



CAREFUL: NOTICE THE DIFFERENCE

A B C

UWAGA: RÓŻNE KLOCKI



6+ 0-3

Printed in EU

WARNING: CHOKING HAZARD-
Toy contains small parts.
Not for children under 3 years.

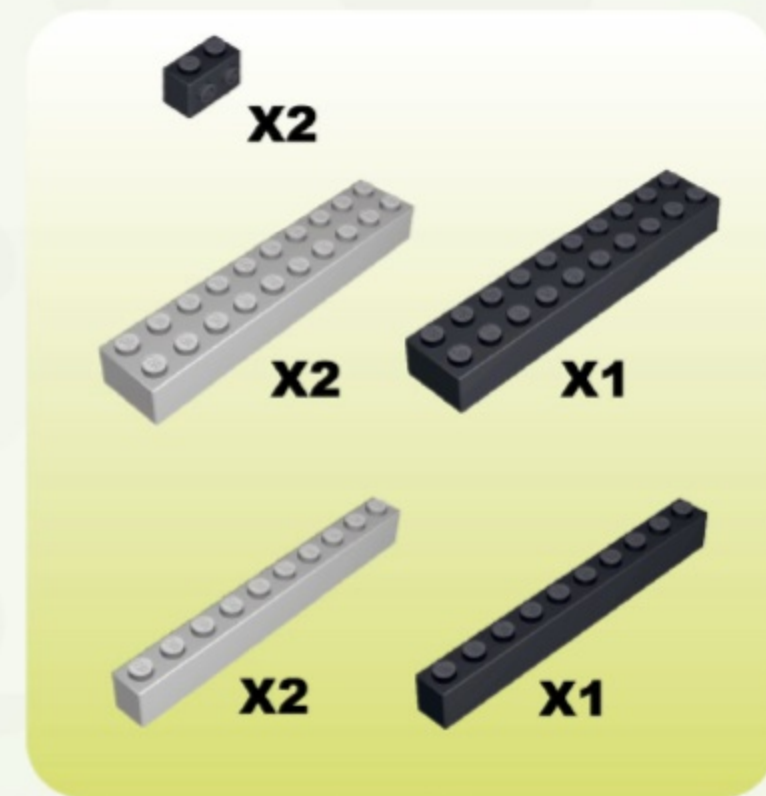
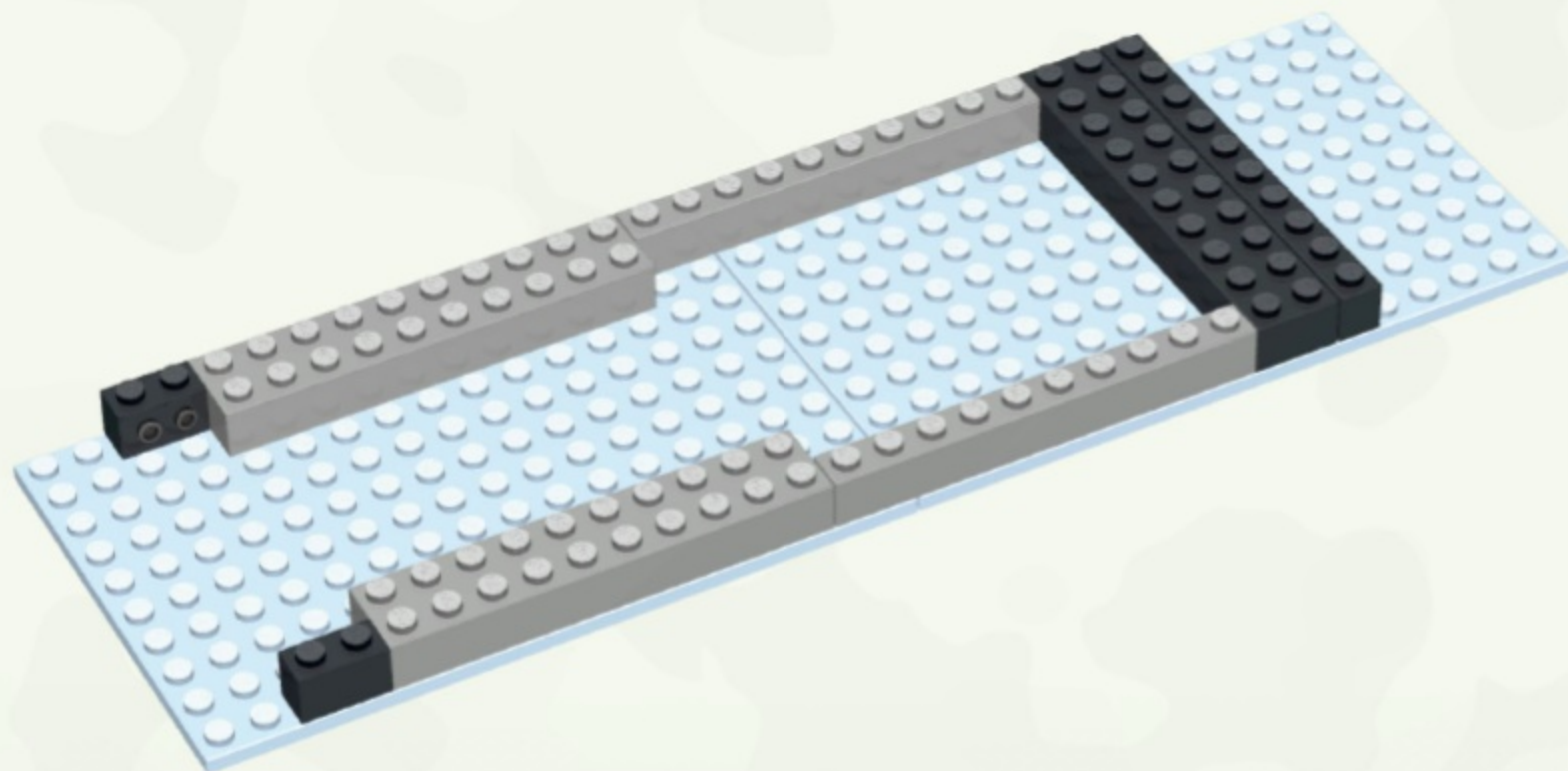
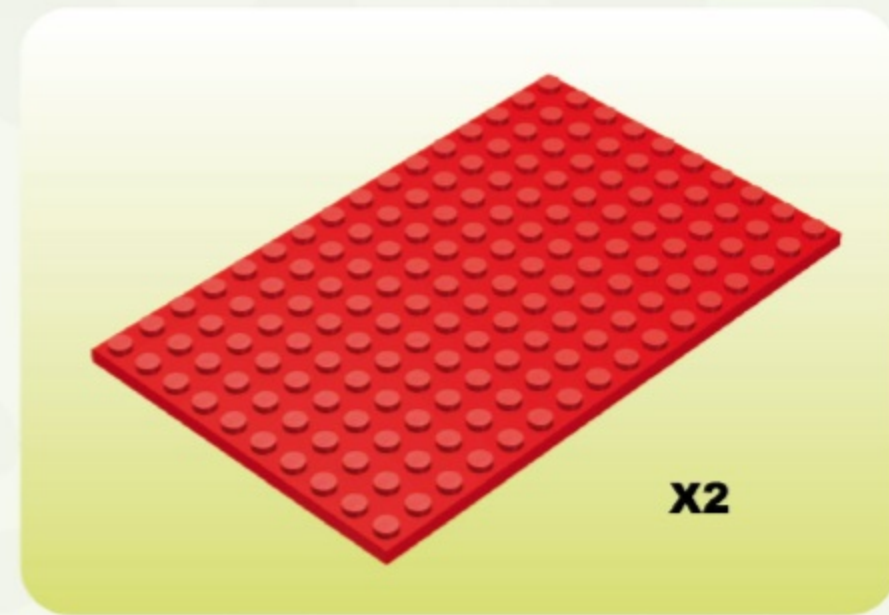
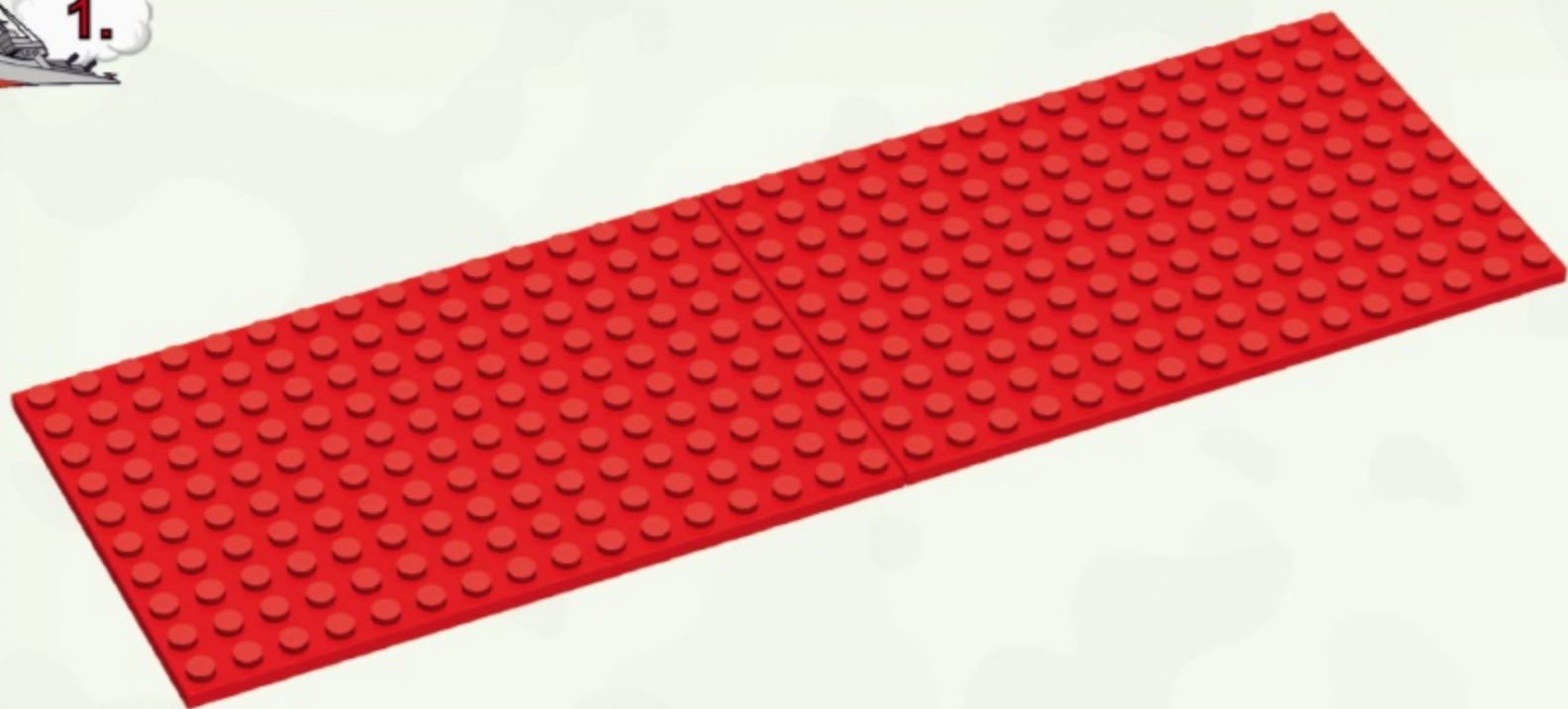

5.

The assembly sequence consists of four steps shown in callout boxes:

- A grey axle with a pin is inserted into a black 2x4 Technic brick.
- A grey 2x4 Technic brick is placed on top of the black brick, with a red arrow indicating the axle passing through the hole in the center.
- A grey 2x4 Technic brick is placed on top of the previous assembly, with a grey axle with a pin inserted into the hole in the center.
- The completed sub-component is shown on a red 1x10 Technic beam, with two grey 2x4 Technic bricks placed on top of it.

Below the callouts, the required parts are listed:

- Grey axle with pin: X2
- Black 2x4 Technic brick: X2
- Grey 2x4 Technic brick: X4
- Red 1x10 Technic beam: X1

A red circle with the text **X2** is positioned between the third and fourth callouts.

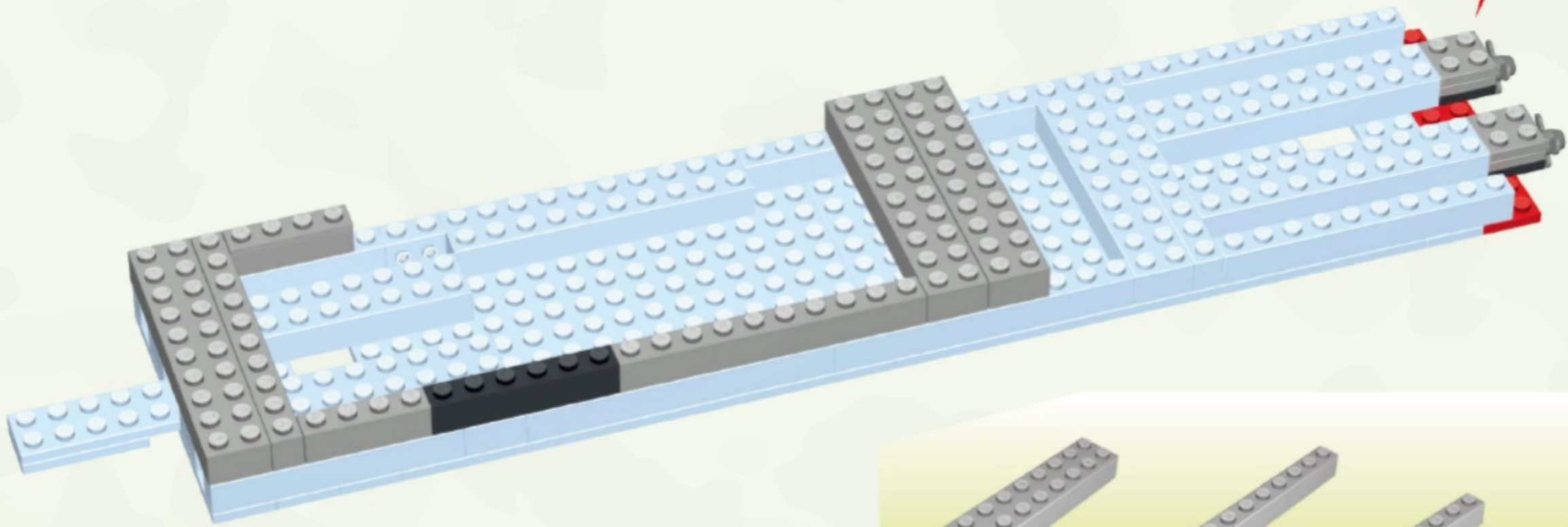

The parts list for this step includes:

- Grey 1x10 Technic beam: X3
- Grey 1x10 Technic beam: X2
- Grey 1x3 Technic beam: X2
- Black 1x4 Technic beam: X1

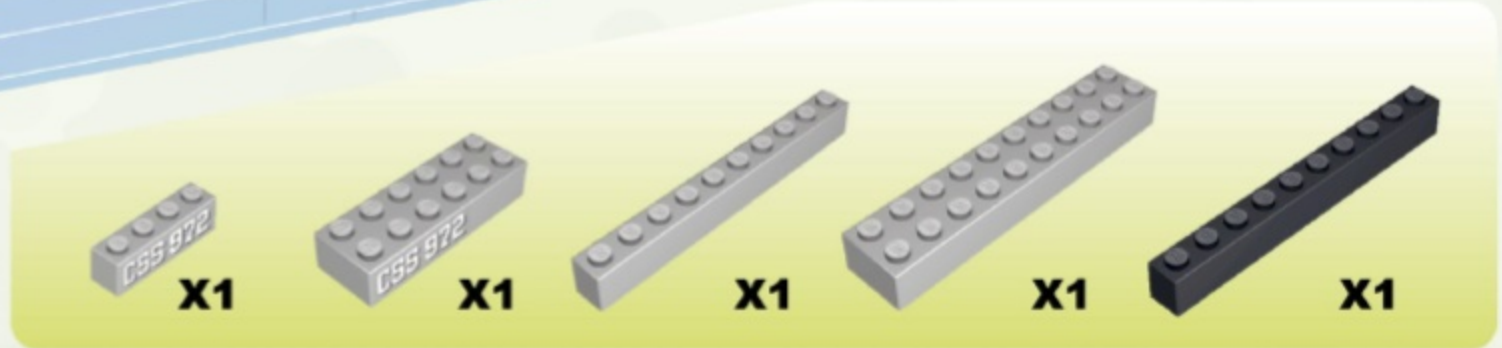
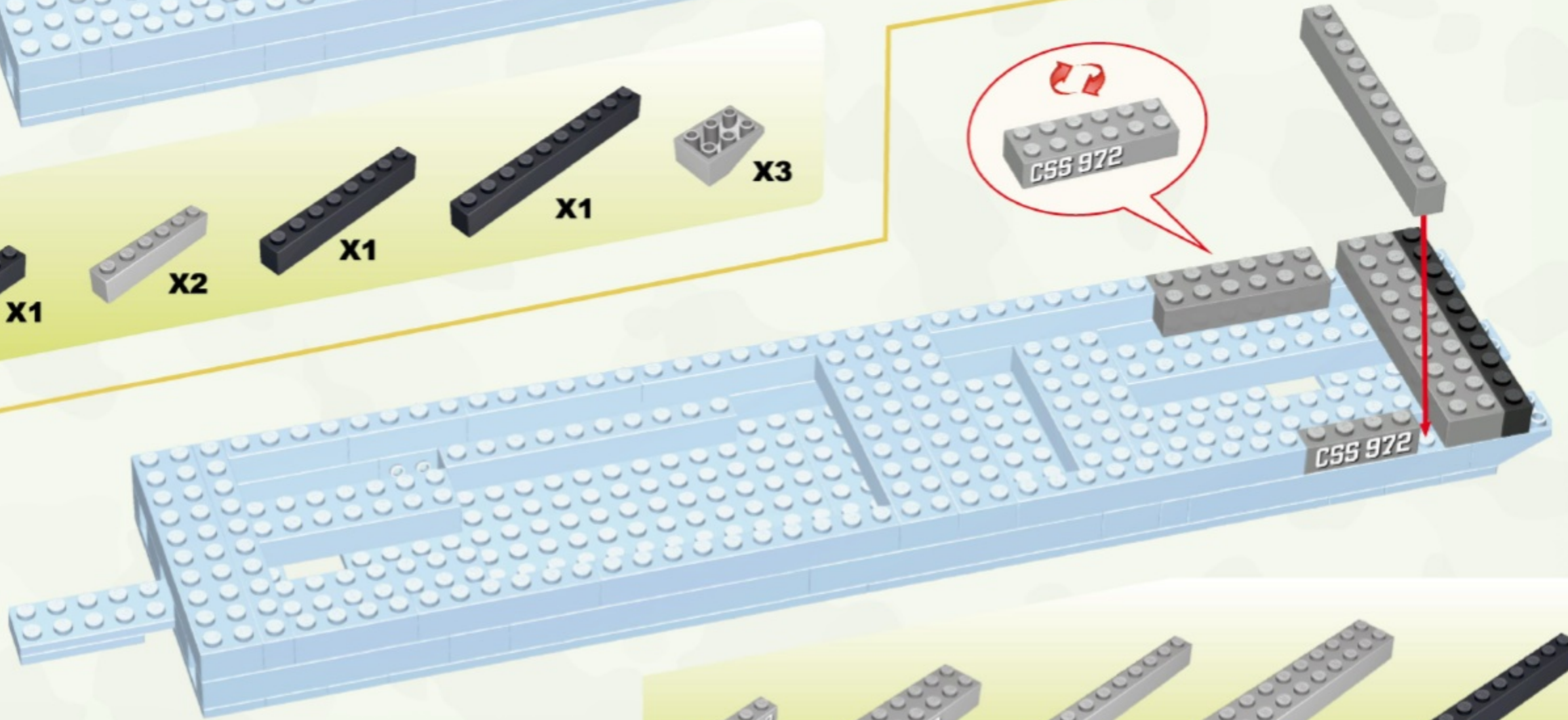
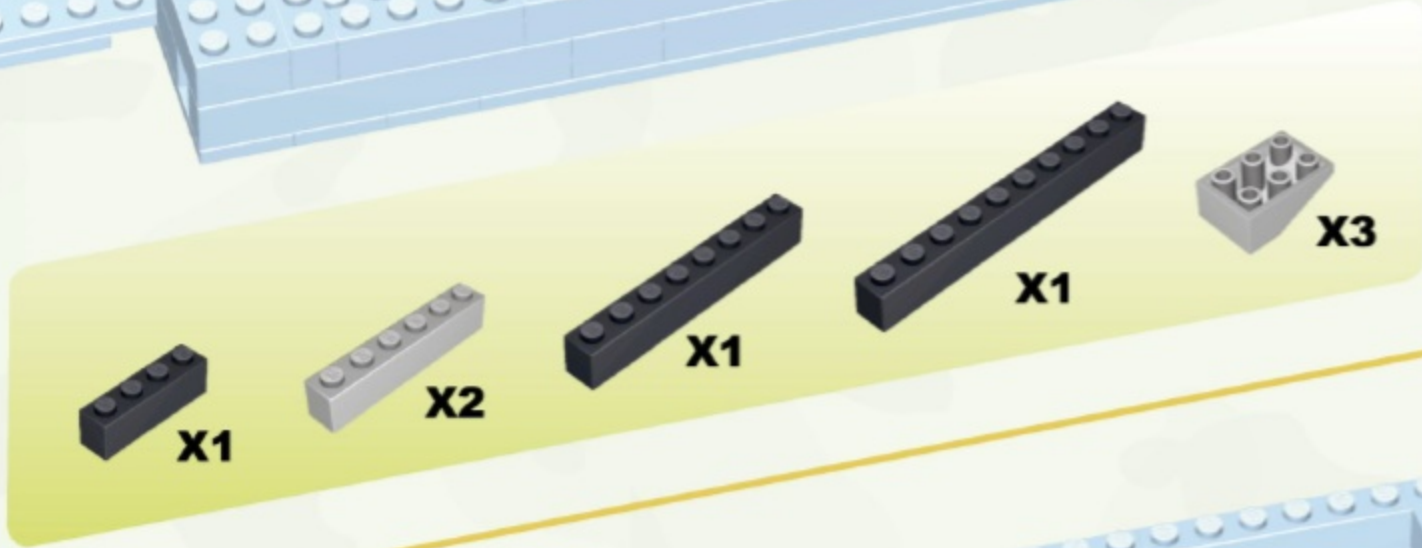
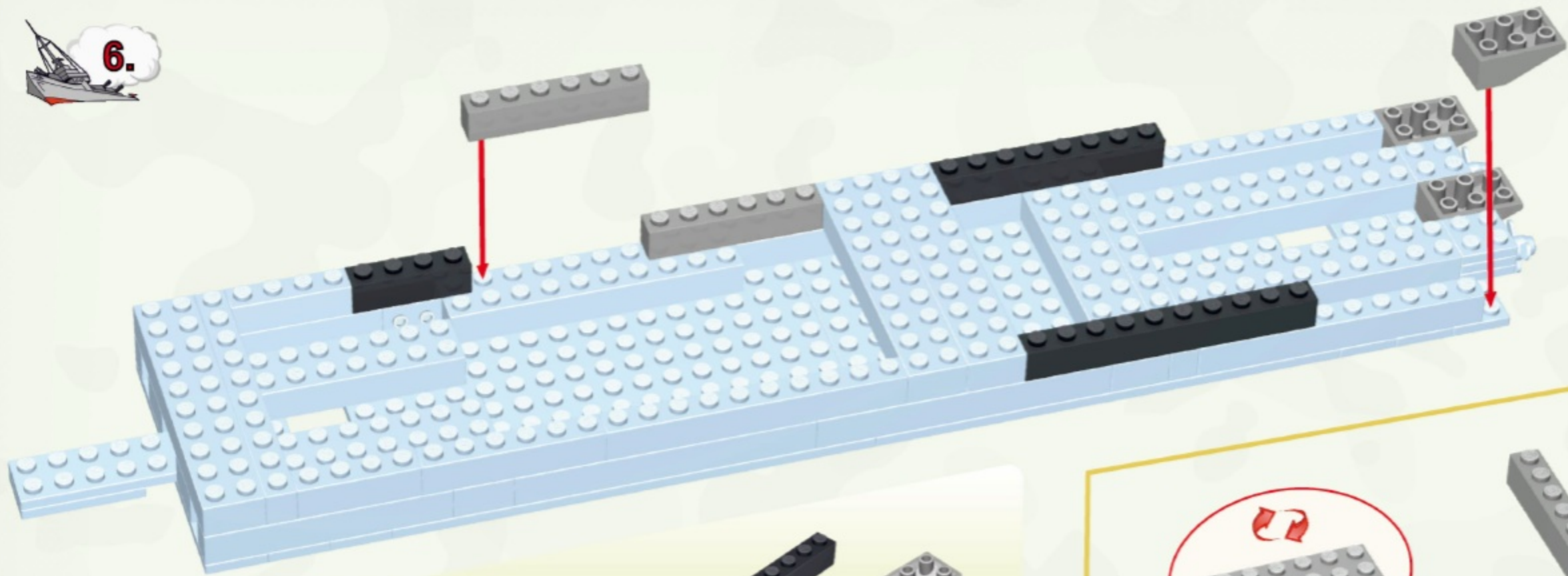

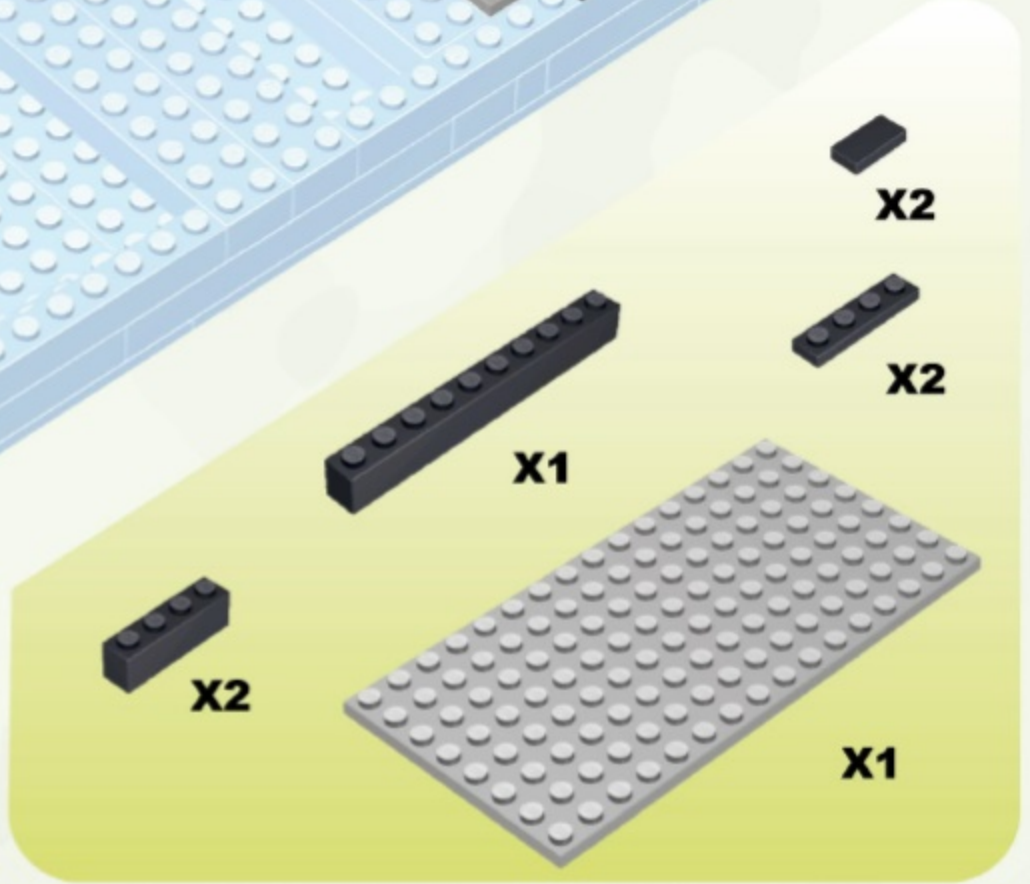
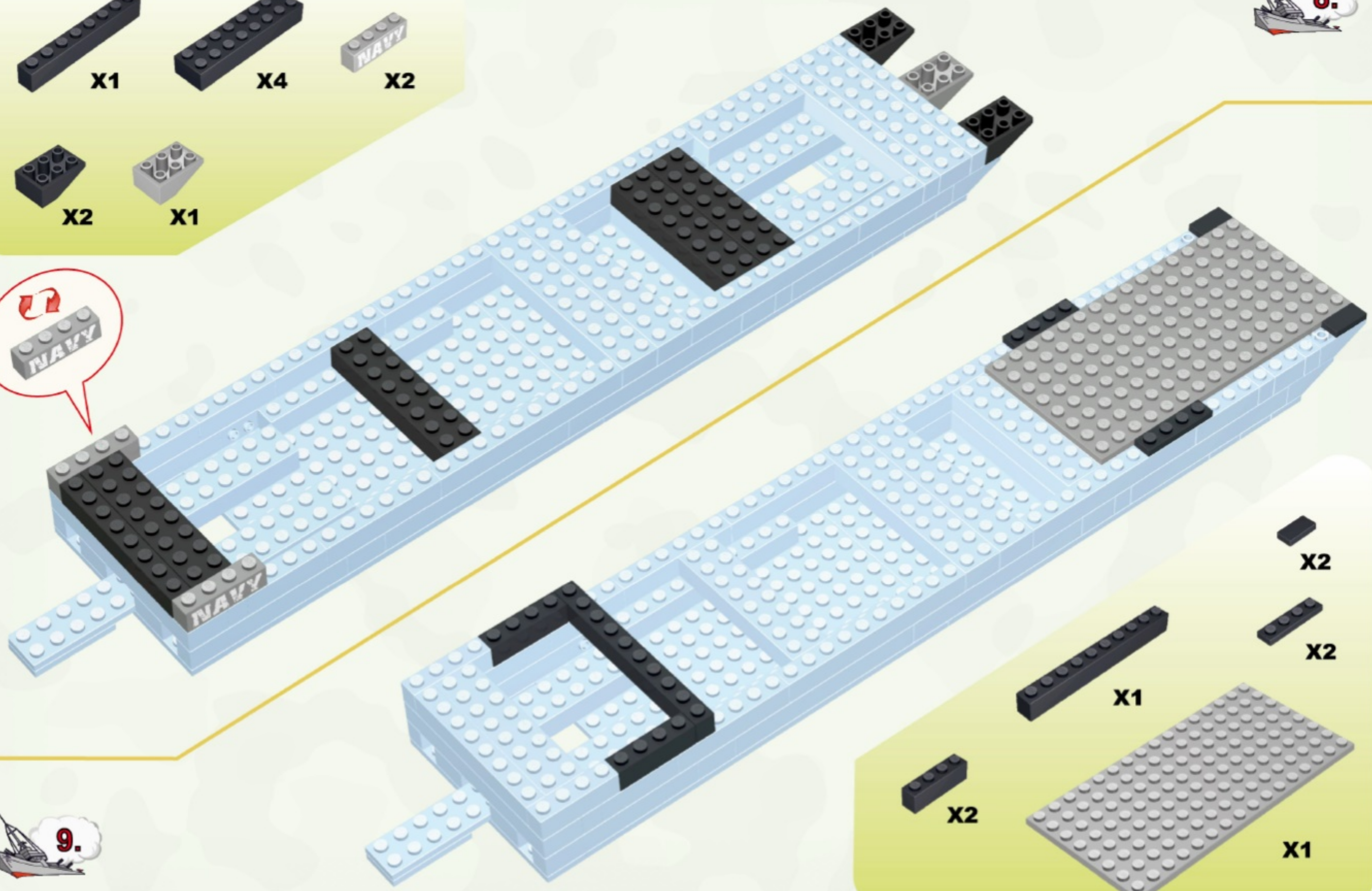
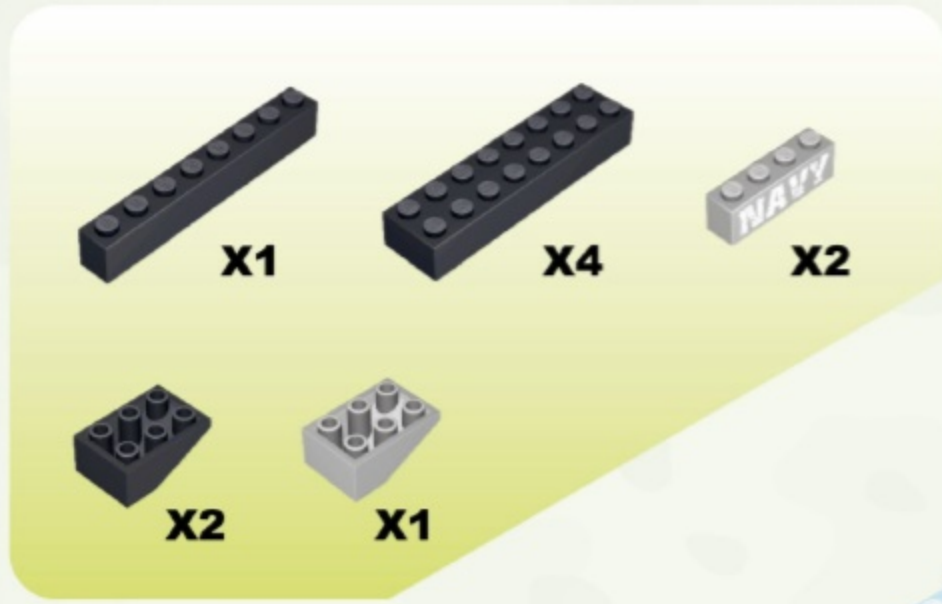

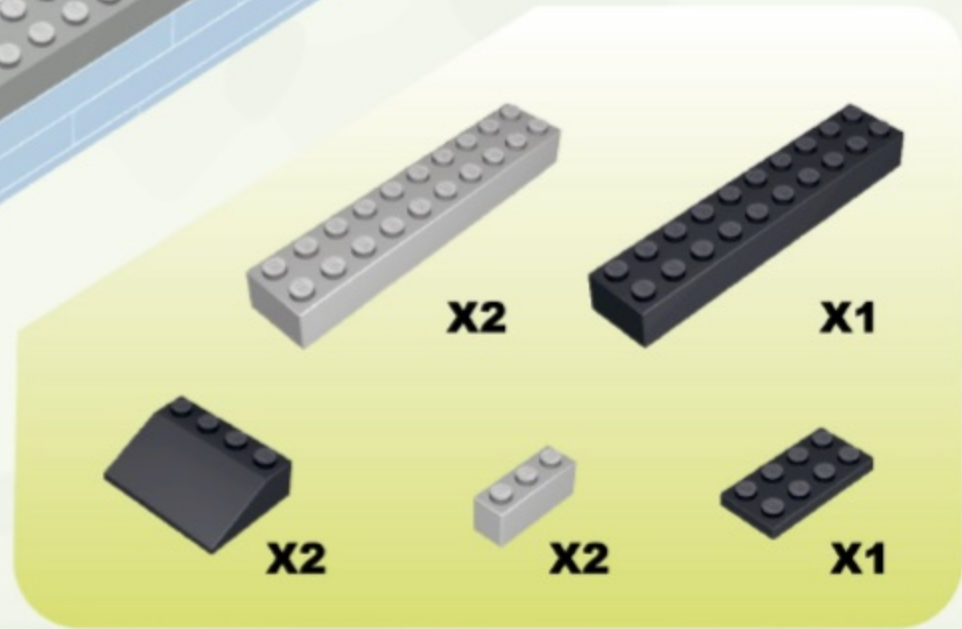
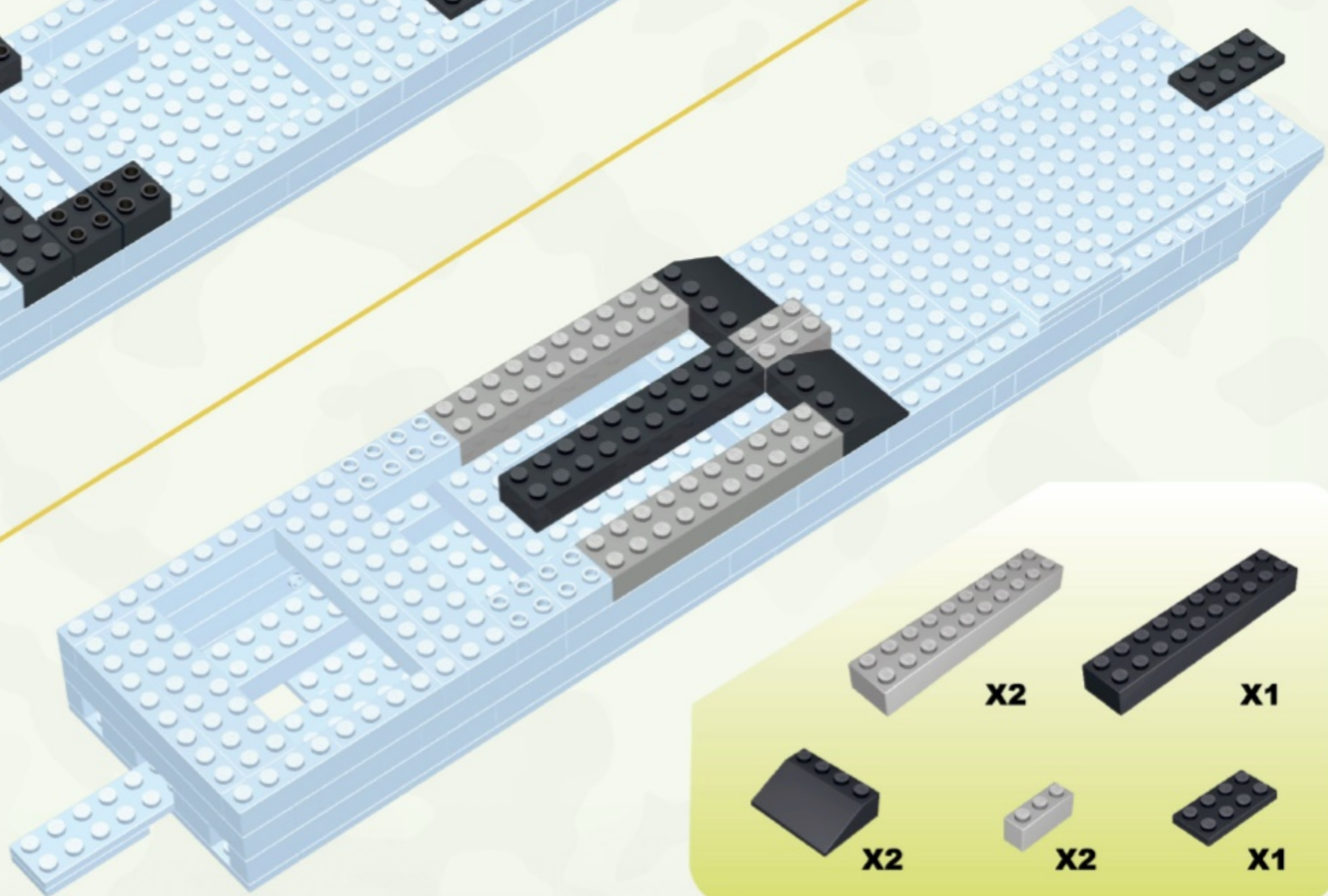
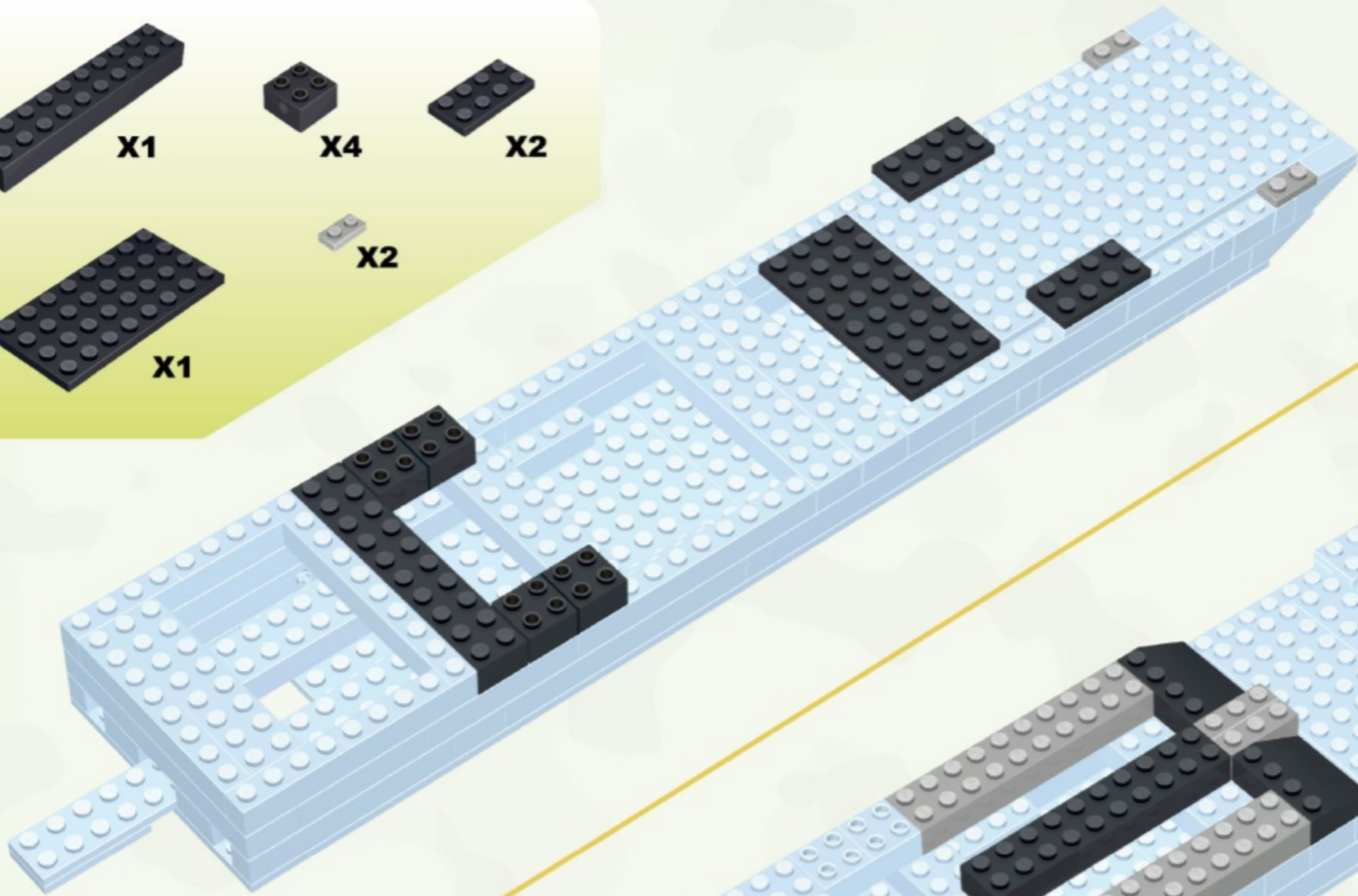
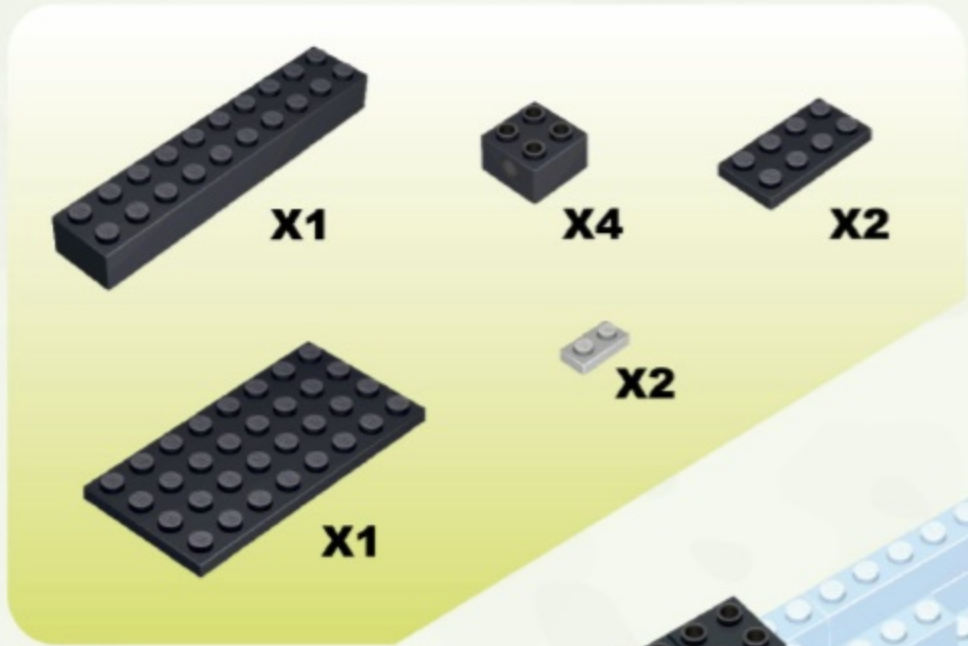

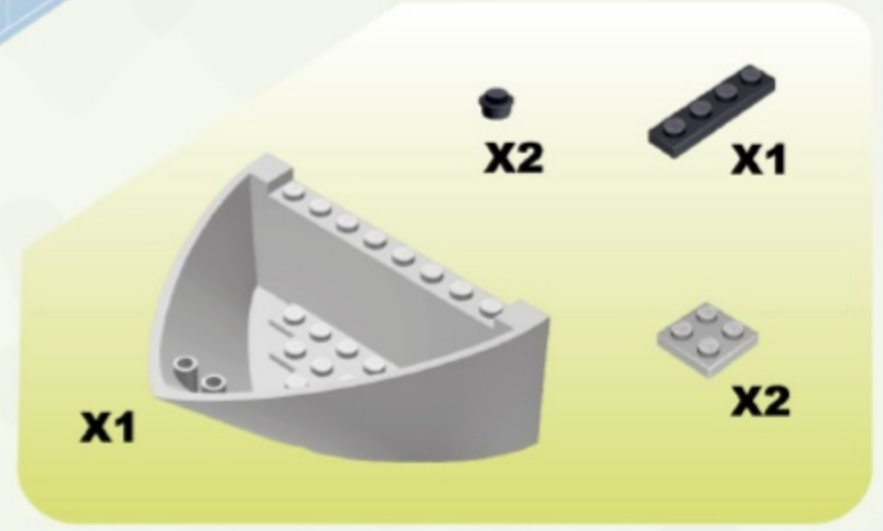
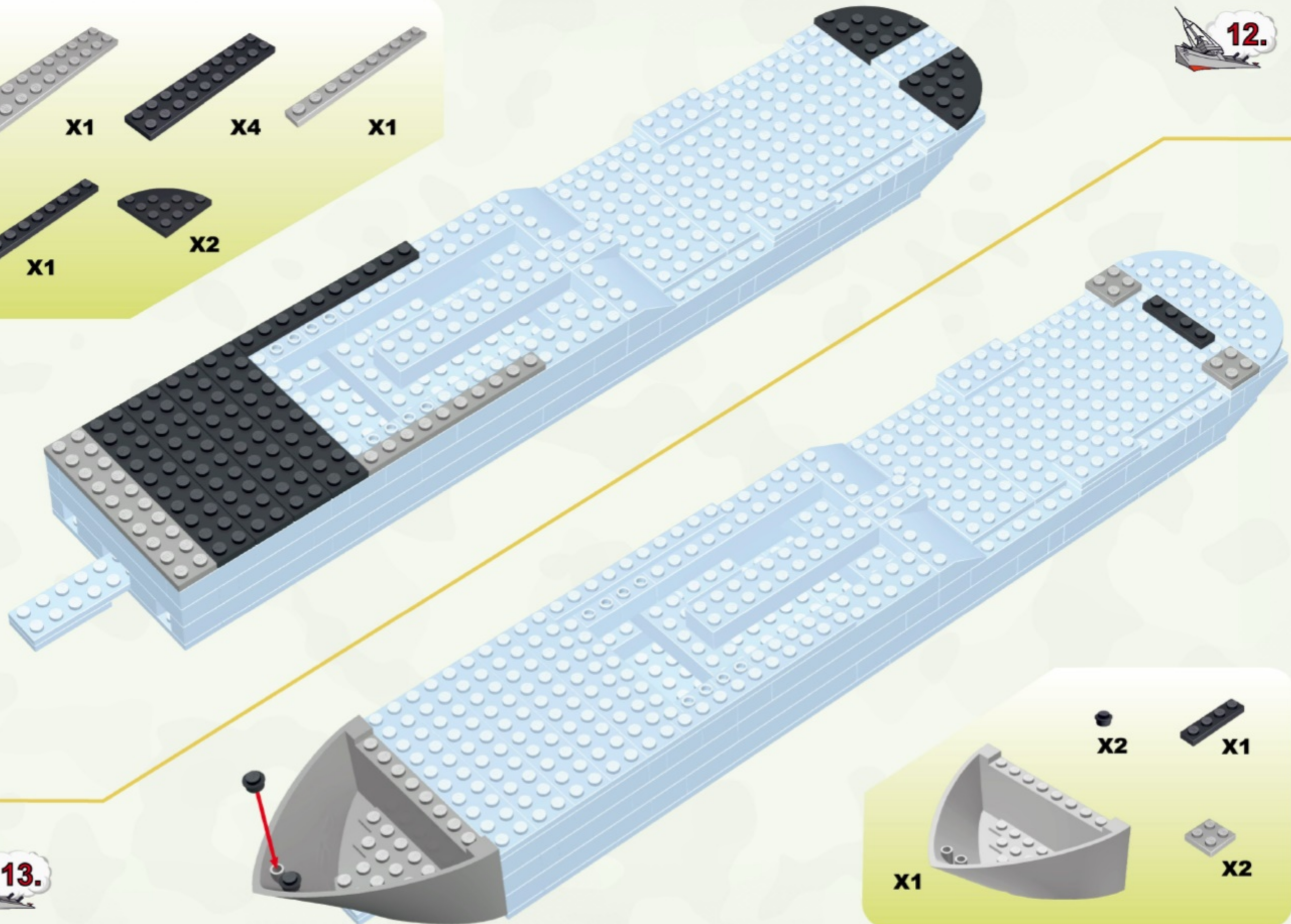
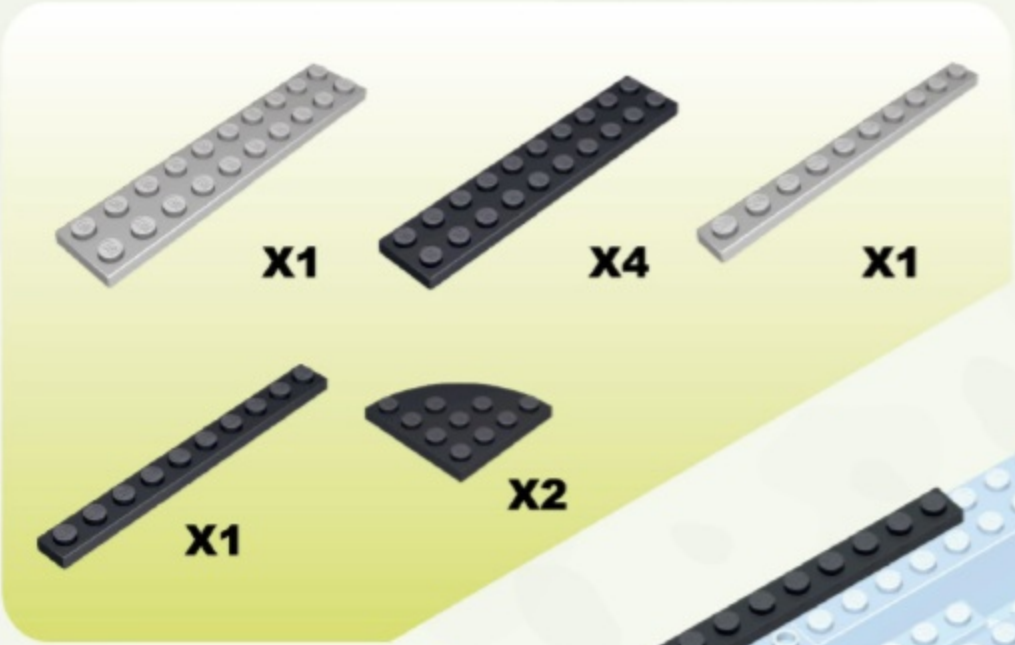

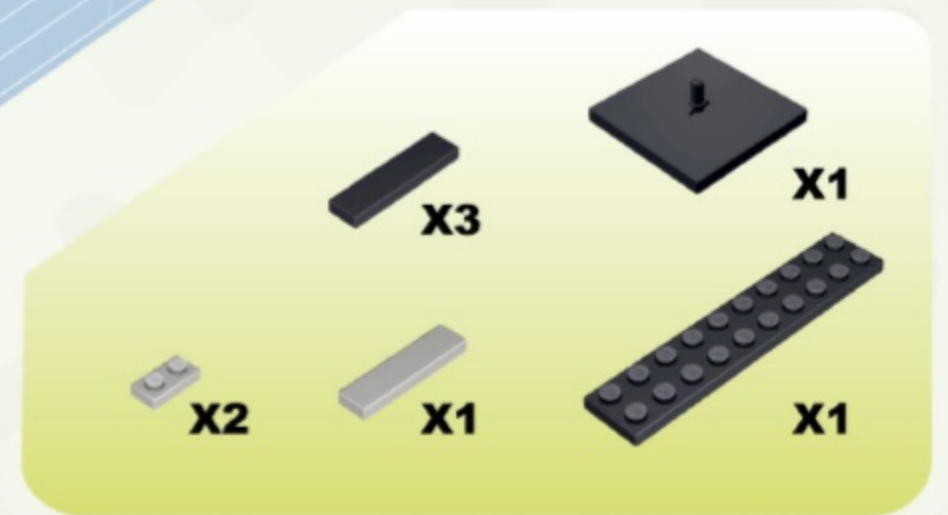
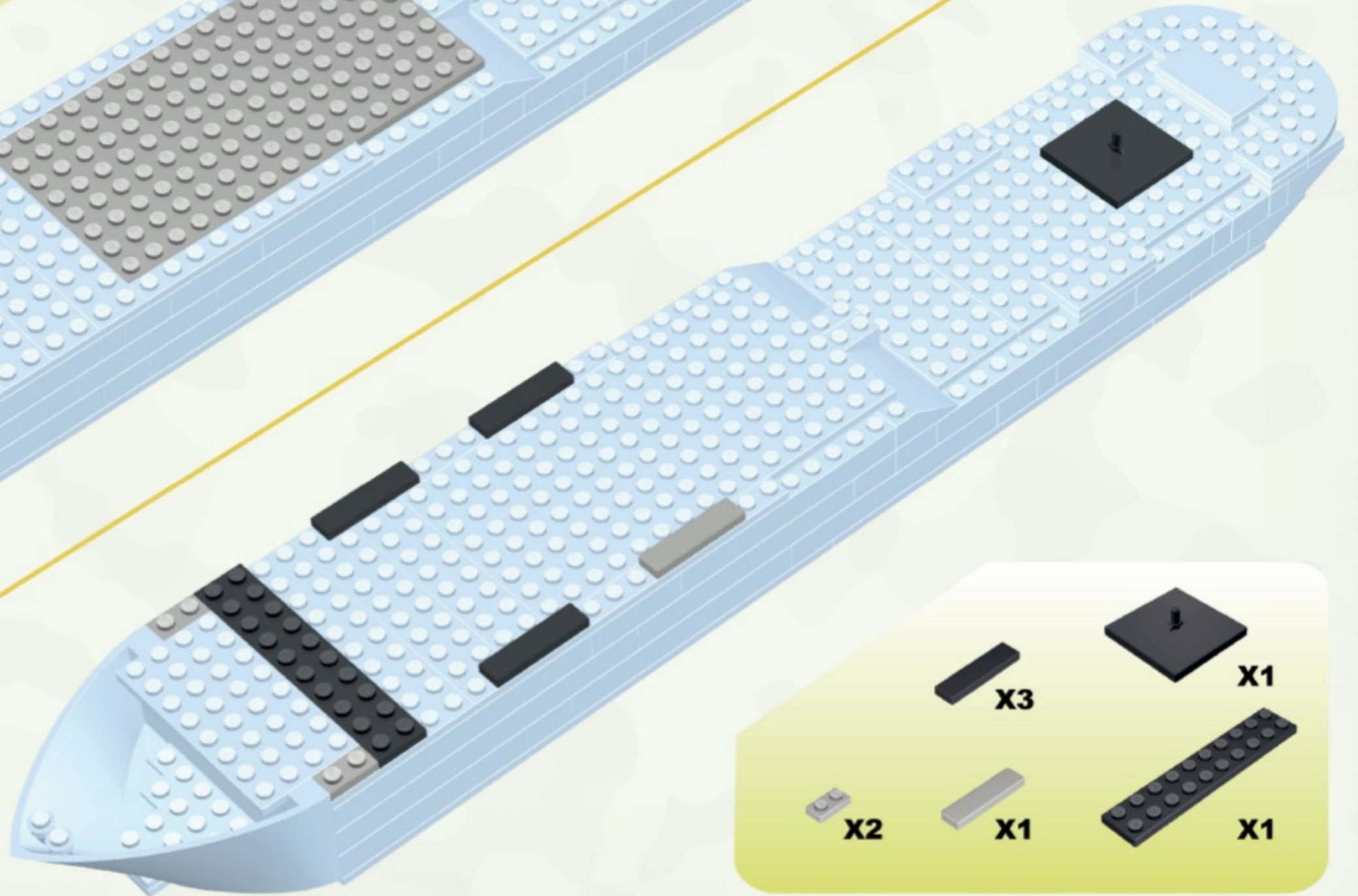
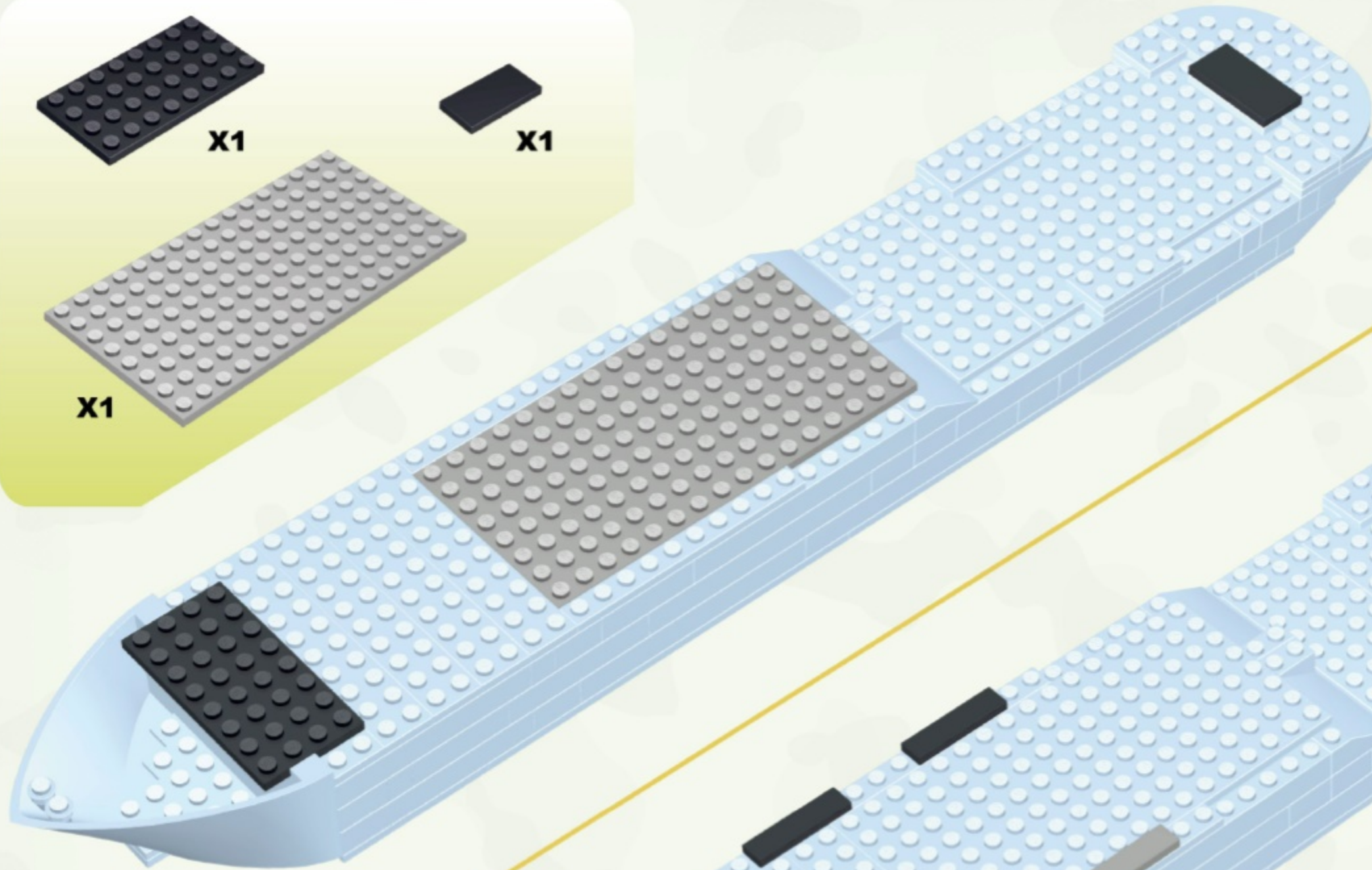
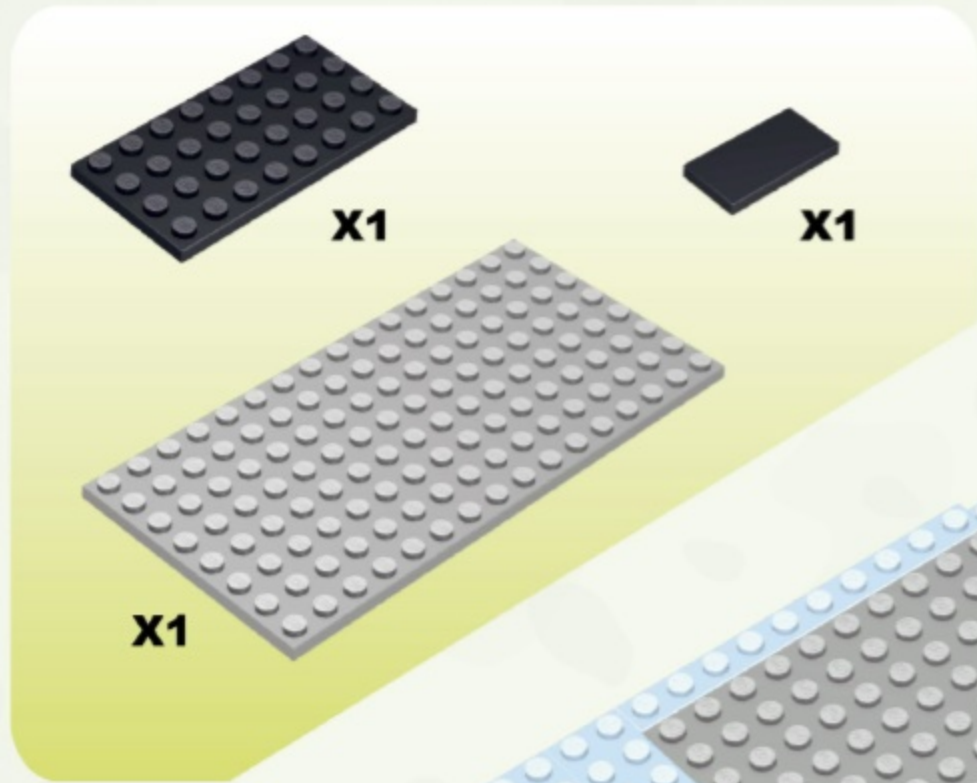

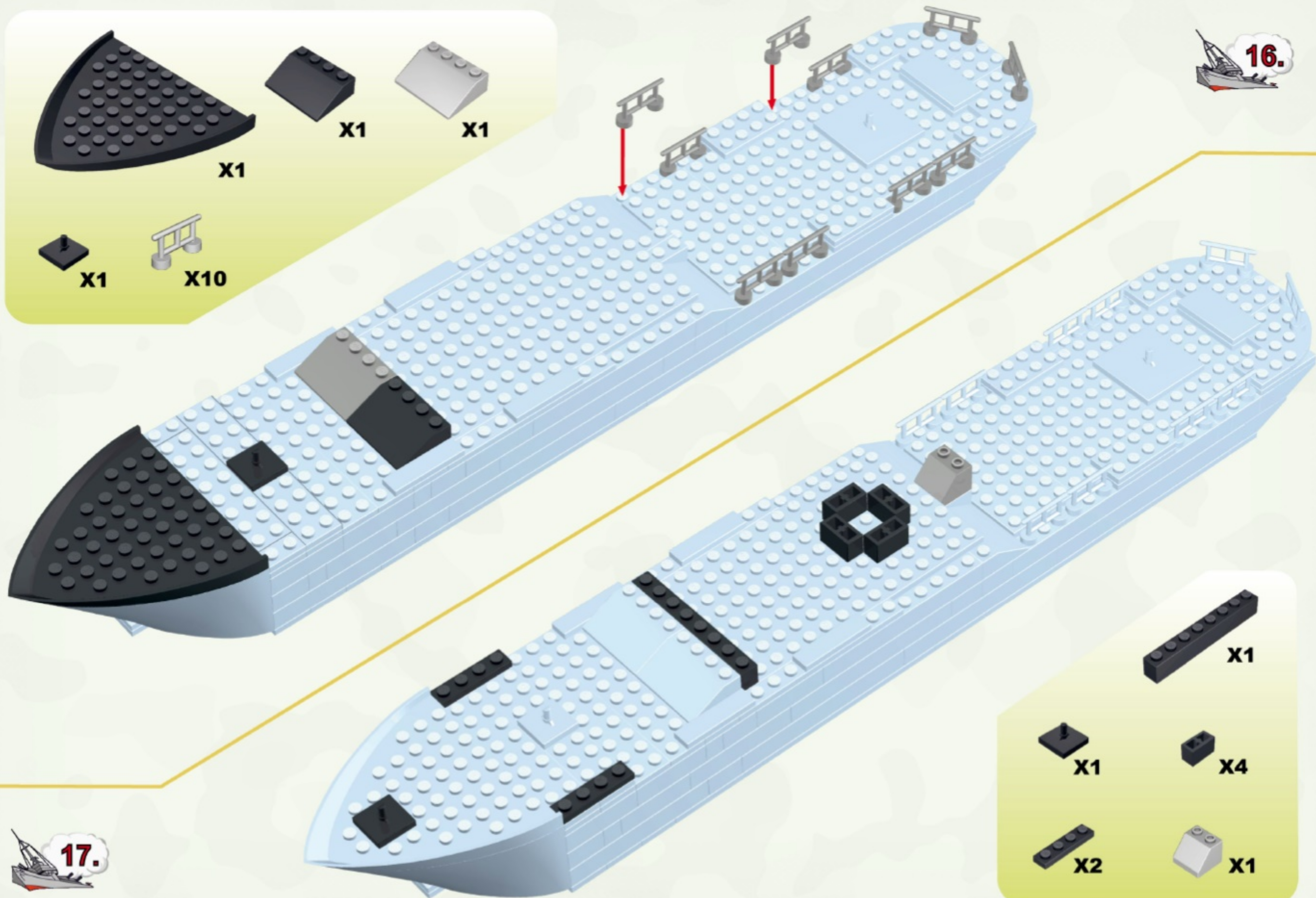
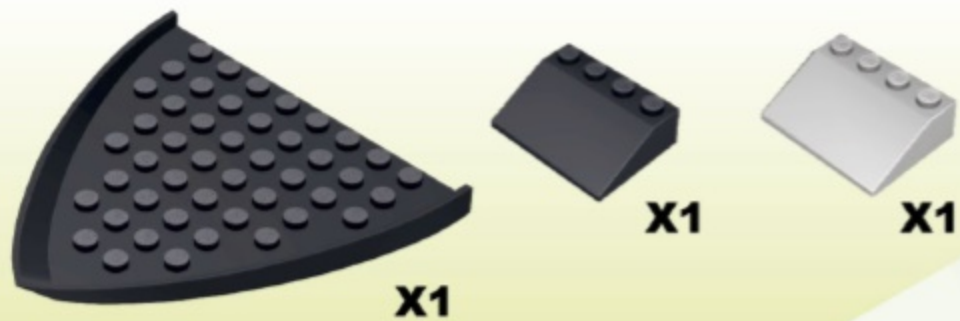

18.

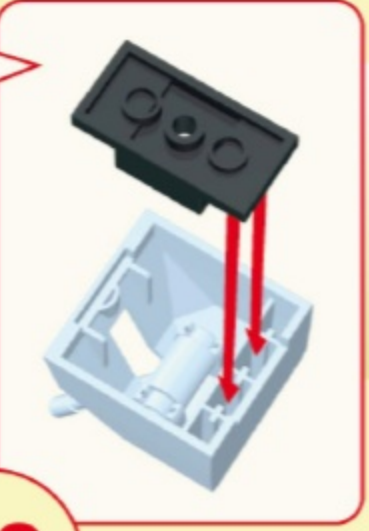

X2

X2

X2

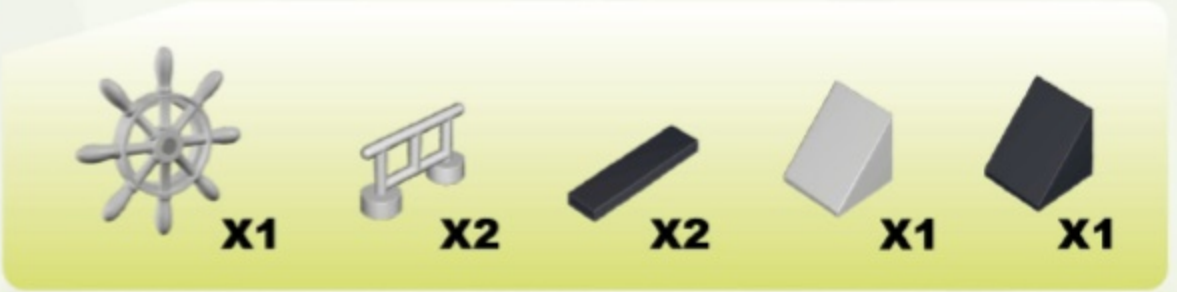
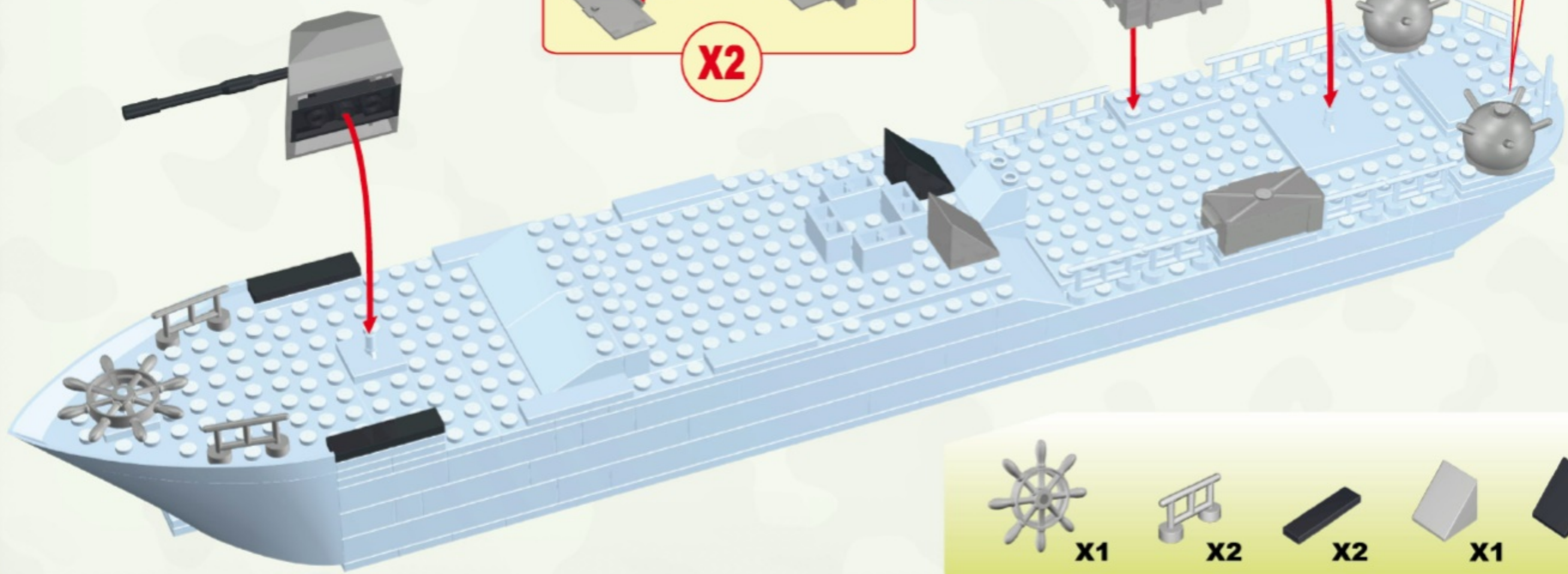

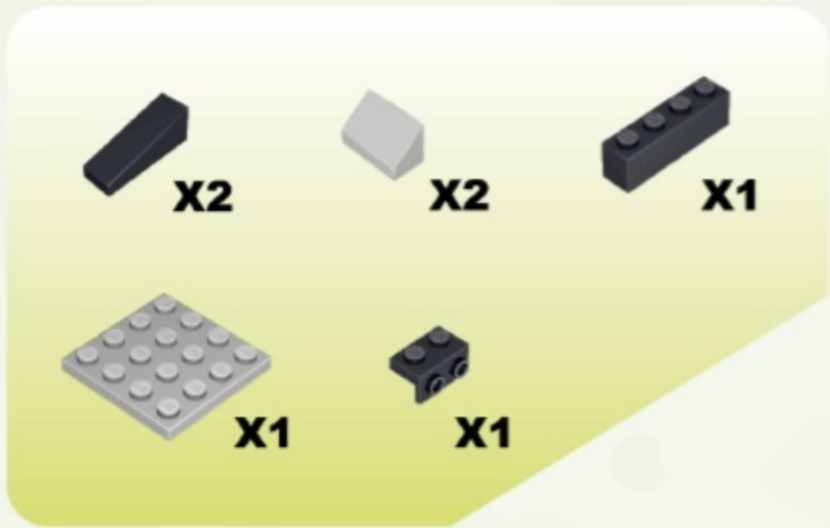

Parts list for step 19:

- Black 1x3 Technic Brick: X2
- Grey 1x2 Technic Brick: X2
- Black 1x3 Technic Brick with Hole: X1
- Grey 4x4 Technic Plate with Hole: X1
- Black 1x2 Technic Brick with Hole: X1

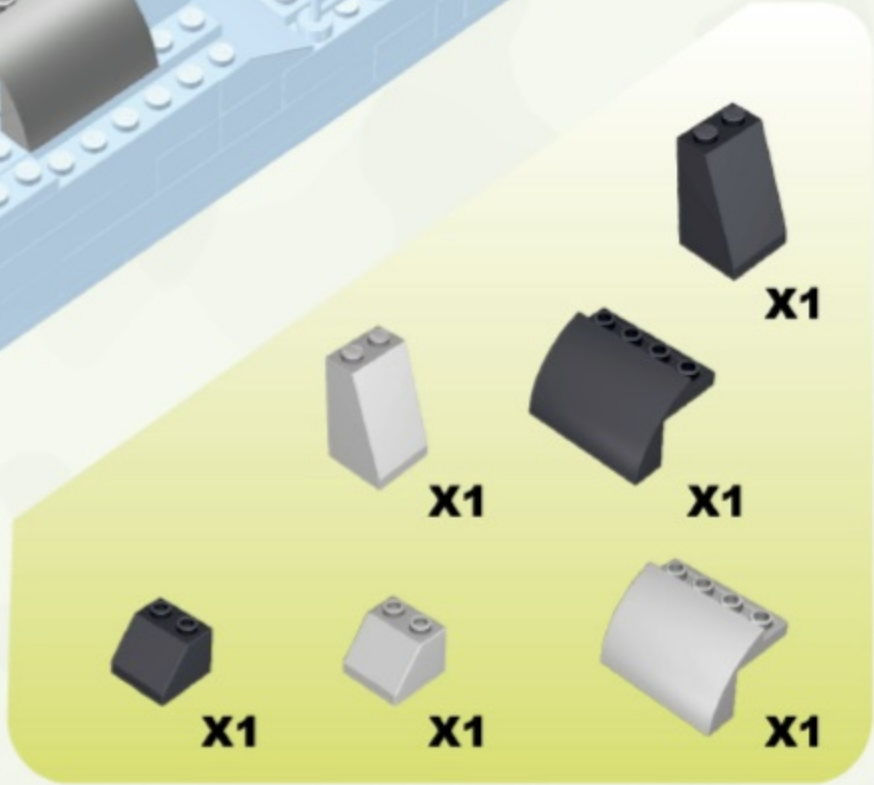
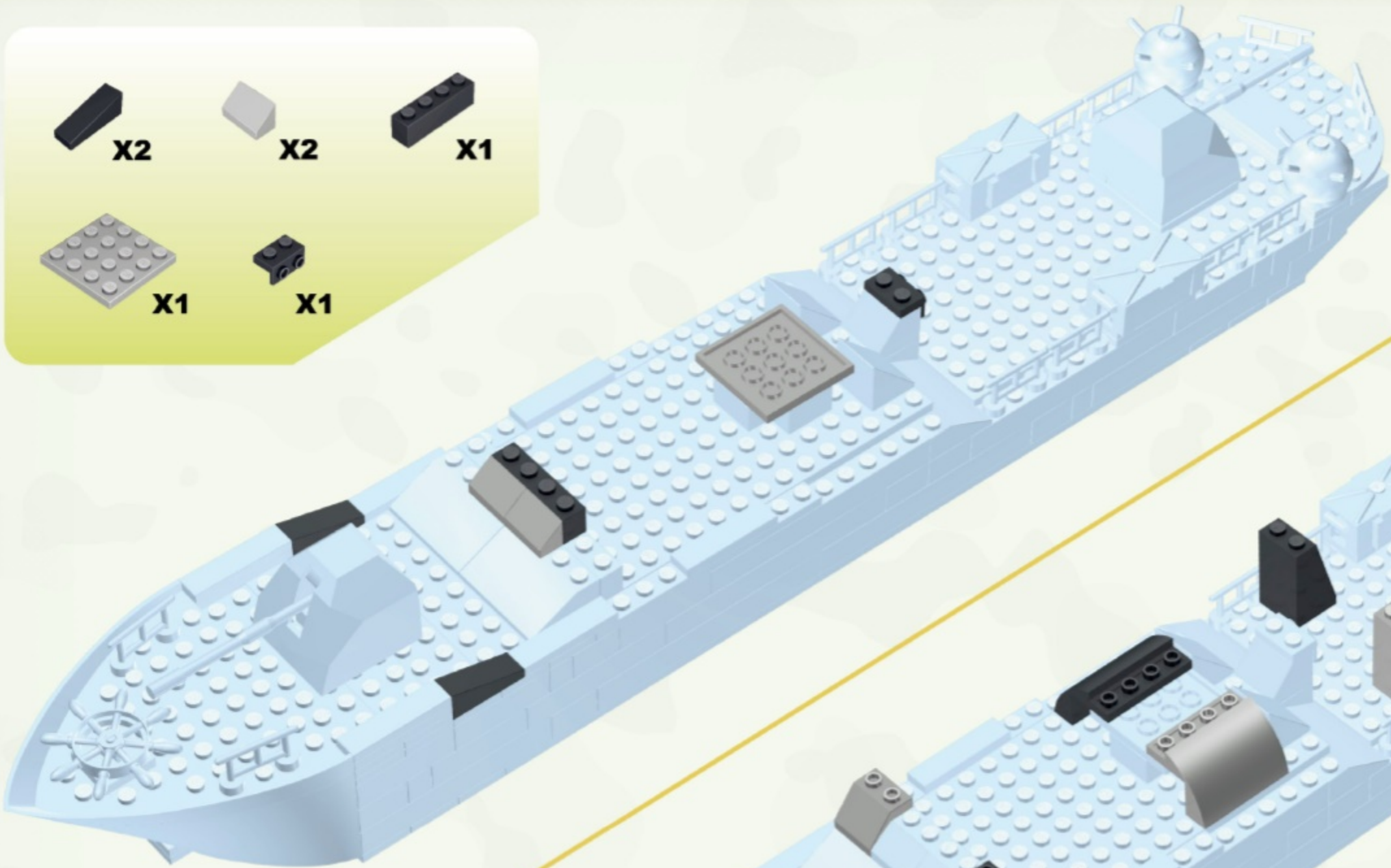

Parts list for step 20:

- Black 1x2 Technic Brick with Hole: X1
- Grey 1x2 Technic Brick: X1
- Black 1x2 Technic Brick with Hole: X1
- Black 1x2 Technic Brick with Hole: X1
- Black 1x2 Technic Brick with Hole: X1
- Grey 1x2 Technic Brick: X1

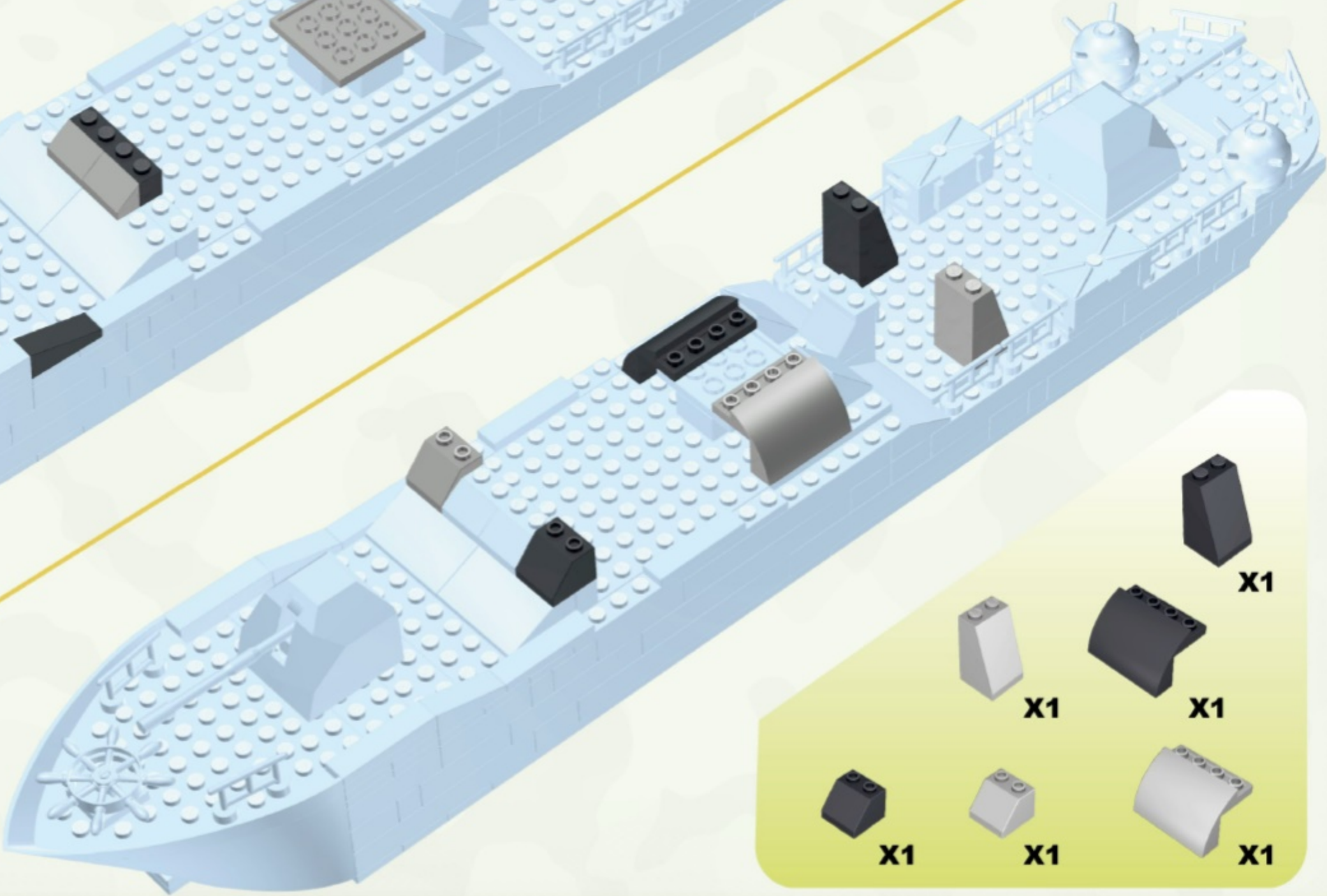

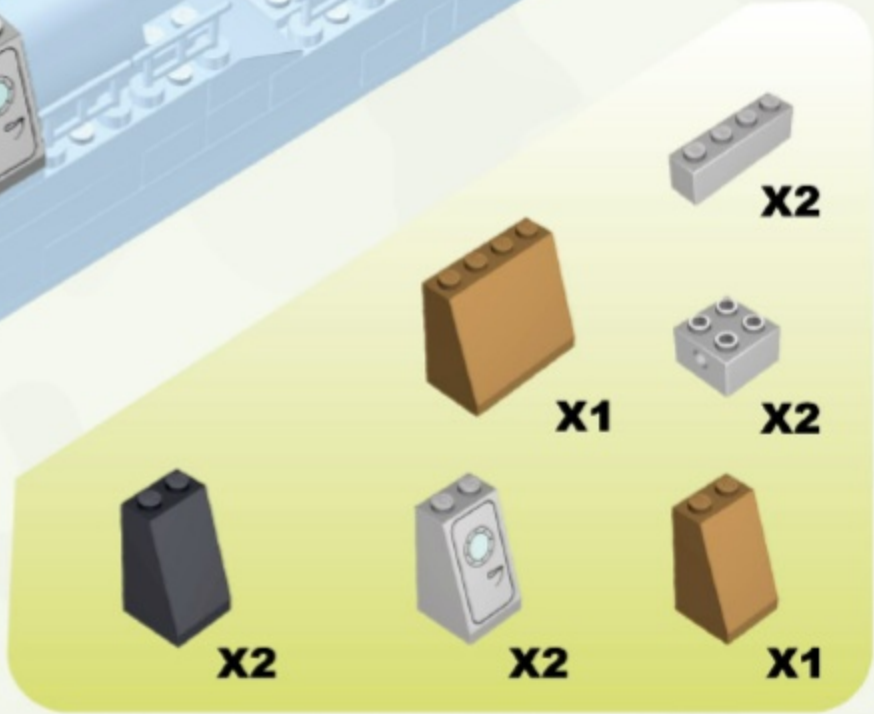
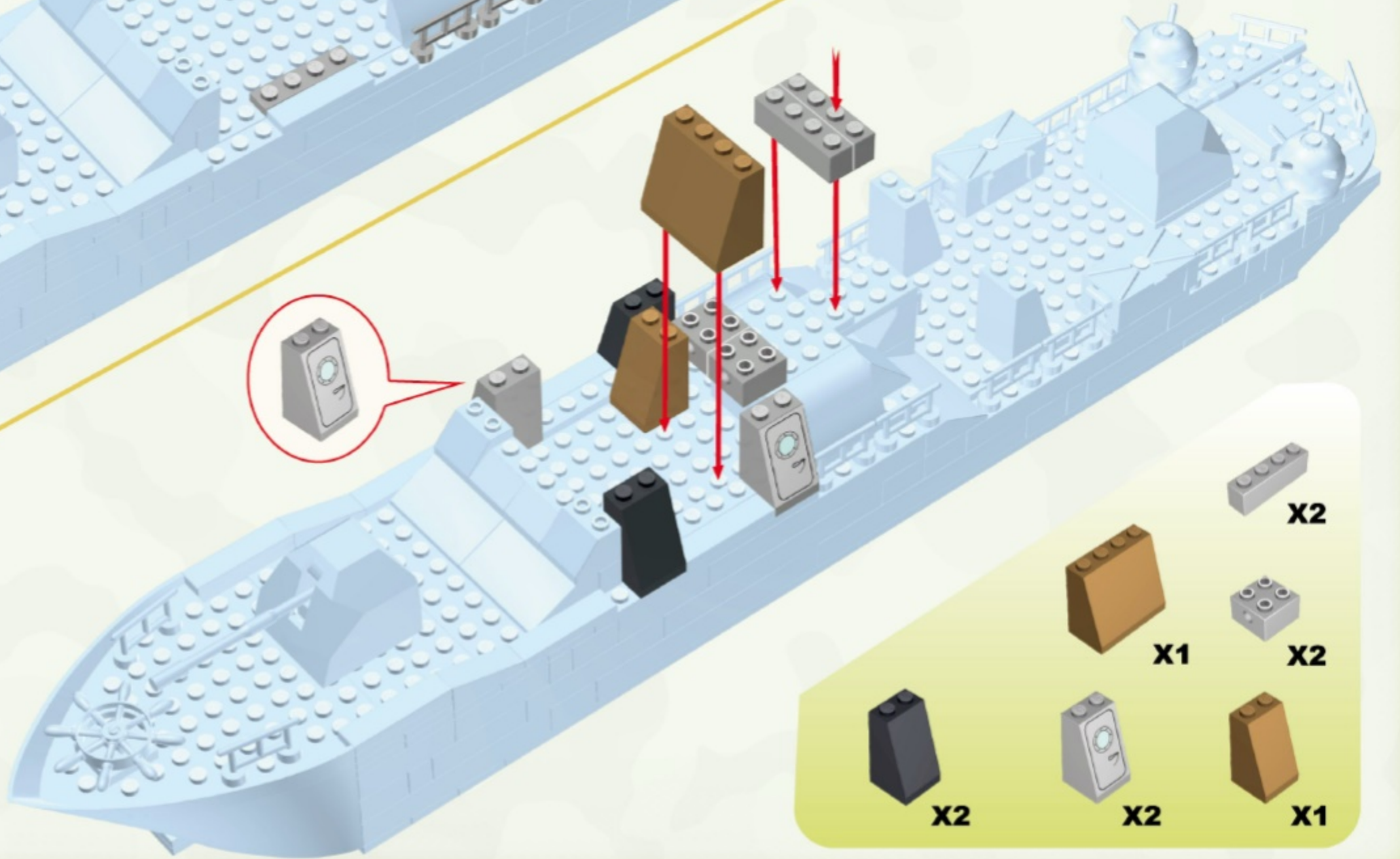
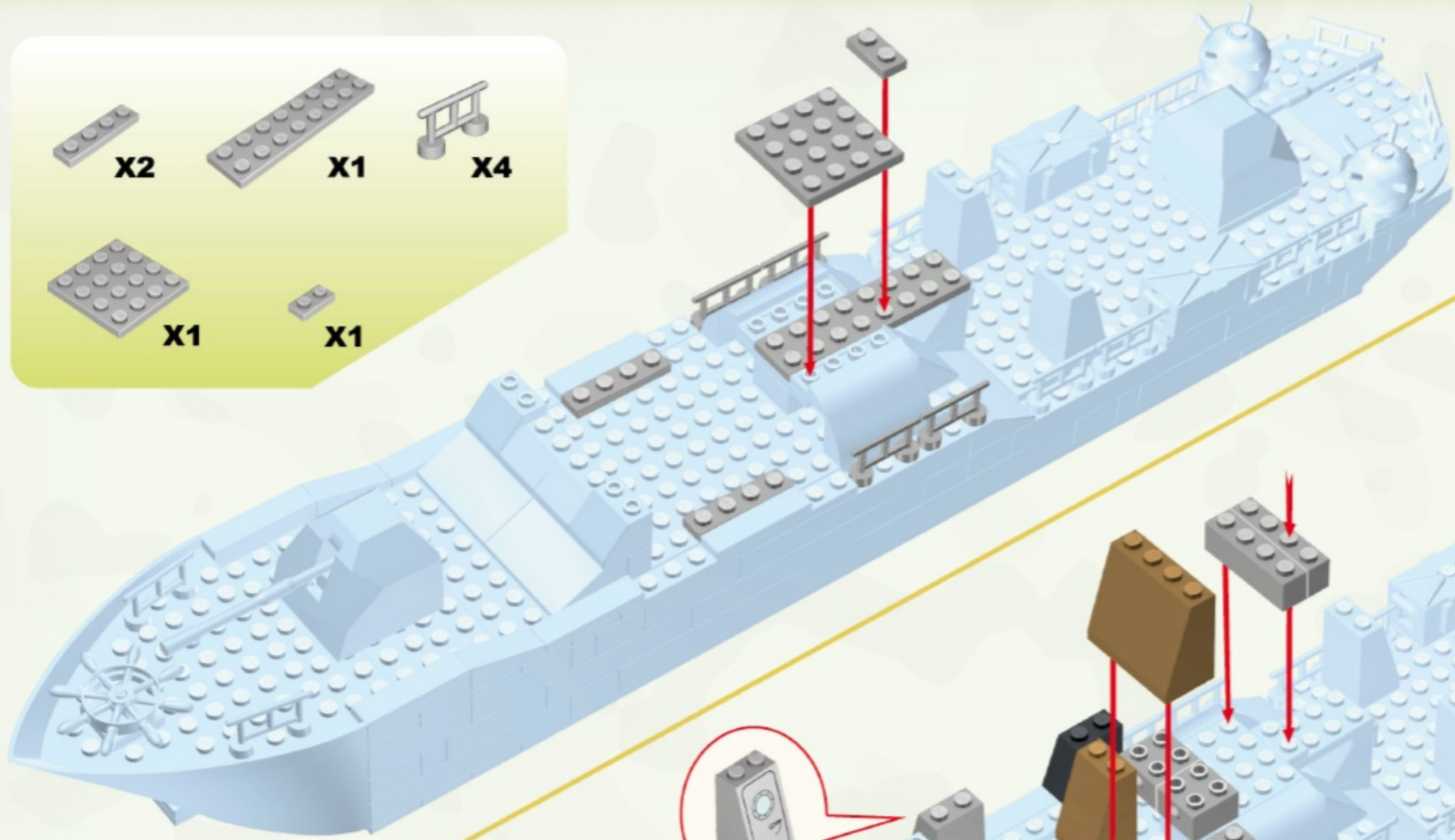
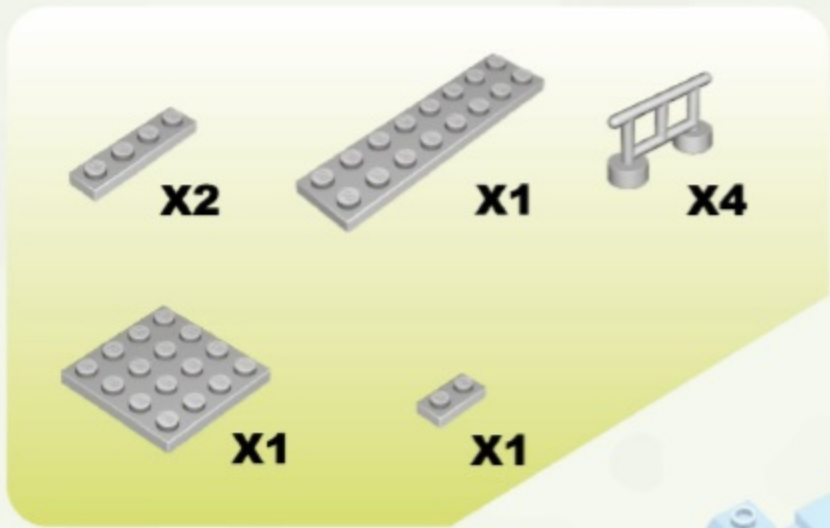

- X1 [Black 1x2 Technic Brick]
- X1 [Grey 1x2 Technic Brick]
- X1 [Black 1x2 Technic Brick with Hole]
- X1 [Grey Ship's Wheel]
- X1 [Grey 1x6 Technic Brick]

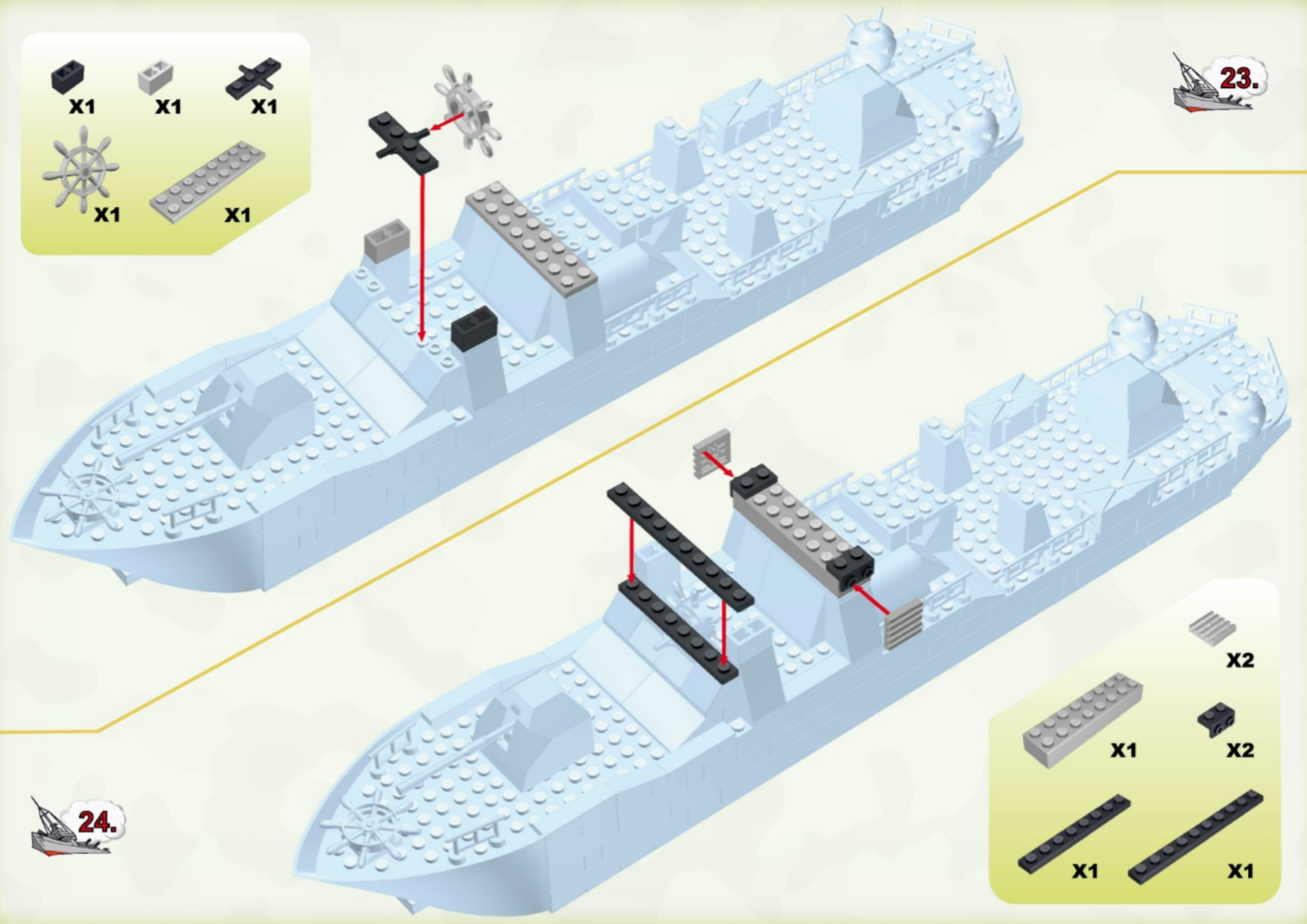

- X2 [Grey 1x2 Technic Brick]
- X1 [Grey 1x6 Technic Brick]
- X2 [Black 1x2 Technic Brick]
- X1 [Black 1x6 Technic Brick]
- X1 [Black 1x6 Technic Brick]

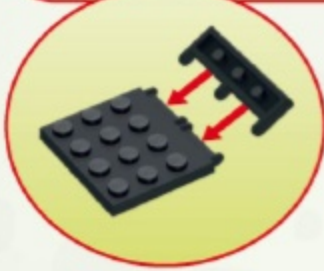
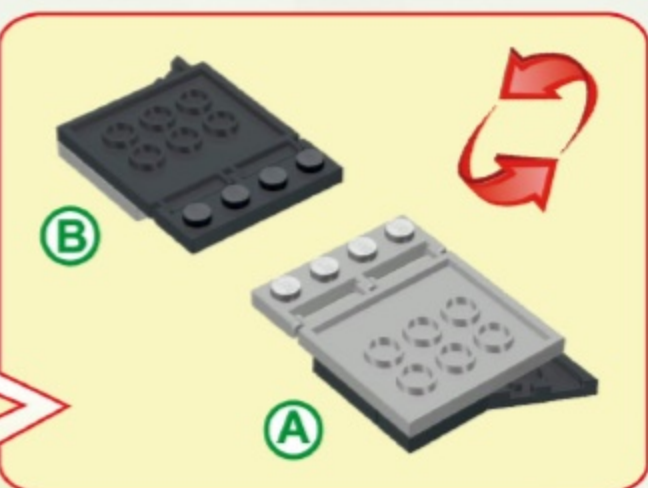
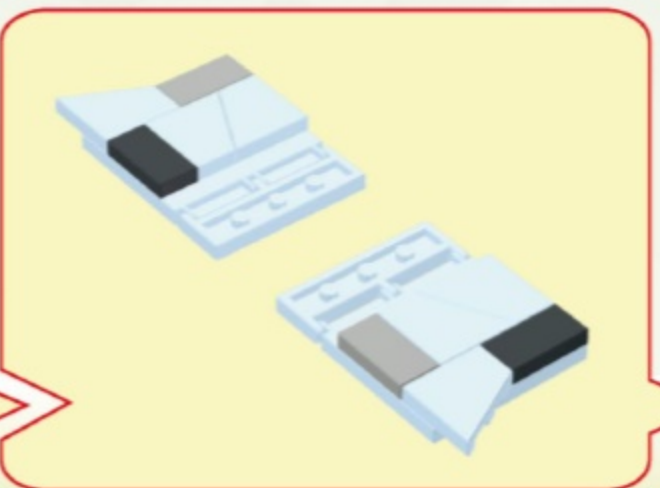
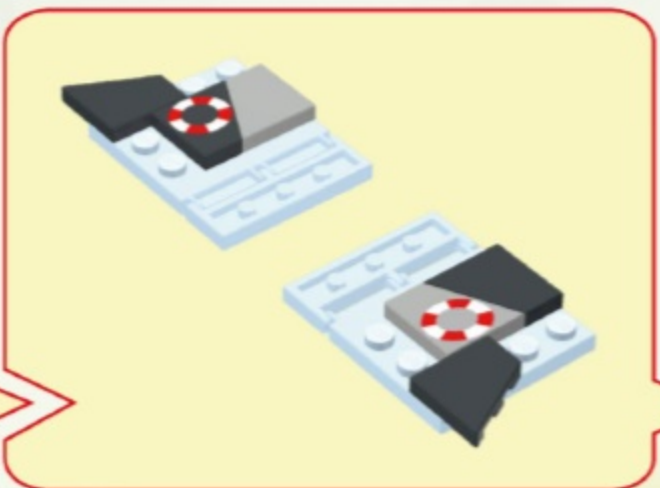

- X1
- X1
- X1
- X1
- X2
- X2
- X2

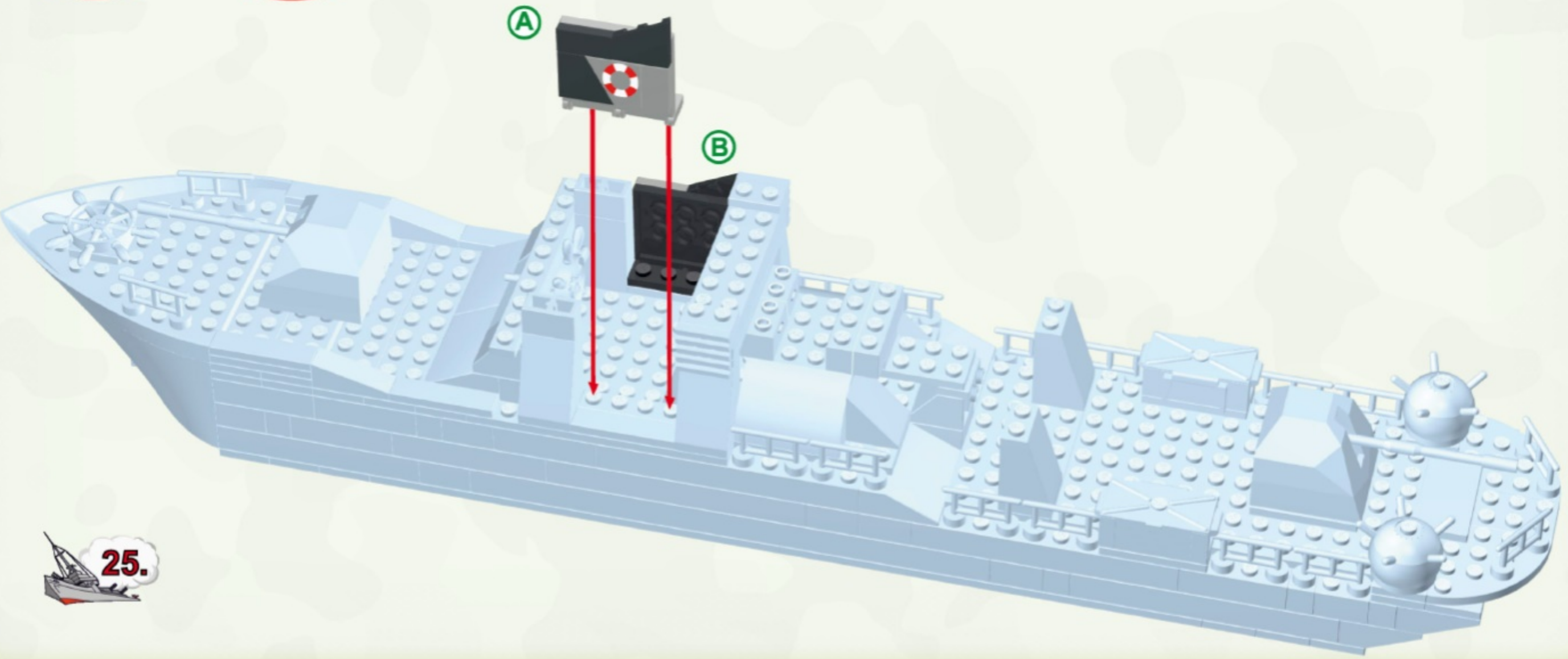

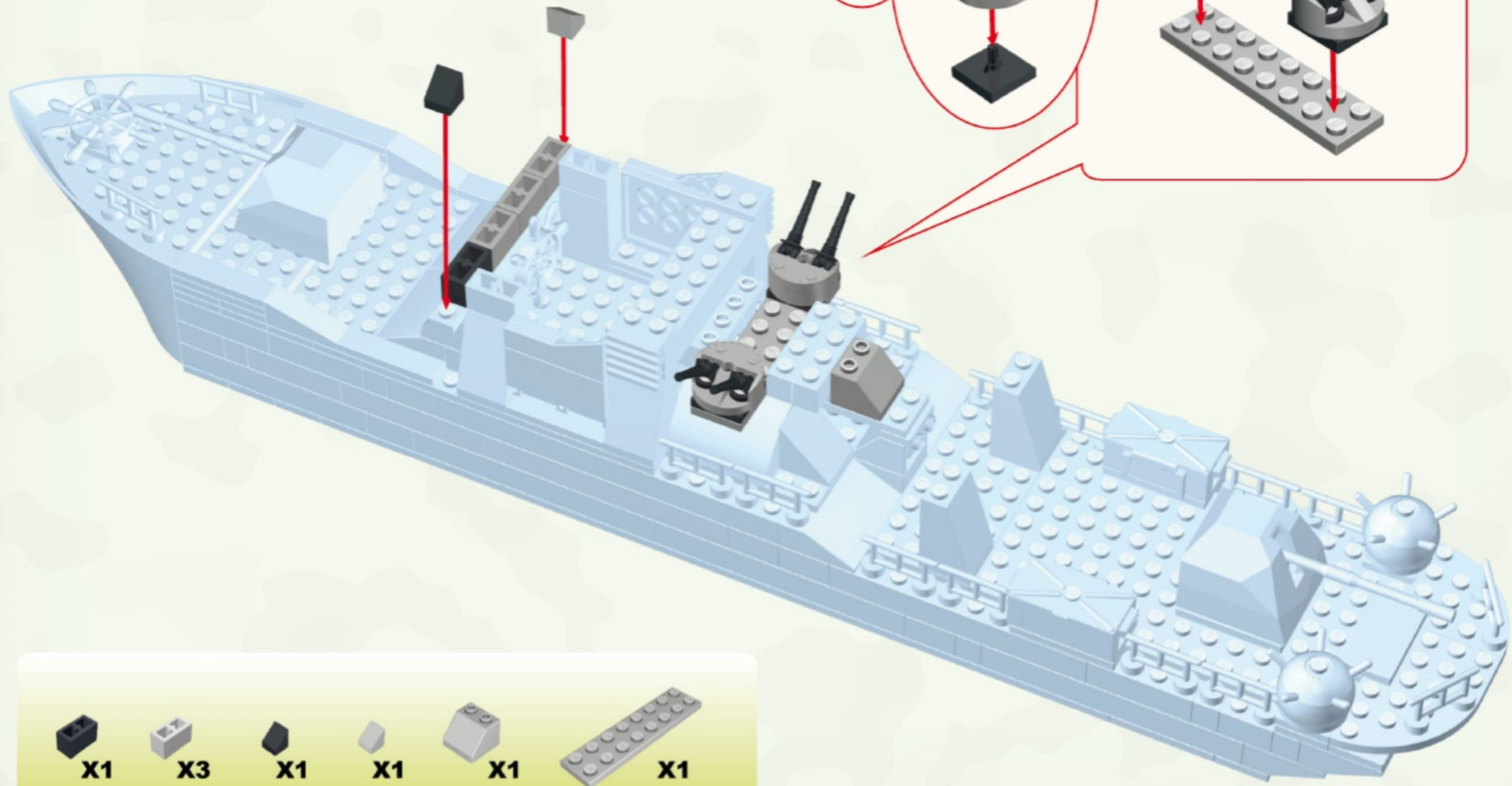



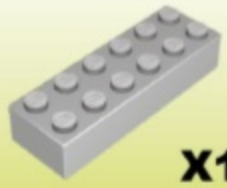
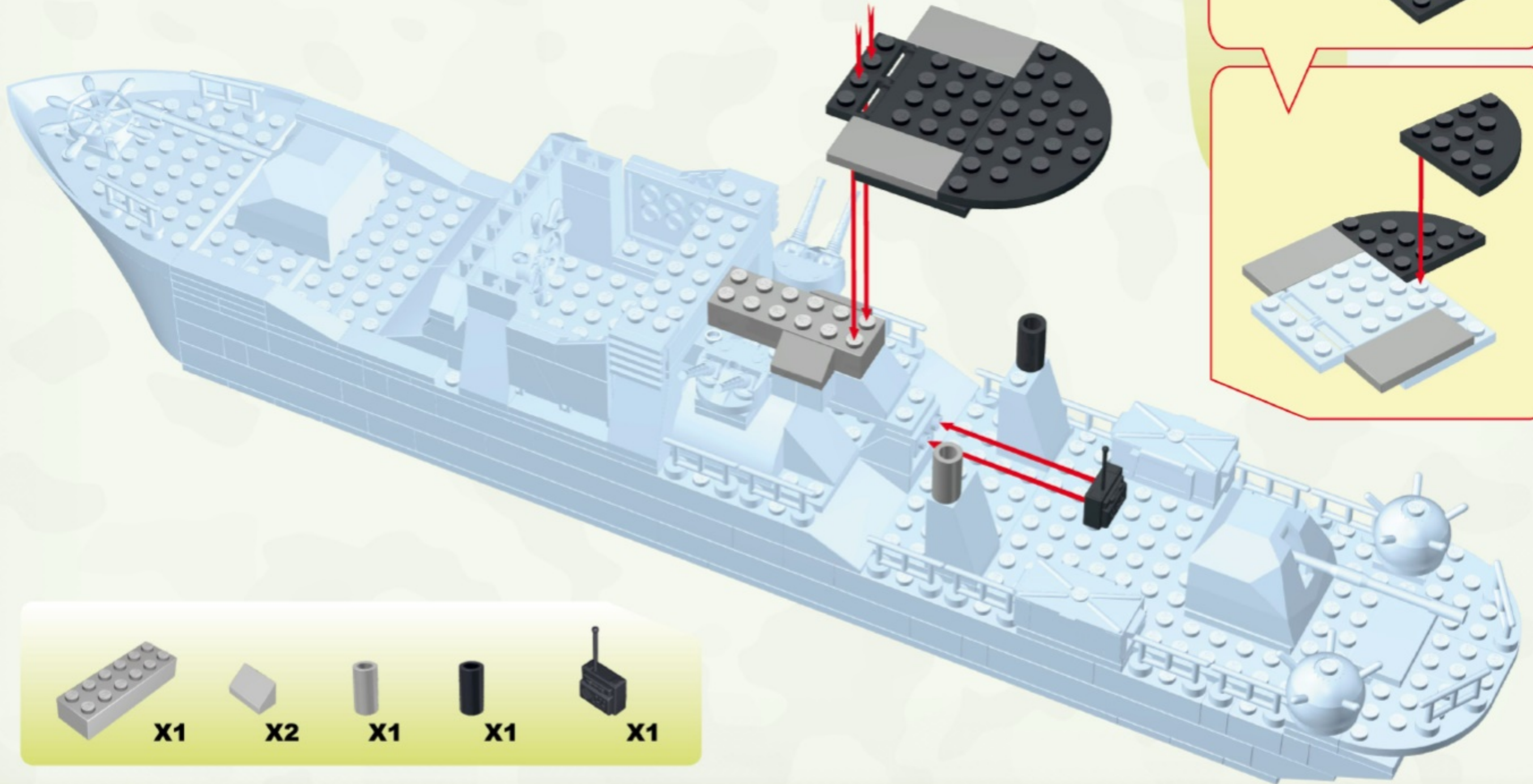
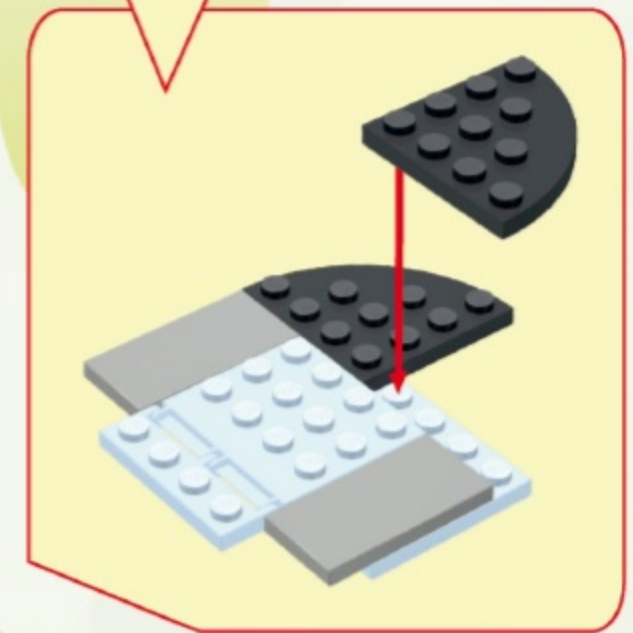
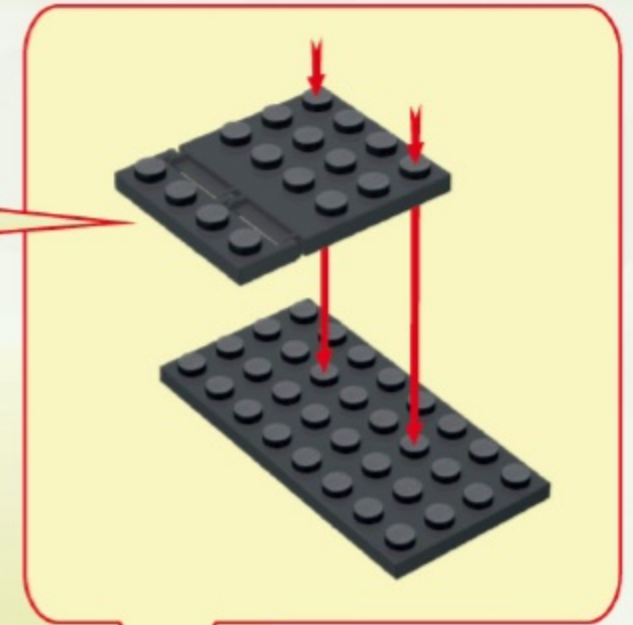
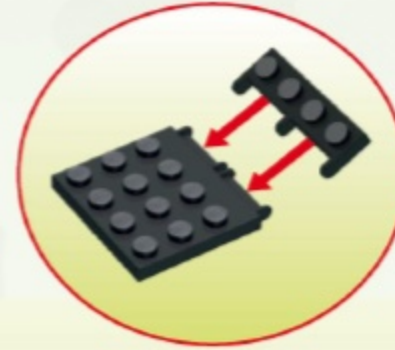
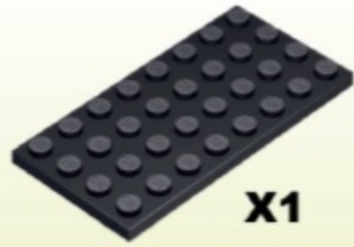

- X1 [Black 1x2 Technic brick]
- X3 [Grey 1x2 Technic brick]
- X1 [Black 1x2 Technic brick]
- X1 [Grey 1x2 Technic brick]
- X1 [Grey 1x2 Technic brick]
- X1 [Grey 1x6 Technic beam]

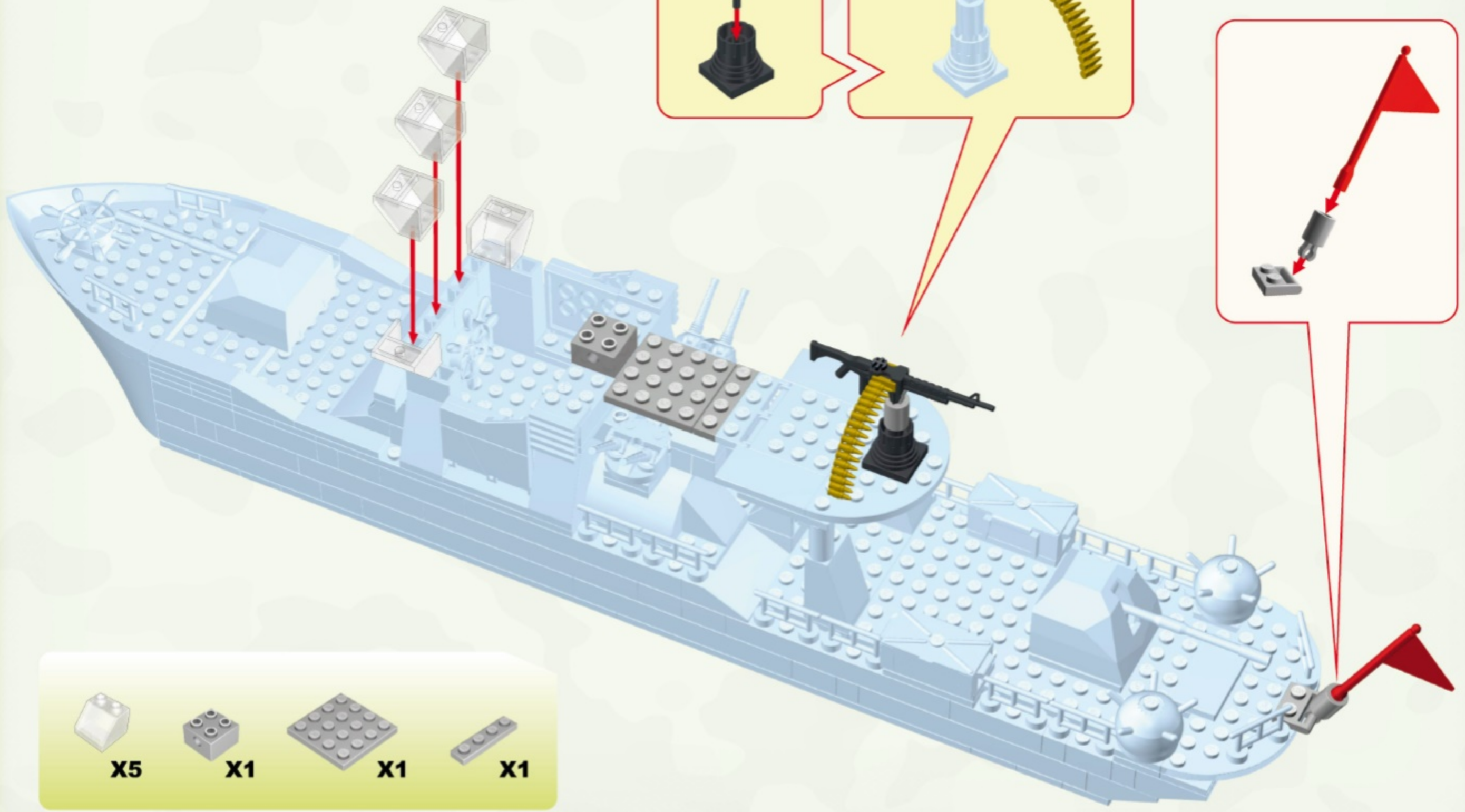
27.





-  X5
-  X1
-  X1
-  X1

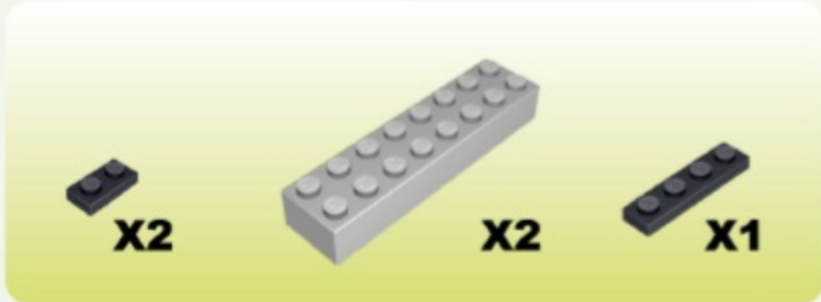
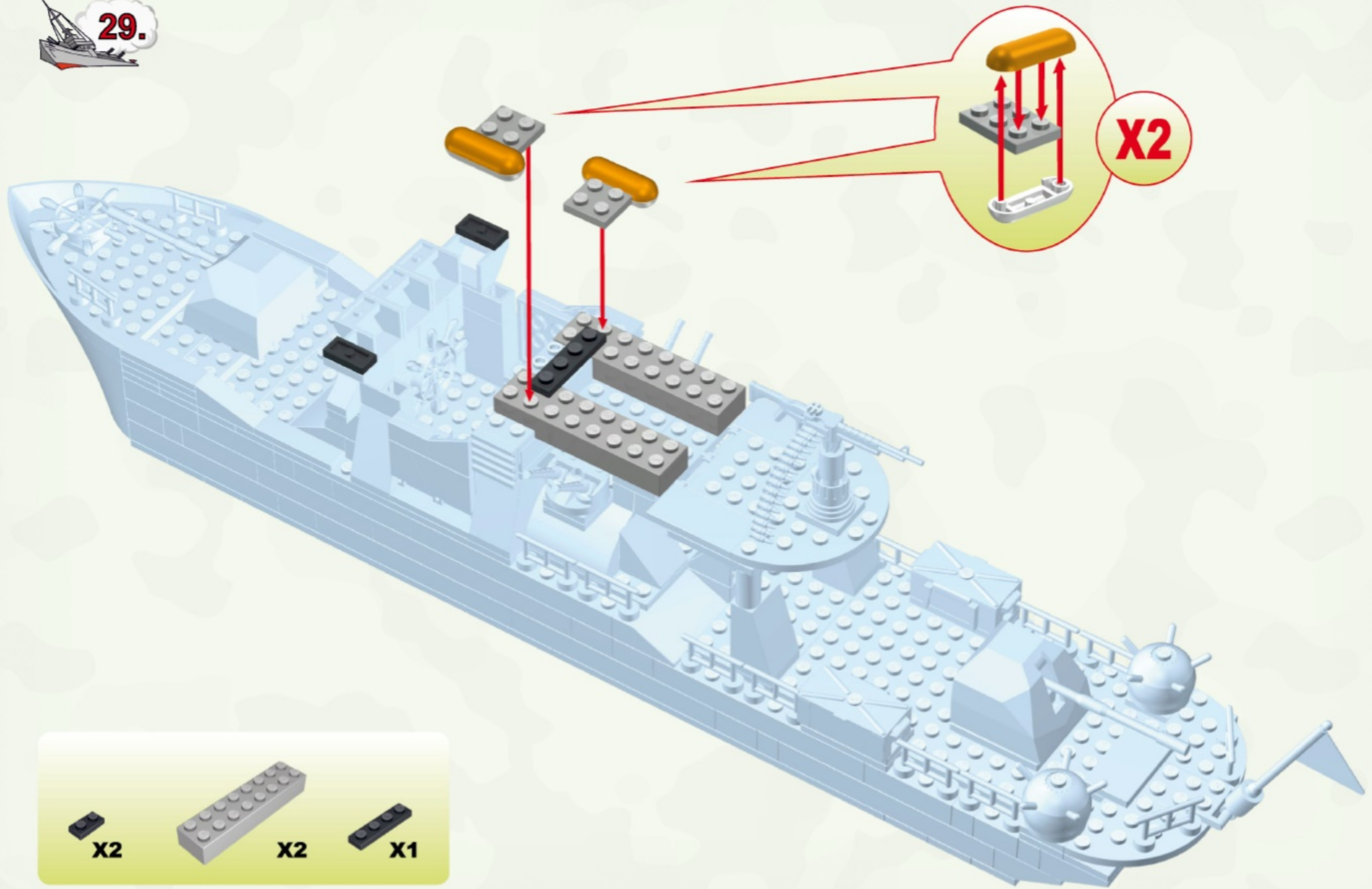

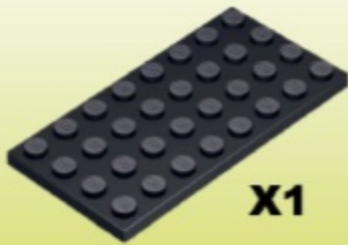
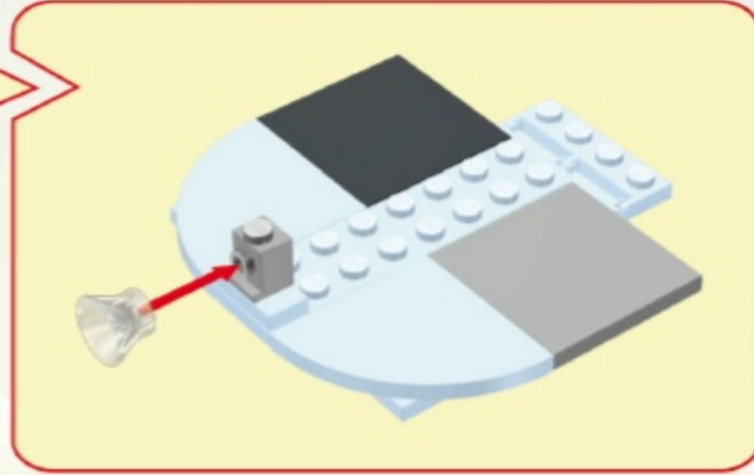
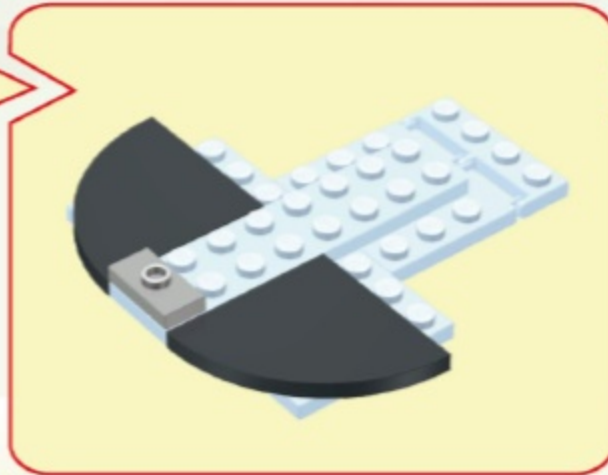
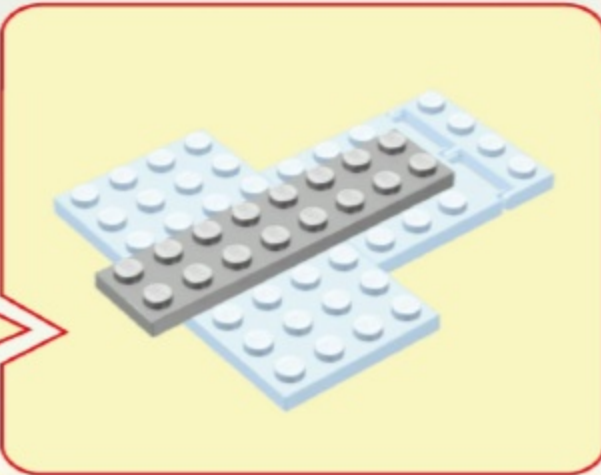
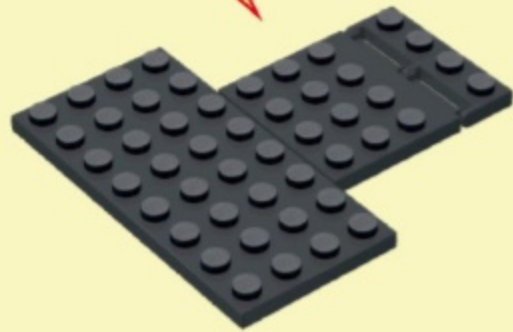

X1

X1

X1

X2

X1

X1

X1

X1

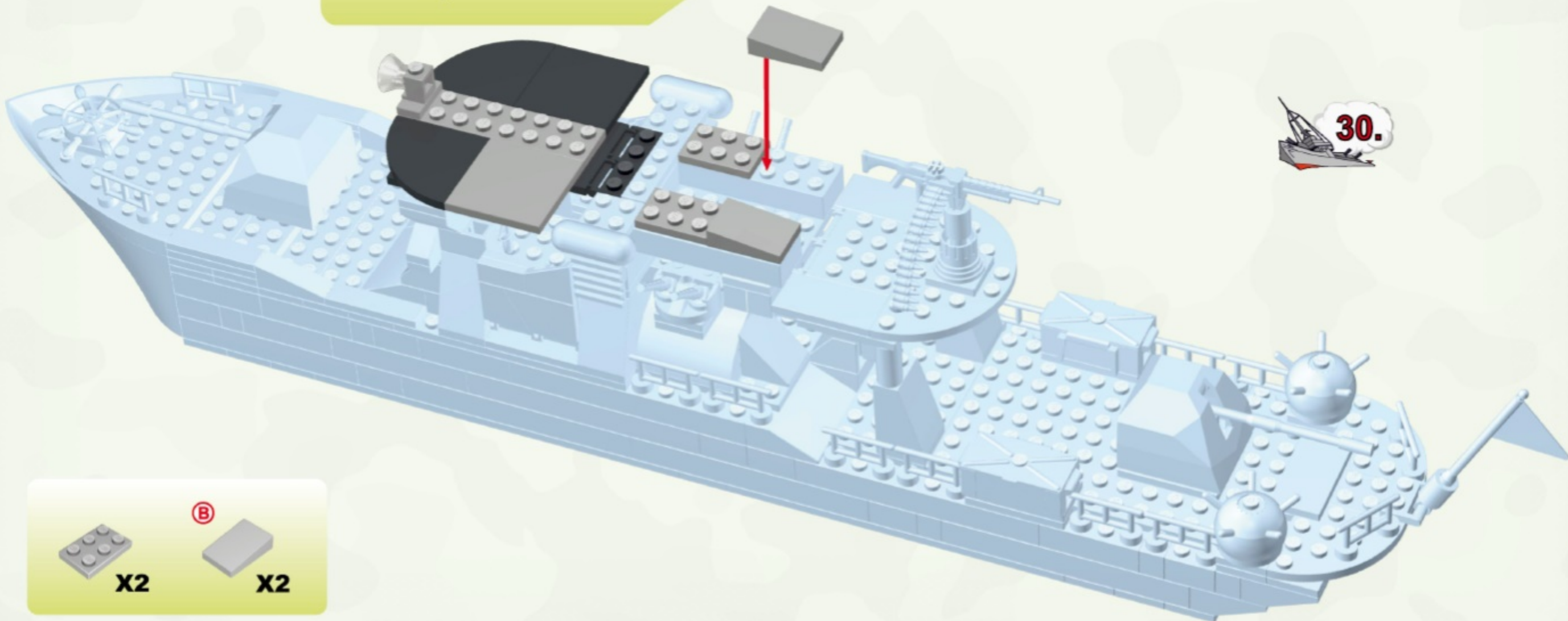



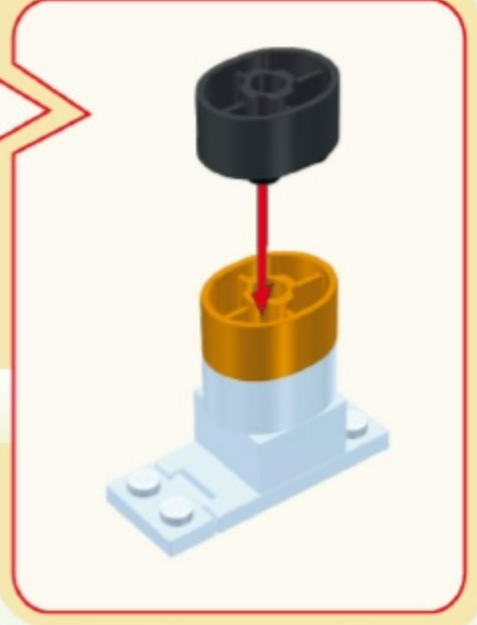
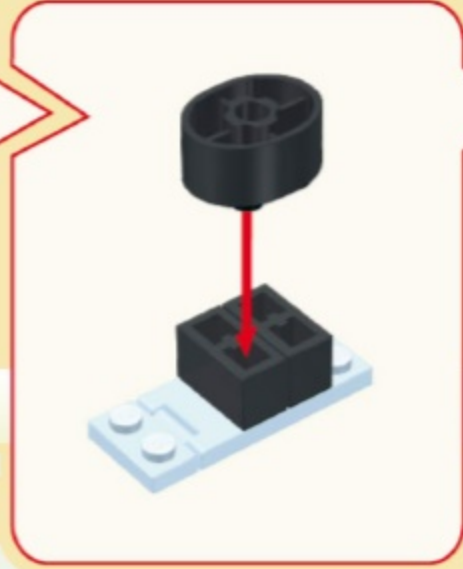
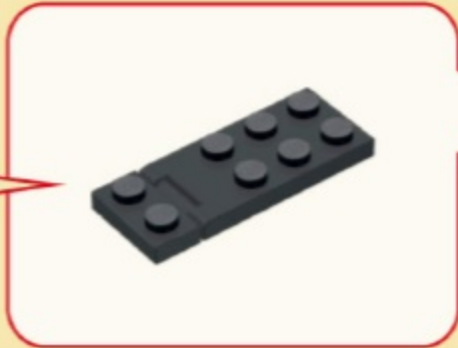
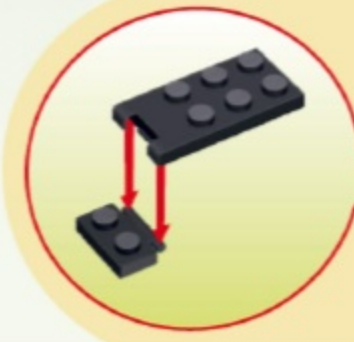

X2

X2

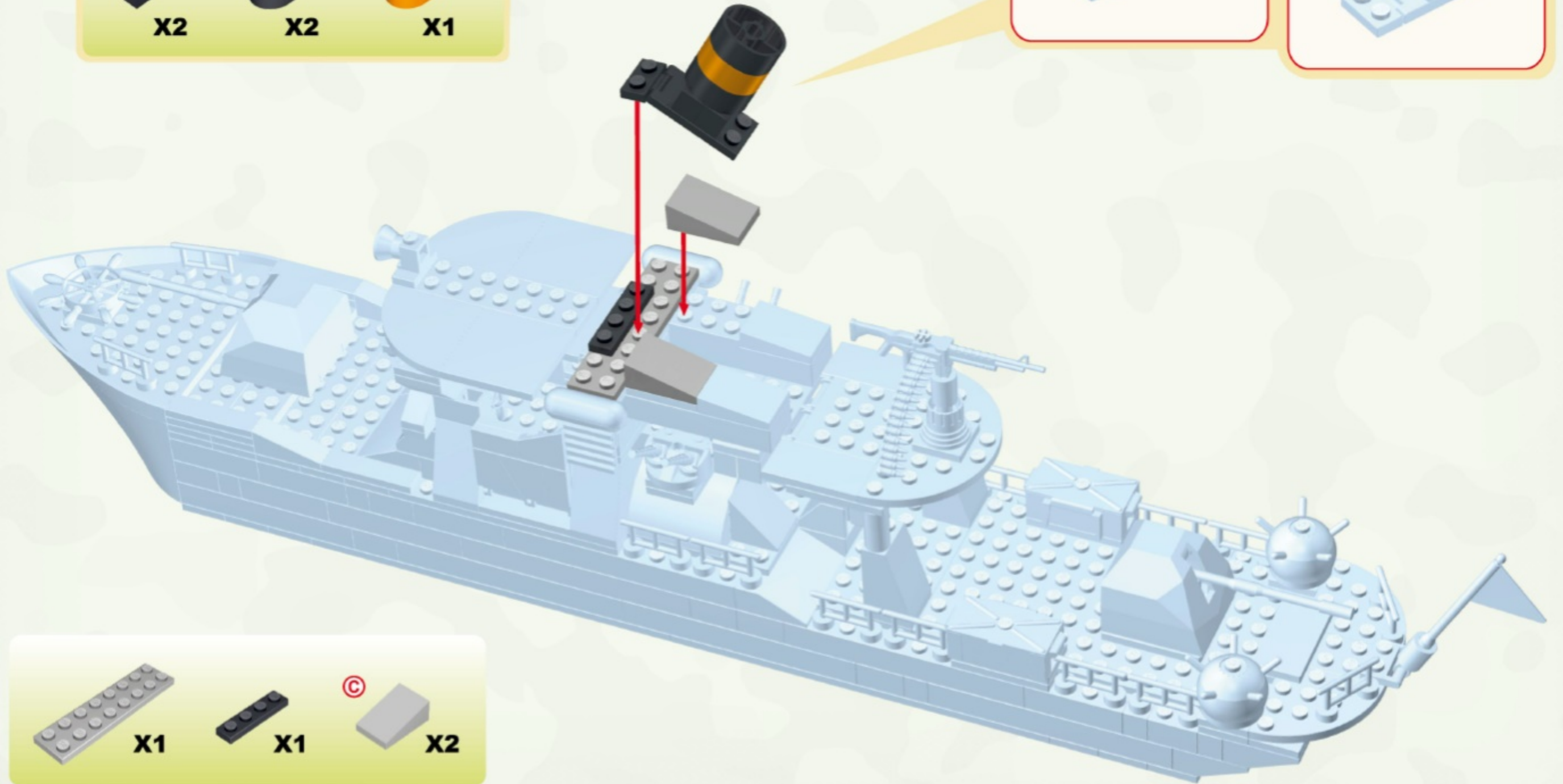

-  X2
-  X2
-  X1



-  X1
-  X1
-  X2

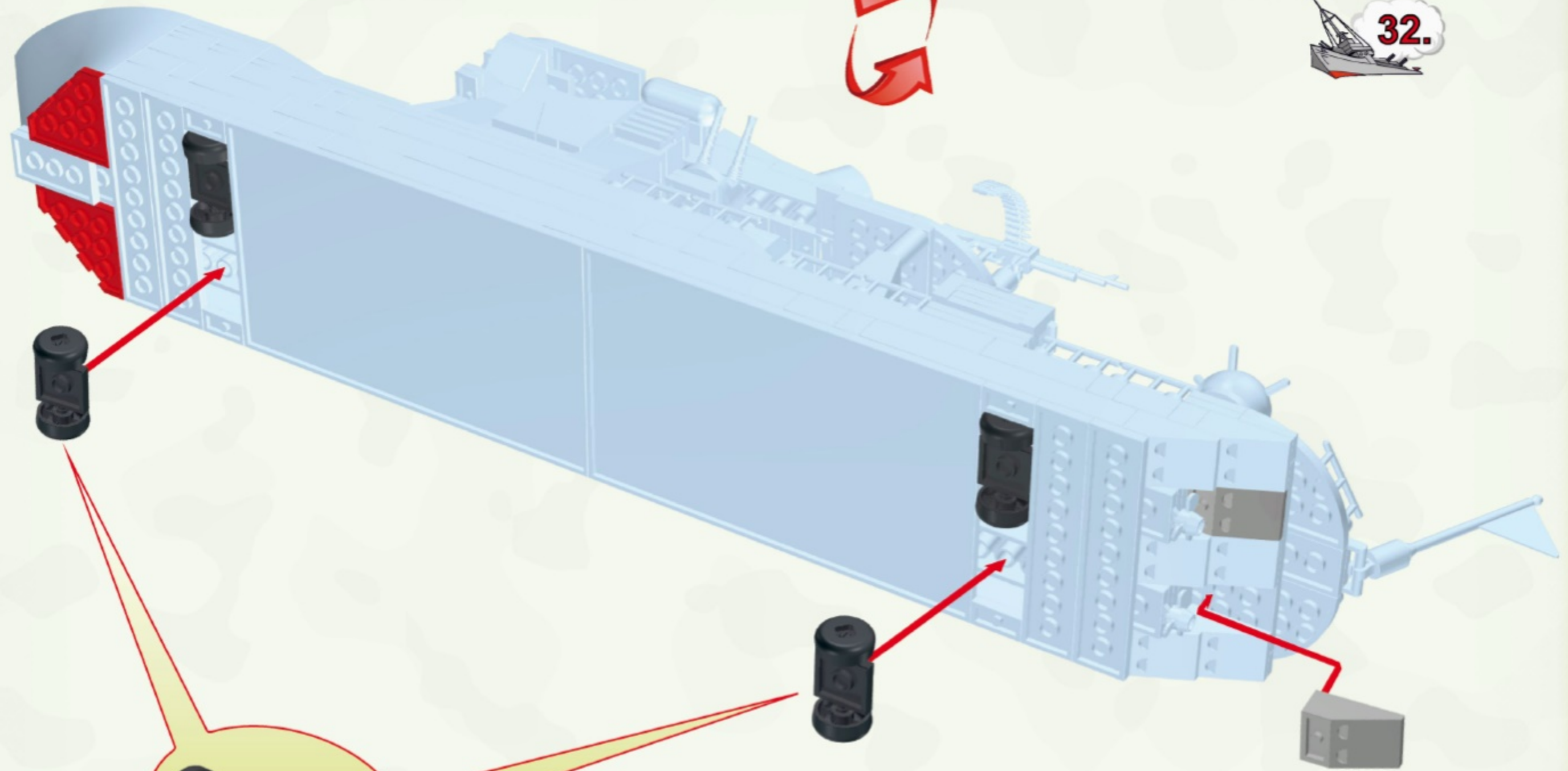

X4



X2

X2

33.



34.



35.



36.

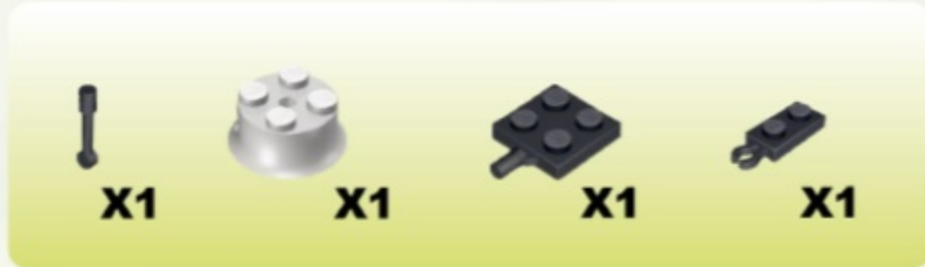
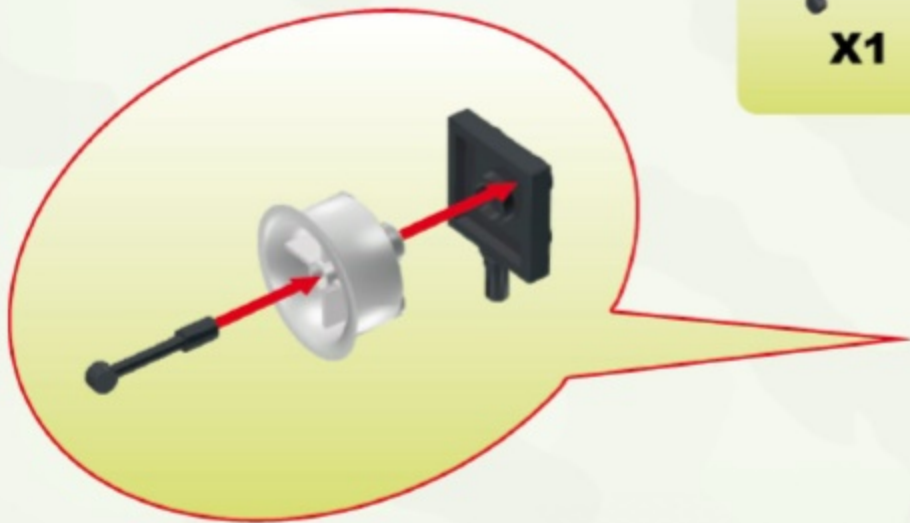

37.



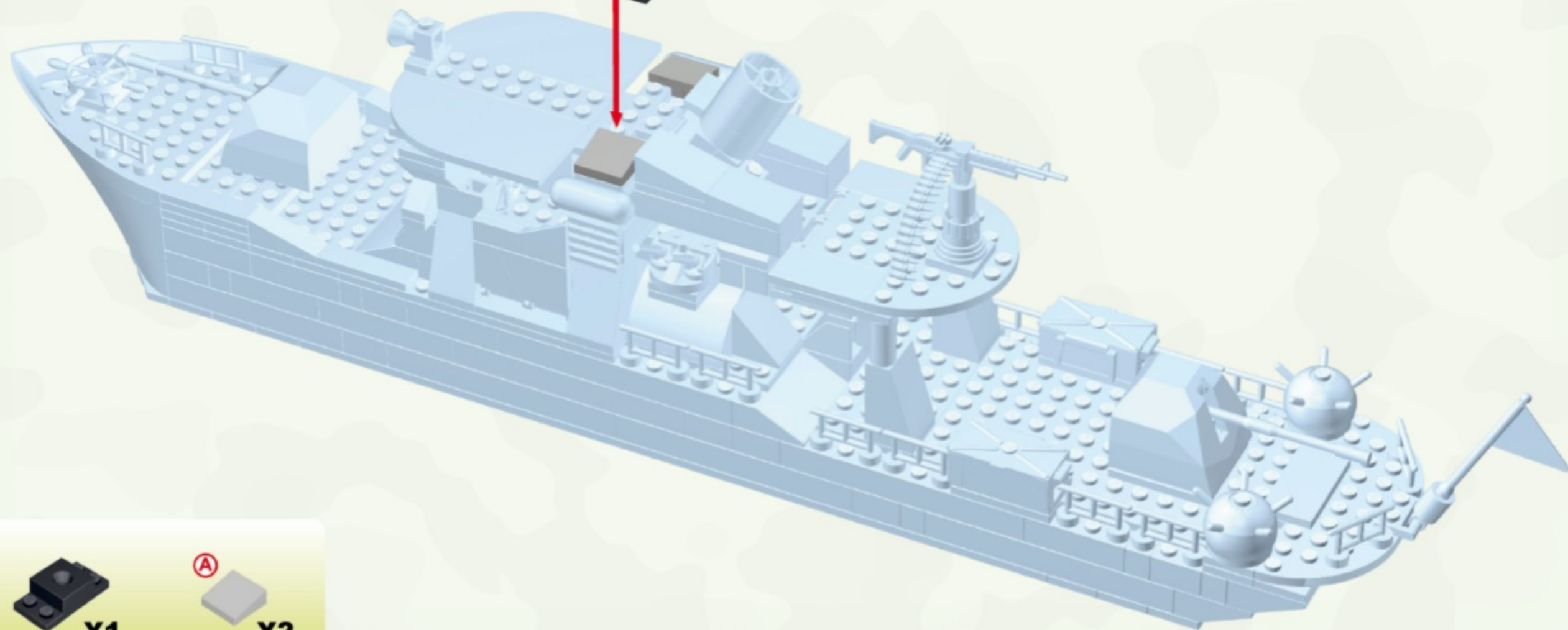

X1

A



X2

03-04436-339