

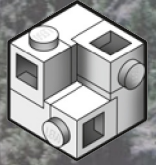

CREATOR™



EXPERT

10271



The Heritage

Le patrimoine

El legado

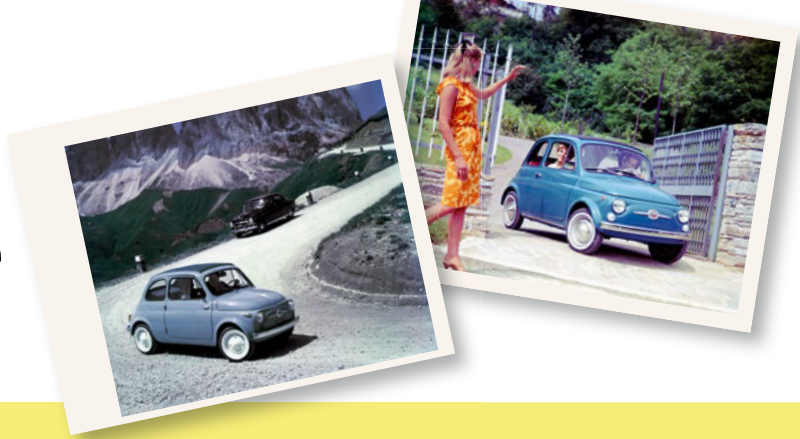

1899



1901



1904



1921



1925



1929



1931



1965



1931



1932



1938



1959



1968



1991



1999



2006



Vintage brochures for the Fiat 500

Brochures vintage de la Fiat 500

Antiguos folletos del Fiat 500





It all began in July 1899 when the Fabbrica Italiana Automobili Torino was founded as Italy's first automotive company. By 1900, 24 Fiat 3½ HP cars had rolled off the assembly line, built by a workforce of just 150 people. Soon Fiat would be producing everything from railway engines to farm tractors, but the company's central passion would always be the automobile. Throughout its 120-year history, Fiat has always played a visionary role in the continued evolution of what the company's founders called "democratic mobility."

Tout a commencé en juillet 1899, lors de la fondation de la Fabbrica Italiana Automobili Torino, la première entreprise automobile italienne. En 1900, 24 voitures Fiat 3½ HP avaient quitté la chaîne de montage, construites par un effectif de seulement 150 personnes. Fiat allait bientôt diversifier sa production, allant des locomotives aux tracteurs agricoles, mais la passion principale de l'entreprise restera toujours l'automobile. Tout au long de ses 120 ans d'histoire, Fiat a joué un rôle visionnaire dans l'évolution continue de ce que les fondateurs de l'entreprise ont appelé la « mobilité démocratique ».

Todo comenzó en julio de 1899, con la fundación de la Fabbrica Italiana Automobili Torino como primera empresa automovilística de Italia. En 1900, 24 autos Fiat 3½ HP ya habían salido de la línea de ensamble, en la que trabajaban solo 150 personas. Más adelante, Fiat fabricaría de todo: desde locomotoras hasta tractores agrícolas; sin embargo, la pasión de la empresa sería siempre el automóvil. A lo largo de sus 120 años de historia, Fiat ha interpretado constantemente un papel visionario en la permanente evolución de lo que los fundadores de la empresa llamaron "movilidad democrática".



1936-1955
FIAT 500 Topolino



1957-1960
FIAT Nuova 500



1960-1969
FIAT 500 D



1960-1977
FIAT 500 K/Giardiniera



The Fiat 500 La Fiat 500 El Fiat 500

1965-1972
FIAT 500 F



1968-1972
FIAT 500 L/Lusso



1972-1975
FIAT 500 R/Rinnovata



2007-2015
FIAT 500



2009-2015
FIAT 500 C



2015 - present
FIAT 500



Launched in 1957, the iconic 500 (pronounced Cinquecento in Italian) was the company's response to the need for a car that was both economical and practical. The two door, four-seat sedan was an inexpensive, compact vehicle measuring only 9 ft. 9 in. in length and powered by a 479cc two-cylinder, rear-mounted air-cooled engine. The true ingenuity of the design lay in overcoming the technological challenge of reducing the size of each component, while still maintaining the 500's youthful, timeless spirit.

Lancée en 1957, l'emblématique 500 (prononcé Cinquecento en italien) était la réponse de l'entreprise à la nécessité d'offrir une voiture à la fois économique et pratique. La berline à deux portes et quatre places était un véhicule compact peu coûteux mesurant seulement 2,97 m de longueur et propulsé par un moteur à deux cylindres de 479 cm³ monté à l'arrière et refroidi à l'air. La véritable ingéniosité de la conception consistait à surmonter le défi technologique que posait la réduction de la taille de chaque composant, tout en conservant l'esprit jeune et intemporel de la 500.

Puesto a la venta en 1957, el inconfundible 500 (*cinquecento*, en italiano) fue la respuesta de la empresa a la creciente necesidad de un auto que fuera a la vez económico y práctico. El sedán, de dos puertas y cuatro asientos, era un vehículo económico y compacto que medía solo 2,97 m de longitud y venía equipado un motor trasero refrigerado por aire de 479 cc y dos cilindros. La verdad ra brillantez del diseño residía en que superaba el desafío tecnológico de reducir el tamaño de todos los componentes, manteniendo el espíritu juvenil e intemporal que caracteriza al 500.





LA DOLCE VITA





In many ways the launch of the Fiat 500 captured the spirit of the time, especially in a mid 1950s Italy that was enjoying an economic boom and a cultural renaissance. The 500 quickly became an icon for a generation that was determined to savor what became known as “the good life” (La Dolce Vita).



À bien des égards, le lancement de la Fiat 500 a capturé l'esprit de l'époque, en particulier dans l'Italie du milieu des années 1950, qui connaissait un boom économique et une renaissance culturelle. La 500 est rapidement devenue une icône pour une génération déterminée à profiter de ce qui est connu comme la « dolce vita ».



En muchos sentidos, el lanzamiento del Fiat 500 cautivó el espíritu de la época, particularmente en la Italia de mediados de la década de 1950, que experimentaba un auge económico y un renacimiento cultural. El 500 se convirtió rápidamente en un ícono para una generación decidida a saborear lo que se conoció como “la buena vida” (*la dolce vita*, en italiano).

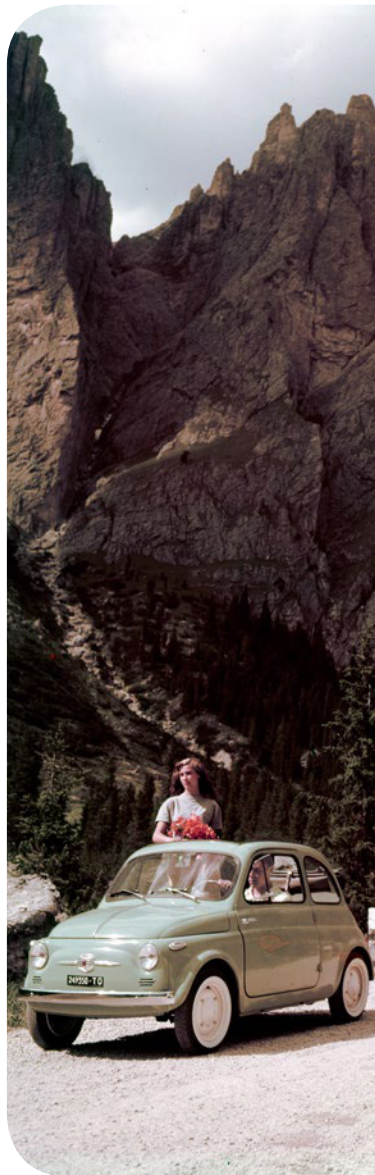

The Challenge

Le défi

El desafío

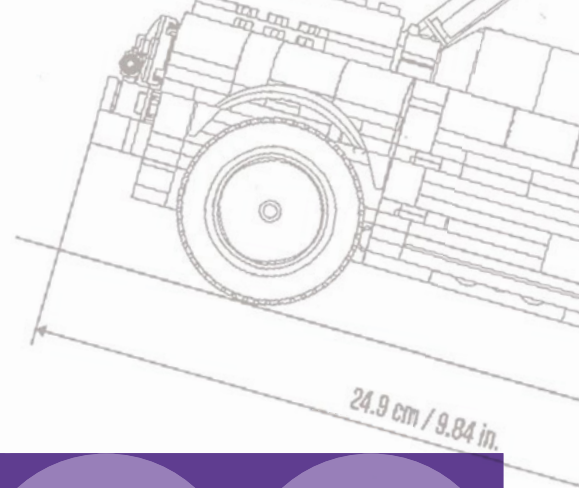

Curvy

“Capturing the compact size and the curvy shapes were probably the biggest challenges I faced creating this model. It changed every day until we thought we had something as close as possible to what we wanted it to look like. I’m quite satisfied with the car overall, but the interior details, the back hatch and the doors are among my favorite parts. We took an early version of the model to Turin, Italy. It was great to get feedback directly from the designers at Fiat and see how passionate they are about the 500 and its legacy.”

Colorful

“Even though it was never an official color for the Fiat 500, we decided to go for this cool yellow tone for a few reasons, the main one being to get a vibrant color that suited the “dolce vita” feeling that the 500 is often associated with. On top of that, it’s a relatively uncommon LEGO® color as well, so we knew our own fans would appreciate getting more LEGO elements in this rare color.”

Les courbes

« Recréer la taille compacte et les courbes de la voiture ont probablement été les plus grands défis auxquels j’ai dû faire face pour créer ce modèle. Il a changé tous les jours jusqu’à ce que nous ayons obtenu quelque chose qui se rapprochait le plus possible de ce que nous voulions. Je suis satisfait de la voiture dans l’ensemble, mais les détails intérieurs, le hayon et les portes sont parmi mes éléments préférés. Nous avons emporté une première version du modèle à Turin, en Italie. Il était fascinant d’obtenir des commentaires directement des concepteurs de Fiat et de voir à quel point ils sont passionnés par la 500 et son héritage. »

La couleur

« Même si ce ne fut jamais une couleur officielle de la Fiat 500, nous avons décidé de choisir ce ton jaune pour plusieurs raisons, la principale étant d’obtenir une couleur vive qui reflète la “dolce vita”, sentiment auquel la 500 est souvent associée. C’est de plus une couleur LEGO® relativement rare. Nous savions donc que nos propres fans apprécieraient obtenir plus d’éléments LEGO dans cette couleur rare. »

Pierre Normandin

LEGO® Senior Designer
Concepteur LEGO® principal
Diseñador sénior de LEGO®
LEGO Creator Expert



Curvas

“Capturar el carácter compacto y las formas curvas fue, probablemente, el mayor desafío al que me enfrenté al crear este modelo. Cambió todos los días hasta que nos pareció que teníamos algo suficientemente similar a lo que queríamos que fuera. Estoy muy satisfecho con el auto en general, pero los detalles interiores, el portón trasero y las puertas son algunas de mis partes favoritas. Llevamos una versión preliminar del modelo a Turín (Italia). Fue fantástico conocer la opinión directa de los diseñadores de Fiat y ser testigos de la pasión que sienten por el 500 y su legado”.

Color

“Aunque nunca llegó a ser uno de los colores oficiales del Fiat 500, nos decidimos por este tono amarillo tan genial por varias razones, la principal de las cuales era que queríamos usar un color vistoso que se ajustara a la sensación de *dolce vita* a la que suele asociarse el 500. Además, es un color relativamente raro en LEGO® y sabíamos que los fans agradecerían la posibilidad de obtener más elementos LEGO con un aspecto tan poco común”.



CREATOR™



EXPERT

It's the smallest details that make the biggest difference in a LEGO® Creator Expert model, so this Fiat 500 F model is packed with authentic functions and features that aim to capture the spirit of the original iconic vehicle.

Ce sont les plus petits détails qui font la plus grande différence dans un modèle LEGO® Creator Expert. Ce modèle Fiat 500 F comporte de nombreuses fonctionnalités et caractéristiques authentiques qui visent à capturer l'esprit du véhicule emblématique.

Son los detalles más pequeños los que marcan las mayores diferencias en un modelo LEGO® Creator Expert, y esta versión del Fiat 500 F cuenta con numerosas funciones y características de enorme realismo que tratan de capturar el inconfundible espíritu del vehículo original.





500

The original 500 series was produced from 1957 to 1975 and despite its small size proved an enormously popular vehicle. Fifty years after the first 500 was presented, Fiat launched an all-new, retro-styled 500 to take the icon into a new era.

La serie 500 original se fabricó entre 1957 y 1975. A pesar de su pequeño tamaño, resultó ser un vehículo enormemente popular. Cincuenta años después de la presentación del primer 500, Fiat lanzó un 500 totalmente renovado, aunque de estilo retro, para introducir al ícono en una nueva era.

La série originale 500 a été produite de 1957 à 1975 et malgré sa petite taille, elle s'est avérée être une voiture extrêmement populaire. Cinquante ans après la présentation de la première 500, Fiat a lancé une toute nouvelle 500 de style rétro pour faire entrer cette icône dans une nouvelle ère.

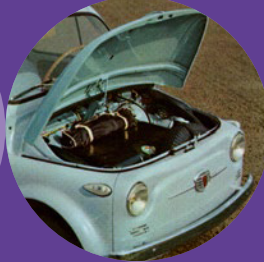

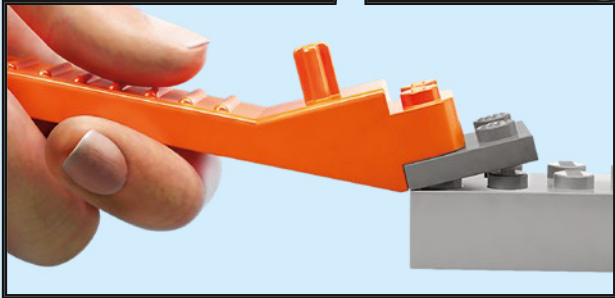
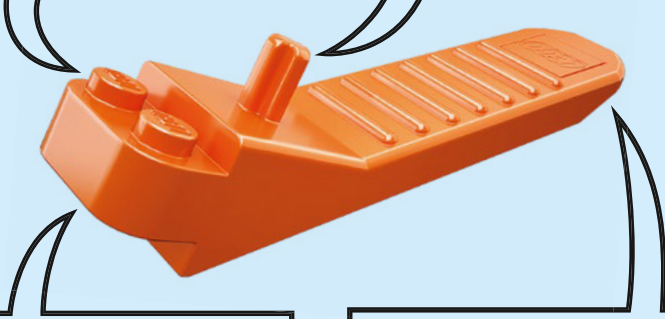
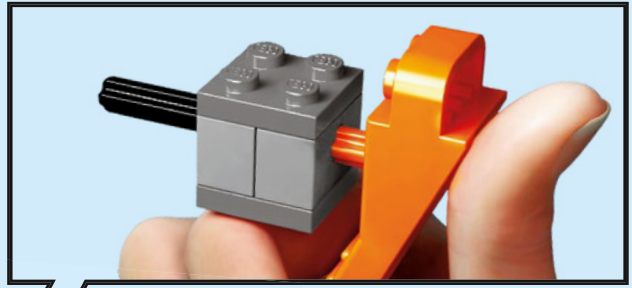
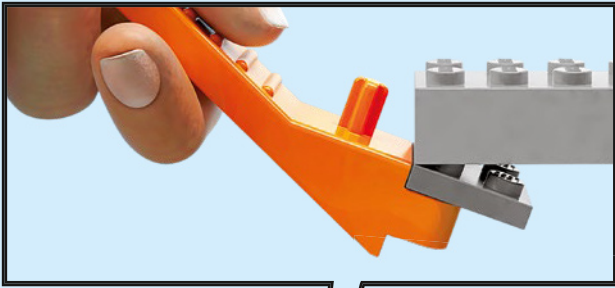



- 1** Scan the code on the front cover
 Scanne den Code auf der Titelseite
 Scanne le code sur la page de couverture
 Scanner le code sur la page couverture
 Scansiona il codice sulla copertina
 Escanea el código de la portada
 Faz scan do código na frente da capa
 Olvasd be a borítón látható kódot!
 Noskenē kodu uz priekšējā vāka
 扫描封面上的二维码

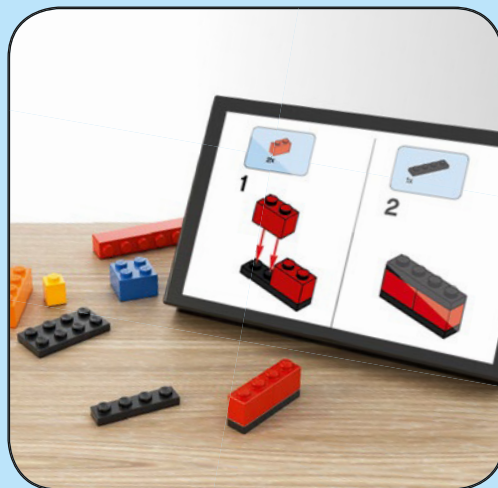

- 2** Get the Building Instructions
 Hol dir die Bauanleitung
 Hol dir die Bauanleitung
 Obtens les instructions de montage
 Obtenir les instructions de montage
 Scarica le istruzioni per la costruzione
 Consulta las instrucciones de construcción
 Obtém as Instruções de Construção
 Szerezd be az építési útmutatókat!
 Saņem būvēšanas instrukcijas
 获取拼搭说明

LEGO.com/apps

Check for compatibility
 Kompatibilität prüfen
 Vérifier la compatibilité
 Controlla la compatibilità
 Comprueba tu compatibilidad

Verificar a compatibilidade
 Ellenőrizd a kompatibilitást
 Pārbaudīt saderību
 检查兼容性

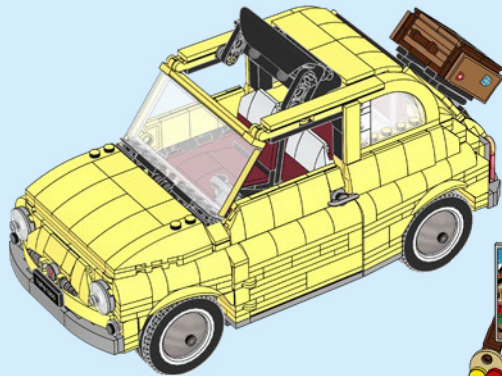
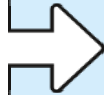
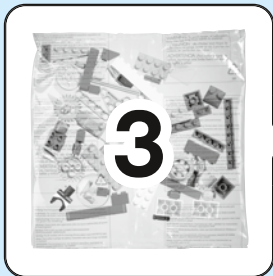
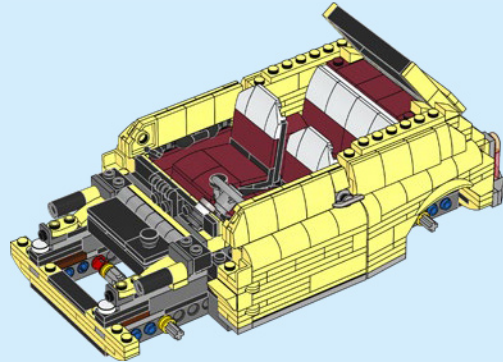
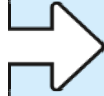
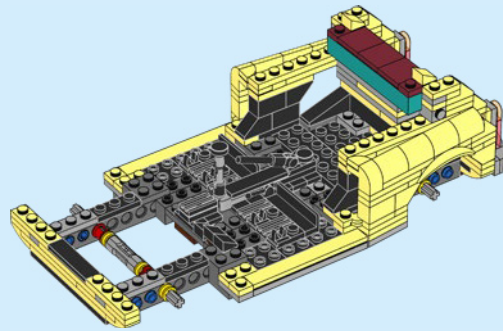
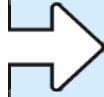

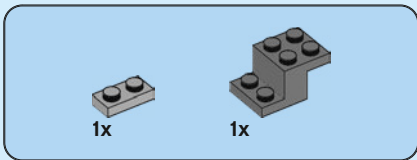
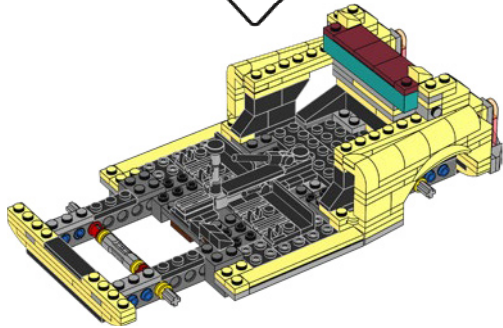

1

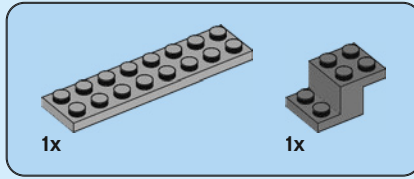
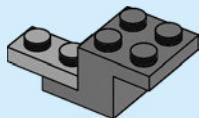

2

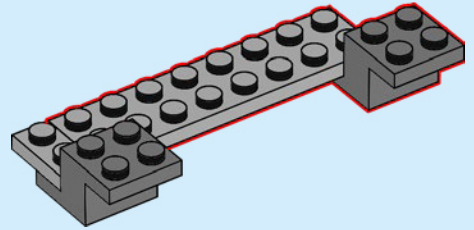

3

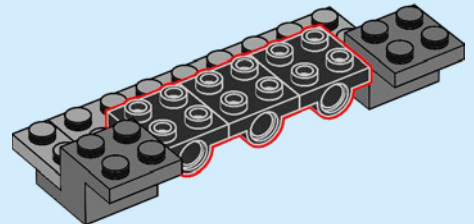

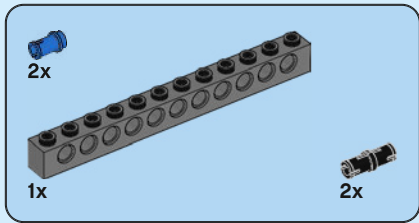

4

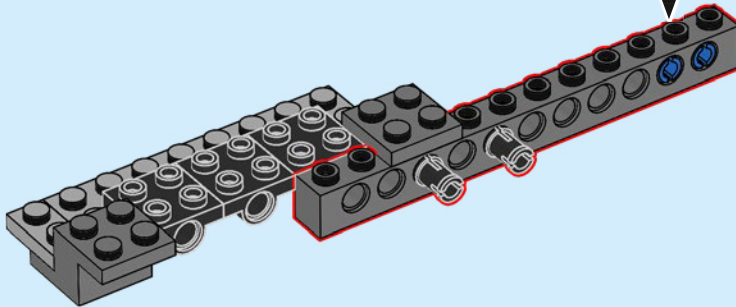
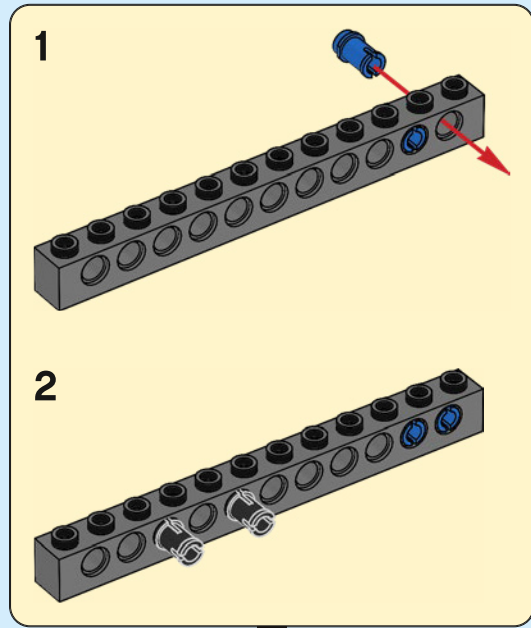

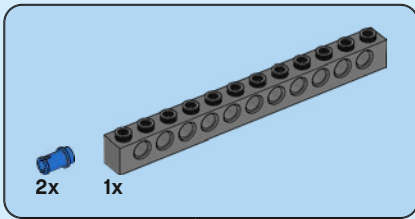

5

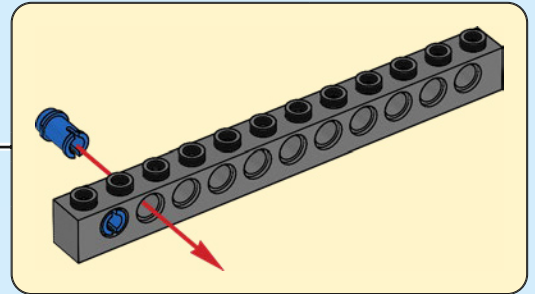
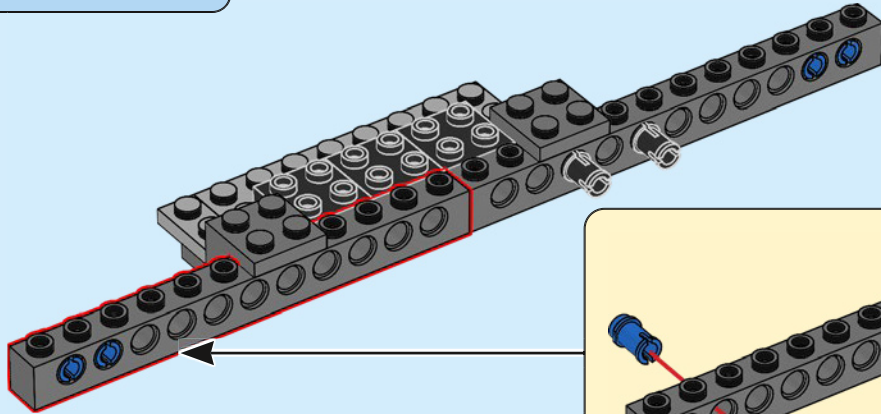

6

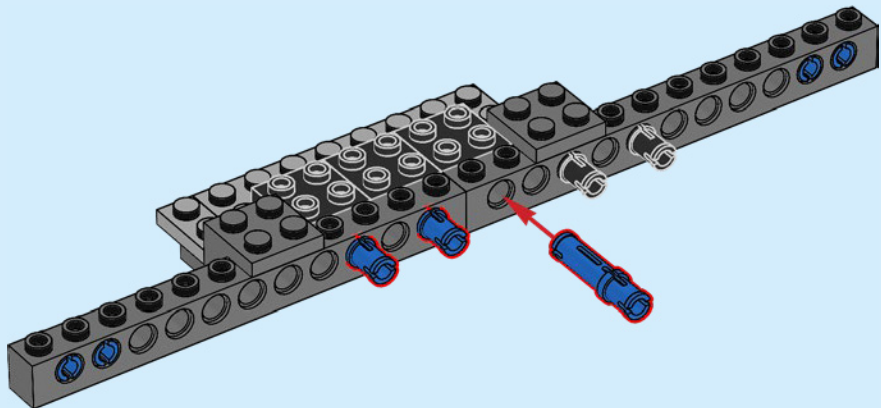

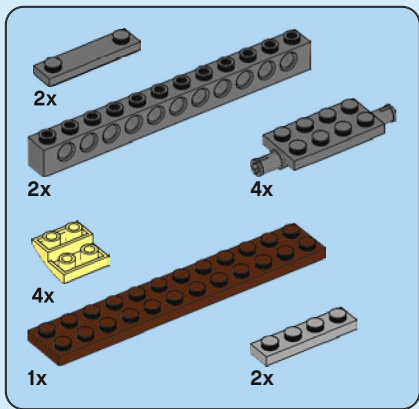

7

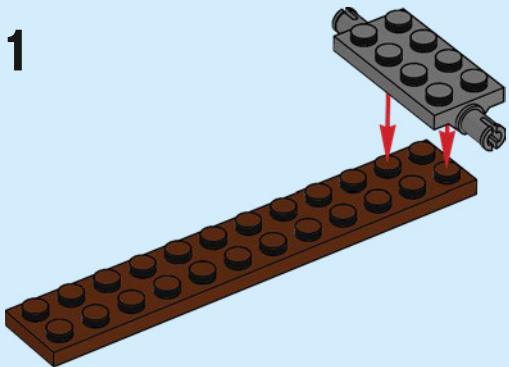

2

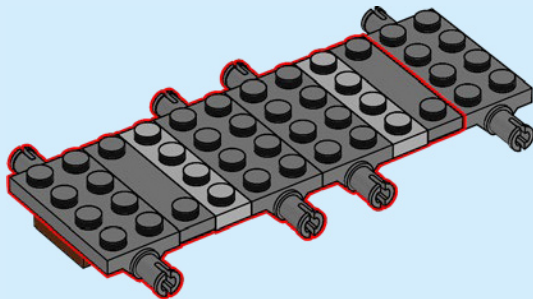

3

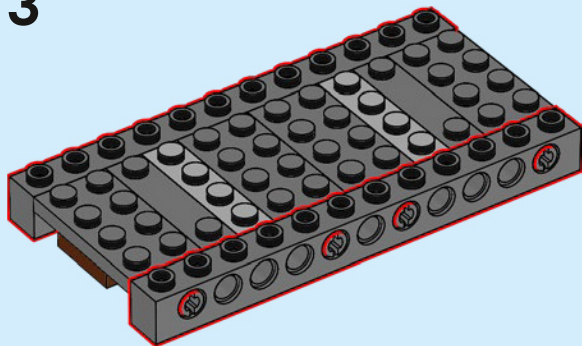

4

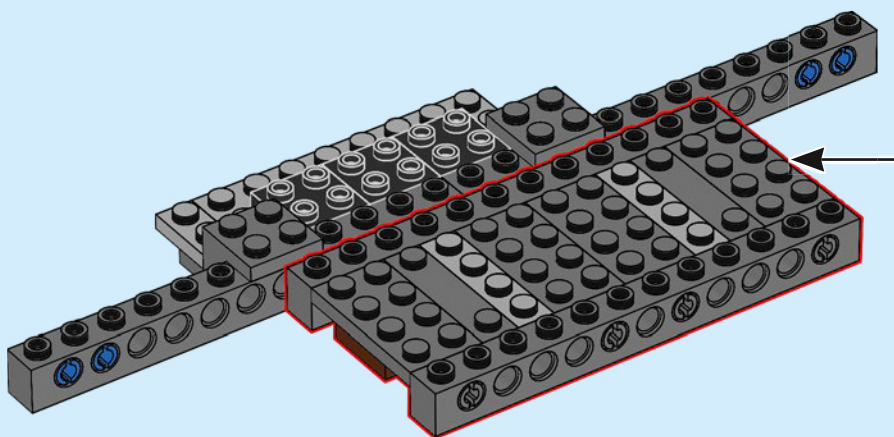
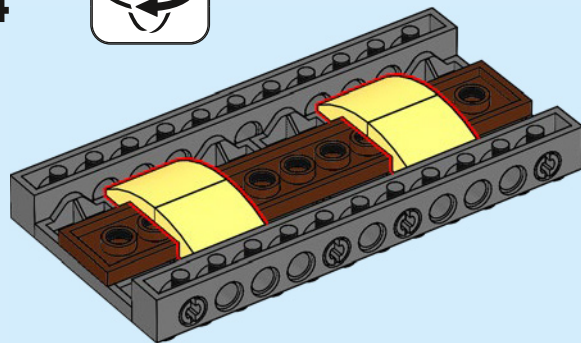

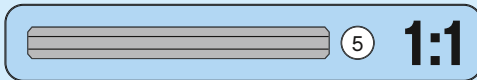
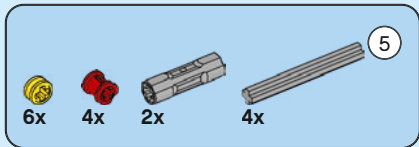

8

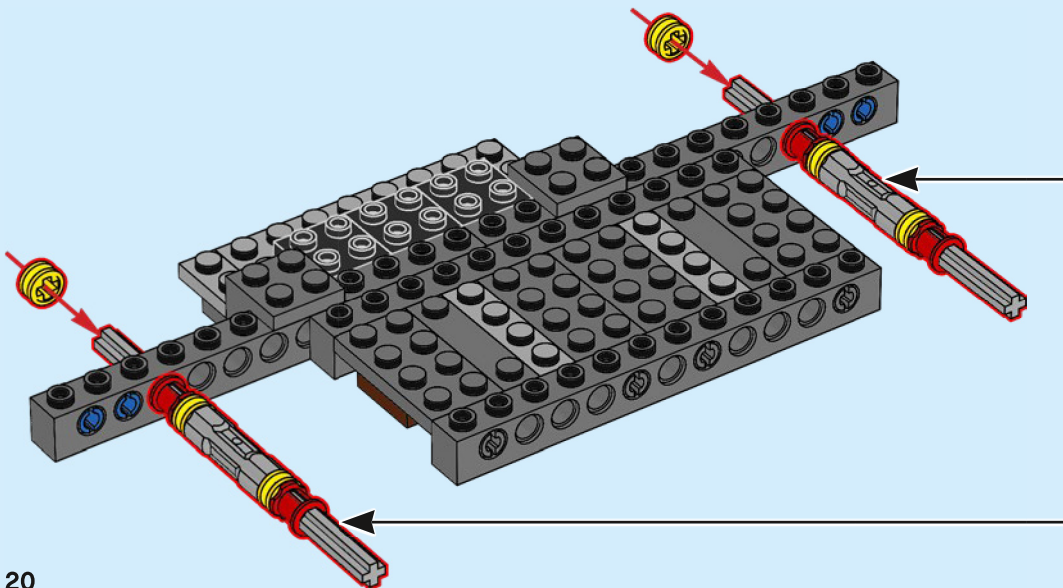
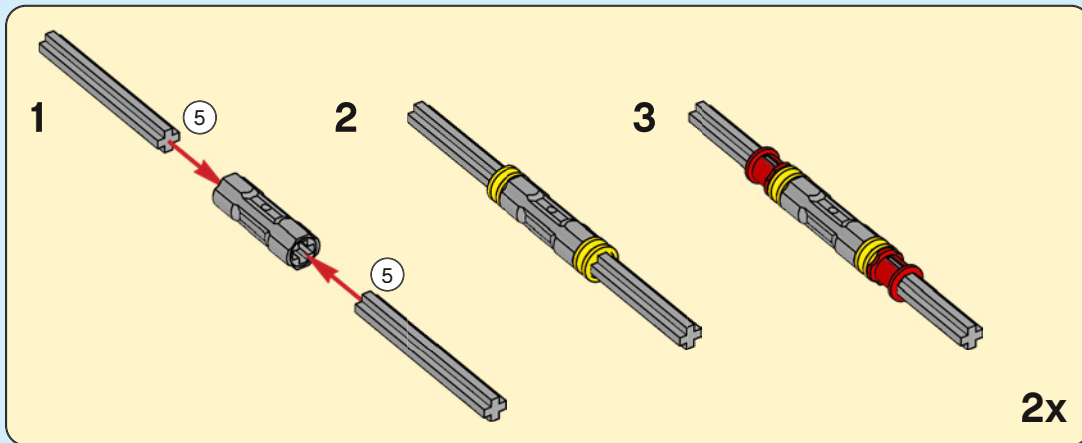

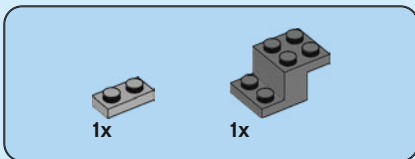
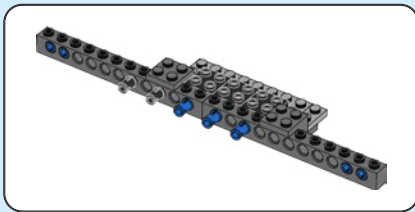

9

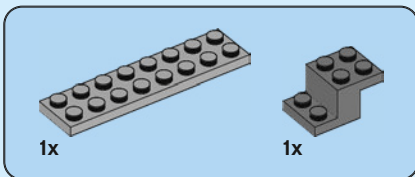
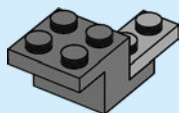

10

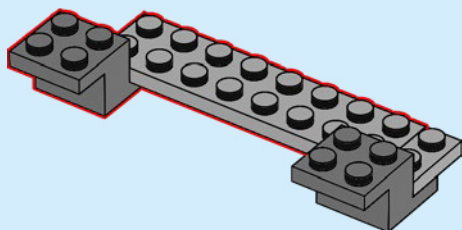

11

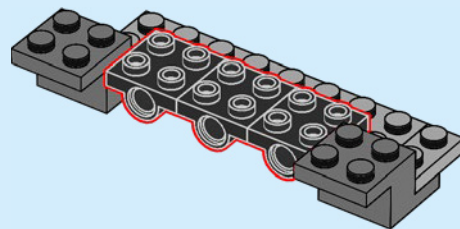

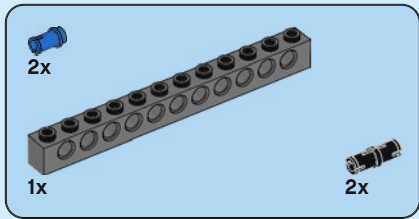

12

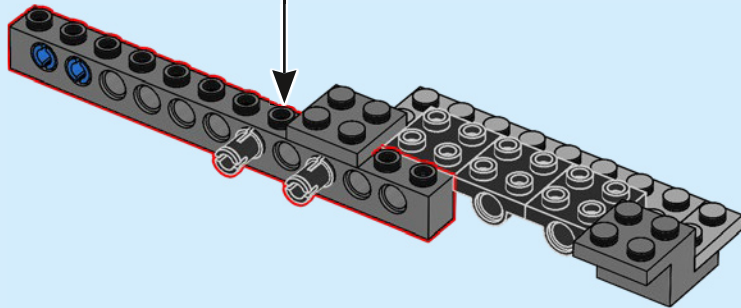
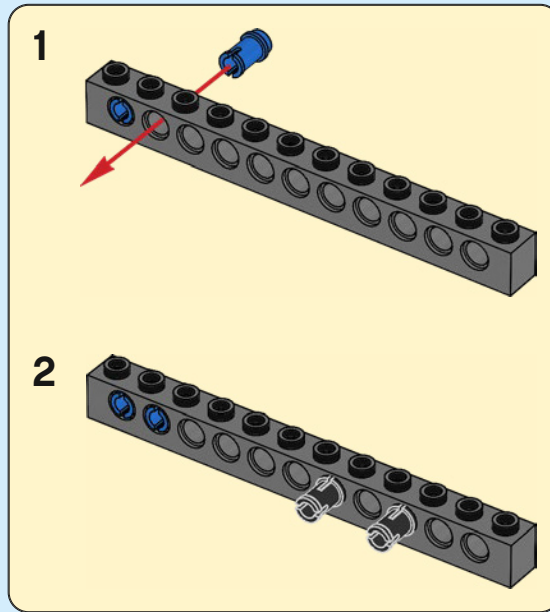

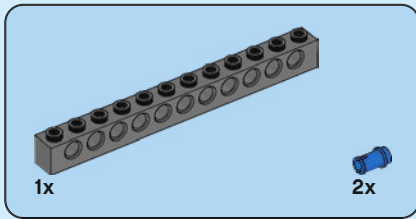

13

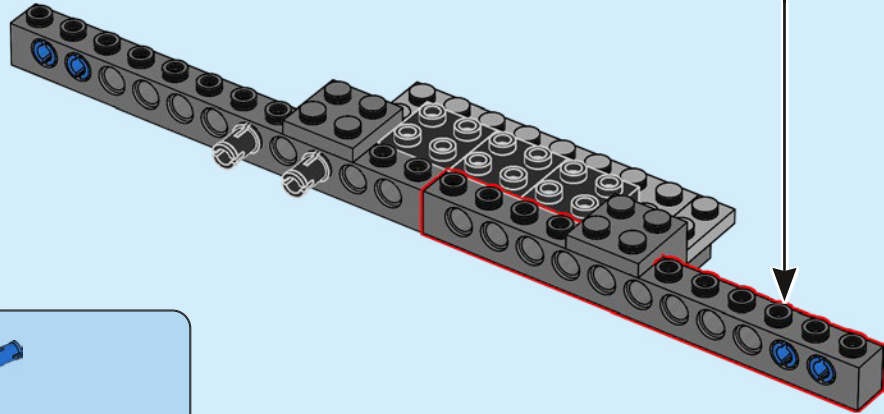
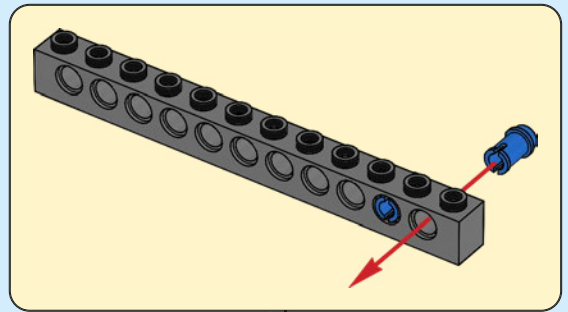

14

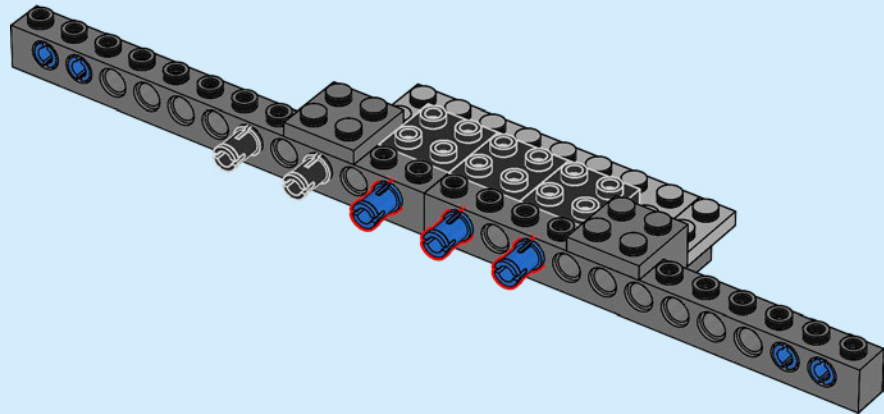

15

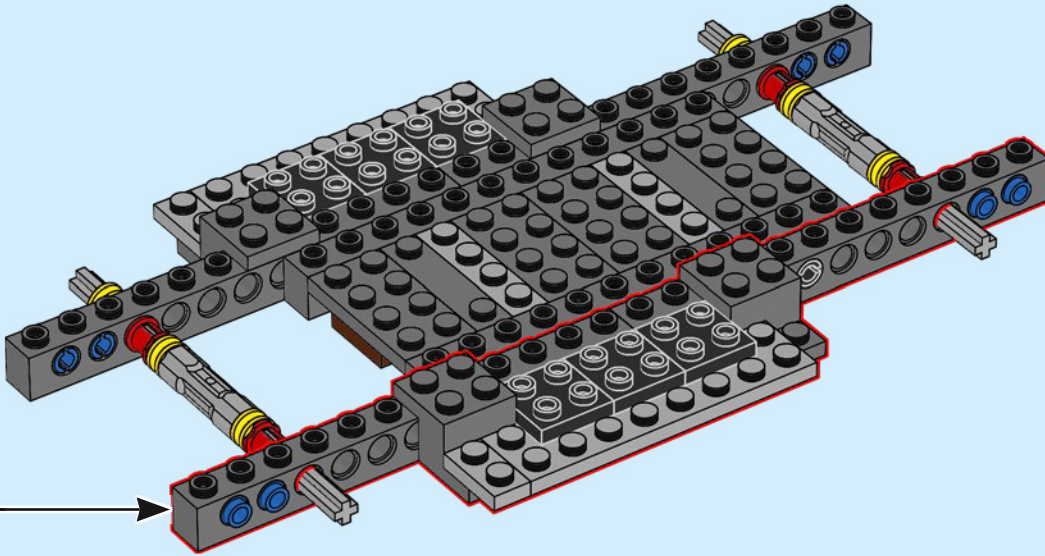

2x

16

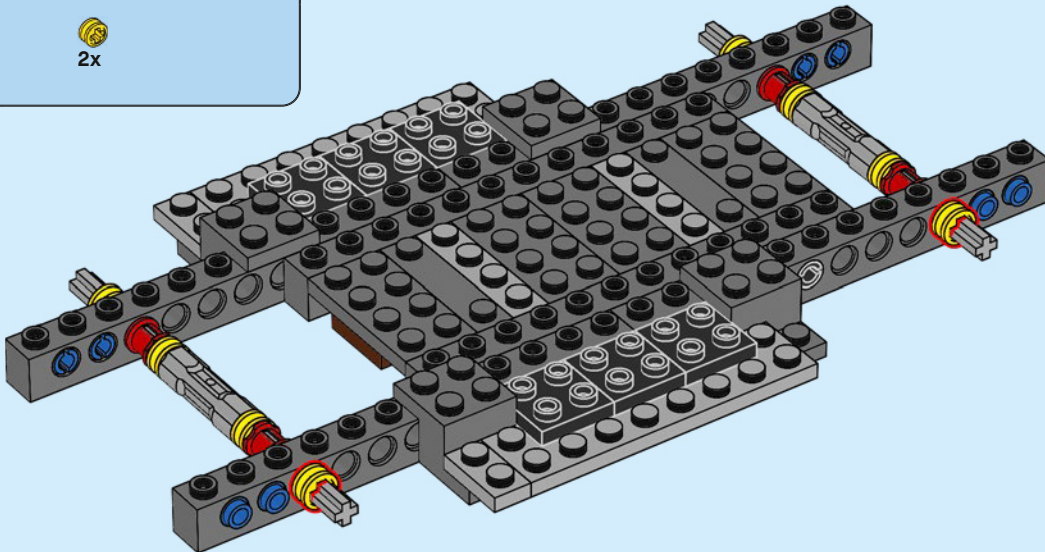

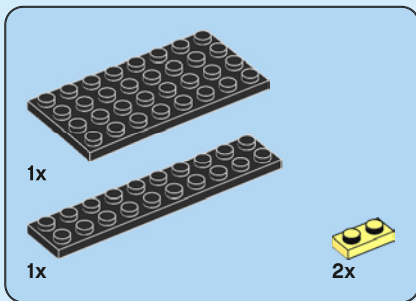

17

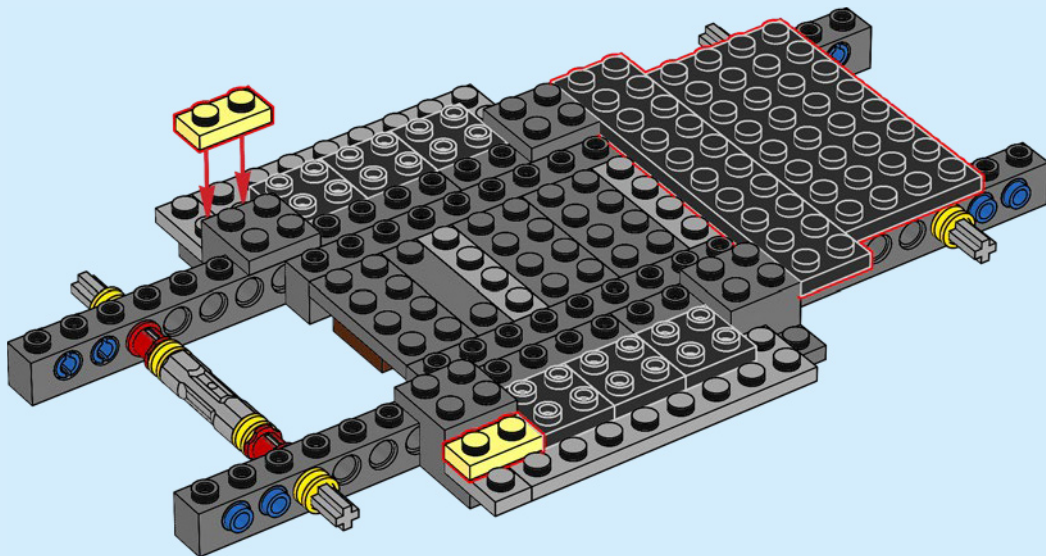

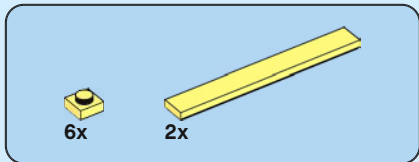

18

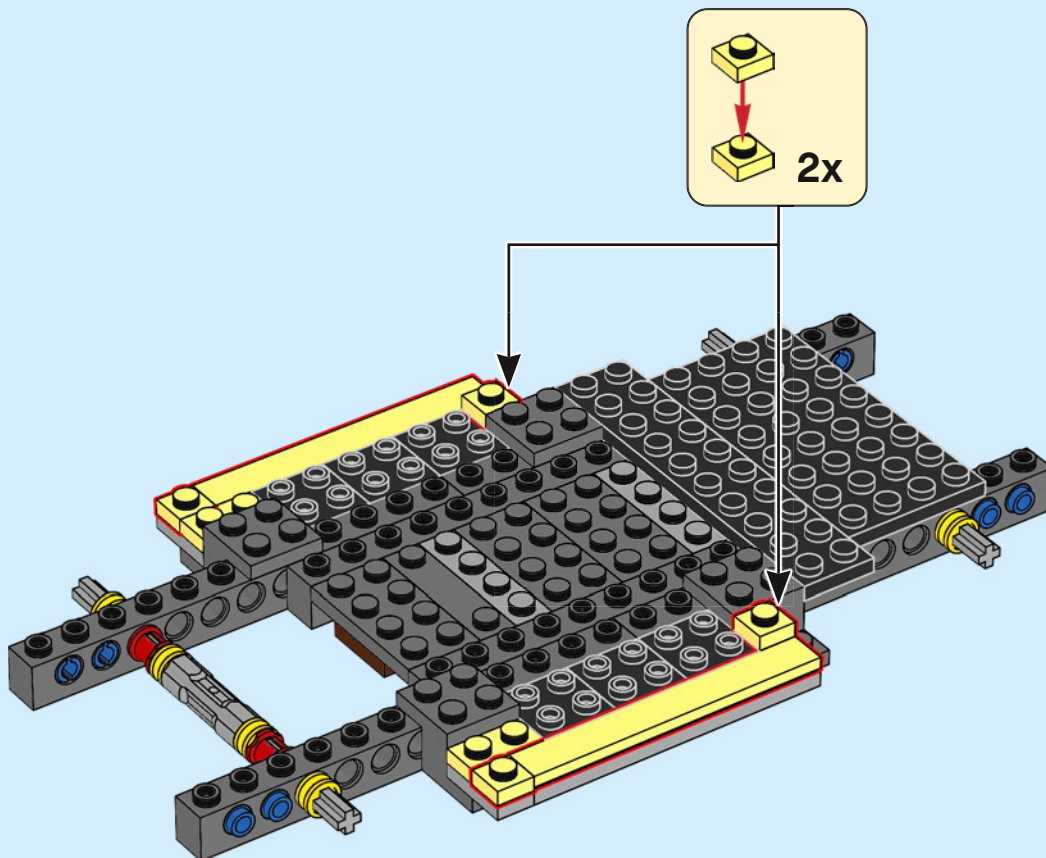

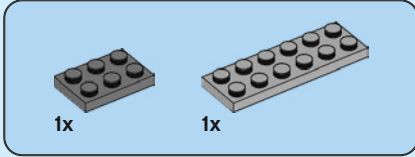
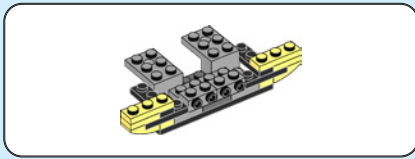

19

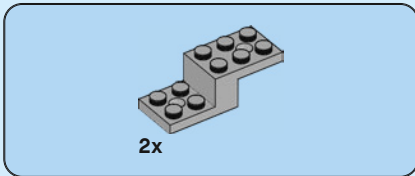
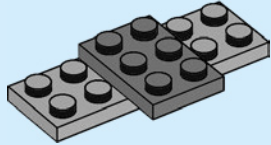

20

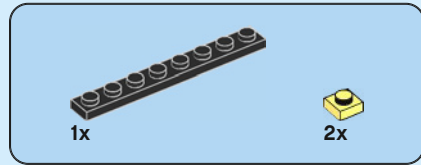
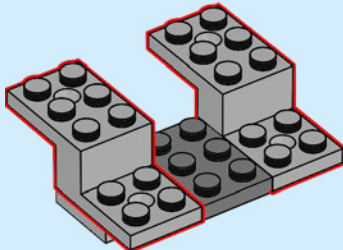

21

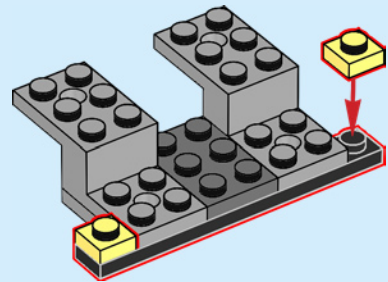



22

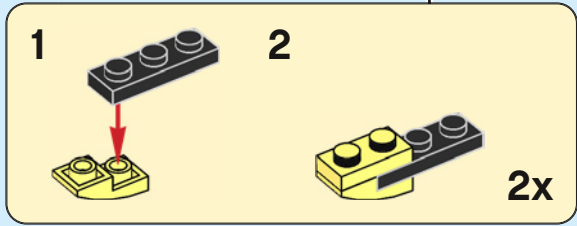
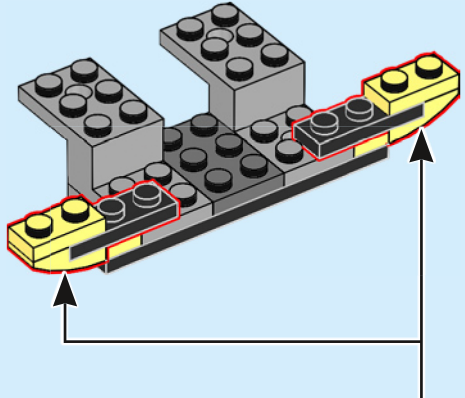

23

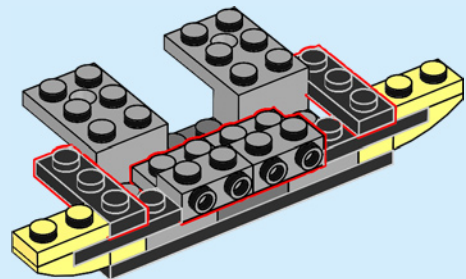

24

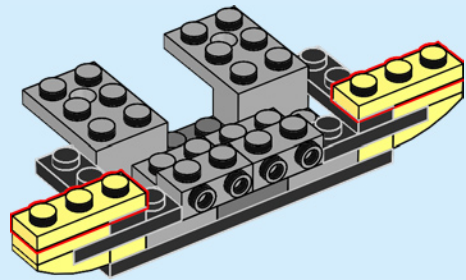

25

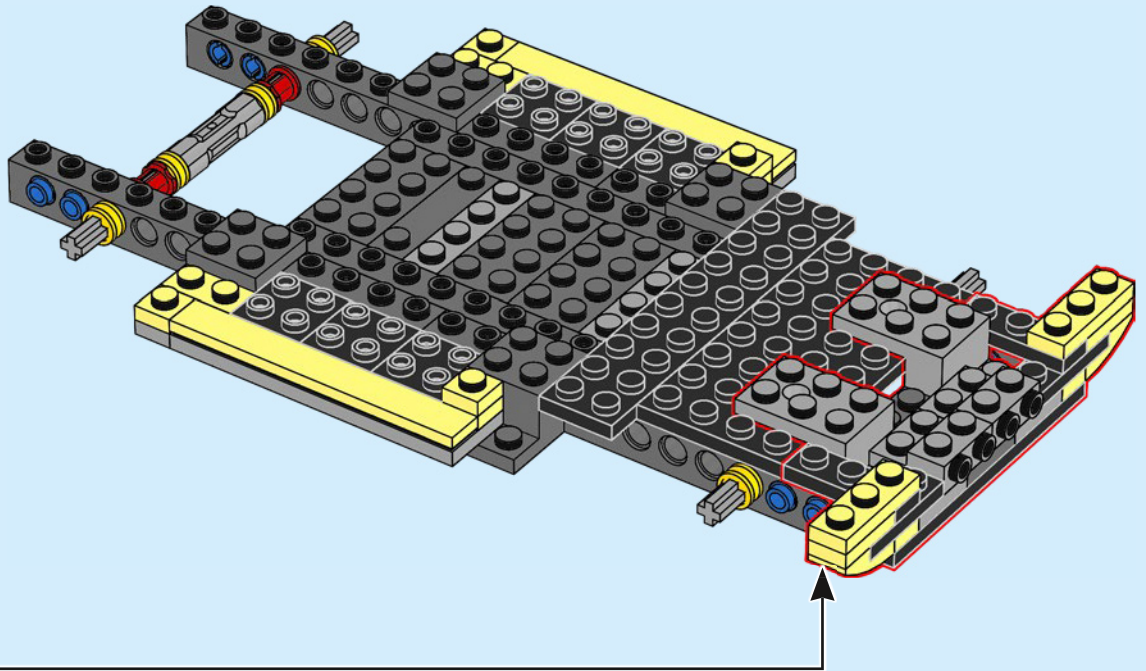

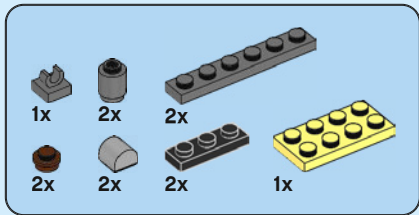

26

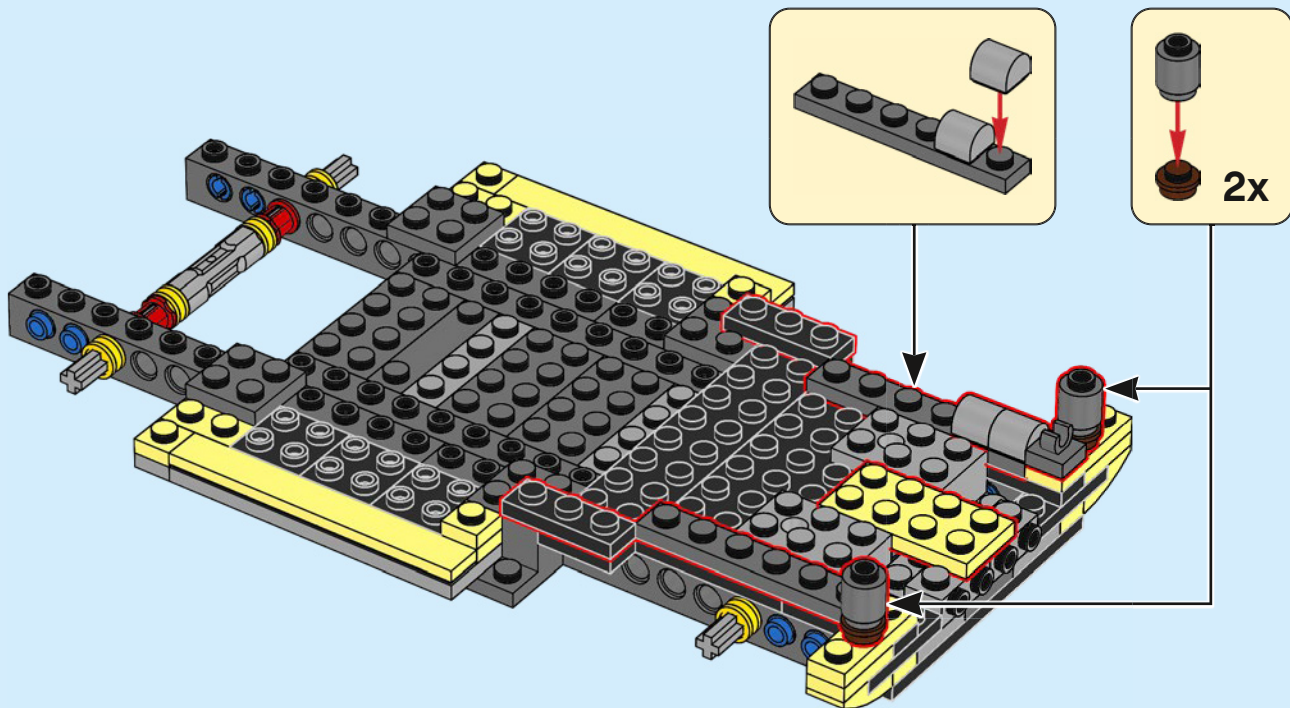

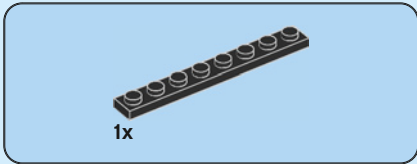
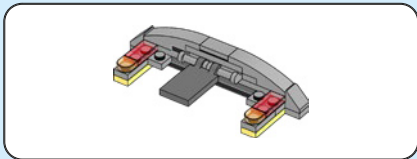

27

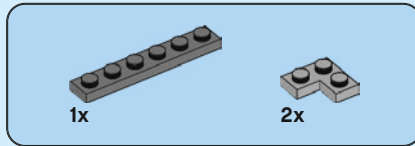
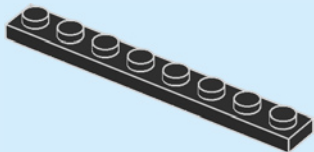

28

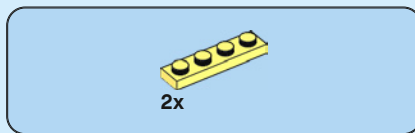
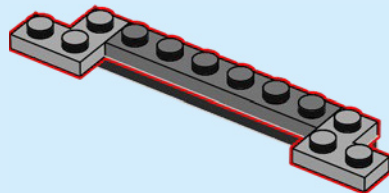

29

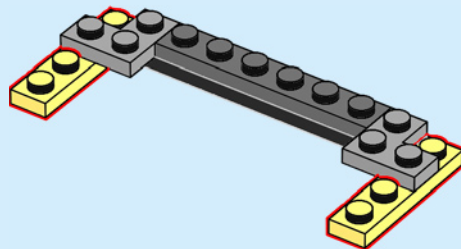

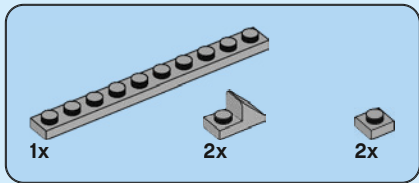

30

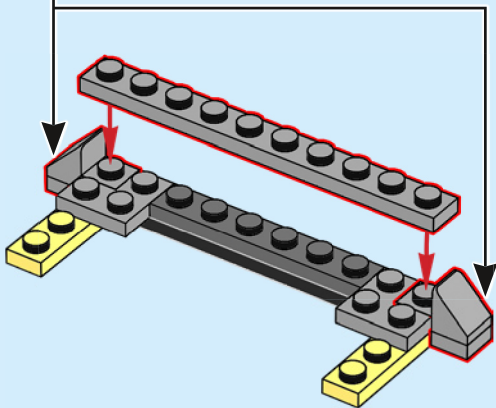
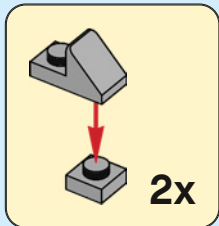

31

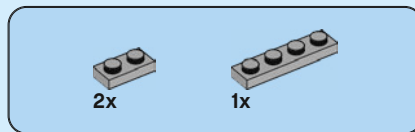
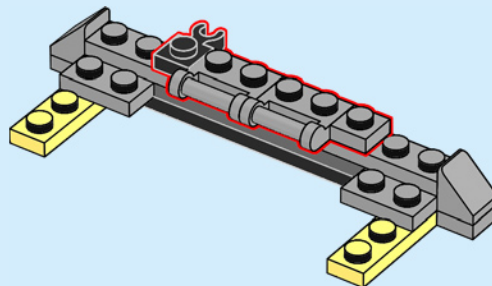

32

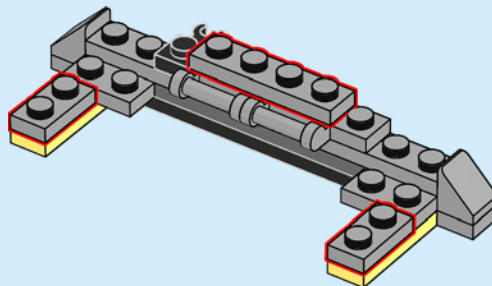

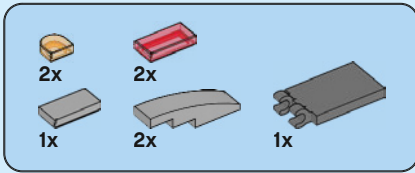

33

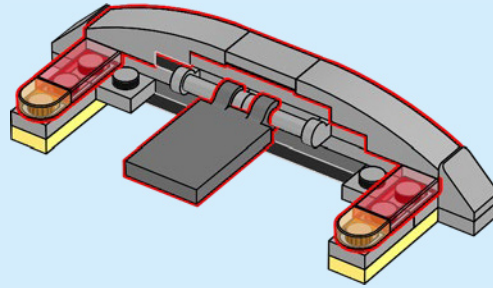

34

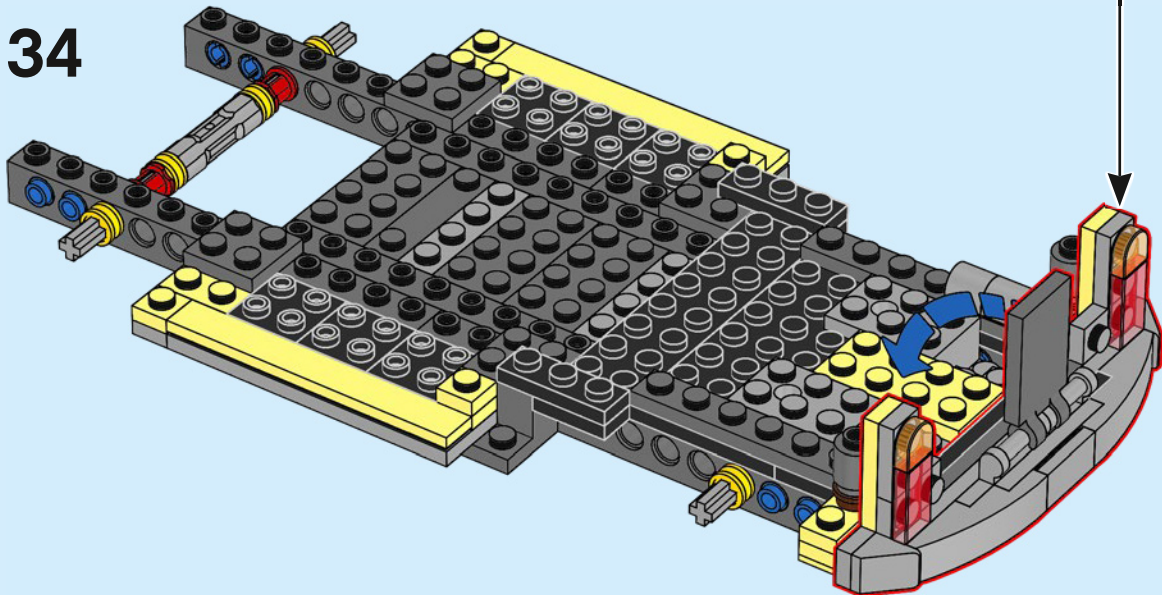

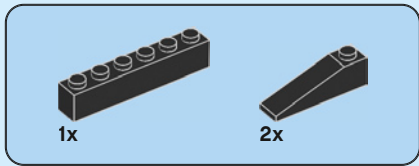

35

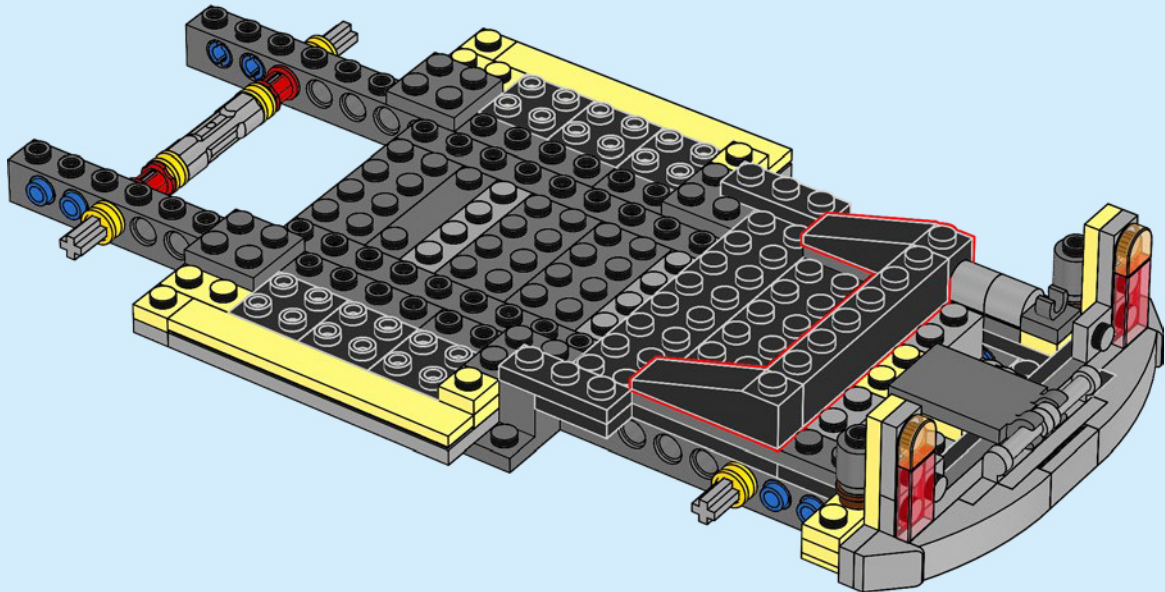

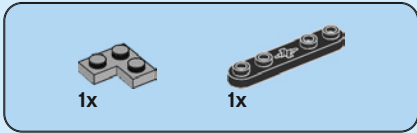

36

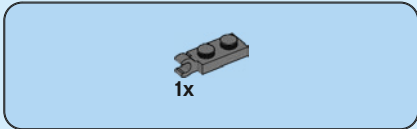
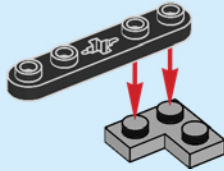

37

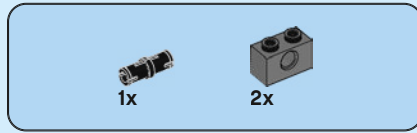
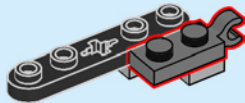

38

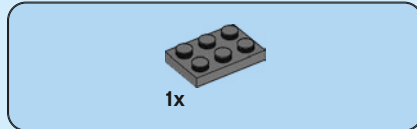
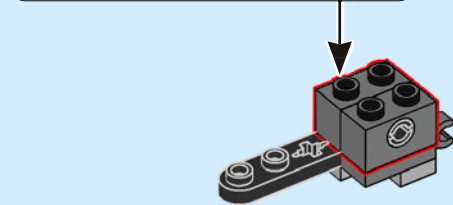
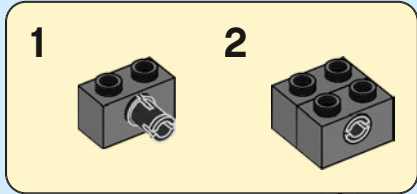

39

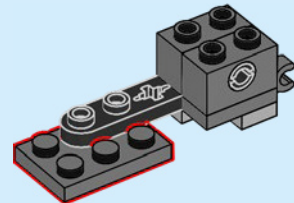



1x

40

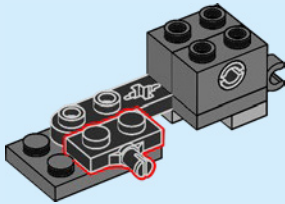

1x

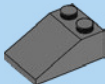

1x

41

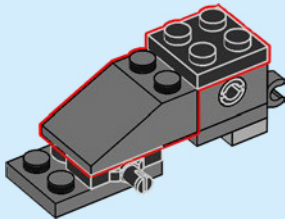

1x



1x



1x

42

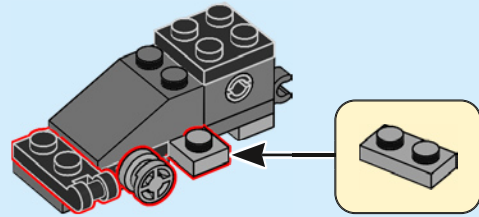

1x



1x



1x

43

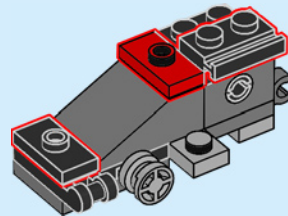





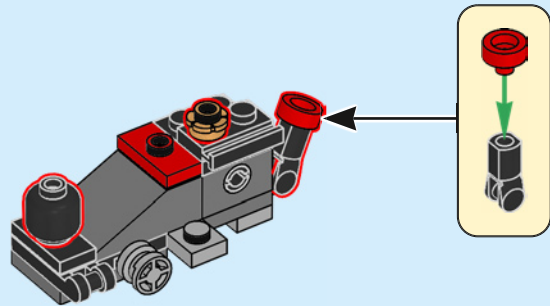

44

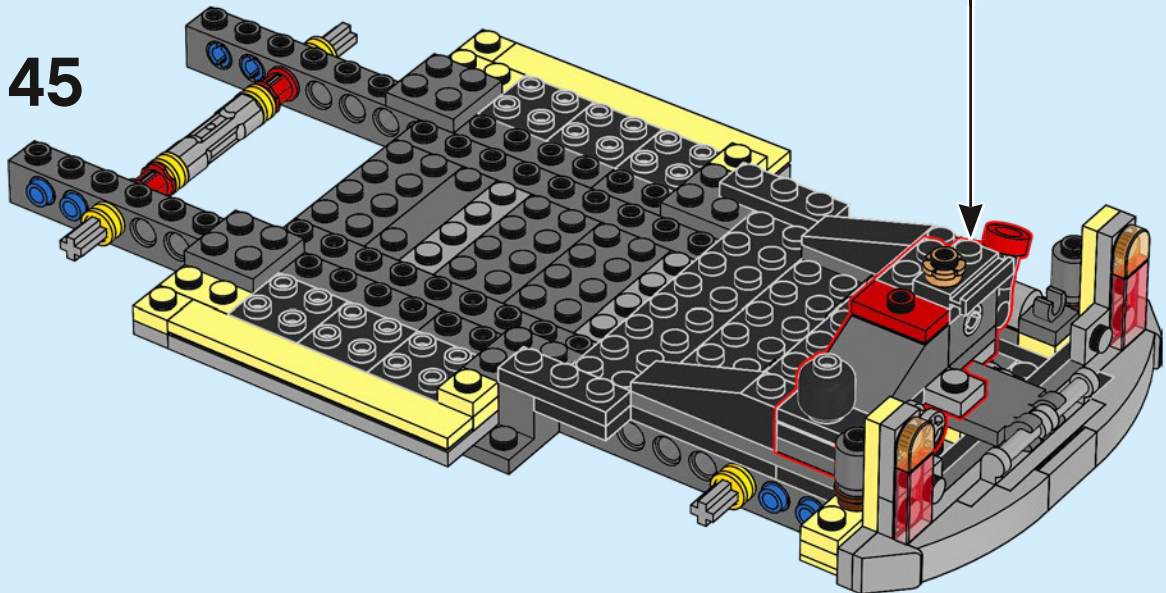

45



			
2x	2x	1x	1x

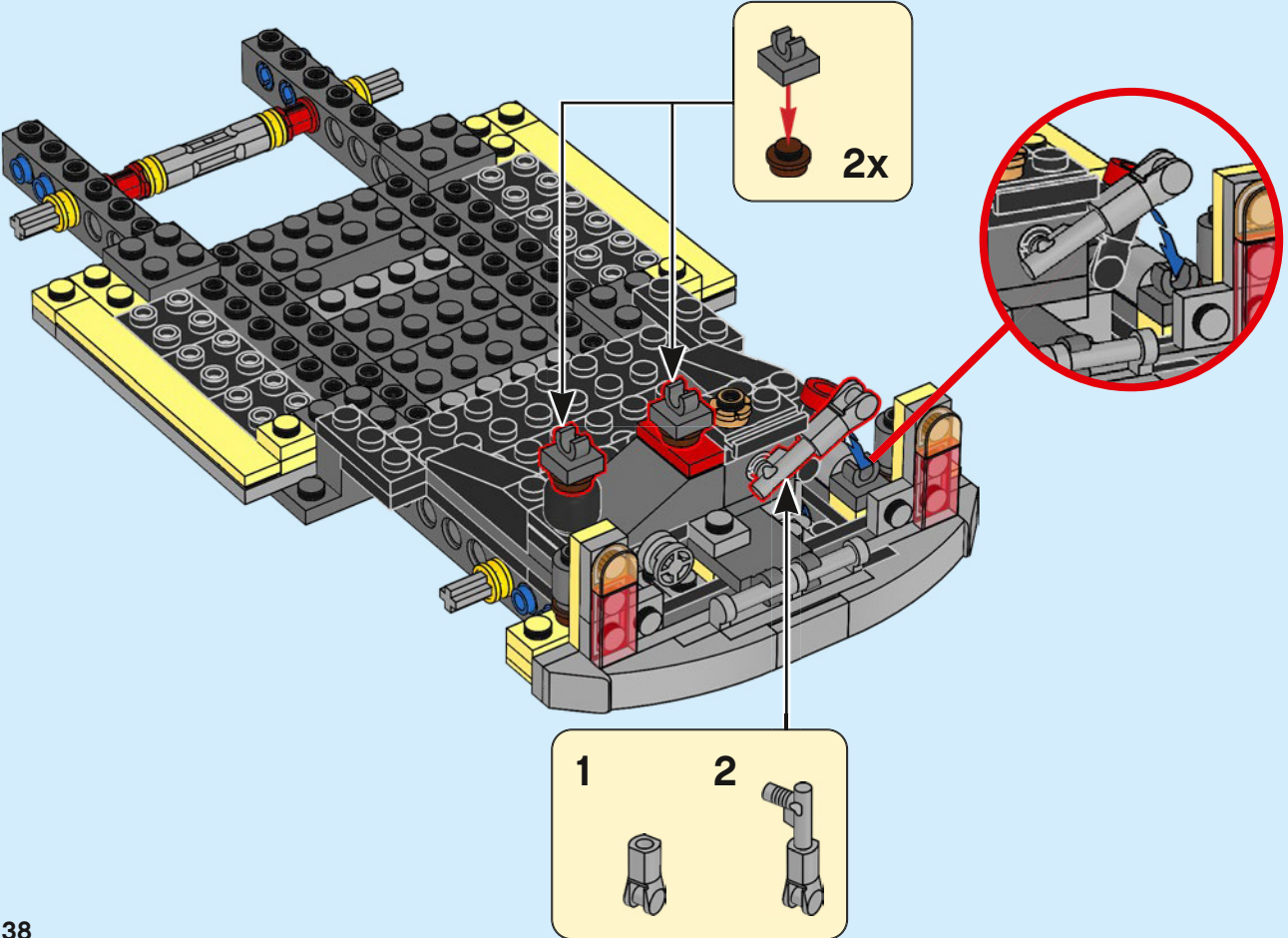

46

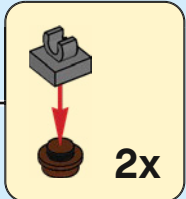

The main diagram shows a grey Technic chassis with yellow beams. A red circle highlights a specific assembly point on the right side. A red arrow points from this circle to a circular inset showing a close-up of the assembly. A blue arrow in the inset points to a grey 1x Technic brick with hole being placed on top of a brown bush. A red circle highlights the assembly point where a grey 1x Technic axle with hole is being inserted into a hole in the chassis.



2x

1	2
	

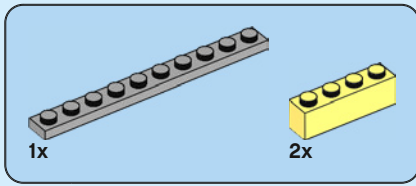

47

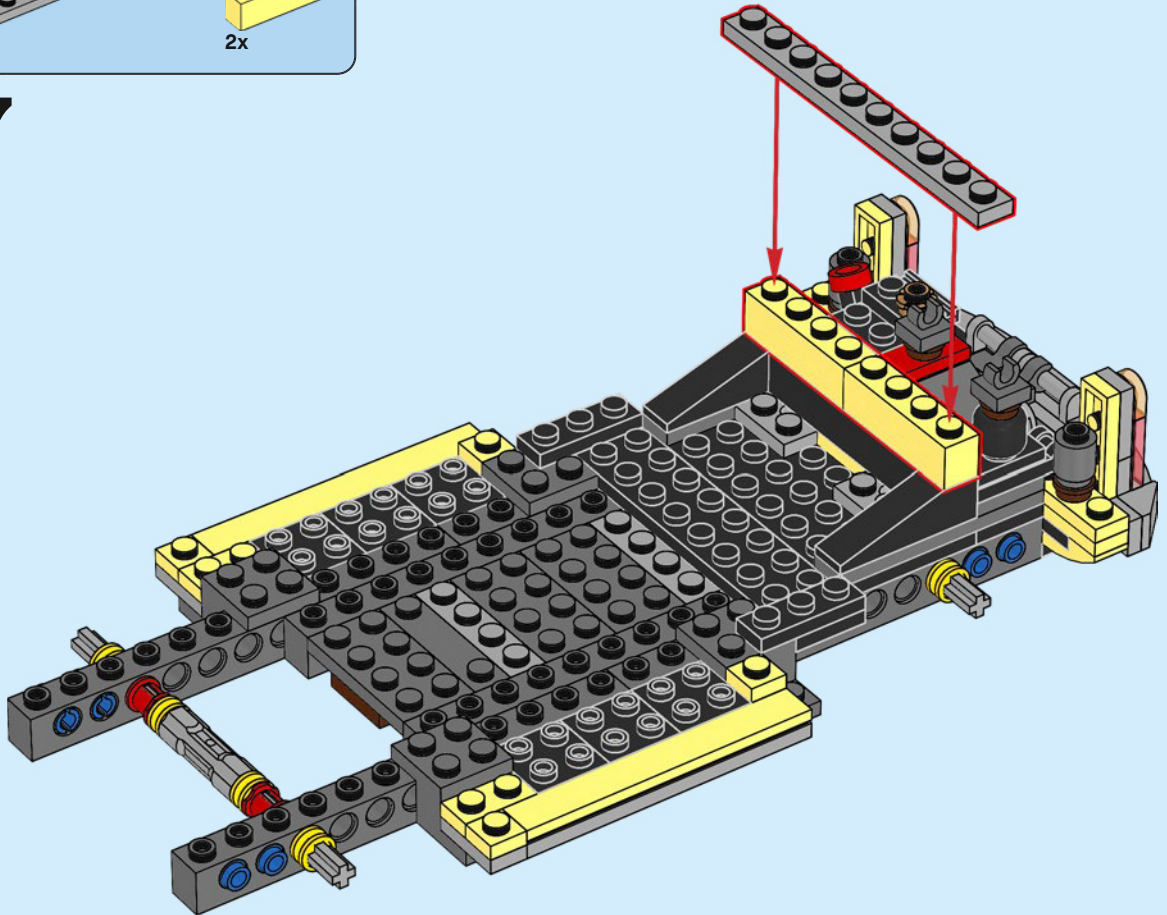

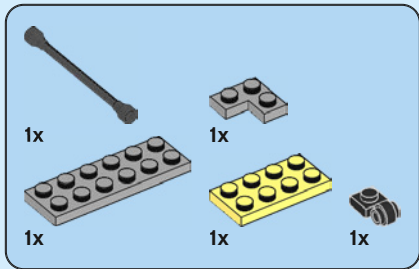

48

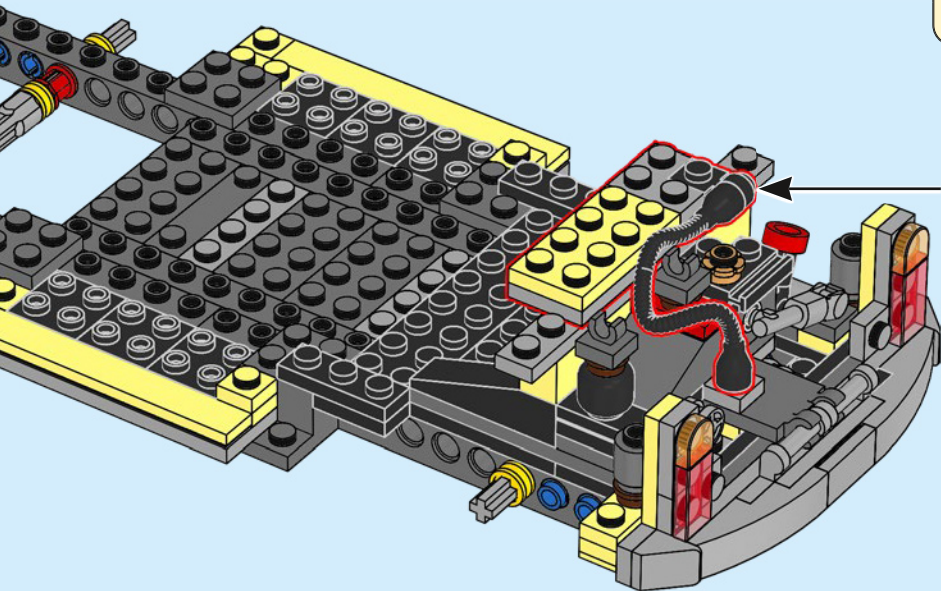
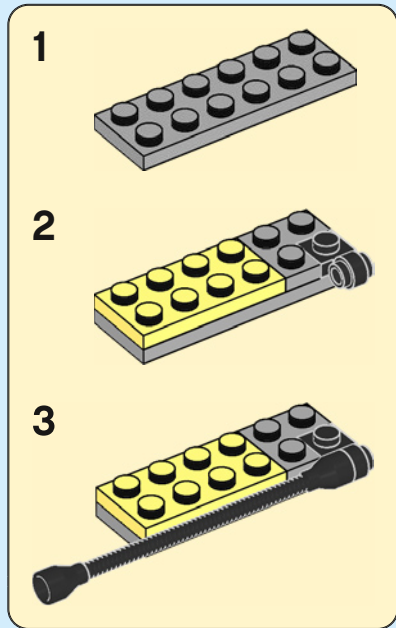

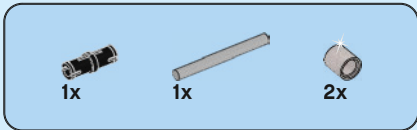

49

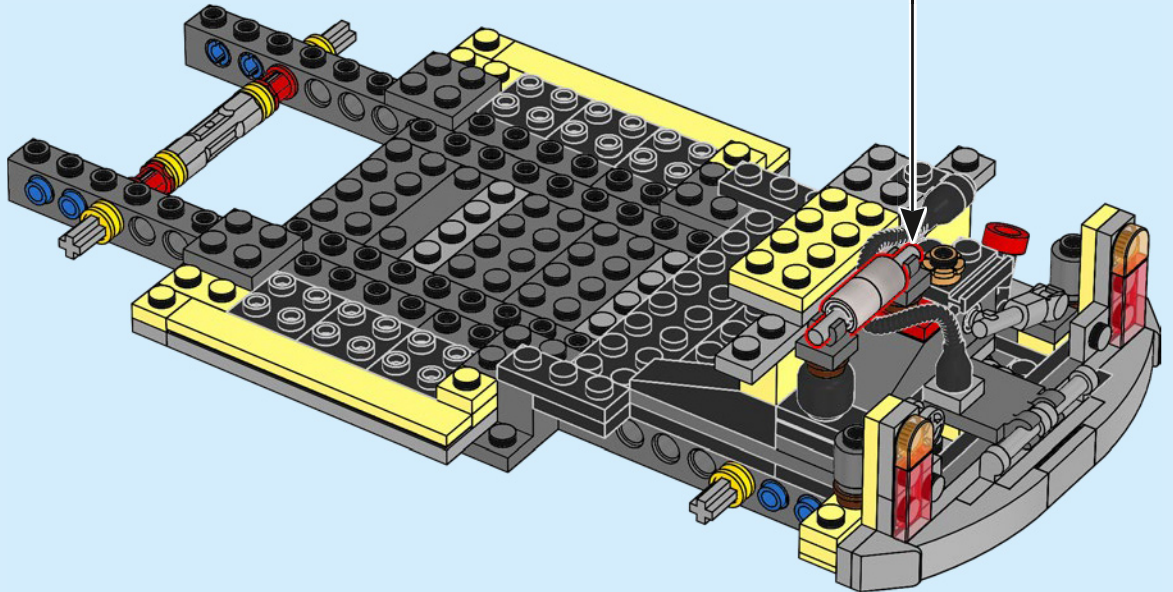

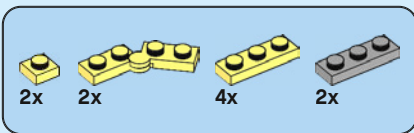

50

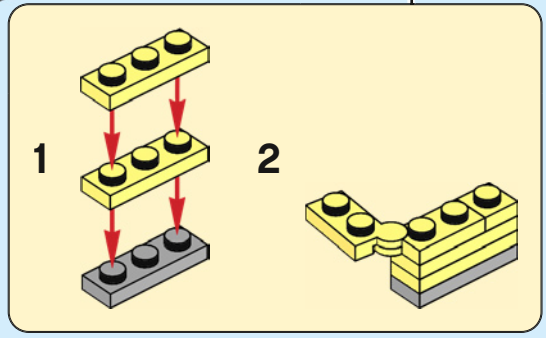
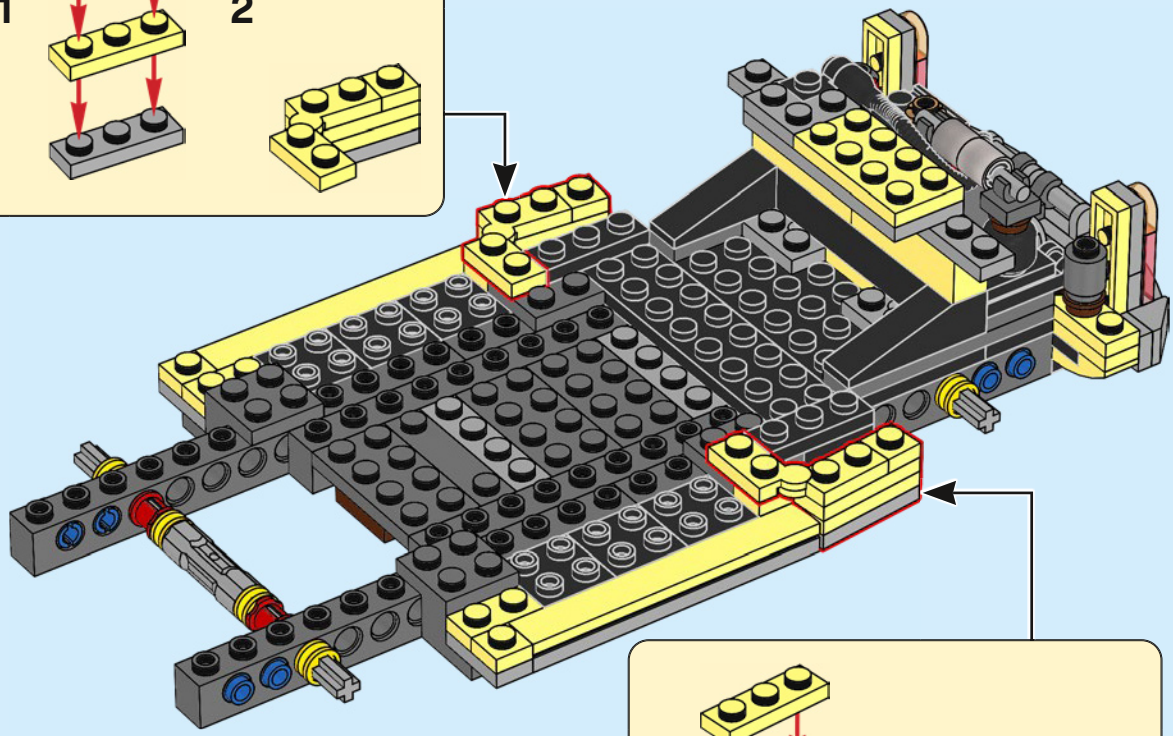
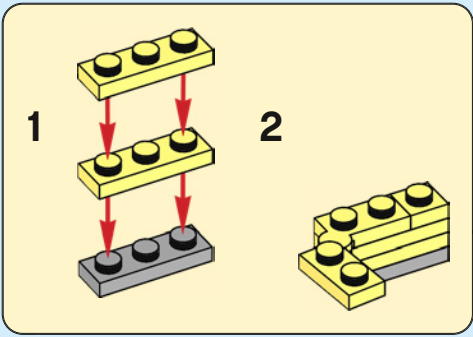

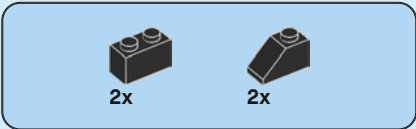

51

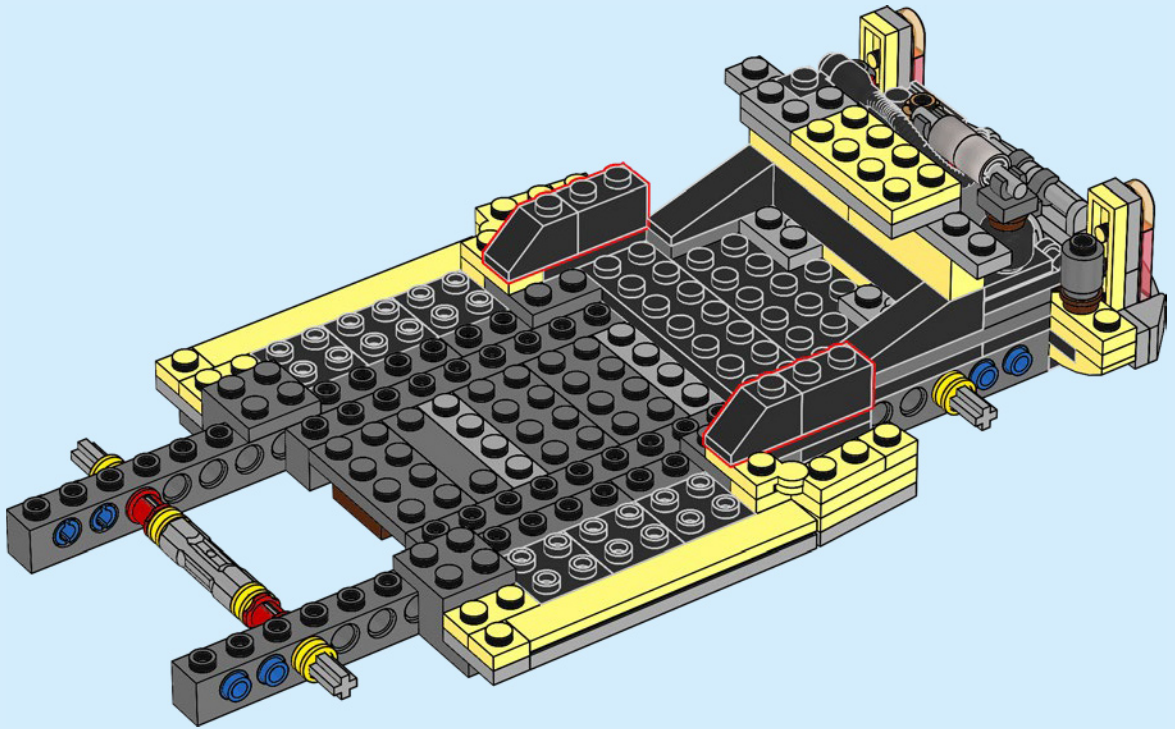

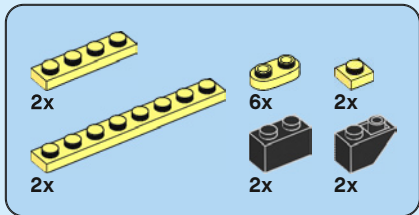

52

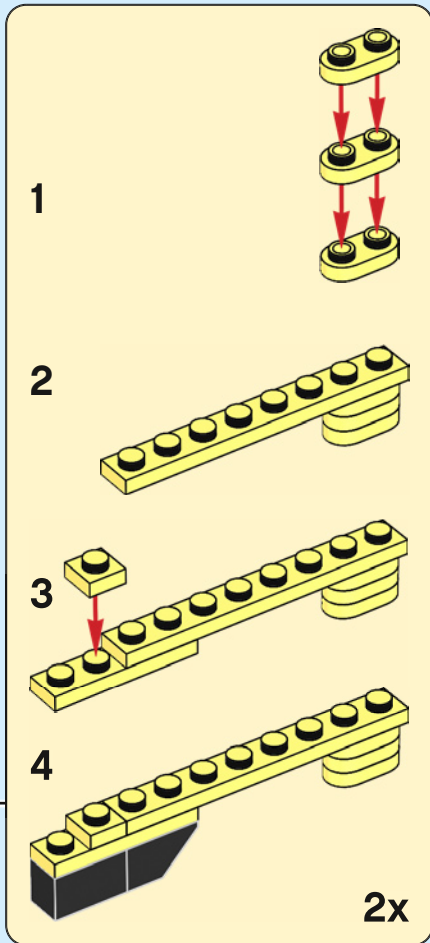
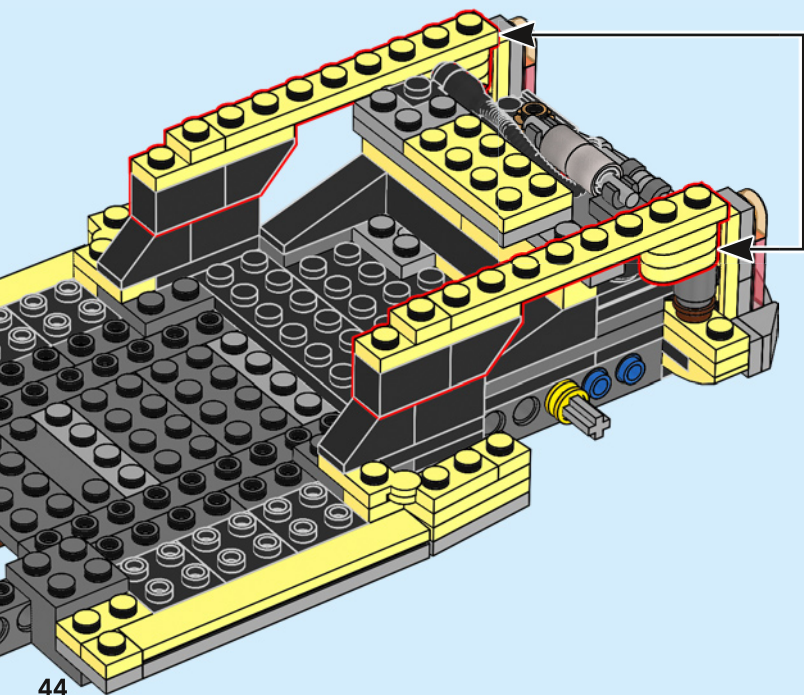



2x

53

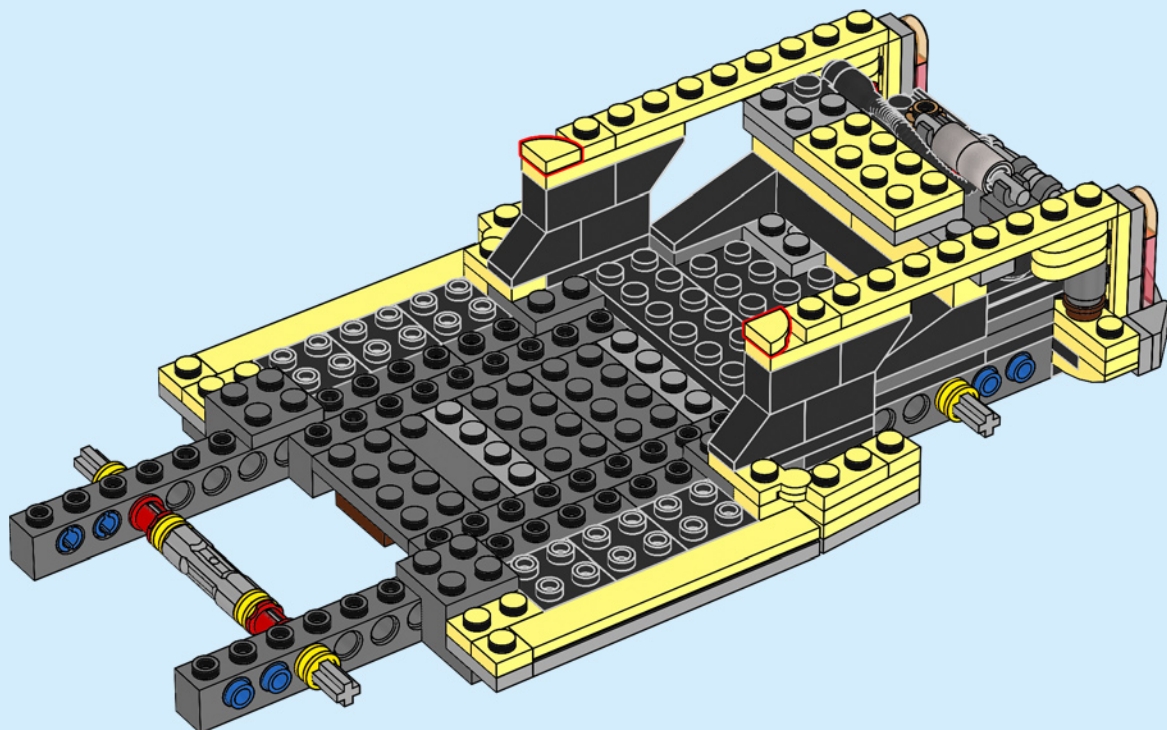

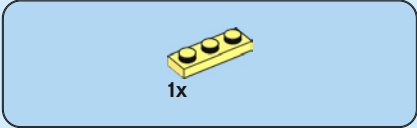
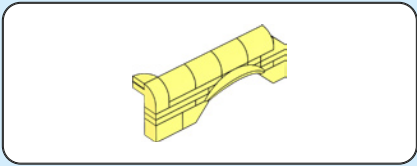

54

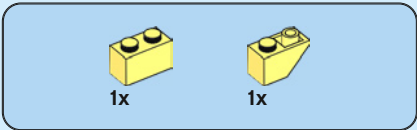
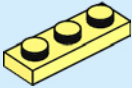

55

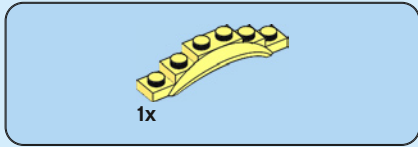
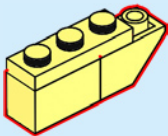

56

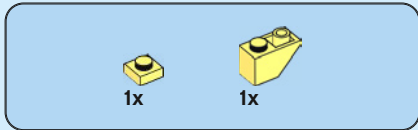
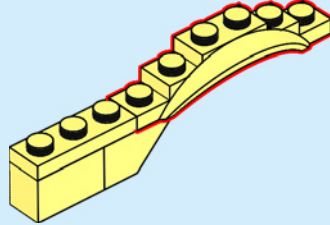

57

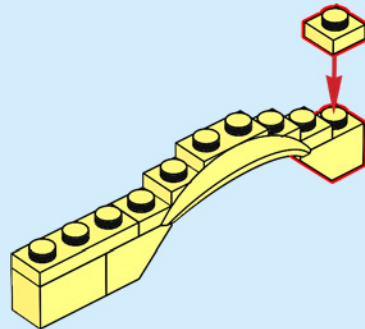

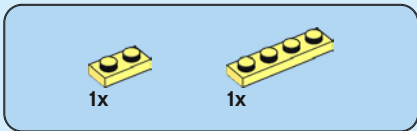

58

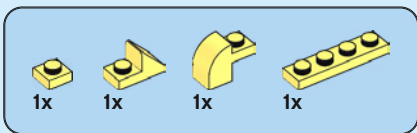
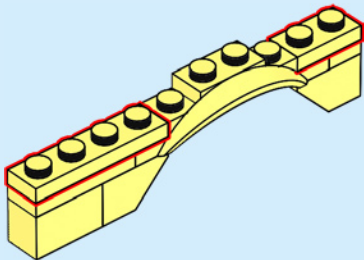

59

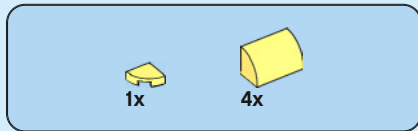
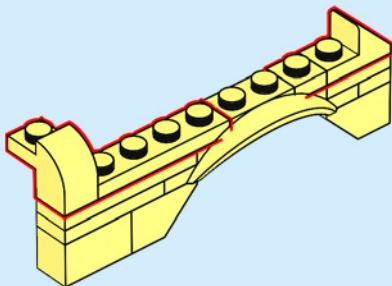

60

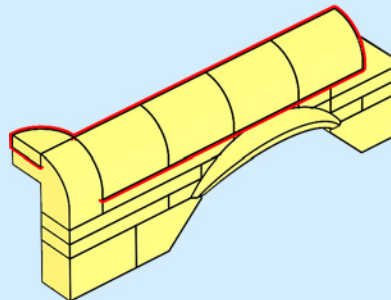

61

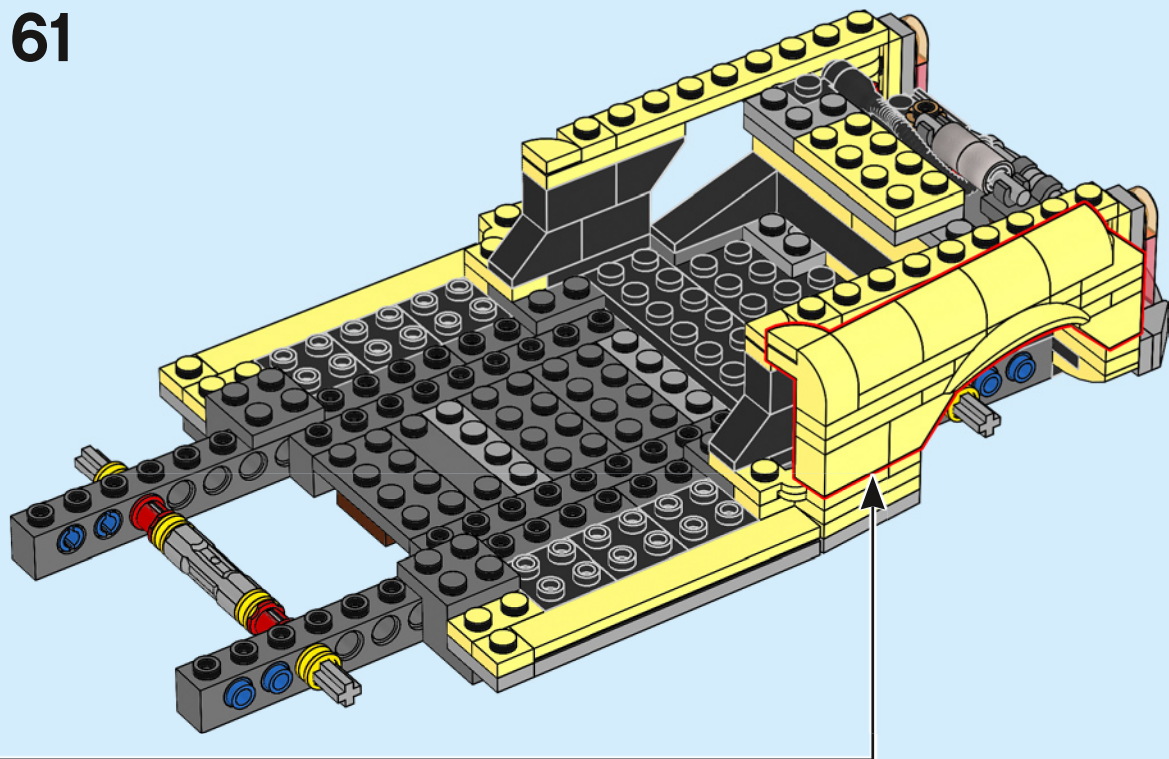

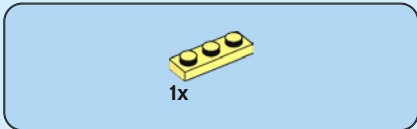
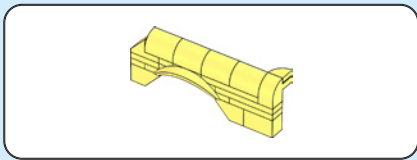

1x

62

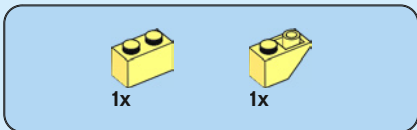
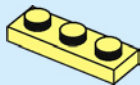

1x

1x

63

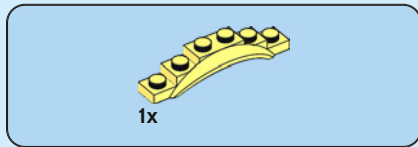
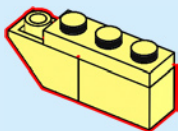

1x

64

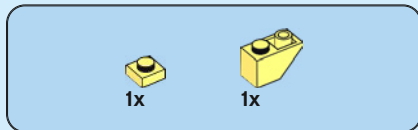
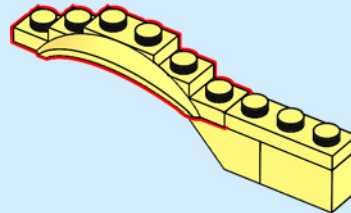

1x

1x

65

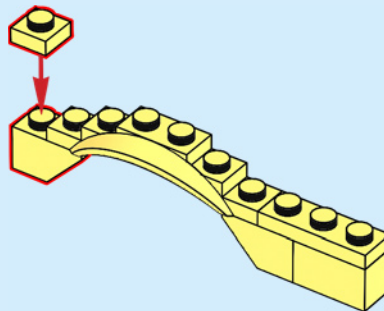

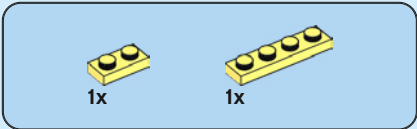

66

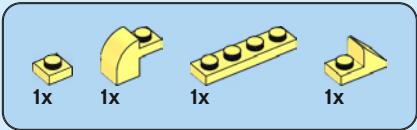
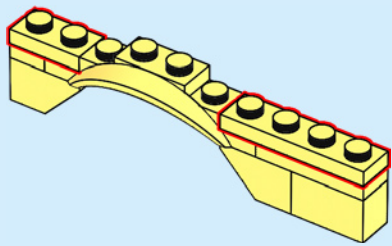

67

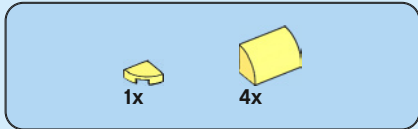
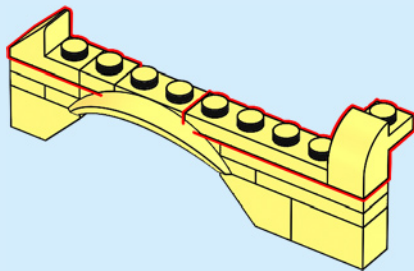

68

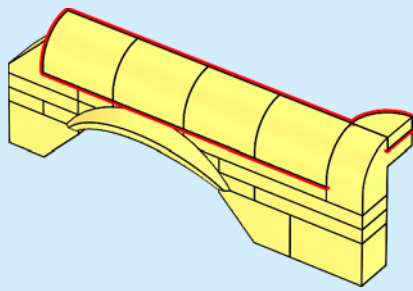

69

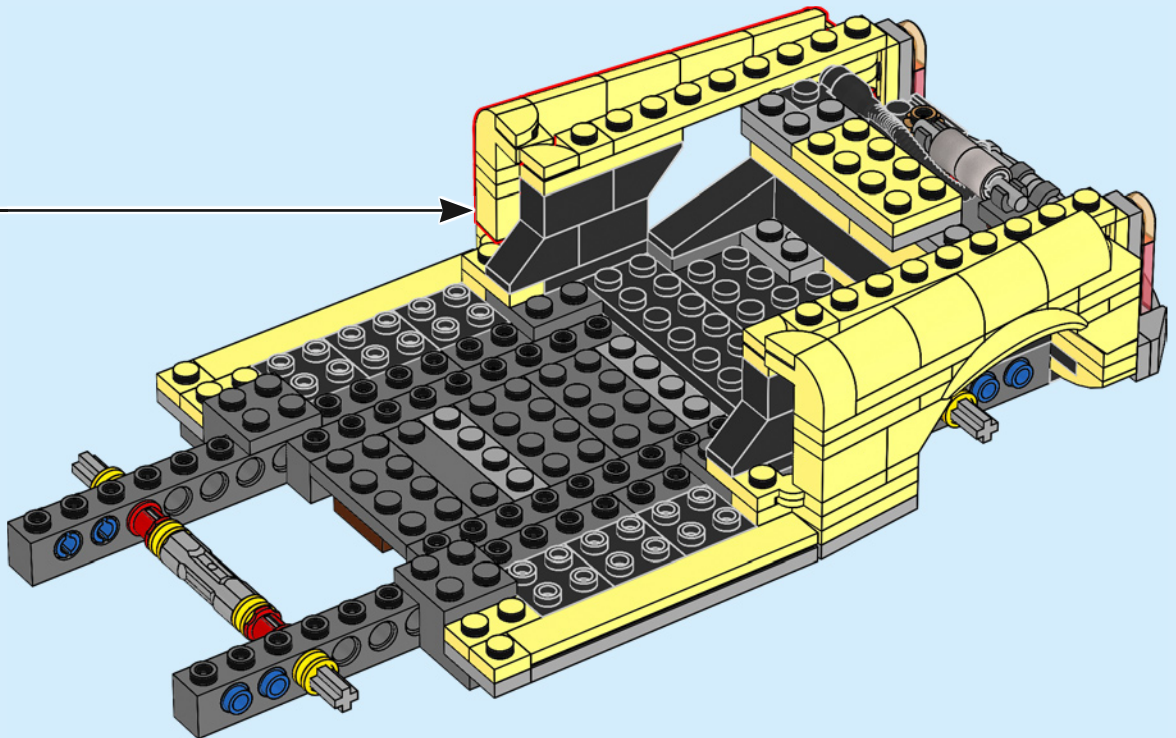

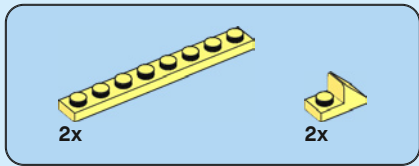

70

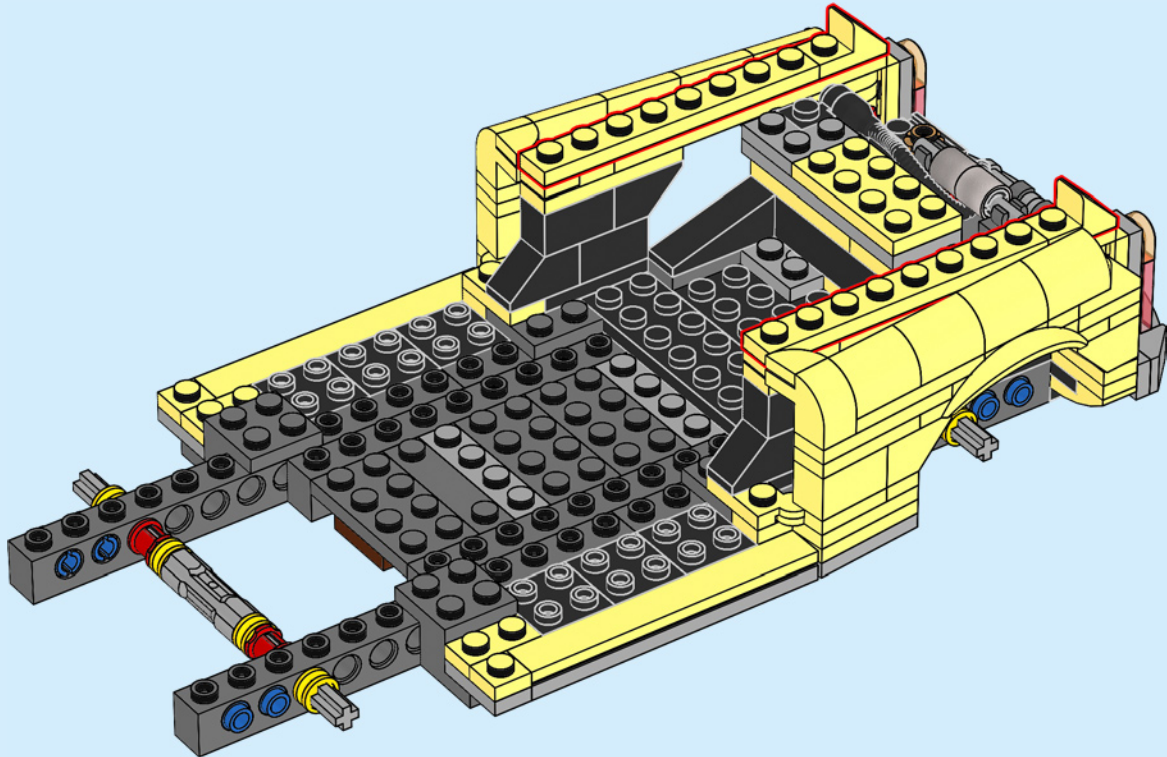

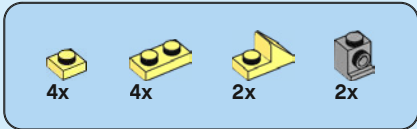

71

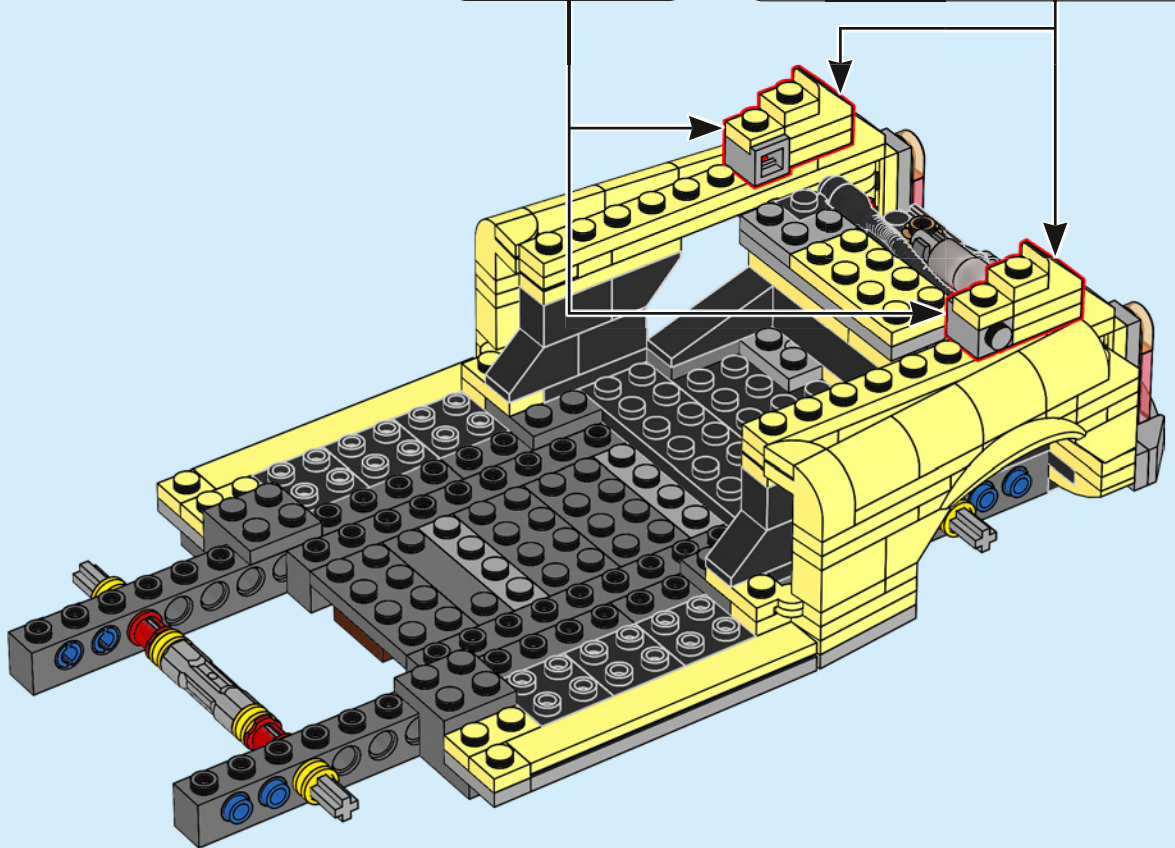
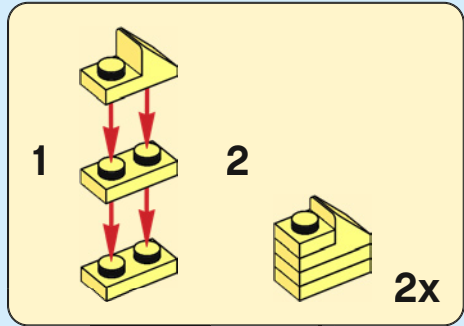
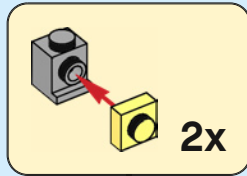

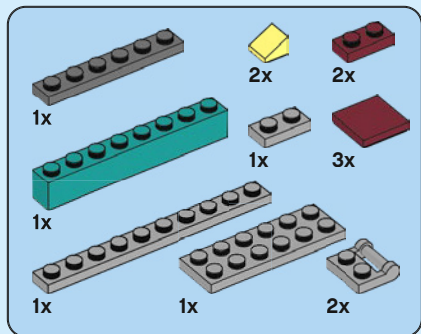

72

1

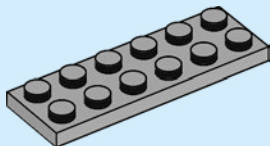

2

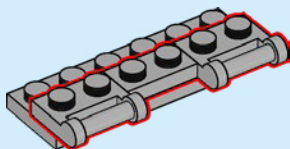

3

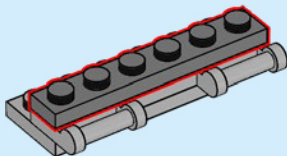

4

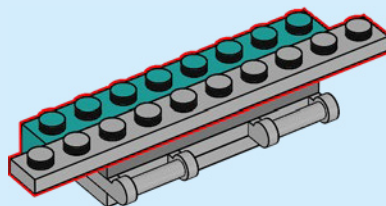



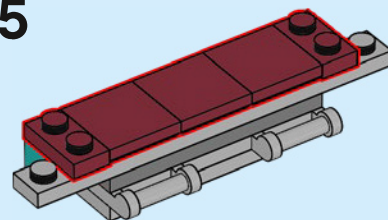

5

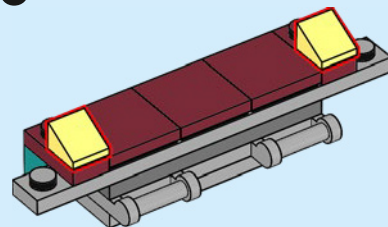

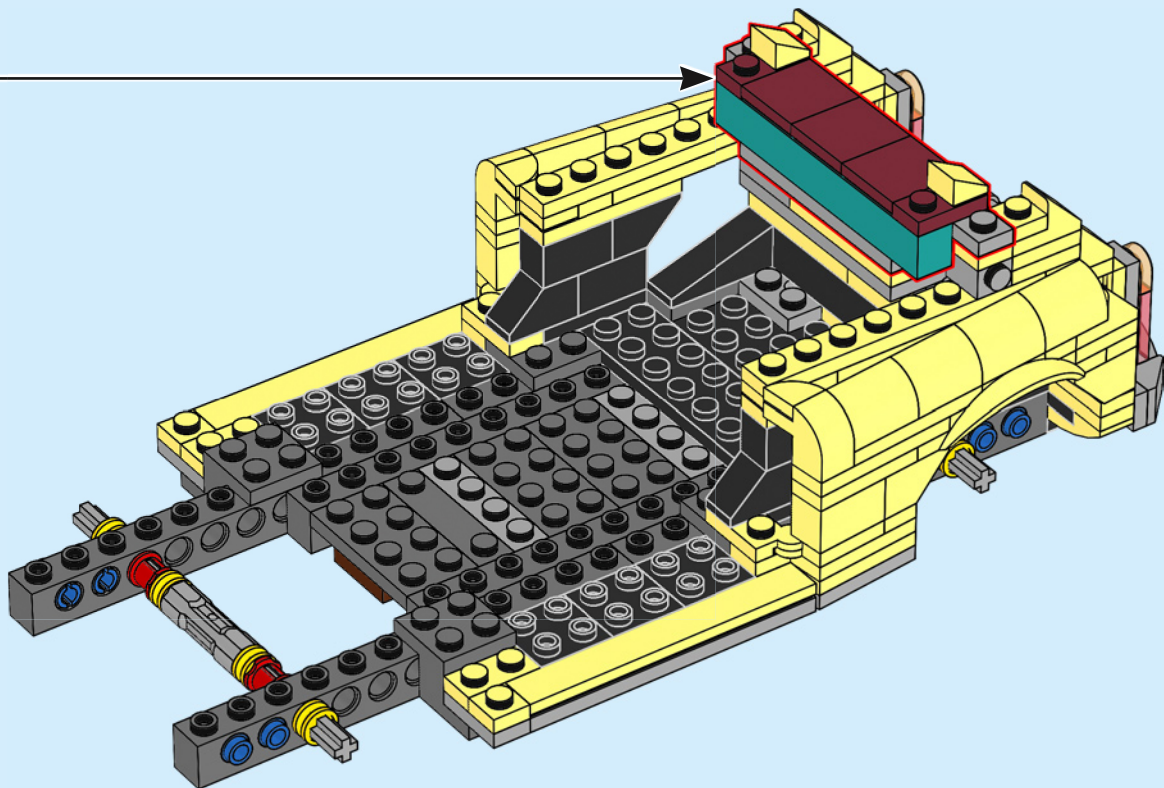
6





			
4x	4x	7x	2x

73

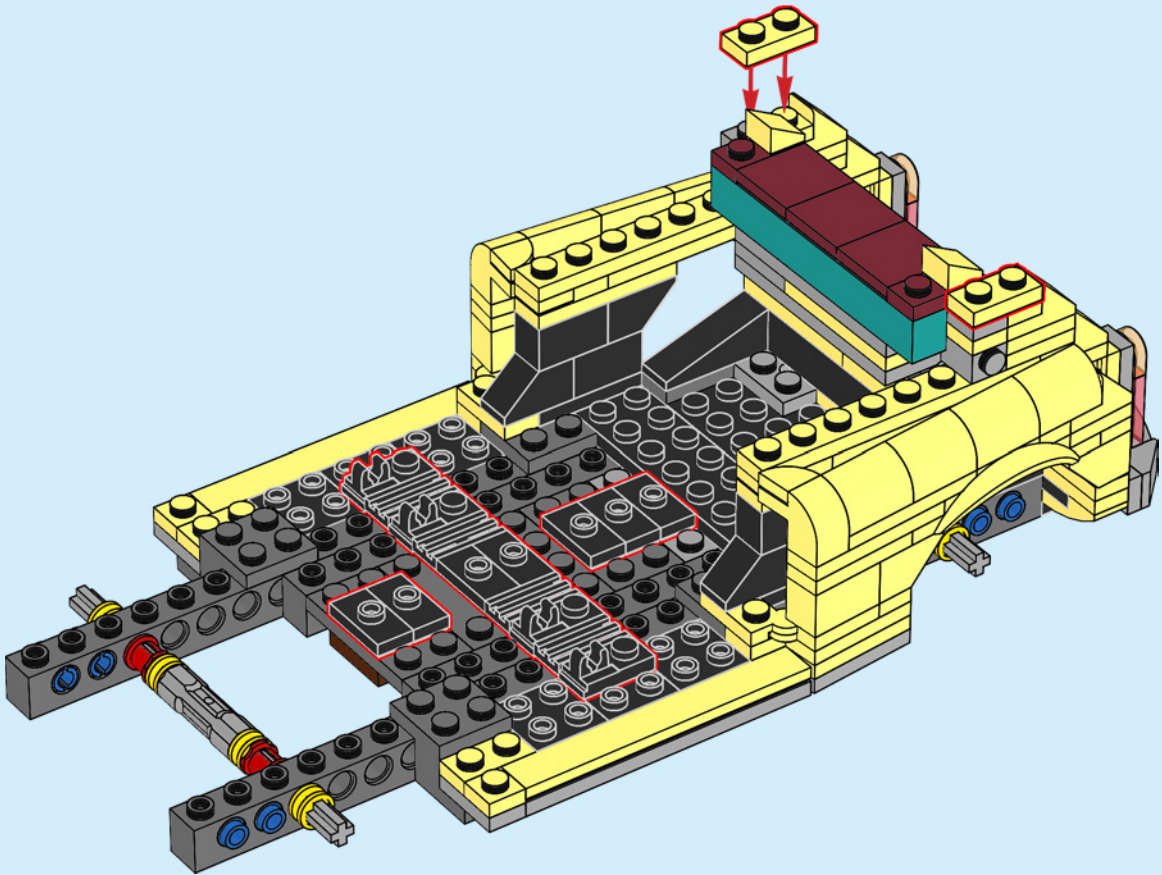

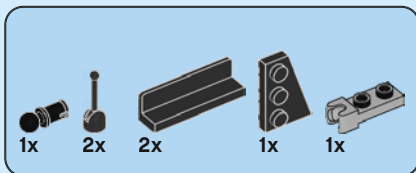

74

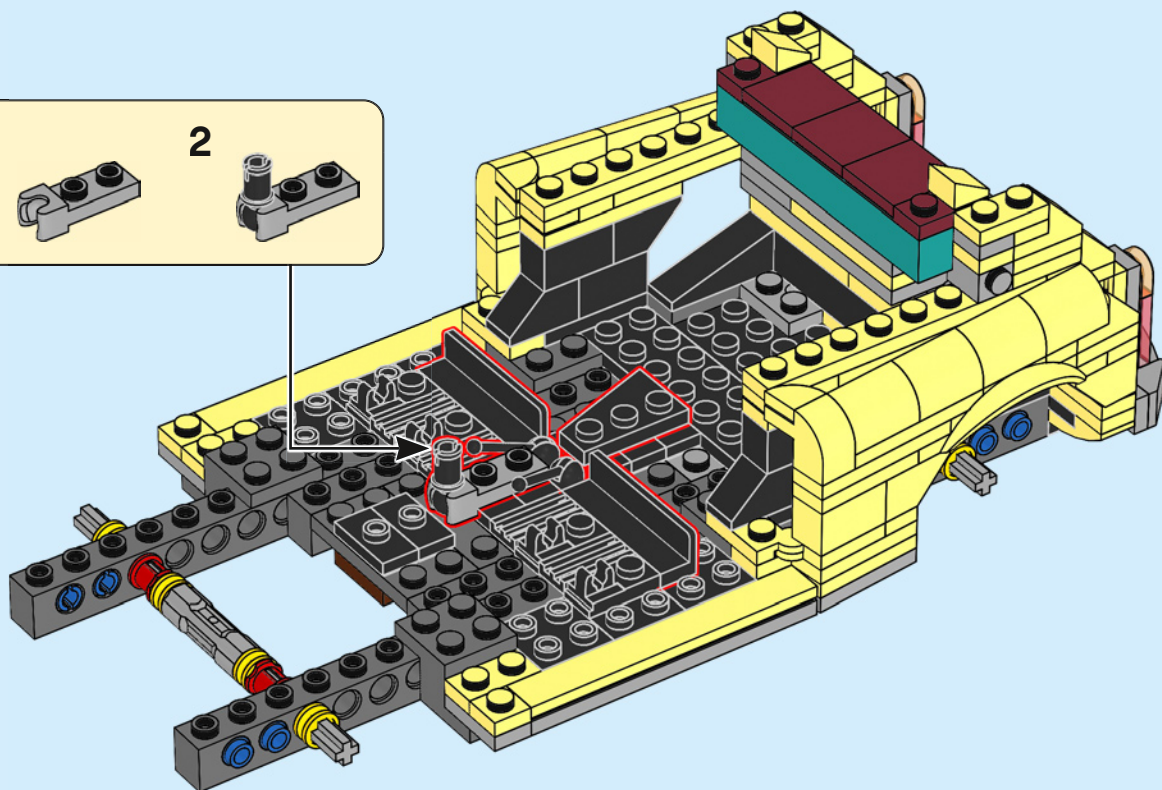
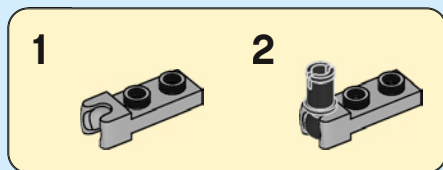

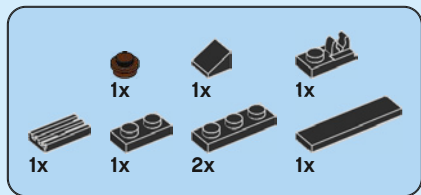

75

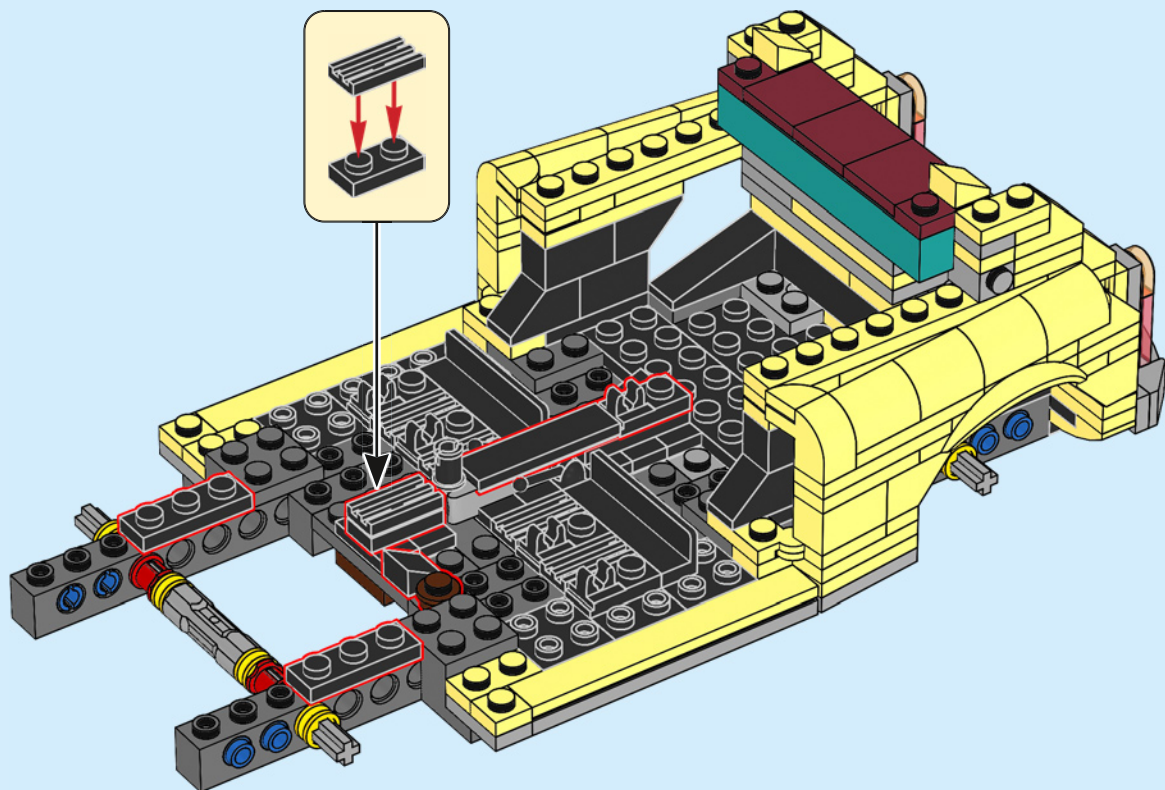



76

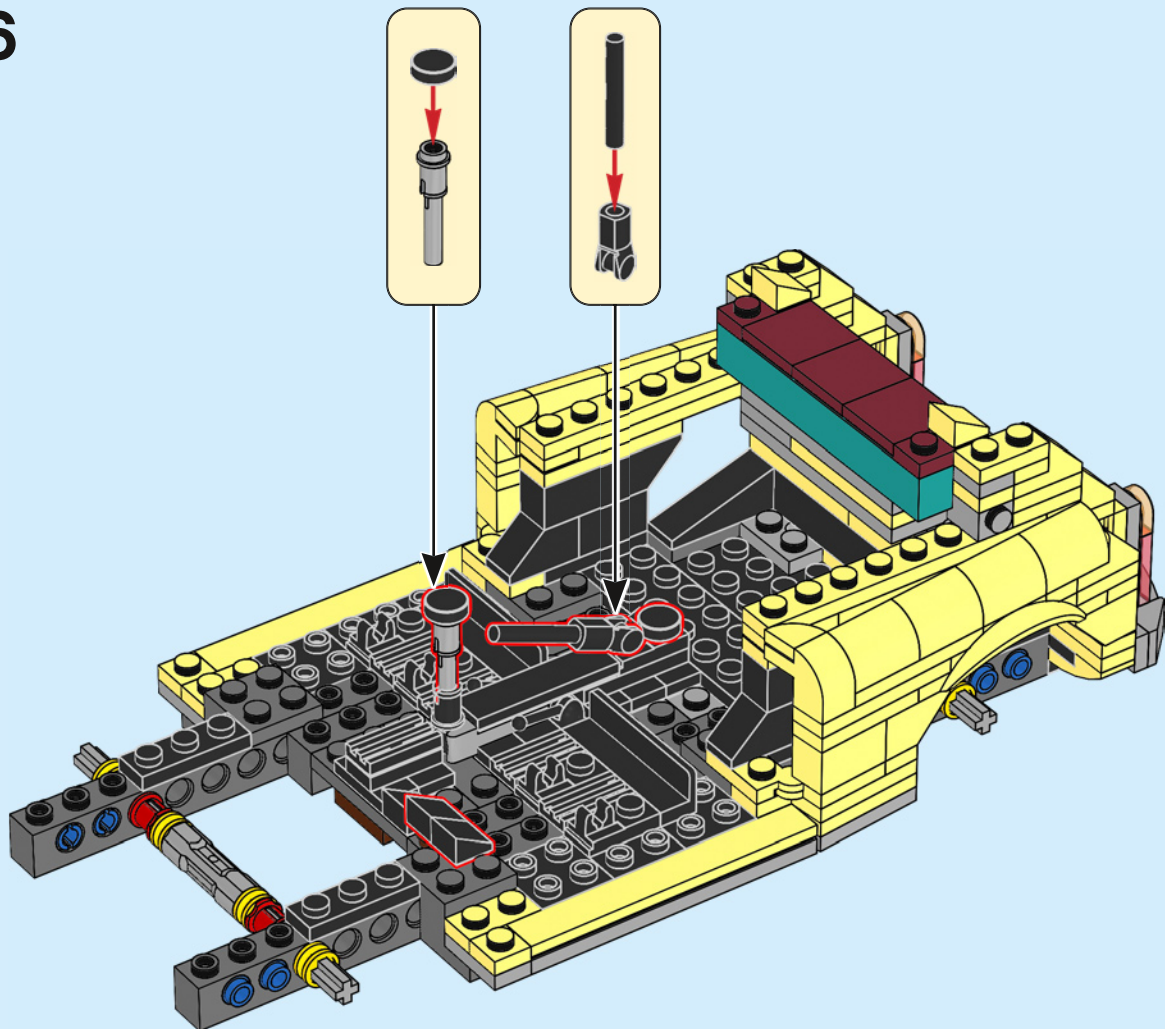

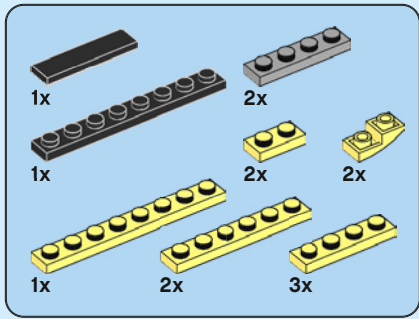

77

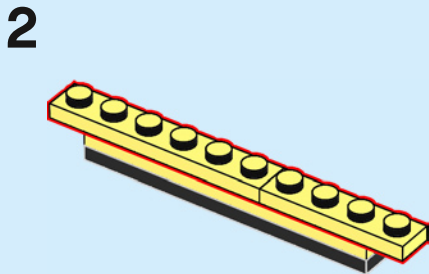
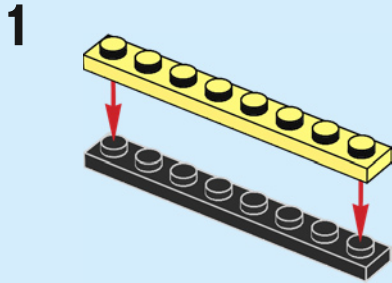

3

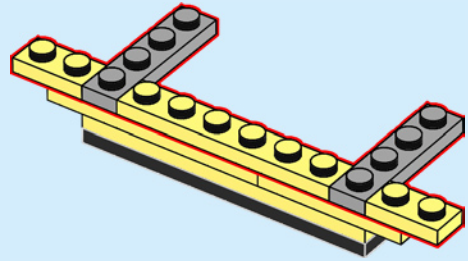

4

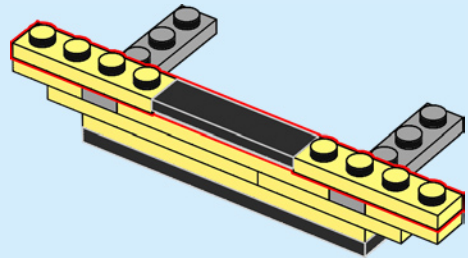

5

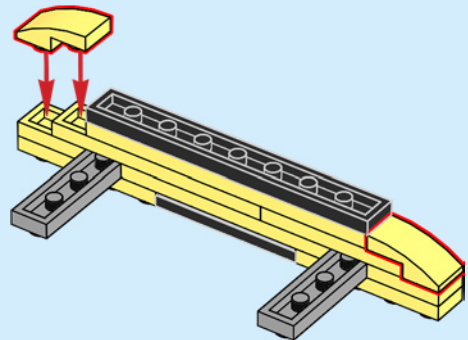
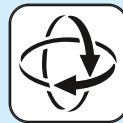

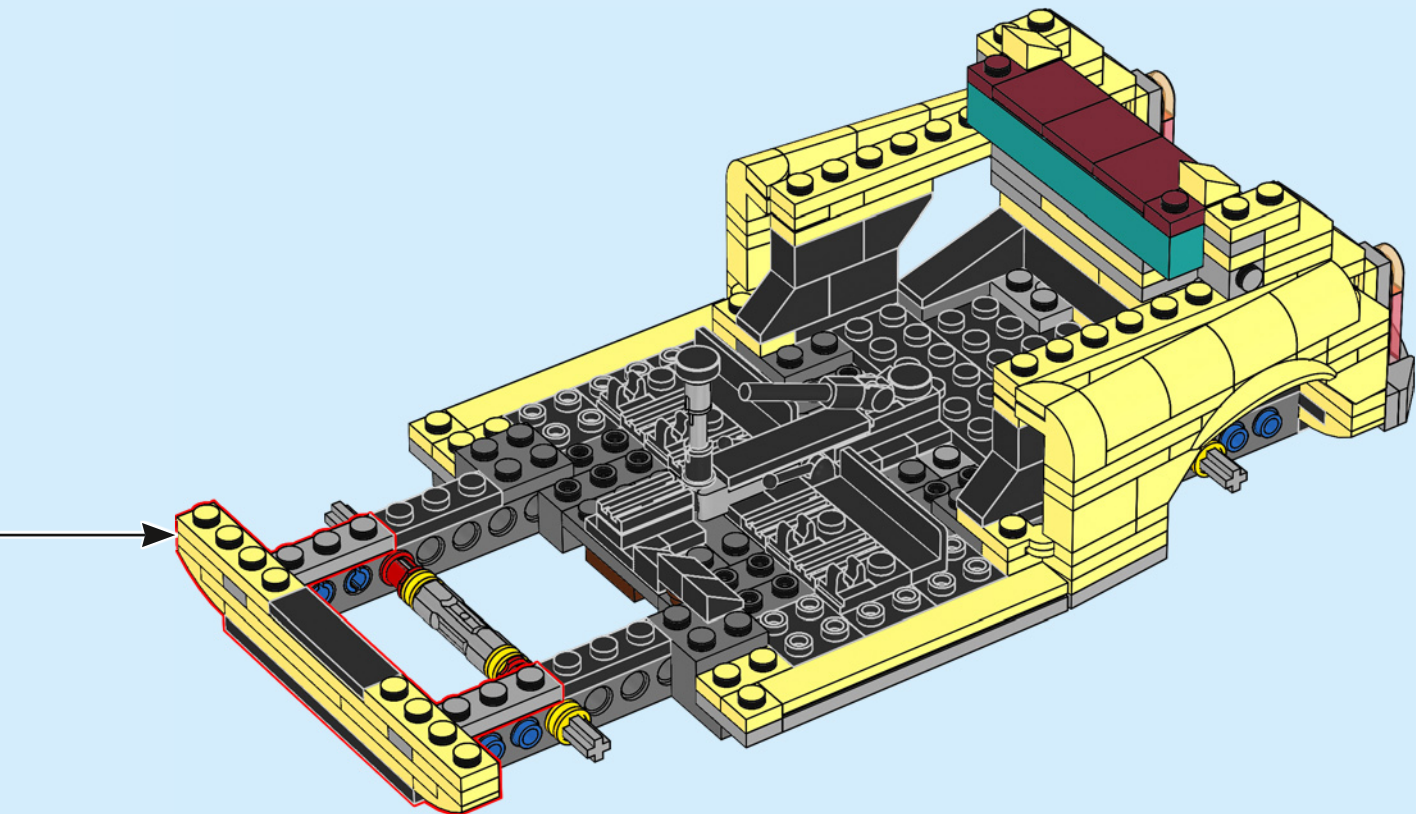

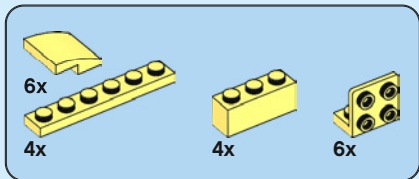
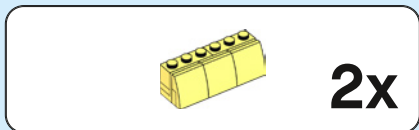
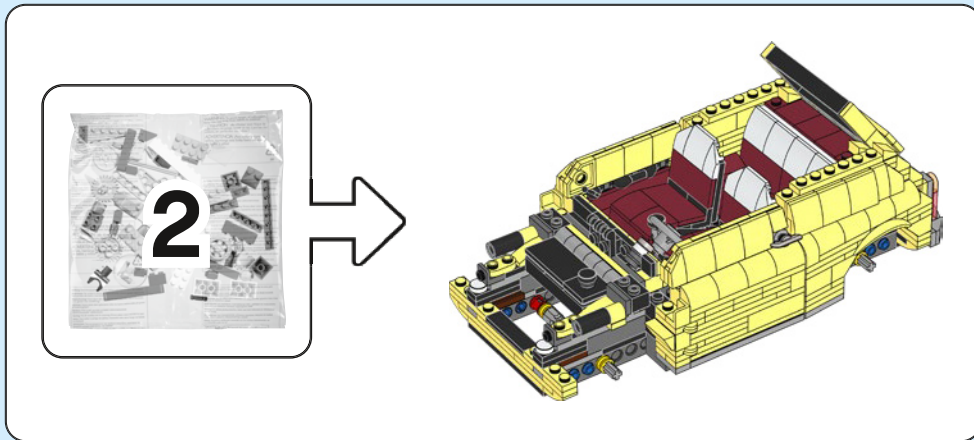

78

1

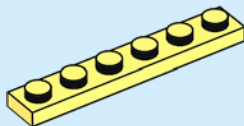

2

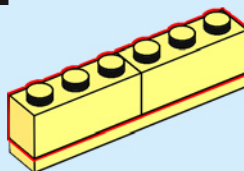

3

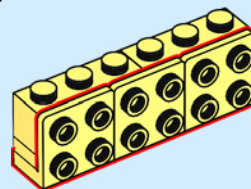

4

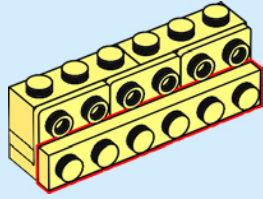

5

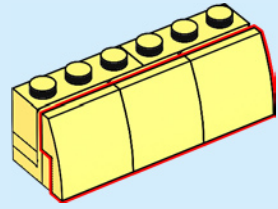

2x

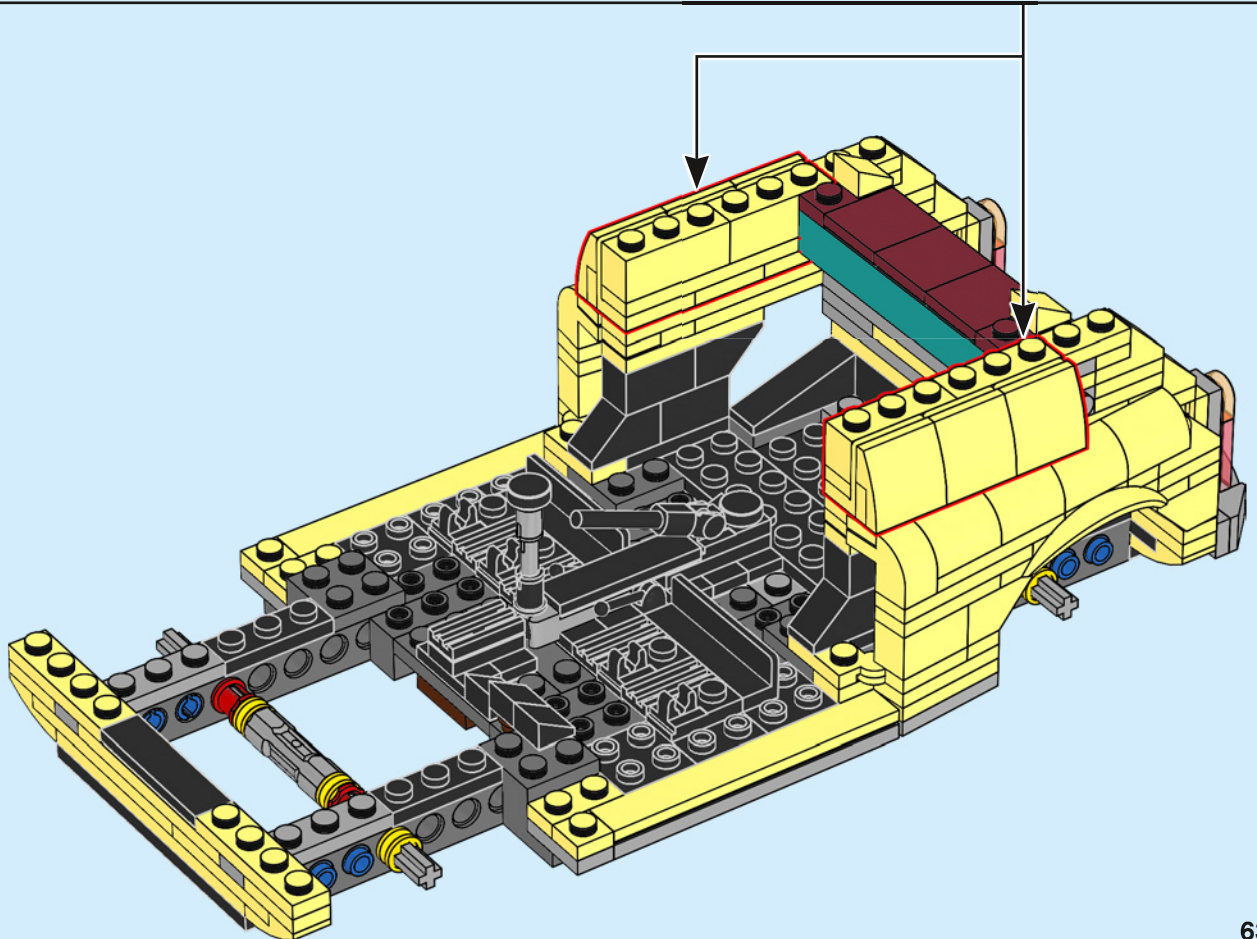

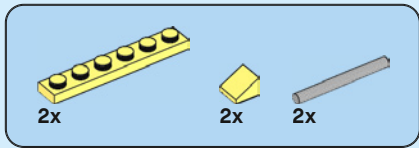

79

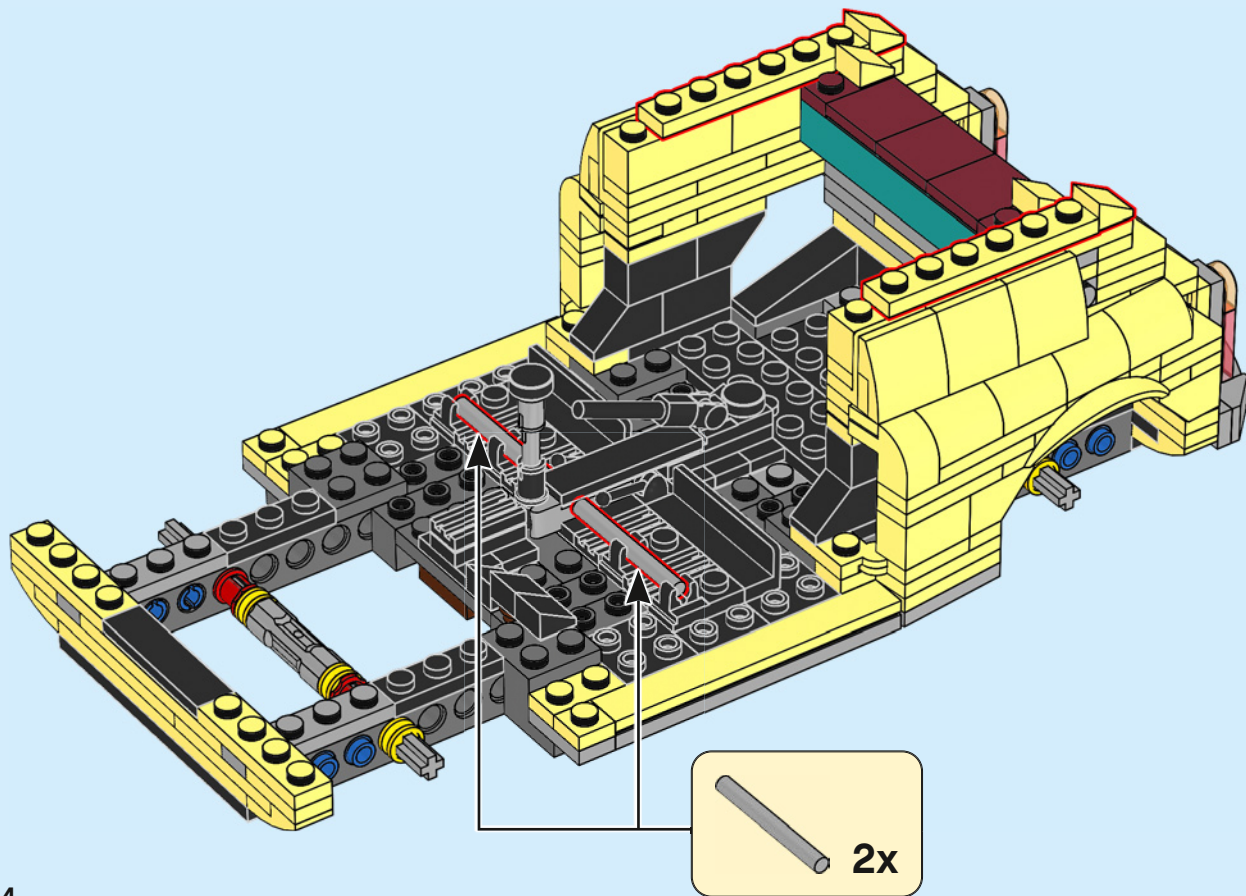

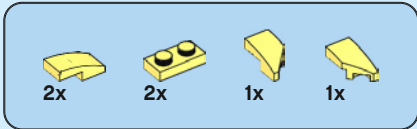

80

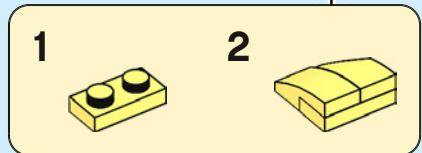
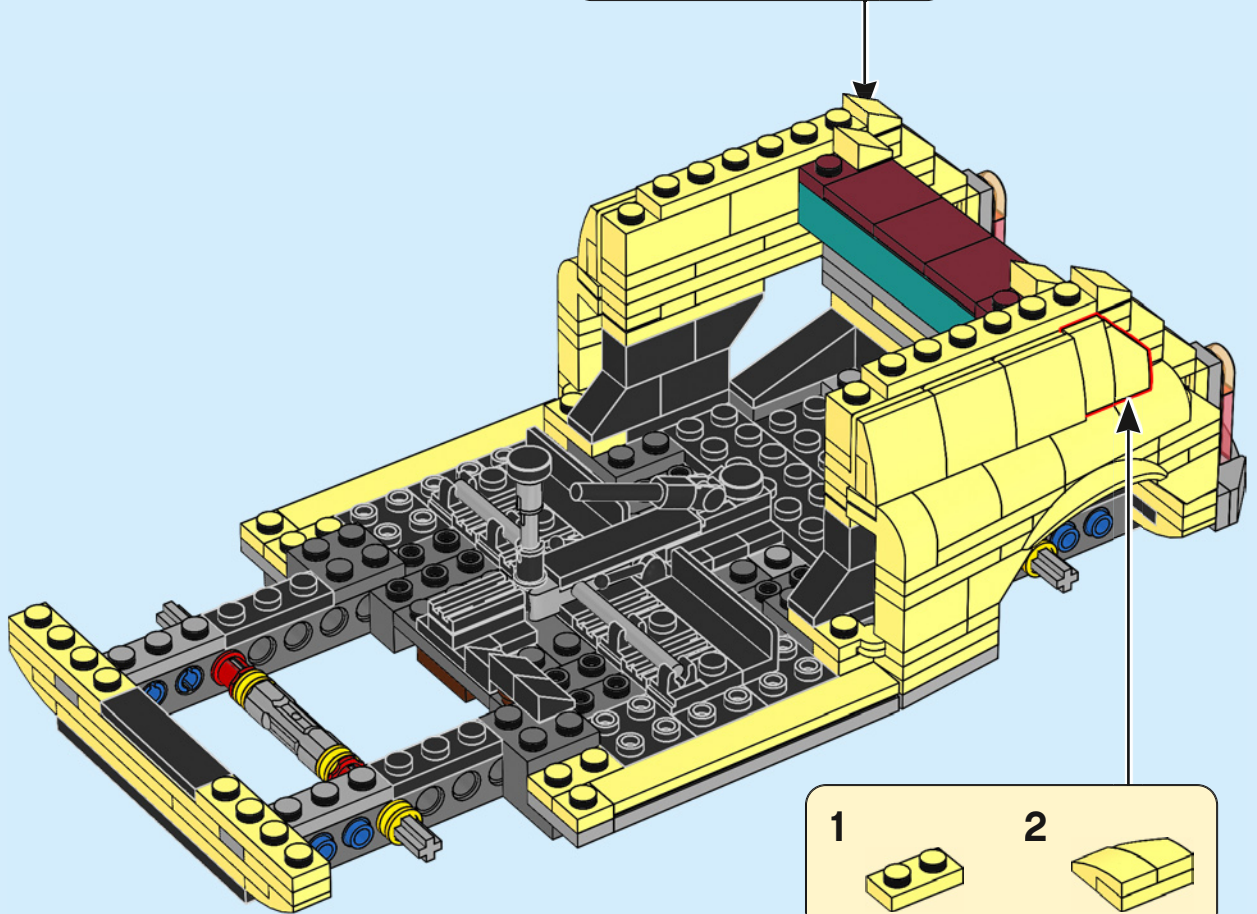
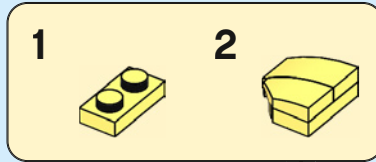

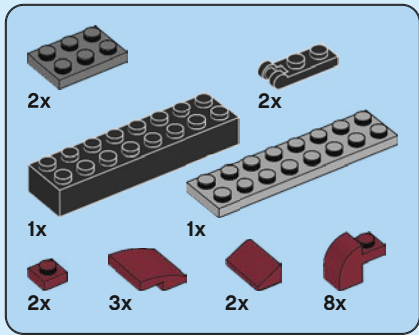

81

1

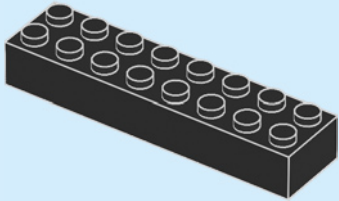

2

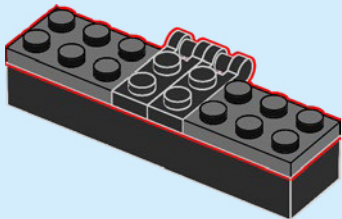

3

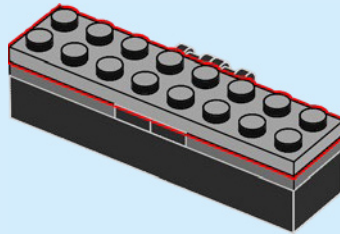

4

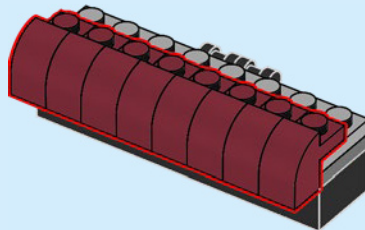

5

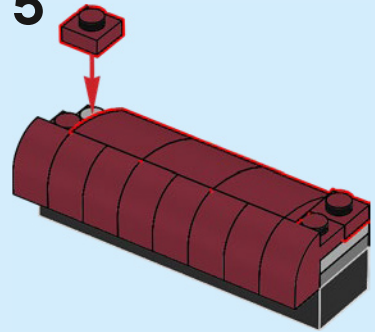

6

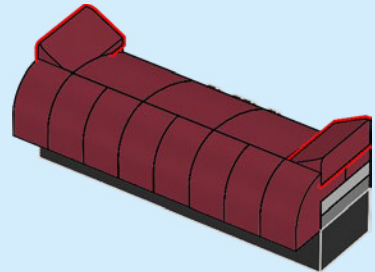

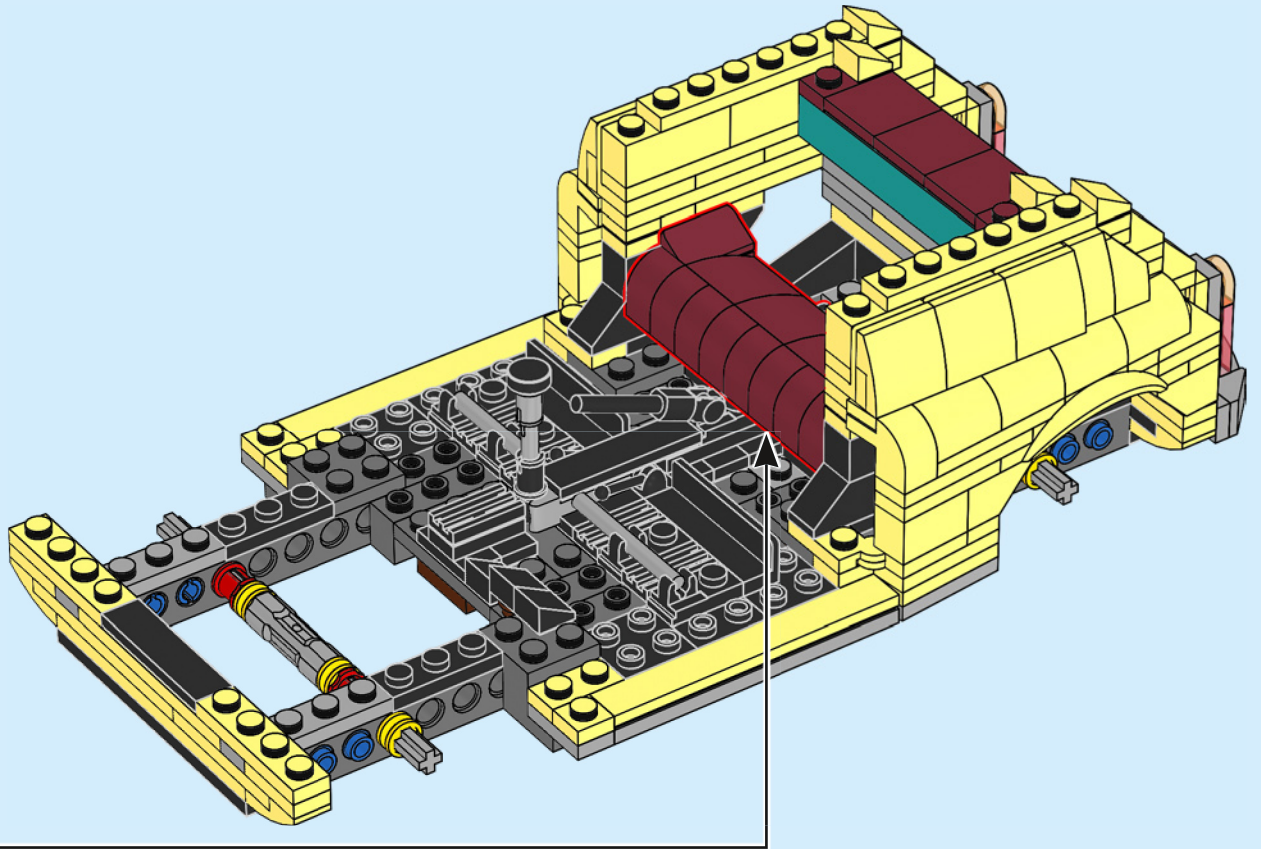

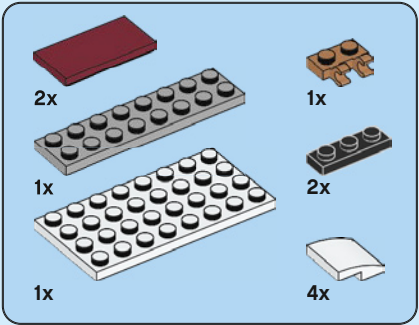

82

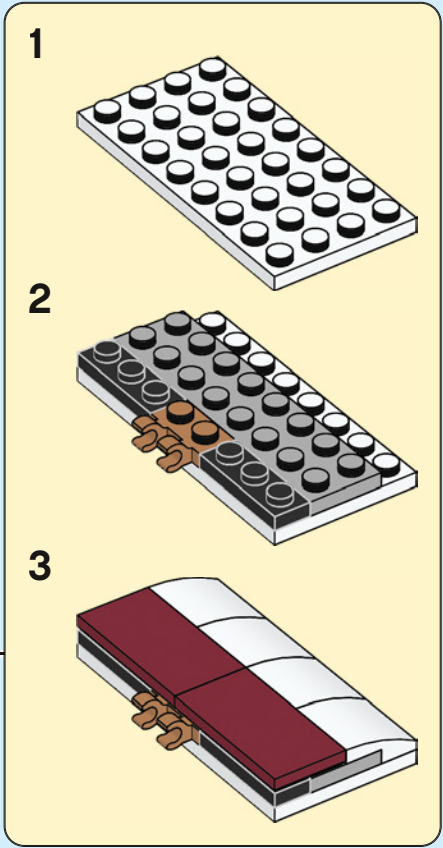
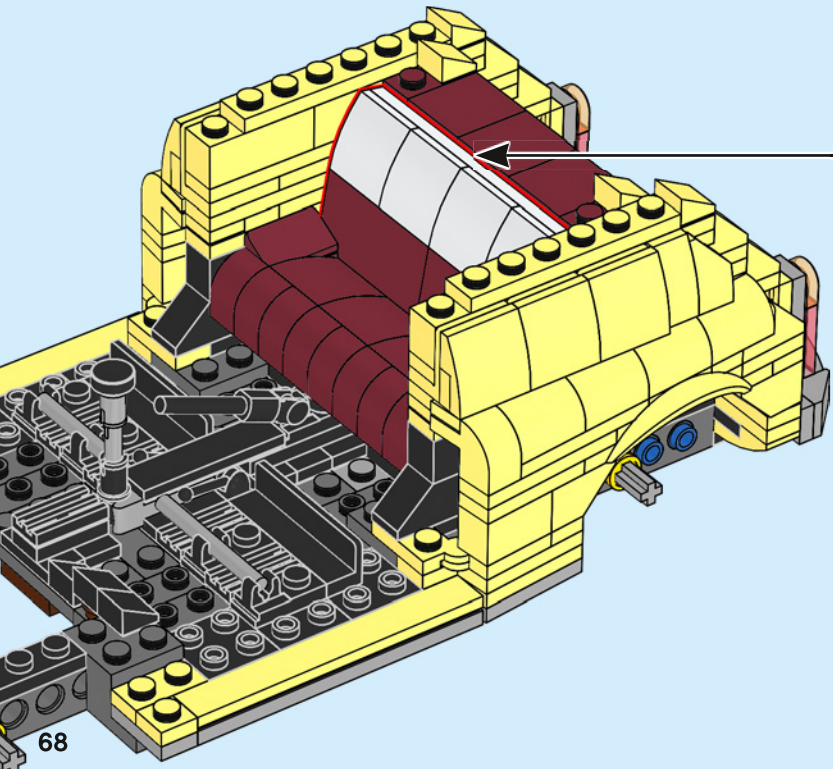

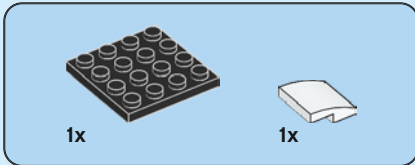

83

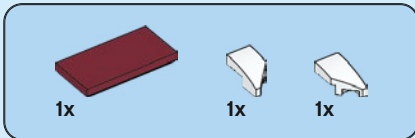
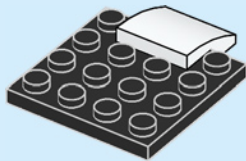

84

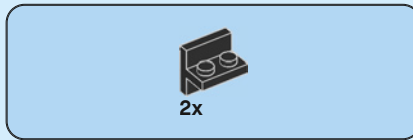
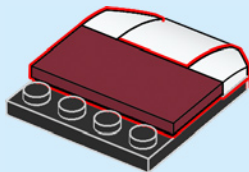

85

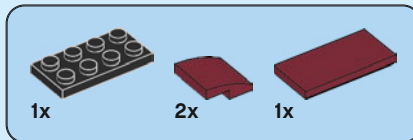
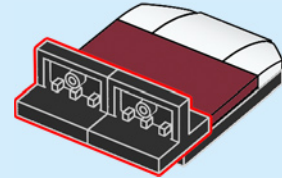

86

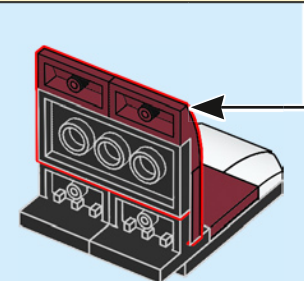
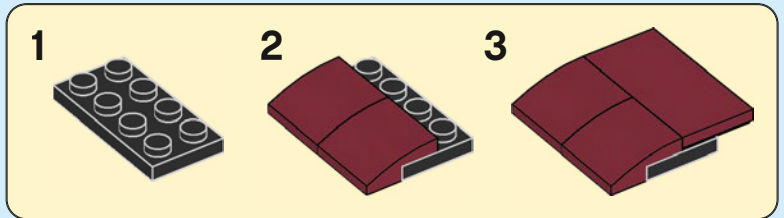



2x



1x

87

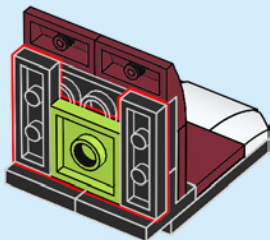

2x



2x

89

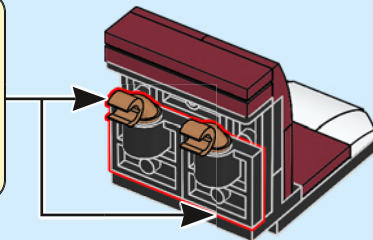
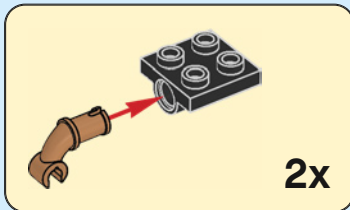

1x



1x



1x

88

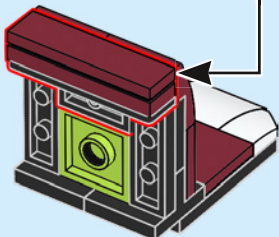
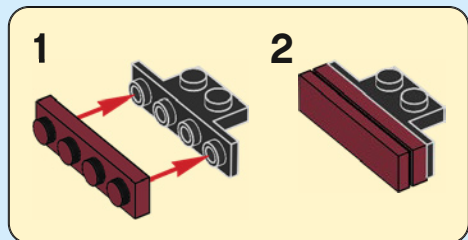

1x



1x

90

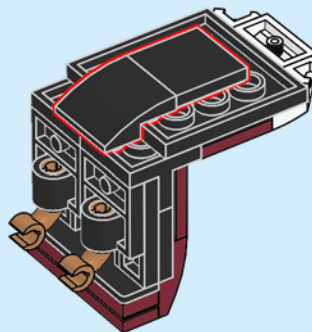

2x

91

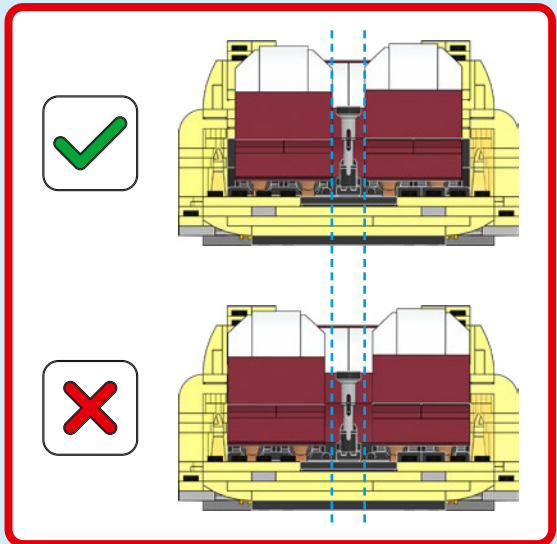
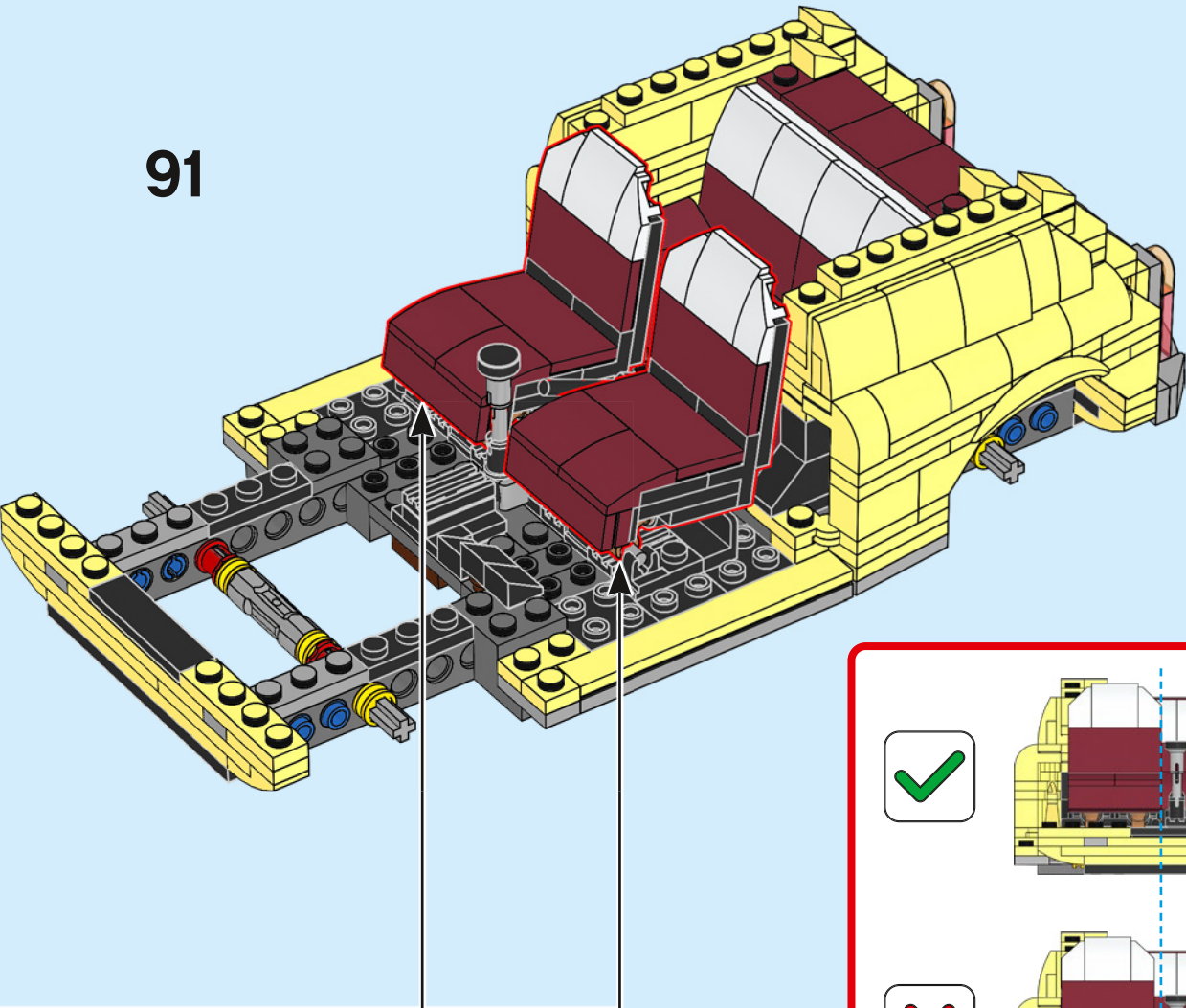

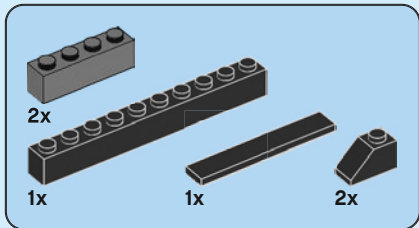

92

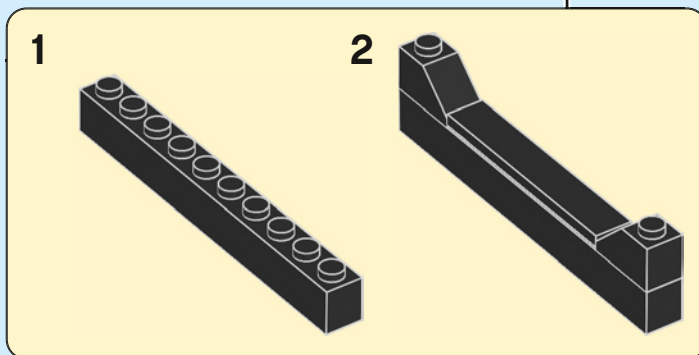
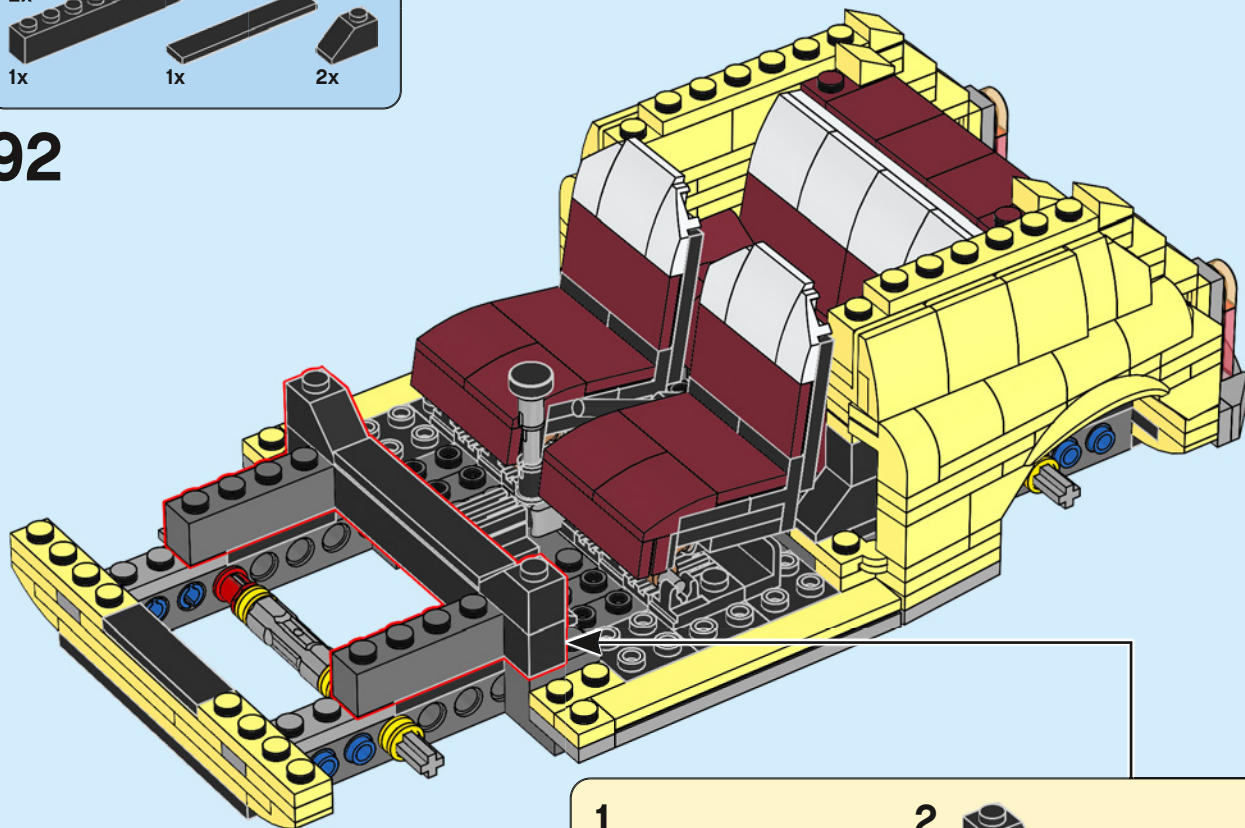

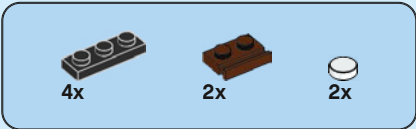

93

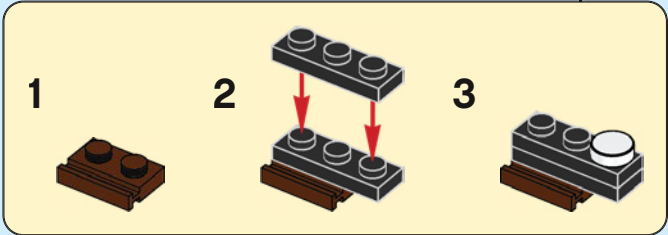
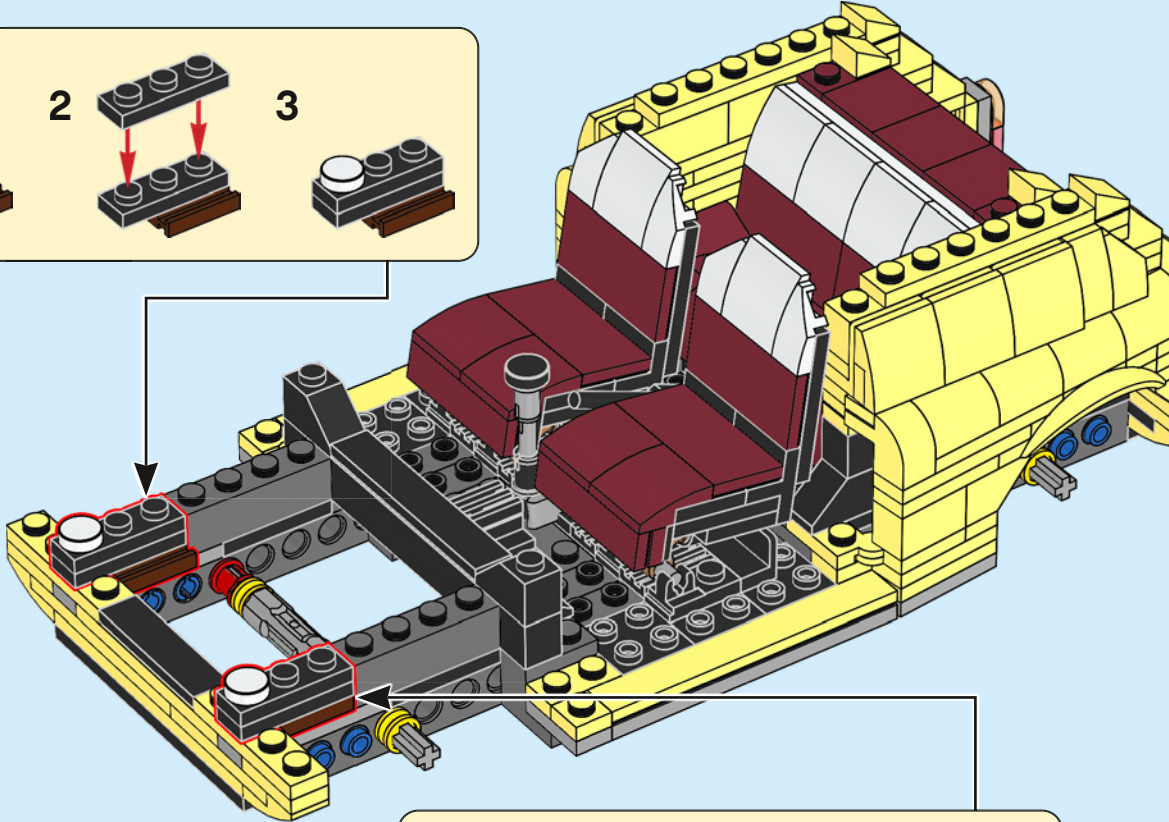
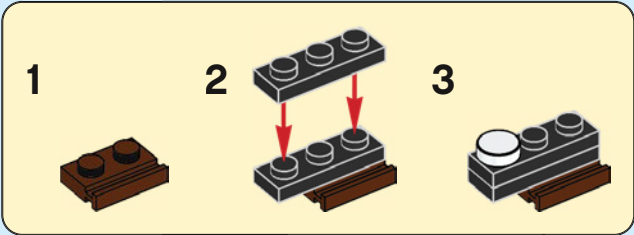

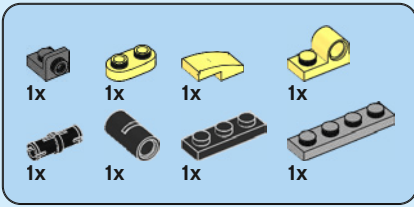

94

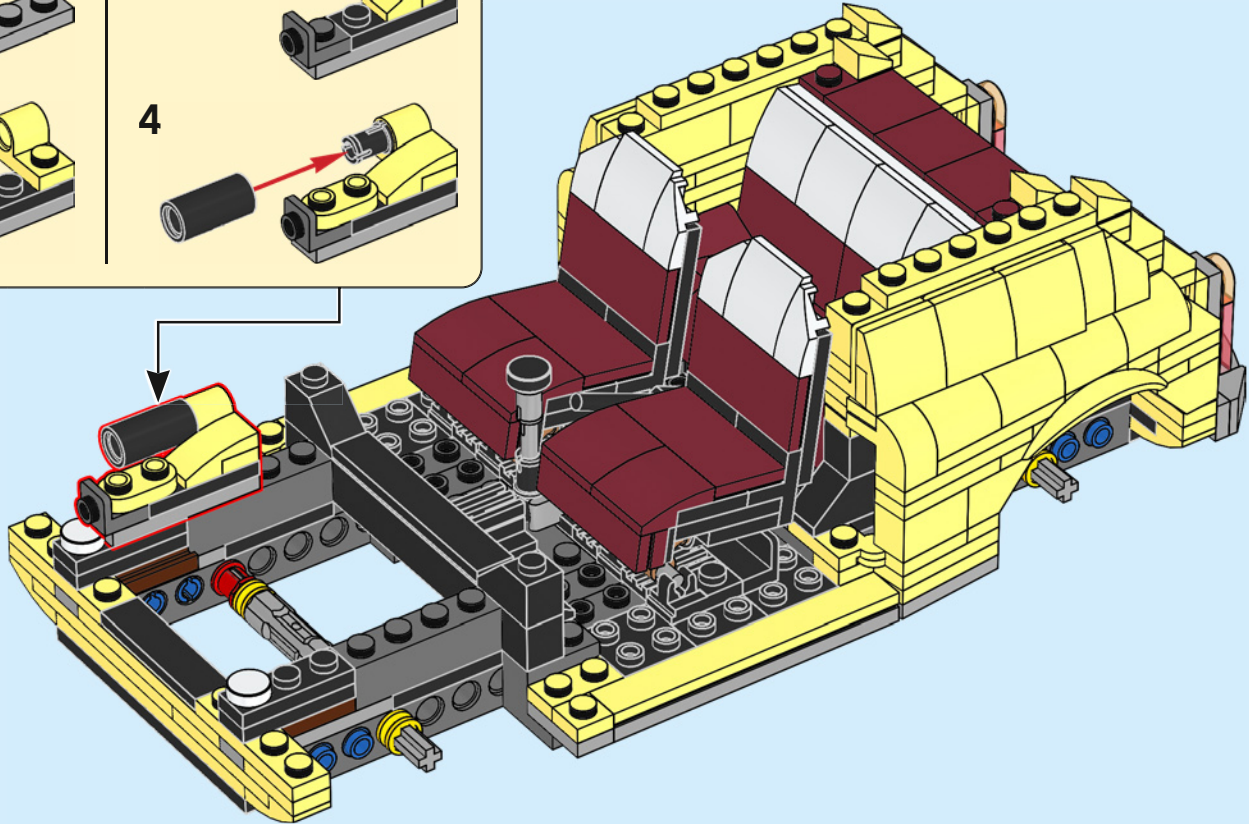
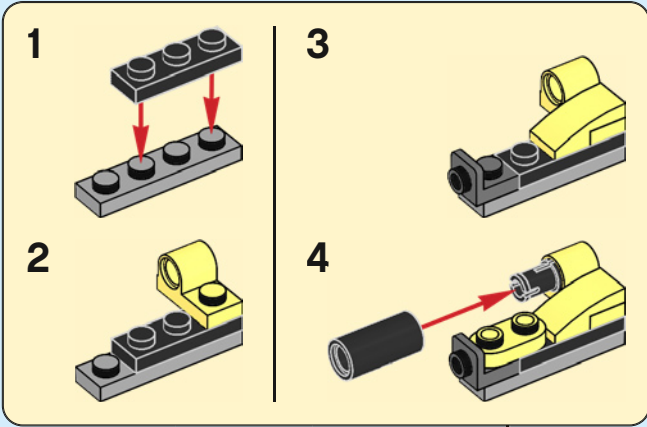

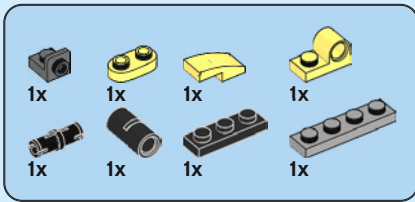

95

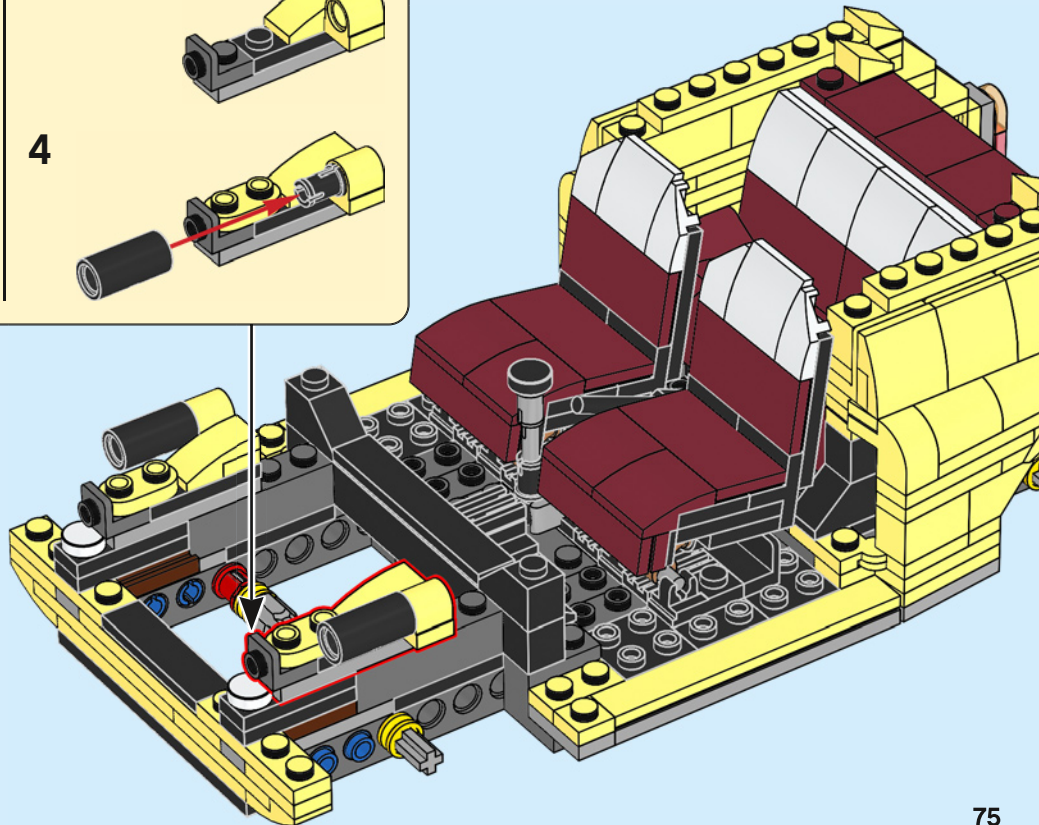
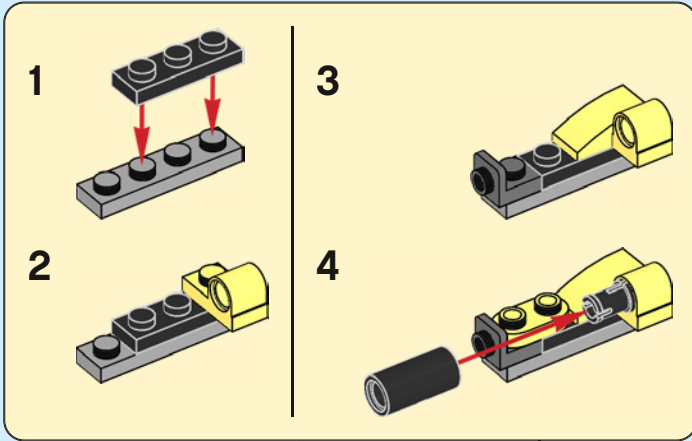

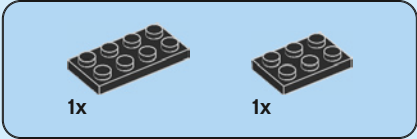
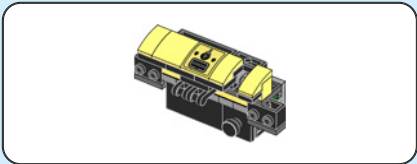

96

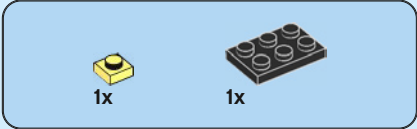
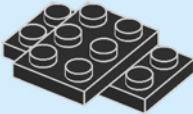

97

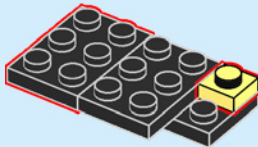

98

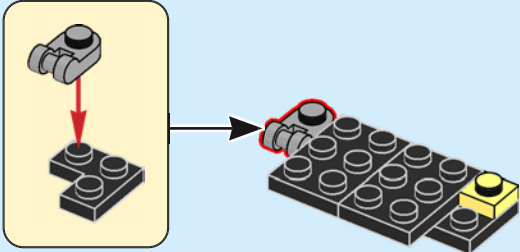

99

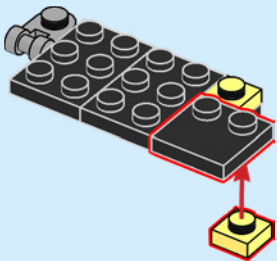

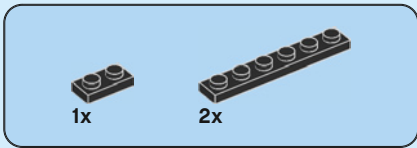

100

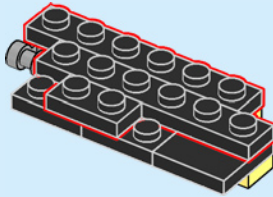

101

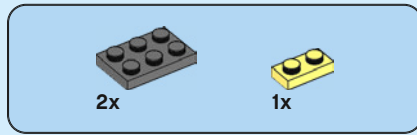
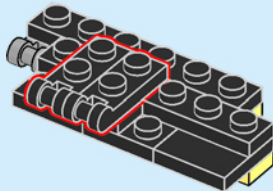

102

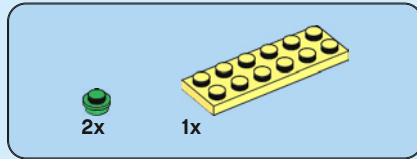
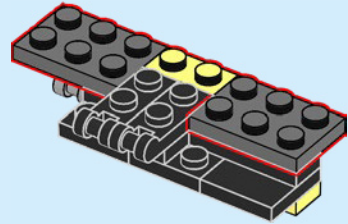

103

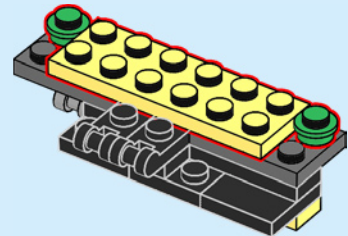

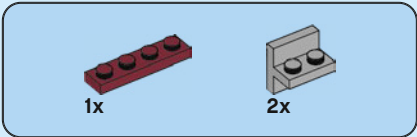

104

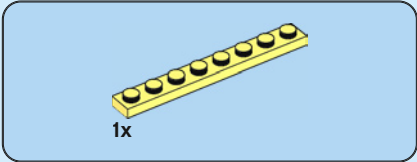
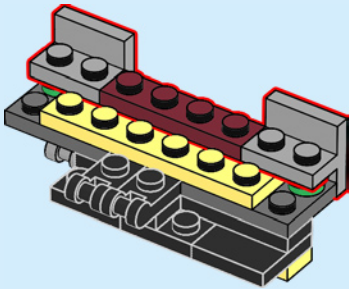

105

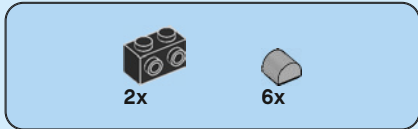
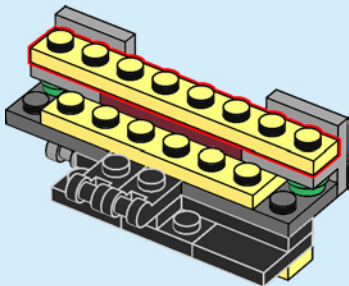

106

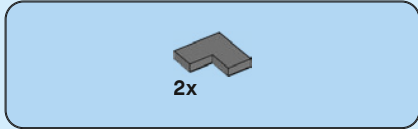
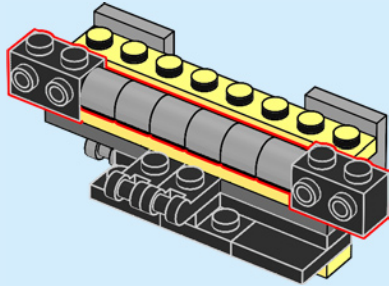

107

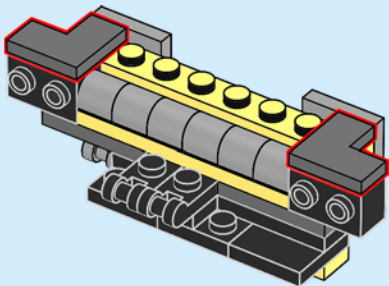

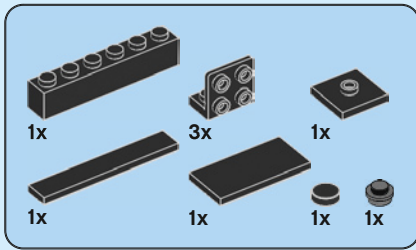

108

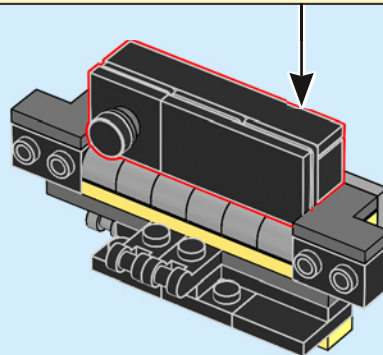
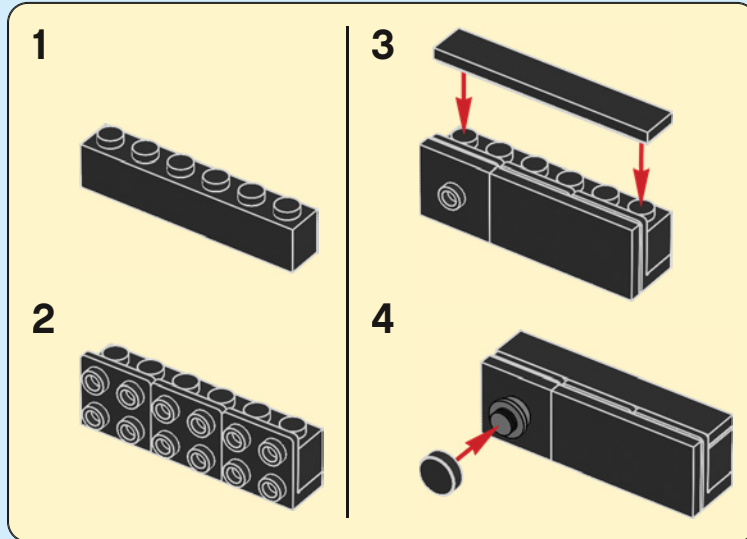

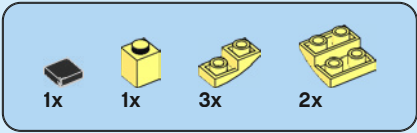

109

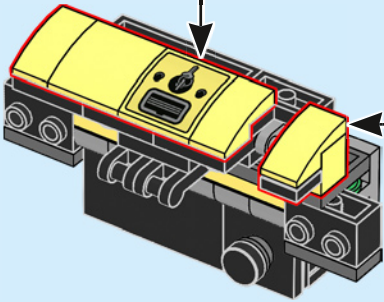
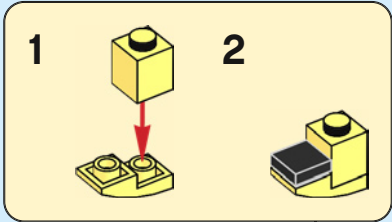
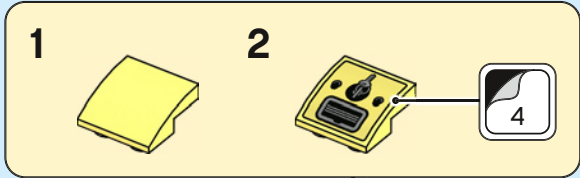

110

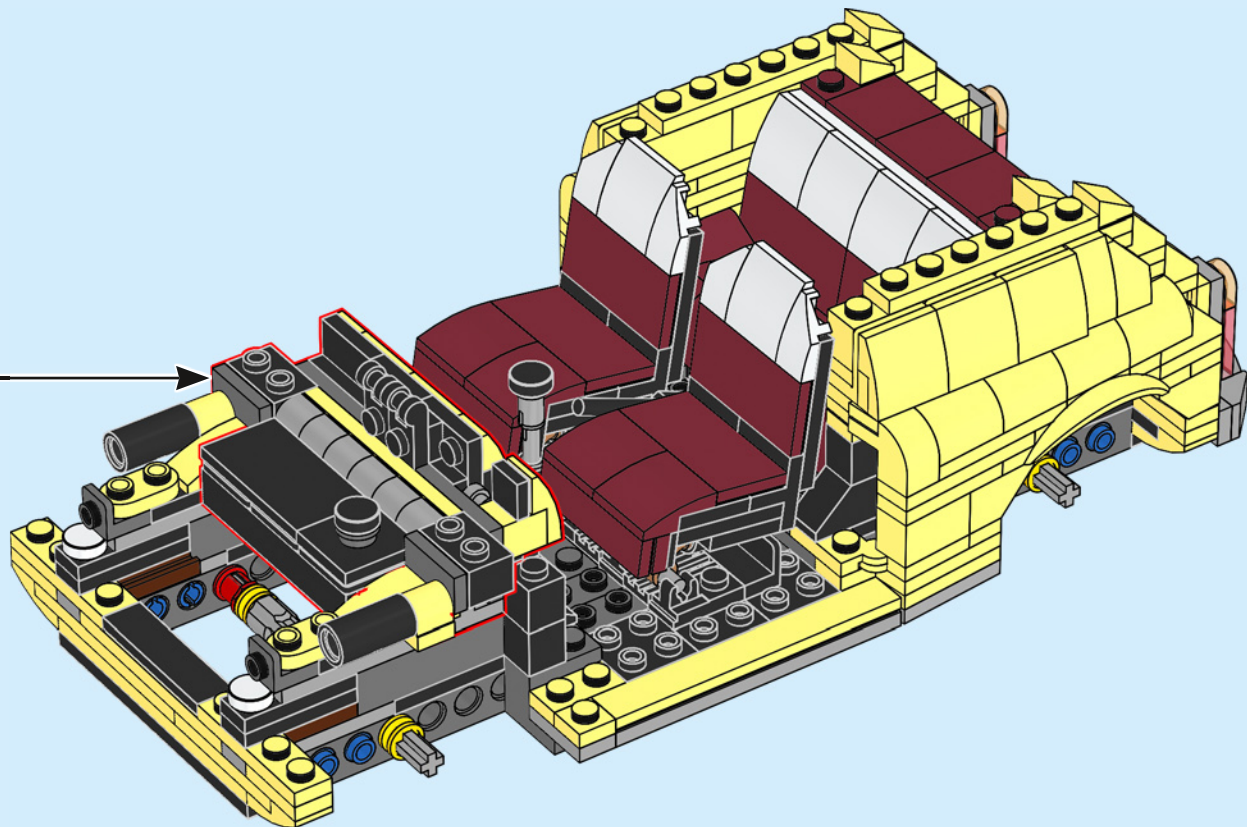

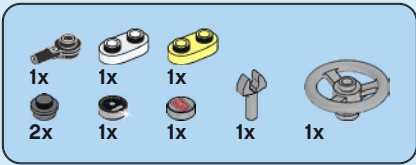

111

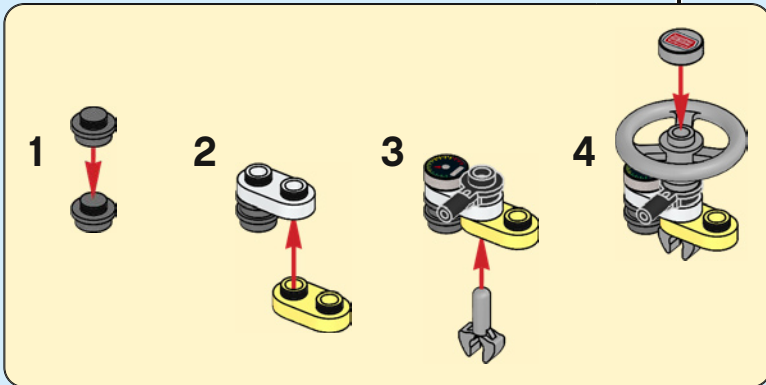
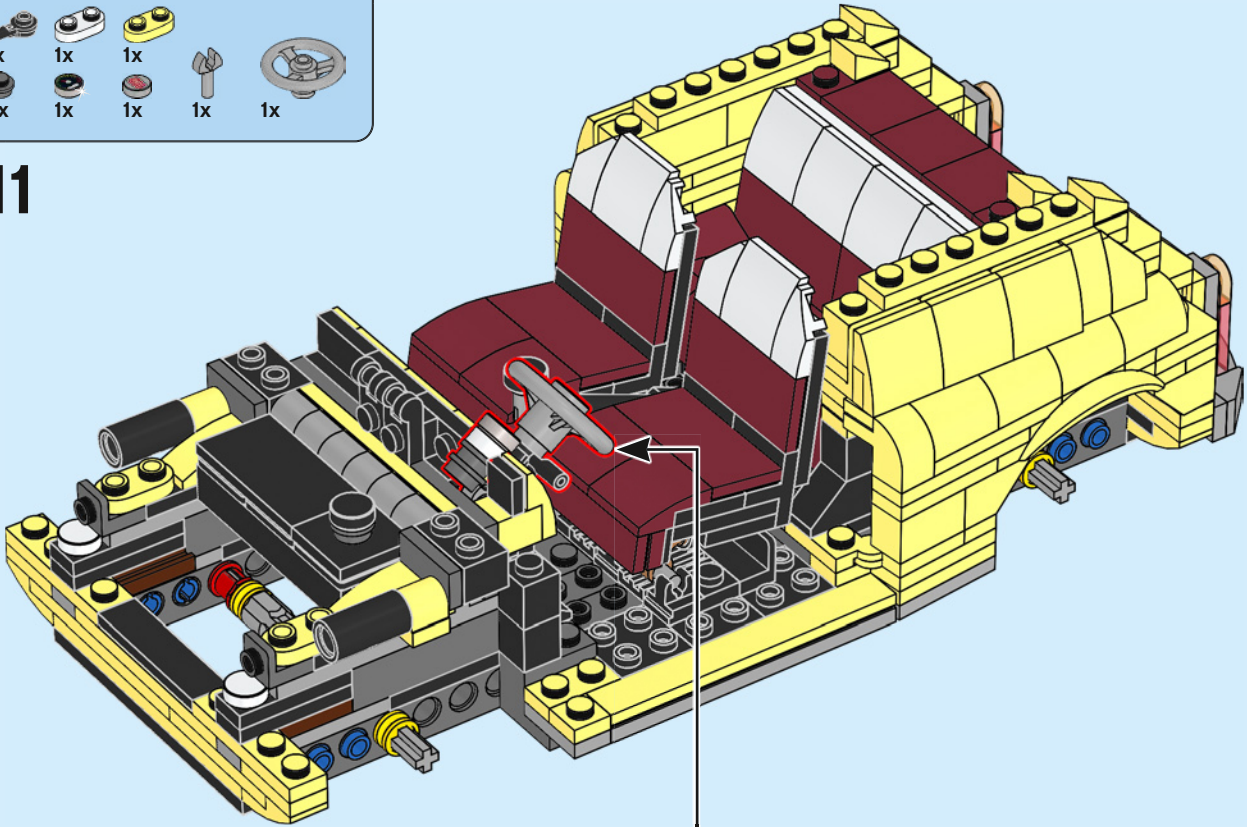

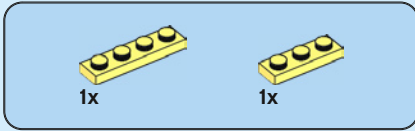
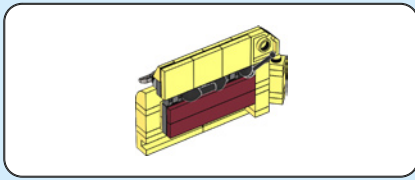

112

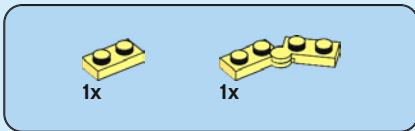
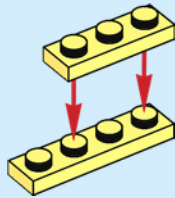

113

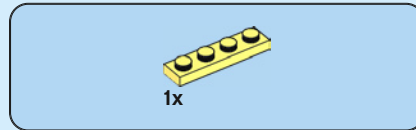
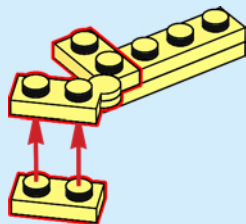

114

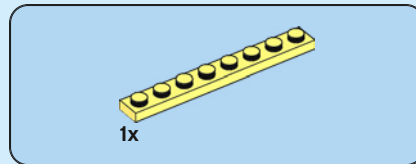
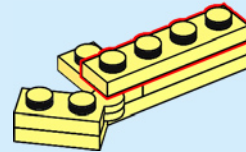

115

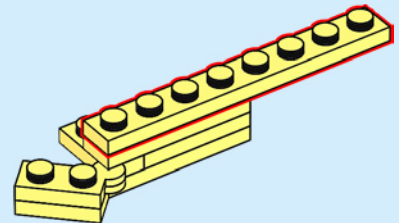

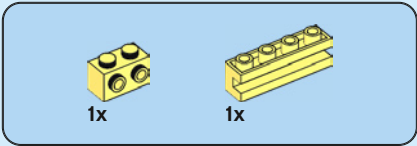

116

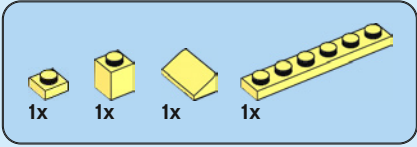
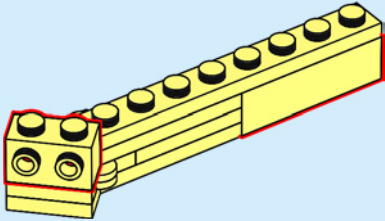

117

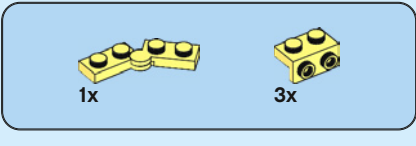
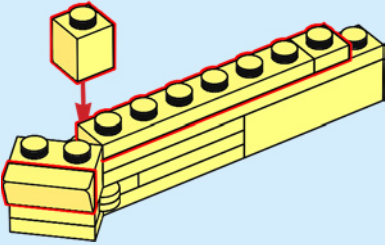

118

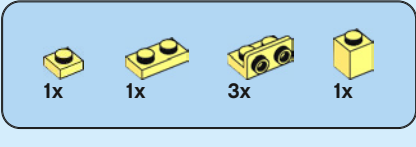
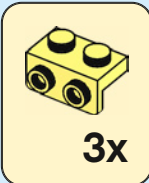
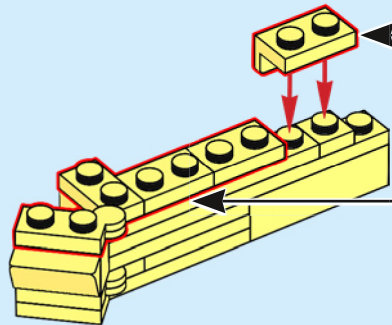

119

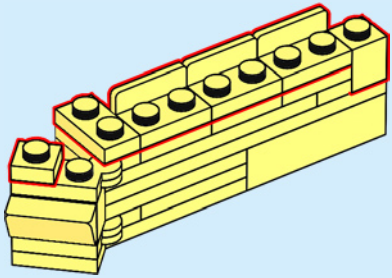

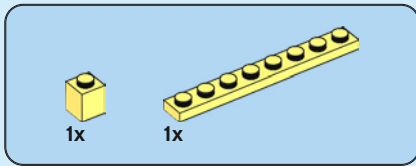

120

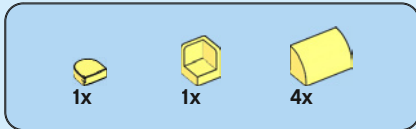
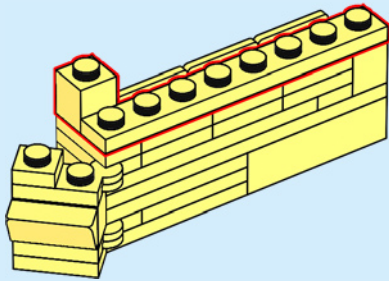

121

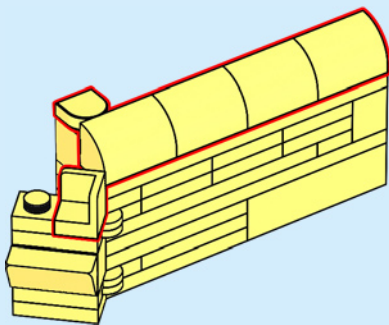

122

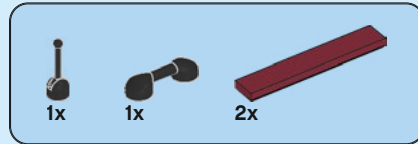
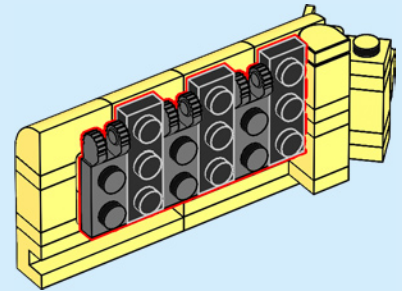

123

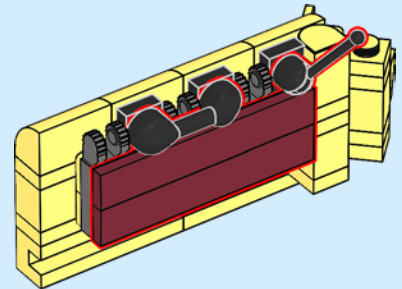

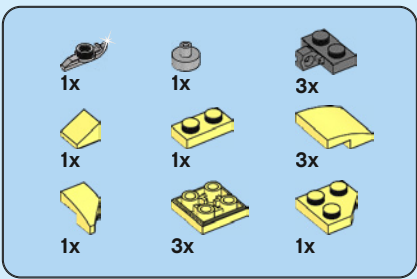

124

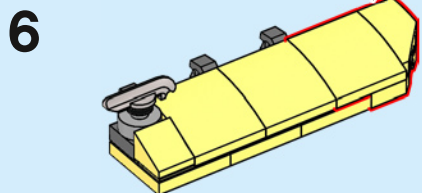
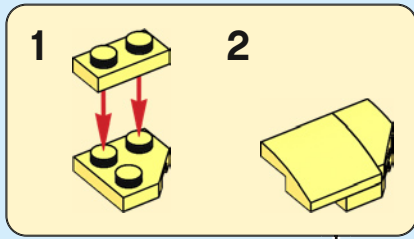
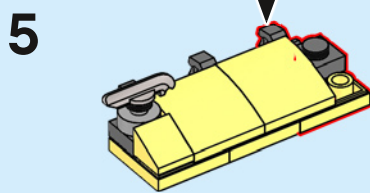
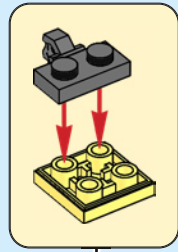
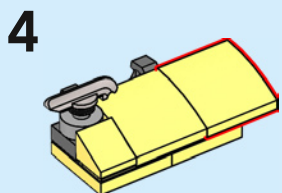
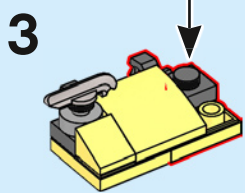
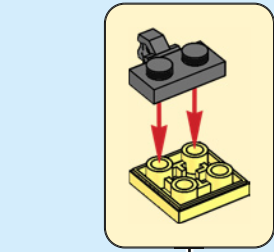
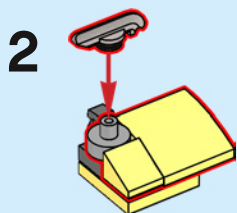
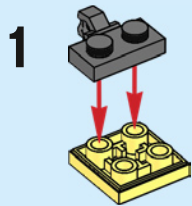

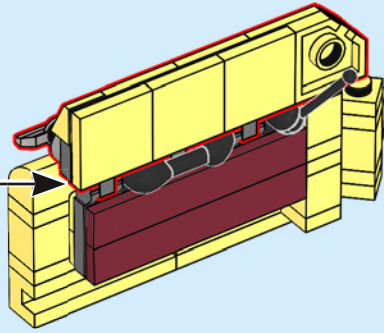

125

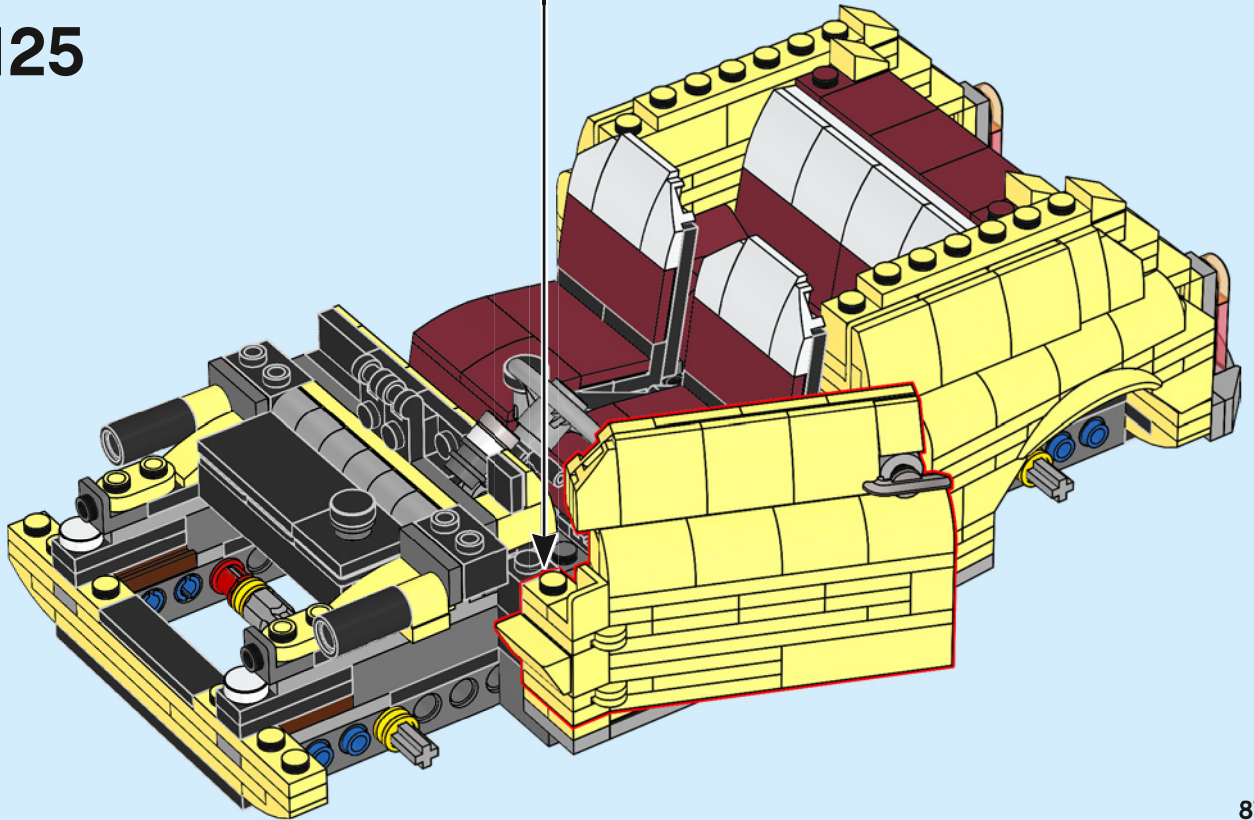

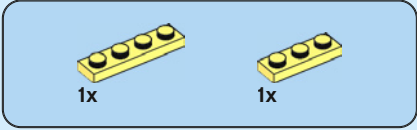
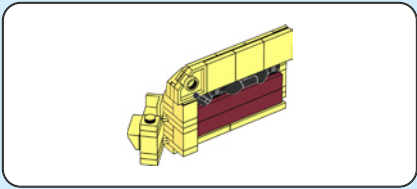

126

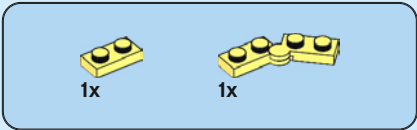
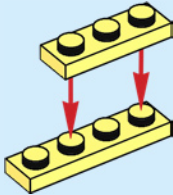

127

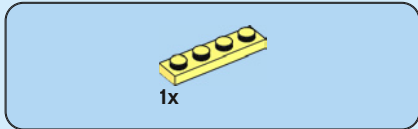
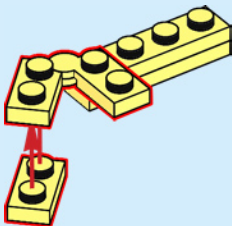

128

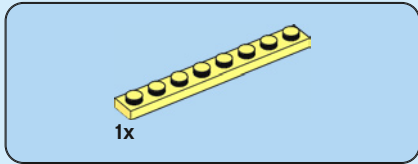
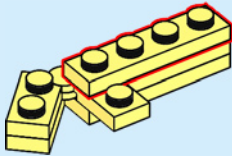

129

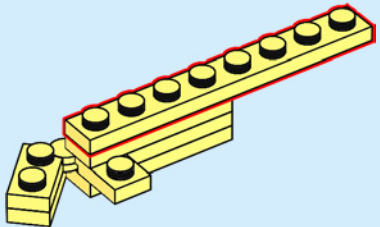

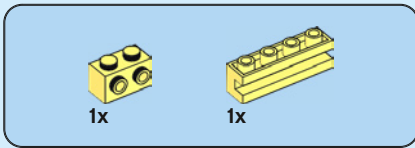

130

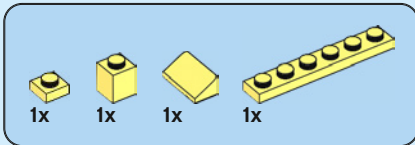
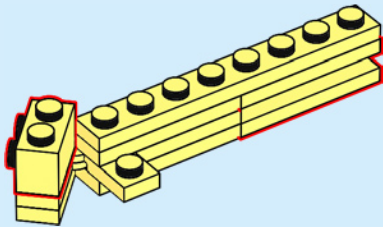

131

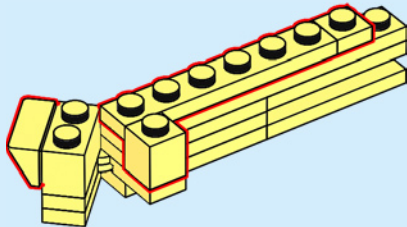

132

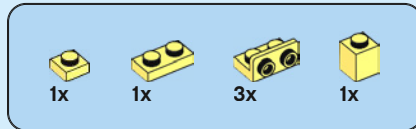
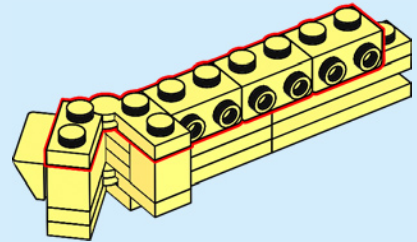

133

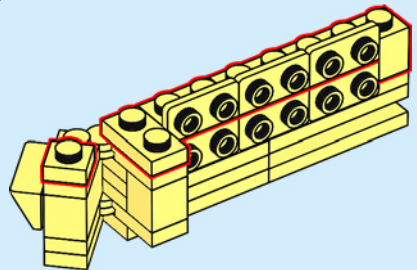

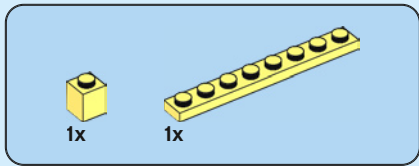

134

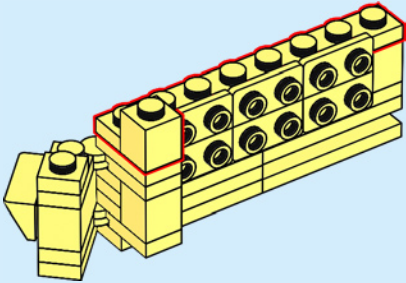

135

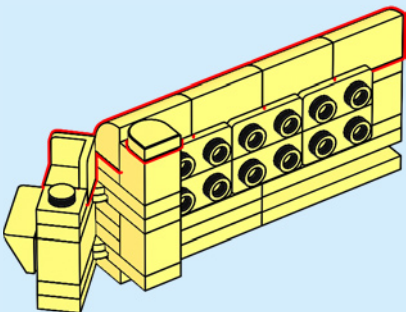

136

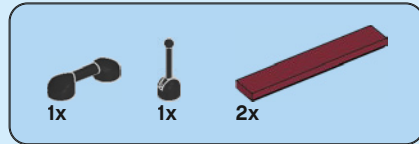
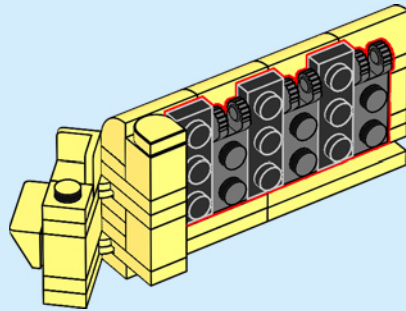

137

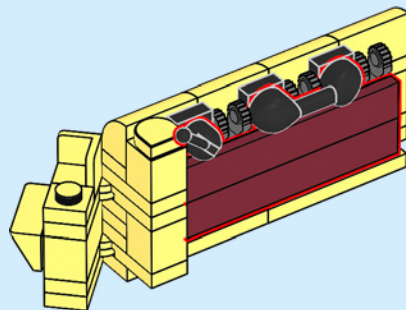

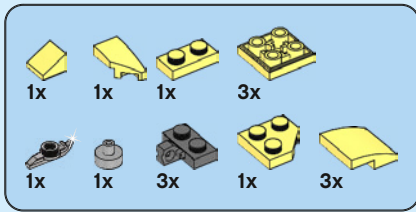

138

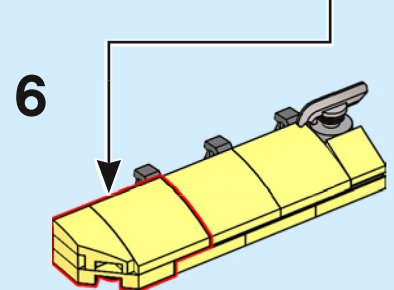
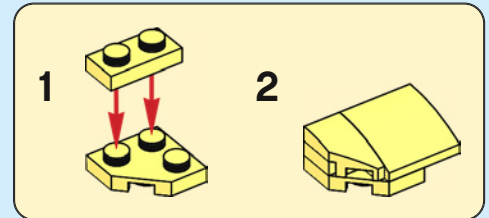
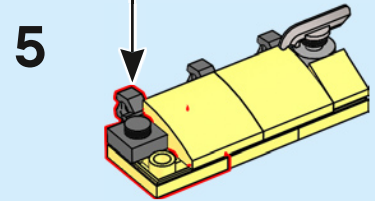
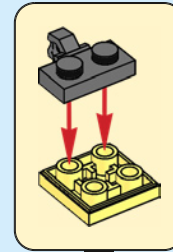
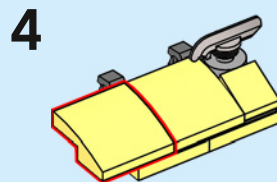
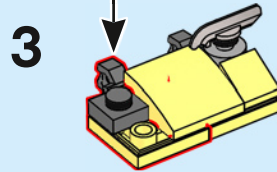
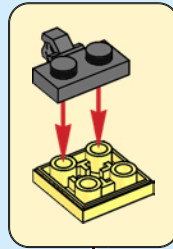
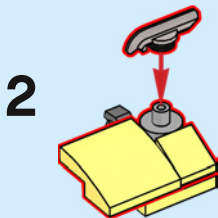
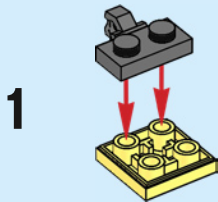

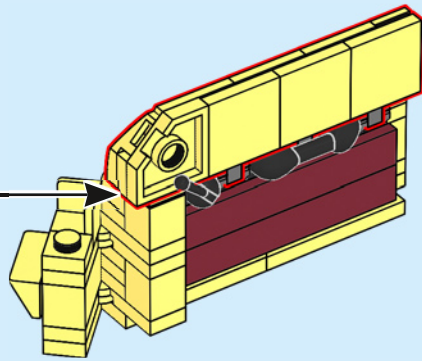

139

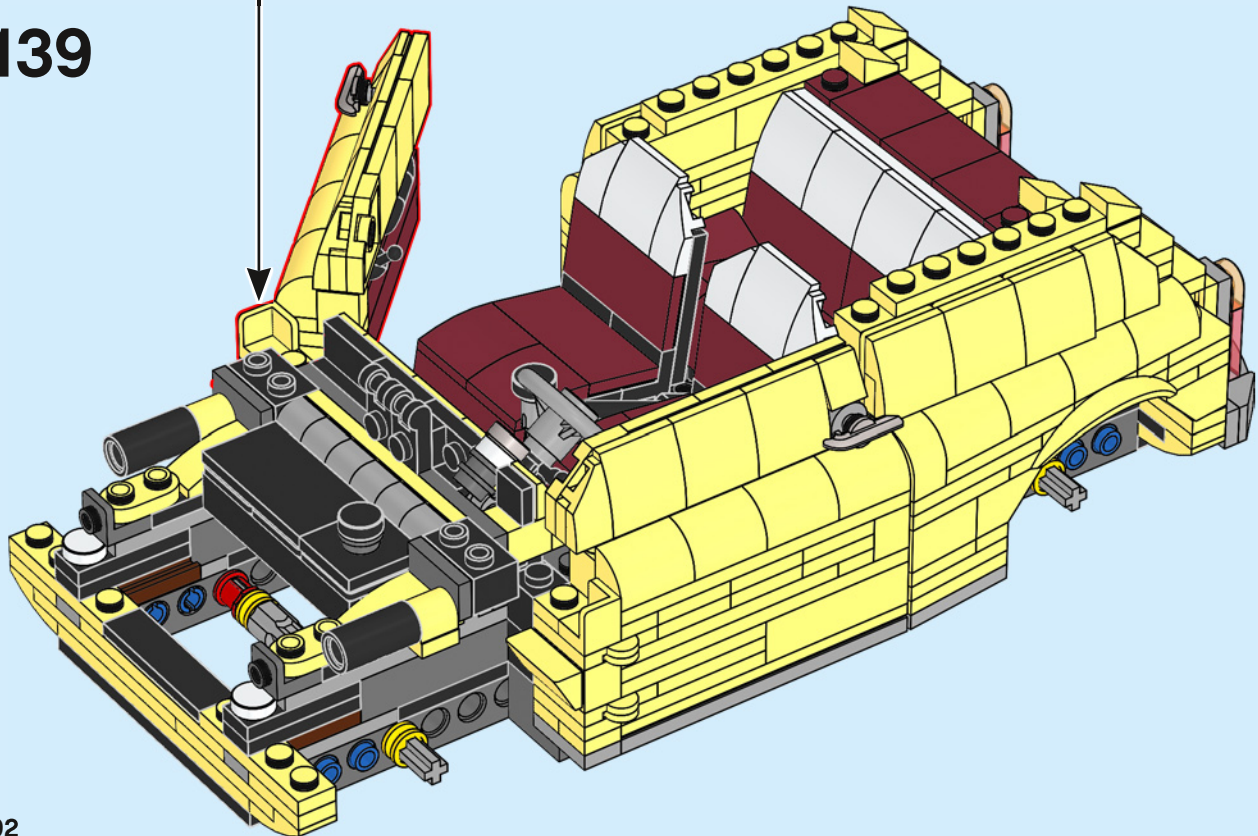

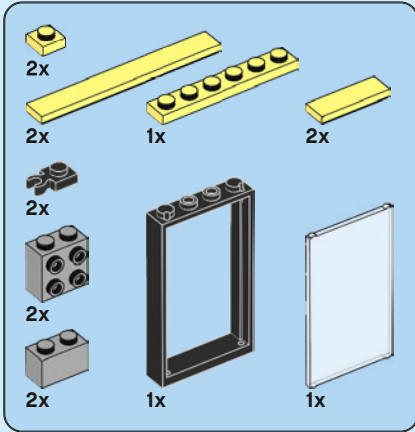
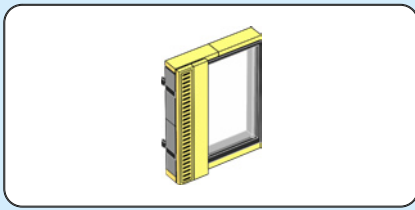

140

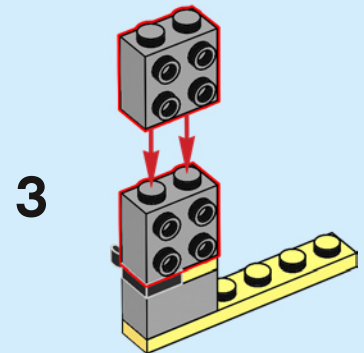
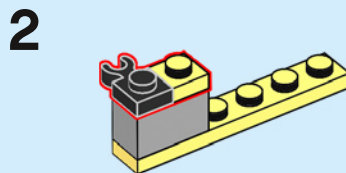
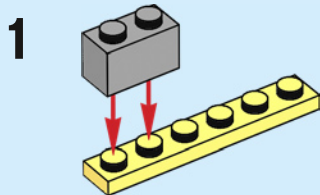

4

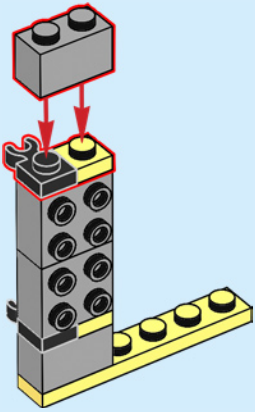

5

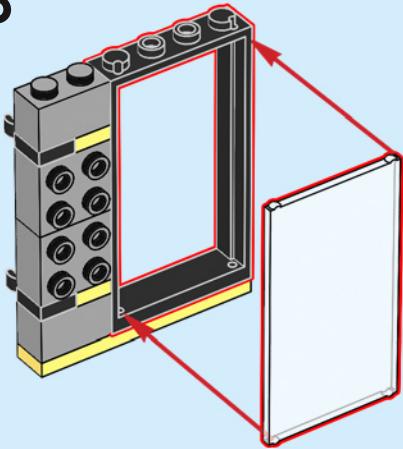

6

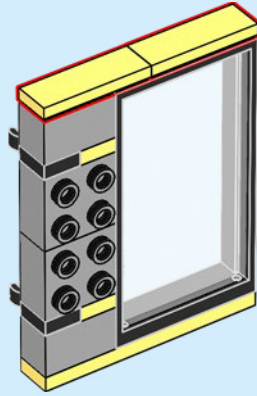

7

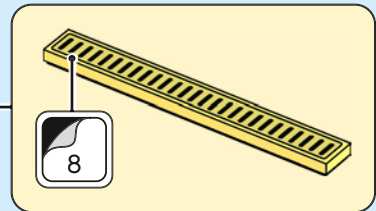
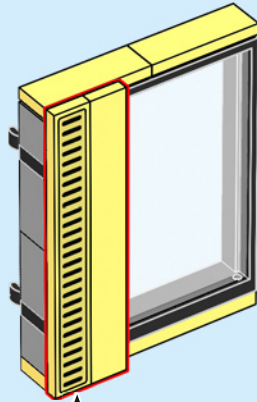

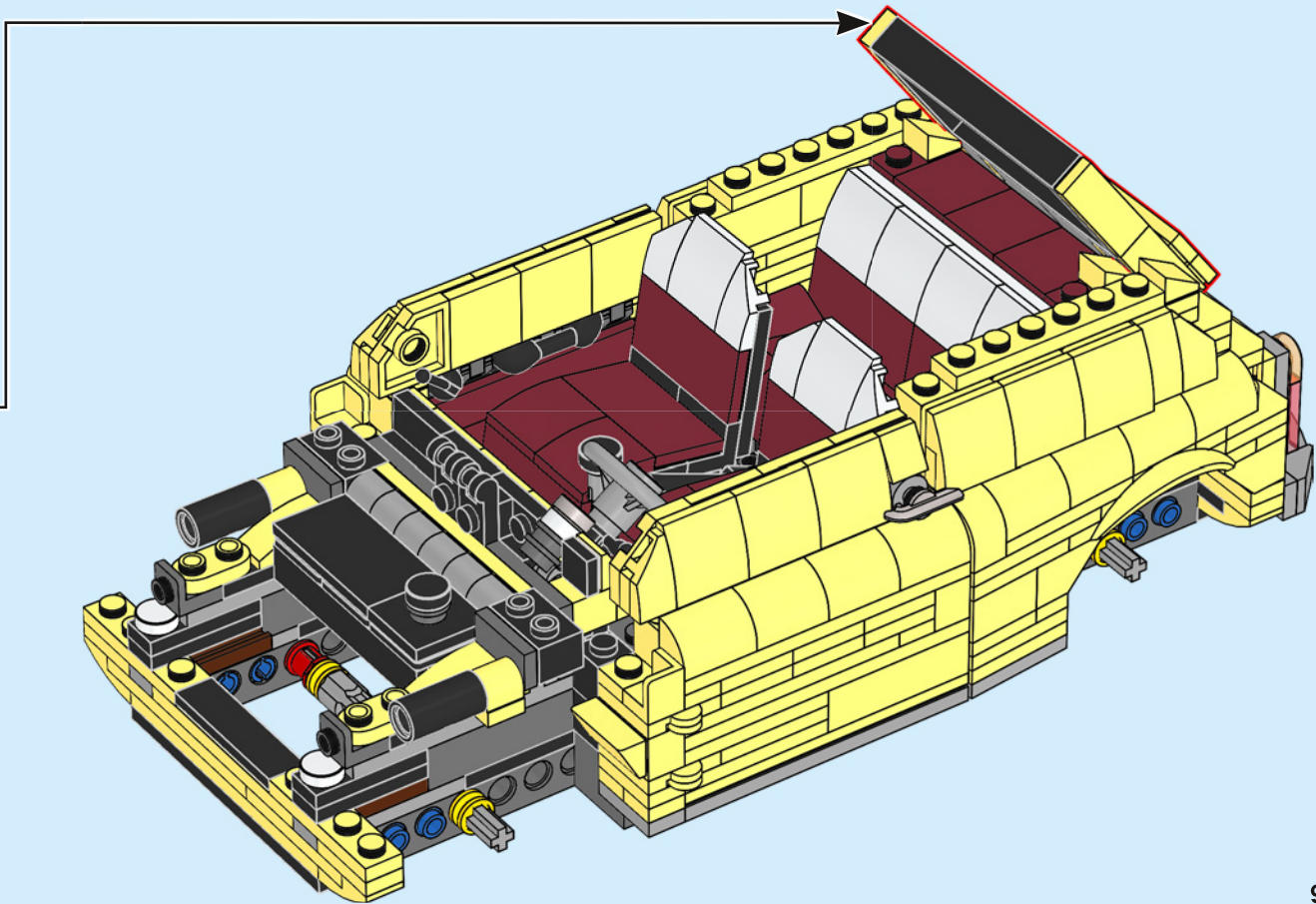

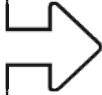

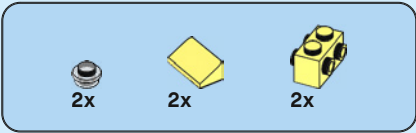

141

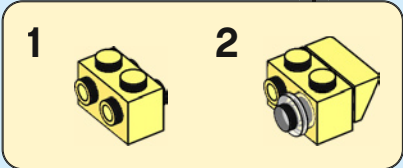
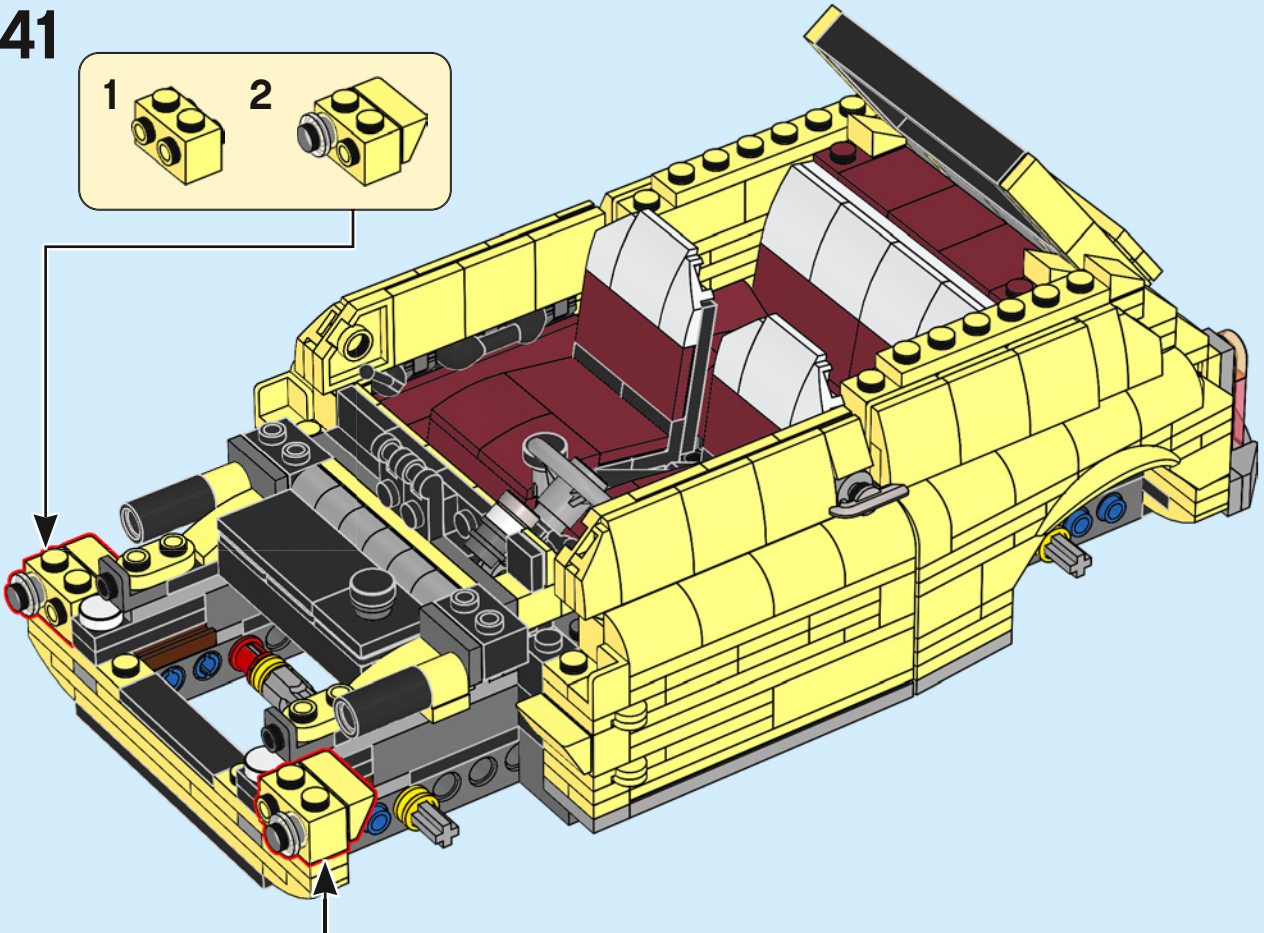
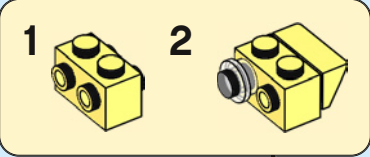

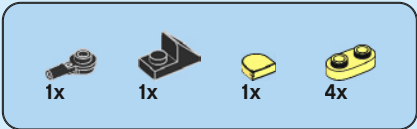

142

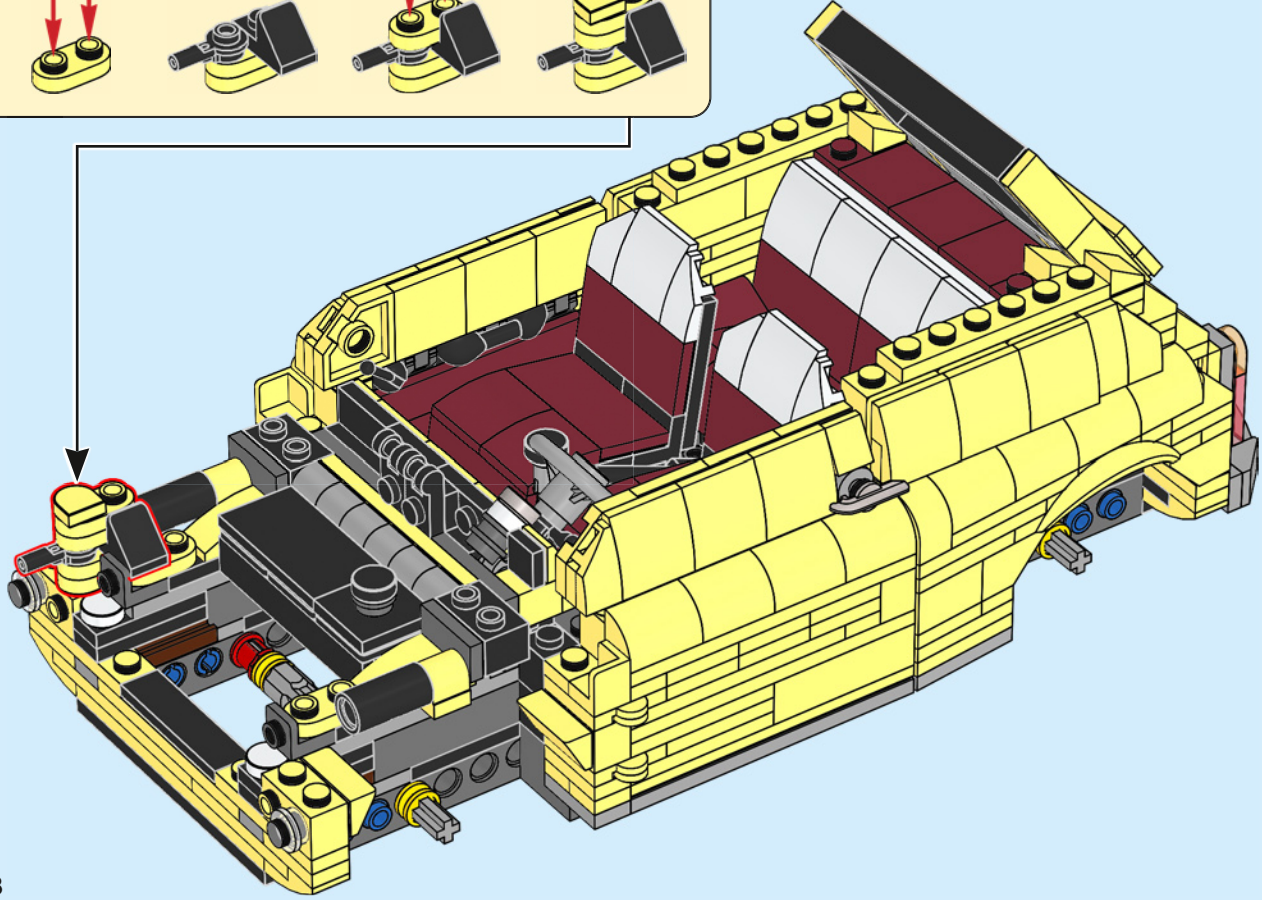
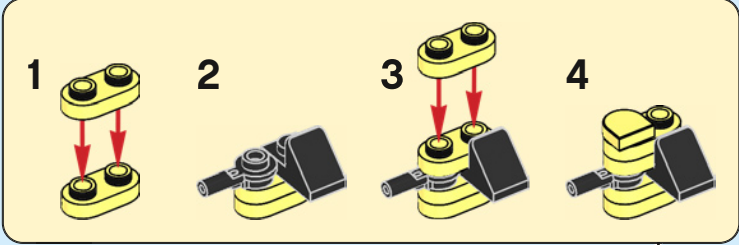

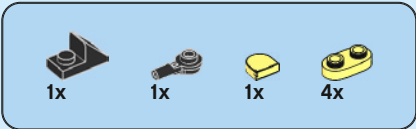

143

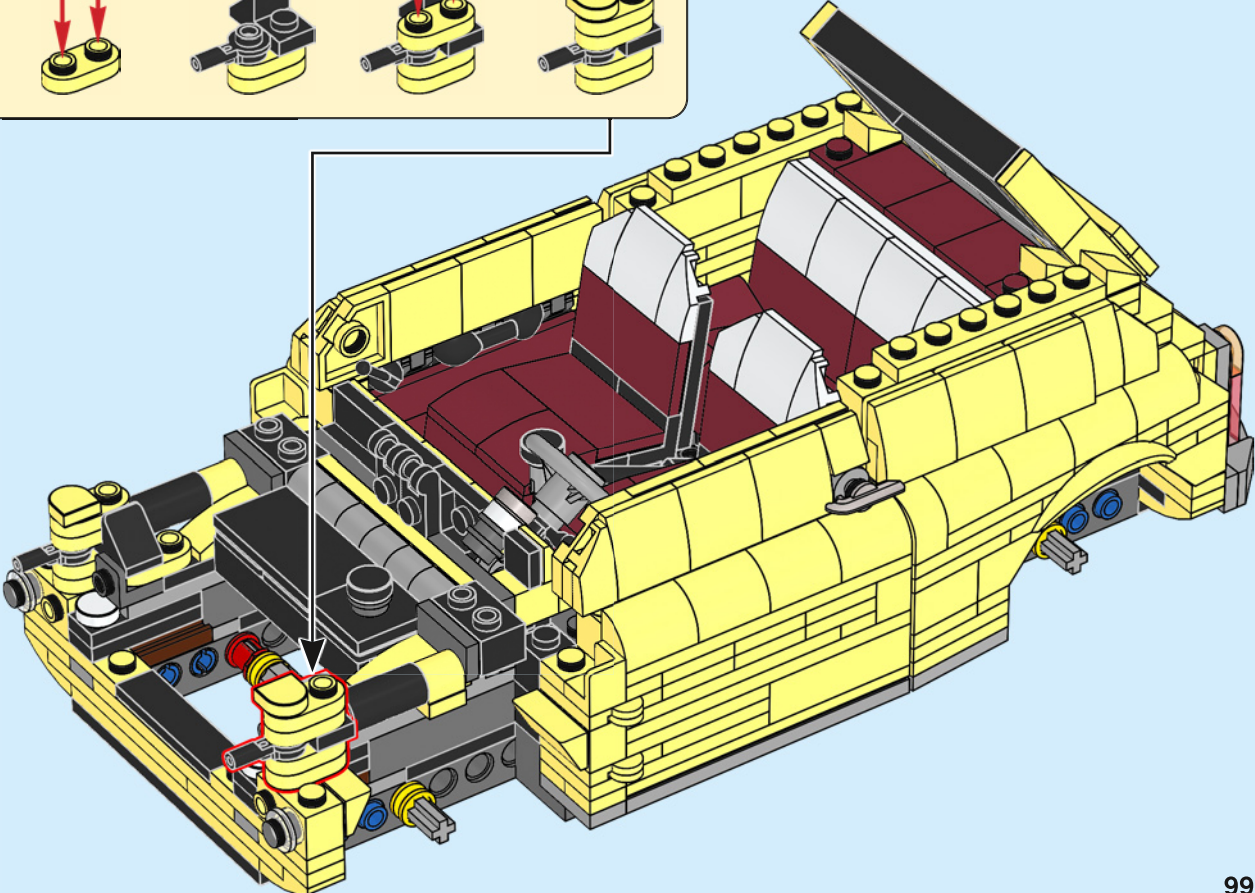
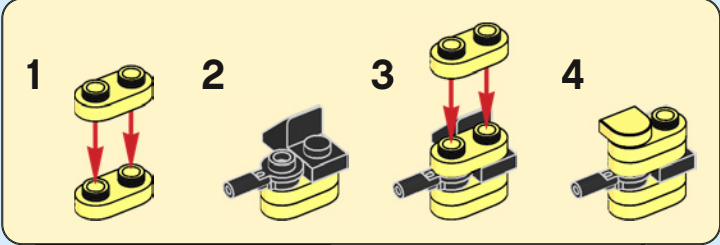

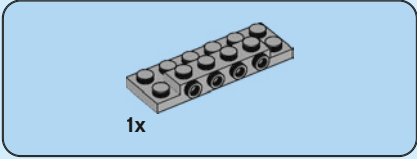
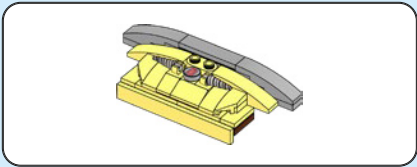

1x

144

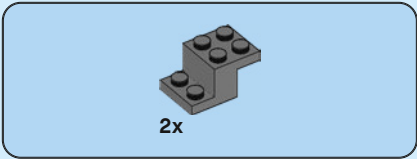
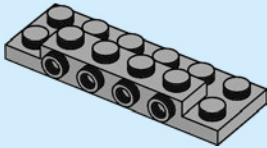

2x

145

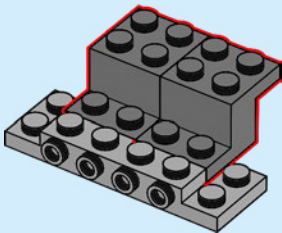

2x

146

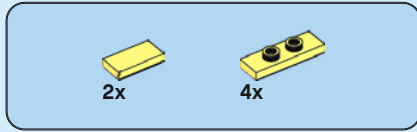
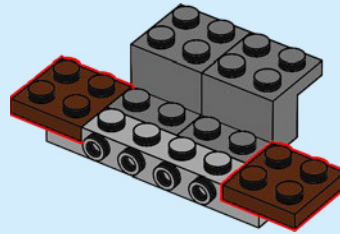

2x

4x

147

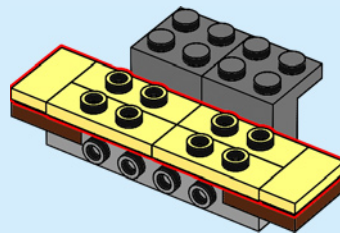

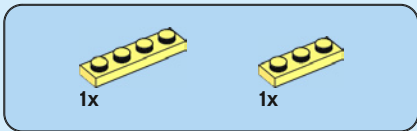

148

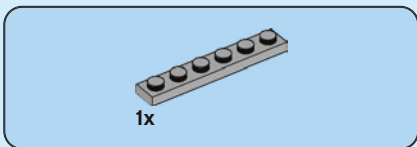
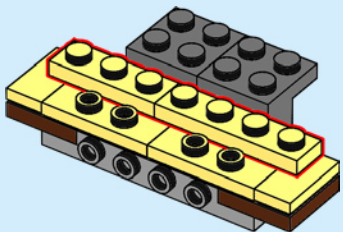

149

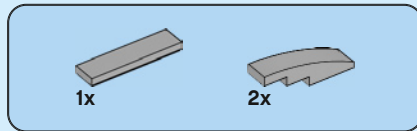
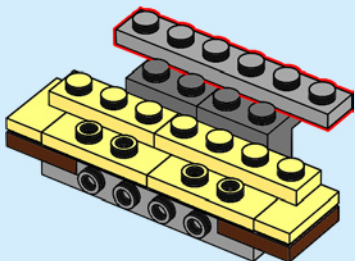

150

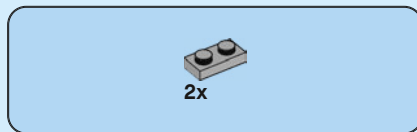
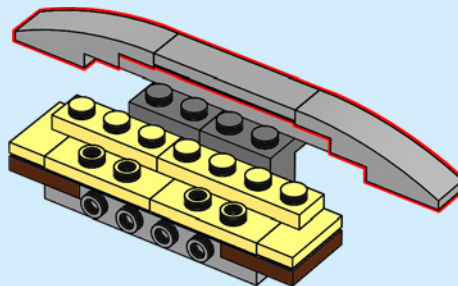

151

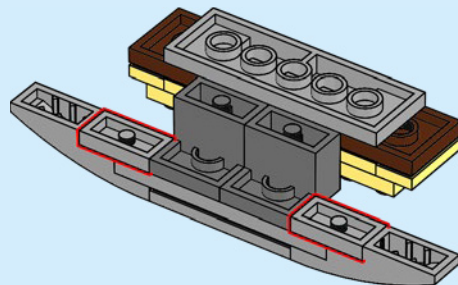



2x



2x

152

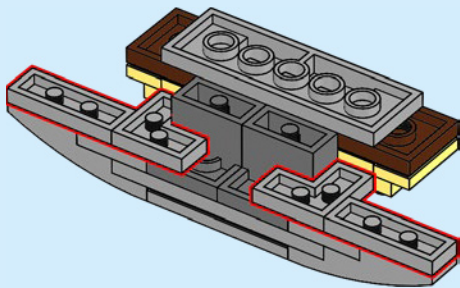

1x



2x

153

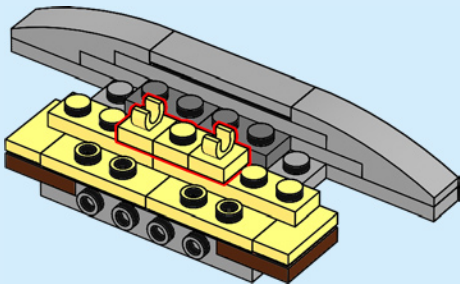

2x



1x



1x



1x



1x

154

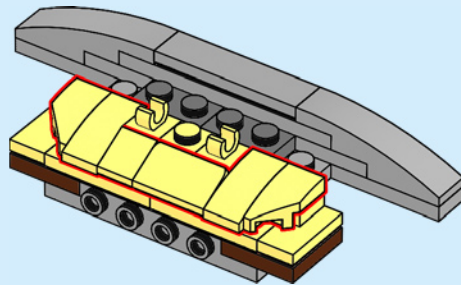

2x



1x



2x

155

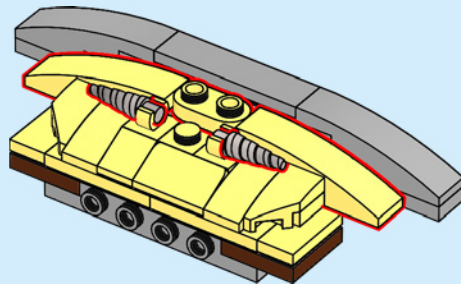

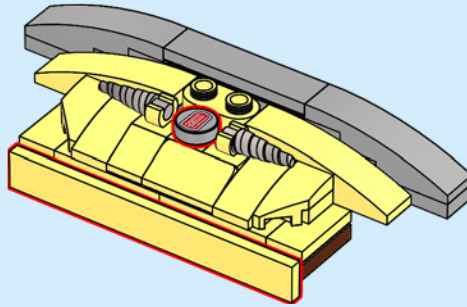
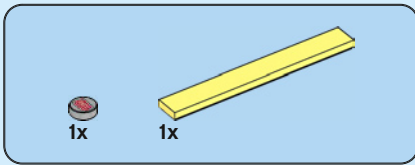

156

157

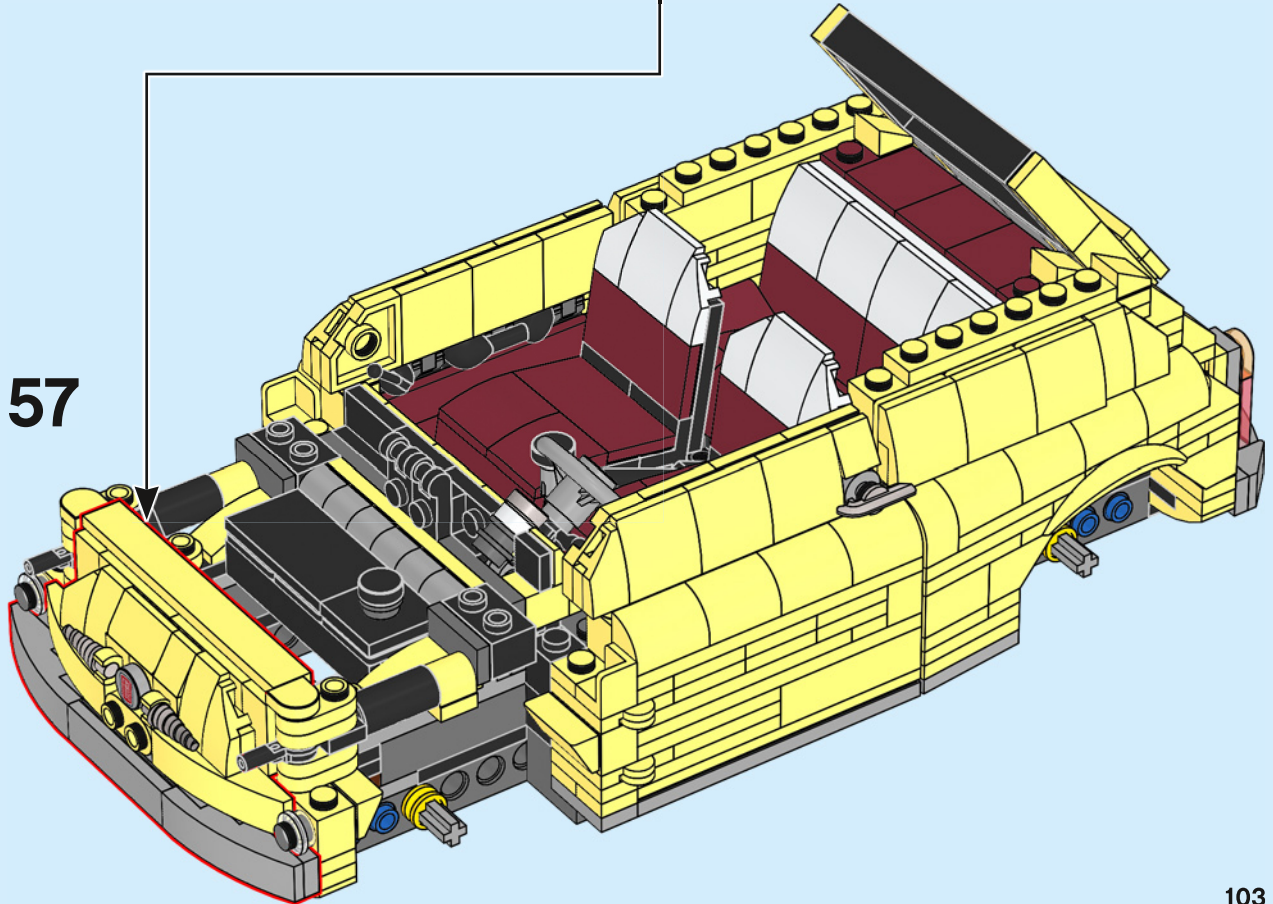

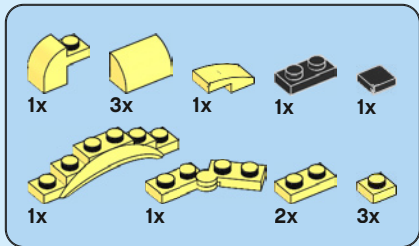

158

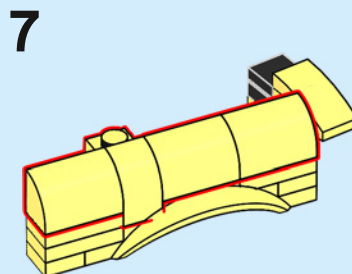
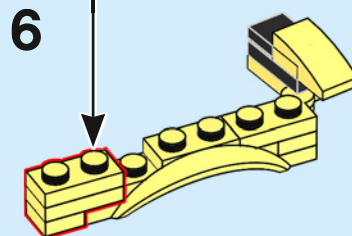
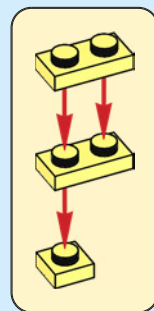
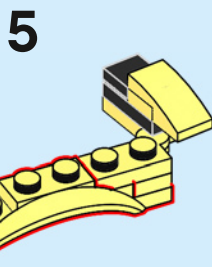
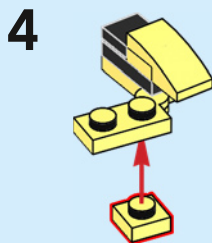
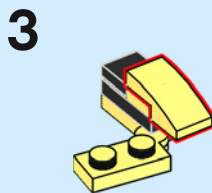
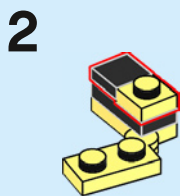
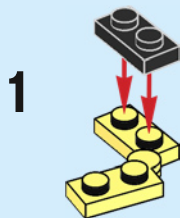

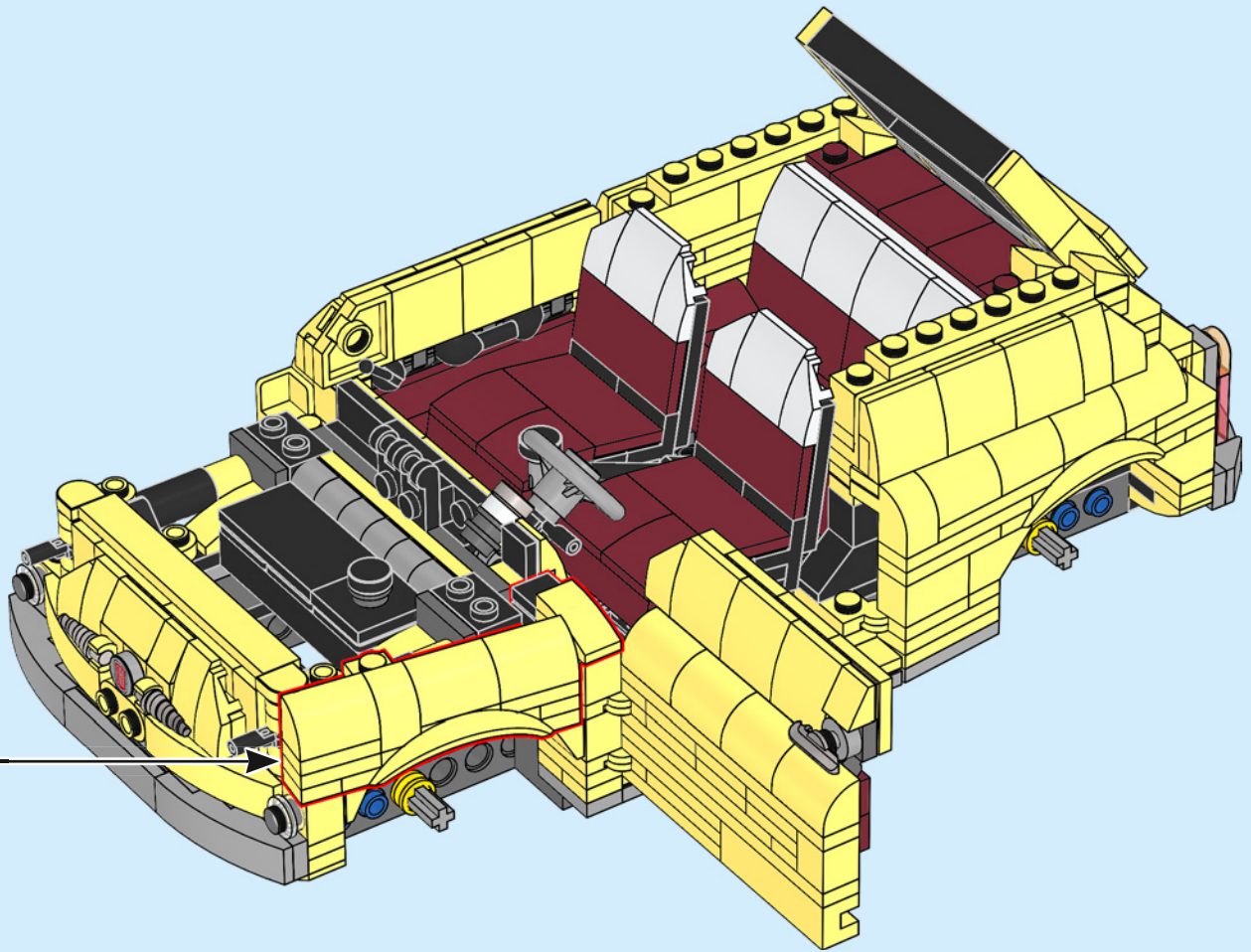

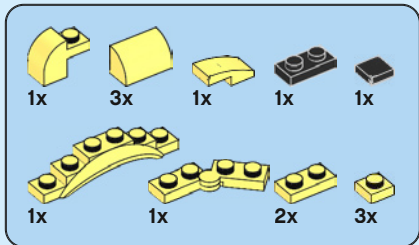

159

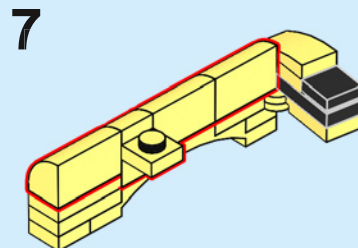
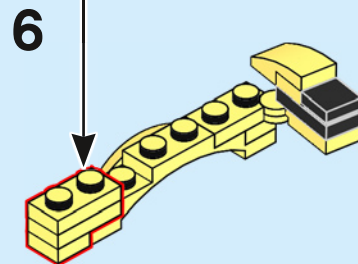
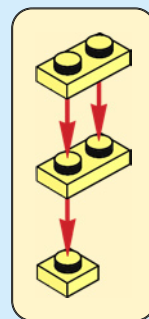
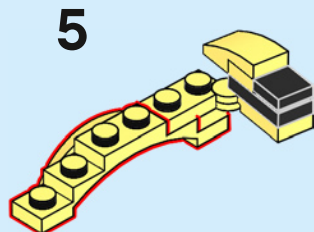
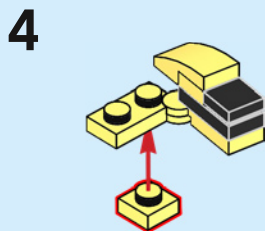
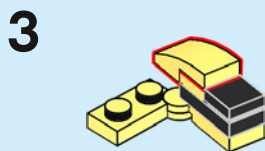
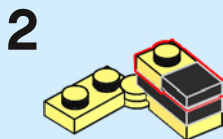
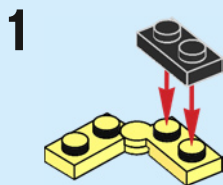

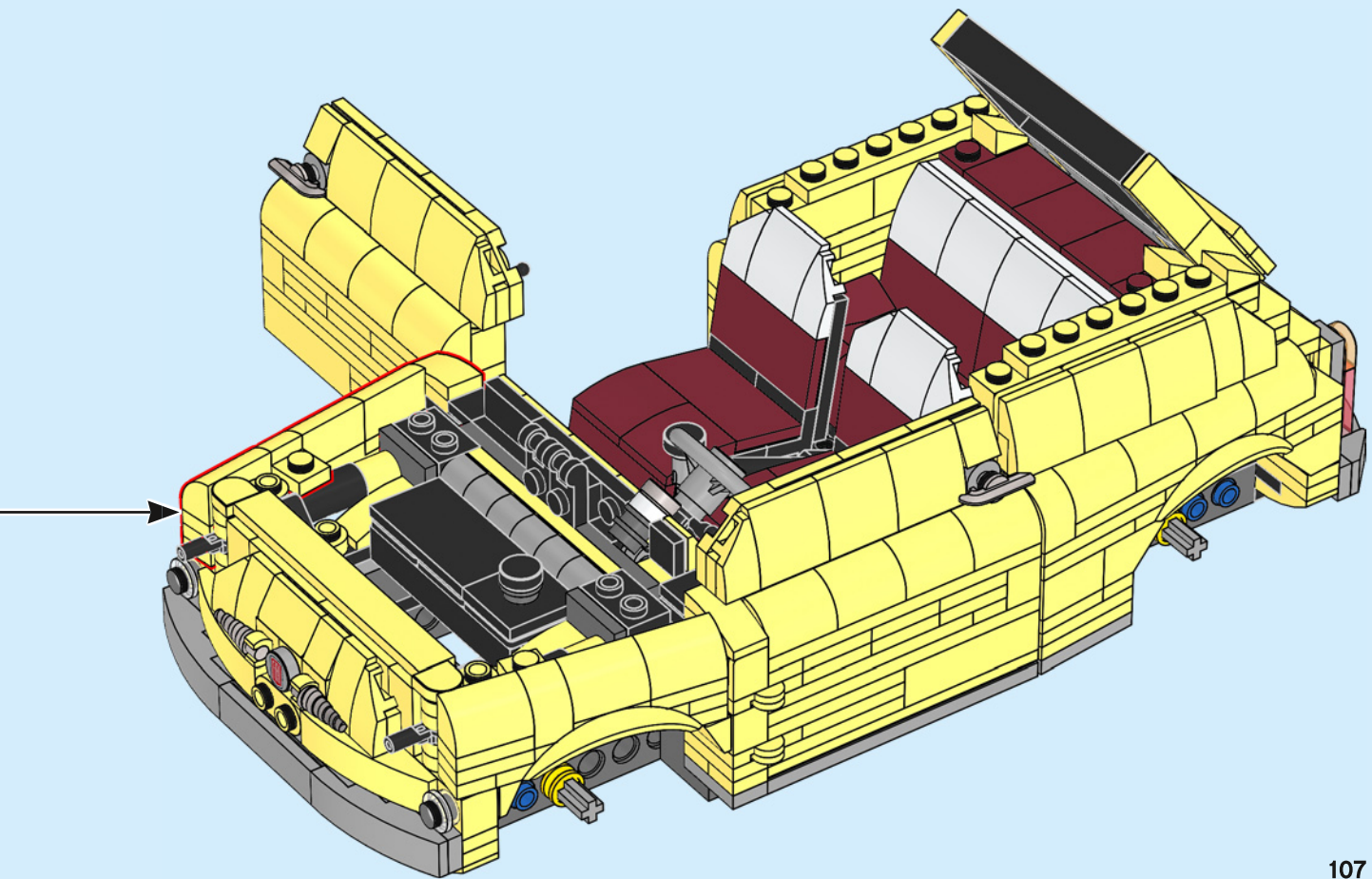

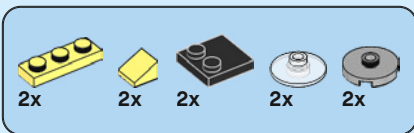

160

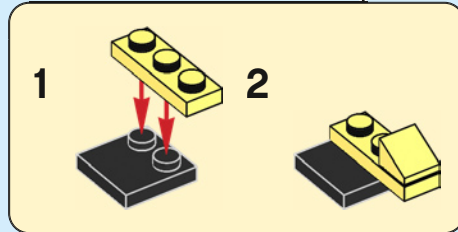
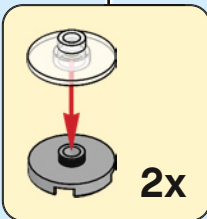
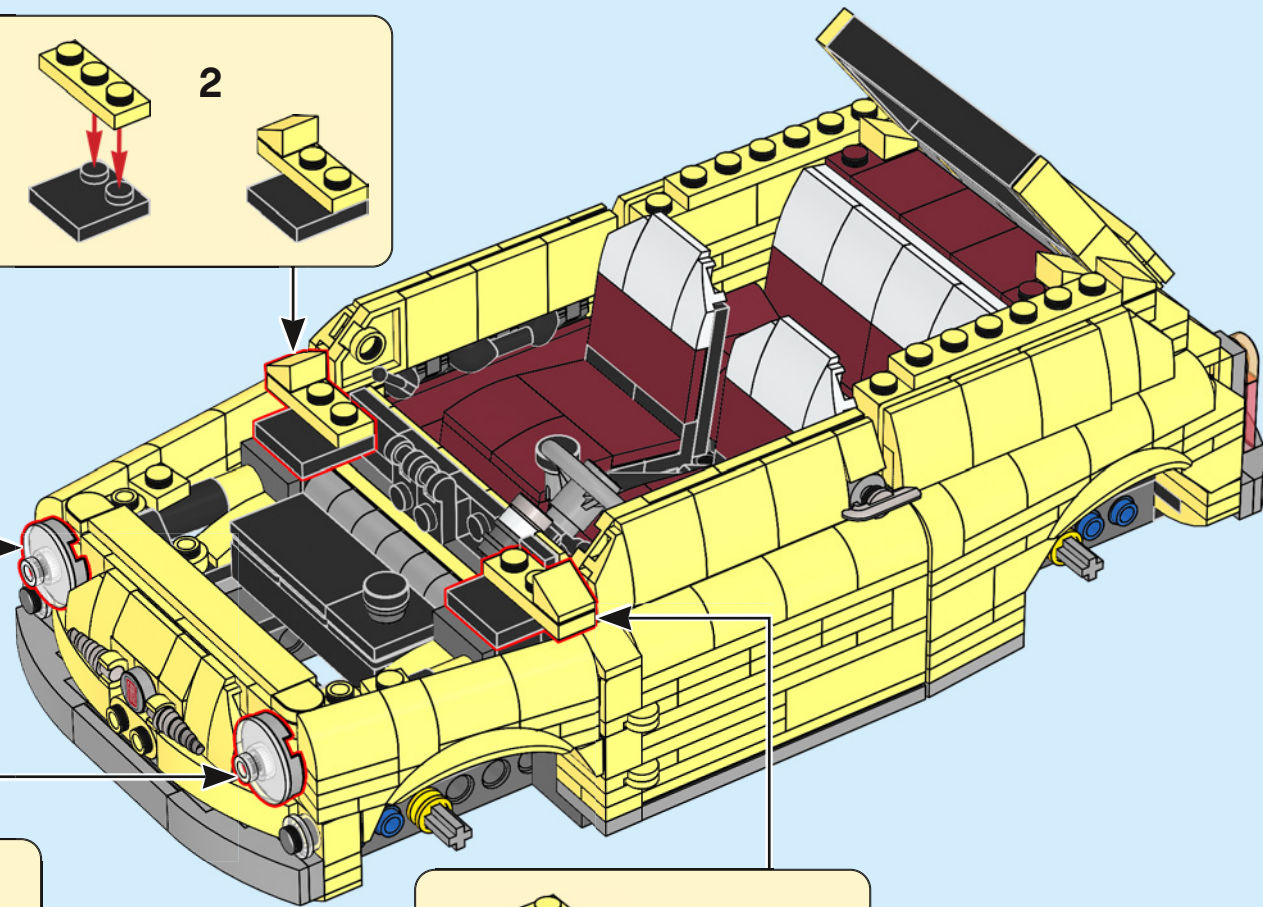
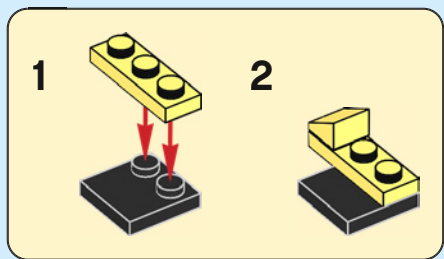

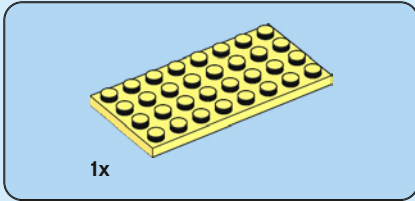
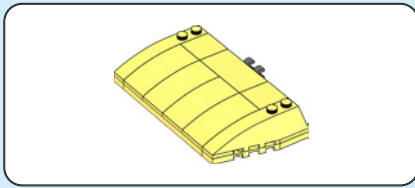

1x

161

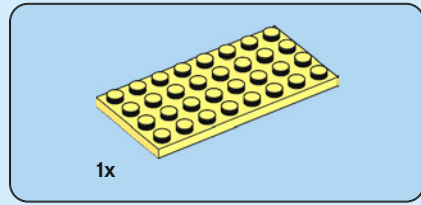
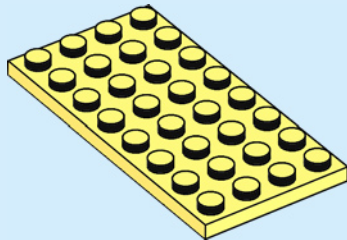

1x

162

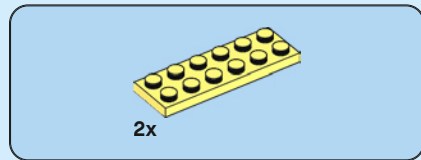
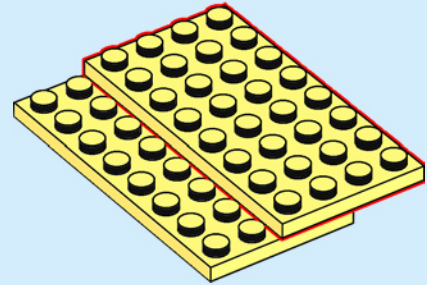

2x

163

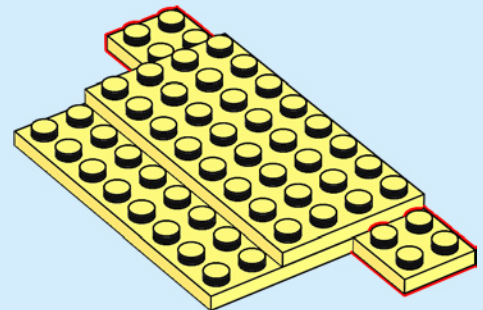

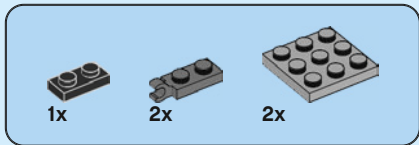

164

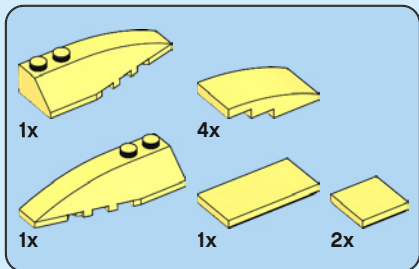
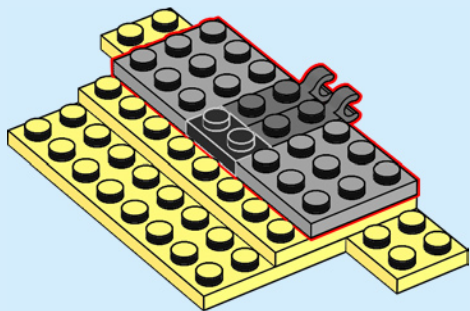

165

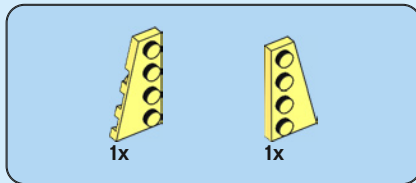
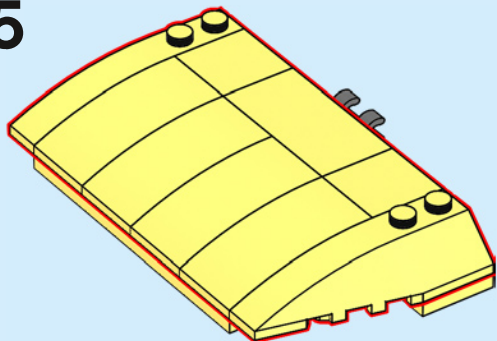

166

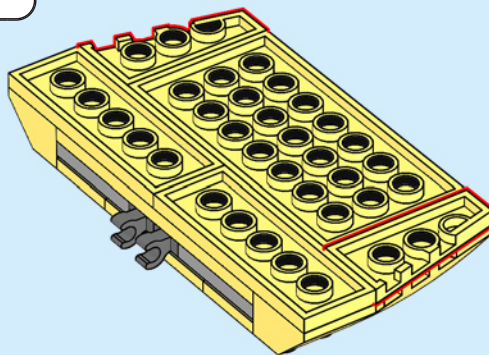

167

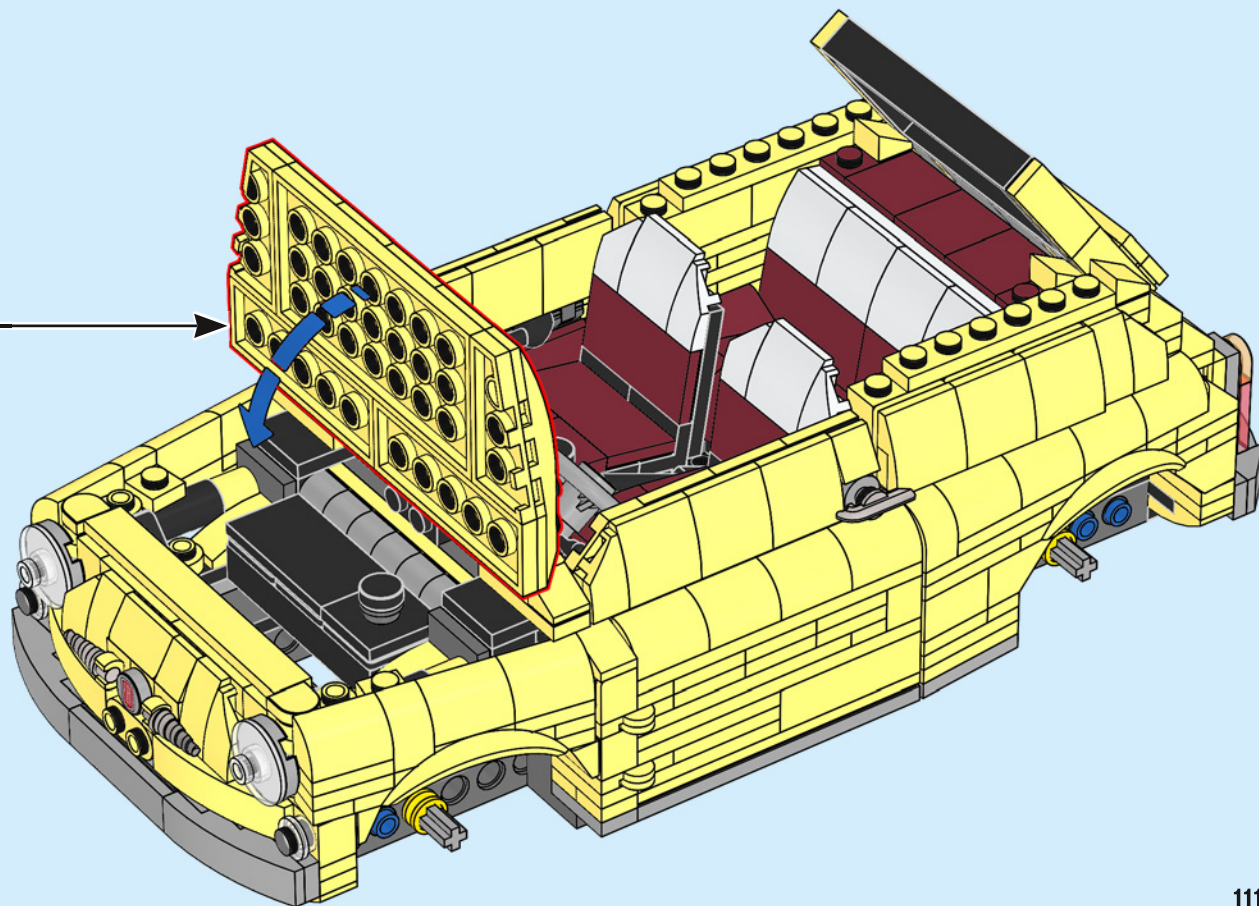

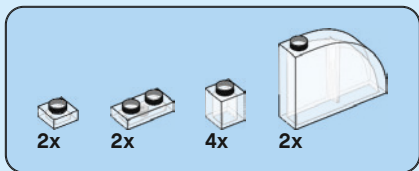

168

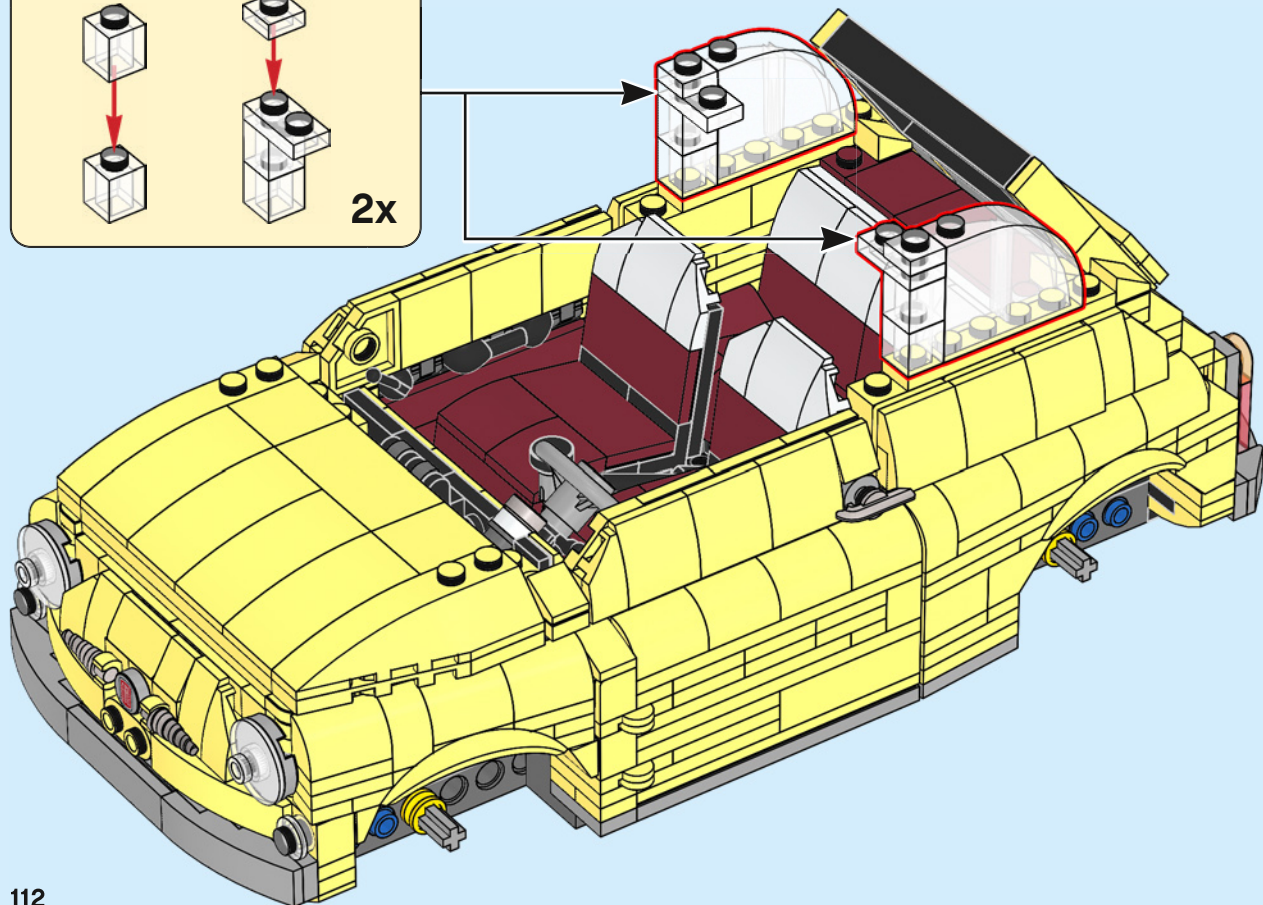
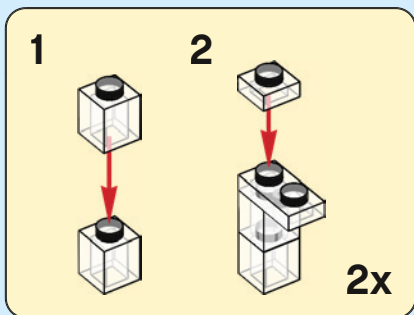

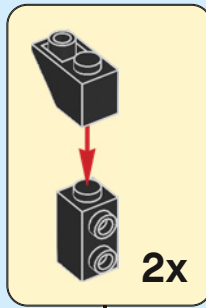
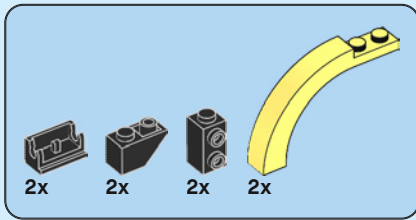

169

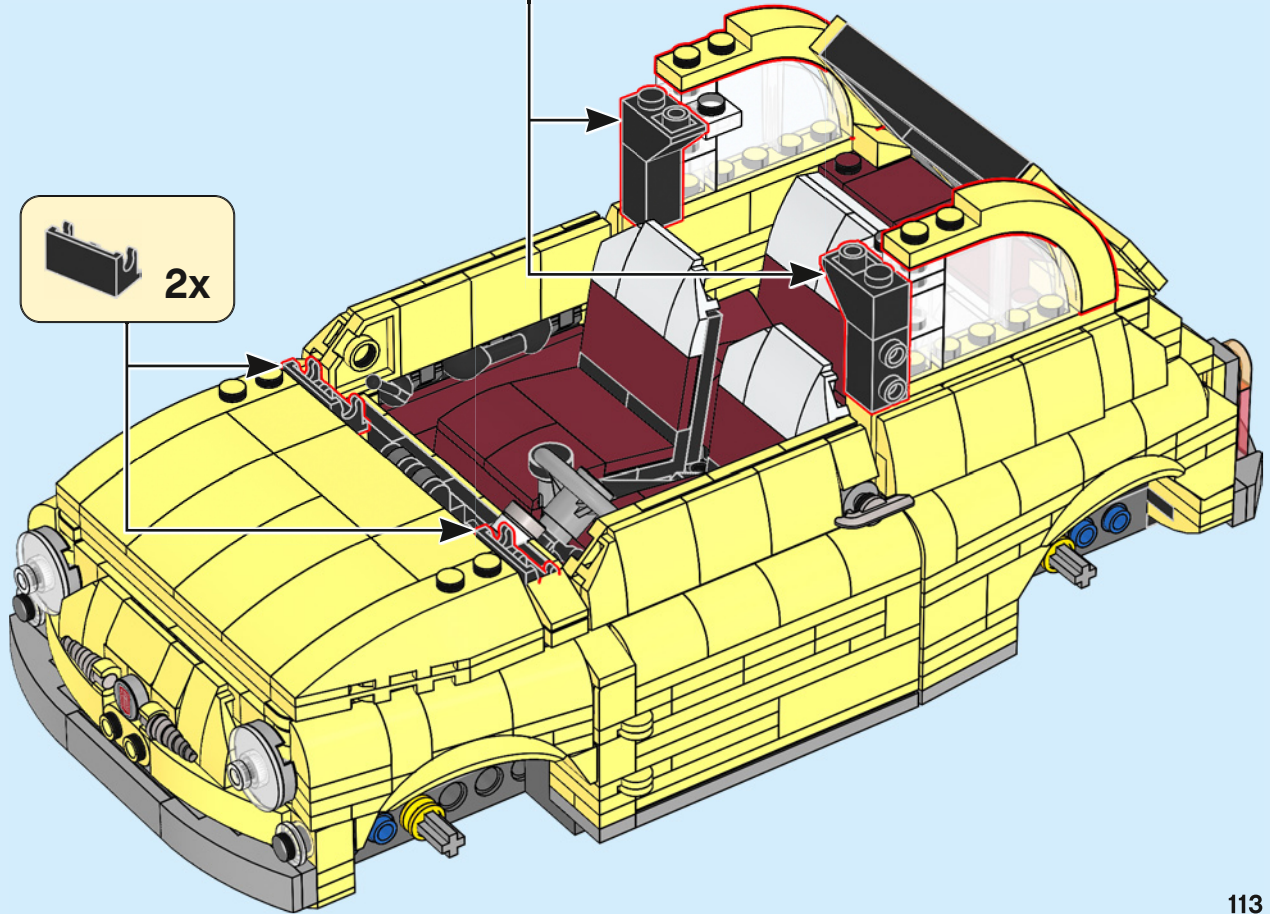

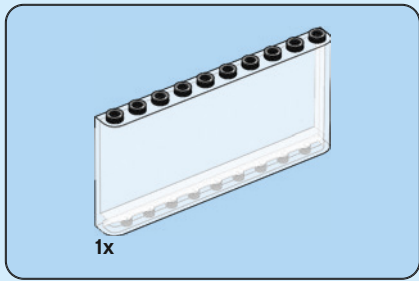

170

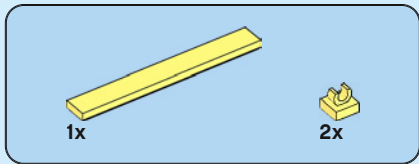
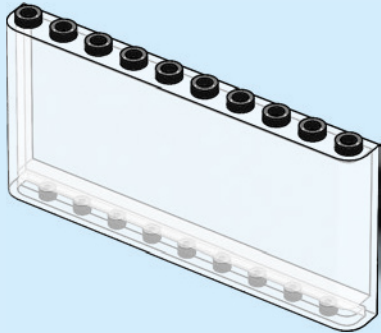

171

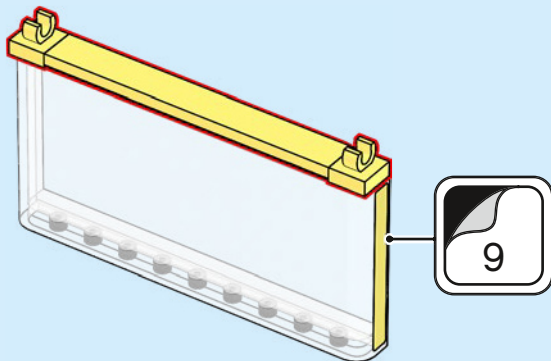

172

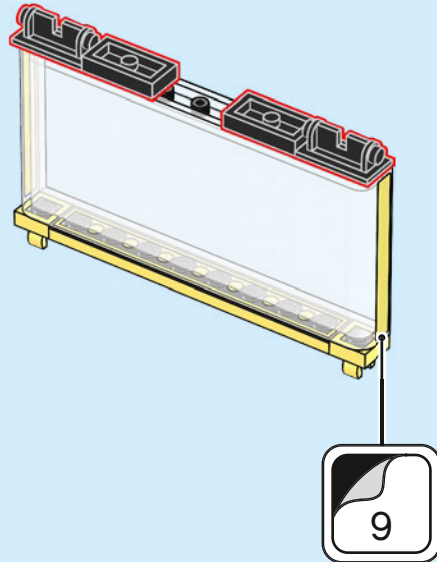

173

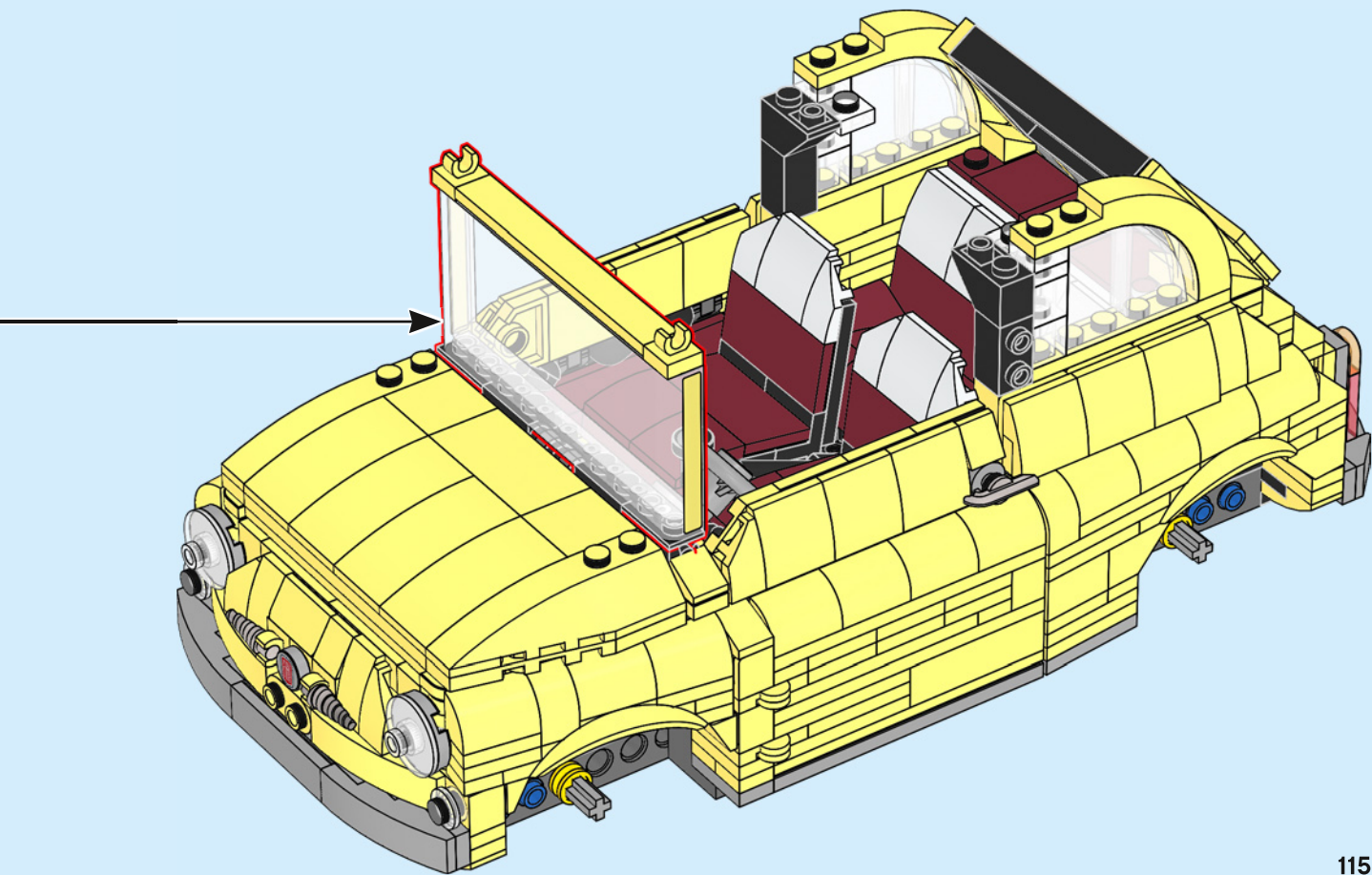

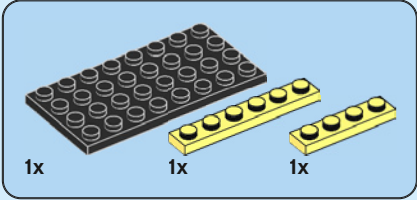
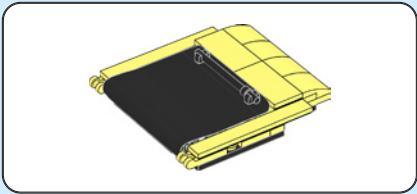

174

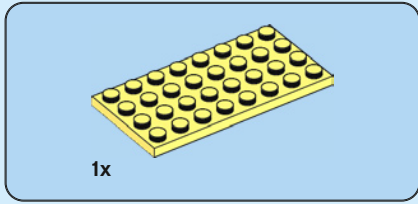
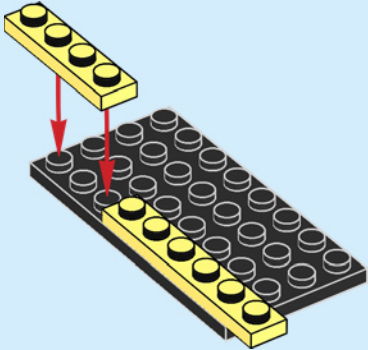

175

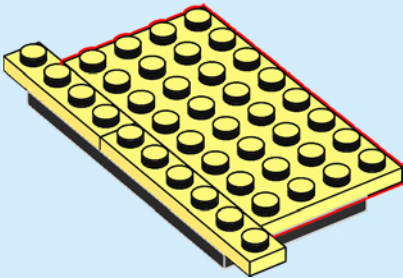

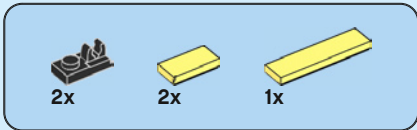

176

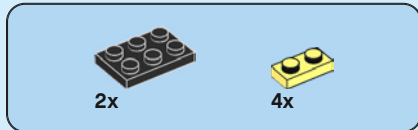
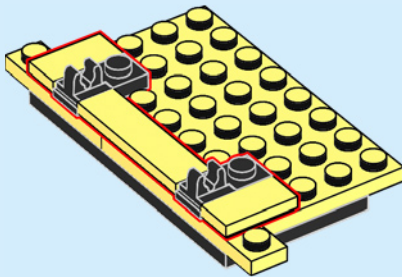

177

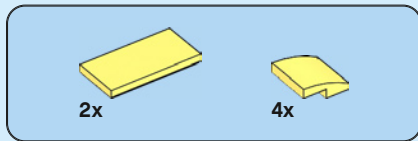
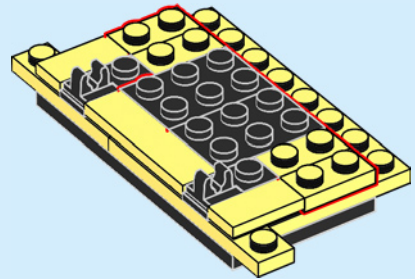

178

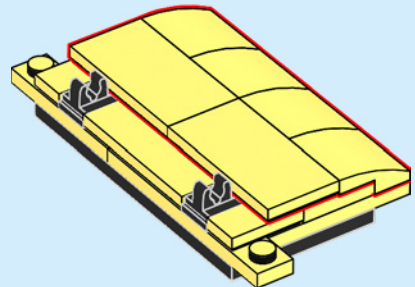

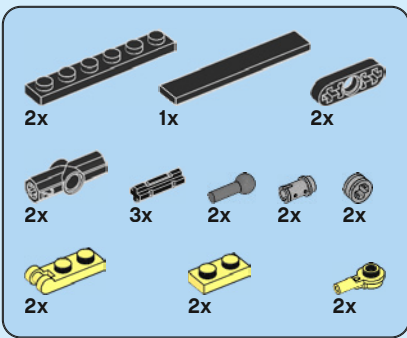

179

1

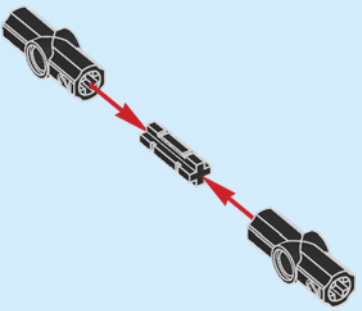

2

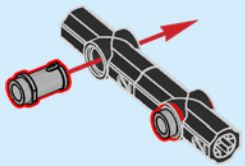

3

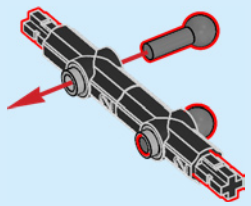

4

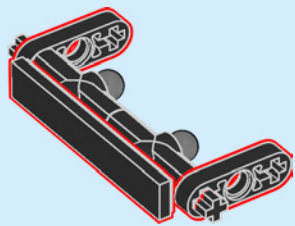

5

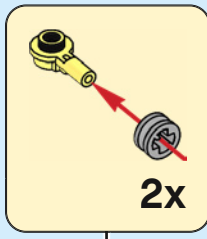
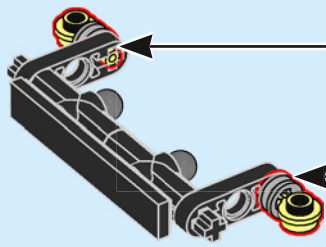

6

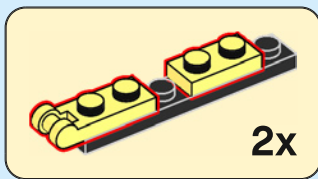
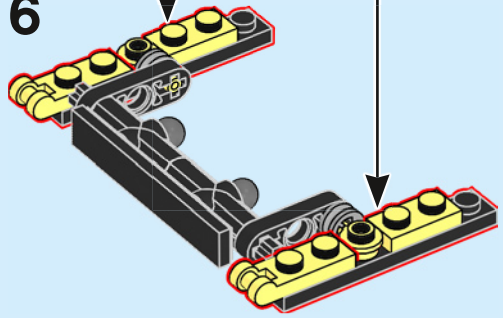

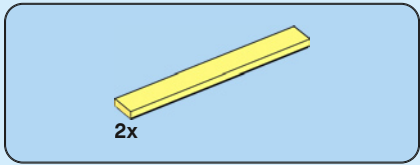

180

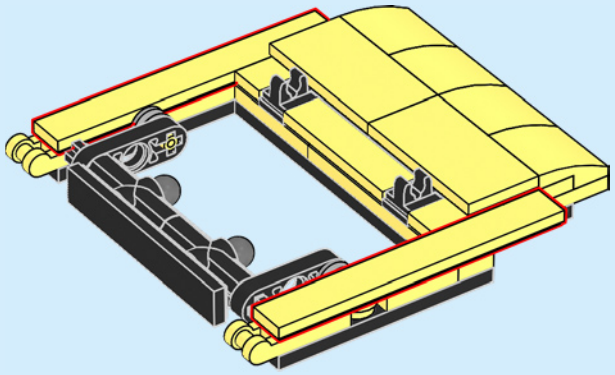
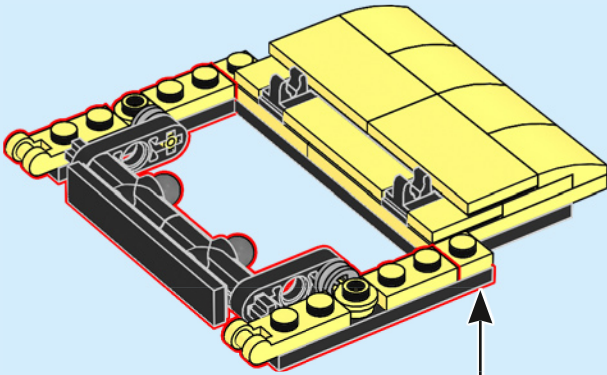

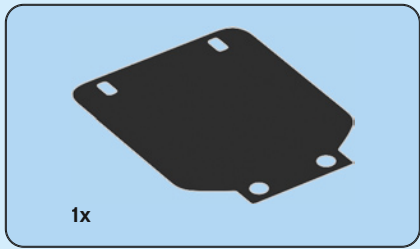

181

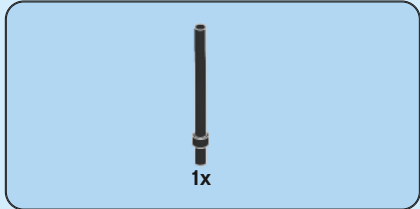
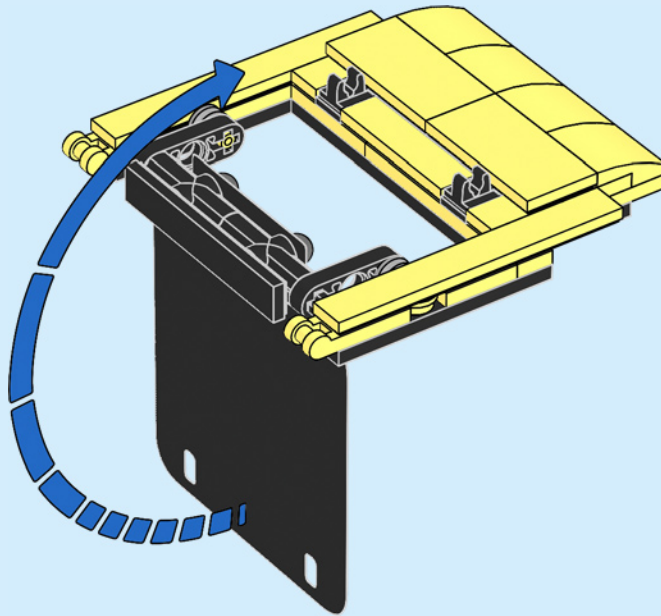

182

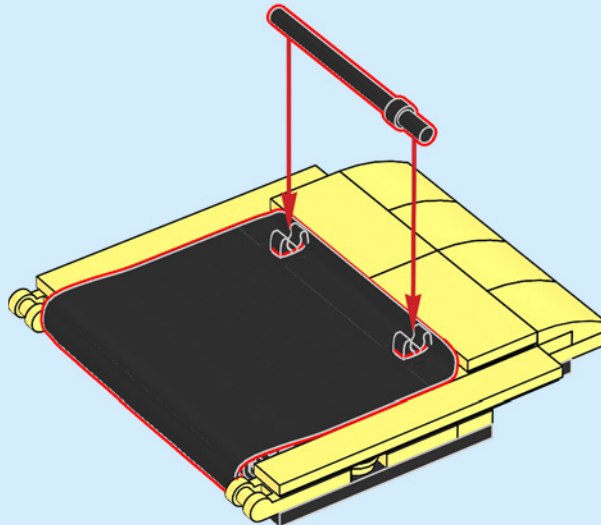

183

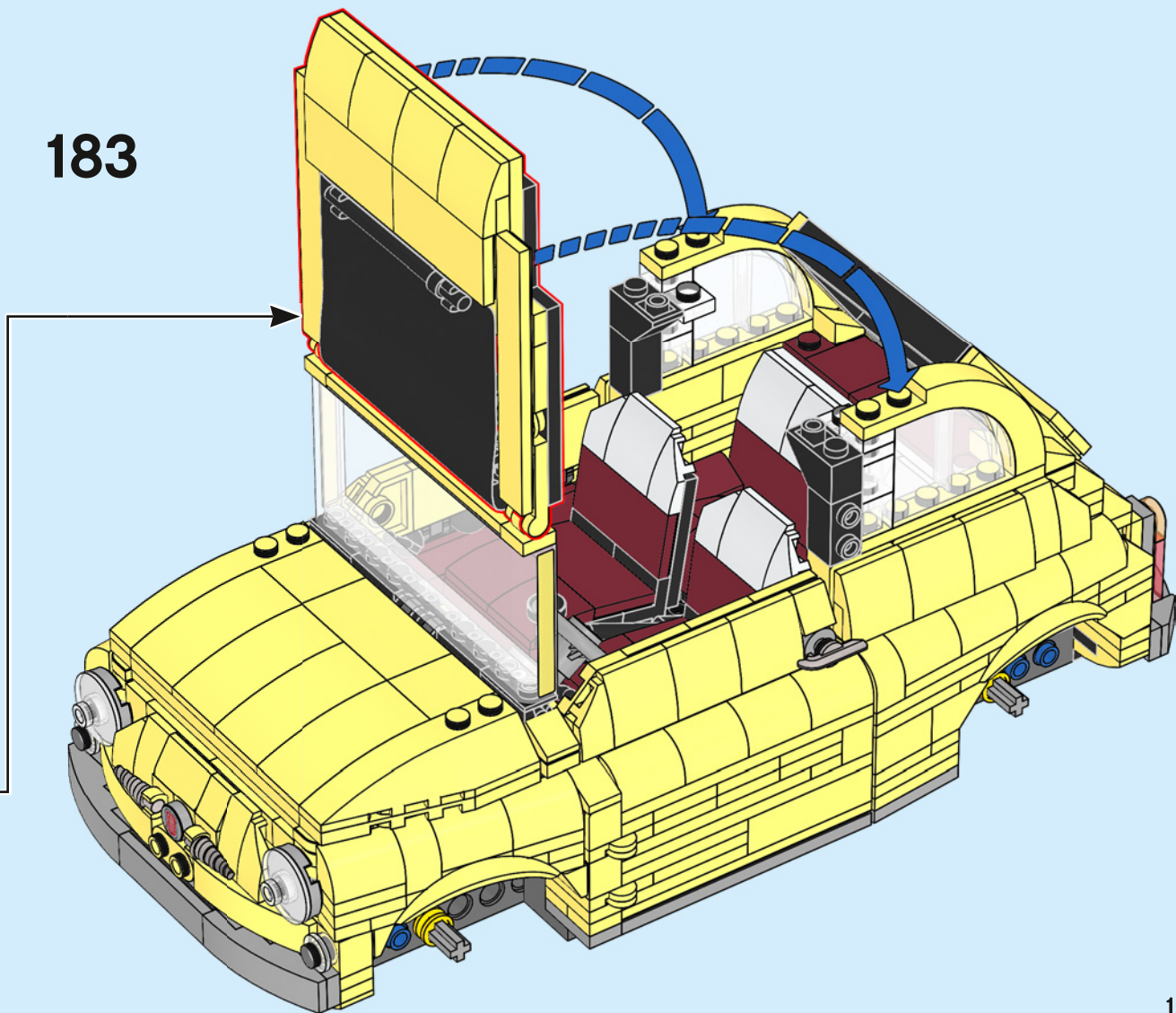

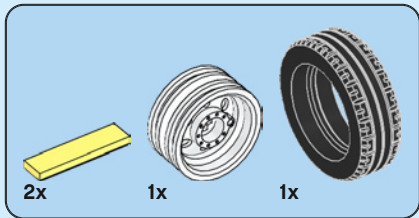

184

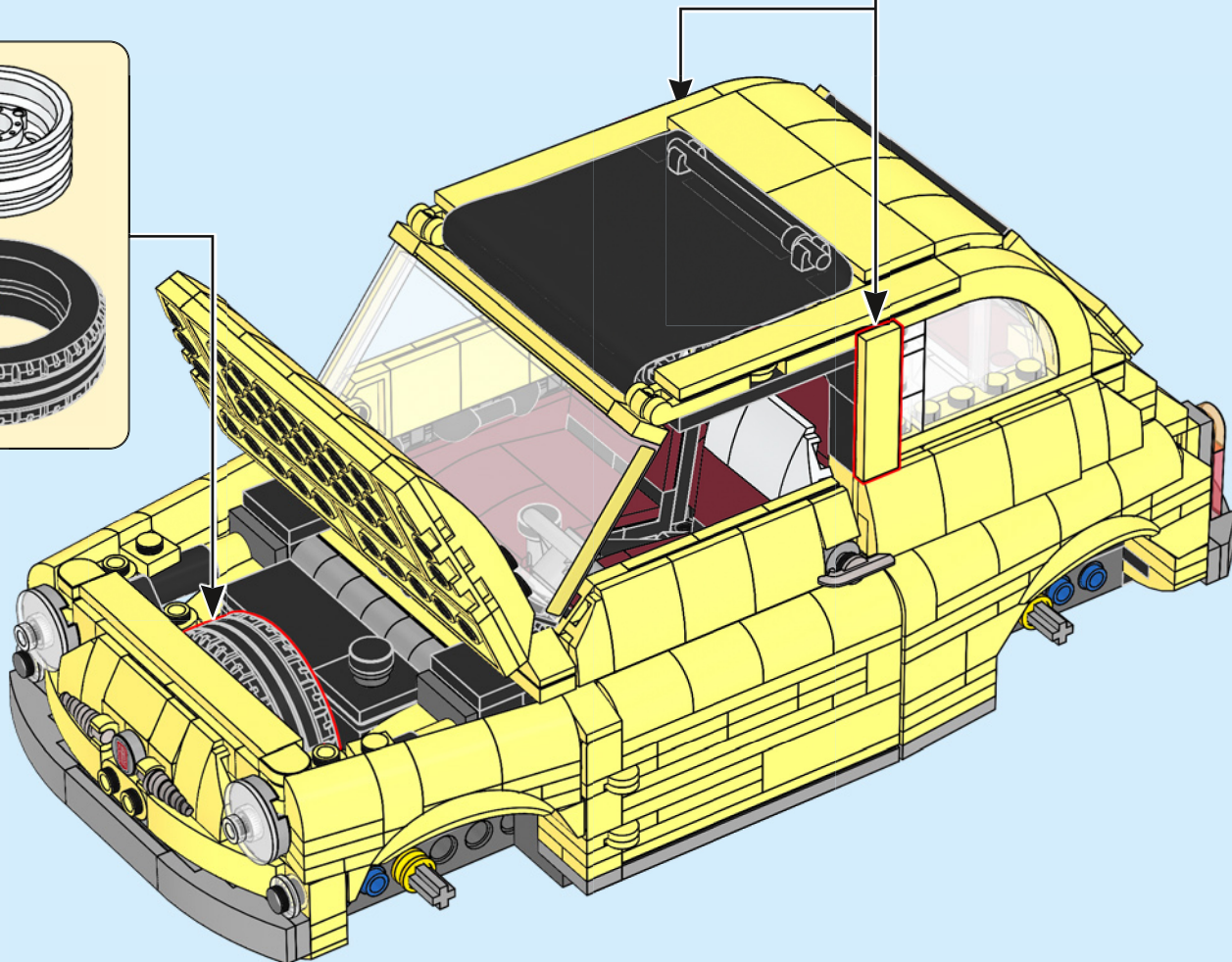
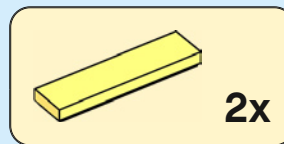
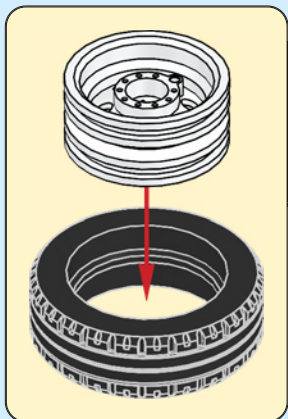

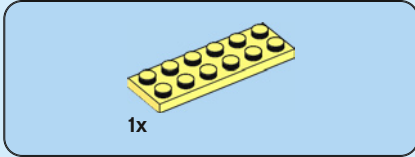
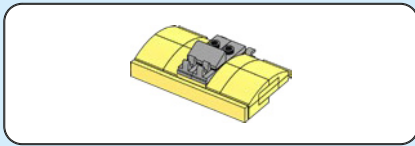

1x

185

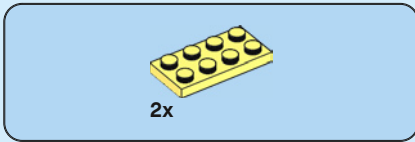
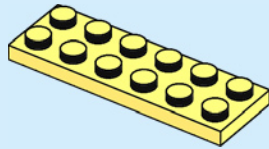

2x

186

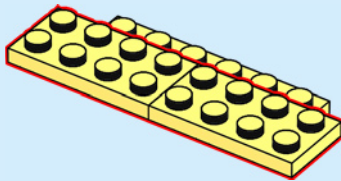

4x

187

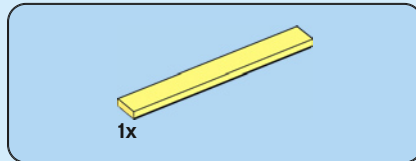
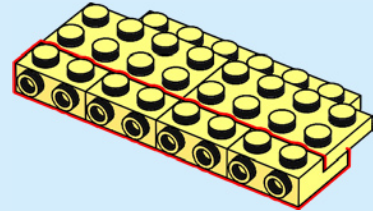

1x

188

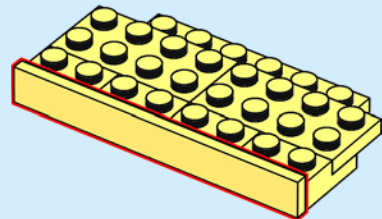

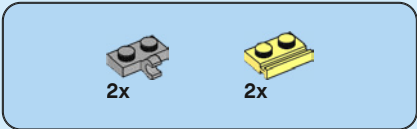

189

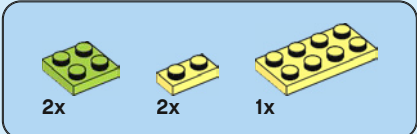
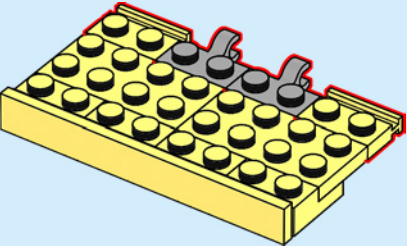

190

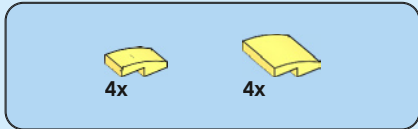
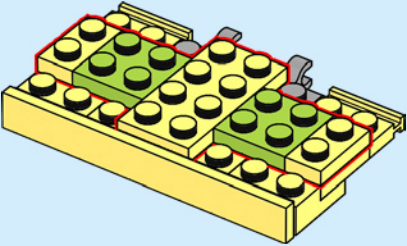

191

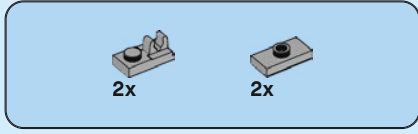
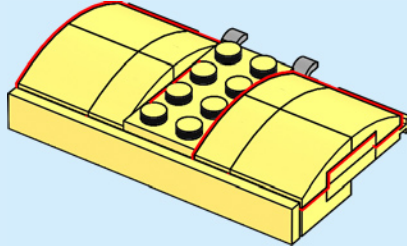

192

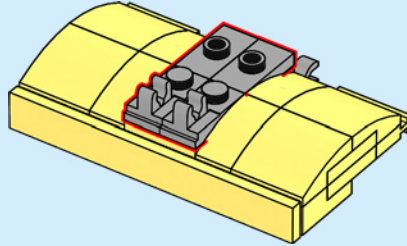

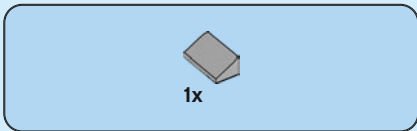

193

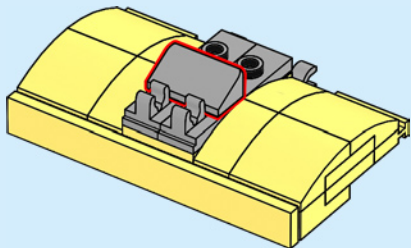

194

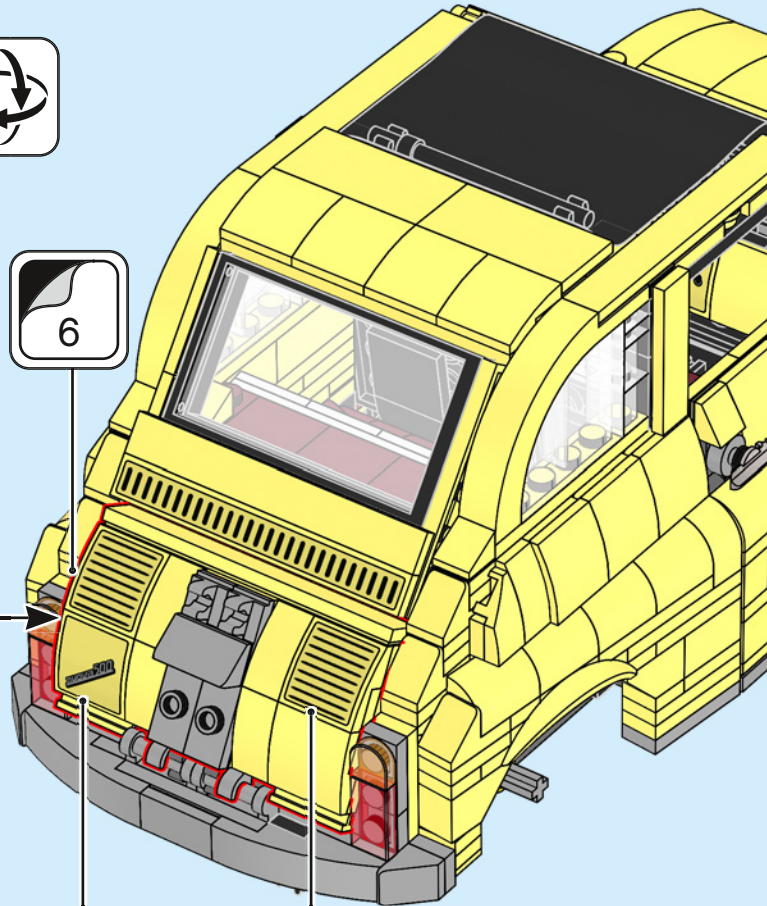

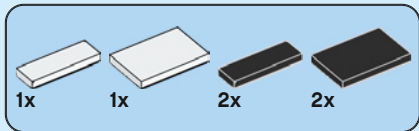

195

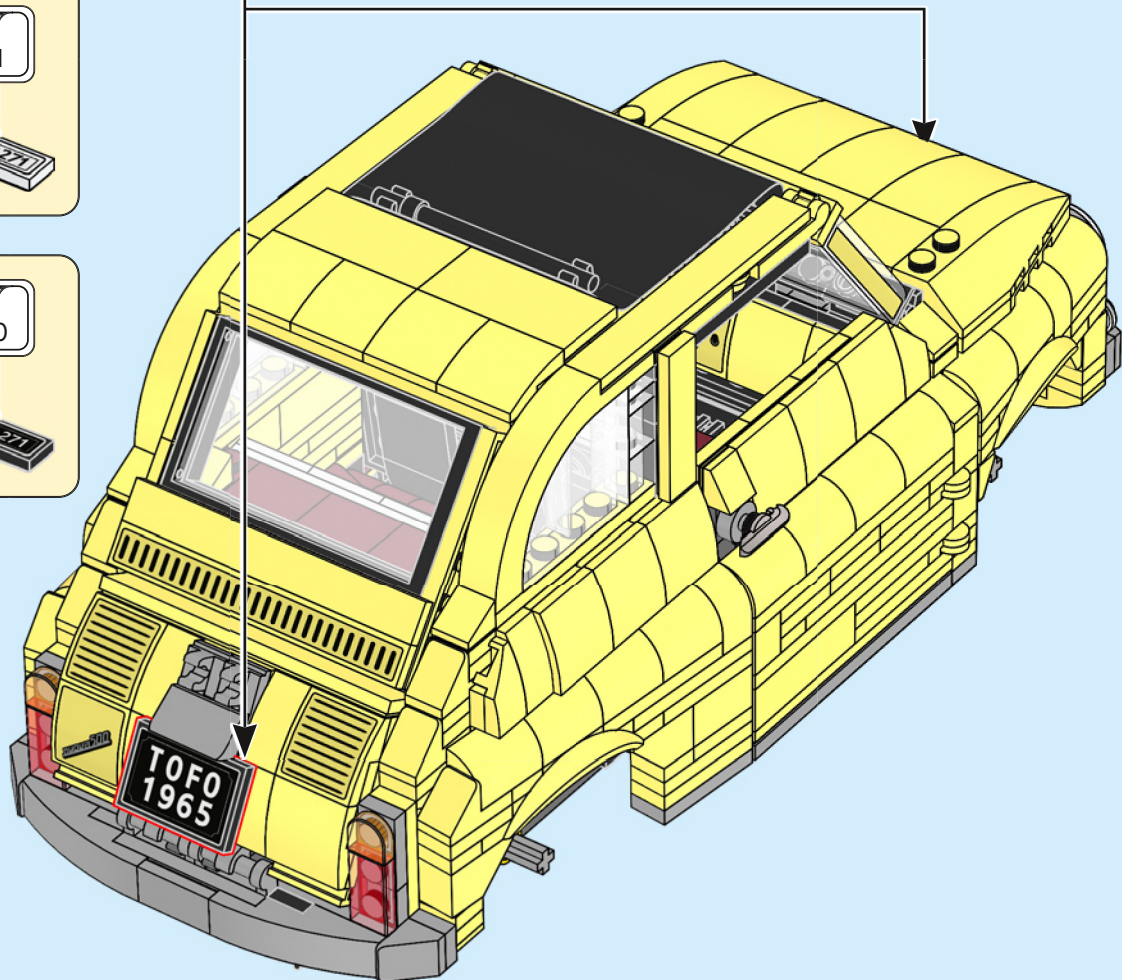
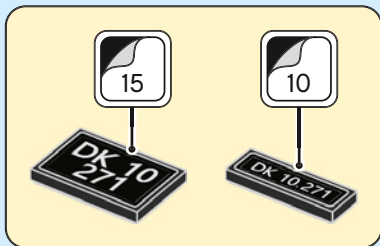
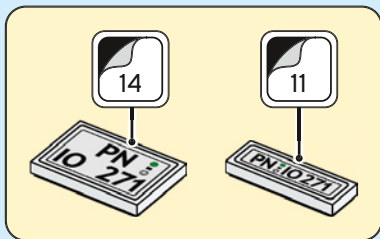
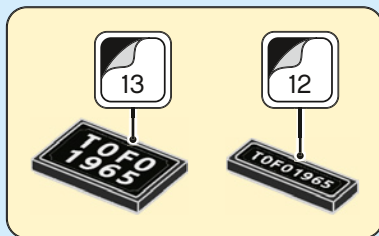

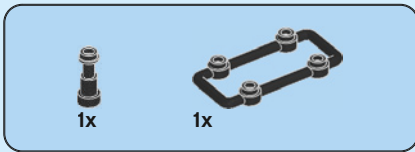

196

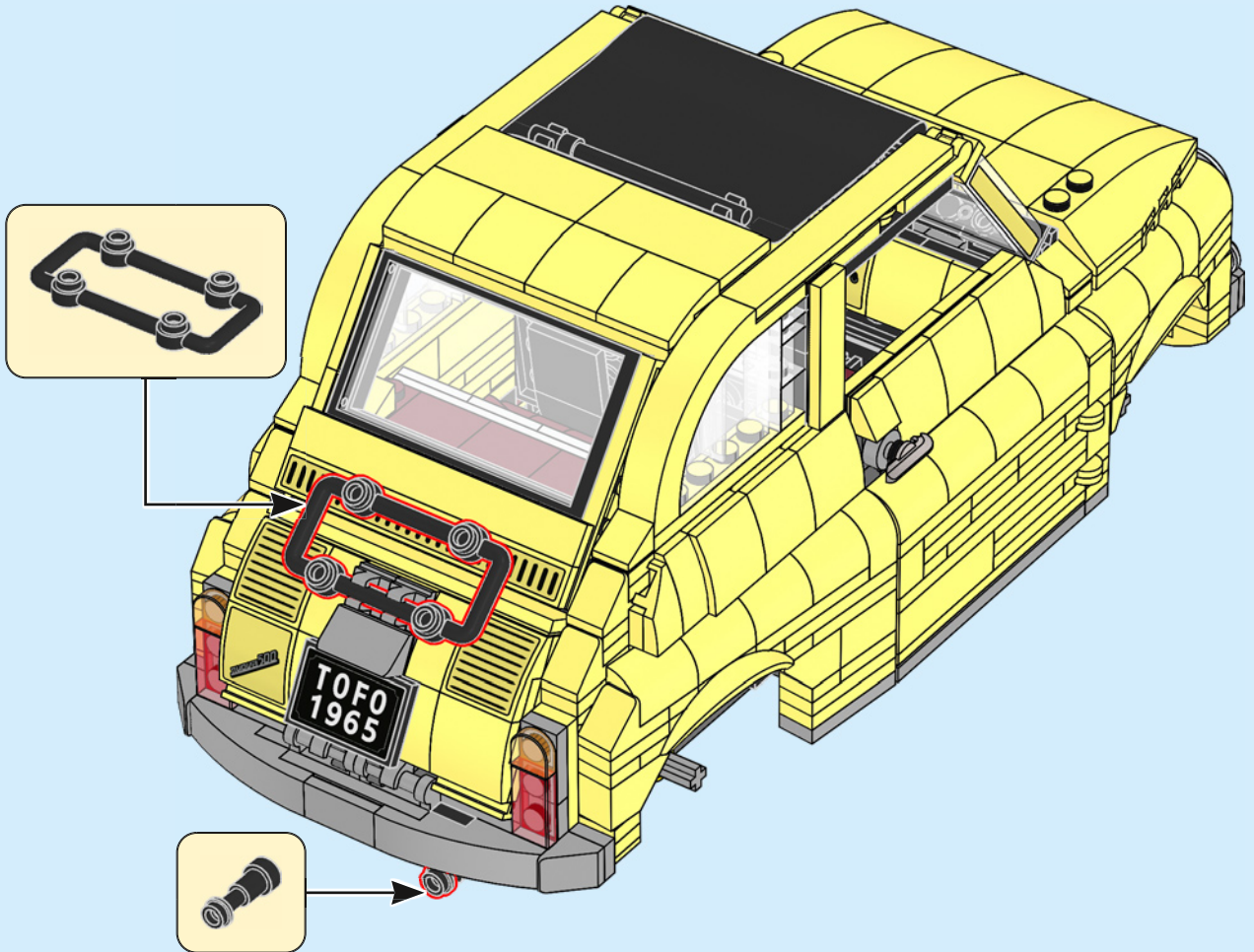



1x

197



1x

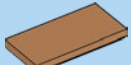

1x

198

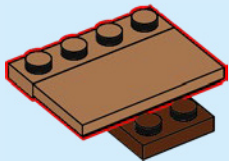

4x

199

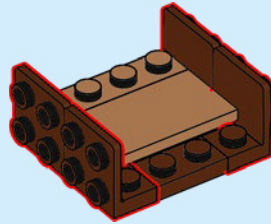

2x



1x



1x

200

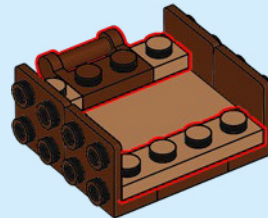

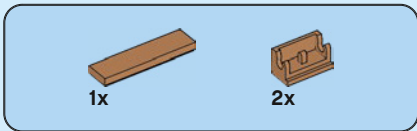

201

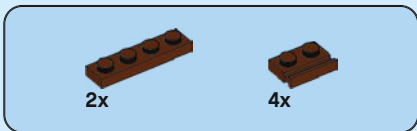
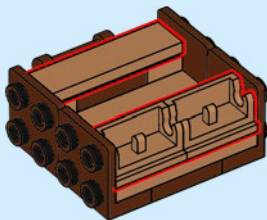

202

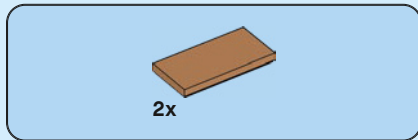
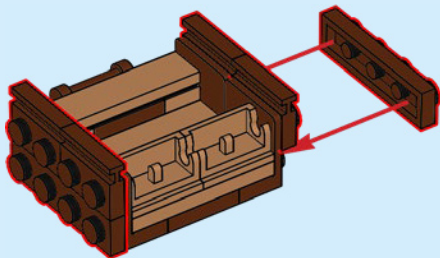

203

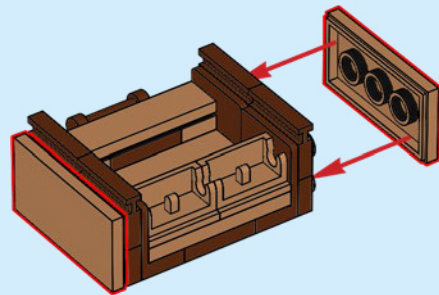

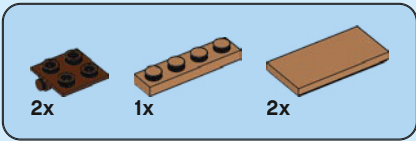

204

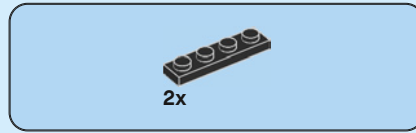
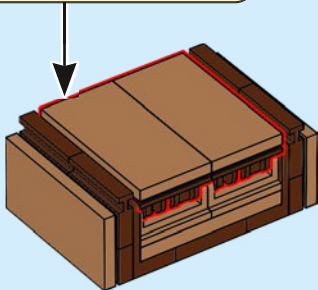
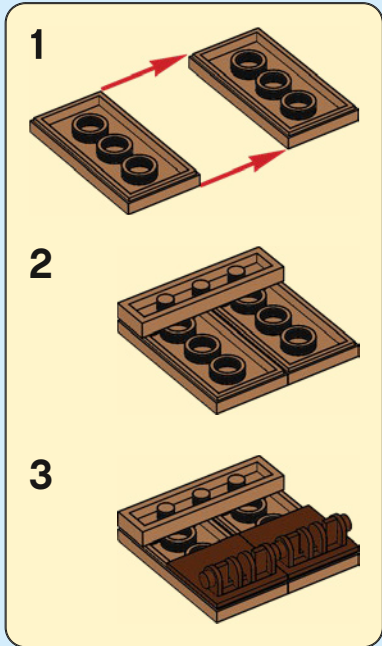

205

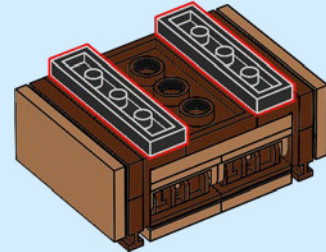

206

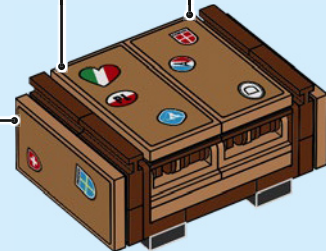

207

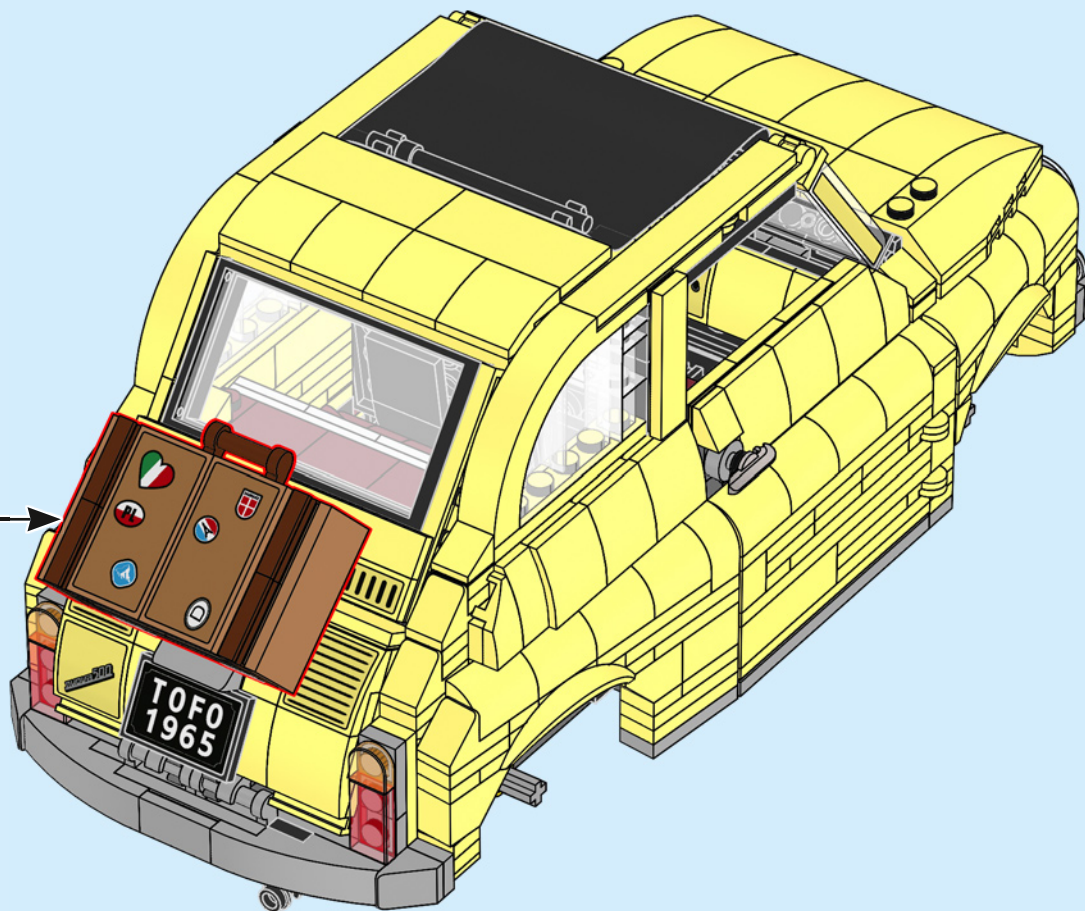

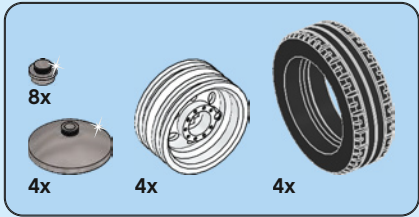

208

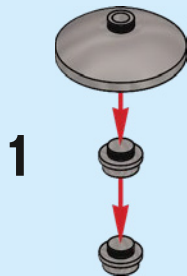

2



3

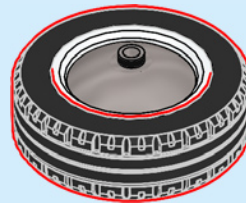

4x

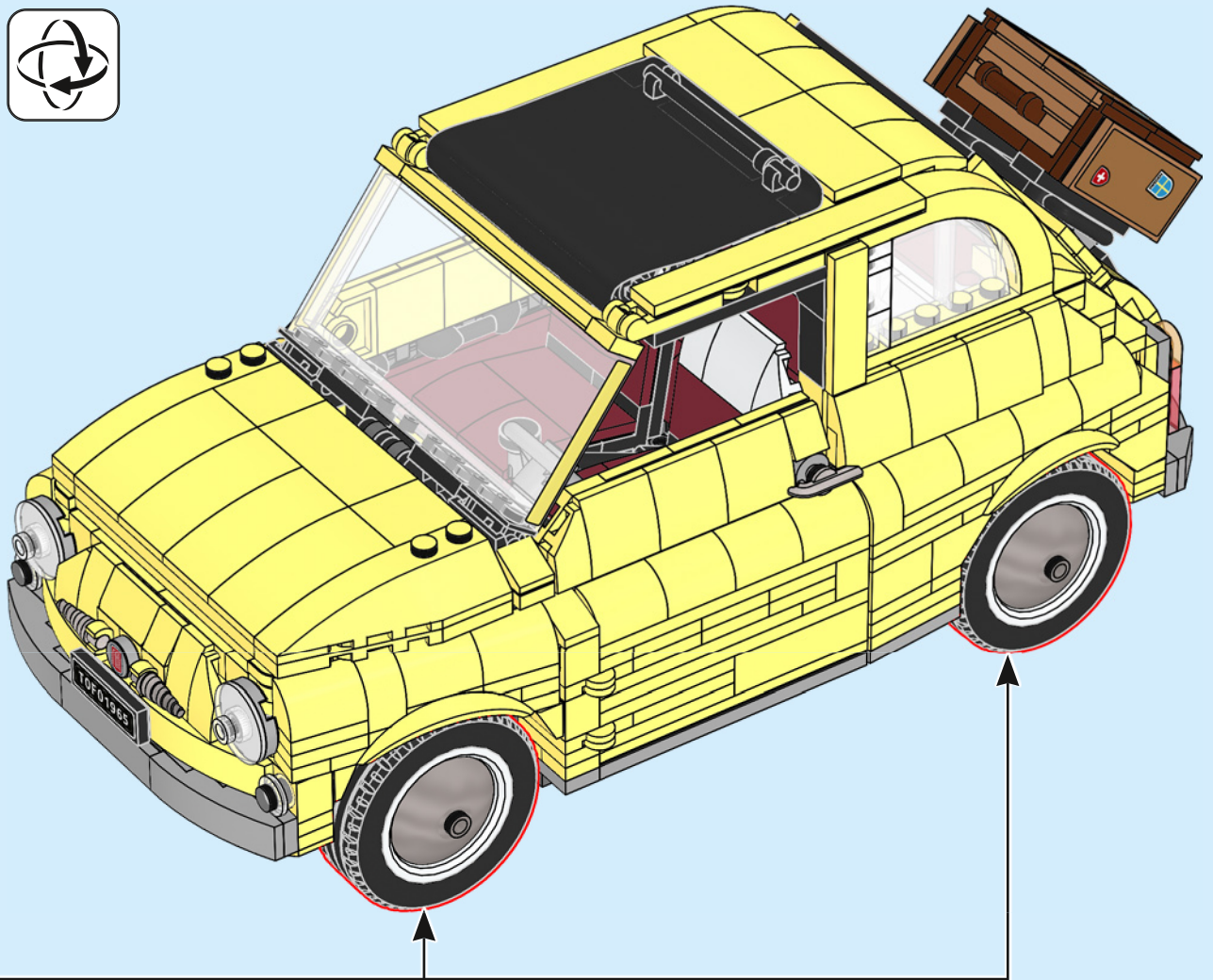

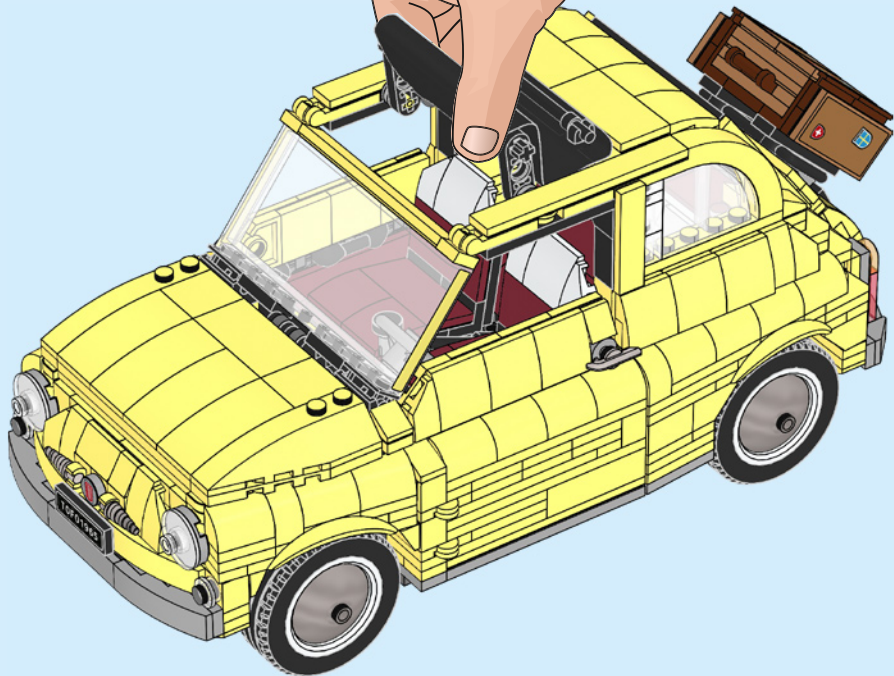

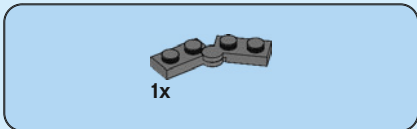

209

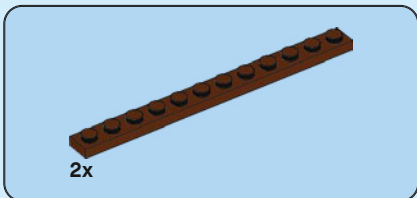
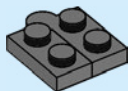

210

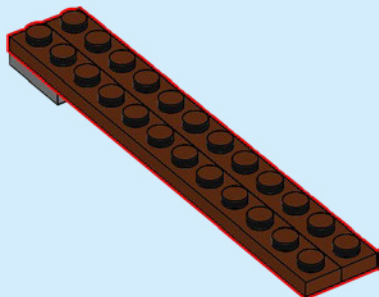

211

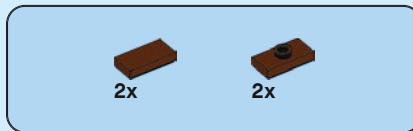
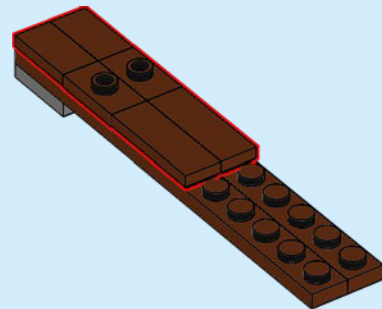

212

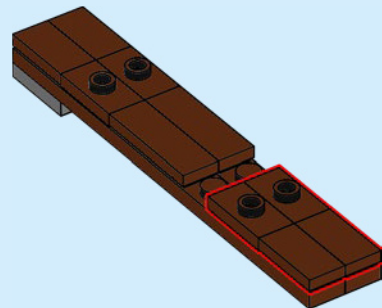

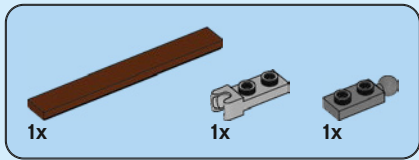

213

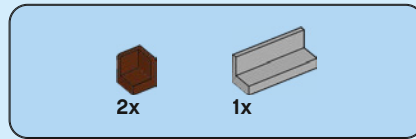
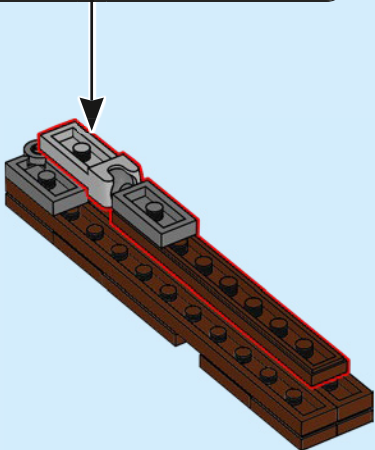
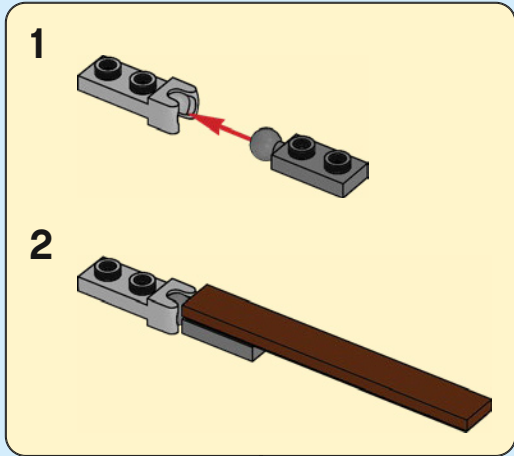

214

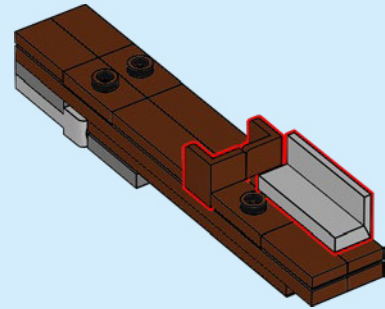

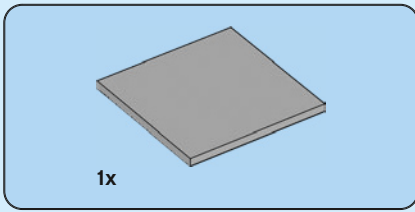

215

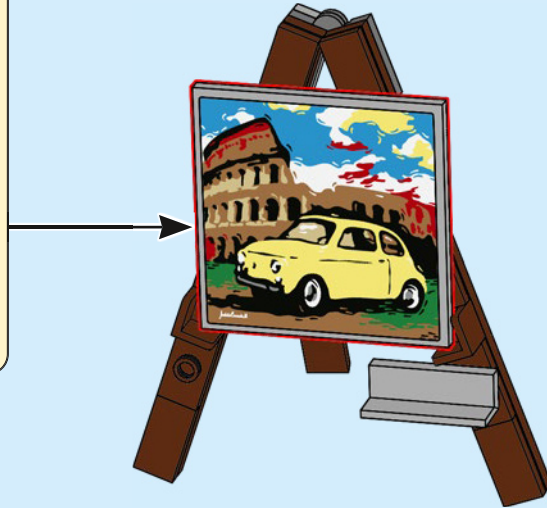
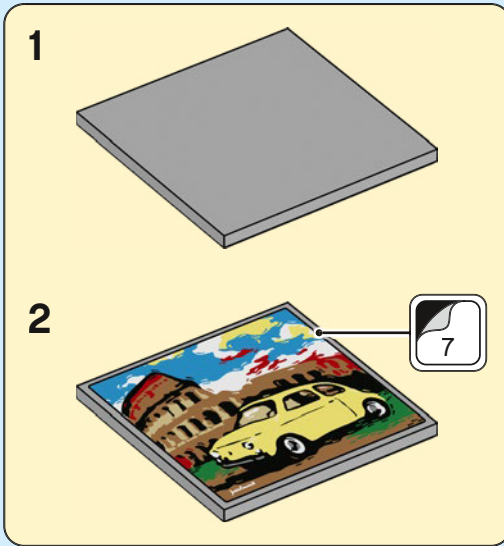



216

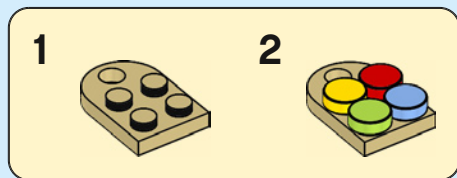

217

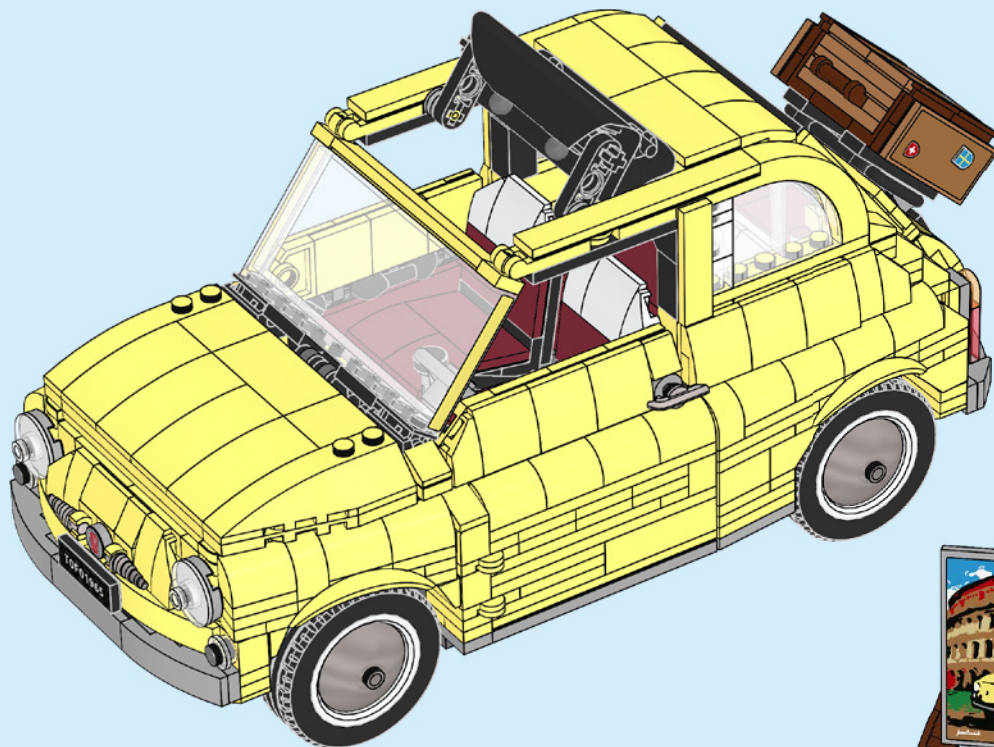

LEGO® Creator Expert – do you like it? Aimez-vous LEGO® Creator Expert ? LEGO® Creator Expert: ¿te gusta?



The LEGO Group would like your opinion on the new product you have just purchased. Your feedback will help shape the future development of this product series.

Please visit:

Le Groupe LEGO aimerait connaître votre opinion sur le produit que vous venez d'acheter. Vos commentaires nous aideront à concevoir les futurs produits de cette gamme.

Veuillez visiter :

The LEGO Group quiere conocer tu opinión acerca del nuevo producto que acabas de comprar. Tus comentarios nos ayudarán a dar forma a los futuros productos de esta serie.

Visita:

[LEGO.com/productfeedback](https://www.lego.com/productfeedback)

By completing our short feedback survey, you will be automatically entered into a drawing to win a LEGO® prize.

En remplissant ce court sondage sur le produit, vous serez automatiquement inscrit à un tirage au sort pour gagner un prix LEGO®.

Al contestar este breve cuestionario de opinión, participarás automáticamente en el sorteo de un producto LEGO®.

2x
6284572



2x
6213880



1x
6210272



2x
6213881



6x
6047220



1x
4558168



1x
6156667



5x
4539270



1x
303501



1x
6284574



1x
6215539



4x
6271820



1x
6092565



2x
6251290



1x
6170421



4x
73587



1x
4538456



2x
6143318



3x
6284070



1x
362626



3x
4504382



3x
307026



2x
6228987



1x
4184169



1x
6281993



1x
242026



5x
4515368



2x
6271869



2x
4558170



1x
4180508



2x
6173119



3x
4109810



8x
4121715



1x
6122656



7x
4598528



2x
6069000



8x
6092585



2x
6138173



5x
241226



4x
300426



2x
393826



4x
4121966



26x
362326



2x
6092570



4x
366526



7x
302326



2x
393726



3x
6000650



4x
6250020



1x
4107761



2x
6151289



2x
4107828



1x
6093525



1x
302226



2x
6211476



10x
6061032



2x
6013867



1x
4565323



2x
243126



3x
6196548



2x
6162892



4x
302126



1x
6288582



2x
4515362



1x
4535834



1x
6280168



5x
6182551



3x
302026



1x
4560182



1x
4560182



1x
4560182



1x
6172984



3x
6192346



2x
4243819



2x
6168620



3x
663626



2x
300926



4x
366626



3x
346026



1x
6037390



1x
611126



2x
303526



1x
383226



1x
6296972



3x
4550017



2x
371026



2x
6240030



4x
6220959



2x
6252041



2x
6245306



2x
6240204



1x
6256058



2x
6288587



1x
6288588



1x
6289133



1x
6240515



1x
6240515

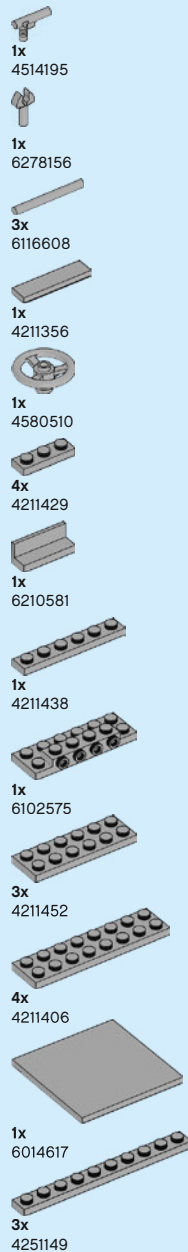

2x 4211090
 3x 4210633
 3x 6071226
 2x 6225494
 2x 6158469
 6x 4210892
 2x 4211111
 3x 4581225
 1x 6123814
 2x 6247784
 6x 4210884
 6x 4211043
 1x 4211106
 6x 4210963

2x 6249116
 1x 6124611
 1x 6284577
 8x 6271167
 4x 6250598
 35x 6058014
 9x 6296498
 3x 6296500
 7x 6022084
 2x 6296526
 4x 6296531
 4x 6228969
 18x 6296501
 2x 6296963
 3x 6296509
 1x 6296528

1x 6296533
 5x 6296510
 2x 6296512
 2x 6296513
 12x 6147726
 4x 6061201
 4x 6070301
 2x 6298528
 22x 6296494
 6x 6296495
 7x 6296507
 2x 6022083
 2x 6117317

4x 6133822
 35x 6201647
 6x 6296497
 6x 6296485
 6x 6296496
 2x 6296519
 6x 6298527
 20x 6296487
 6x 6296511
 2x 6286832
 4x 6296521
 2x 6296964
 4x 6201646
 13x 6296492

2x 6195265
 2x 6036232
 2x 6296493
 17x 6248756
 3x 6289722
 2x 6296536
 8x 6296491
 4x 6296523
 5x 6296524
 3x 6210674
 2x 6289285

4x 6296535
 12x 6211356
 4x 6296488
 1x 6296527
 4x 6175294
 1x 6296525
 9x 6296504
 10x 6248761
 3x 6213270

1x 6209691
 2x 6215606
 2x 6167642
 4x 6259768
 1x 6167698
 1x 6102998
 3x 6167700
 5x 6218359
 1x 6170776
 2x 4569058
 1x 6057878
 4x 4537937



Customer Service
 Kundenservice
 Service Consommateurs
 Servicio Al Consumidor
 LEGO.com/service or dial

 : 00800 5346 5555
 : 1-800-422-5346

