

S·P·Q·R·

KOLOSSEUM

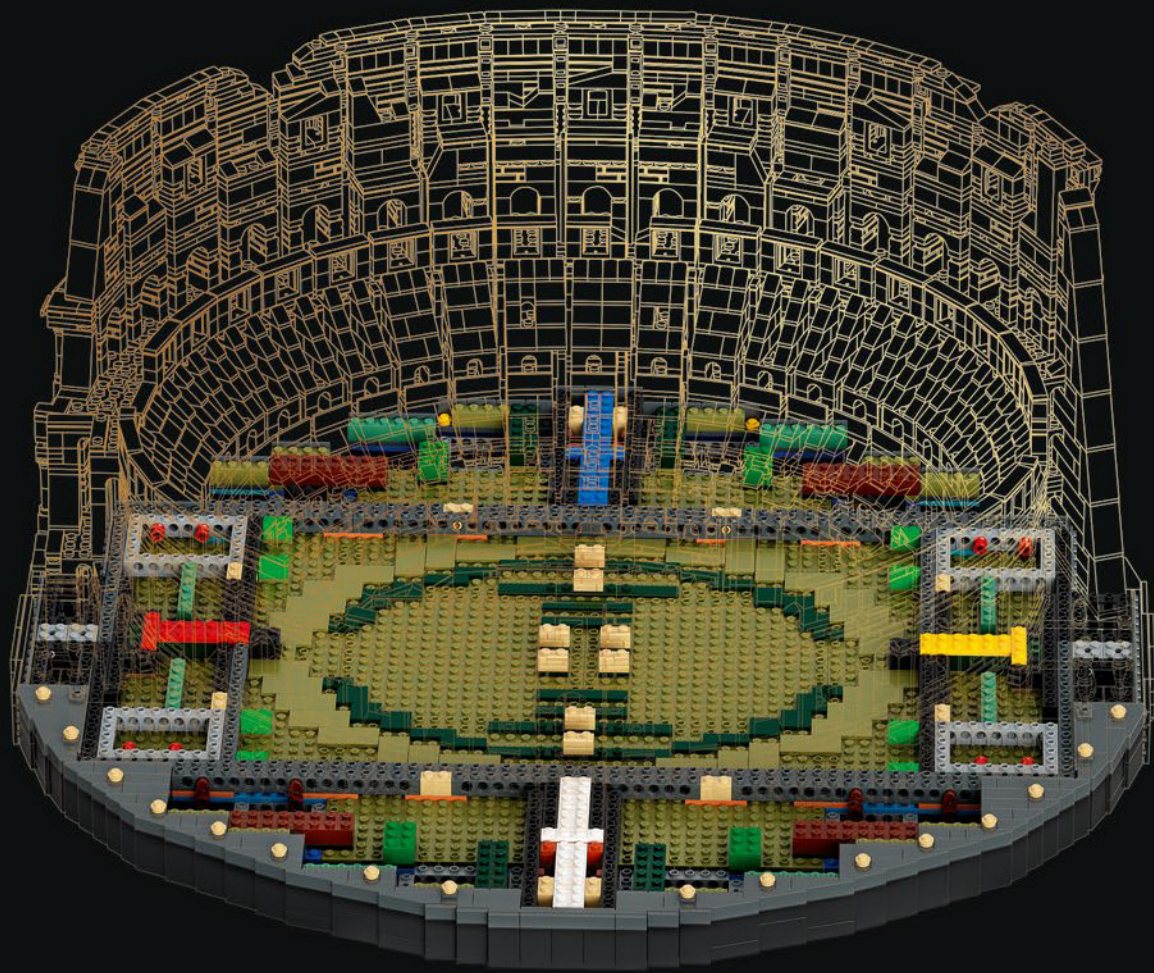

I

HERZLICH WILLKOMMEN

Das ist unsere Interpretation des berühmten Kolosseums in Rom. Vielleicht ruft dir das Set eine Reise nach Rom in Erinnerung? Vielleicht weckt das Modell das Interesse an klassischer Architektur in dir? Möglicherweise kannst du beim Bauen auch einfach nur gut abschalten? Hauptsache, das Modell bereitet dir viele Stunden LEGO® Bauvergnügen.

Jamie Berard, Leitender Designer

DAS KOLOSSEUM

Das Kolosseum steht im Herzen der italienischen Hauptstadt. Das bekannte Wahrzeichen der Stadt erinnert auch an das römische Kaiserreich. Dieses imposante Amphitheater war damals das größte seiner Art und fasste zwischen 50.000 und 80.000 Zuschauer. Sie versammelten sich dort, um sich Gladiatorenkämpfe, Tierjagden und sogar nachgestellte Seeschlachten anzuschauen. Das Bauwerk gilt als eines der 7 Weltwunder der Neuzeit und zählt mit mehr als 7 Millionen Besuchern im Jahr zu den beliebtesten Touristenattraktionen der Welt.





Frühere griechische Theater wurden an Hänge gebaut. Doch das Kolosseum ragt vom flachen Talboden in der Mitte von Rom empor.

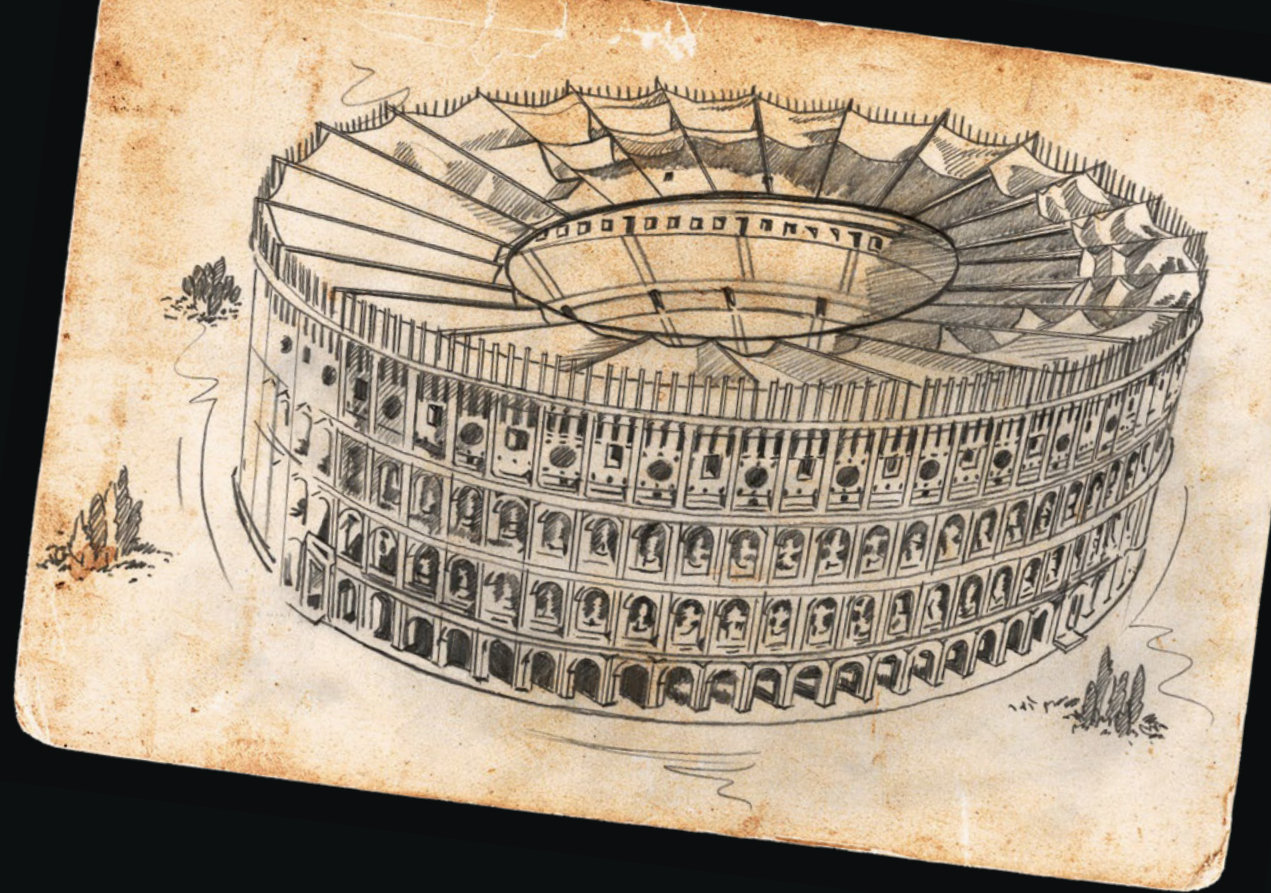

AMPHITHEATER

Das Kolosseum ist ein freistehendes ellipsenförmiges Bauwerk mit einer Länge von 189 Metern und einer Breite von 156 Metern. Die ovale Arena im Inneren ist 87 Meter lang und 55 Meter breit und von einer imposanten 5 Meter hohen Wand umgeben. Darüber reihten sich die Sitze. Die beeindruckende Fassade ragt bis auf eine Höhe von 48 Metern empor. Mit dem Sonnensegel (Velarium), das mit Tauen zwischen senkrechten Holzmasten aufgespannt wurde, war das Kolosseum sogar noch höher.



Im Erdgeschoss führten 80 rund um die Arena verteilte Eingänge ins Gebäude. Die 4 Haupteingänge waren dem Kaiser und den Eliten der Stadt vorbehalten und reich verziert.

DAS BAUWERK

Mehr als 100.000 Kubikmeter Travertin wurden im Kolosseum verbaut. Allein 45.000 Kubikmeter Travertin wurden für die Außenmauern verwendet. Mehr als 300 Tonnen Eisenklammern hielten die Steine zusammen. Mörtel wurde nicht verwendet. Die Außenfassade des Bauwerks besteht aus 3 markanten Ebenen mit jeweils 80 imposanten Arkaden. Unter dem sandbedeckten Holzboden der Arena verbarg sich ein komplexes Kellersystem, das sogenannte *Hypogeum*.



HYPOGEUM

Das *Hypogeum* war ein zweigeschossiges unterirdisches Netz von Tunneln und Käfigen, das nach Vollendung des ursprünglichen Kolosseums hinzugefügt wurde. Dort waren die Gladiatoren und Tiere vor den Kämpfen eingesperrt. Wegen dieser Unterkellerung konnte die Arena nicht mehr für nachgestellte Seeschlachten geflutet werden.



LEGO.com/brickseparator



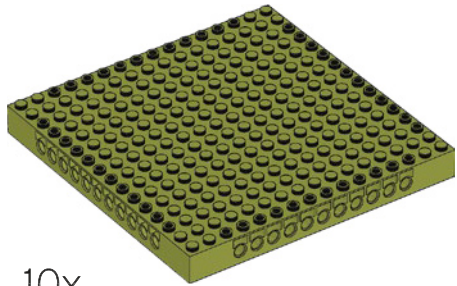

10x

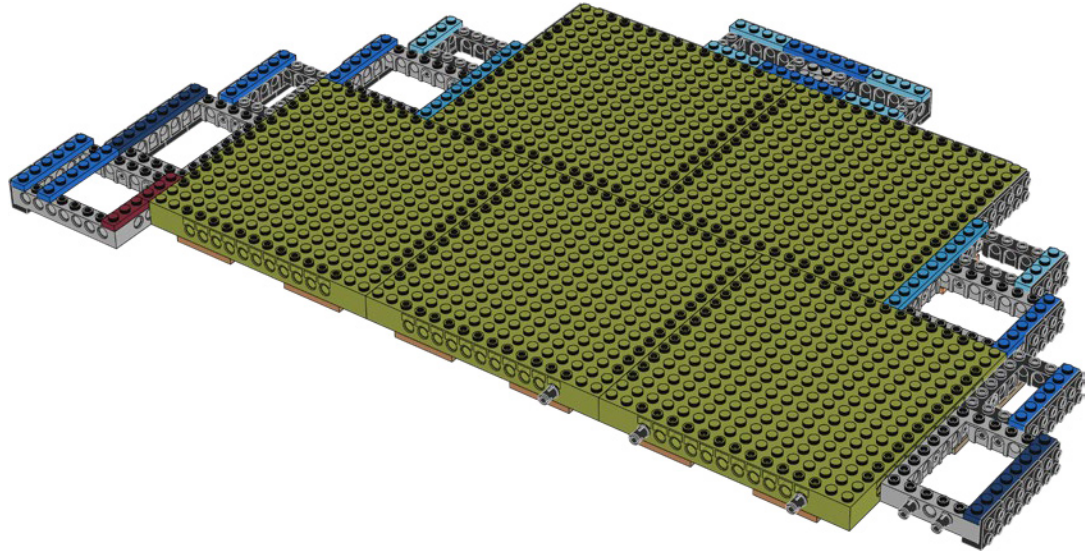
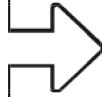

2x



1

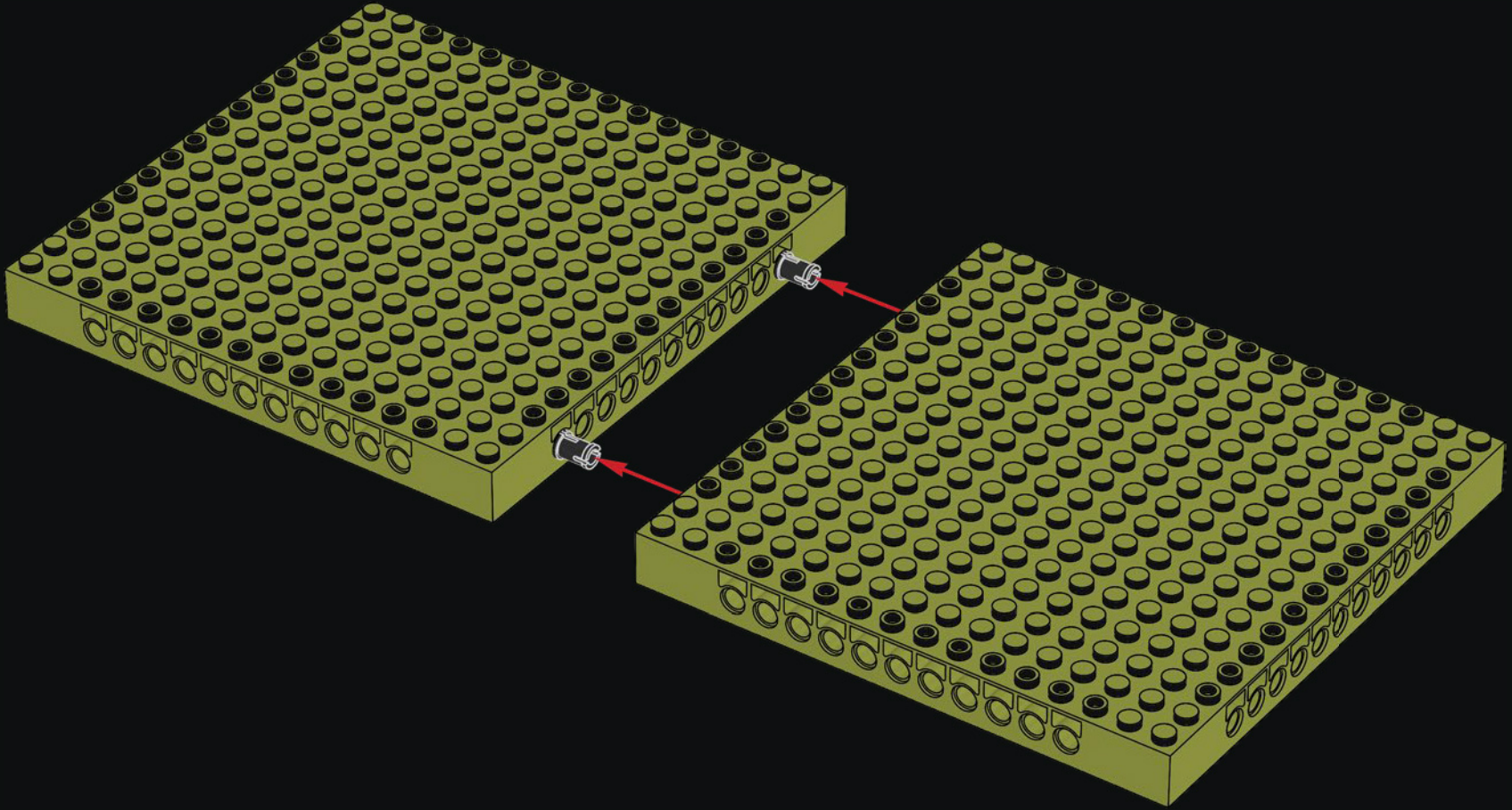

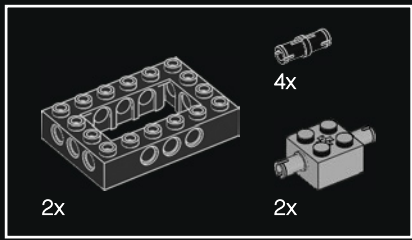

2

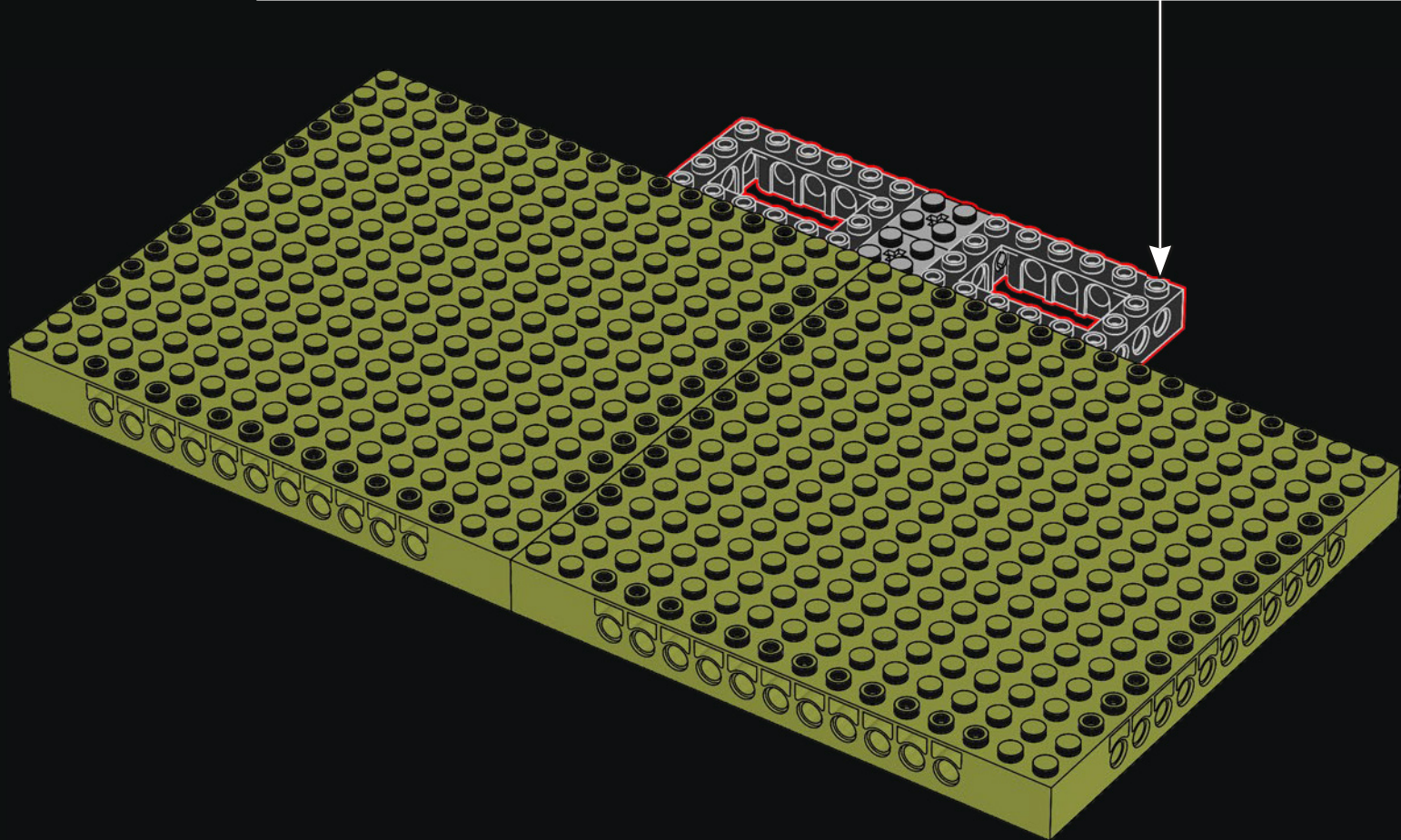
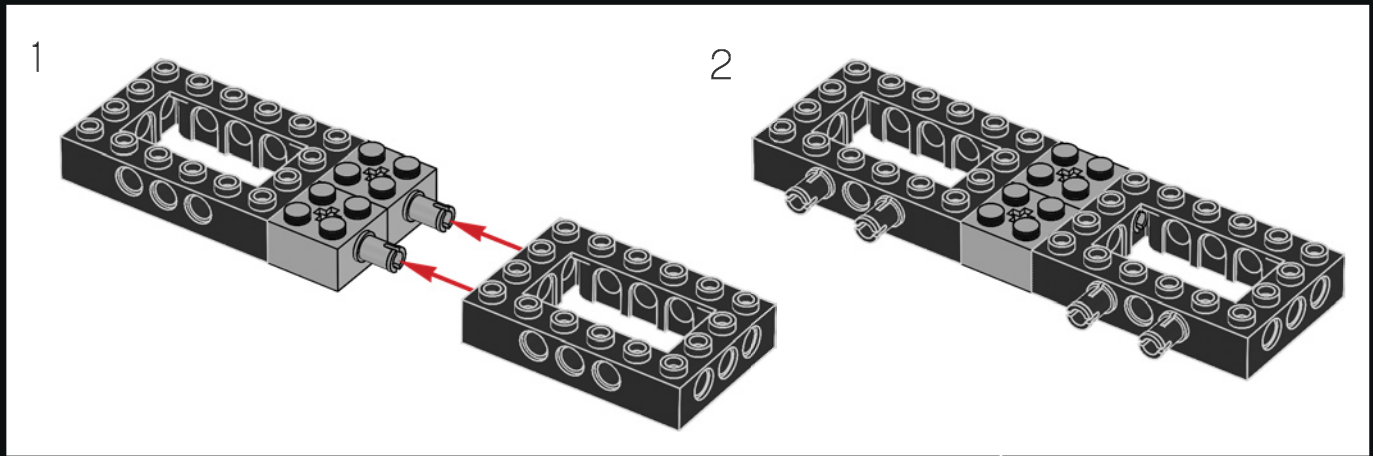



3

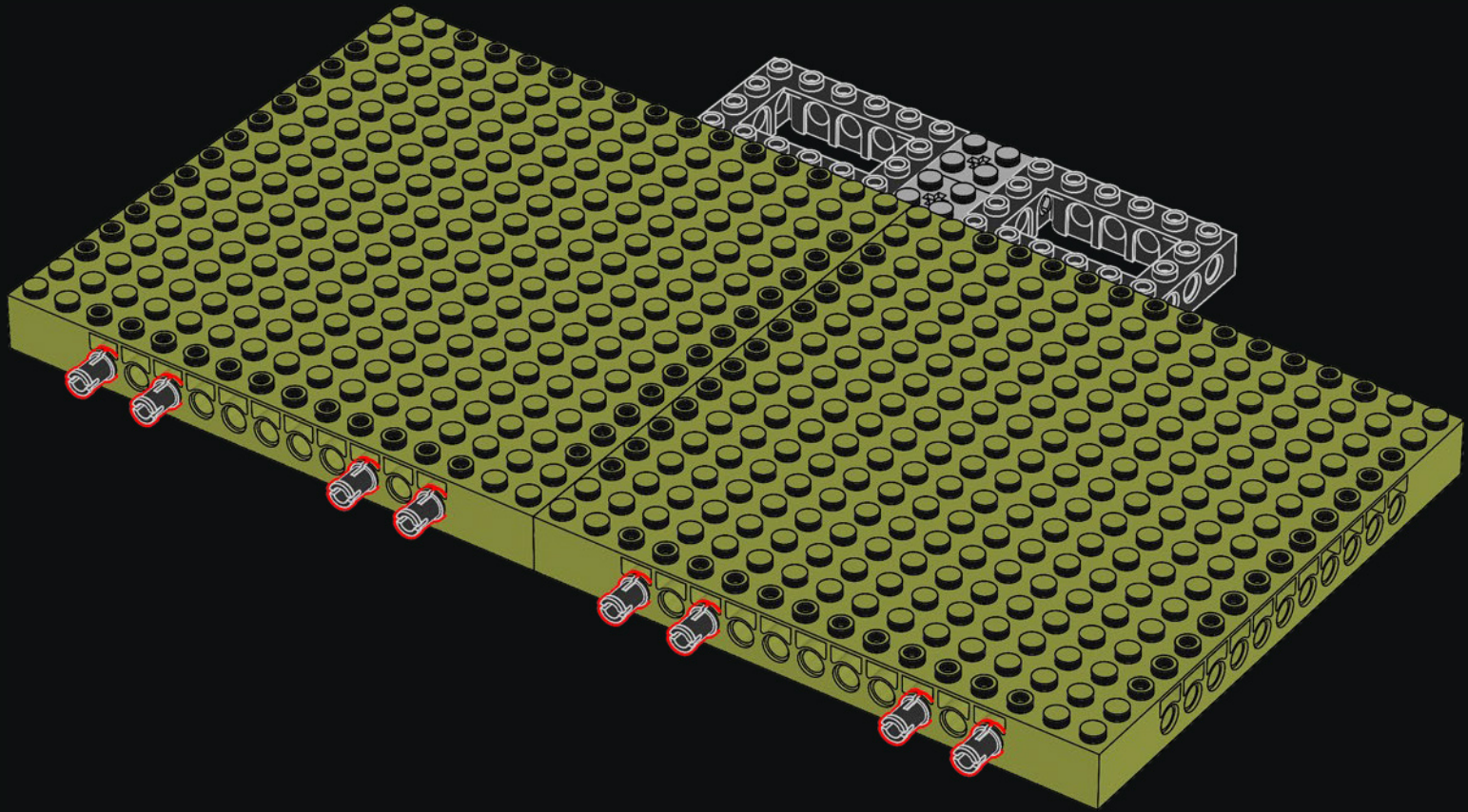

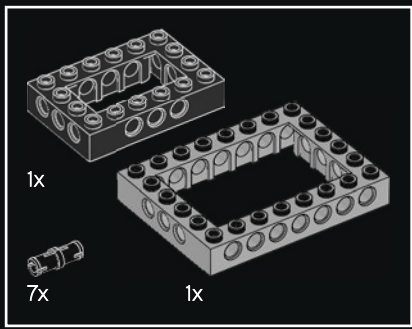

4

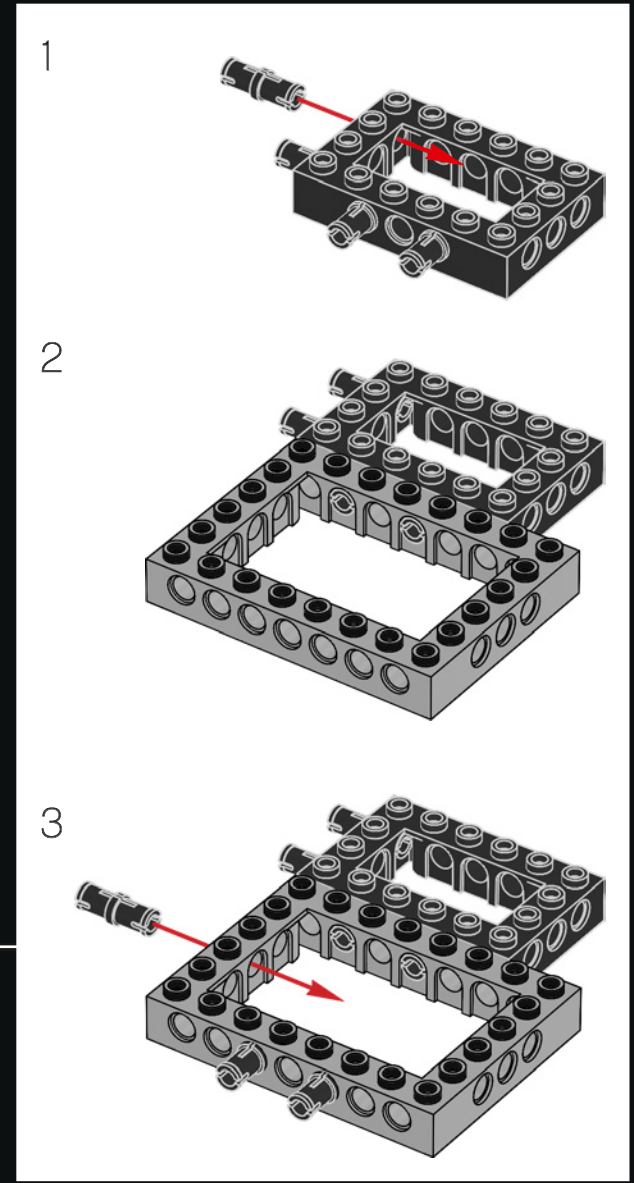
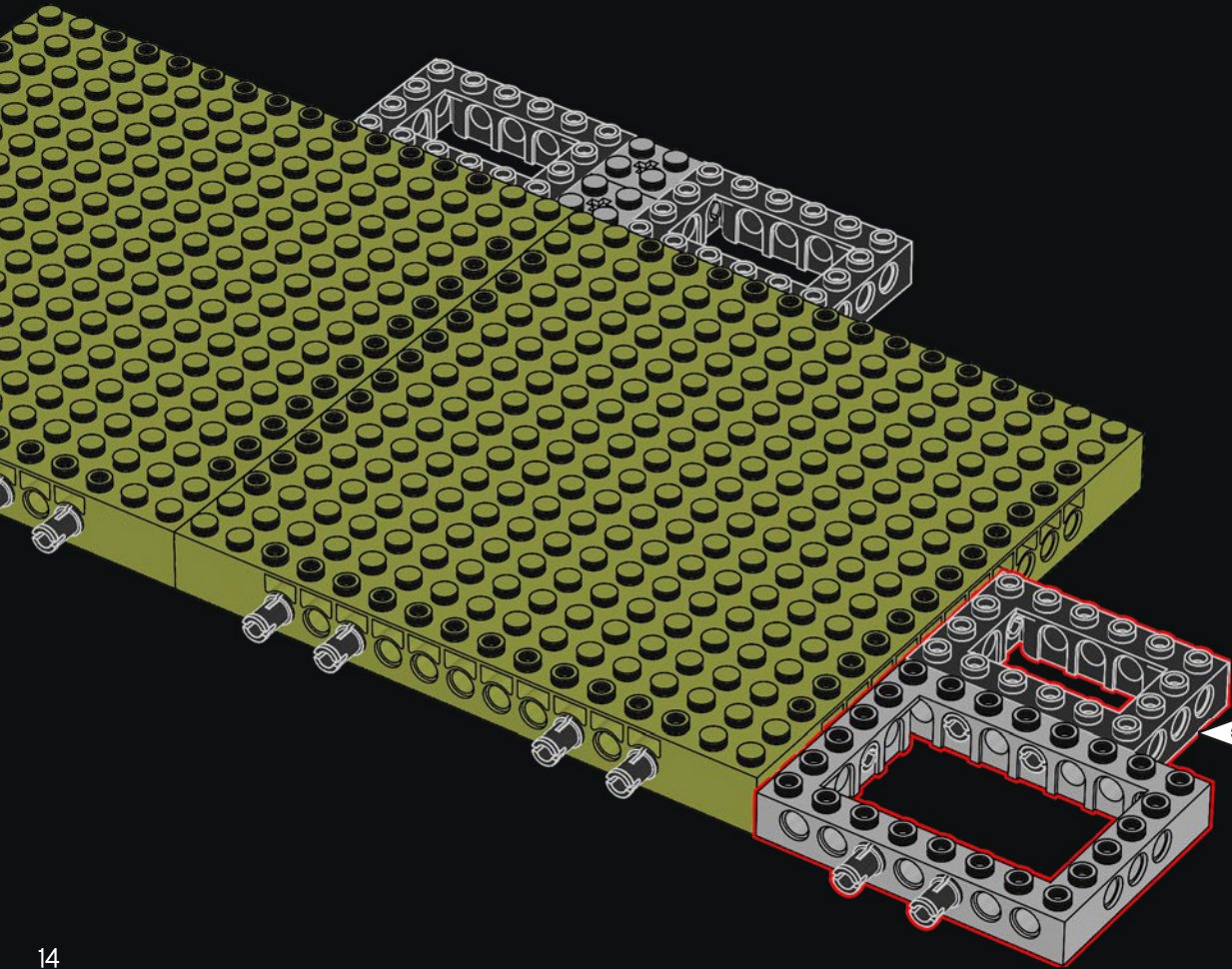

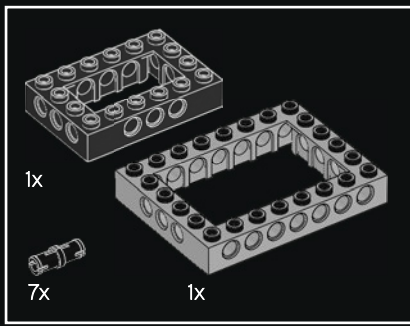

5

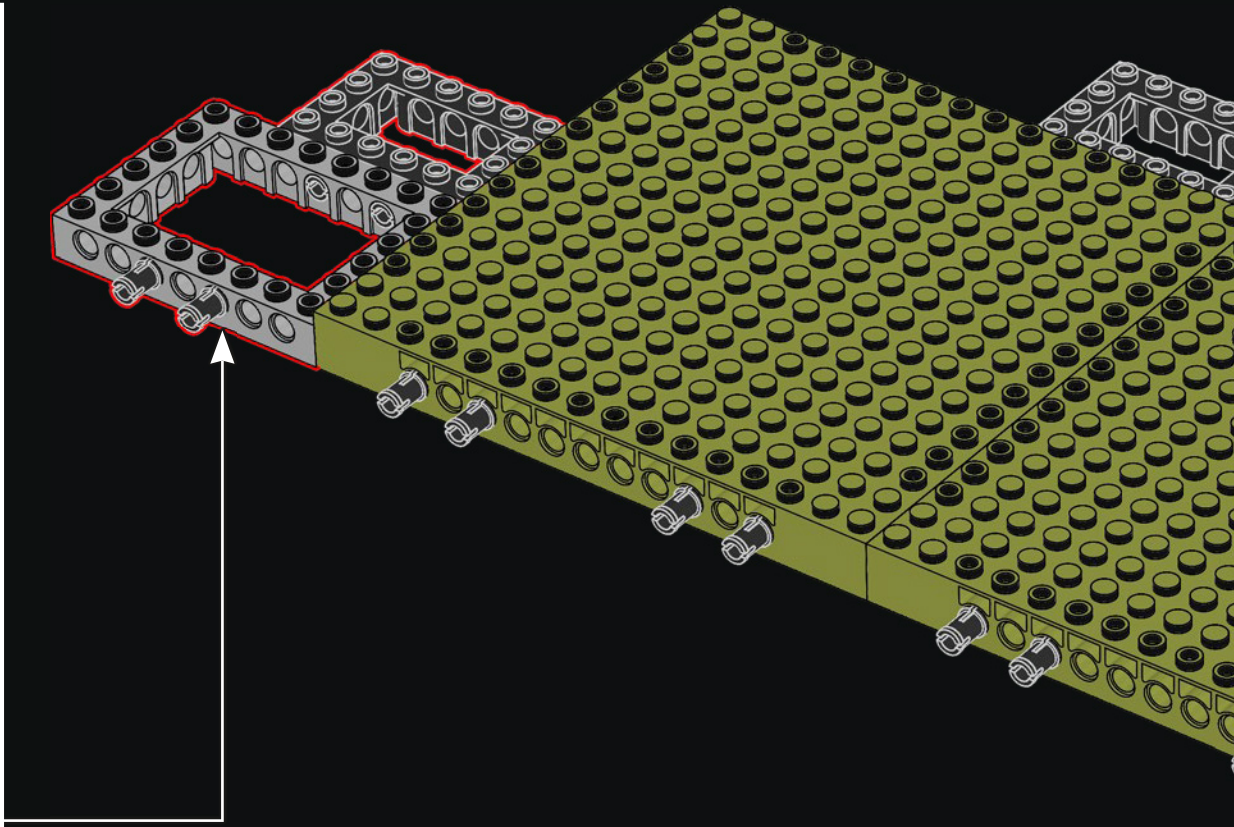
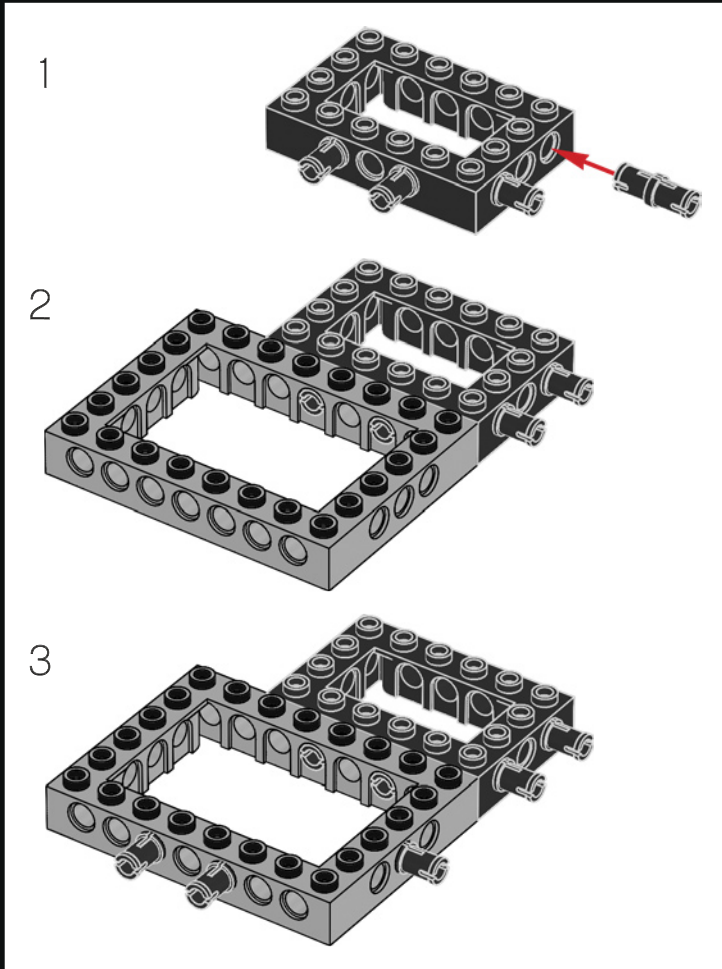



2x

6

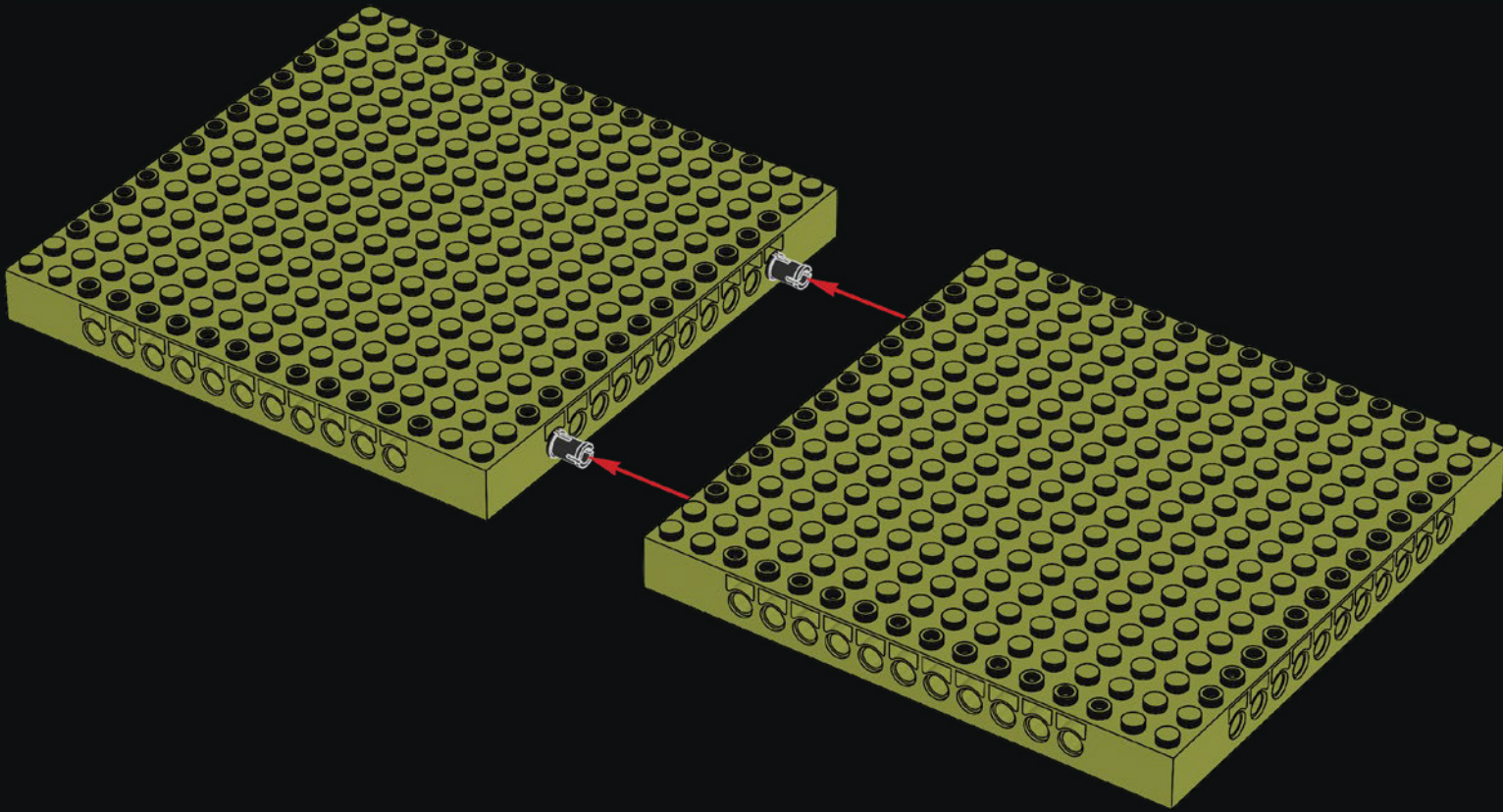



7

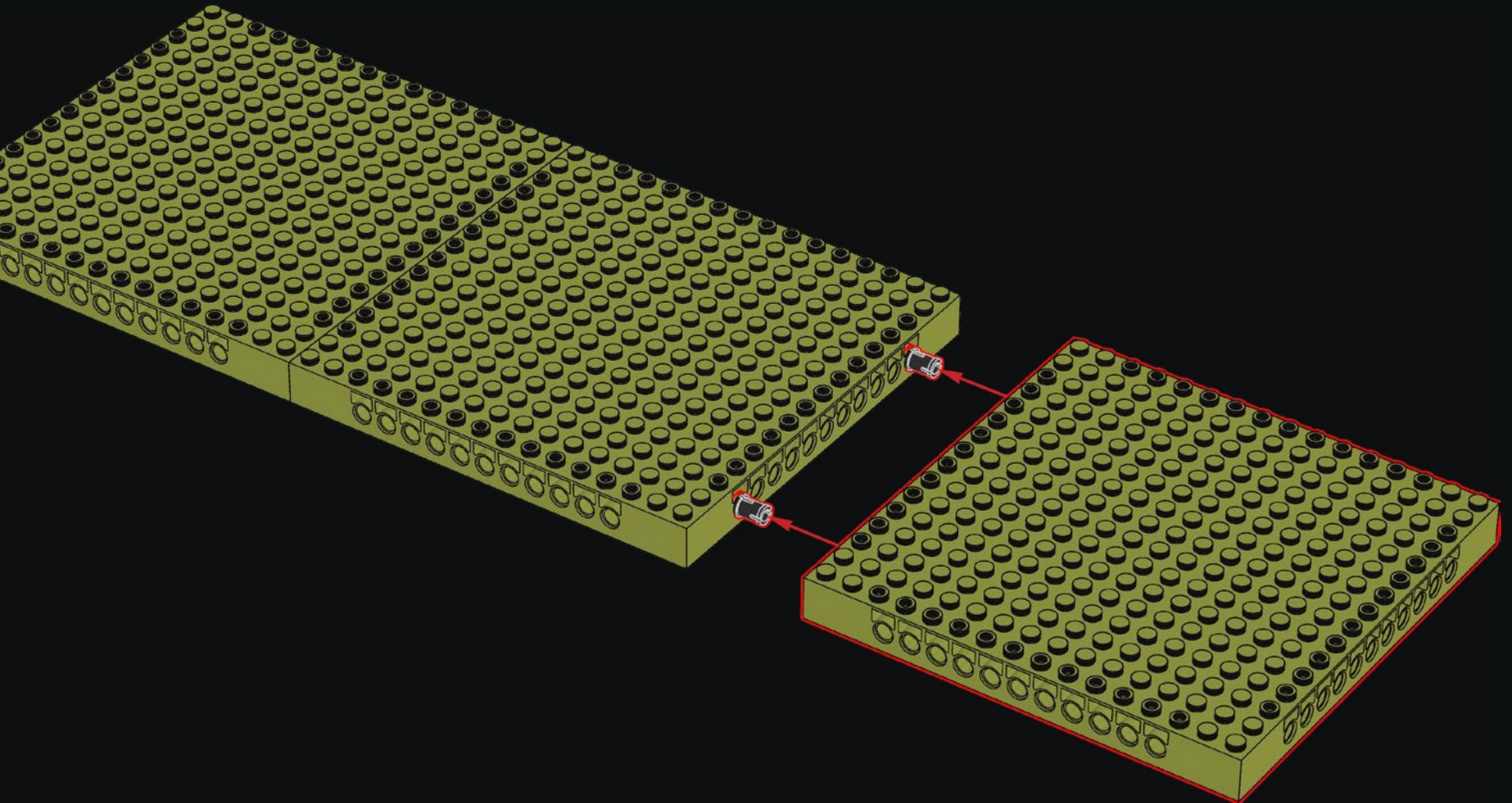

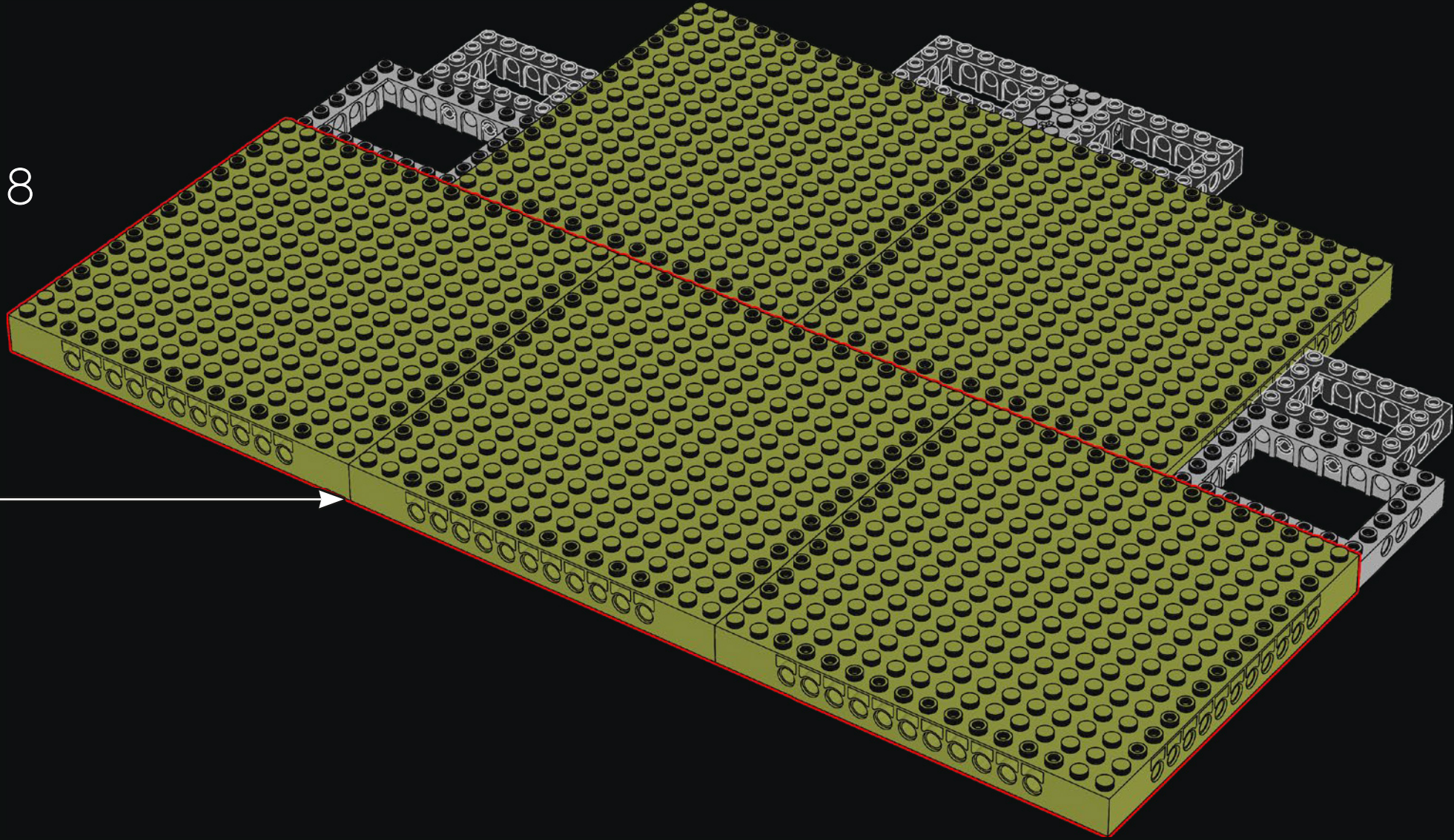

8

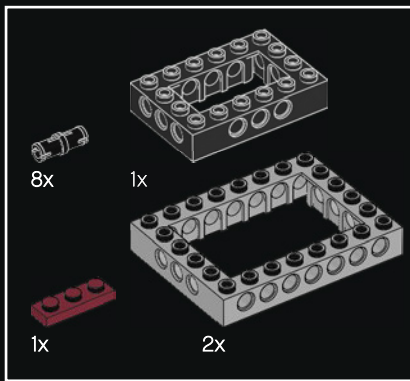

9

1

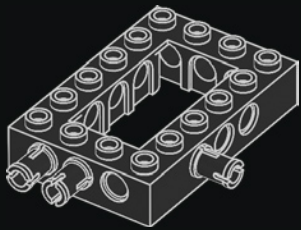

2

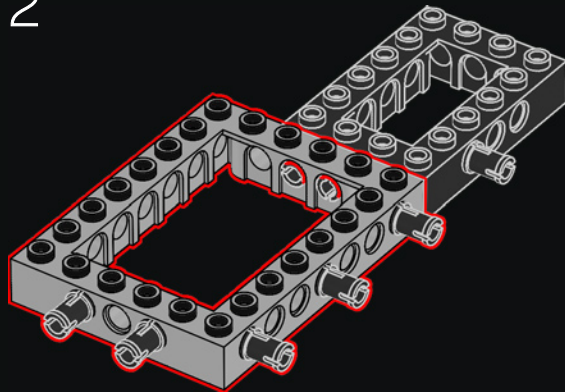

3

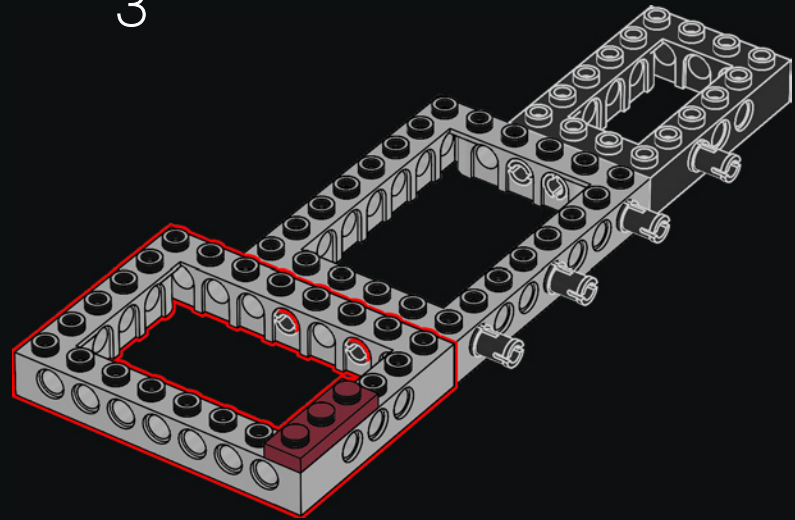

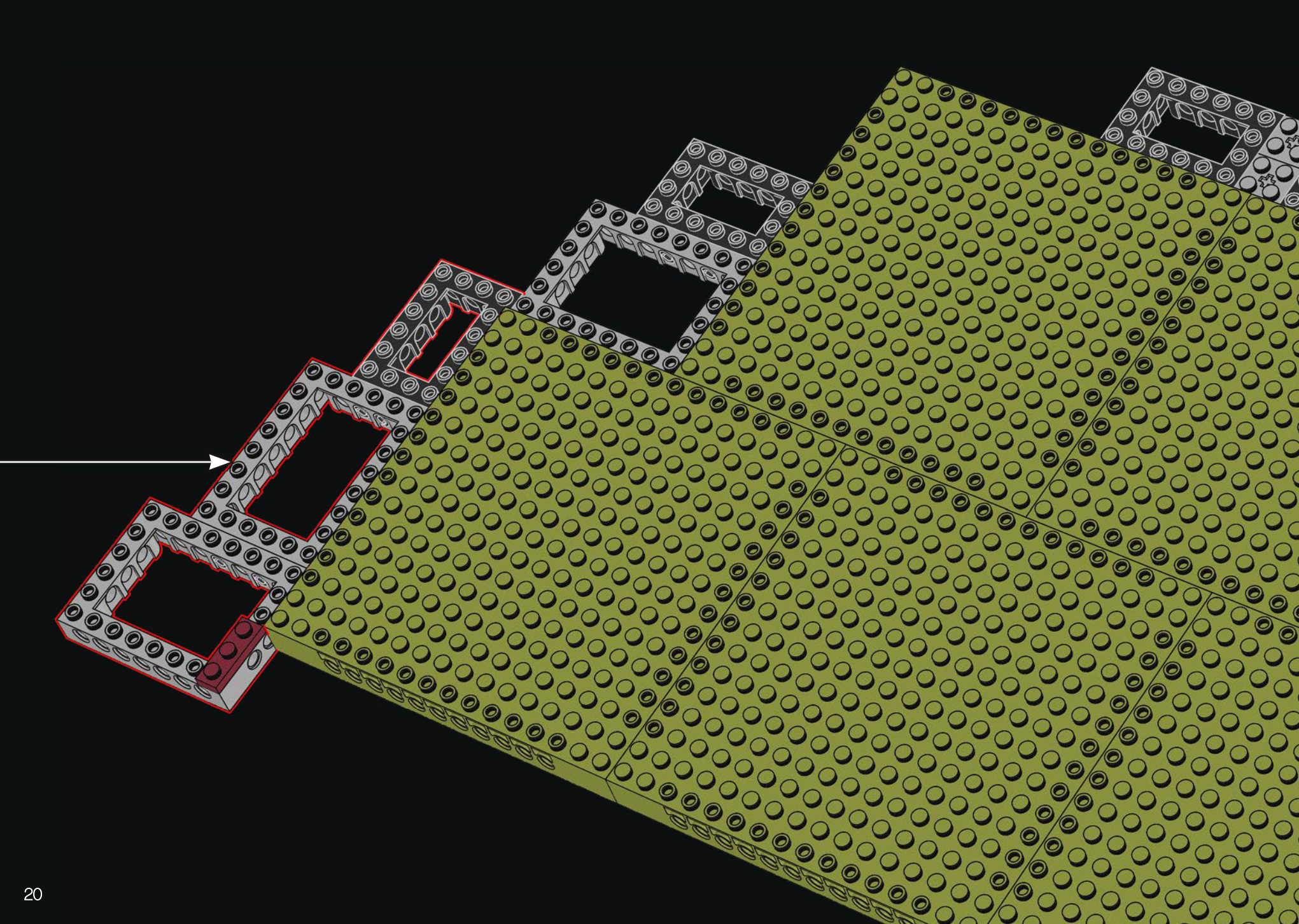

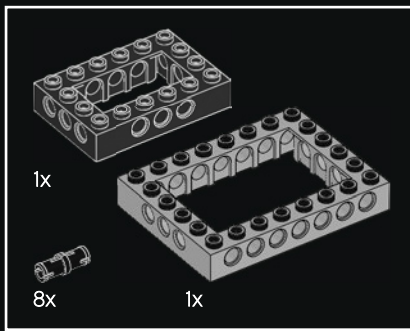

10

1

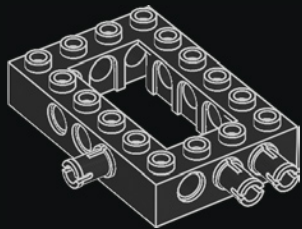

2

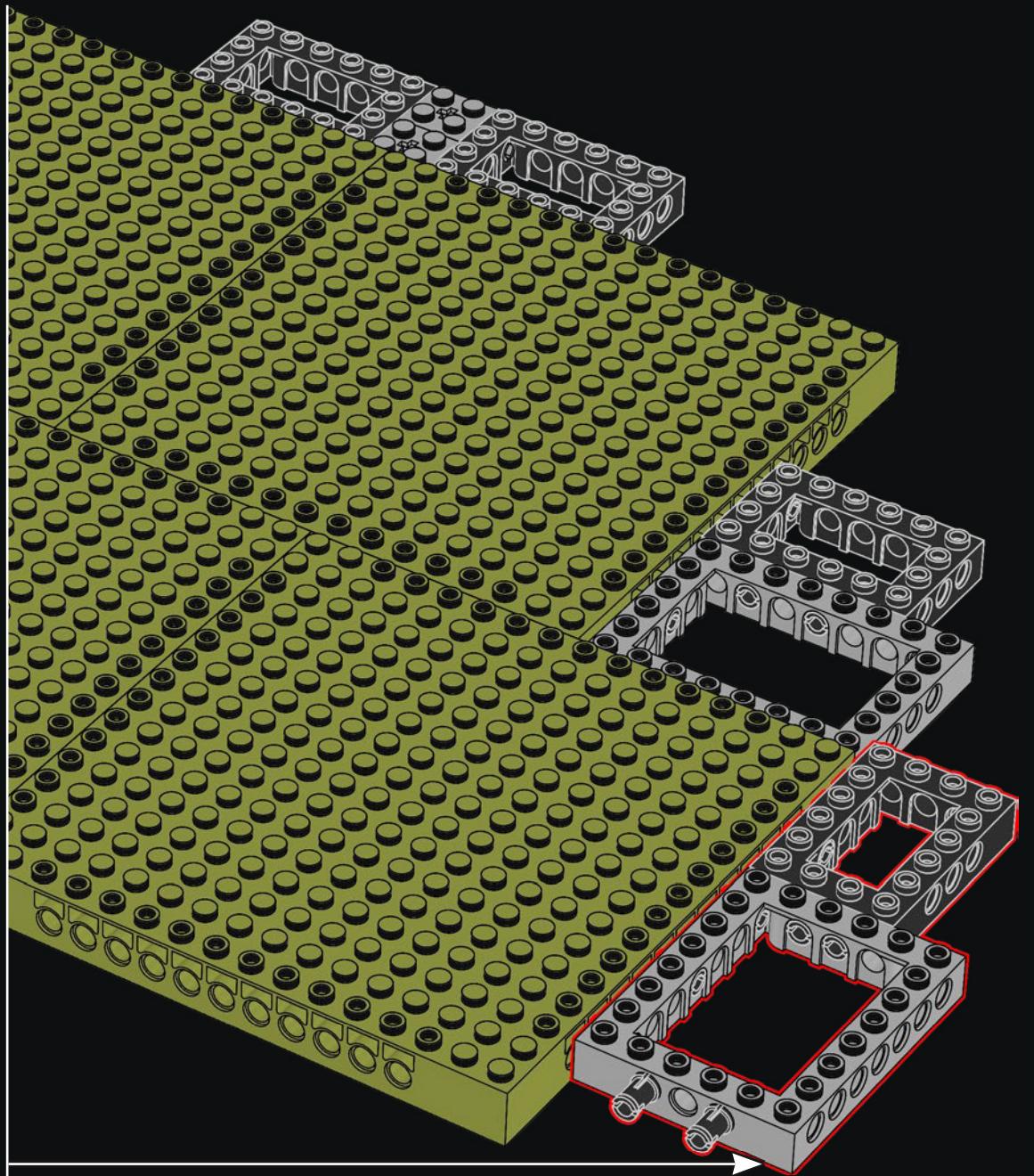
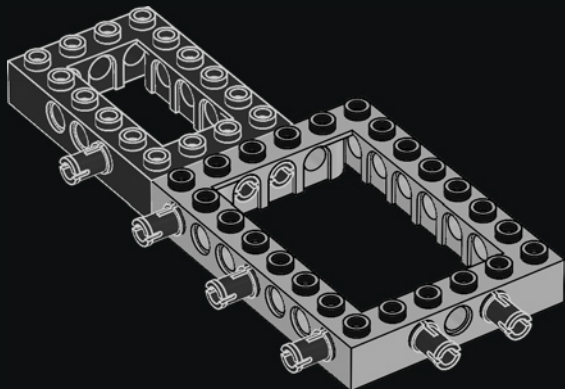

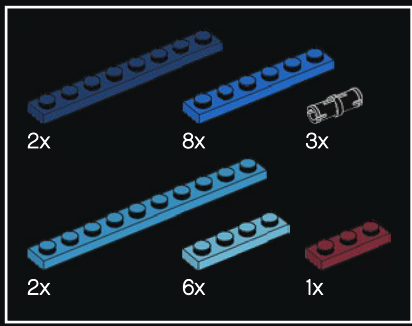

11

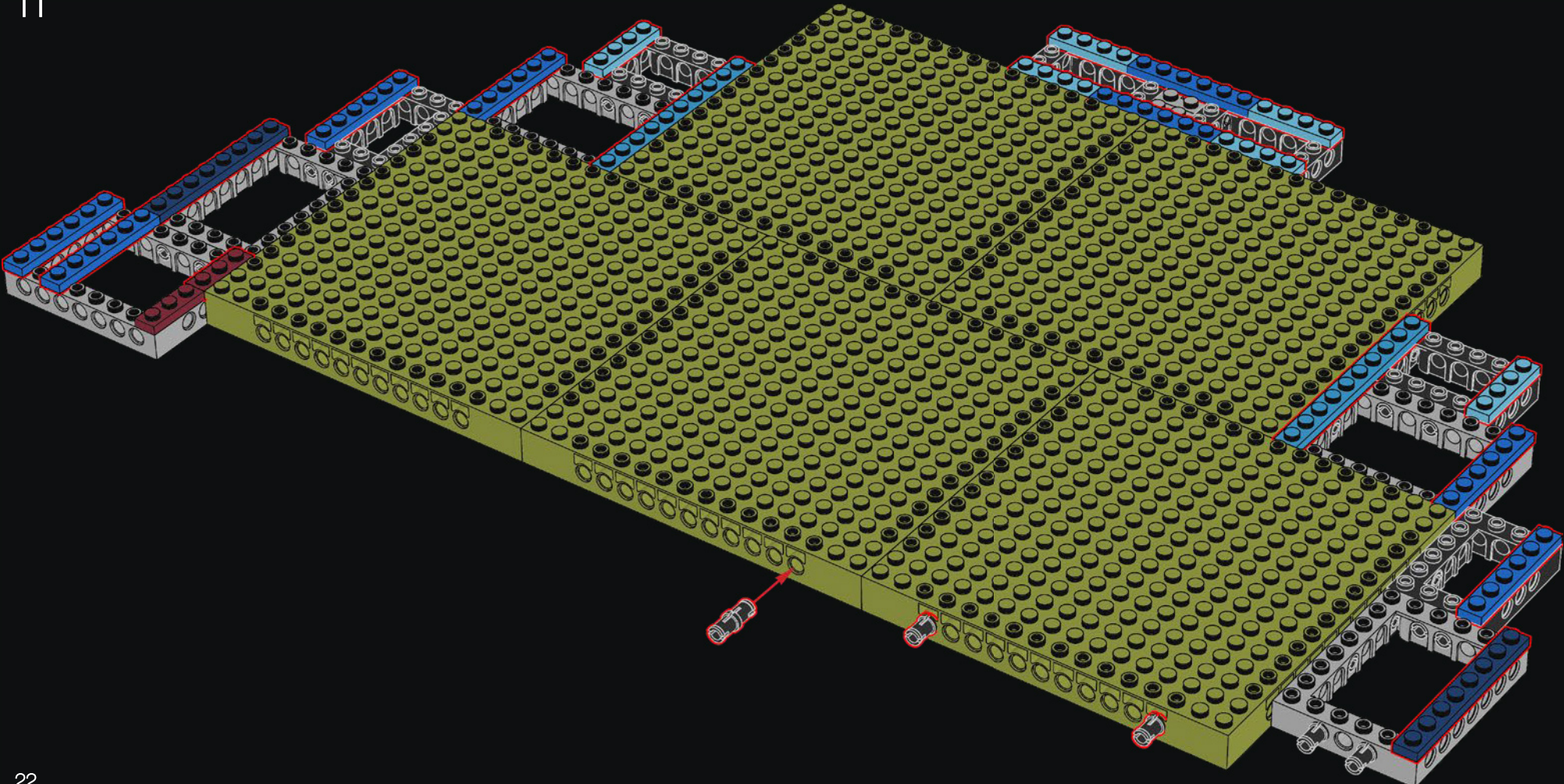

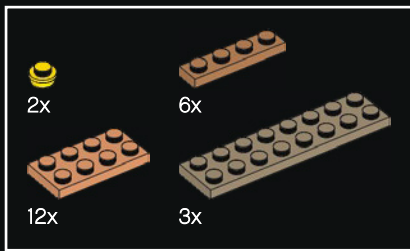

12





46x

13

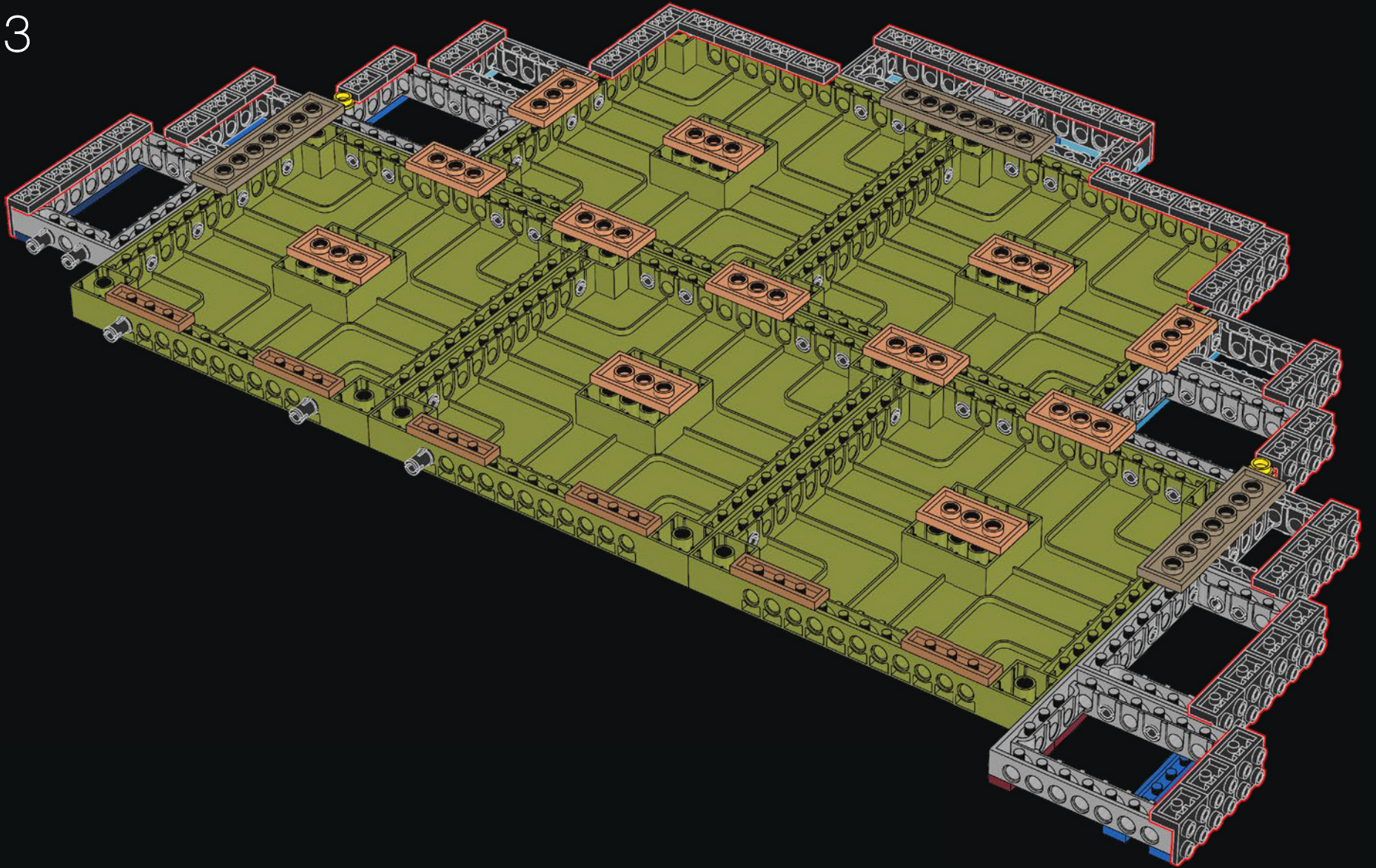

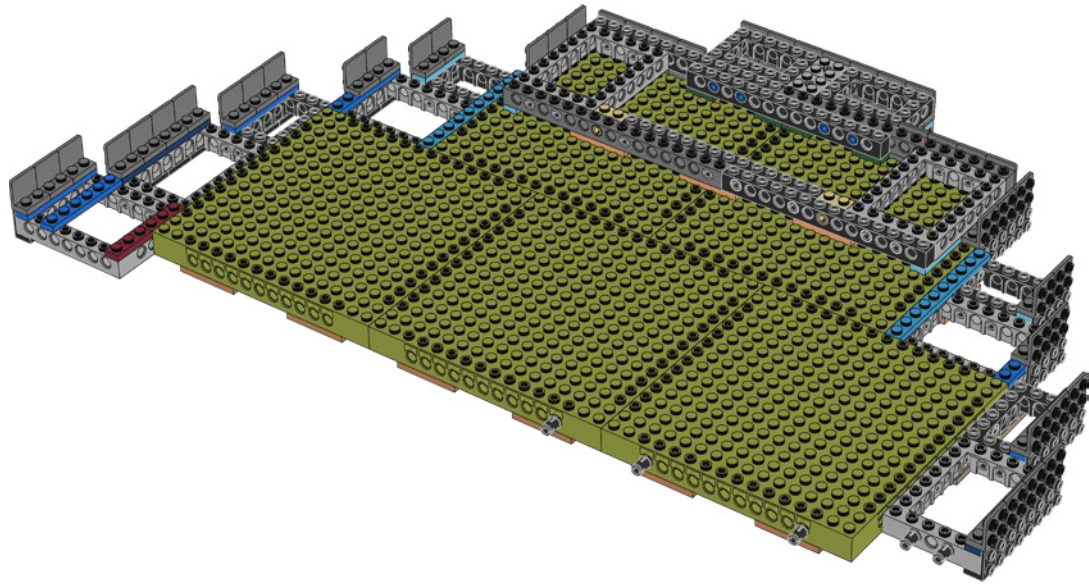
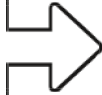



46x

14

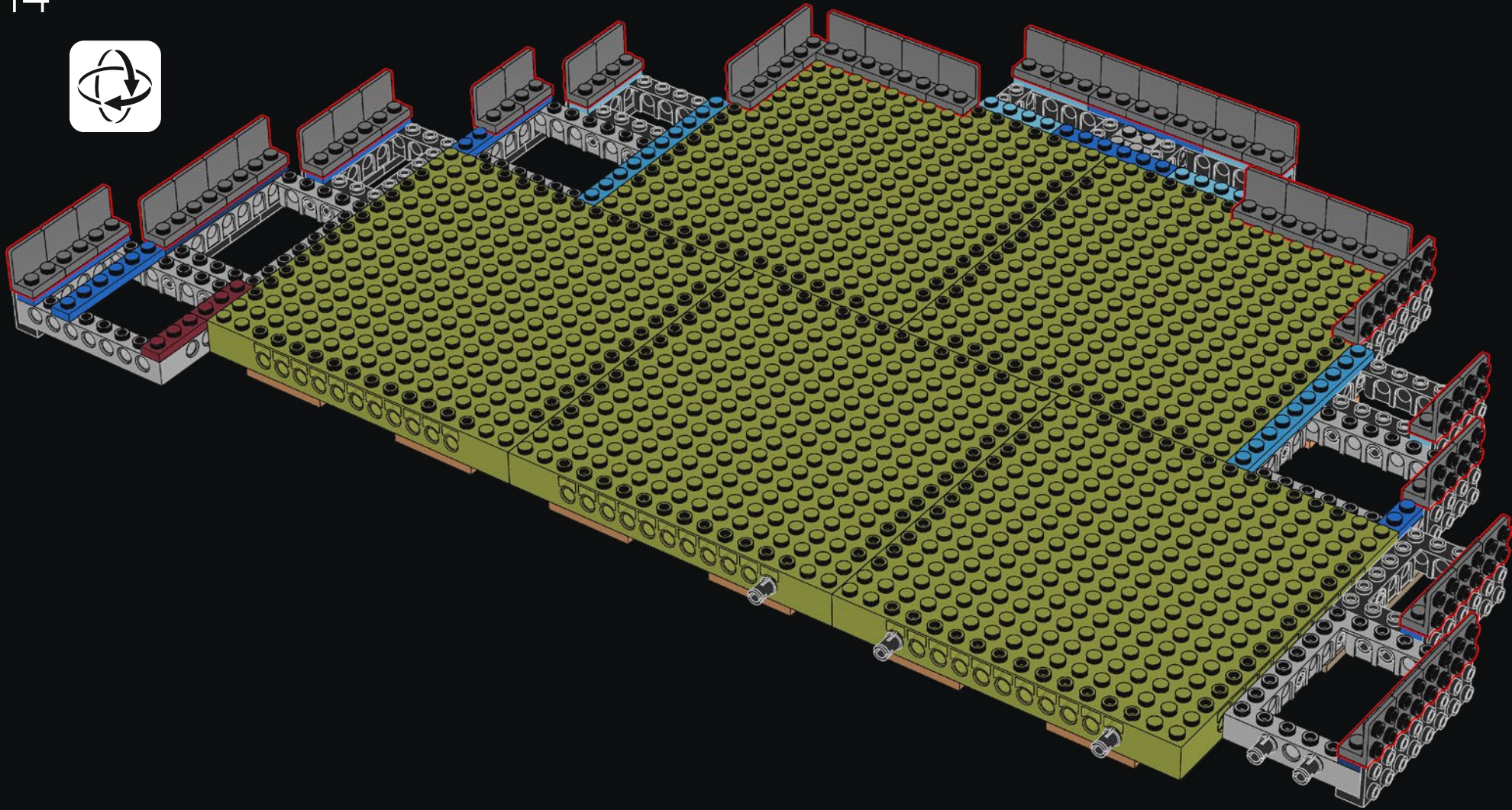

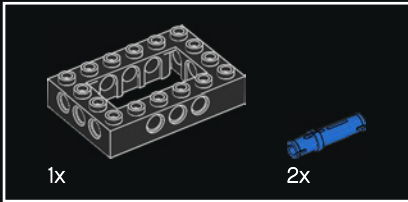
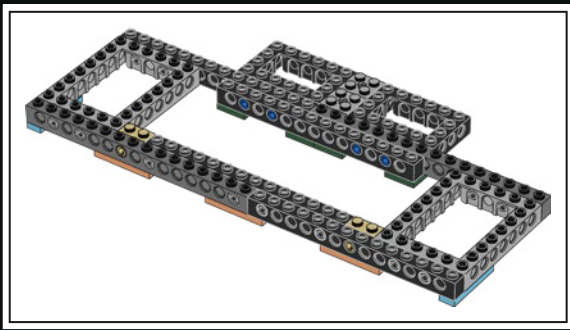

15

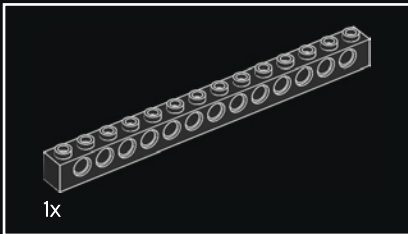
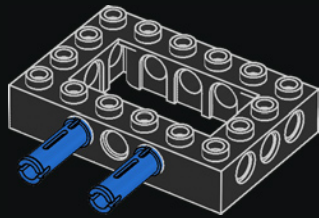

16

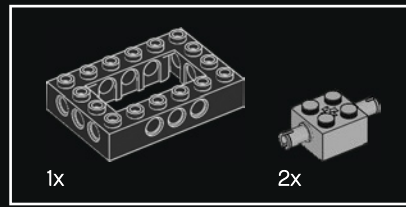
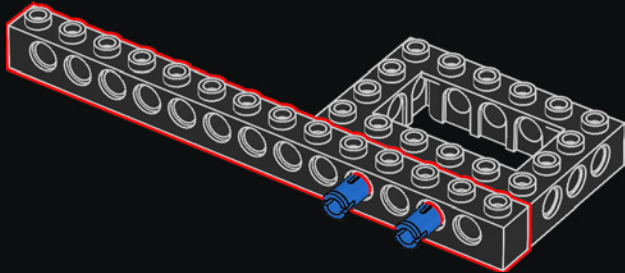

17

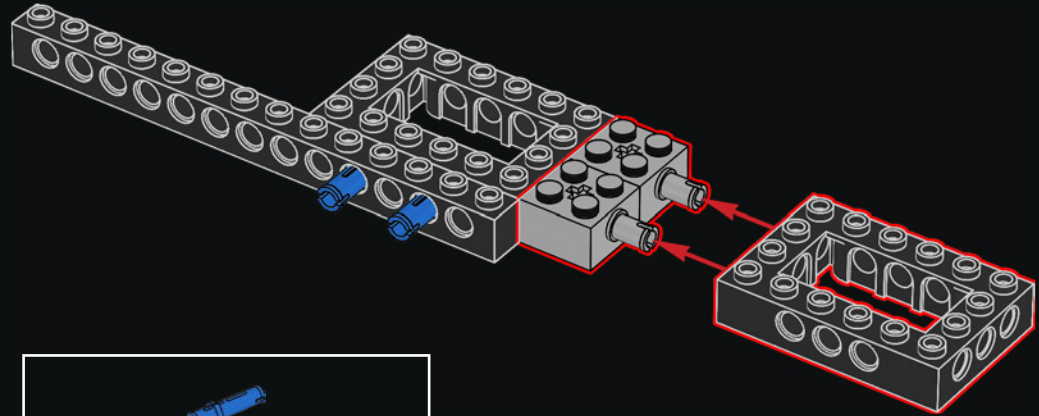

18

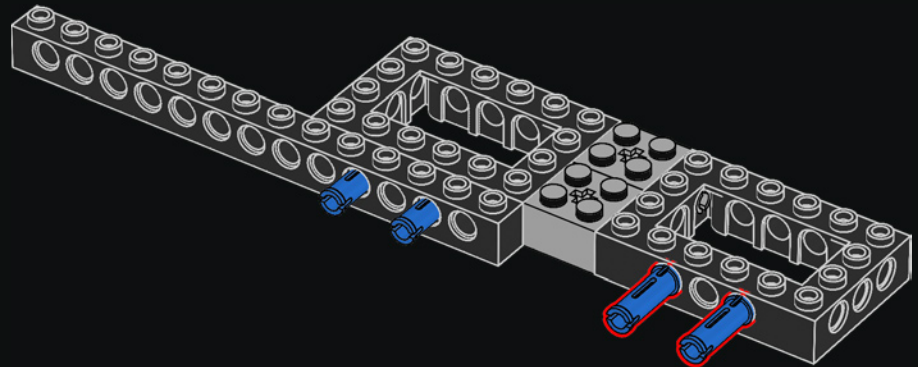

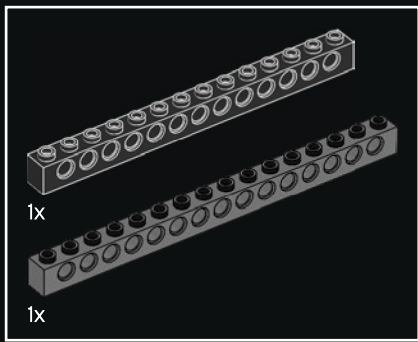

19

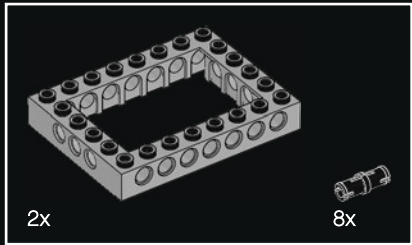
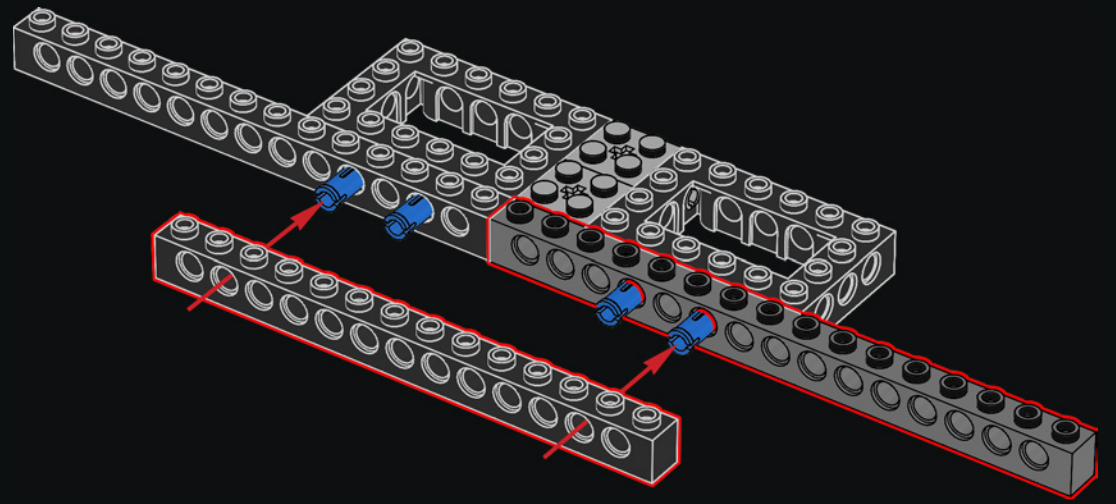

20

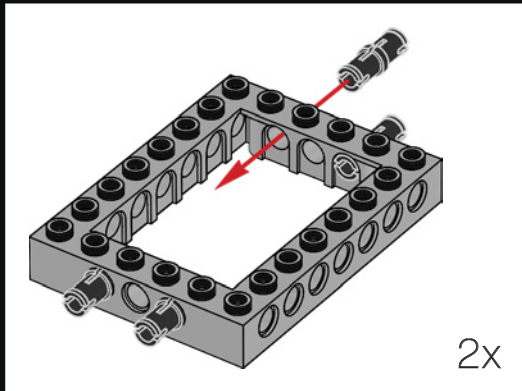
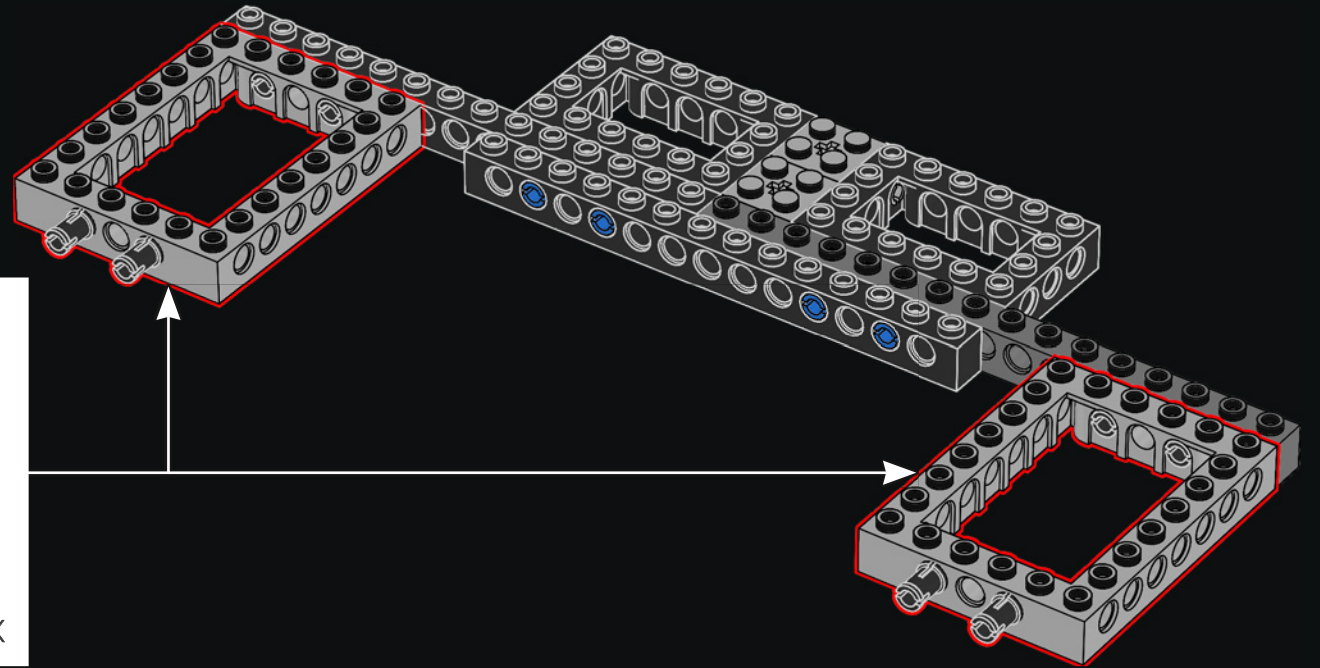

28

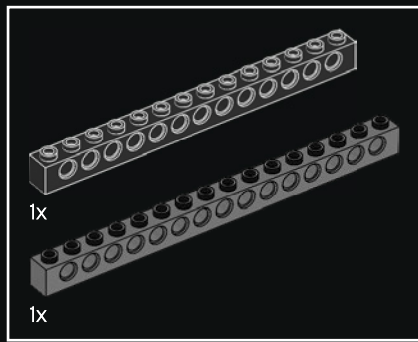

21

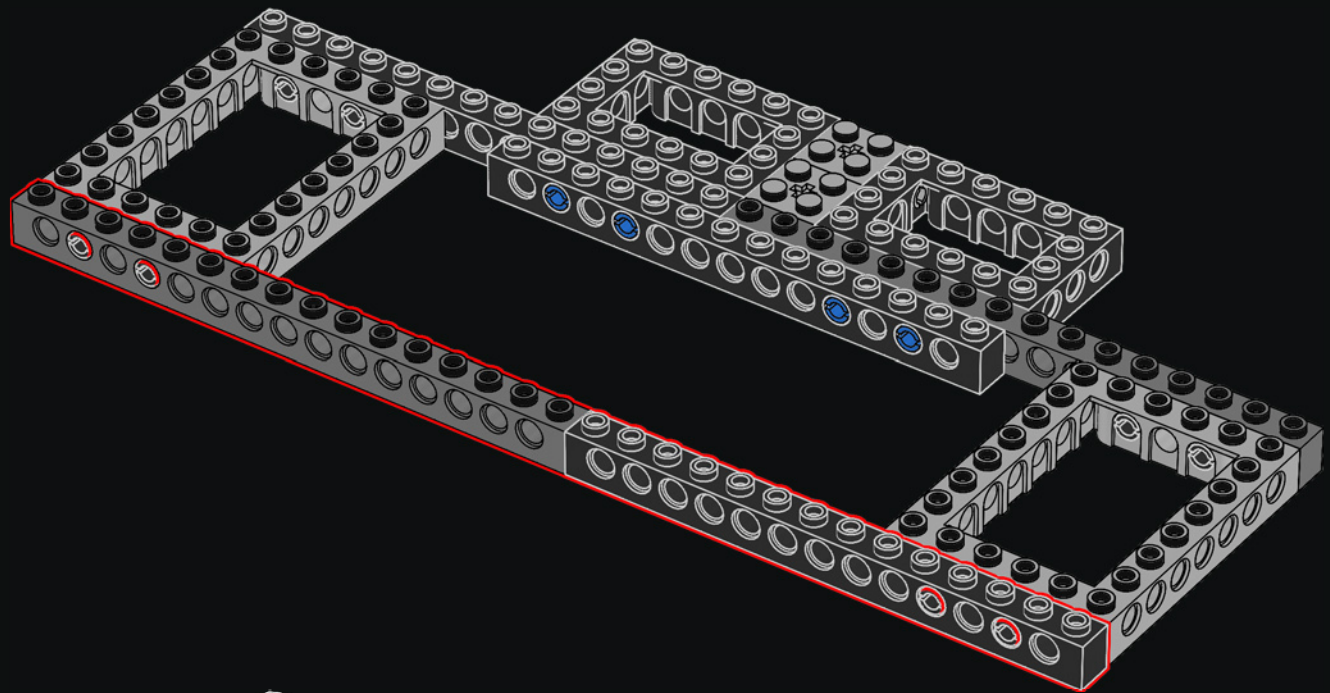

22

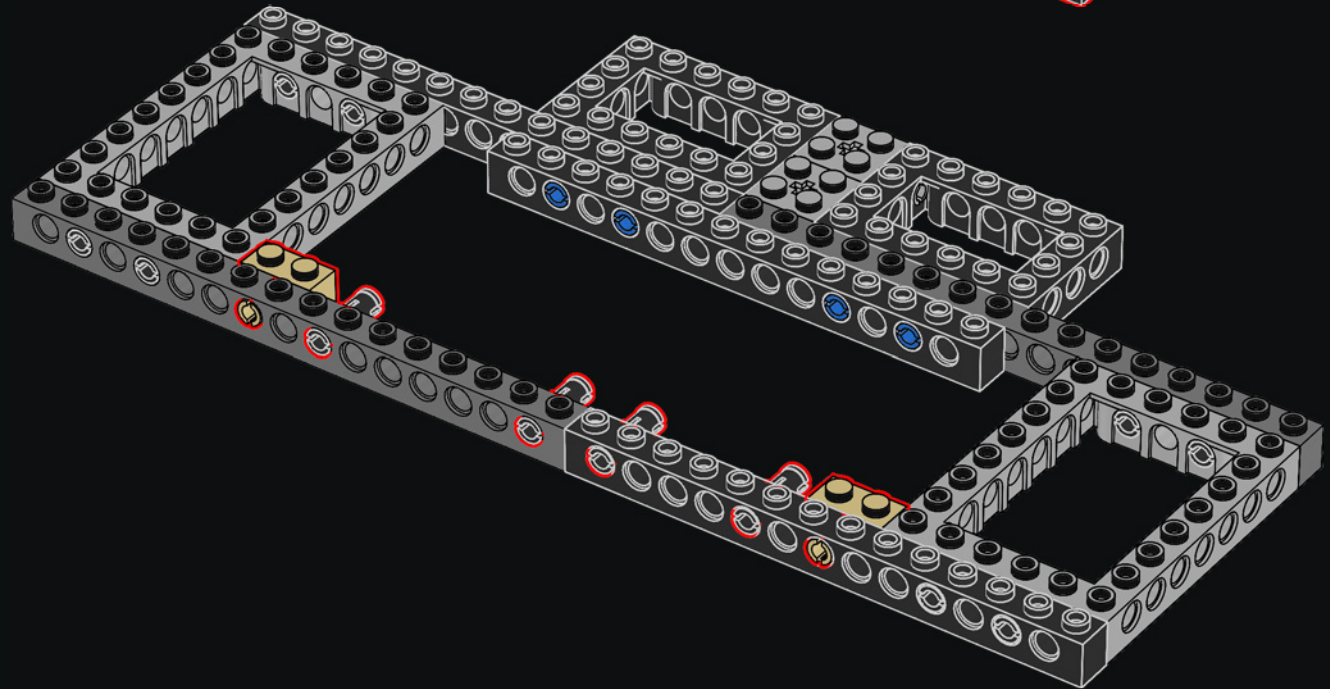

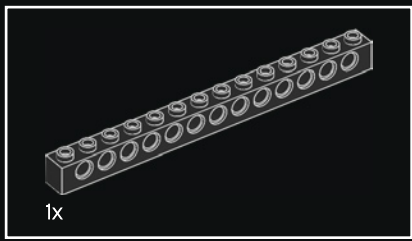

1x

23

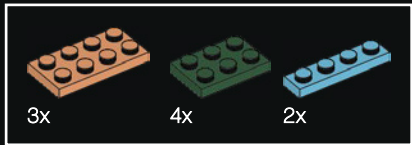
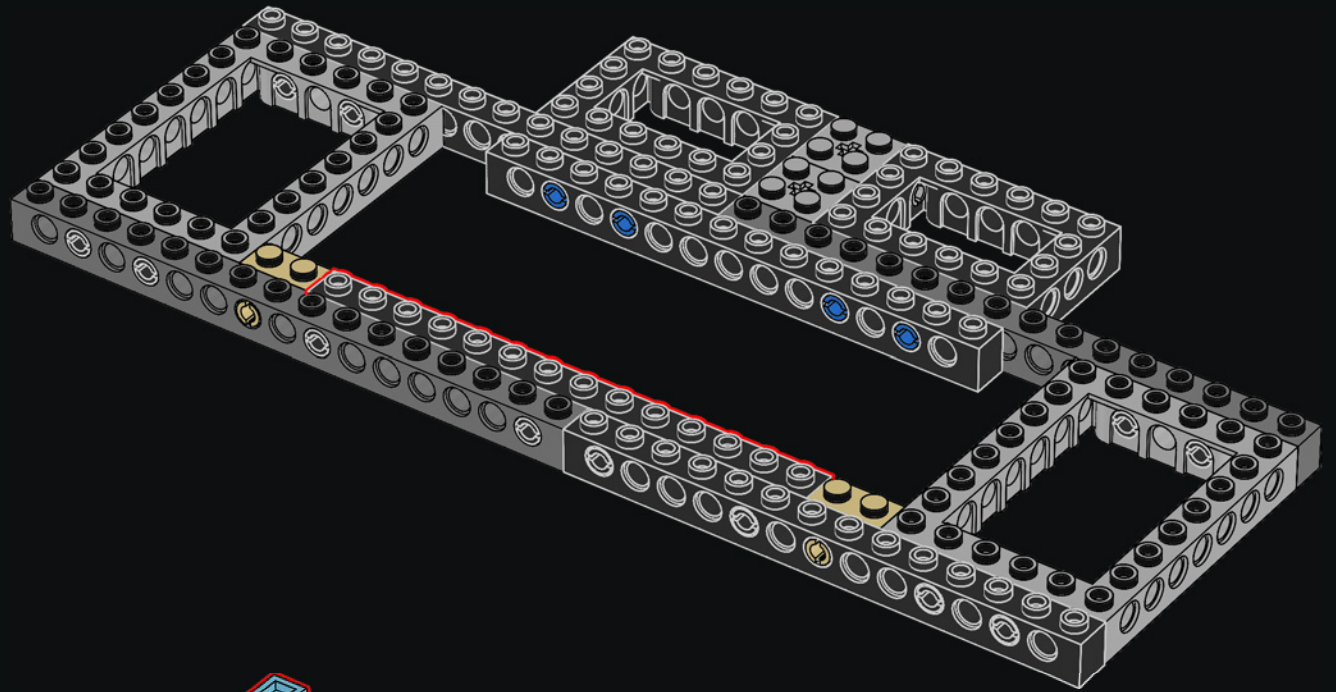

3x

4x

2x

24

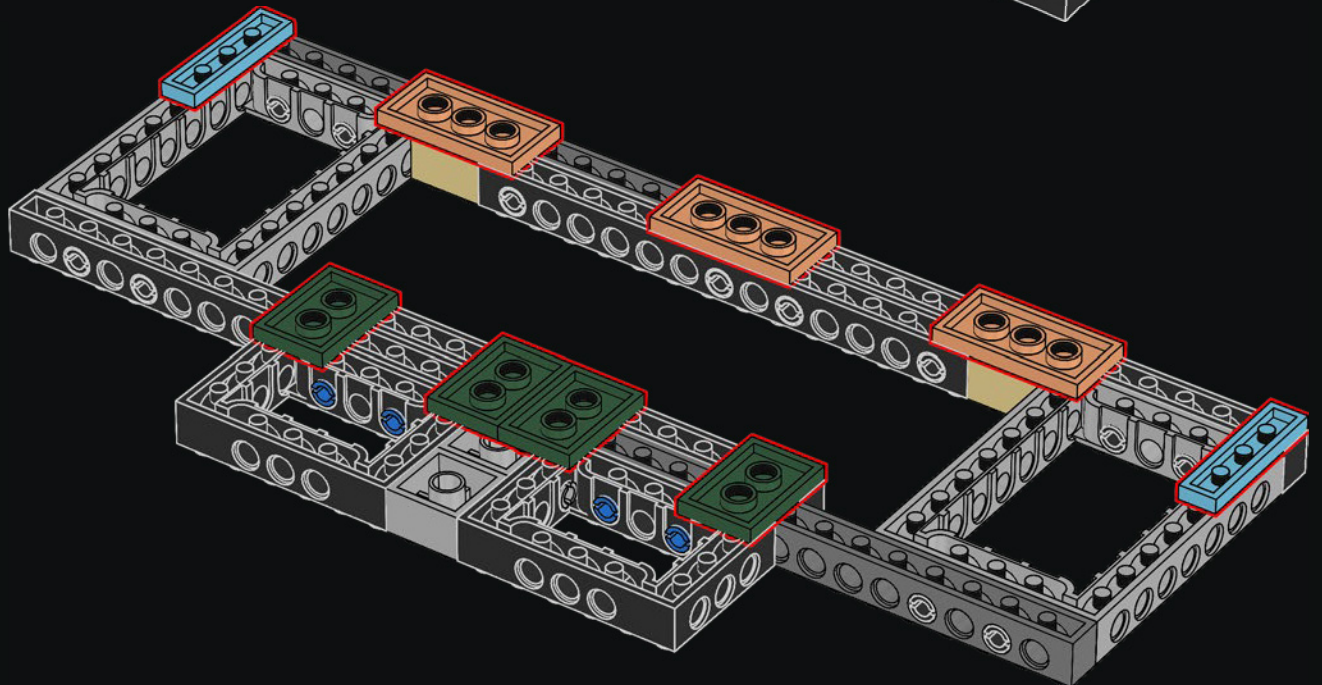

25

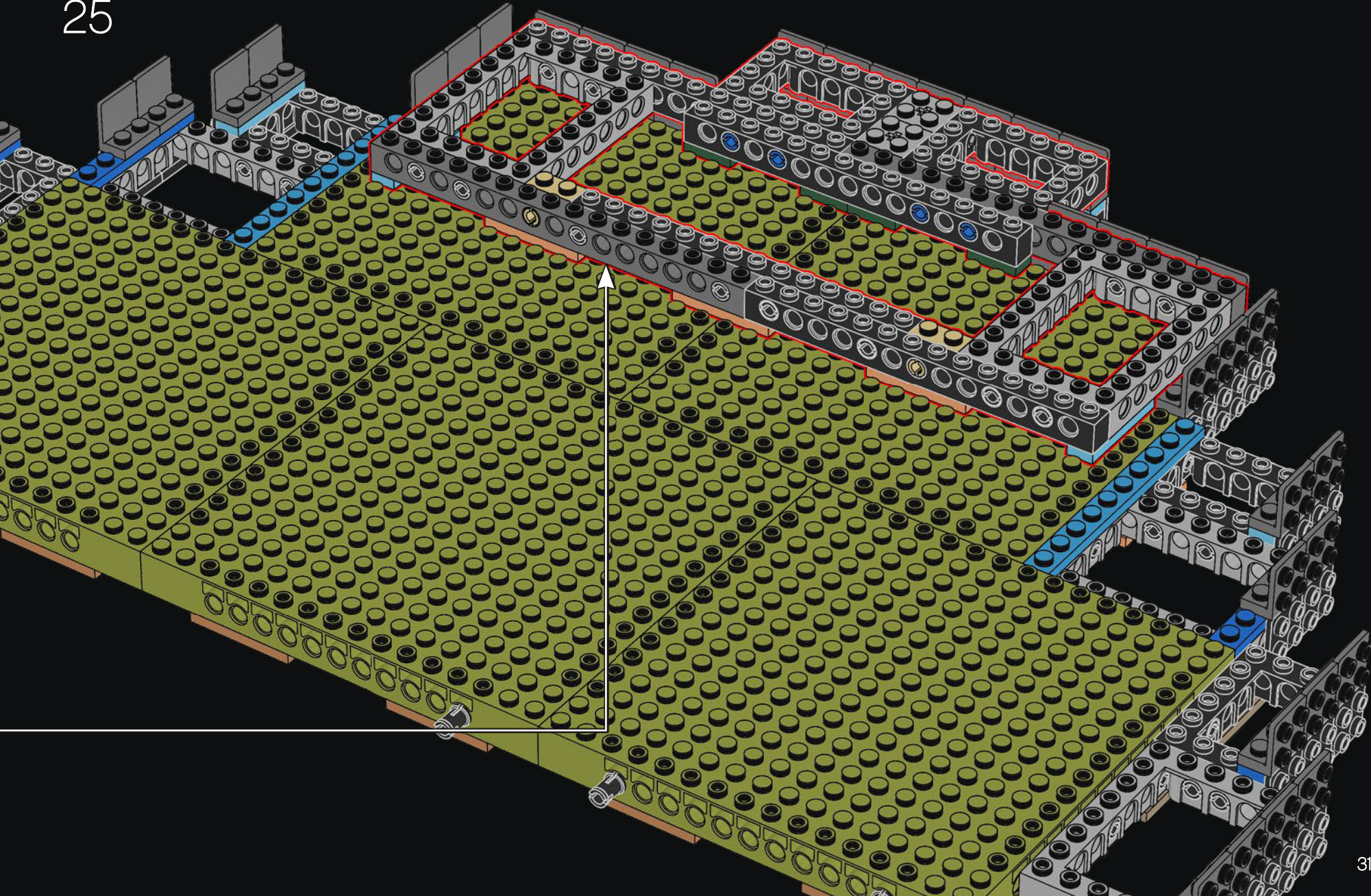

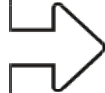

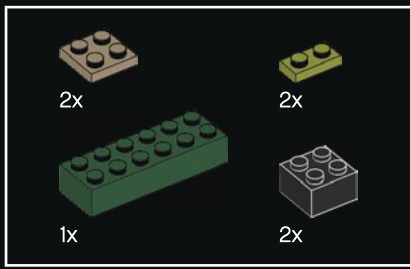

26

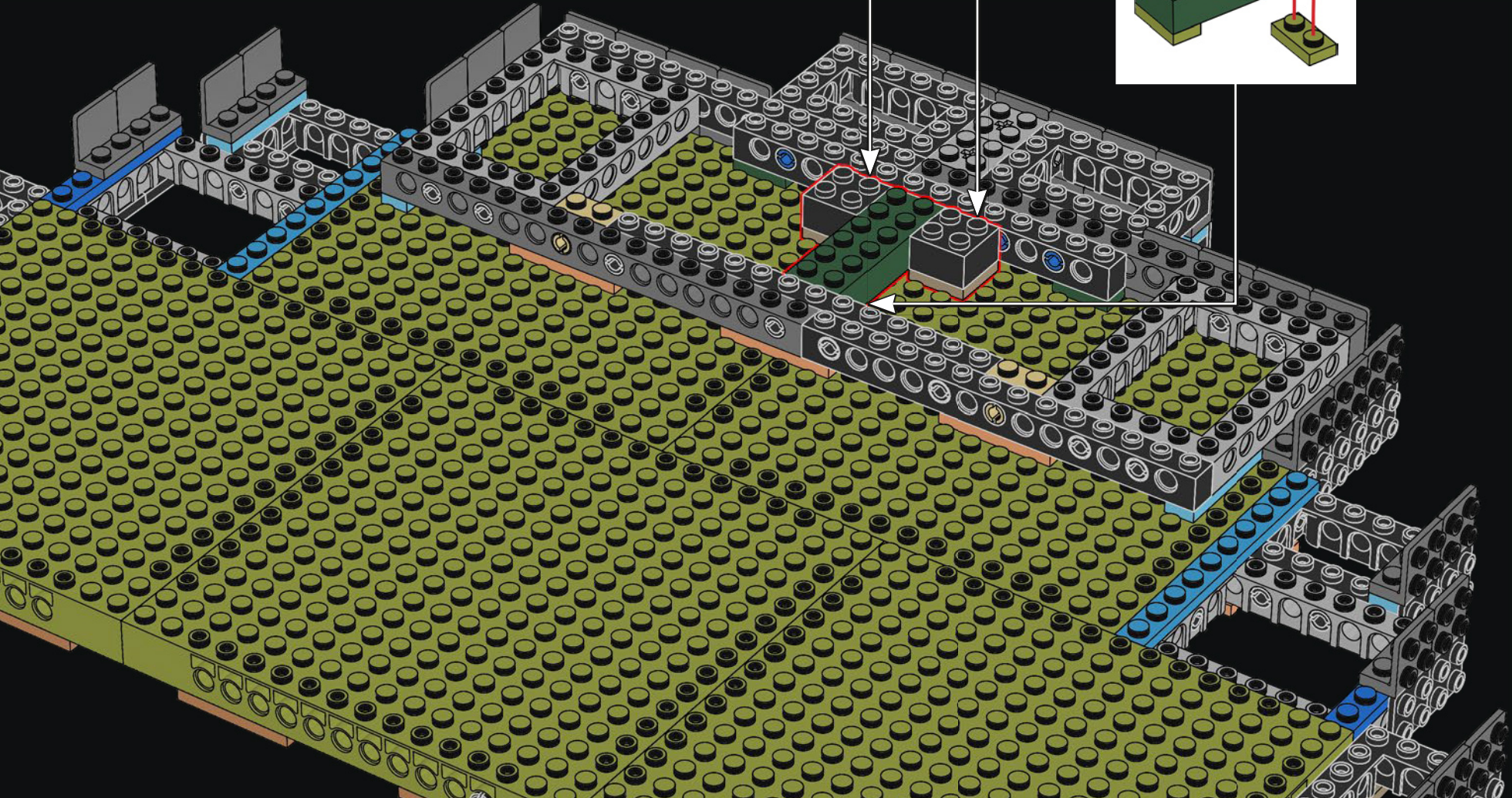
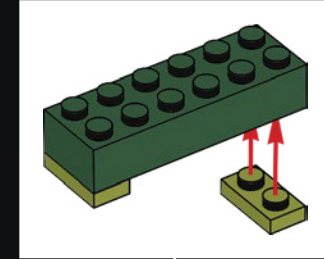
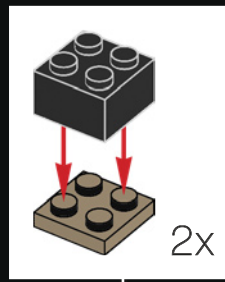

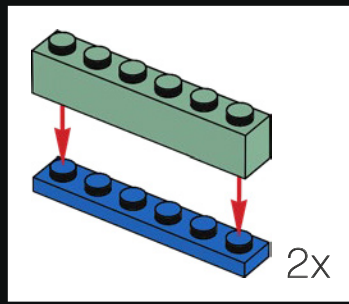
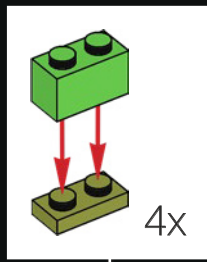
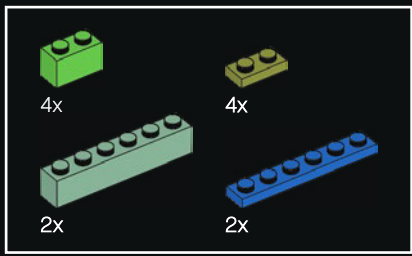

27

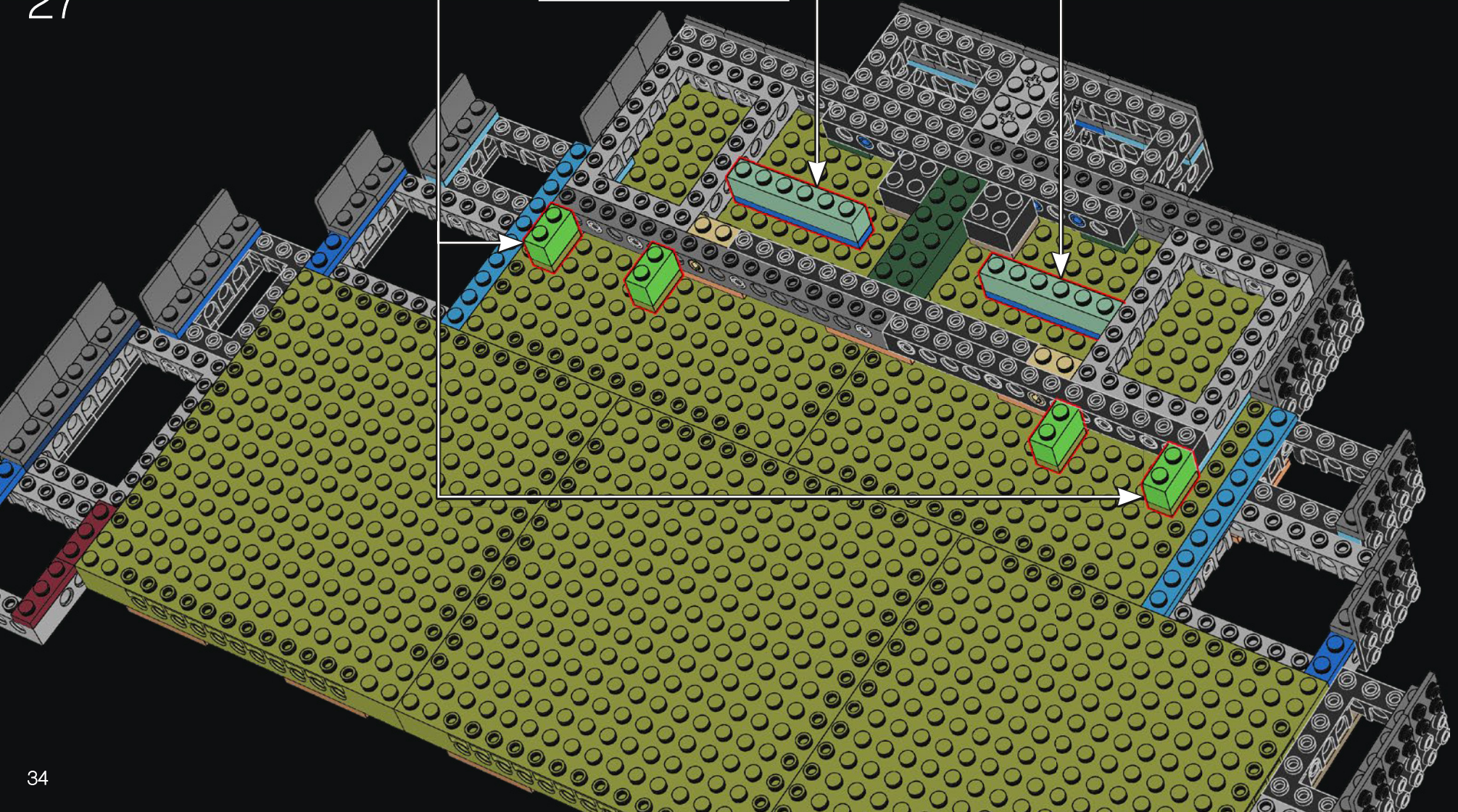

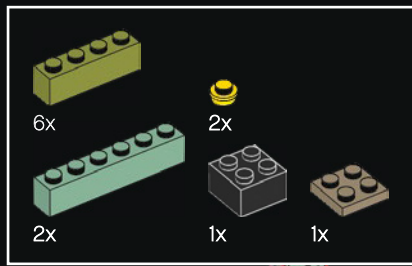

28

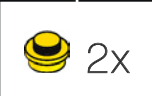
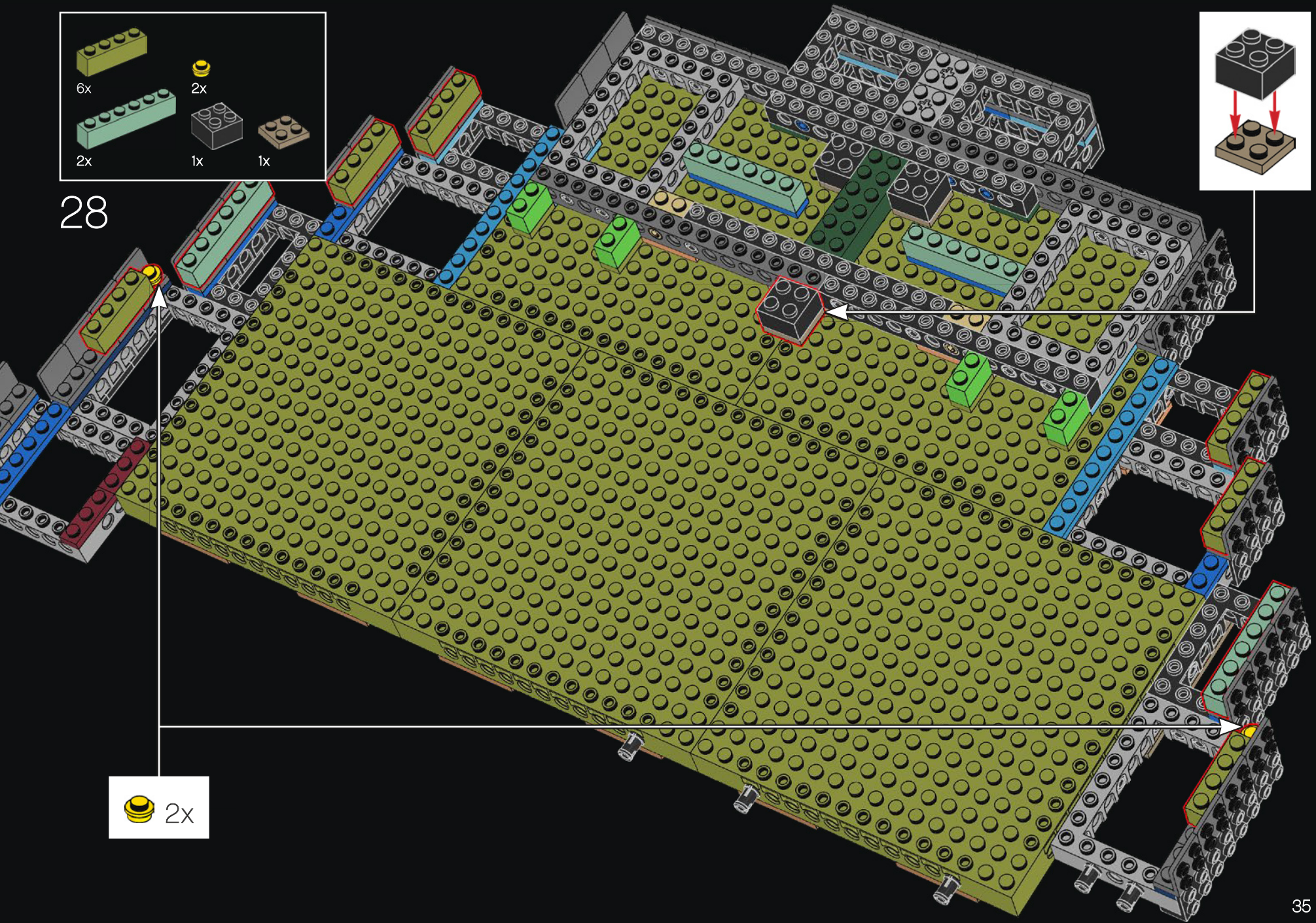
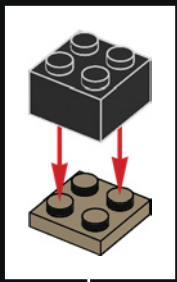

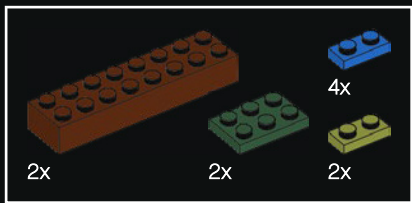

29

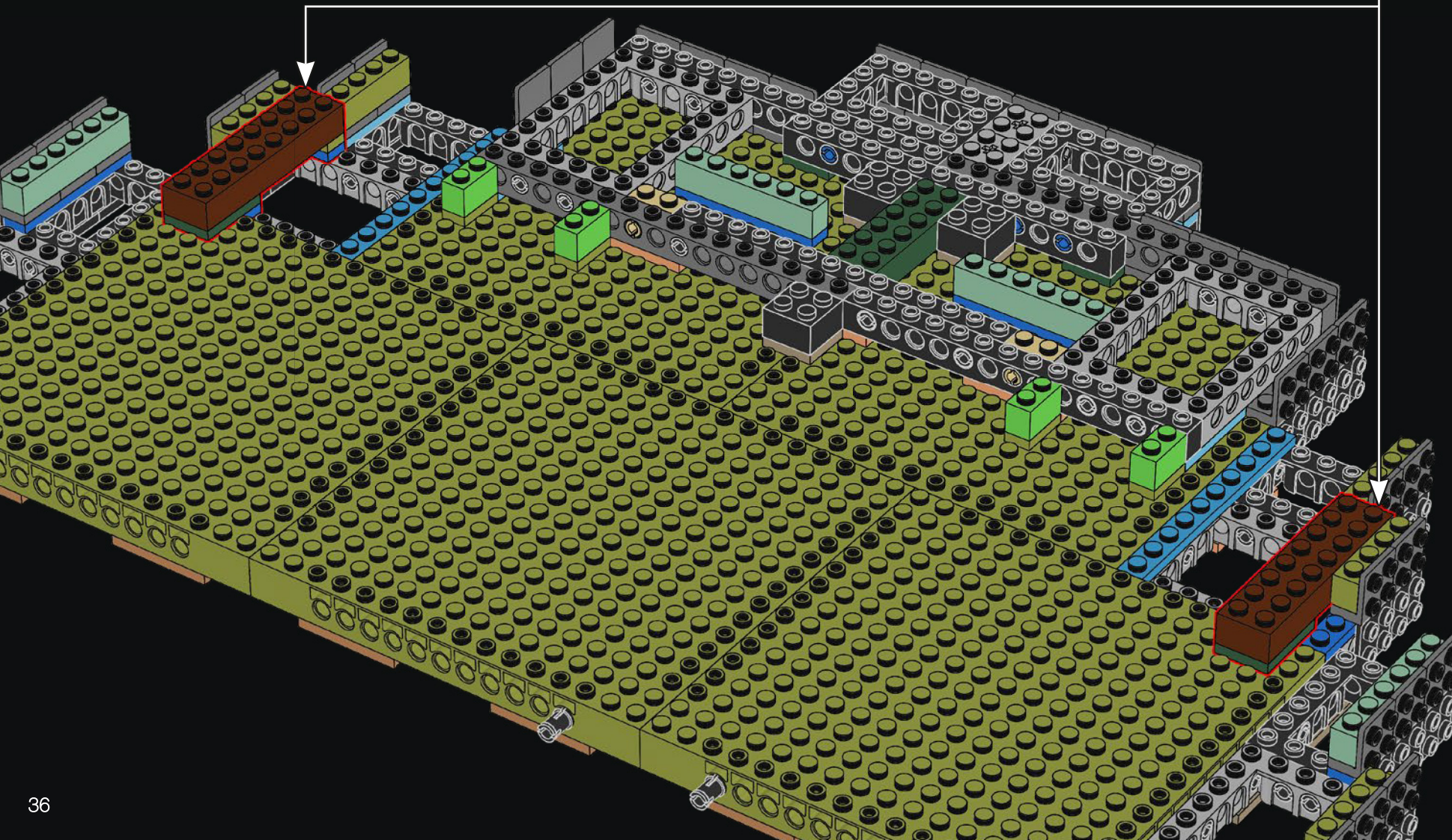
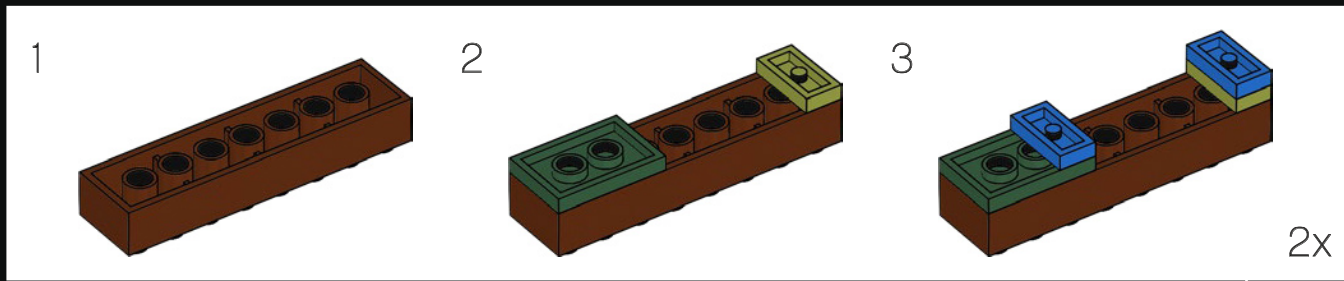

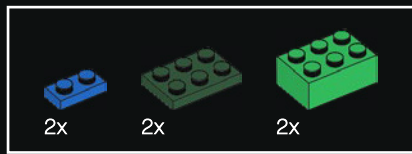

30

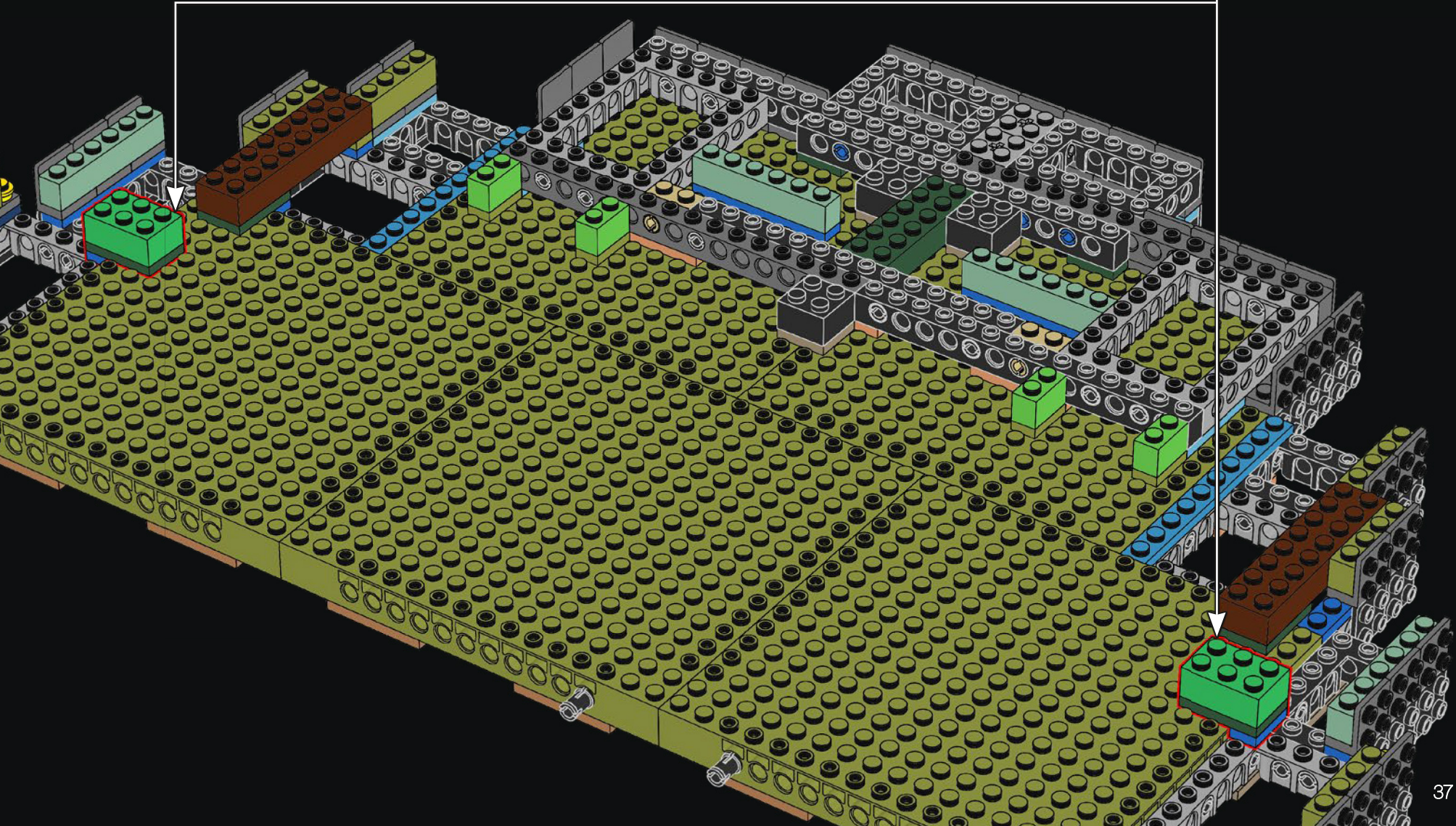
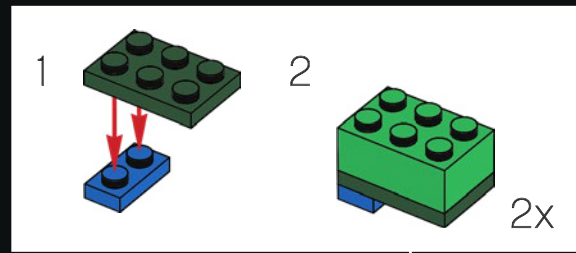

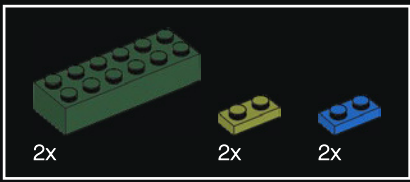

31

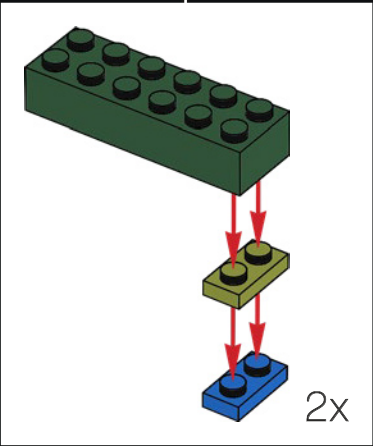
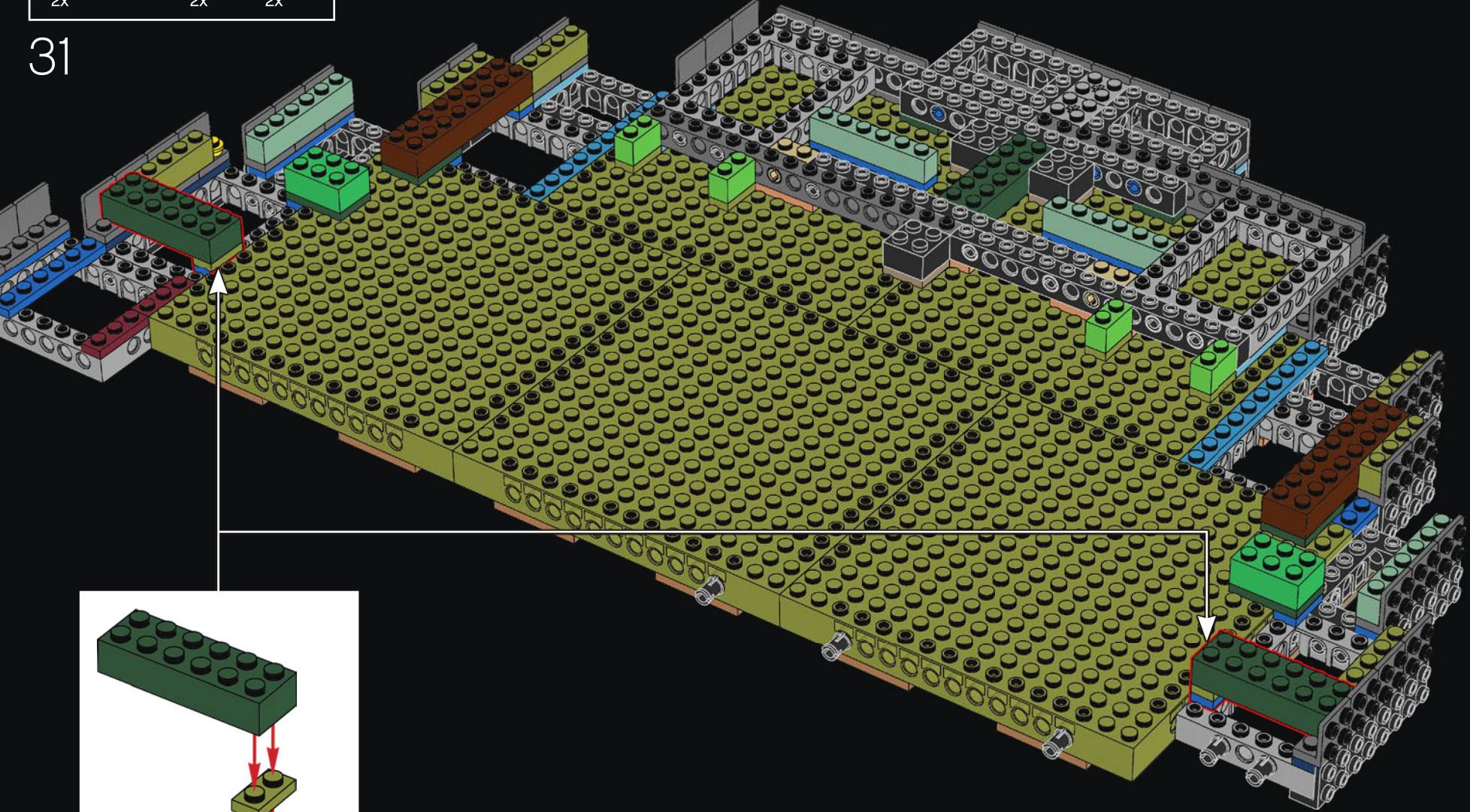

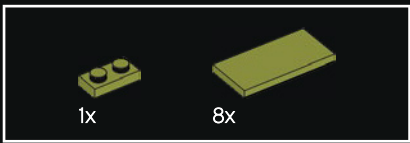

32



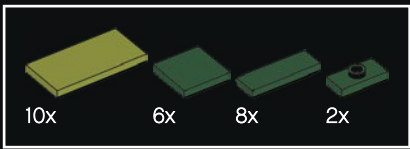

33

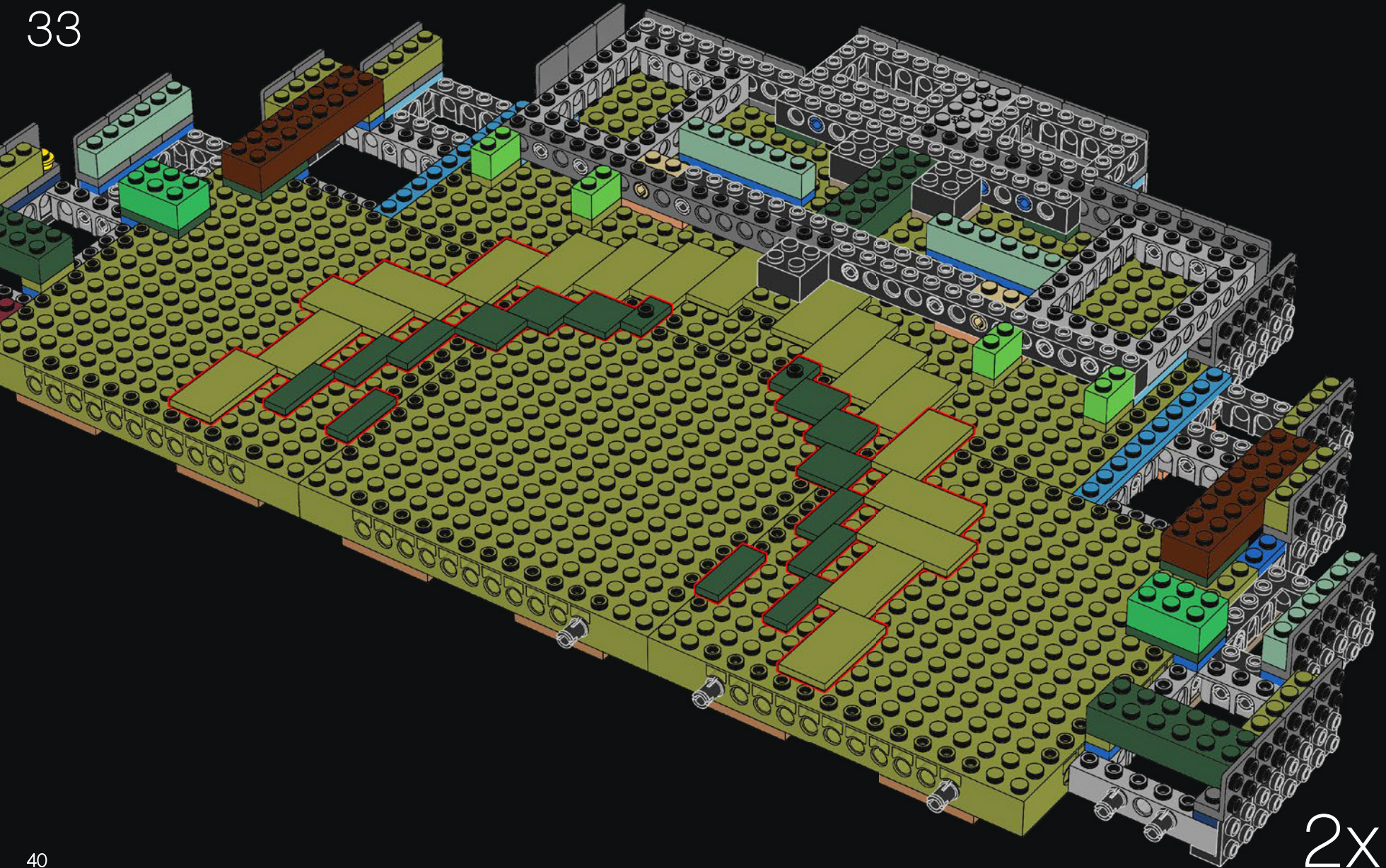

2x

34

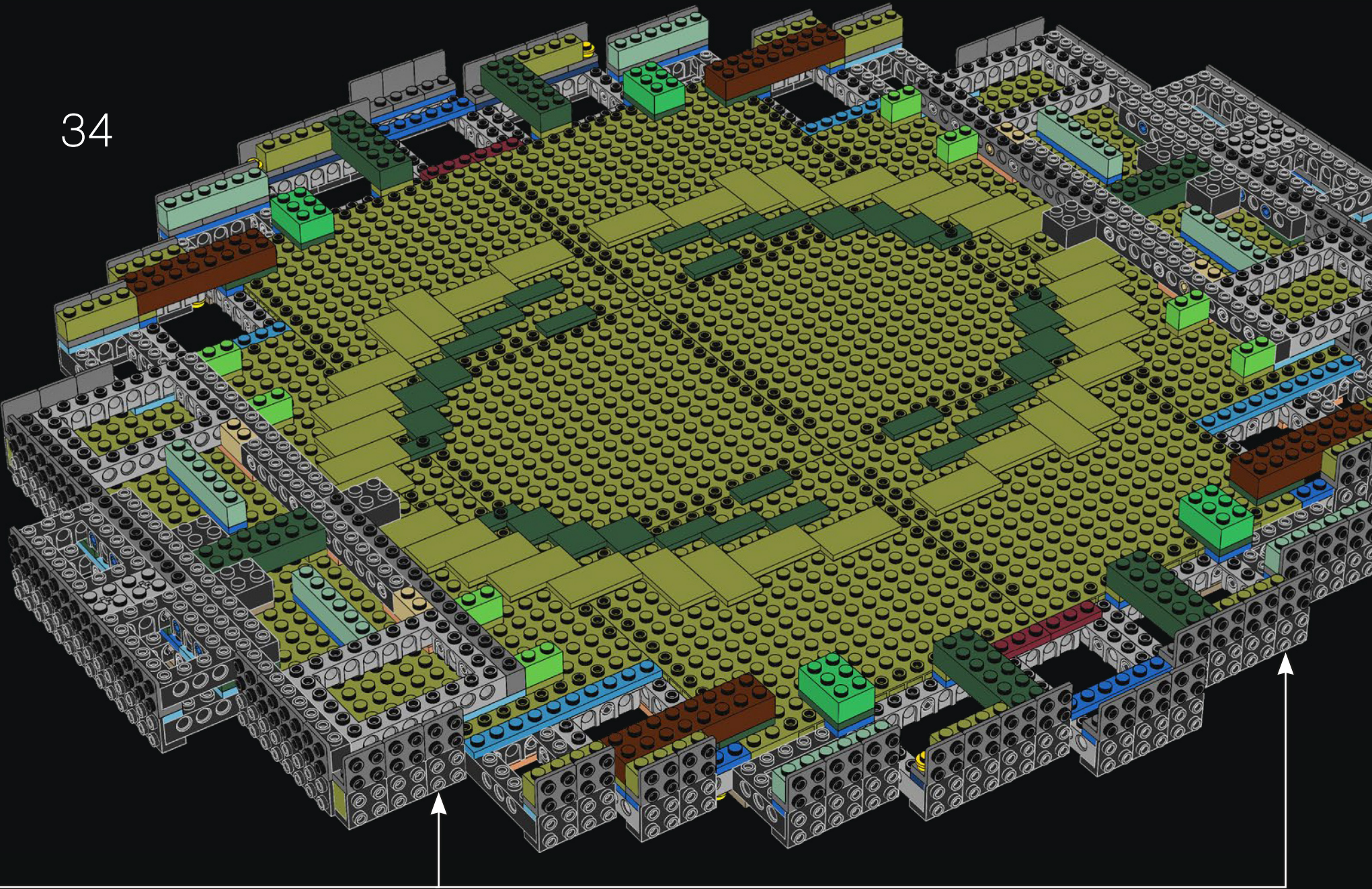

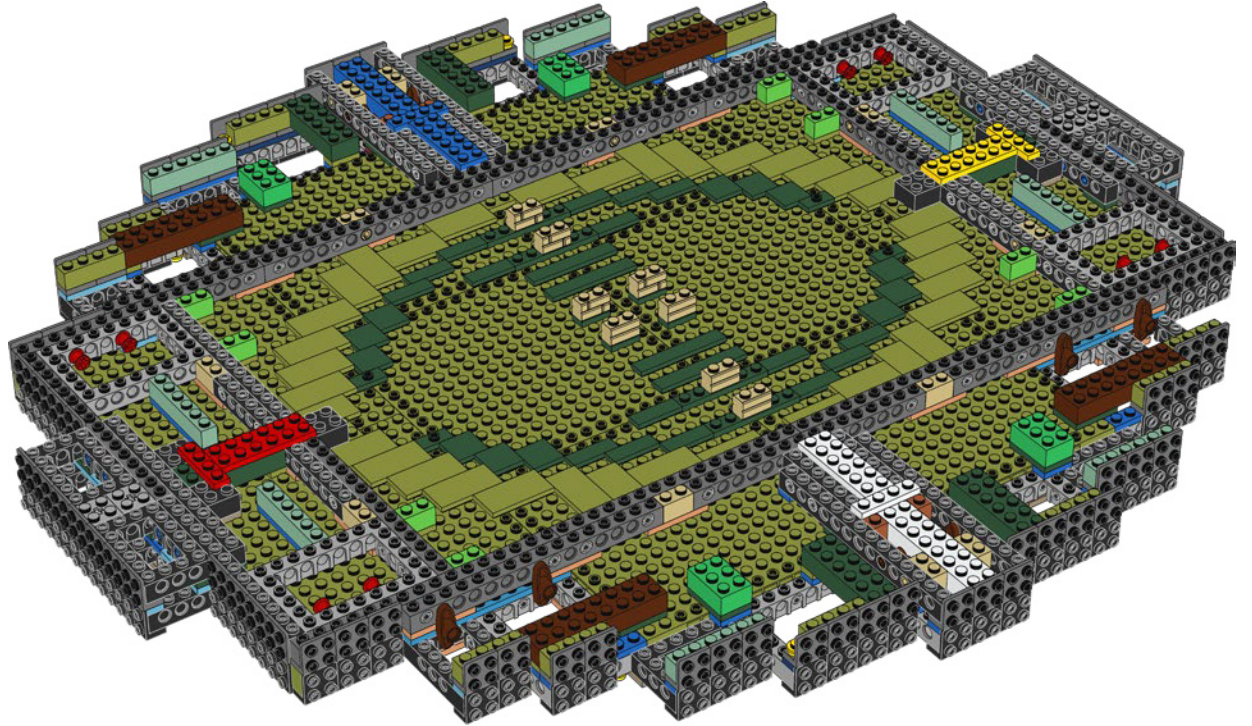
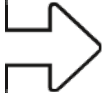
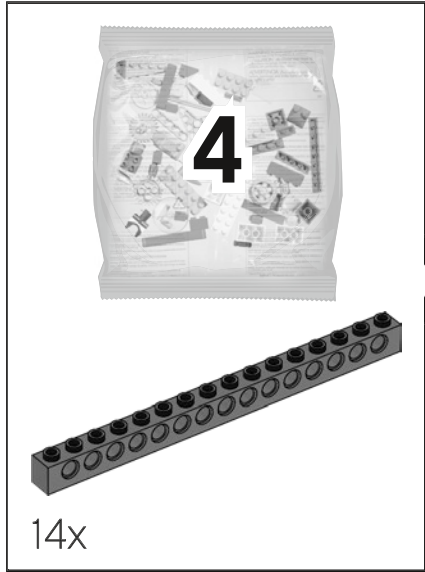

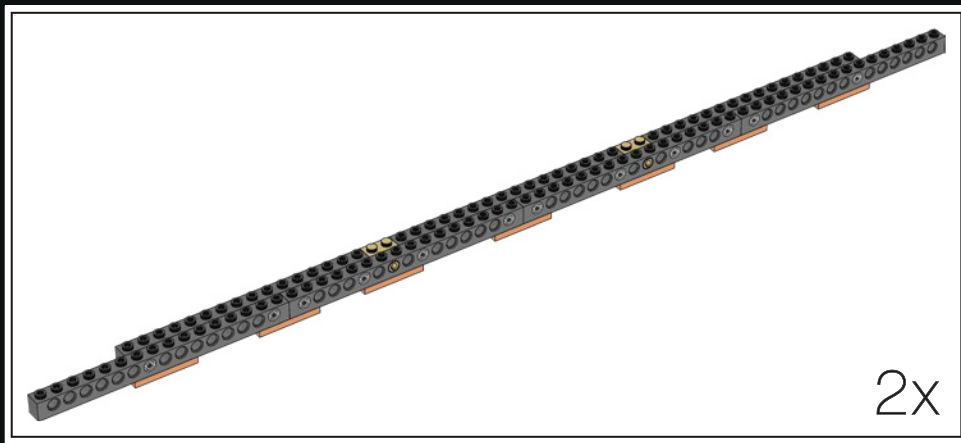

2x

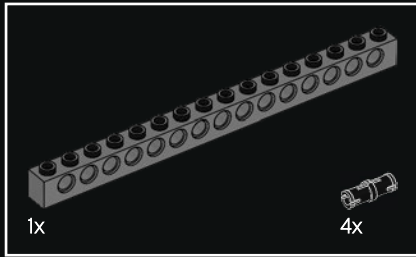

1x

4x

35

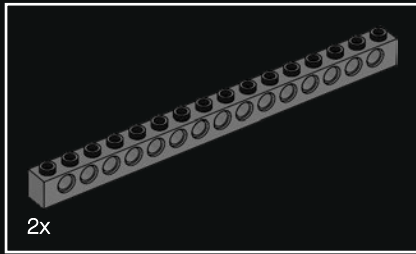
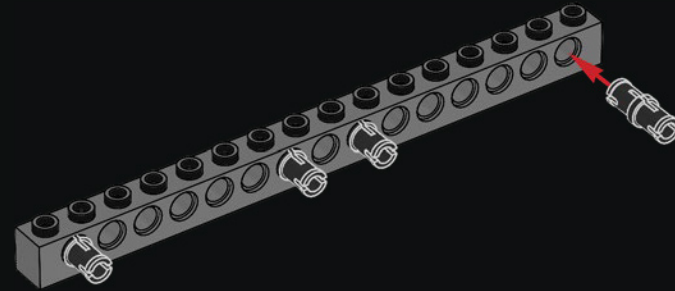

2x

36

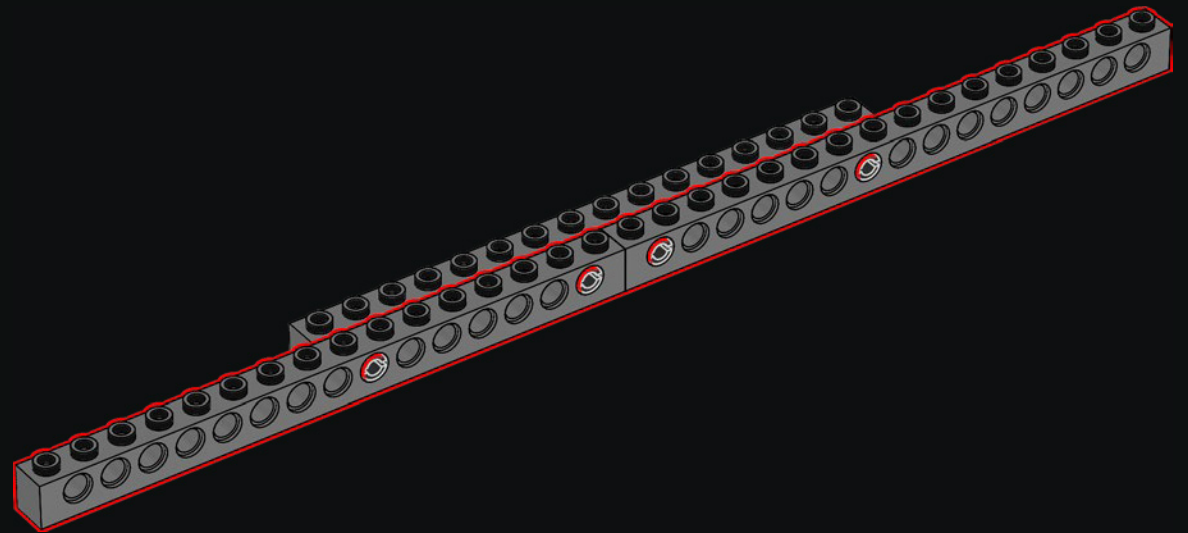



37

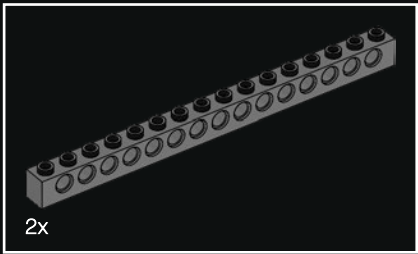
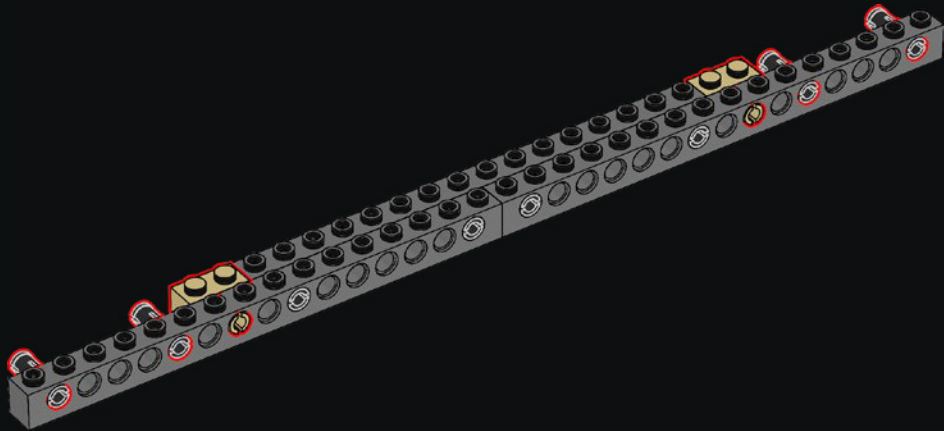

38

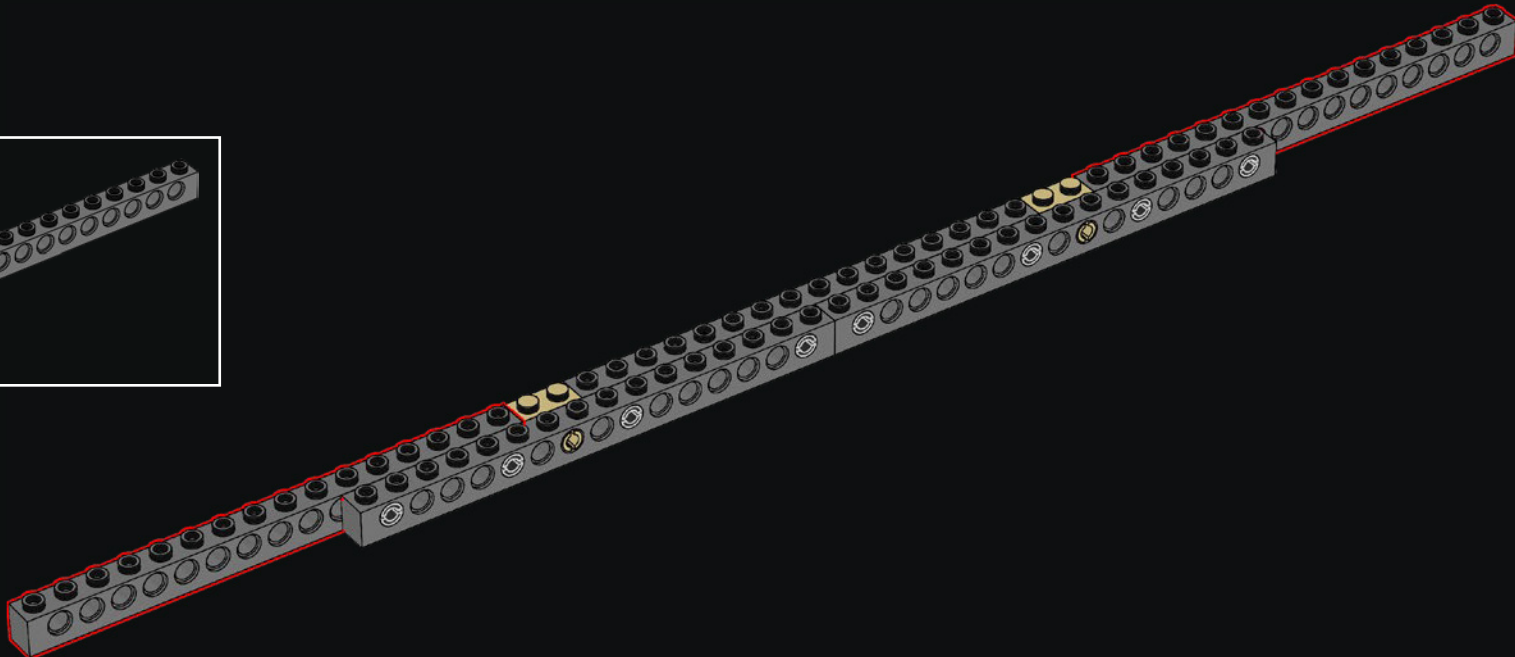



39

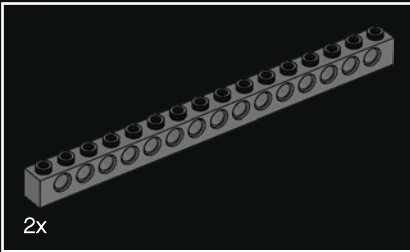
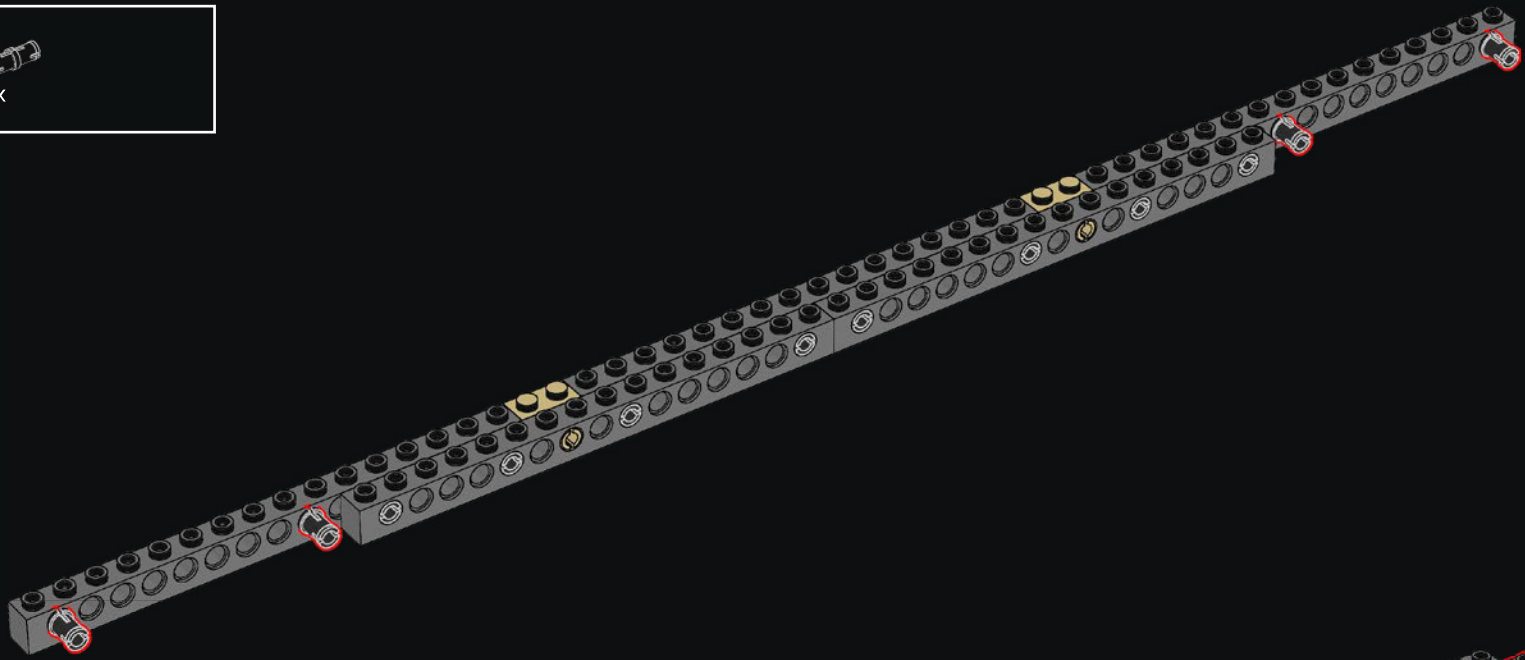

40



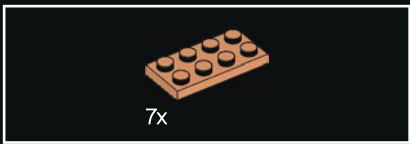

41

Das Kolosseum trug auch den Namen *Amphitheatrum Flavium*, denn die 3 Kaiser aus der Dynastie der Flavianer bauten und veränderten das Bauwerk.

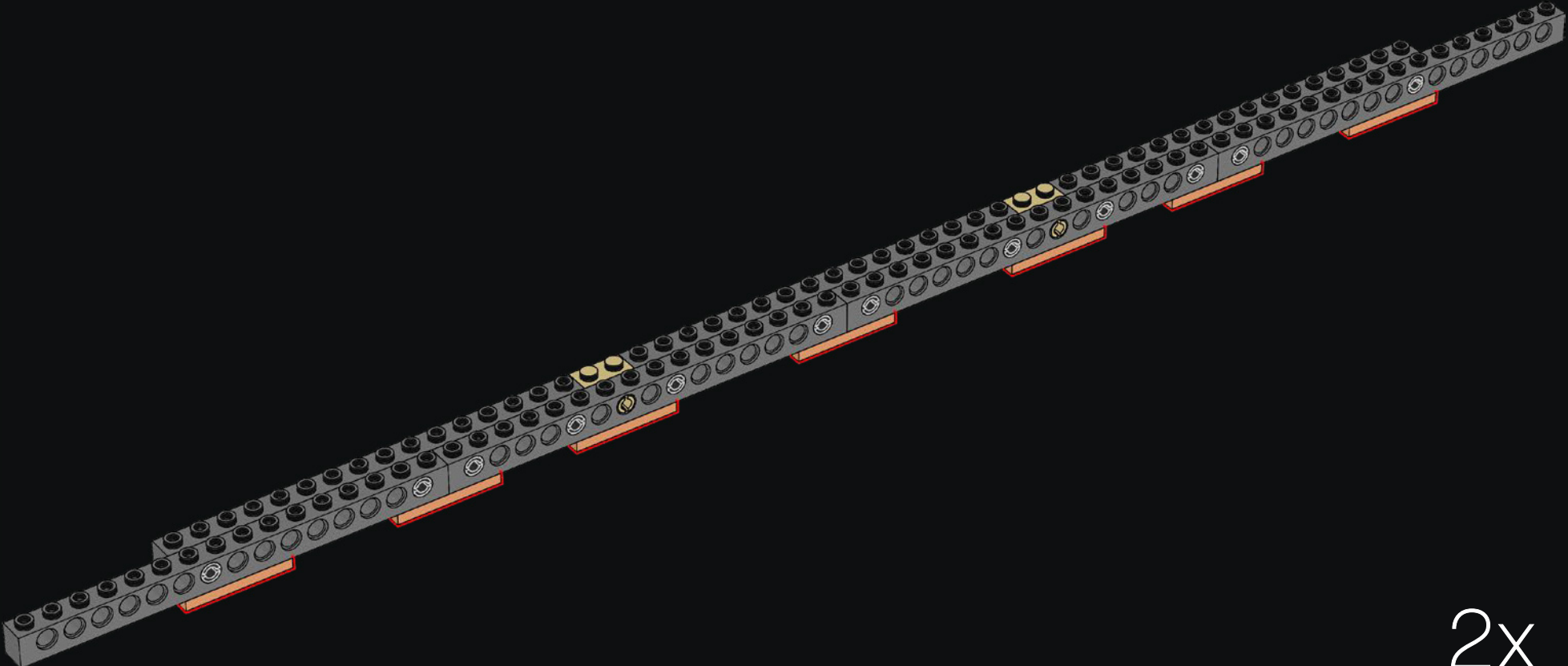

2x

42

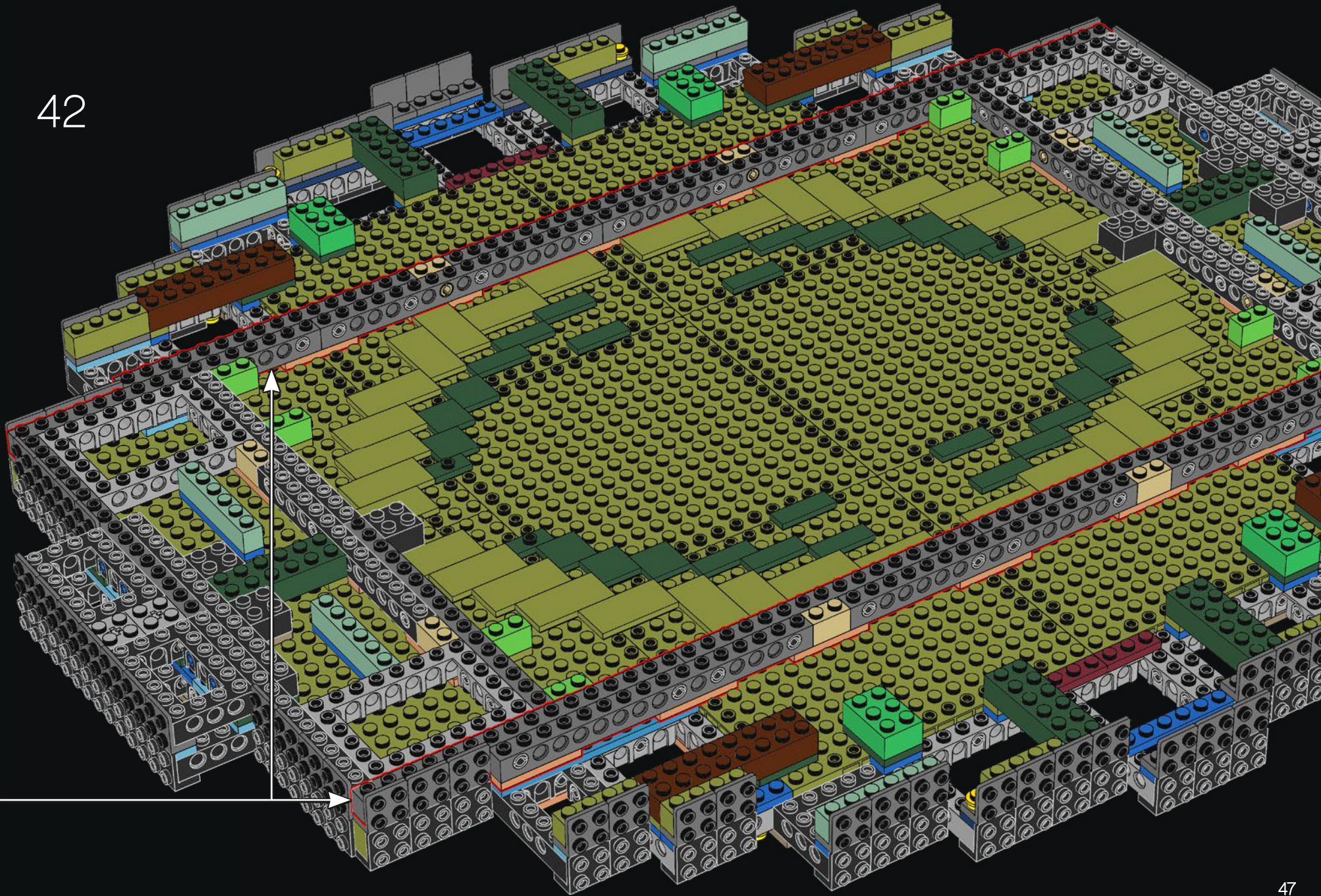



43

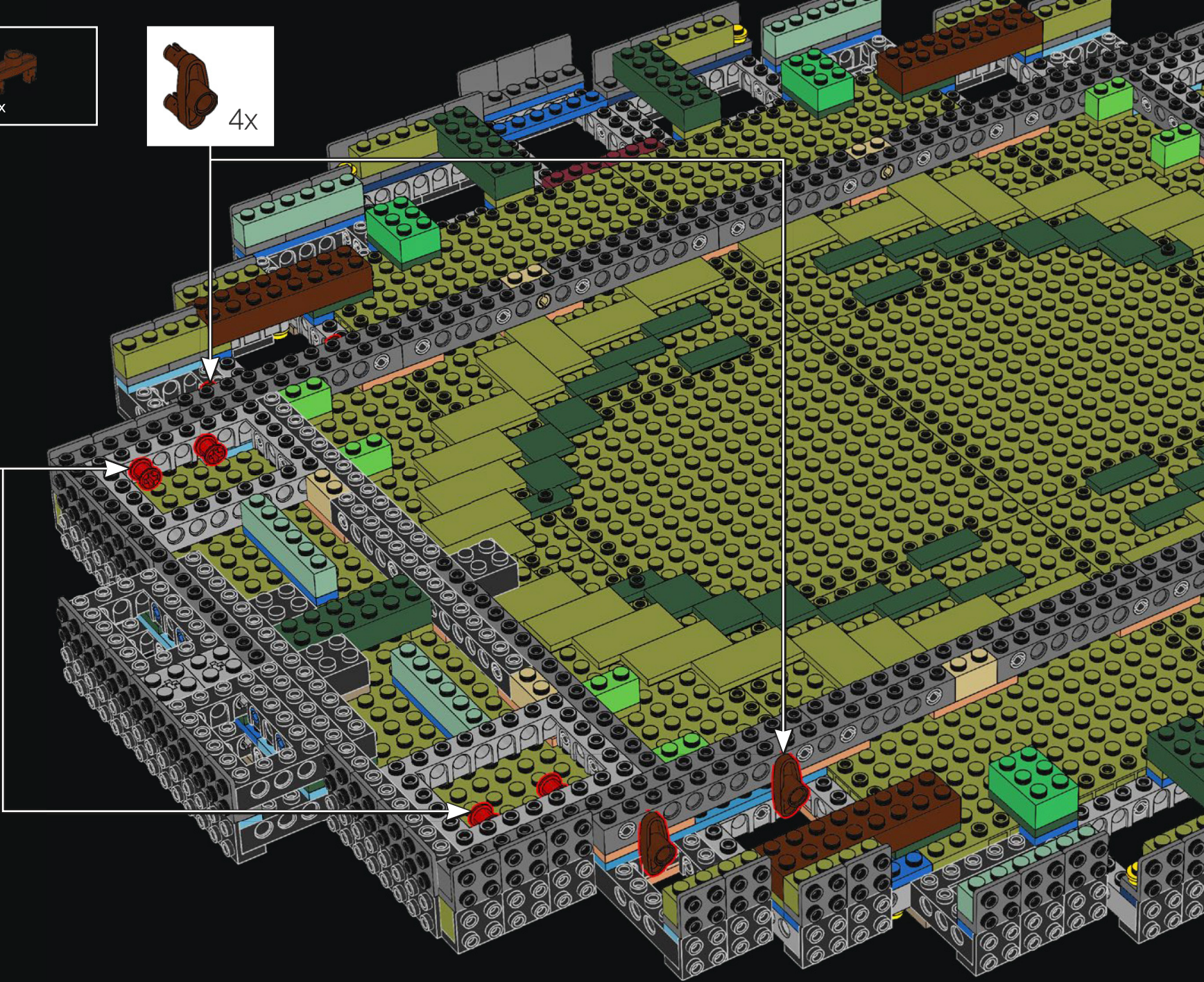

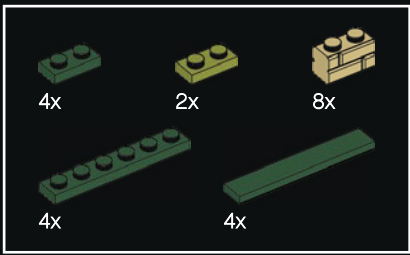

45

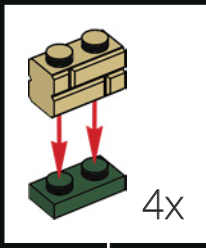
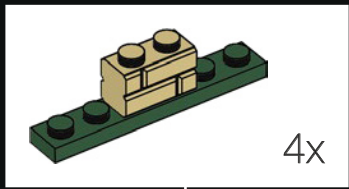
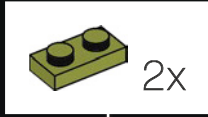

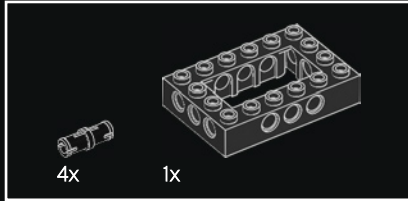
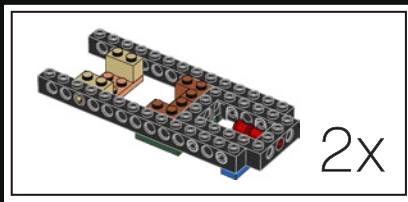

46

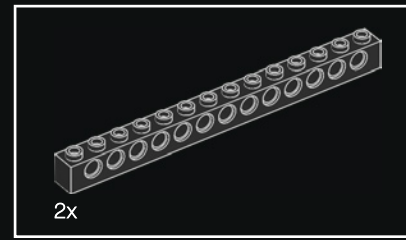
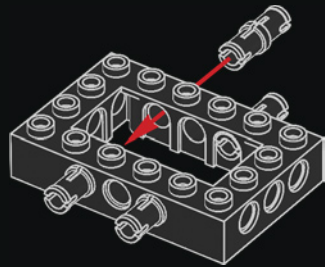

47

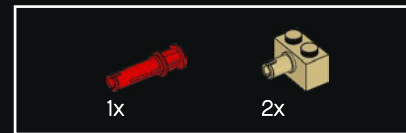
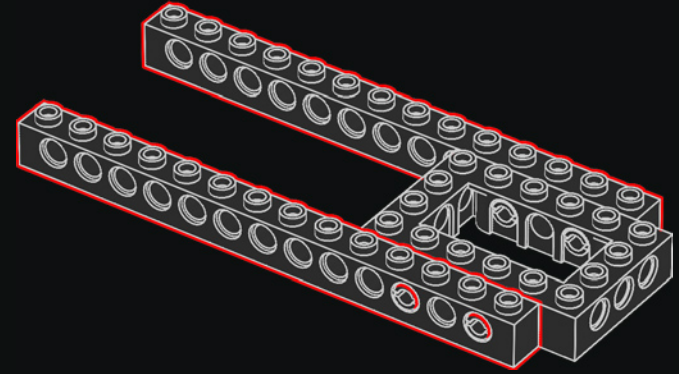

48

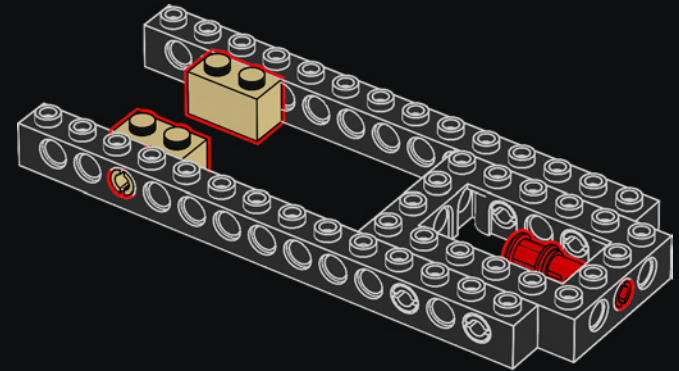

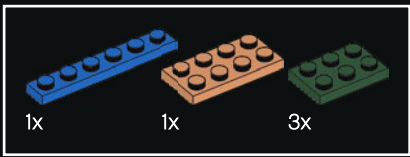

49

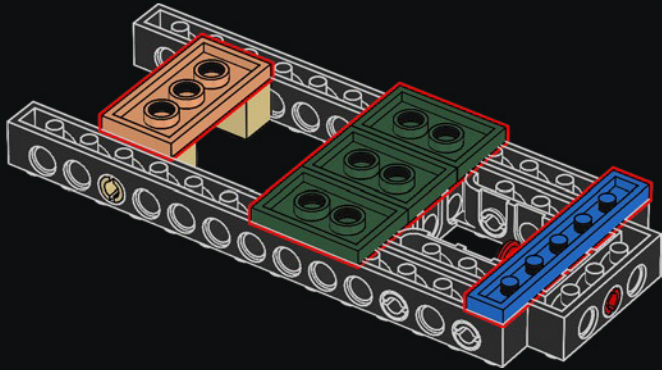

50

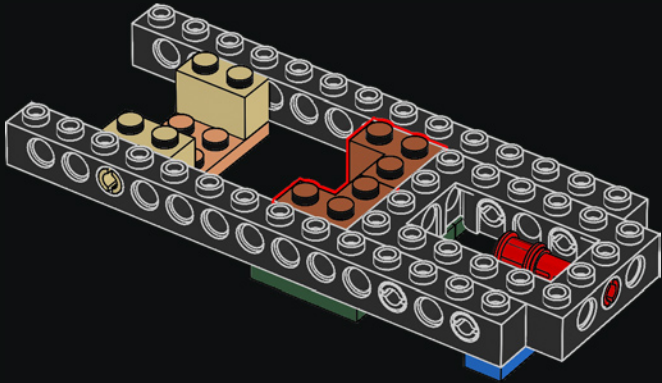

2x

51

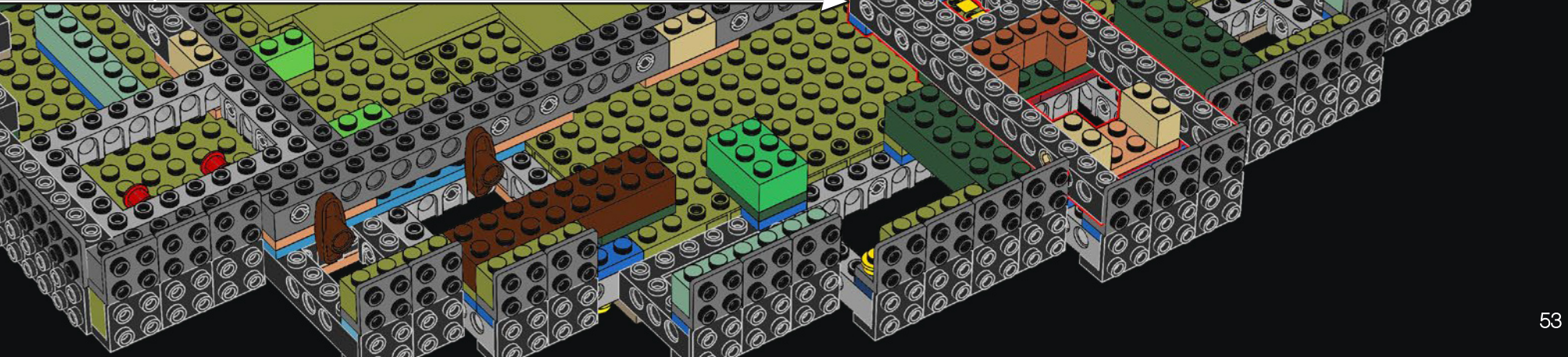
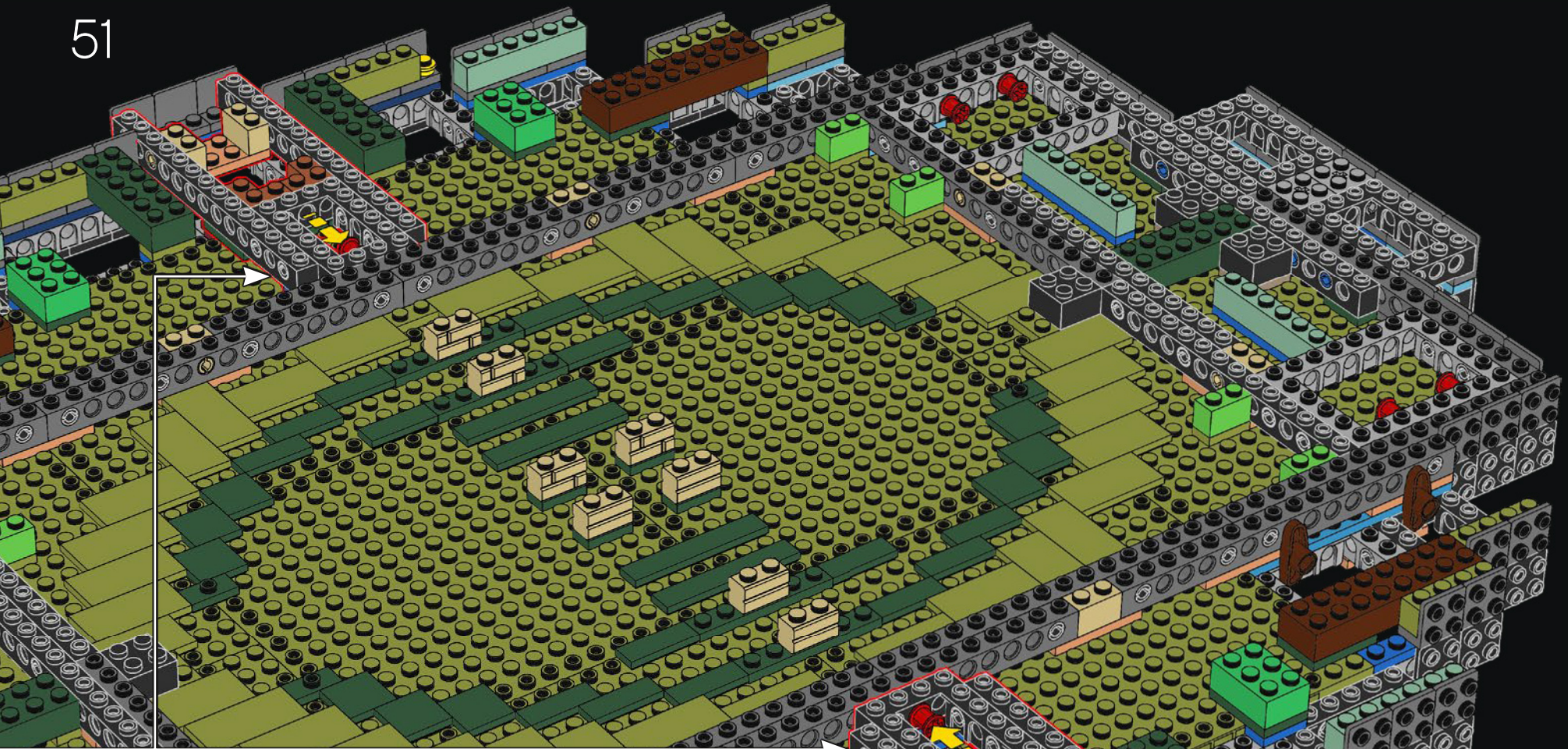



52

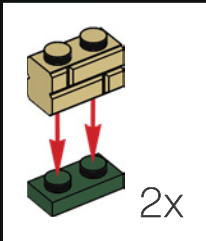

54

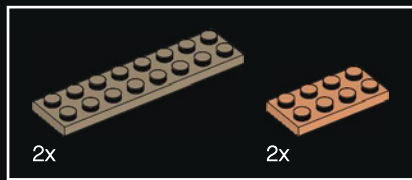

53

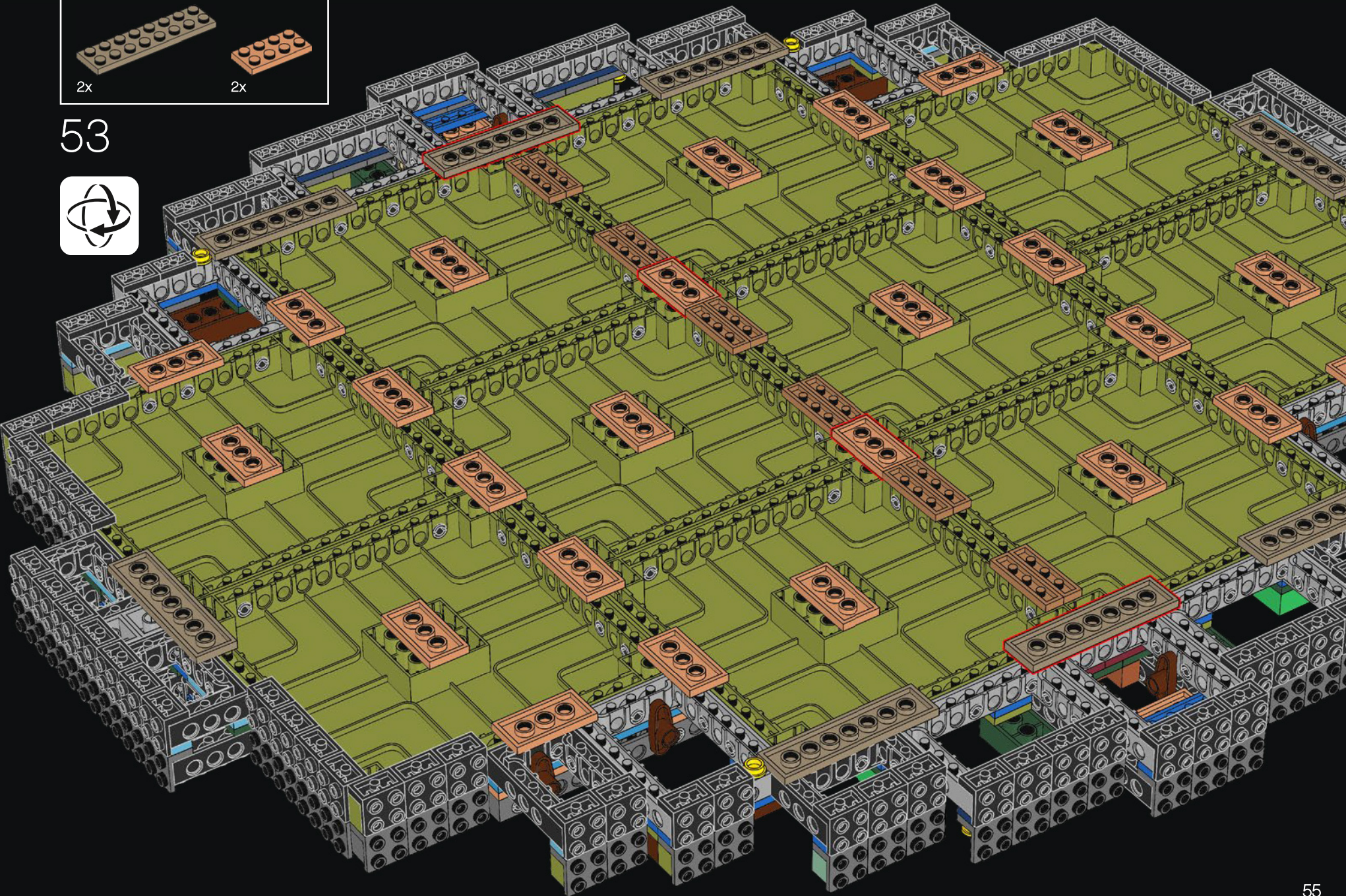

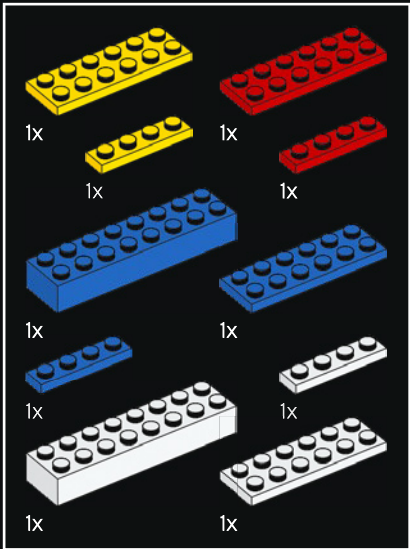

54



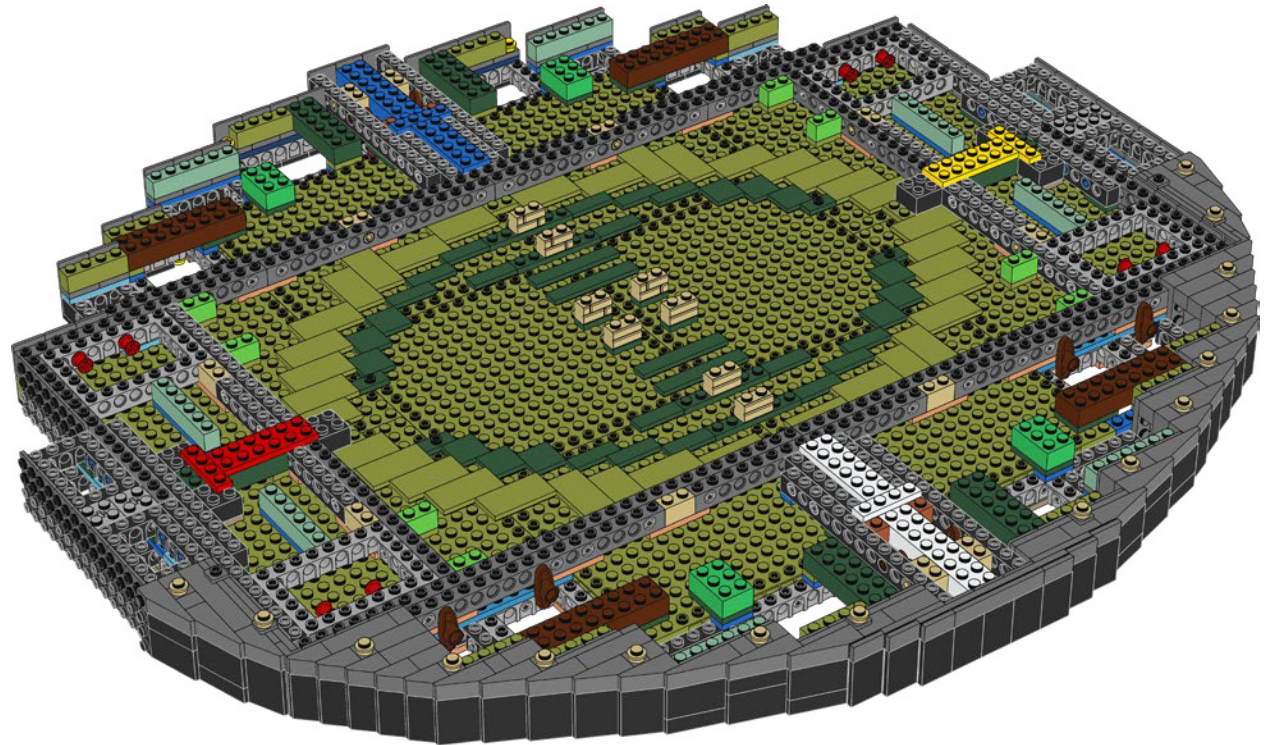
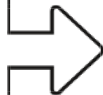

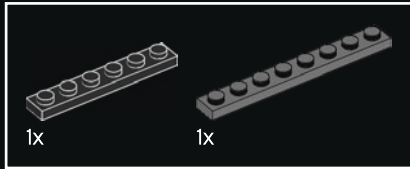
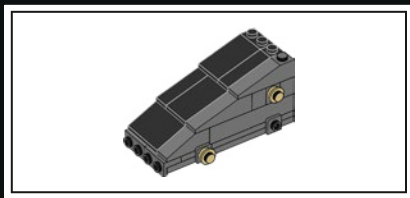

55

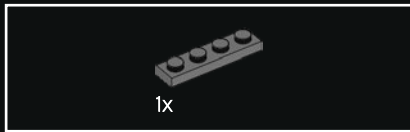
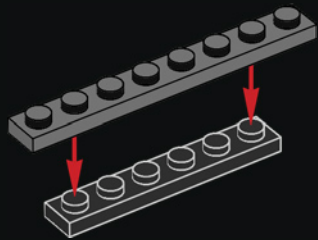

56

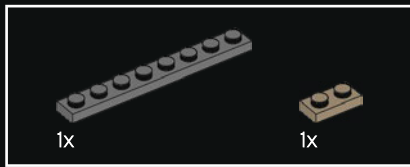
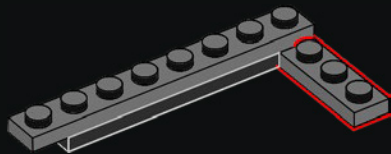

57

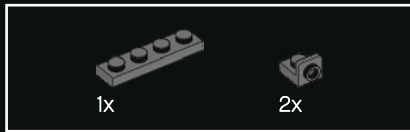
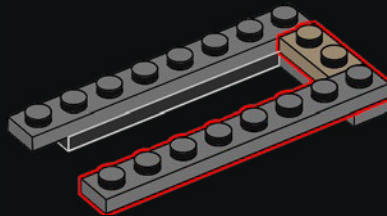

58

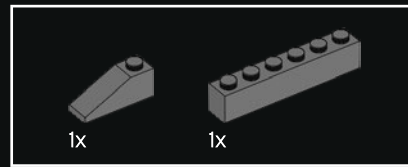
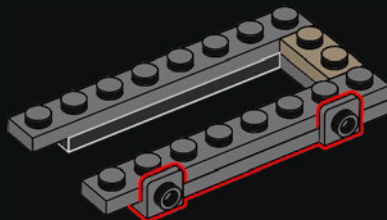

59

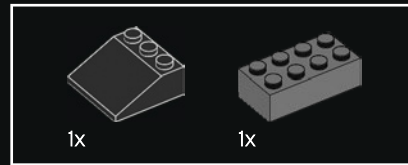
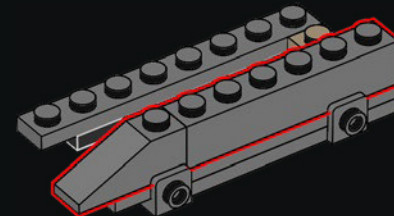

60

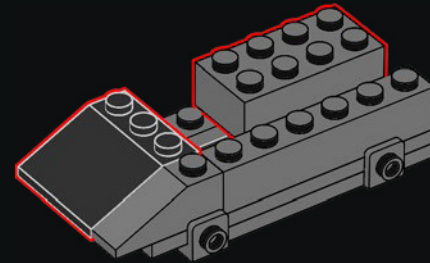

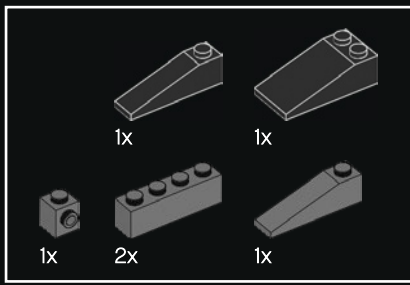

61

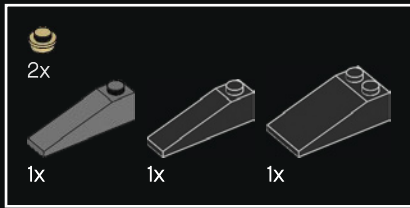
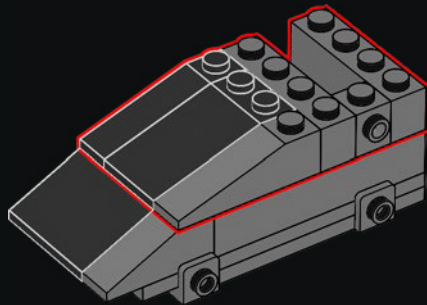

62

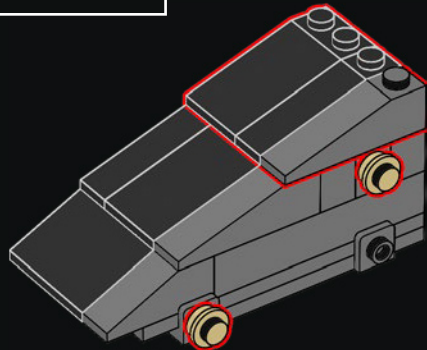

63

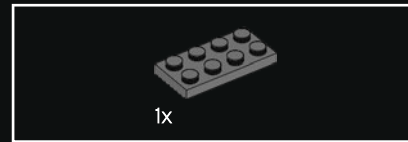
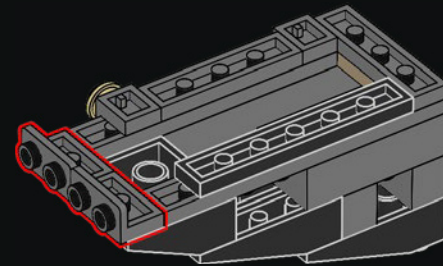

64

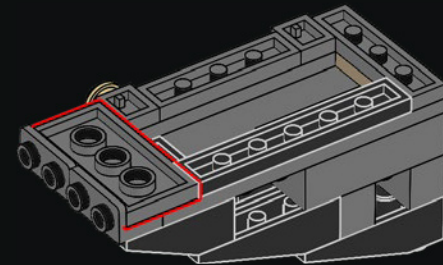

65

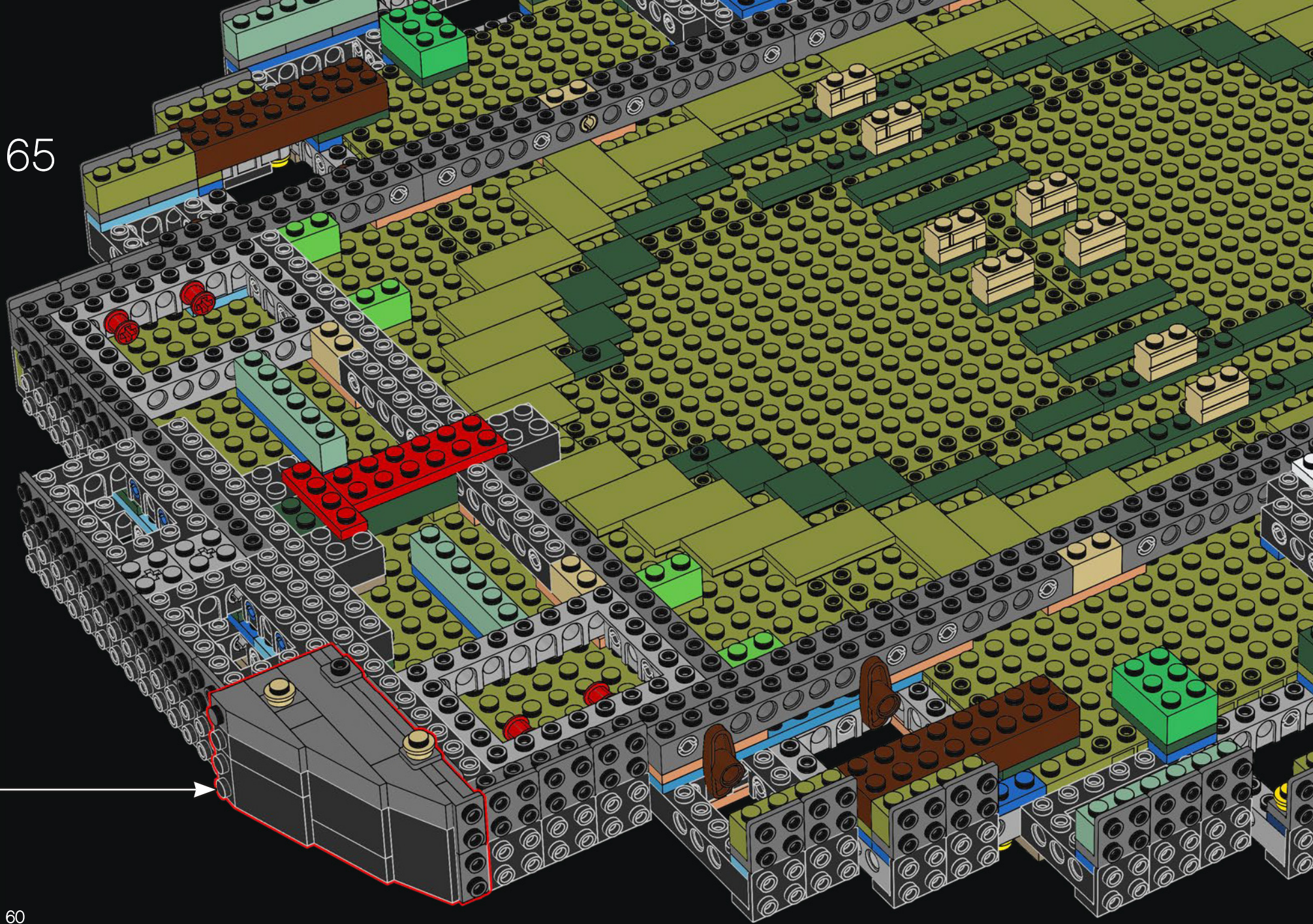

60

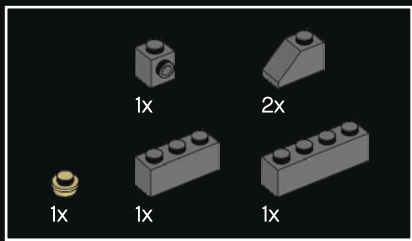

70

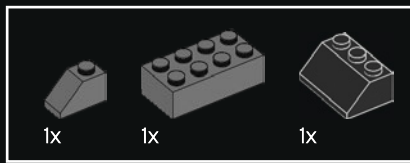
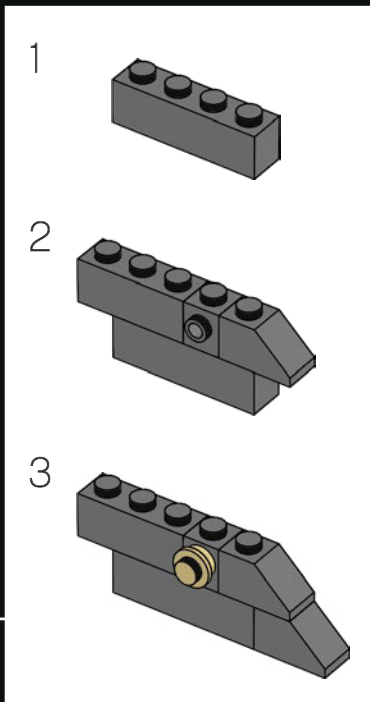
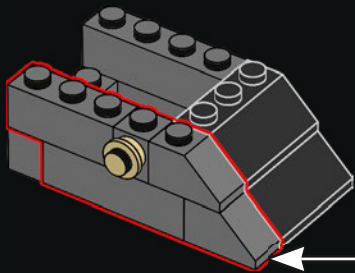

72

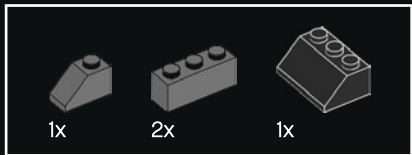
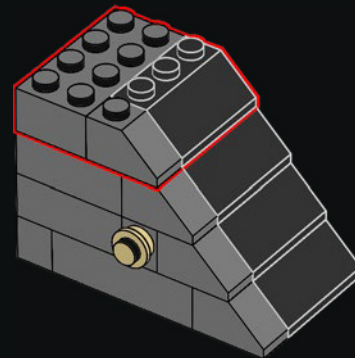

71

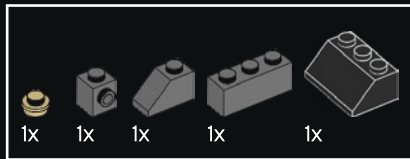
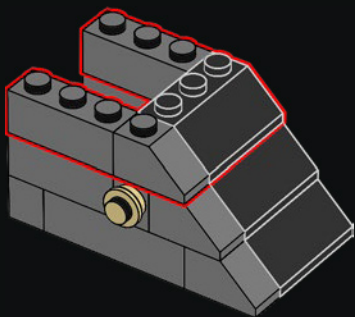

73

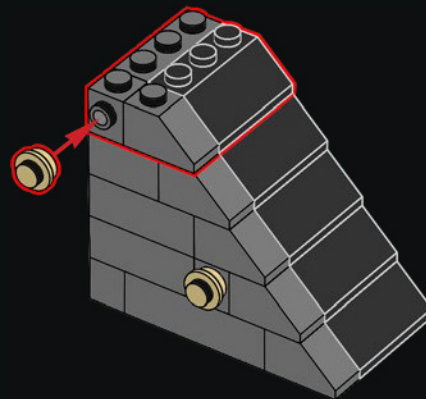

74

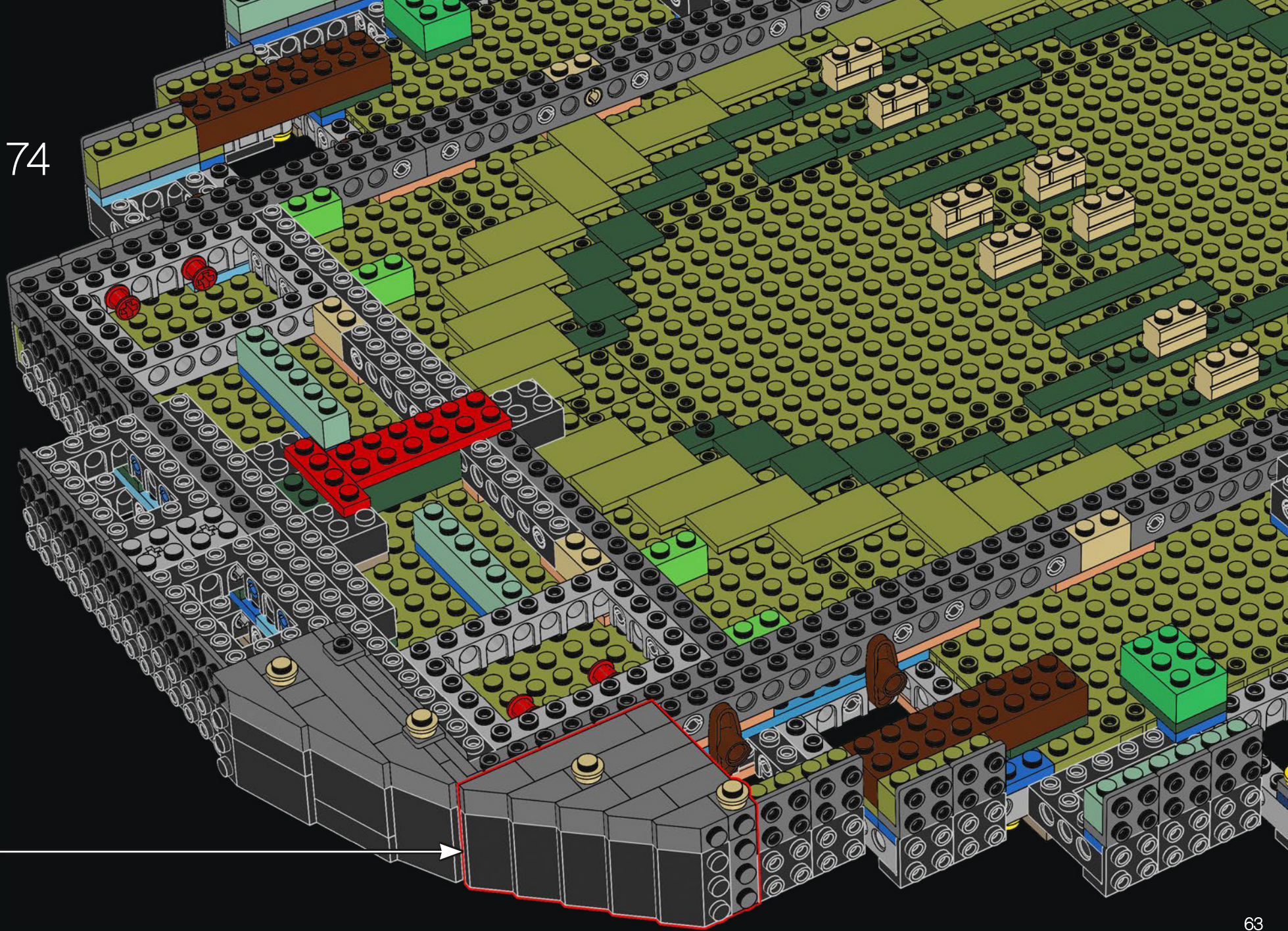

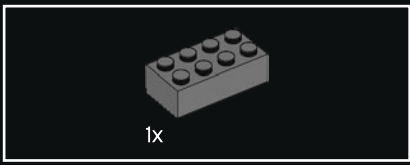

75

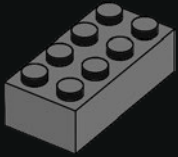

76

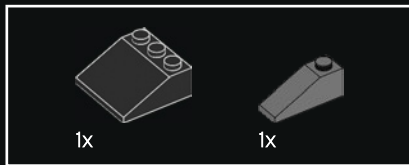
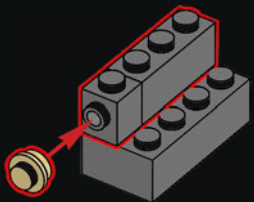

77

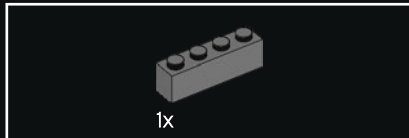
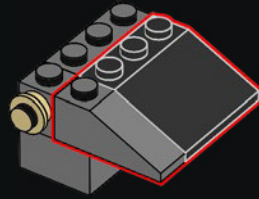

78

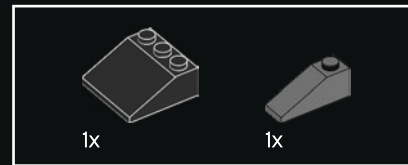
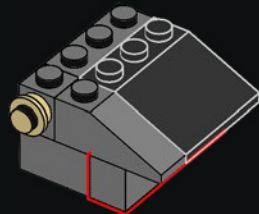

79

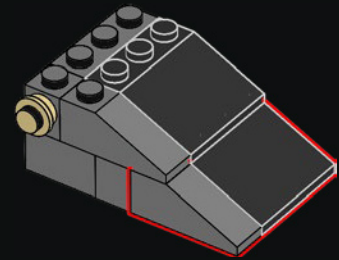

80

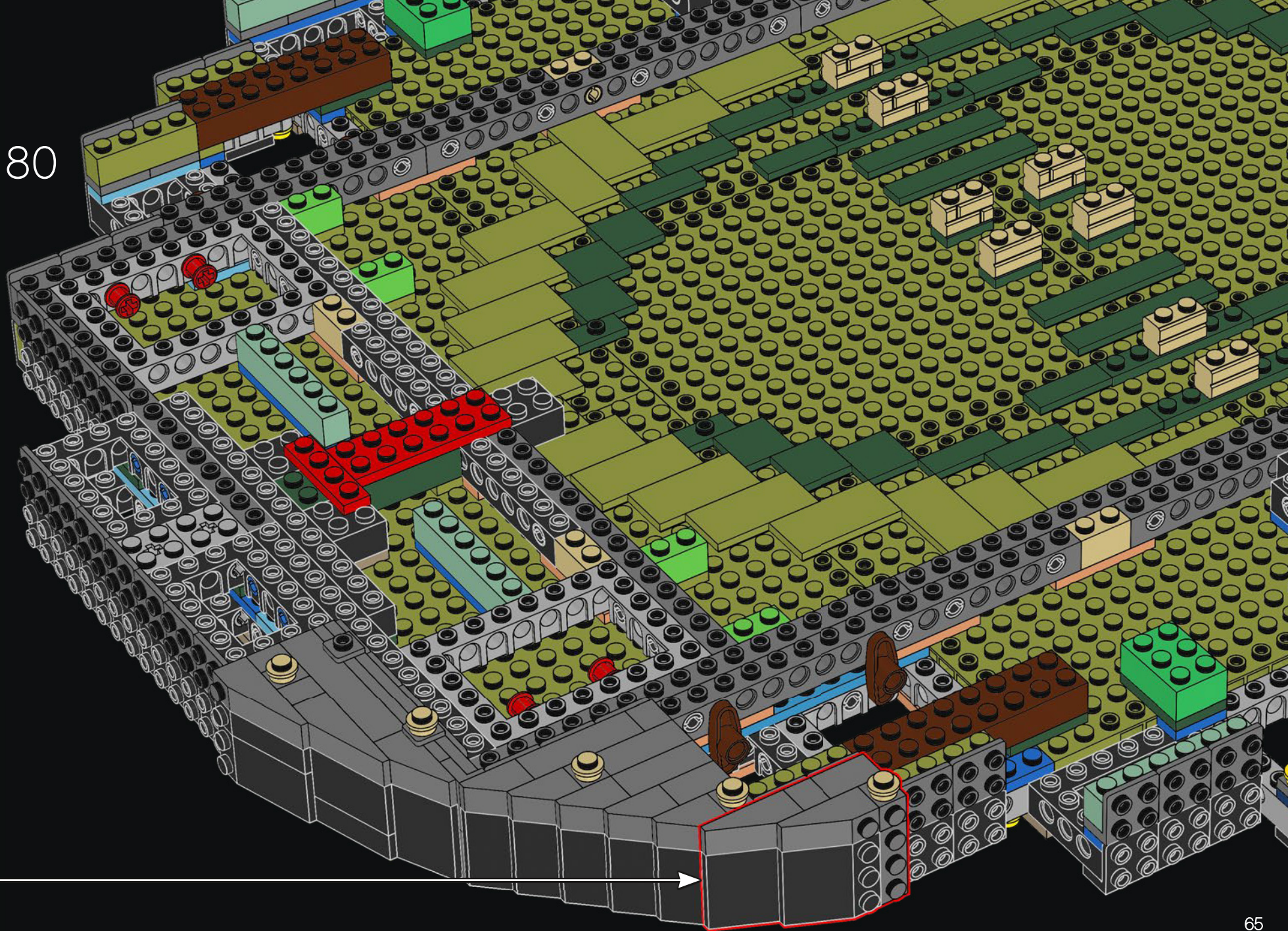

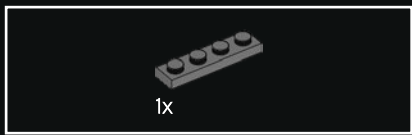

81

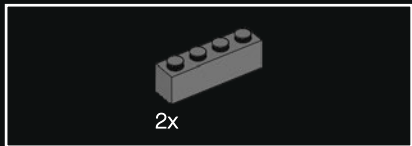
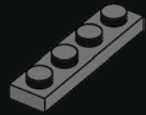

82

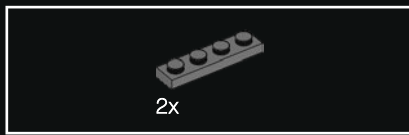
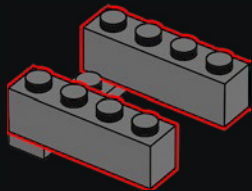

83

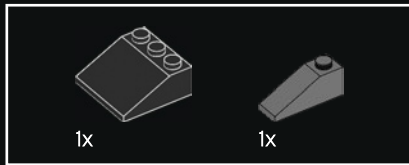
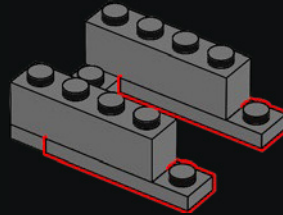

84

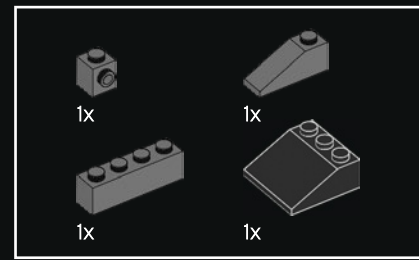
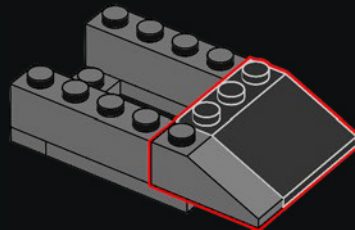

85

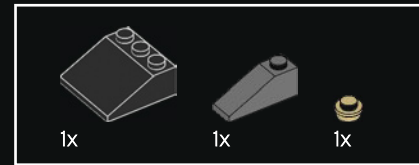
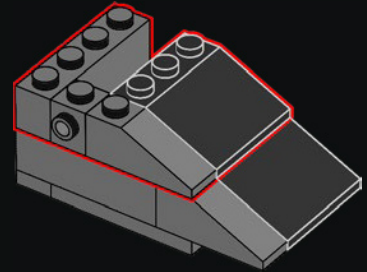

86

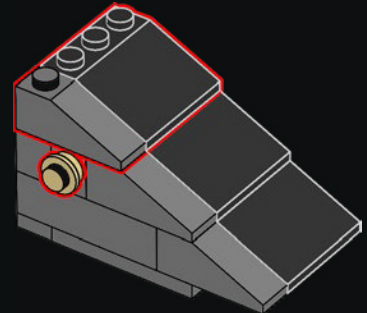

87



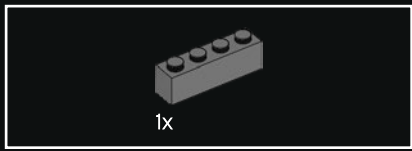

88

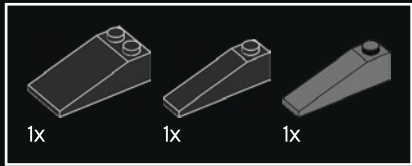
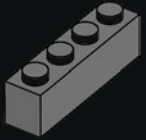

89

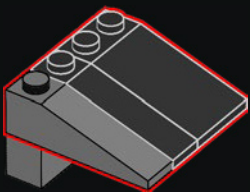

90

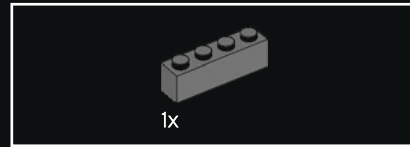
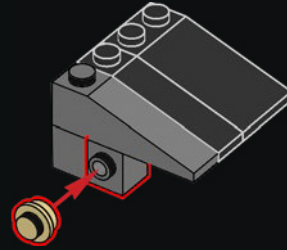

91

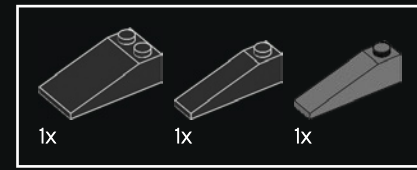
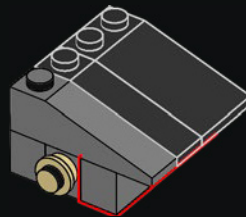

92

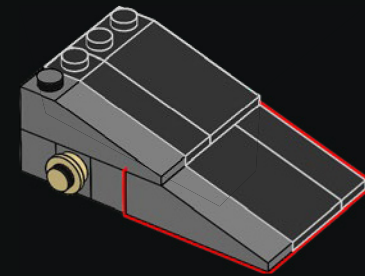

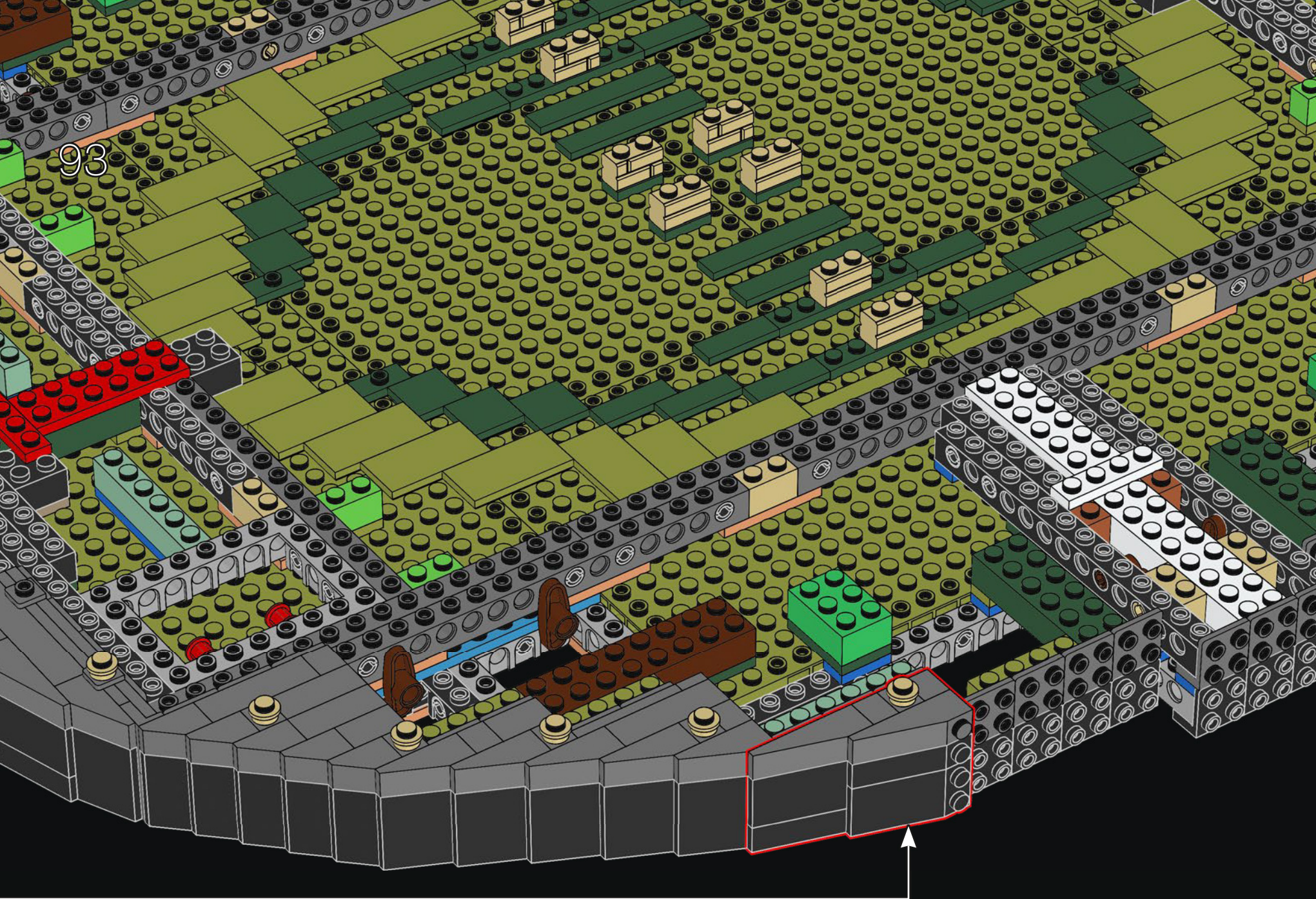

93

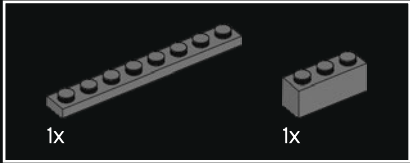
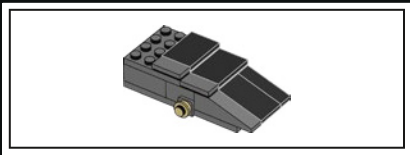

94

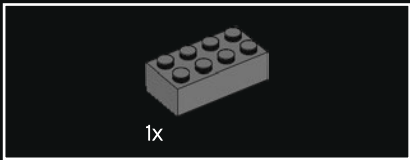
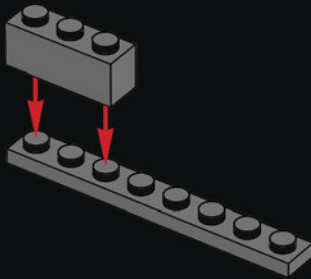

95

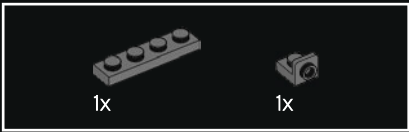
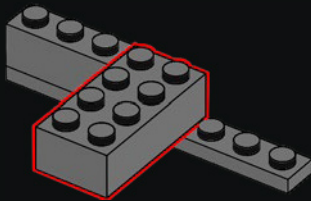

96

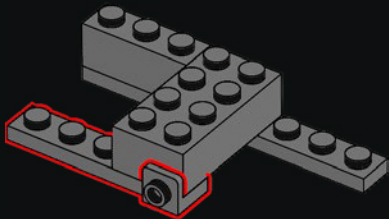

97

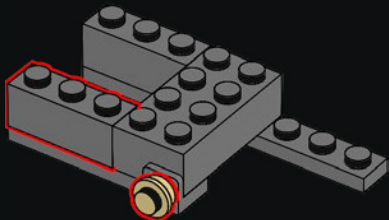

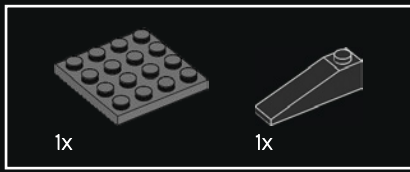

98

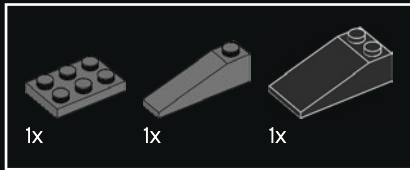
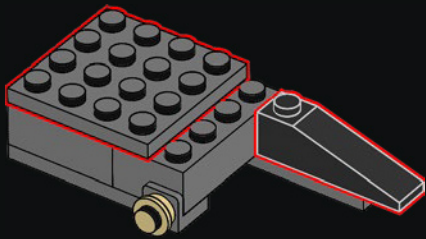

99

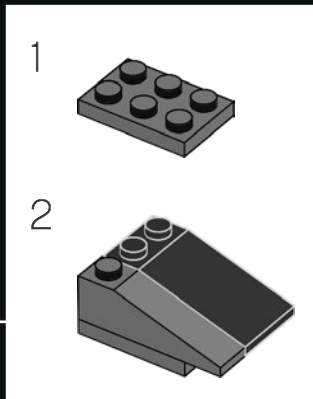
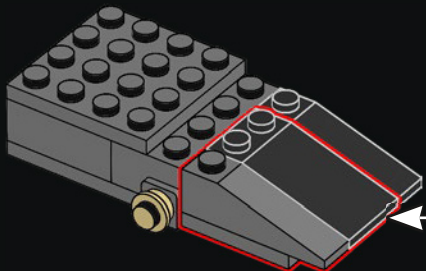

100

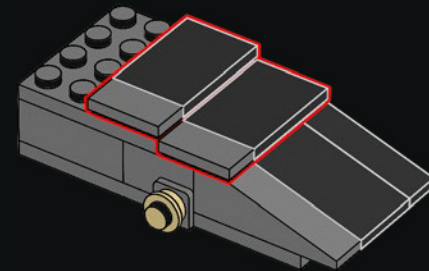

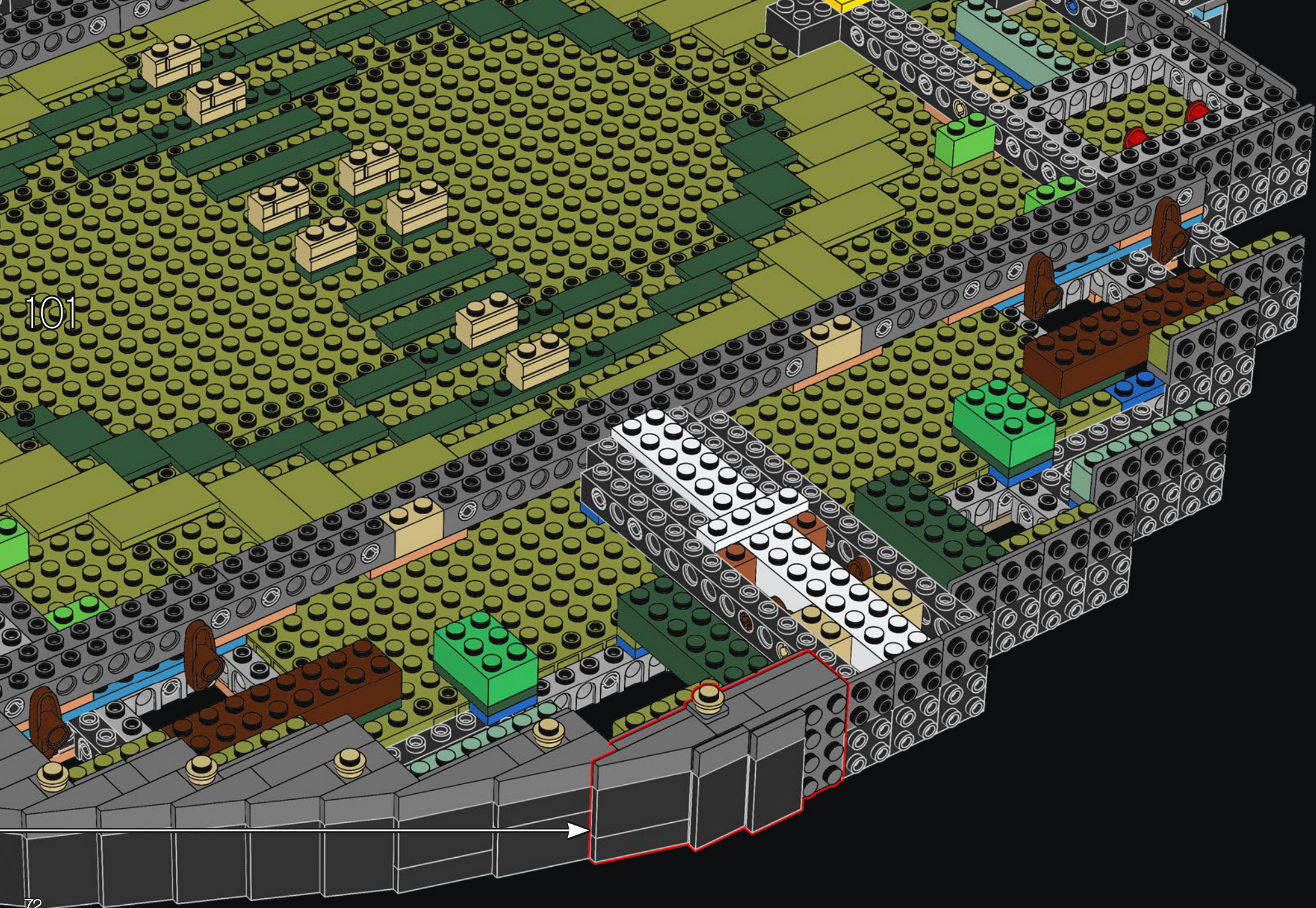

101

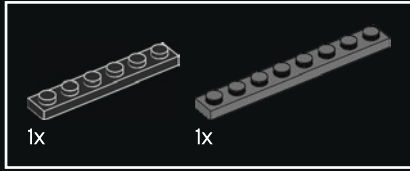
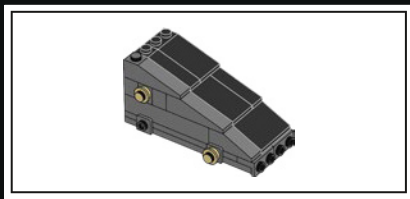

102

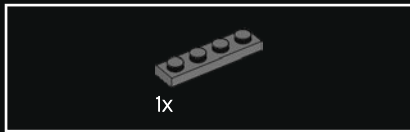
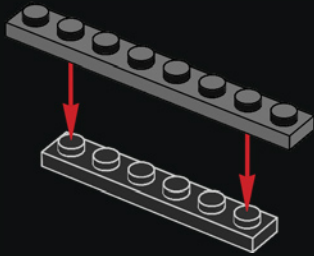

103

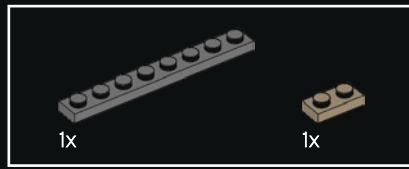
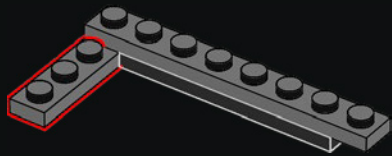

104

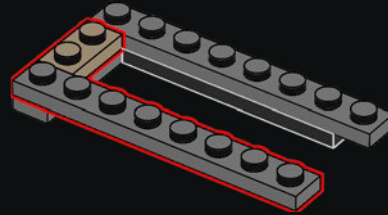

105

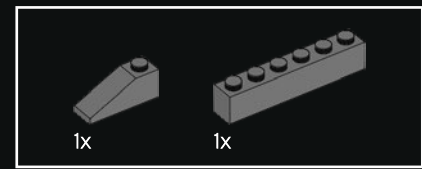
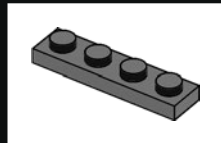
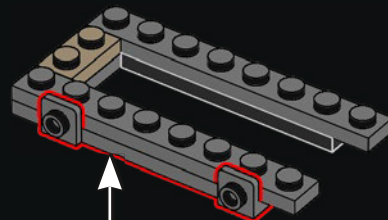

106

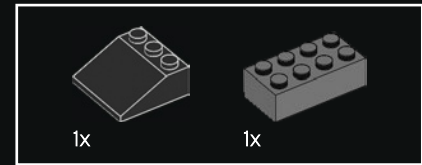
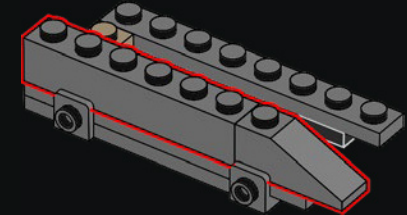

107

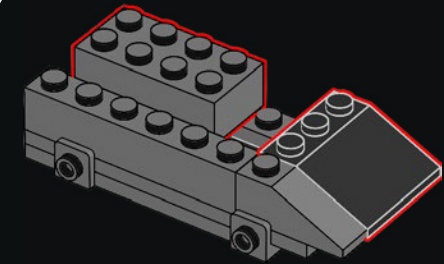

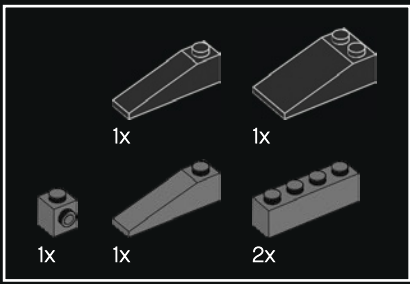

108

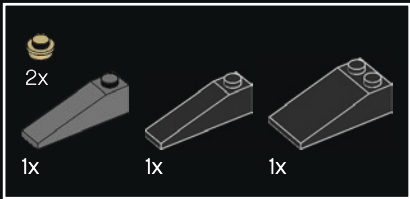
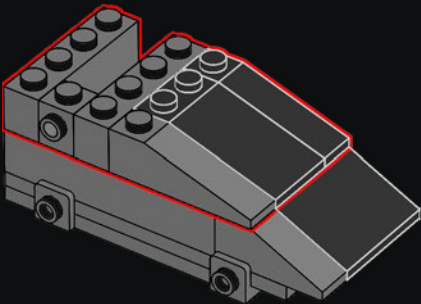

109

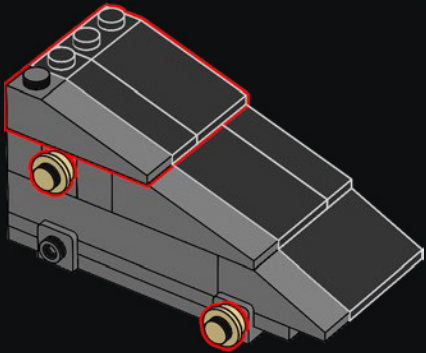

110

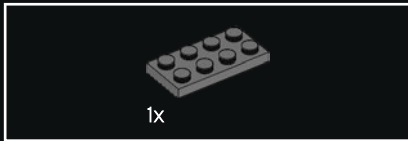
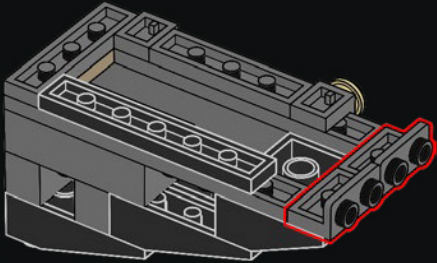

111

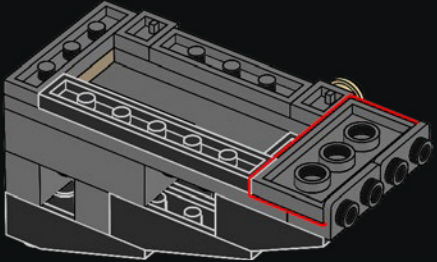



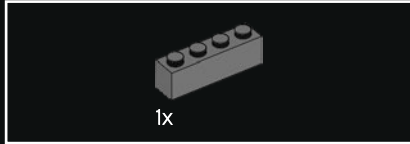
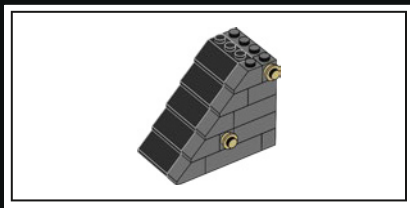

1x

113

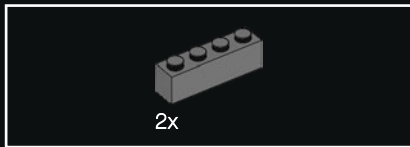
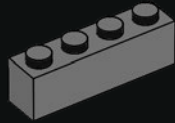

2x

114

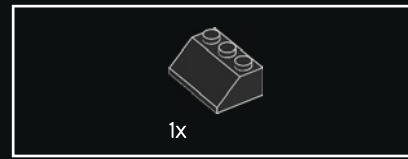
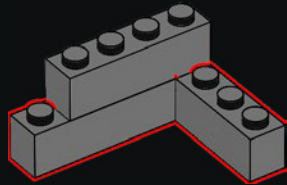

1x

115

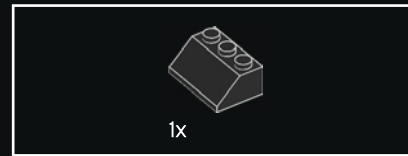
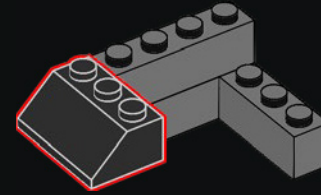

1x

116

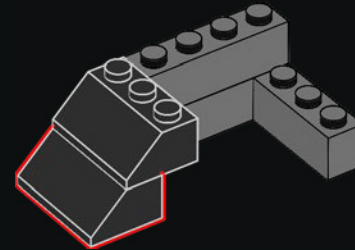

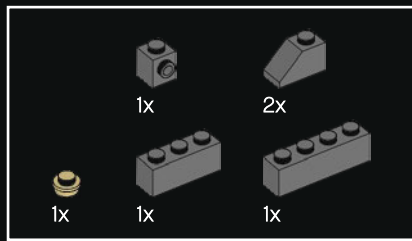

117

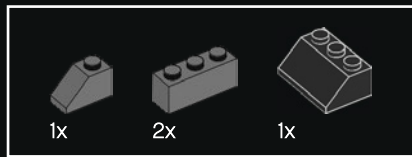
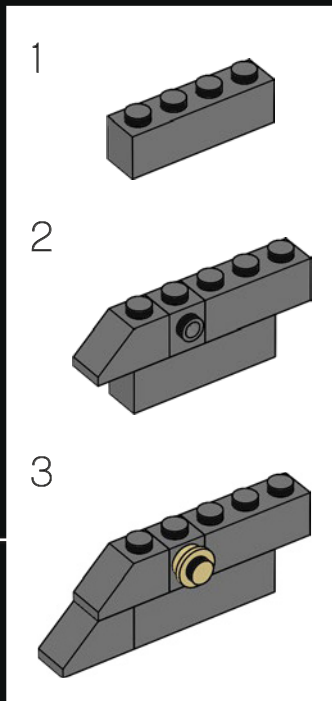
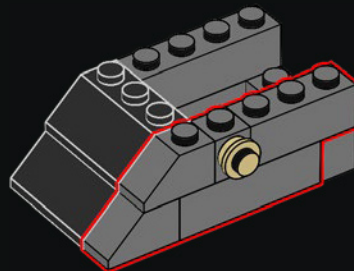

118

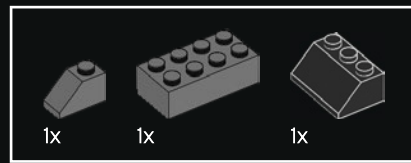
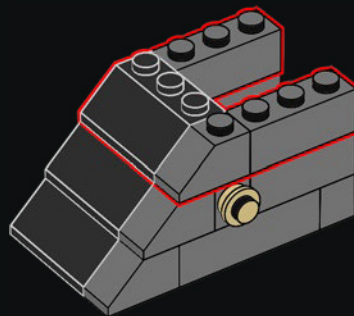

119

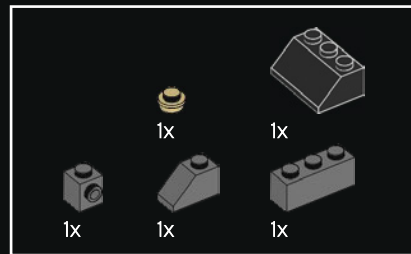
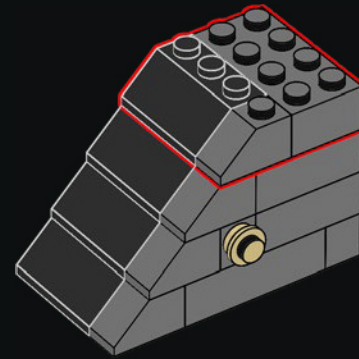

120

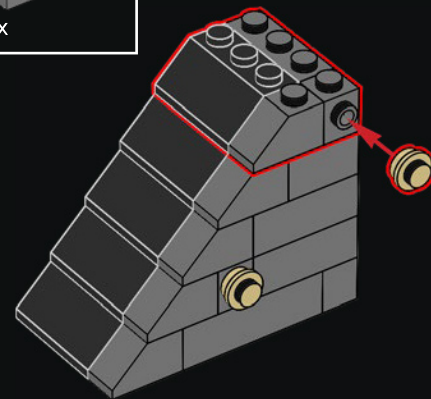

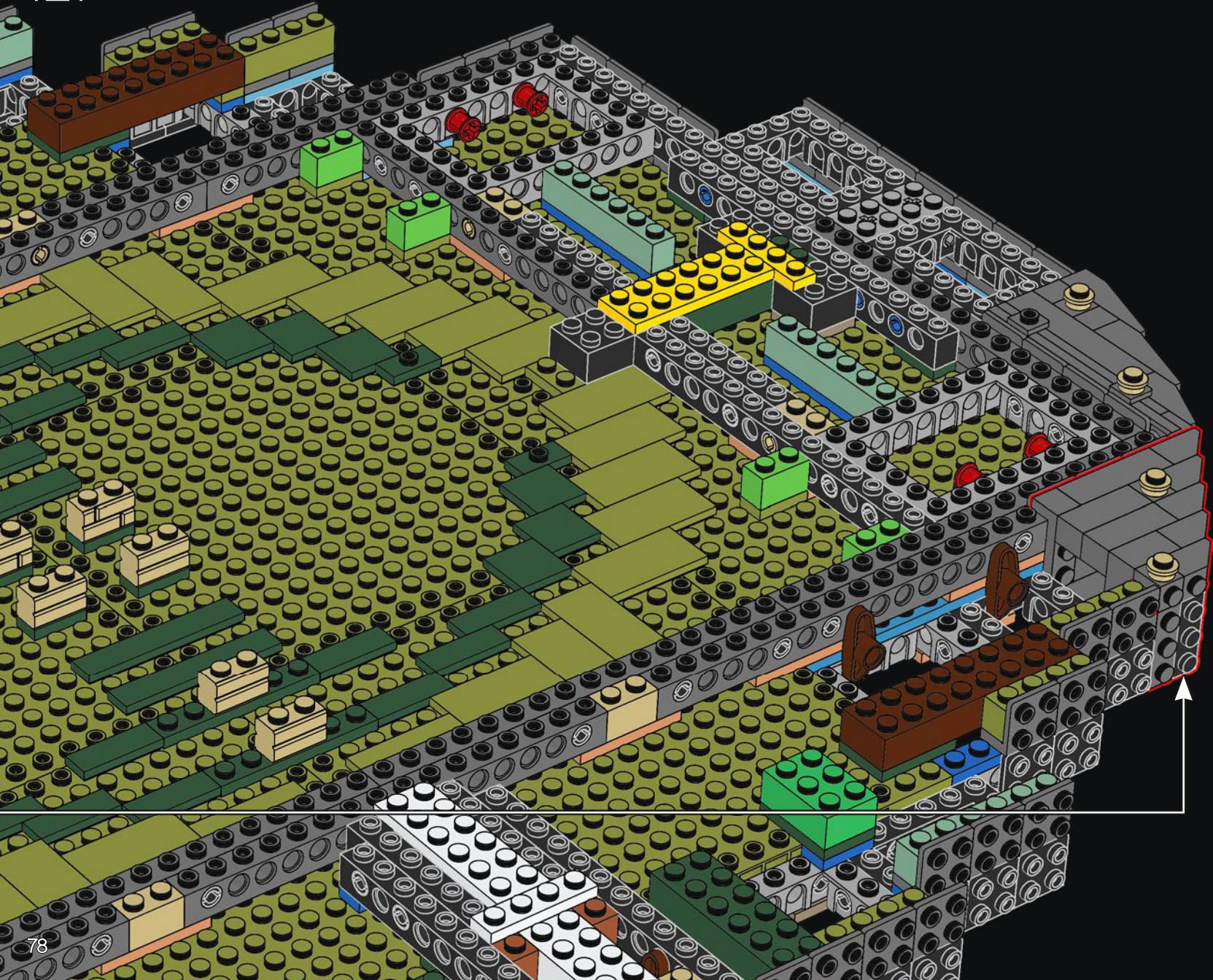

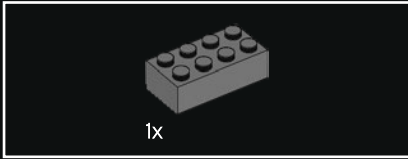
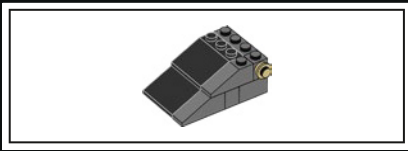

122

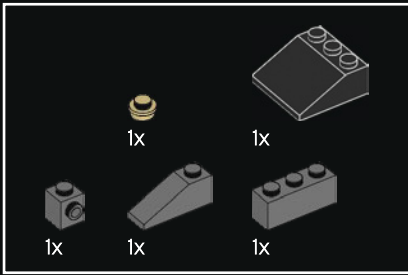
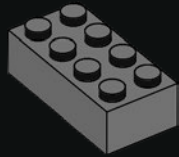

123

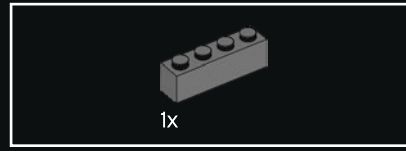
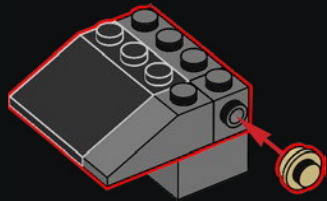

124

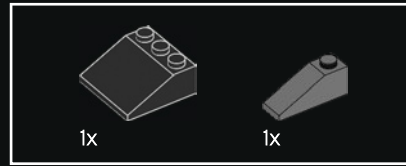
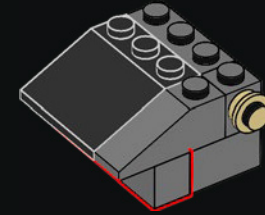

125

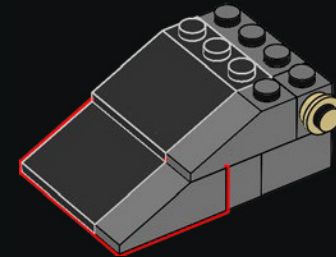



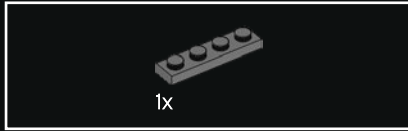
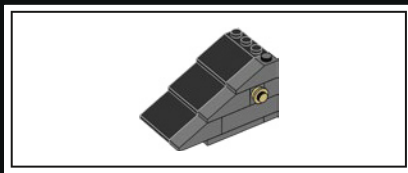

127

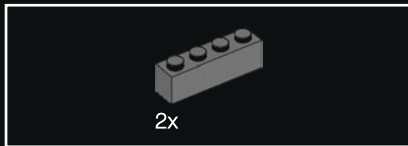
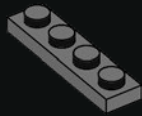

128

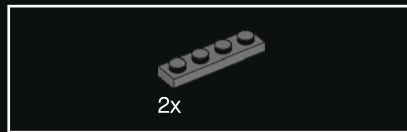
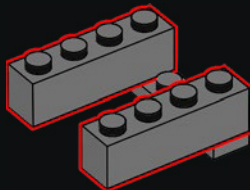

129

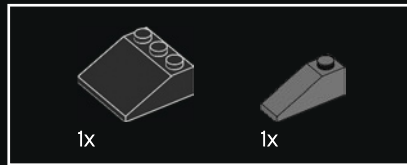
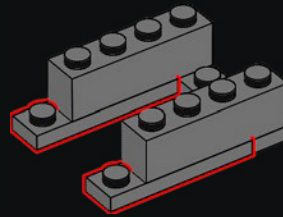

130

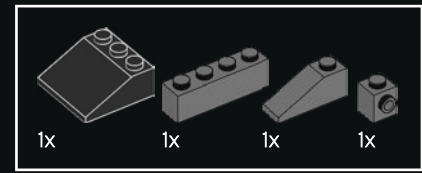
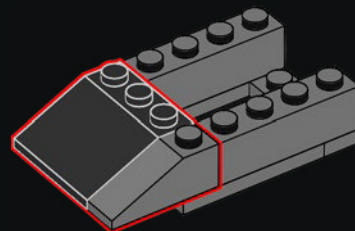

131

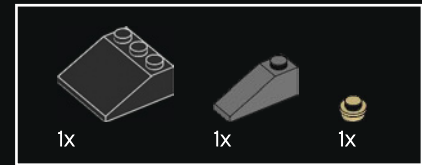
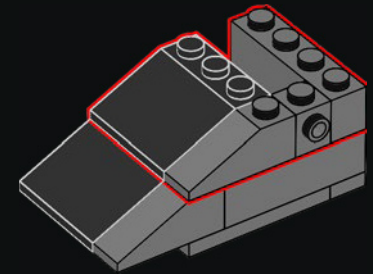

132

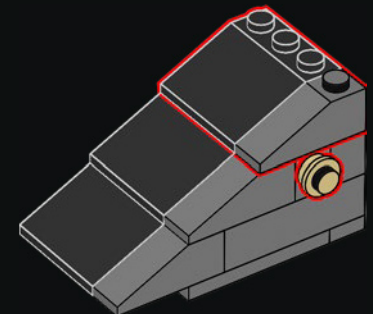



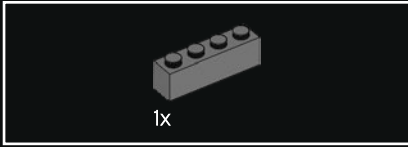
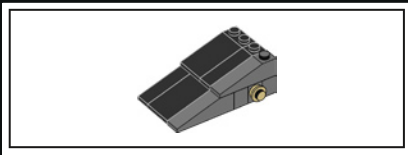

134

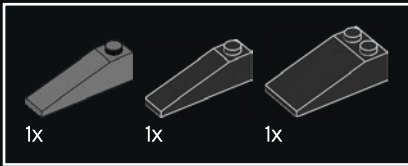
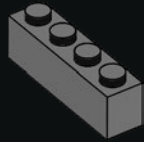

135

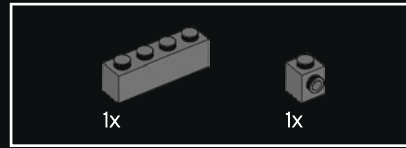
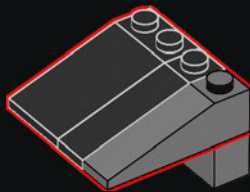

136

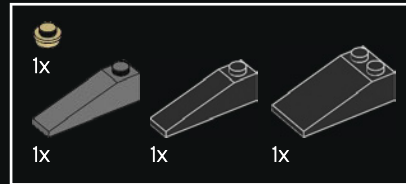
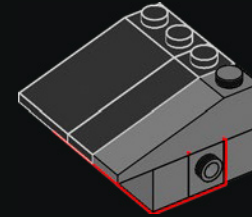

137

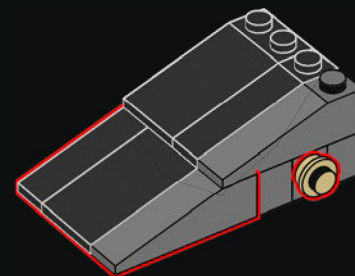



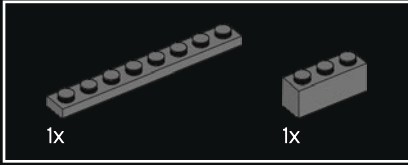
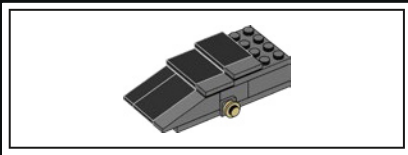

139

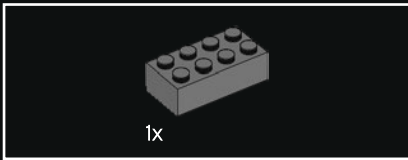
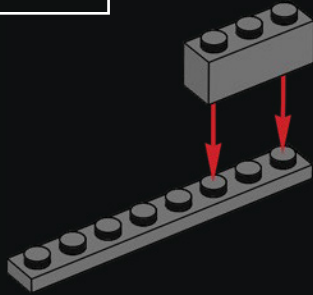

140

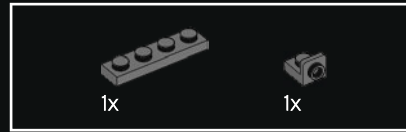
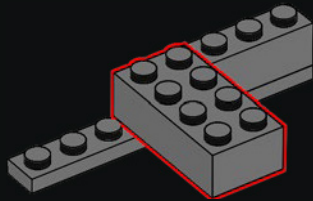

141

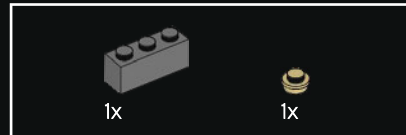
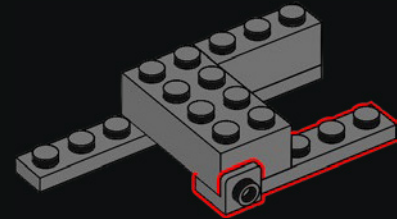

142

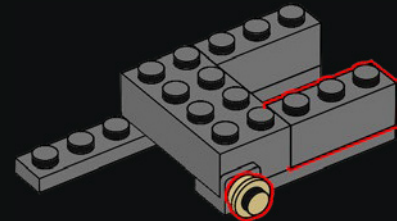

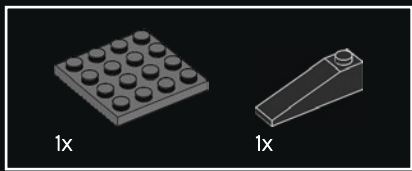

143

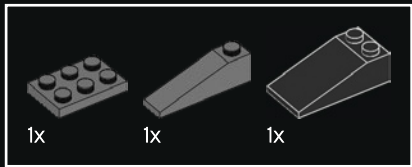
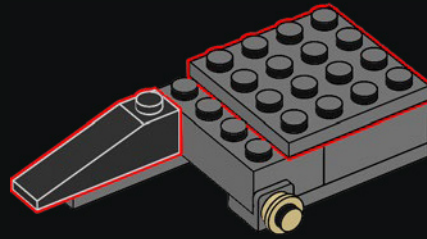

144

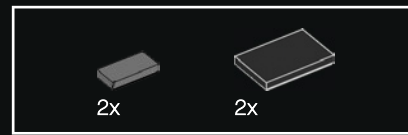
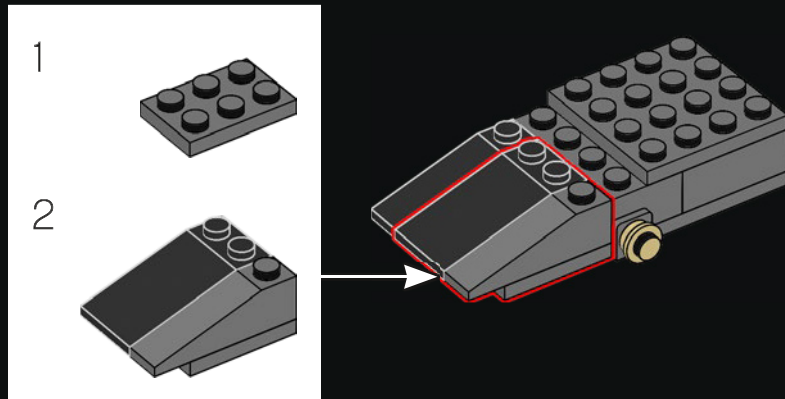

145

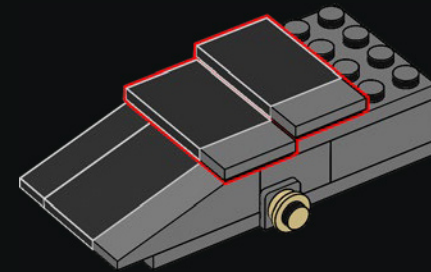

146

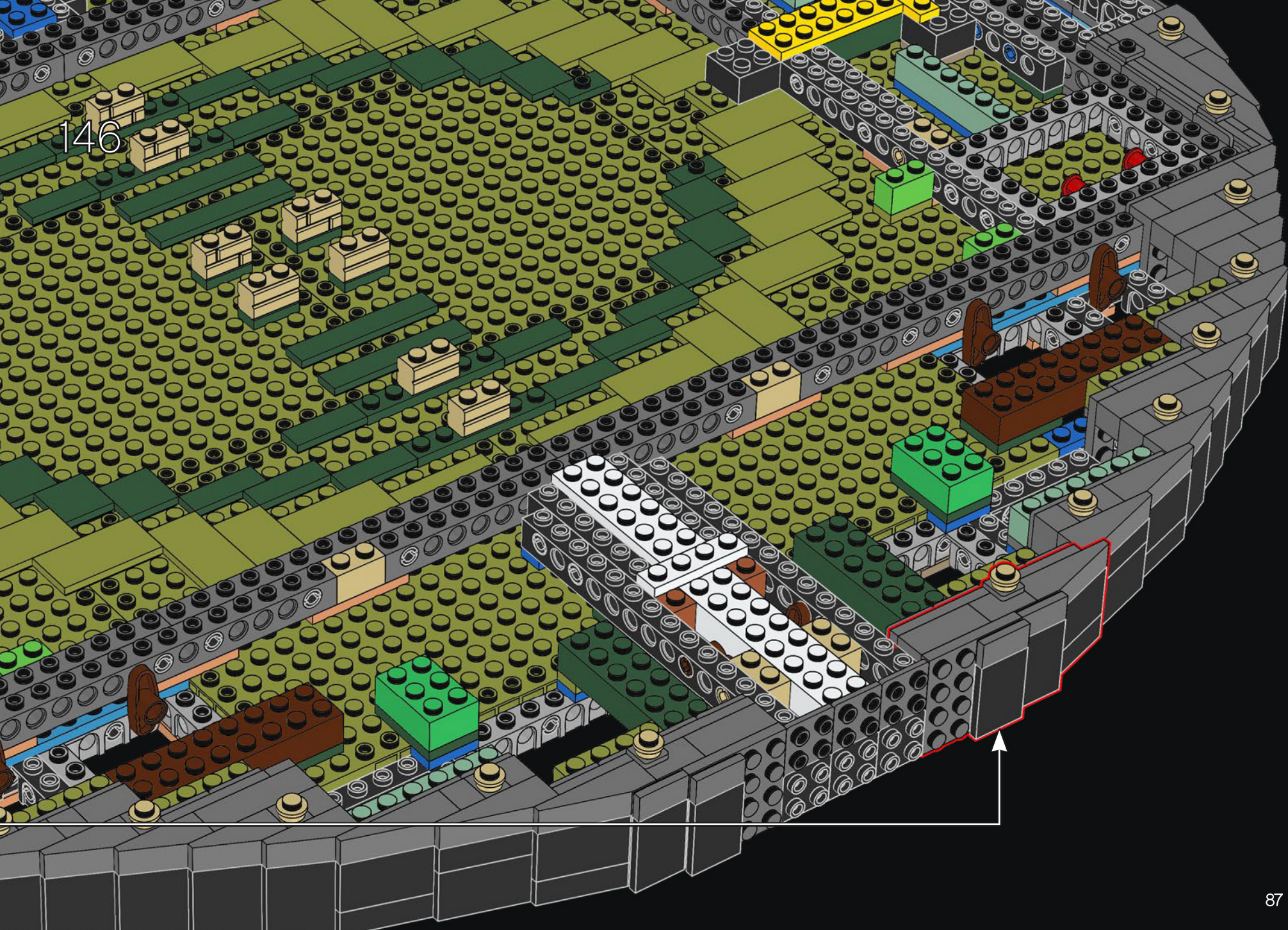

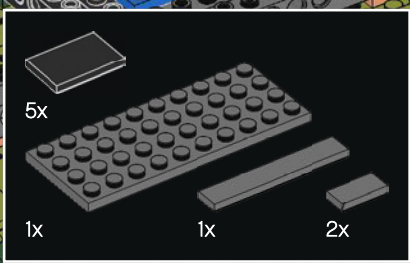

147

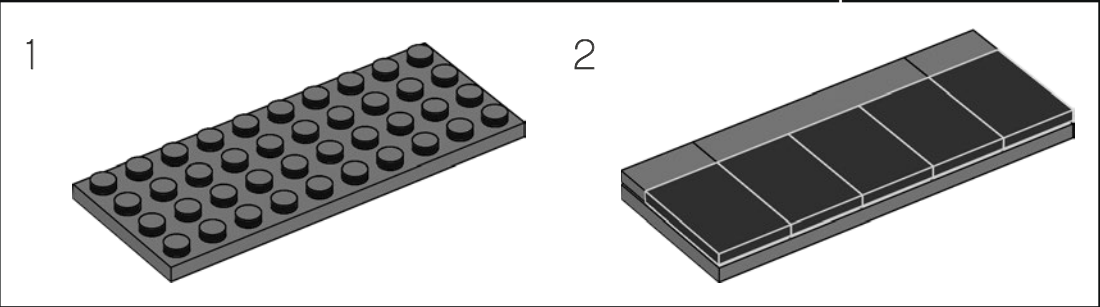
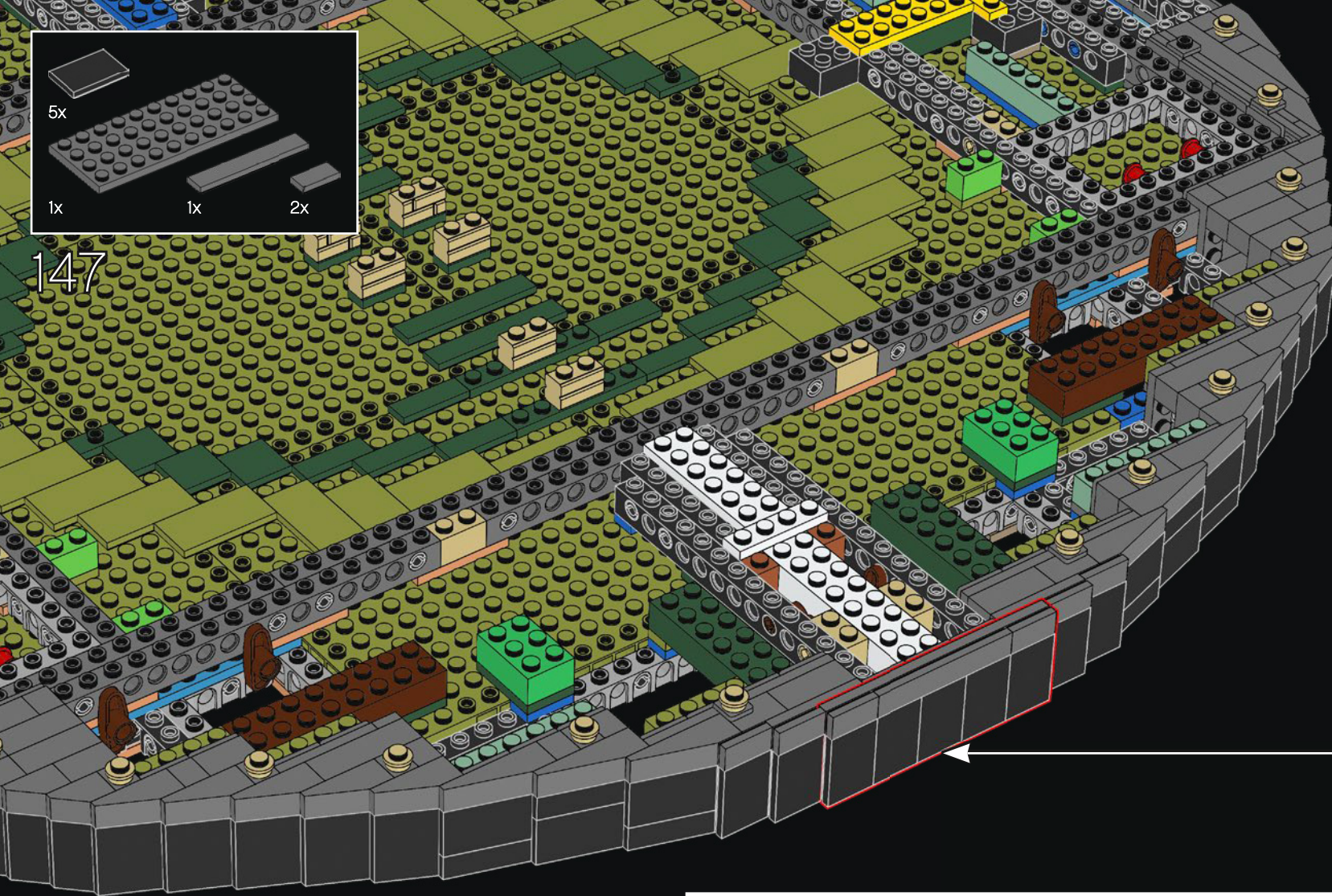

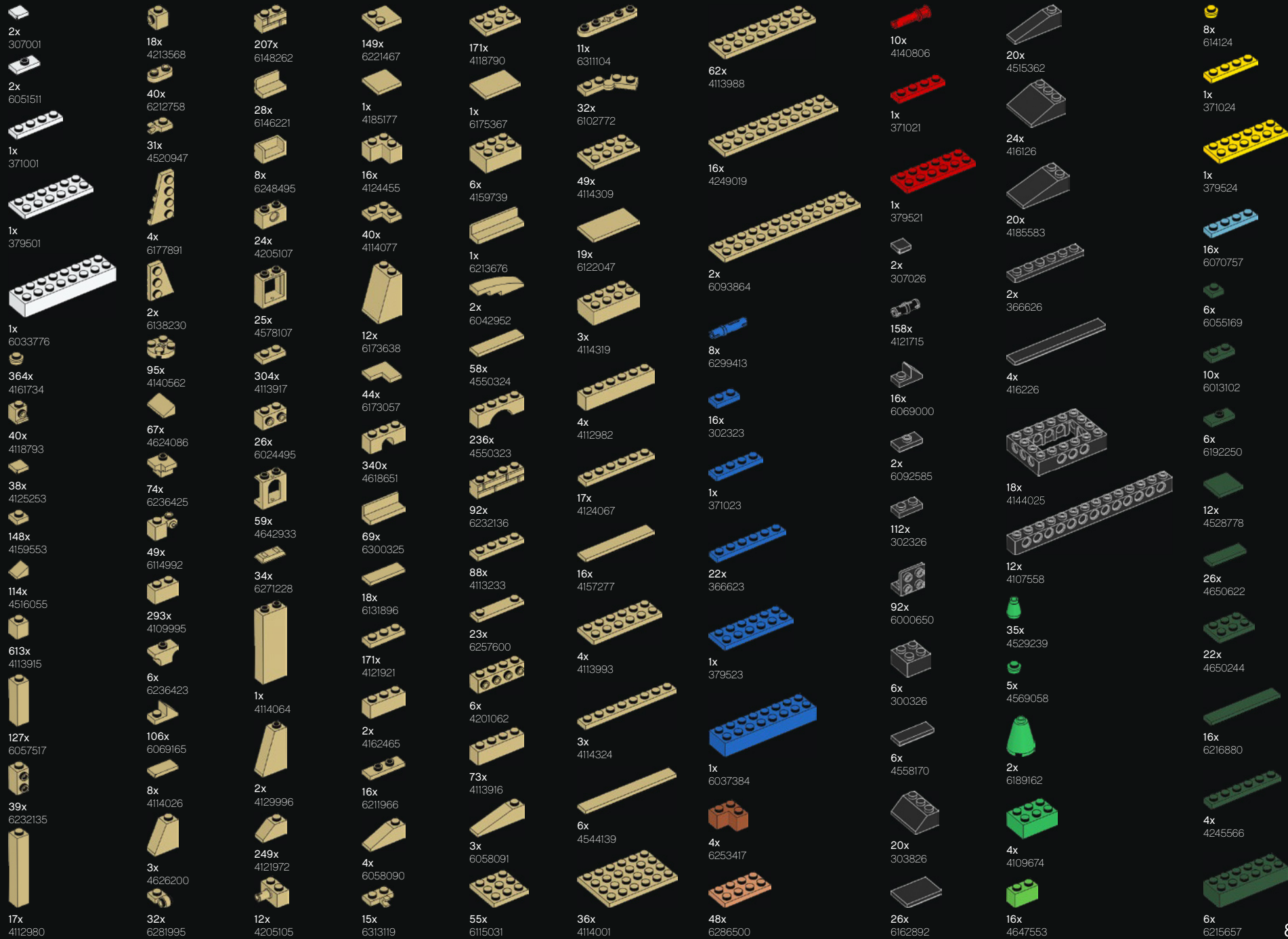

- 32x 6016483
- 10x 6212080
- 12x 6062697
- 36x 6016488
- 1x 6275877
- 1x 6195266
- 12x 6167700
- 1x 6240515

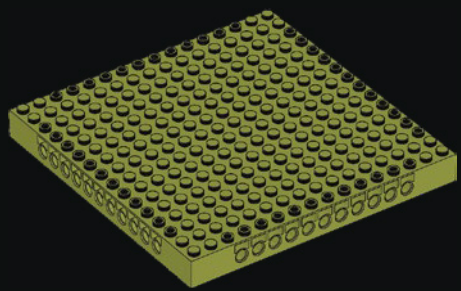

- 10x 6301768

- 115x 6300321
- 96x 6300320
- 133x 6300322
- 18x 6300318
- 36x 6055172
- 91x 4549436
- 14x 6040126
- 35x 6001824
- 239x 6231386
- 35x 6093064
- 142x 4528604
- 237x 6092591
- 35x 4521914
- 5x 4496699

- 17x 6167894
- 8x 4246957
- 115x 4530678
- 213x 4616711
- 36x 6047415
- 81x 4550168
- 40x 6184880
- 7x 6132768
- 14x 6015452
- 23x 6175927
- 23x 4626904
- 4x 4267874
- 1x 4507047
- 3x 6015424
- 1x 4550329
- 14x 6156492

- 56x 4530678
- 213x 4616711
- 36x 6047415
- 81x 4550168
- 40x 6184880
- 7x 6132768
- 14x 6015452
- 23x 6175927
- 23x 4626904
- 4x 4267874
- 1x 4507047
- 3x 6015424
- 1x 4550329
- 14x 6156492

- 19x 6039482
- 12x 4558955
- 6x 6225494
- 11x 6092572
- 79x 6039479
- 18x 4211052
- 20x 4211135
- 8x 6214341
- 92x 6308045
- 9x 6123814
- 8x 6126083
- 4x 4211094
- 2x 4211055
- 66x 4211104
- 24x 4211045
- 19x 6039482

- 12x 4558955
- 6x 6225494
- 11x 6092572
- 79x 6039479
- 18x 4211052
- 20x 4211135
- 8x 6214341
- 92x 6308045
- 9x 6123814
- 8x 6126083
- 4x 4211094
- 2x 4211055
- 66x 4211104
- 24x 4211045
- 19x 6039482

- 6x 4243831
- 18x 6187008
- 6x 4211043
- 48x 4211103
- 13x 6257592
- 24x 4211001
- 20x 4211053
- 20x 4535930
- 33x 4560184
- 2x 4211065
- 22x 4211085
- 4x 4211100
- 22x 4210651
- 6x 4243831
- 16x 4210998
- 2x 4210997
- 28x 6147337
- 2x 4211122
- 2x 6000970
- 18x 4256828
- 4x 6250216
- 4x 6151666
- 8x 6177081
- 4x 4539076

- 18x 6187008
- 6x 4211043
- 48x 4211103
- 13x 6257592
- 24x 4211001
- 20x 4211053
- 20x 4535930
- 33x 4560184
- 2x 4211065
- 22x 4211085
- 4x 4211100
- 22x 4210651
- 6x 4243831

- 16x 4210998
- 2x 4210997
- 28x 6147337
- 2x 4211122
- 2x 6000970
- 18x 4256828
- 4x 6250216
- 4x 6151666
- 8x 6177081
- 4x 4539076

- 16x 4210998
- 2x 4210997
- 28x 6147337
- 2x 4211122
- 2x 6000970
- 18x 4256828
- 4x 6250216
- 4x 6151666
- 8x 6177081
- 4x 4539076

- 1x 6170468
- 12x 6323704
- 11x 6116613
- 4x 6096701
- 20x 6168647
- 6x 4211399
- 75x 6043656
- 4x 6273227
- 9x 6043639
- 126x 6211969
- 8x 4211752
- 14x 4211848

- 1x 6170468
- 12x 6323704
- 11x 6116613
- 4x 6096701
- 20x 6168647
- 6x 4211399
- 75x 6043656
- 4x 6273227
- 9x 6043639
- 126x 6211969
- 8x 4211752
- 14x 4211848

- 14x 4211848



Customer Service
Kundenservice
Service Consommateurs
Servicio Al Consumidor

LEGO.com/service or dial

00800 5346 5555 : 

1-800-422-5346 : 





FEEDBACK AND WIN



FEEDBACK AND WIN

Your feedback will help shape the future development of this product series.

Please visit:

FEEDBACK UND GEWINNEN

Dein Feedback trägt zur Weiterentwicklung dieser Produktreihe bei.

Geh auf:

COMMENTEZ ET GAGNEZ

Vos commentaires nous aideront à concevoir les futurs produits de cette gamme.

Rendez-vous sur :

COMENTA Y GANA

Tu opinión nos ayudará a dar forma al desarrollo de esta serie de productos en el futuro.

Visita:

反馈有奖

您的反馈将有助于我们在今后改进本系列产品。

请访问：

[LEGO.com/productfeedback](https://www.lego.com/productfeedback)

By completing, you will automatically enter a drawing to win a LEGO® set.

Terms & Conditions apply.

Durch Ausfüllen nimmst du automatisch an der Verlosung eines LEGO® Preises teil.

Es gelten die Teilnahmebedingungen.

En envoyant vos commentaires, vous serez automatiquement inscrit(e) à un tirage au sort qui vous permettra de remporter un prix LEGO®.

Offre soumise à conditions.

Al contestar, participarás automáticamente en el sorteo y podrás ganar un set LEGO®.

Sujeto a Términos y Condiciones.

完成我们的反馈调查，即可自动进入抽奖环节，赢取乐高®套装。

适用《条款和条件》。

