

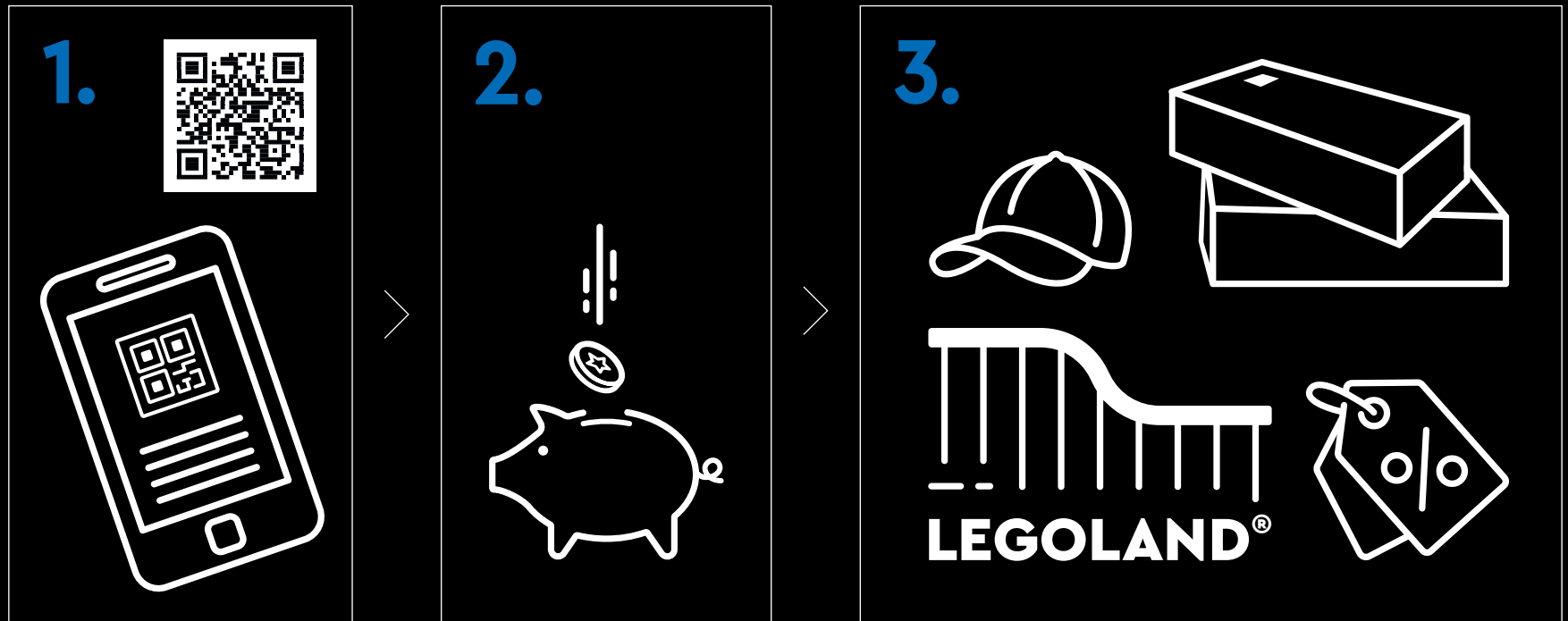



LEGO.com/sustainable-packaging

LEGO® VIP



1. Sign up **2.** Earn points for purchases **3.** Redeem points for rewards, experiences, discounts & more | **1.** Melde dich an **2.** Sammle Punkte bei jedem Kauf **3.** Löse die Punkte für Belohnungen, Erlebnisse, Rabatte und Ähnliches ein | **1.** Inscrivez-vous **2.** Gagnez des points lors de vos achats **3.** Échangez vos points contre des récompenses, des expériences, des remises et bien plus encore | **1.** Iscriviti **2.** Guadagna punti con i tuoi acquisti **3.** Riscatta punti per premi, esperienze, sconti e altro ancora | **1.** Regístrate **2.** Gana puntos por tus compras **3.** Canjea puntos por recompensas, experiencias, descuentos y mucho más | **1.** Registe-se **2.** Ganhe pontos em compras **3.** Troque os pontos para prémios, experiências, descontos e muito mais | **1.** 注册 **2.** 购物赚积分 **3.** 用积分兑换奖励、体验、折扣等 | **1.** Zarejestruj się **2.** Zdobywaj punkty za zakupy **3.** Wymieniaj punkty na rabaty, przygody i inne nagrody | **1.** Zaregistrujte se **2.** Sbírejte body za nákupy **3.** Vyměňujte body za odměny, zážitky, slevy a spoustu dalšího | **1.** Zaregistrujte se **2.** Získavajte body za nákupy **3.** Uplatnite si body a získajte odmeny, rôzne zážitky, zľavy a ešte viac | **1.** Regisztrálj **2.** Szerezz pontokat minden vásárlással **3.** Váltsd be pontjaidat jutalmakra, élményekre, kedvezményekre és egyebekre | **1.** Înscric-te **2.** Câștigă puncte pentru achiziții **3.** Valorifică puncte pentru recompense, experiențe, reduceri și multe altele | **1.** Регистрируйте се **2.** Получайте точки за покупки **3.** Используйте точки за награды, услуги, отстъпки и т.н. | **1.** Reģistrējies **2.** Pelni punktus par pirkumiem **3.** Izmanto punktus, lai saņemtu balvas, izklaides iespējas, atlaides un daudz ko citu | **1.** Registreeru **2.** Teeni ostude eest punkte **3.** Lunasta punktide eest preemiad, elamused, allahindlused ja muu | **1.** Užsiregistruokite **2.** Pelnykite taškų už pirkinius **3.** Panaudokite taškus atlygiui, funkcijoms, nuolaidoms ir ne tik





WILLKOMMEN IN BRUCHTAL

Auch 20 Jahre nach der Premiere von *Die Rückkehr des Königs™* bleibt die Filmtrilogie *Der Herr der Ringe™* eines der bedeutsamsten cineastischen Kunstwerke unserer Zeit. Wie soll man da eine Lieblingsszene oder den denkwürdigsten Moment auswählen? In der dunkelsten Epoche ist Bruchtal, die majestätische Residenz der Elben, ein stiller, florierender Zufluchtsort, der Heilung, Hoffnung, unaufgeregte Entschlossenheit und Einigkeit verheißt. Bei einer wichtigen Zusammenkunft in Bruchtal schmieden Gesandte der Völker von Mittelerde die *Gemeinschaft des Ringes™*, um den Einen Ring zu vernichten, der alle knechtet.



*Die Gemeinschaft der
LEGO® Designer*

EINE GEMEINSCHAFT VON LEGO® DESIGNERN

Als eine Gemeinschaft aus Modell-, Element- und Grafikdesignern aus aller Welt haben wir uns auf den Weg gemacht, die Magie dieses Ortes zu erfassen. Wir haben uns an den akustischen Skizzen aus dem Film orientiert und uns einige künstlerische Freiheiten herausgenommen, um unsere Lieblingselemente zu kombinieren. Diese Nachbildung des legendären Imladris (der letzten trauten Heimstätte östlich des Meeres) aus 6.000 LEGO® Steinen ist ein detailgetreuer Ausschnitt von Bruchtal im Maßstab der LEGO Minifiguren. Dort spielen sich viele denkwürdige Szenen zwischen den geliebten Filmfiguren ab.



KLASSISCHE SZENEN AUS LEGO® DER HERR DER RINGE™

Begib dich auf eine Reise durch einige klassische Szenen aus früheren LEGO® *The Lord of the Rings*™ Sets aus den Jahren 2012 und 2013, die unter anderem die Ankunft von Gandalf dem Grauen™ im Auenland oder die letzte Schlacht mit dem König der Toten an der Küste von Minas Tirith darstellten.



9469 GANDALF™ ARRIVES

Aus Anlass des 111. Geburtstages seines Freundes Bilbo Beutlin besucht Gandalf der Graue das Auenland. Hier begegnet er dem jungen Frodo Beutlin, und das Abenteuer nimmt seinen Lauf.



79006 THE COUNCIL OF ELROND

Die Völker von Mittelerde wurden ins Bruchtal bestellt, wo der Rat von Elrond einberufen wurde. Hier wird nun über das Schicksal des Einen Ringes entschieden.



9473 THE MINES OF MORIA™

Die heldenhafte Gemeinschaft des Ringes bekommt es in den verlassenen Minen von Moria mit bösen Orks und einem riesigen Höhlentroll in Balins Gruft zu tun.



9474
THE BATTLE OF HELM'S DEEP™

Das Volk der Rohan wird in der ummauerten Festung an Helms Klamm von Sarumans barbarischer Uruk-hai-Armee angegriffen.



10237
THE TOWER OF ORTHANC

Mit seinen 2.357 Teilen war der sechsgeschossige Turm von Orthanc zum Zeitpunkt seiner Markteinführung nicht nur das bis dato größte LEGO® The Lord of the Rings™ Set, sondern beinhaltete auch legendäre Minifiguren und stellte unvergessliche Szenen dar.



79008
PIRATE SHIP AMBUSH

Saurons Mordor-Orks bereiten sich darauf vor, ihre Verbündeten an Bord des Piratenschiffs zu begrüßen, bekommen es aber stattdessen mit Aragorn, Gimli, Legolas und der Armee der Toten zu tun.



DER TURM

Während seines Aufenthalts in Bruchtal schreibt Bilbo an seinem Tisch im Turm sein Buch *Hin und zurück* fertig. Ein Geheimversteck im Fundament des Turms ist gerade groß genug, um einen Flüchtigen zu beherbergen oder den Einen Ring sicher zu verwahren.



Frodo hat aus zwei Materialien geformte Beine, die seine nackten Füße, ein ganz wesentliches Merkmal des Hobbits aus dem Auenland, darstellen. Er trägt auch den Einen Ring, der nach Bruchtal gebracht wurde, damit der Rat über sein Schicksal entscheiden kann.

FRODO BEUTLIN



Bilbos Kopf hat zwei unterschiedliche Gesichter. Eine Seite zeigt das fürchterliche Gesicht, das er kurzzeitig offenbart, als er versucht, Frodo den Ring abzunehmen.

BILBO BEUTLIN



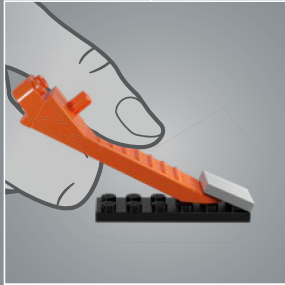
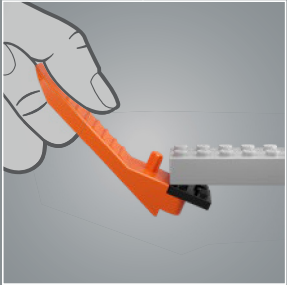
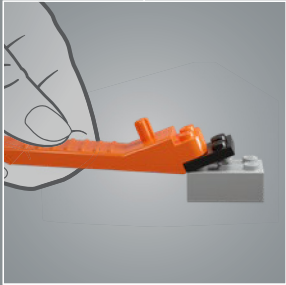
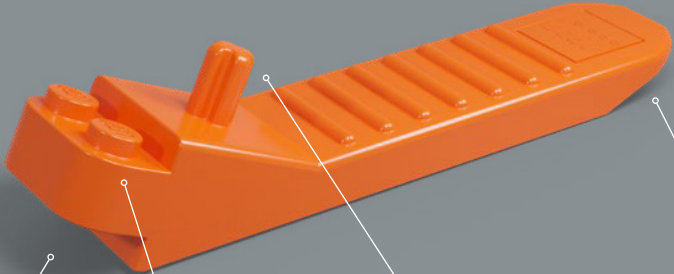



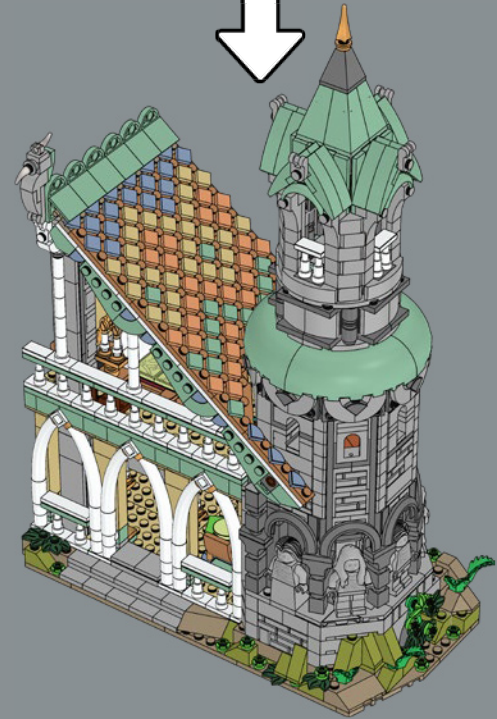

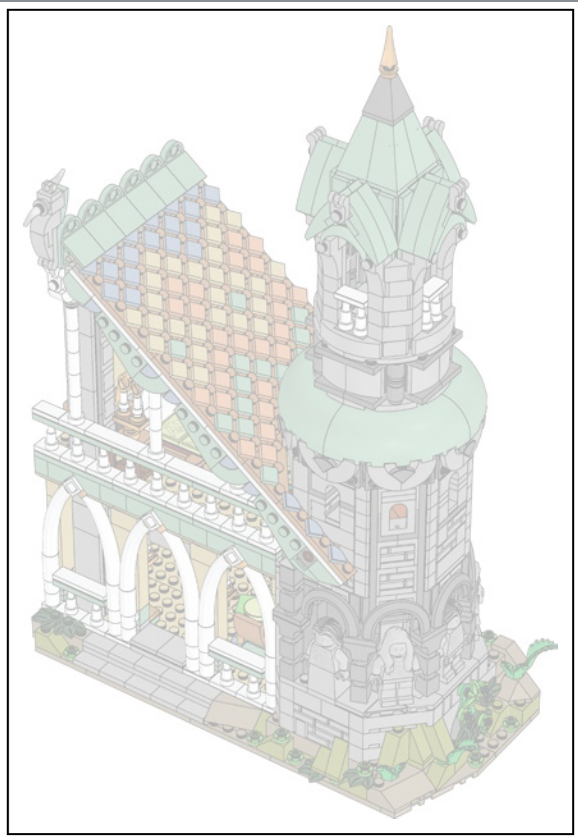

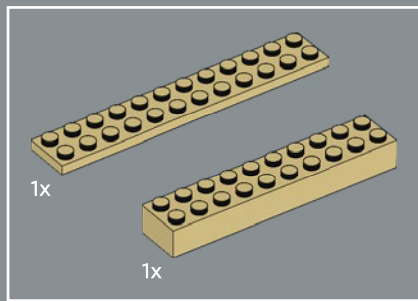

1

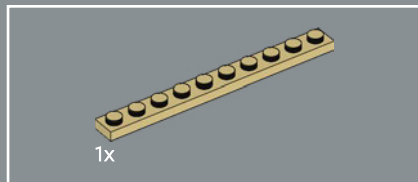
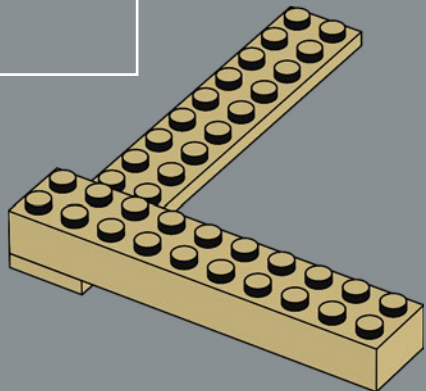

2

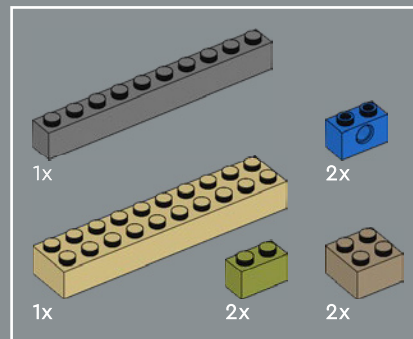
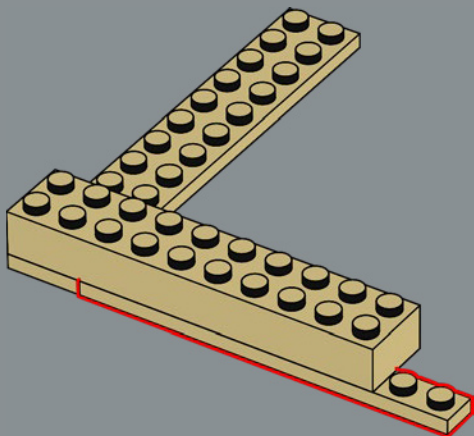

3

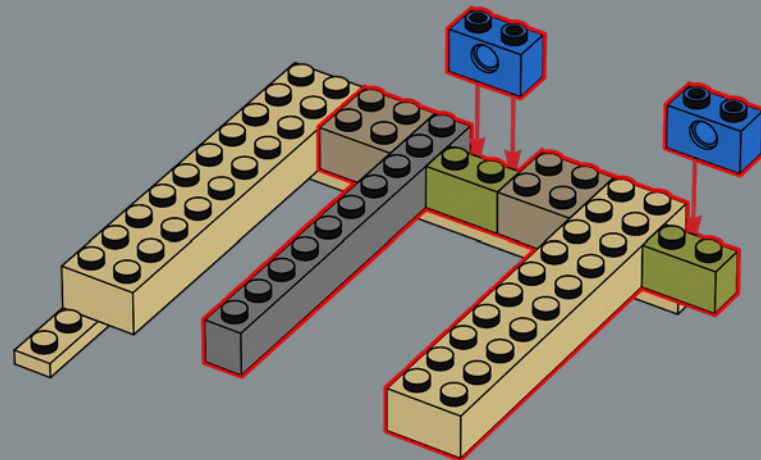

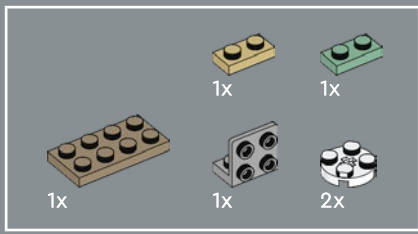

4

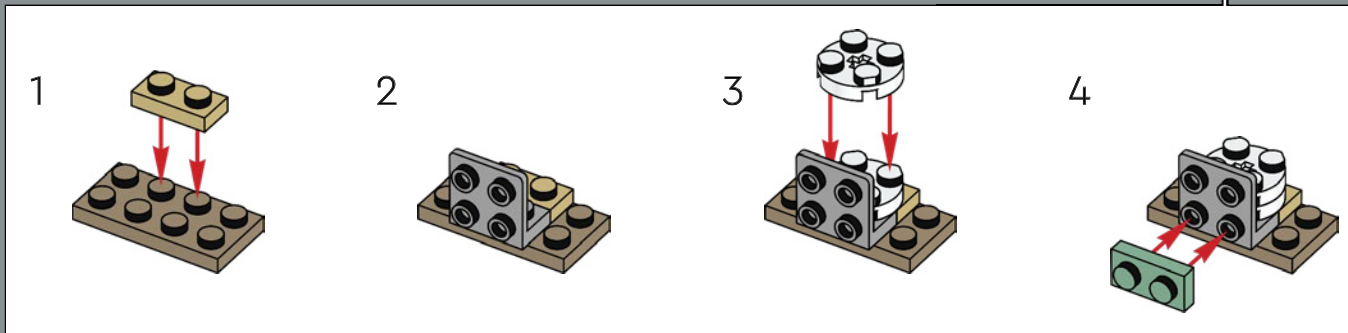
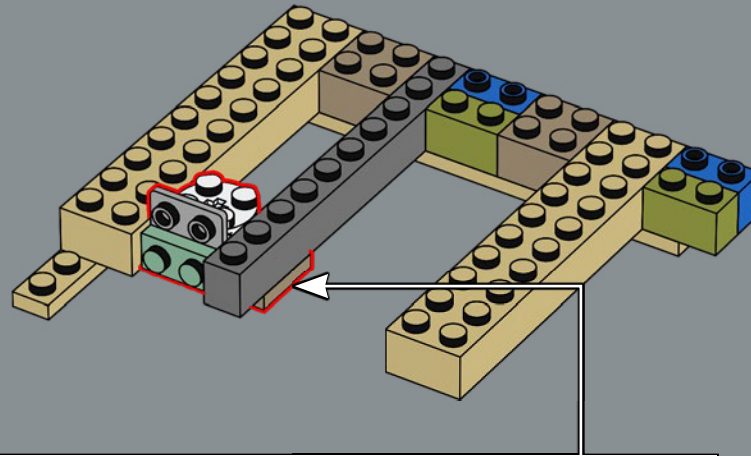

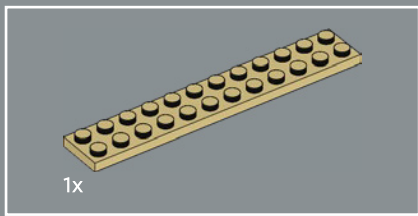

5

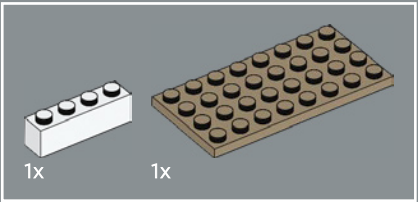
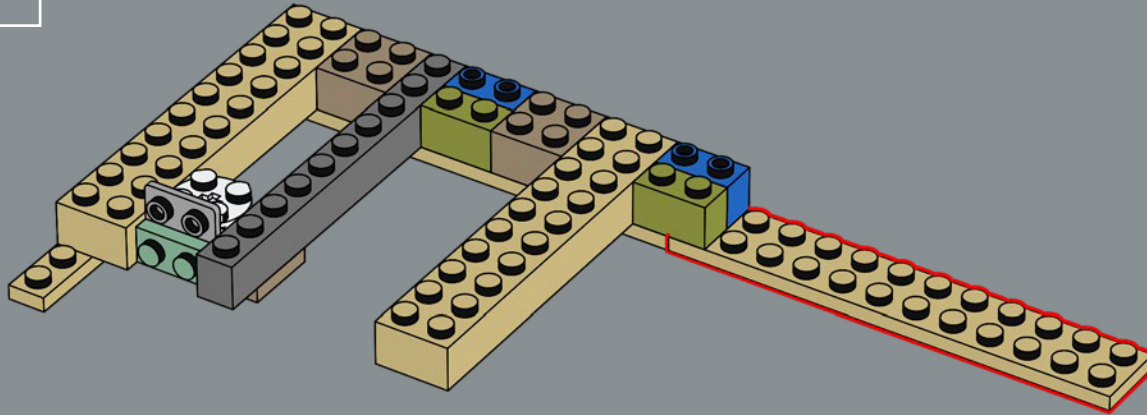

6

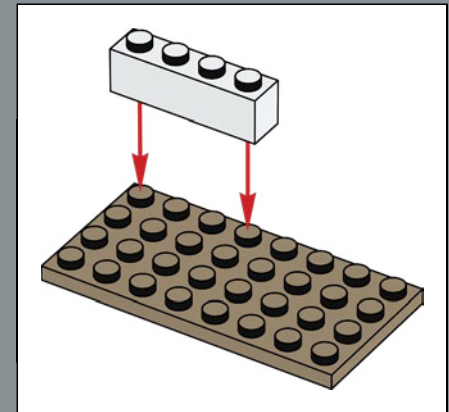
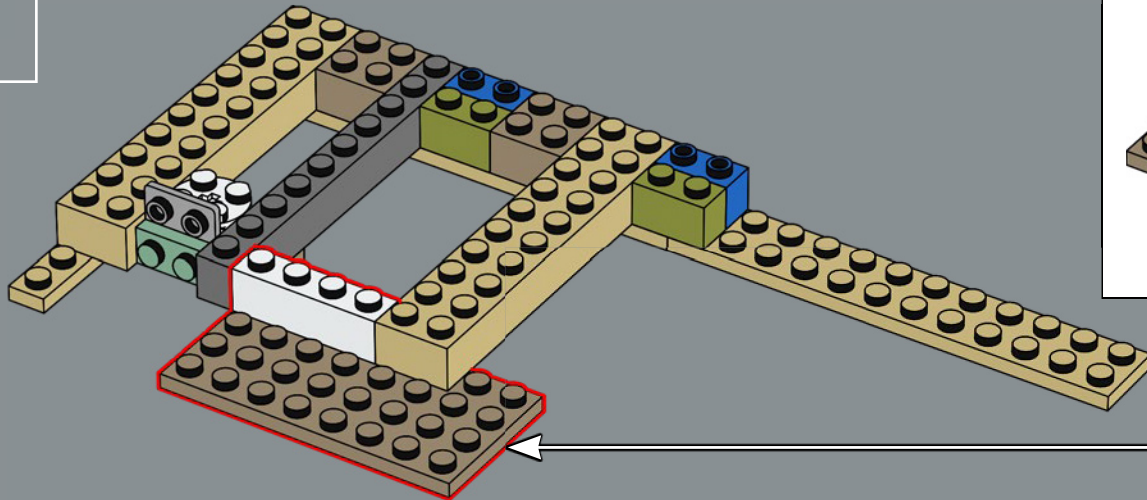

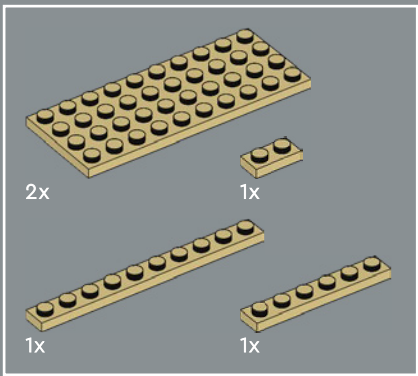

7

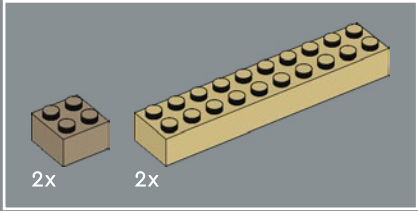
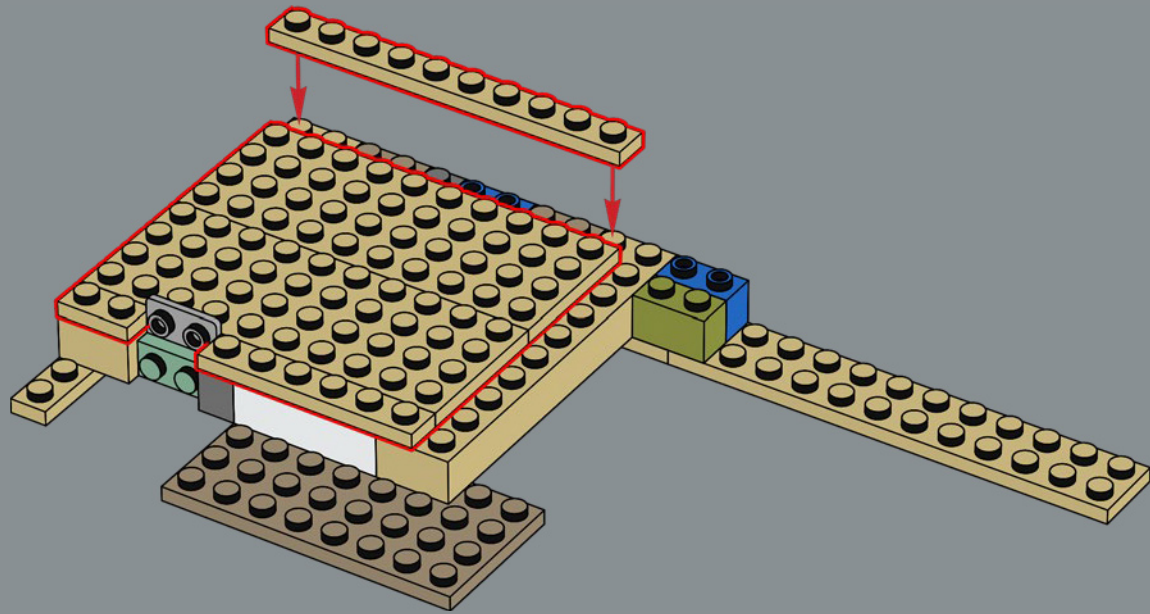

8

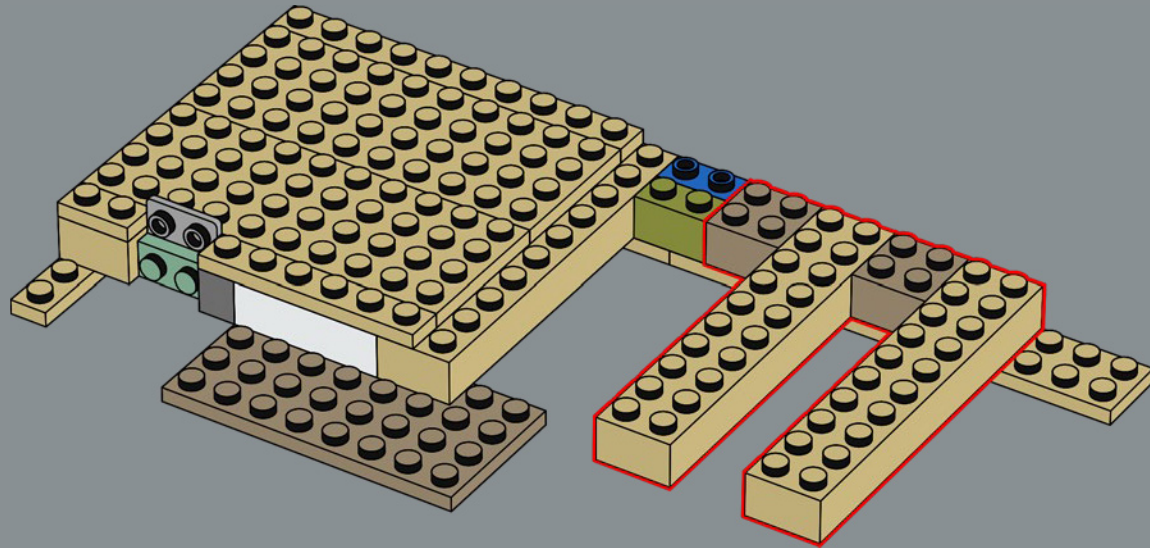

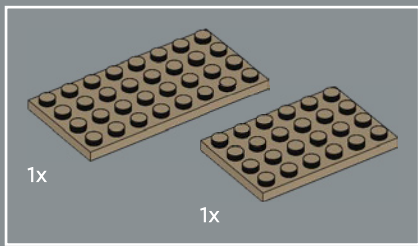

9

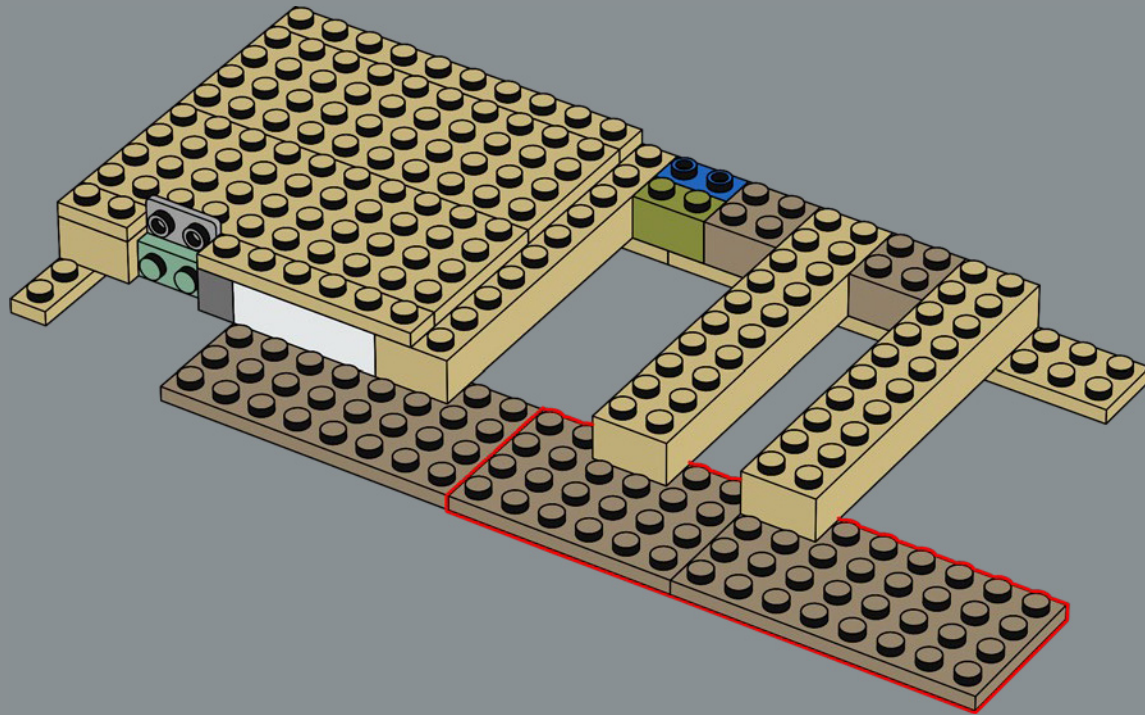

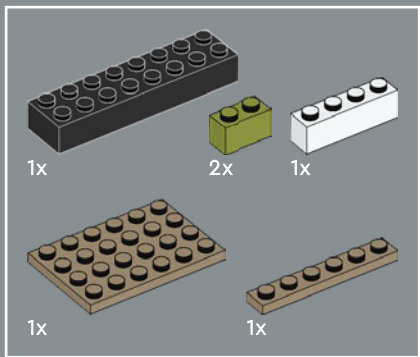

10

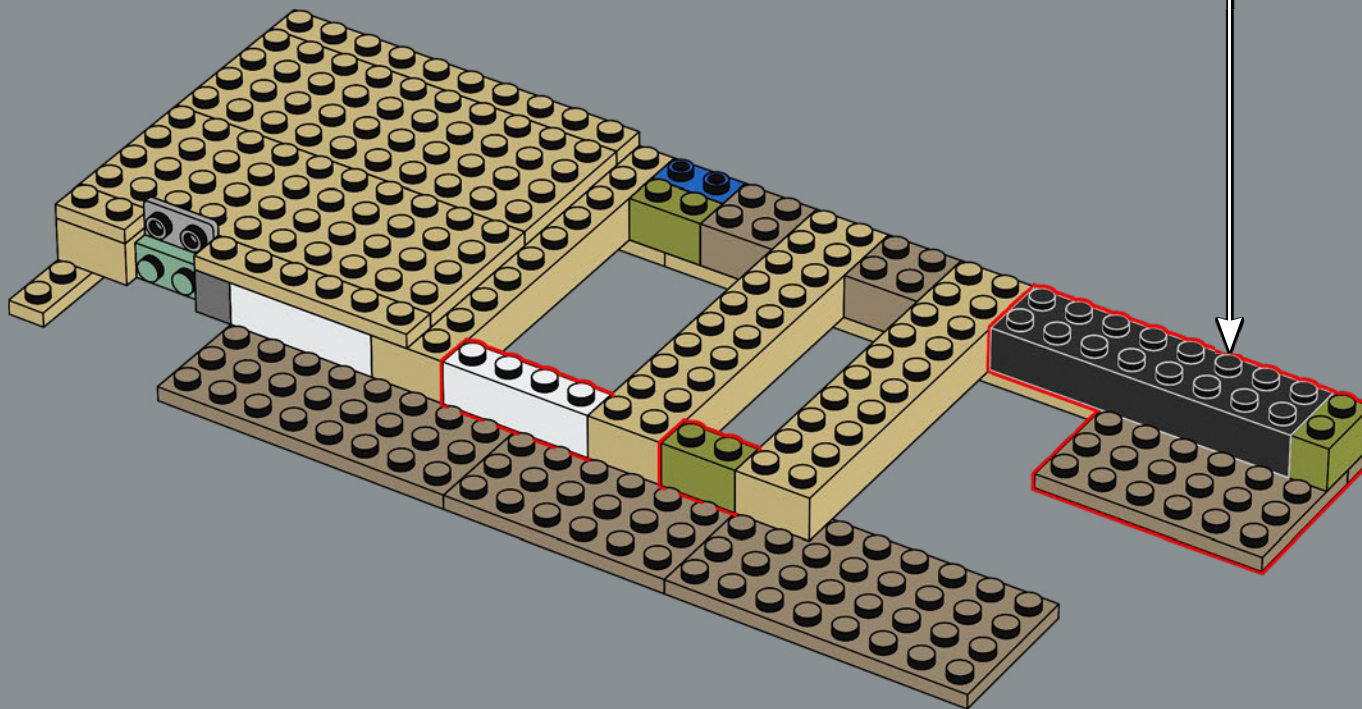
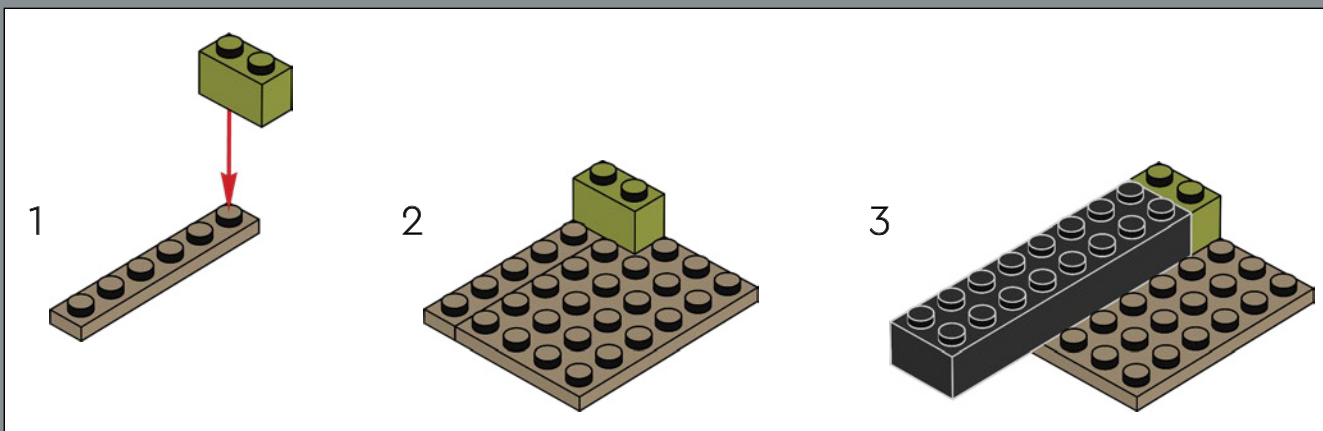

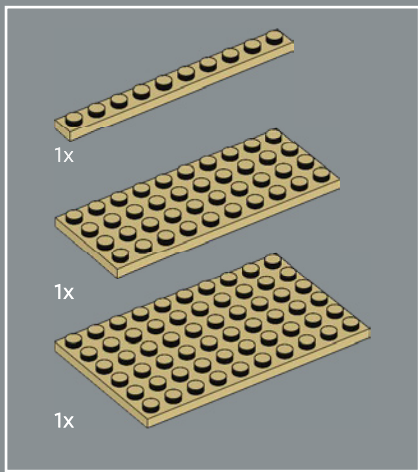

11

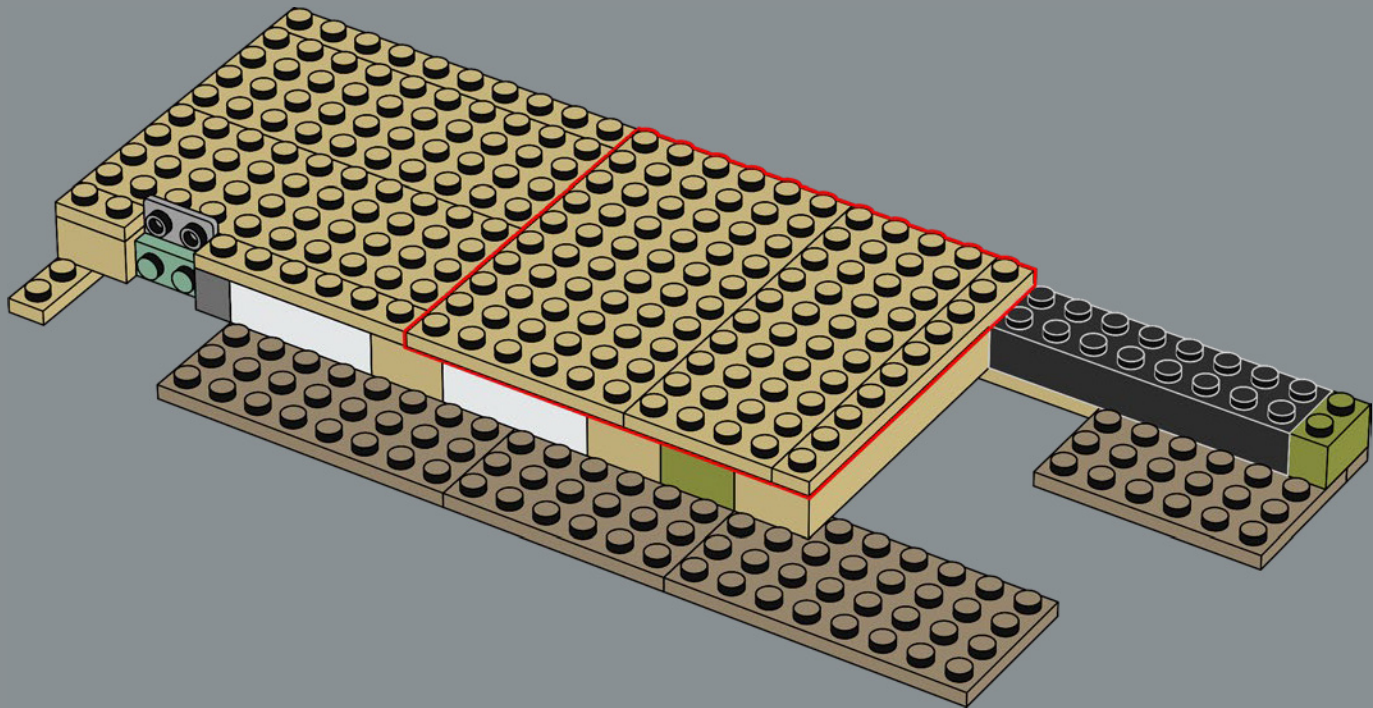

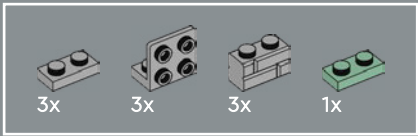

12

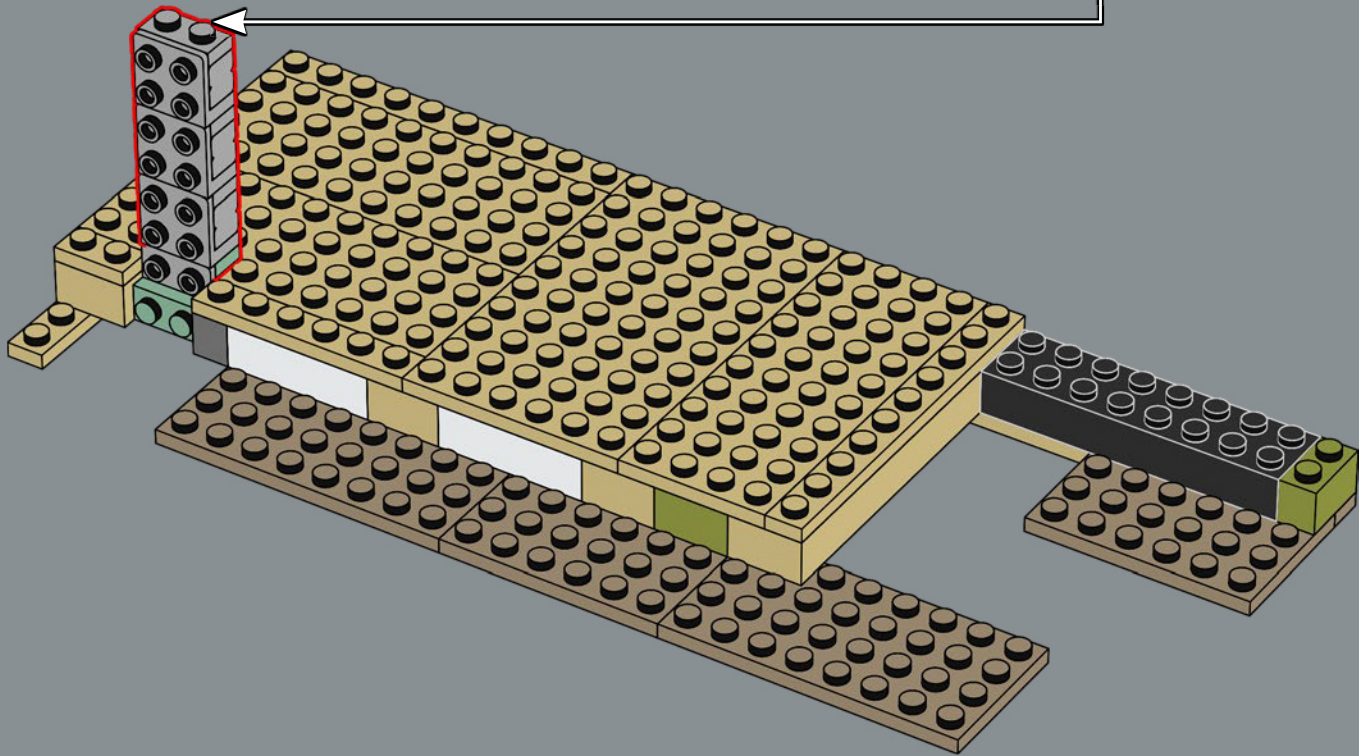
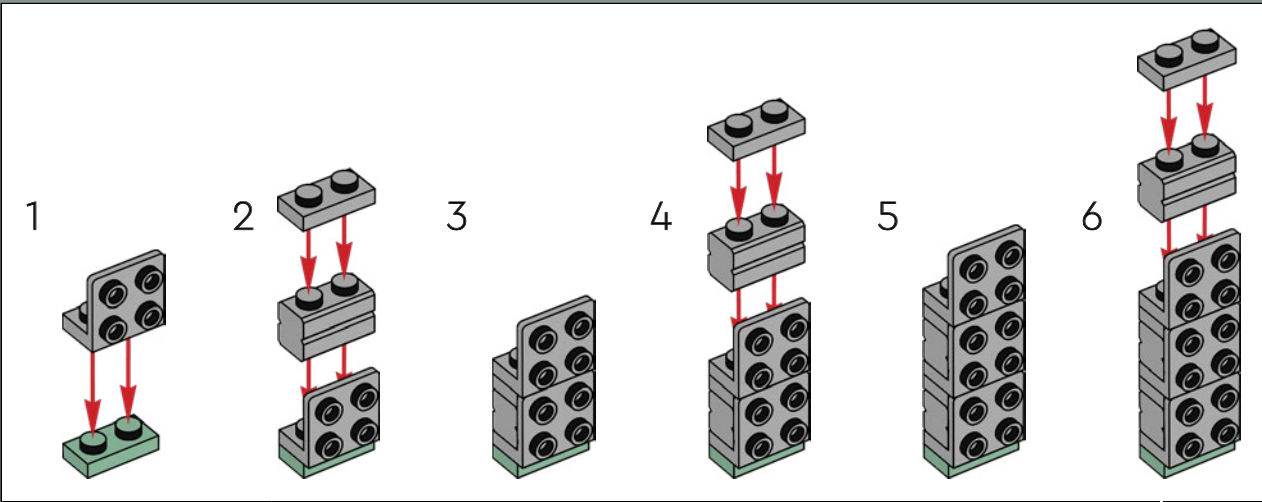

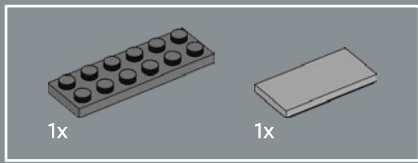

13

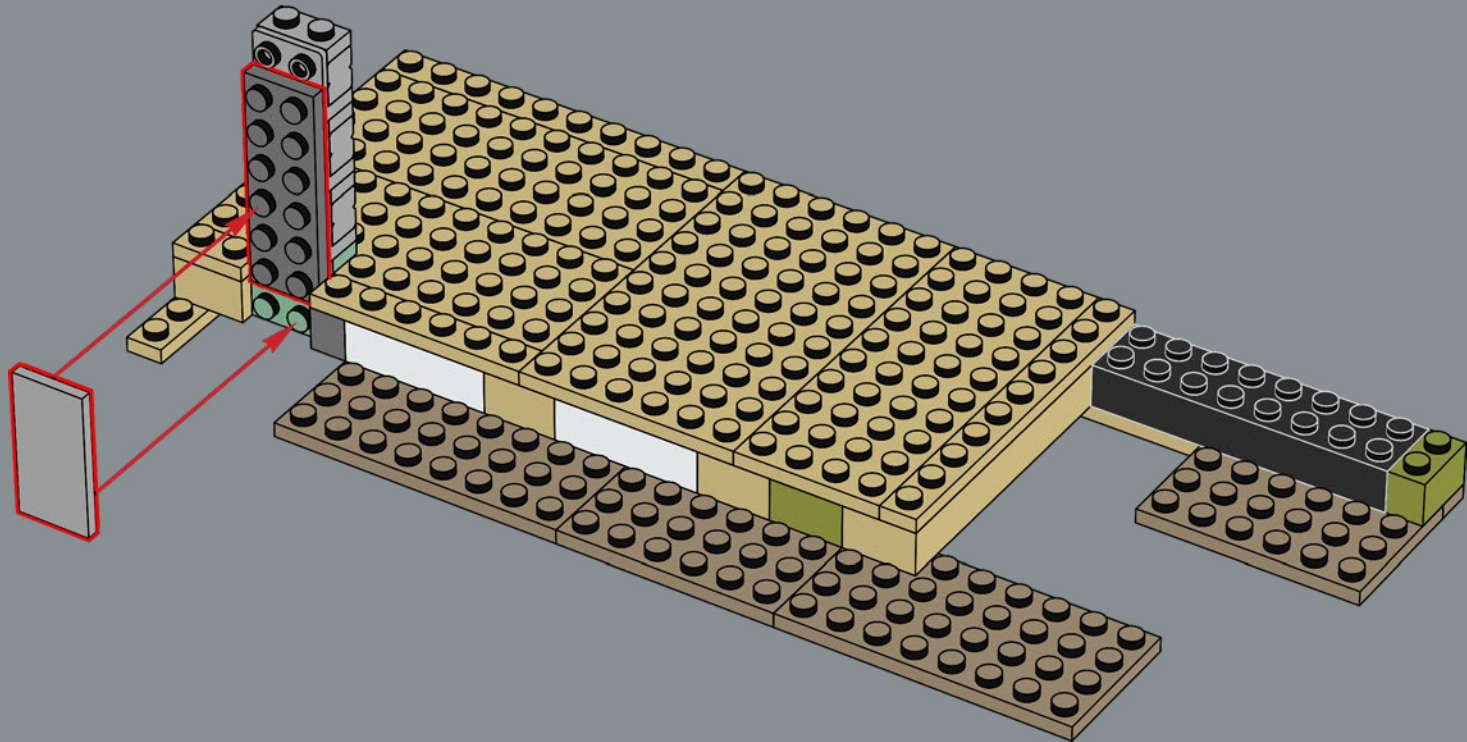

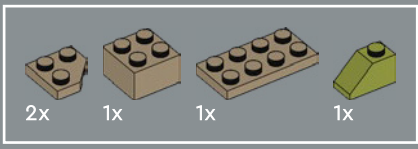

14

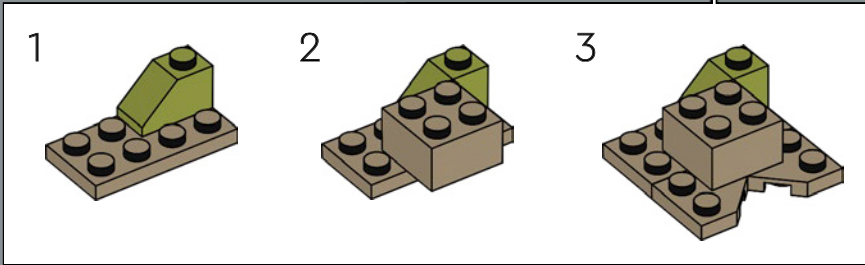
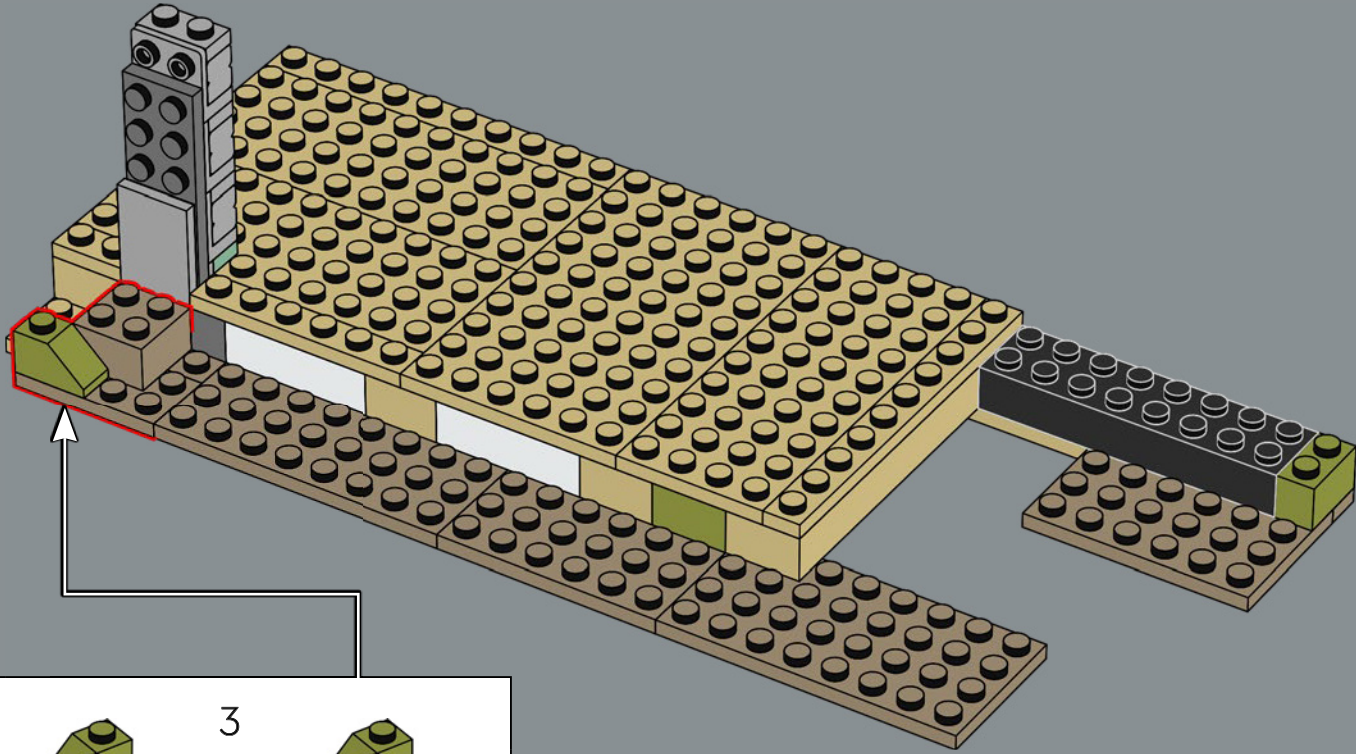

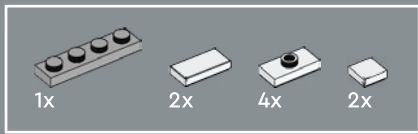

17

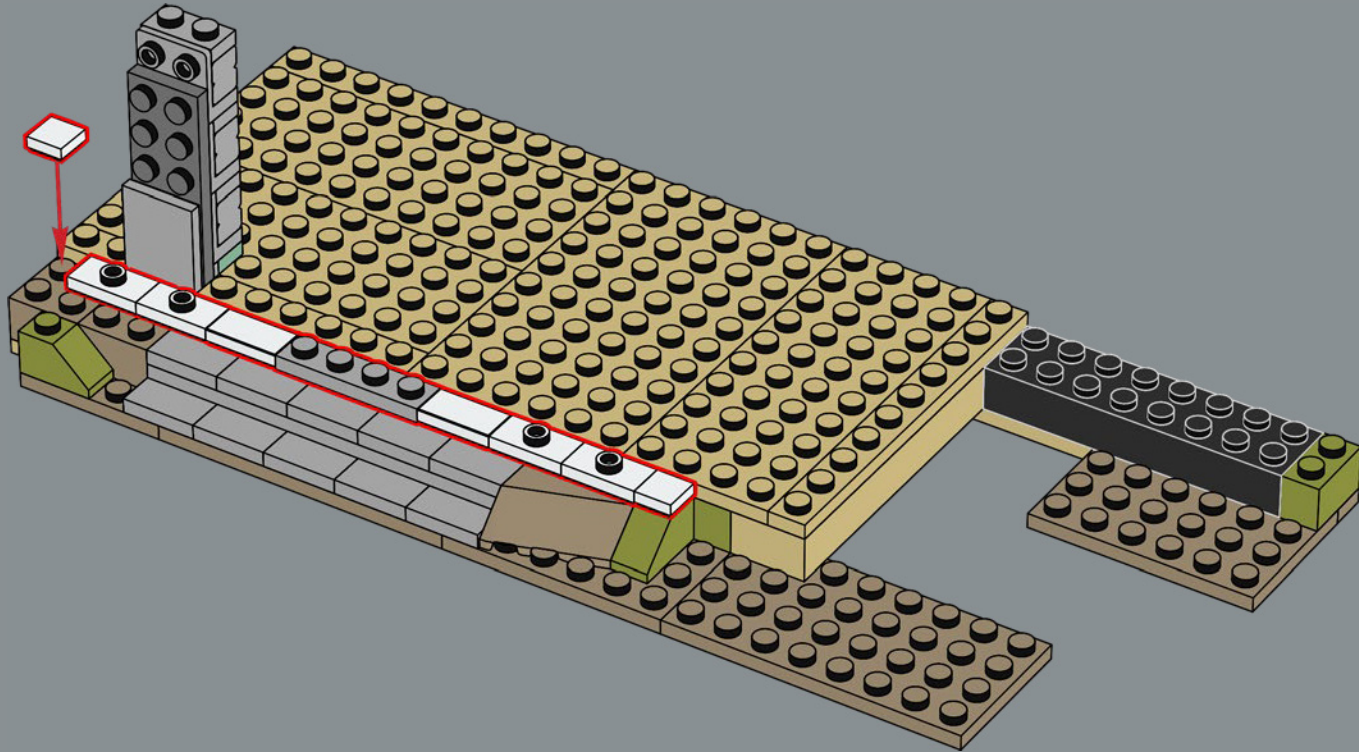

 1x	 2x
--	--

18

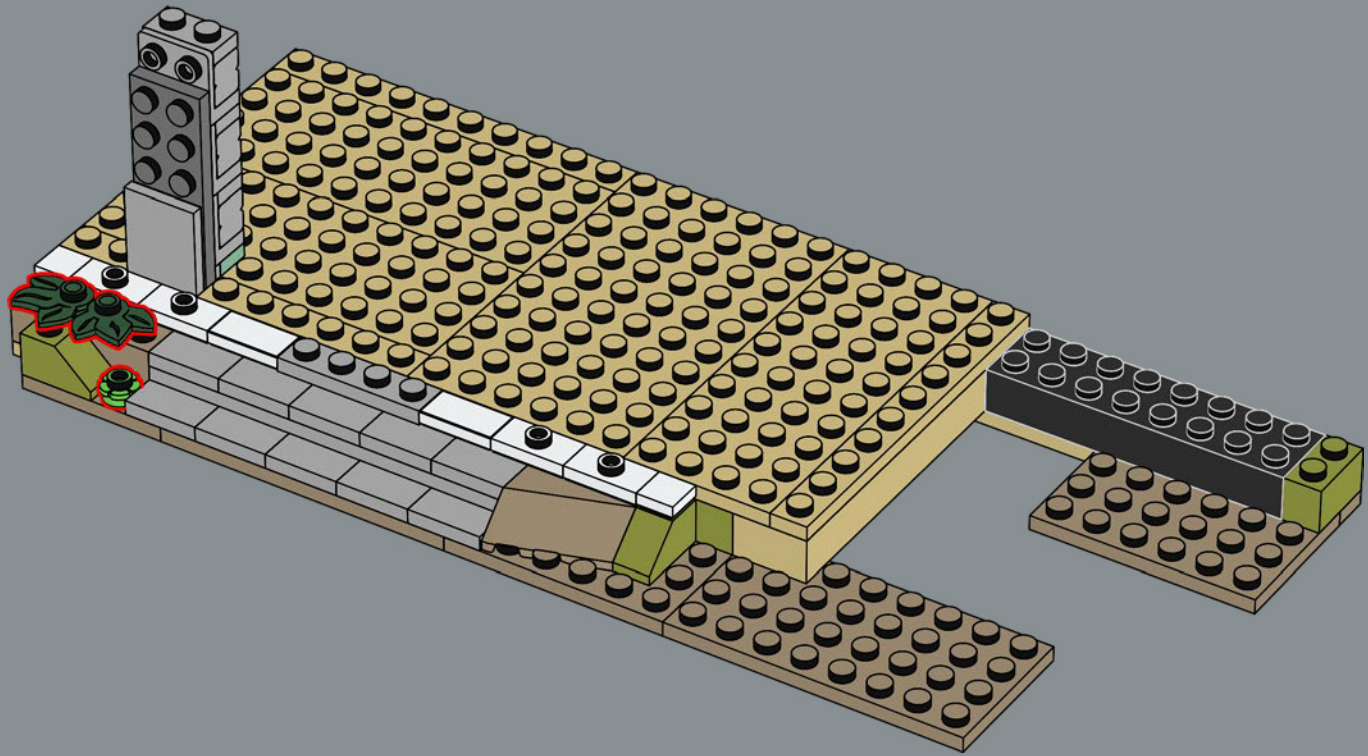

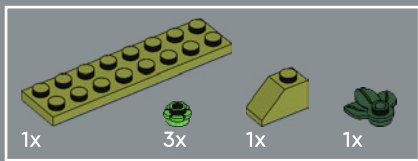

19

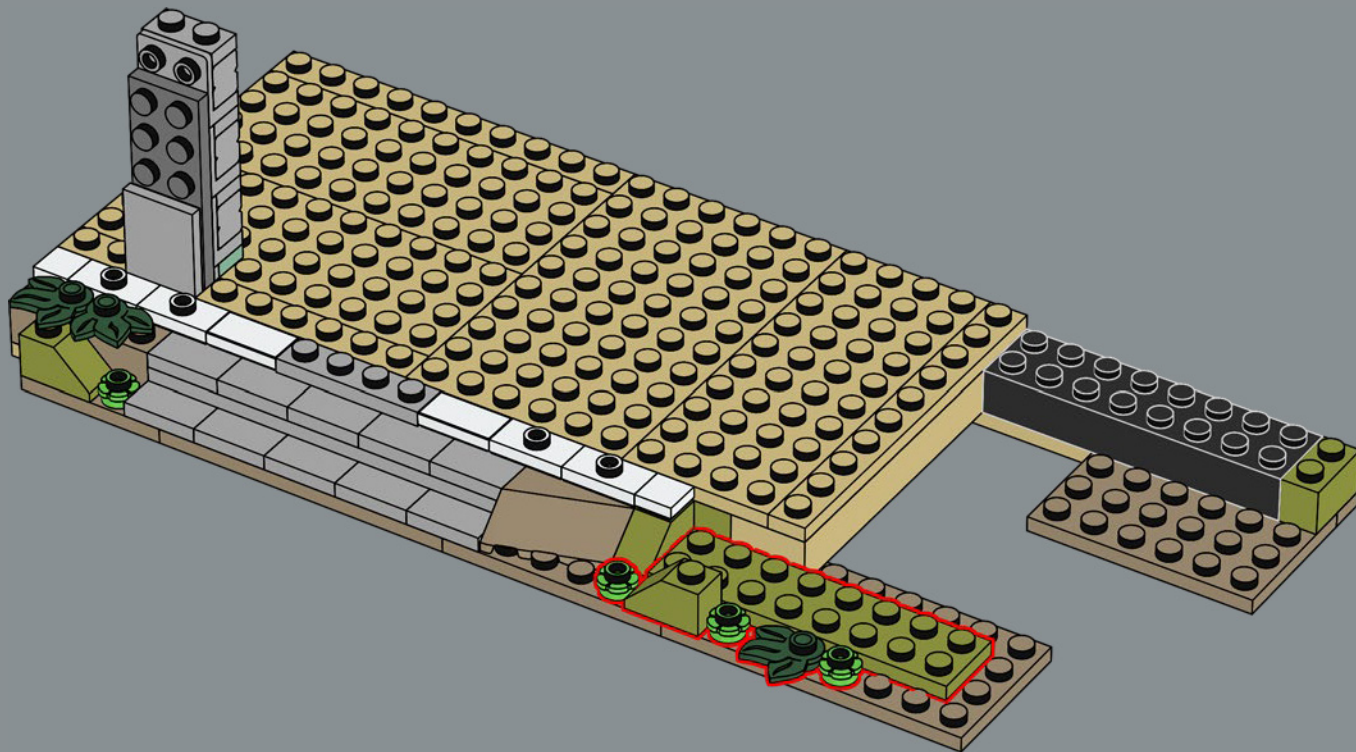

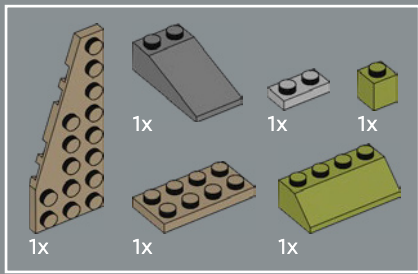

21

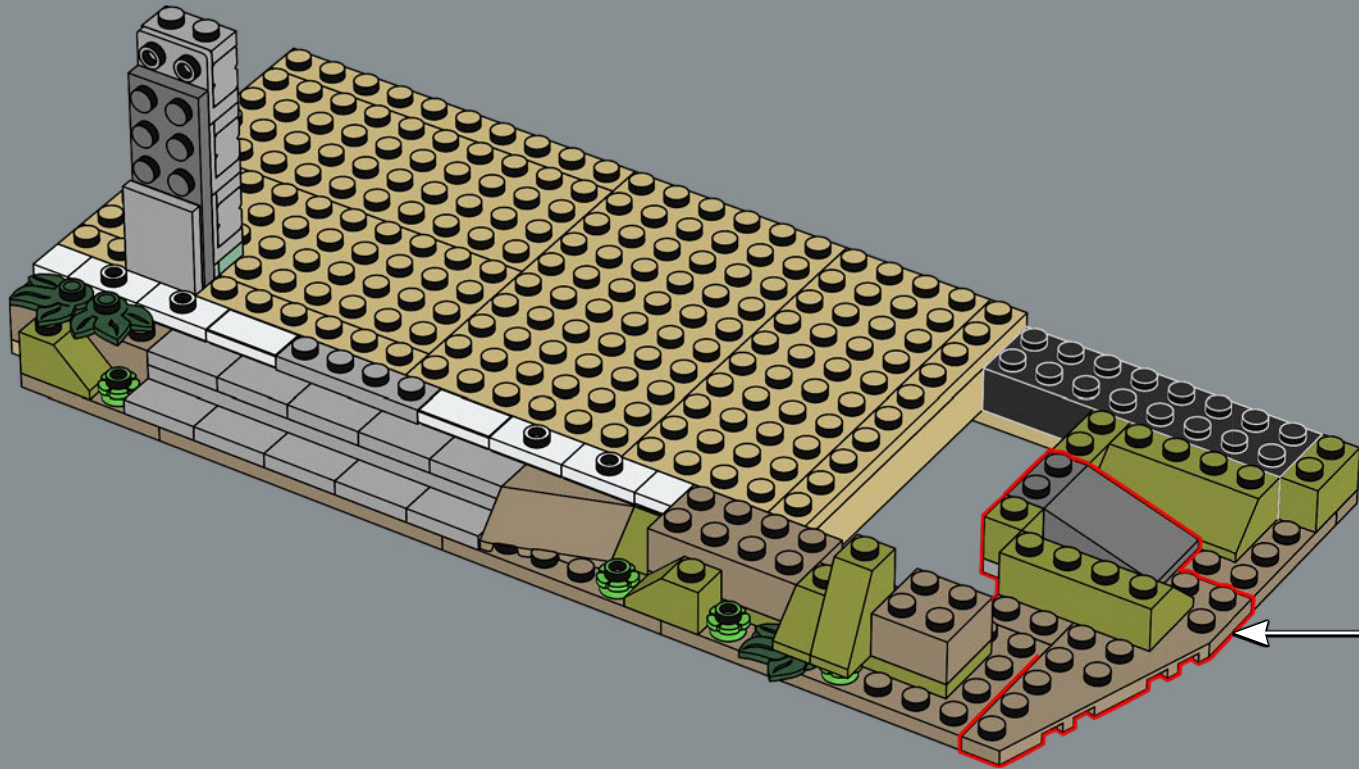
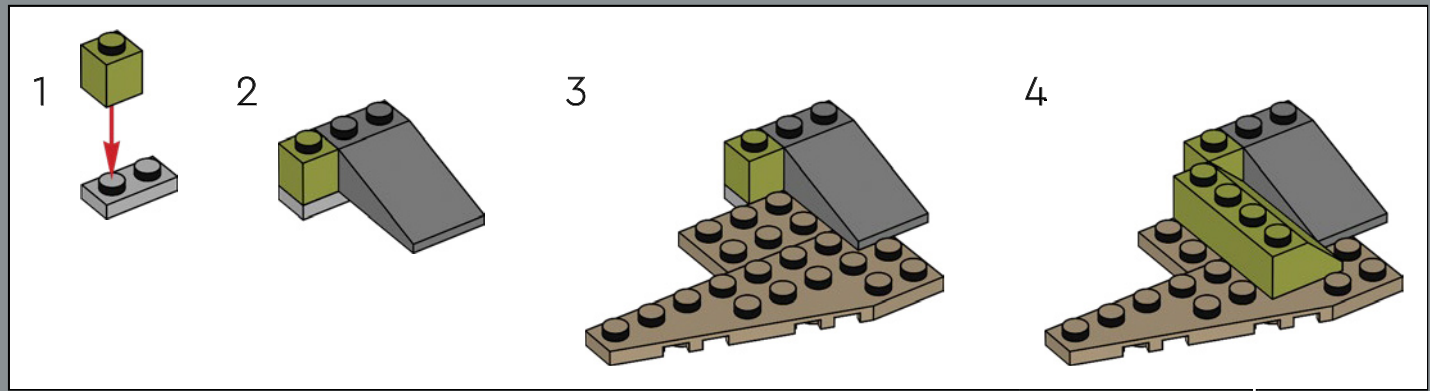

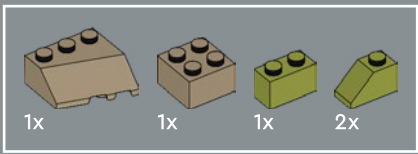

22

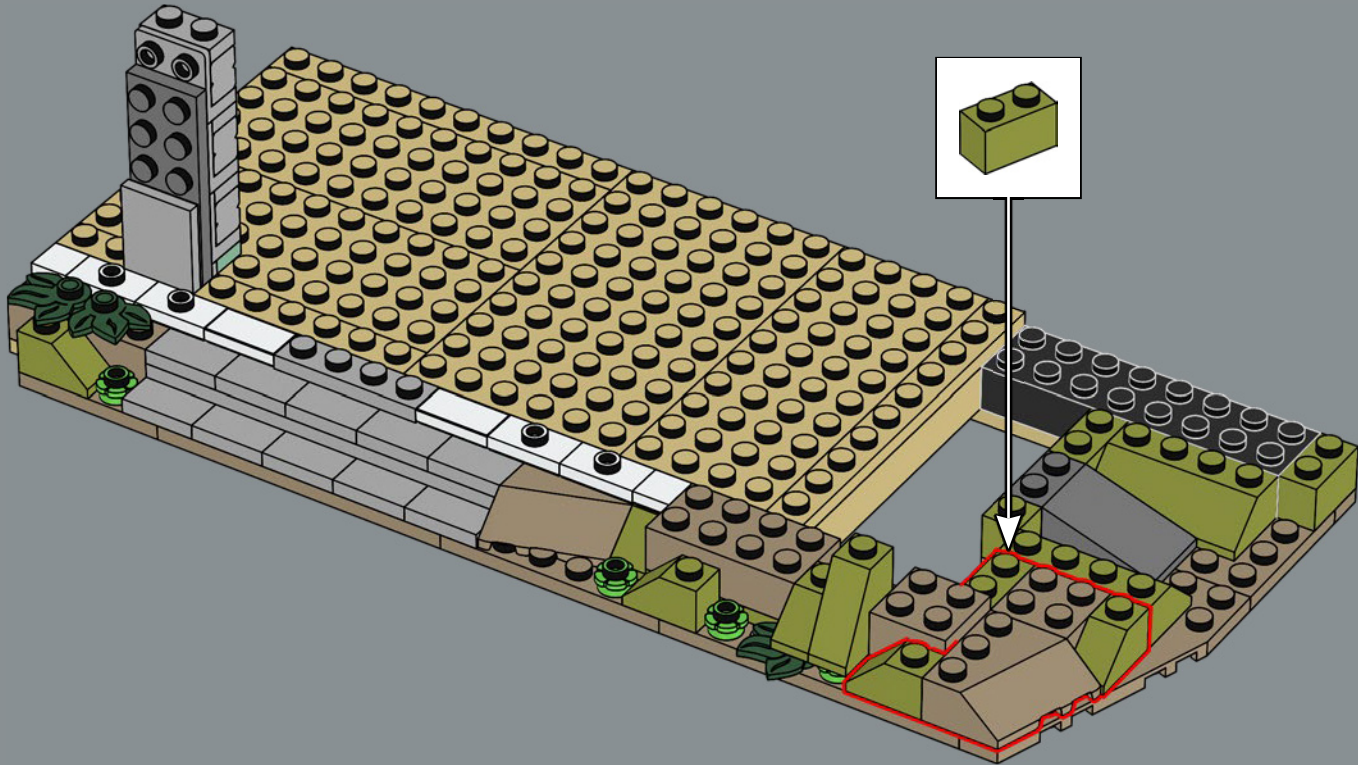

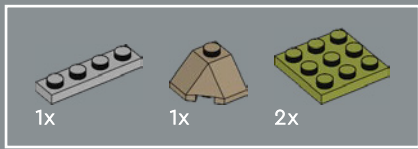

23

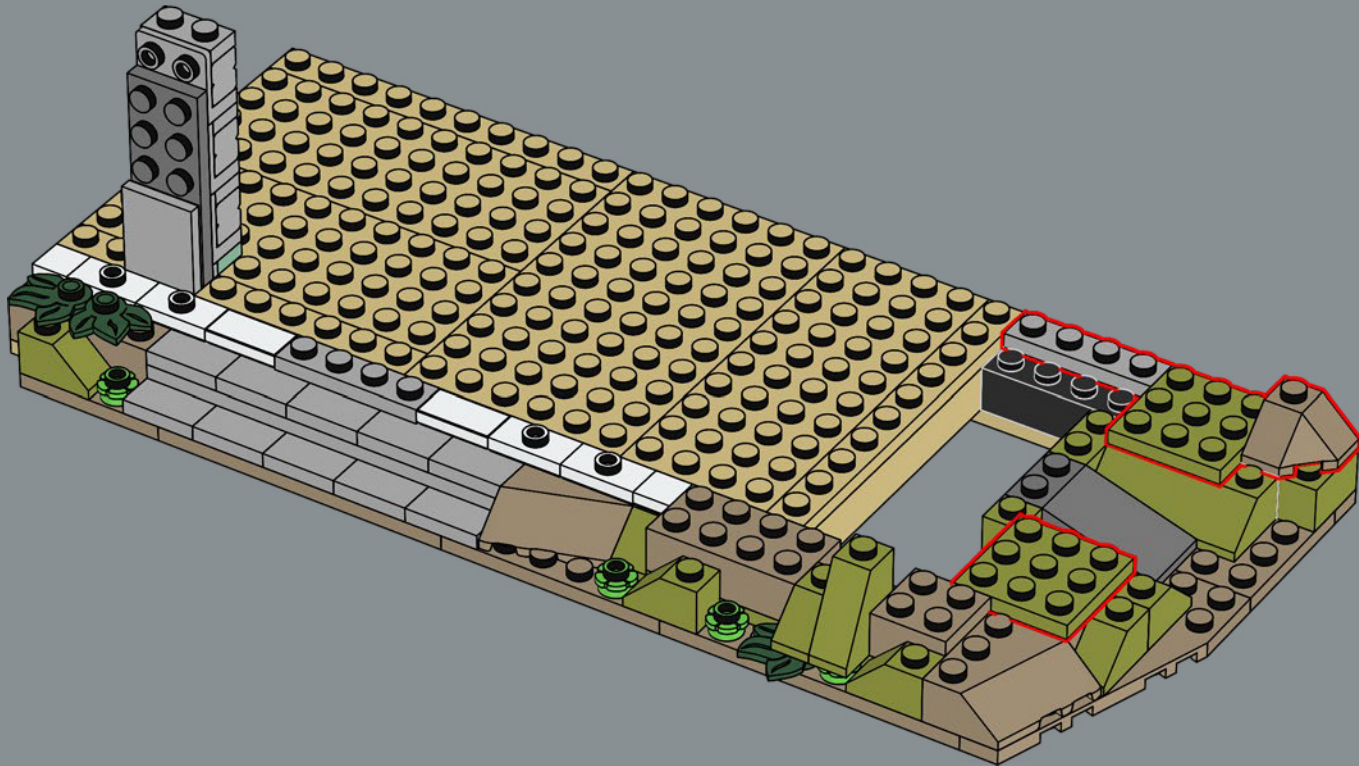

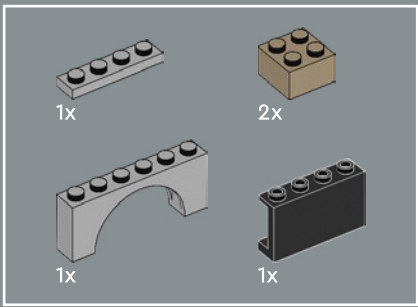

24

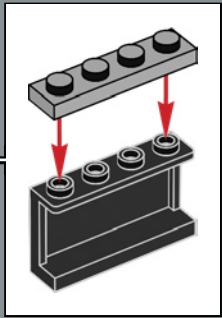
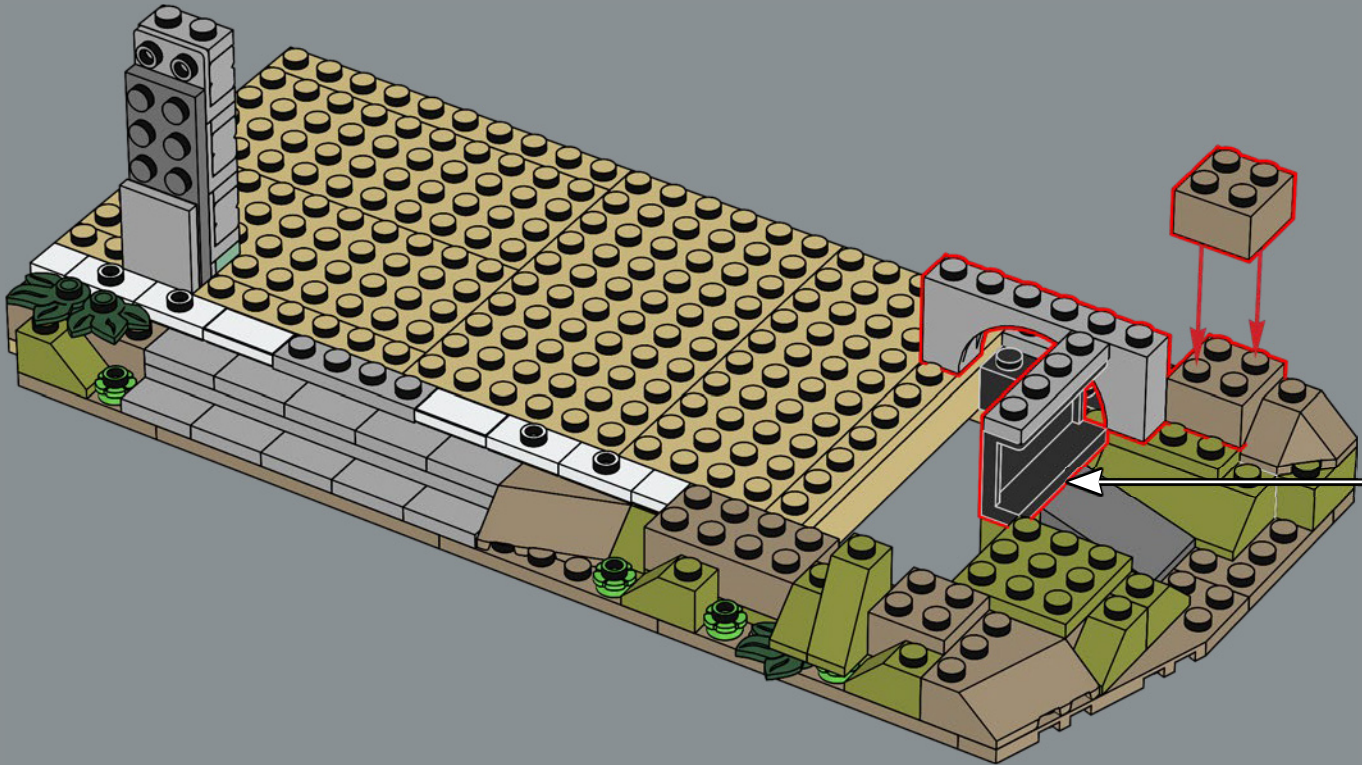

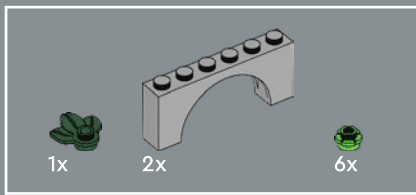

25

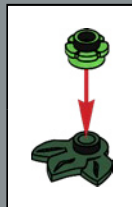
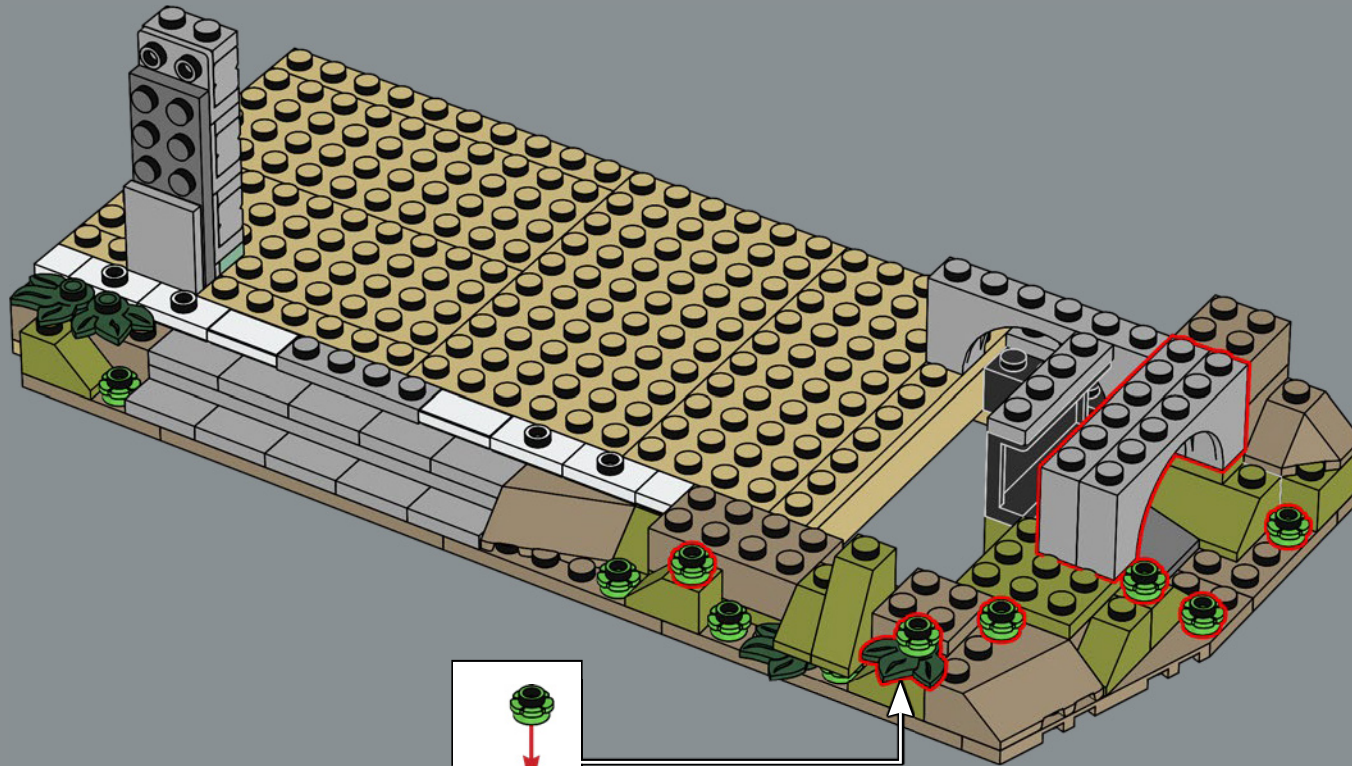

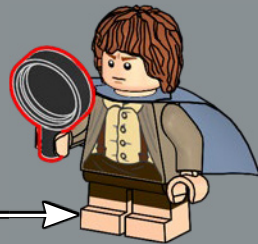
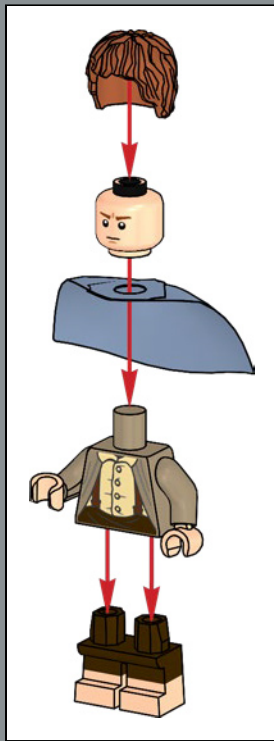
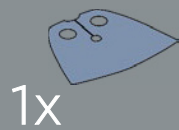
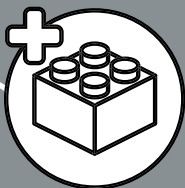

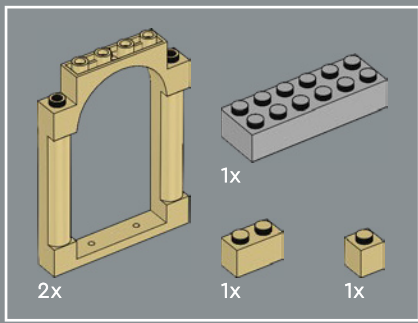

26

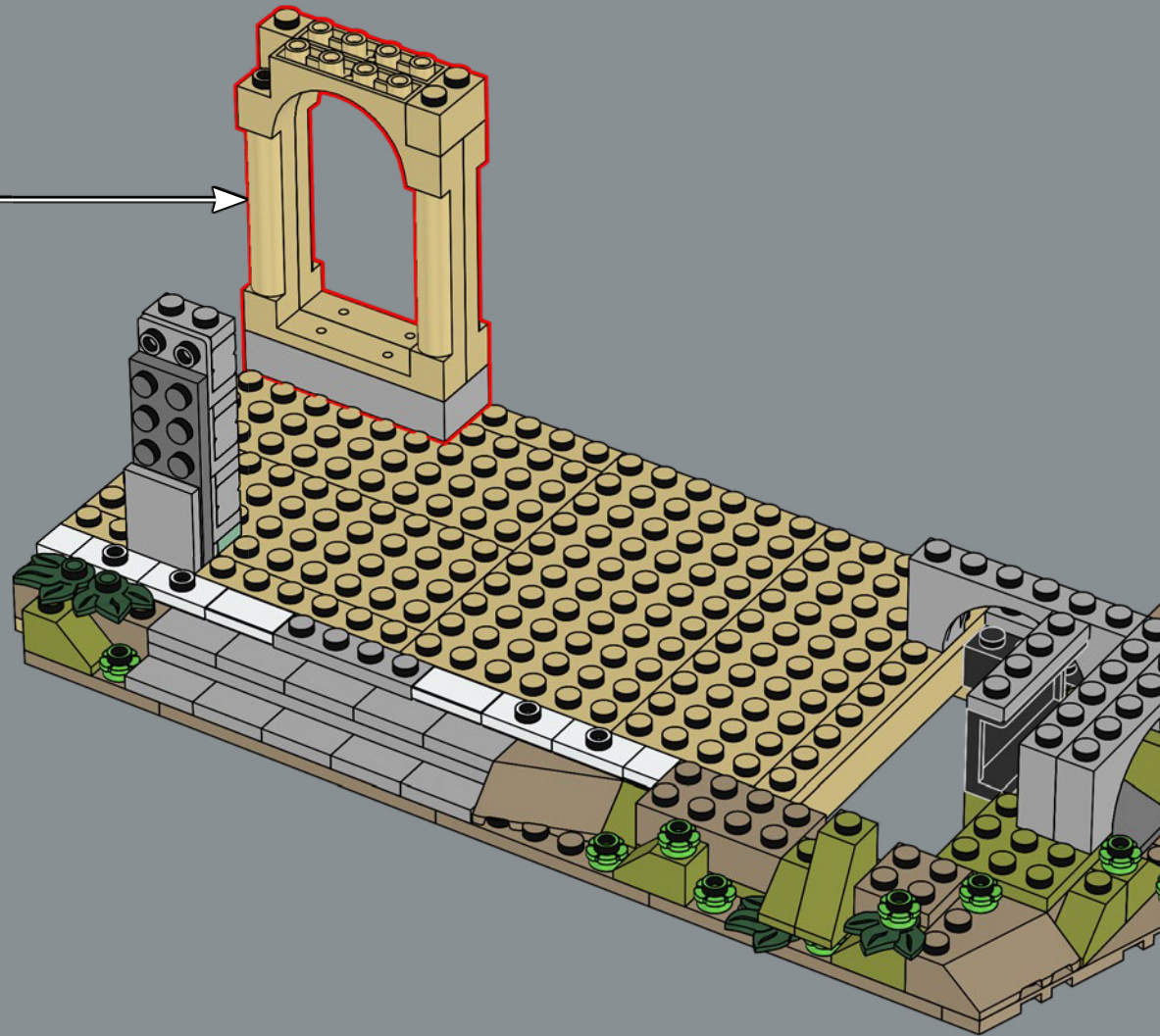
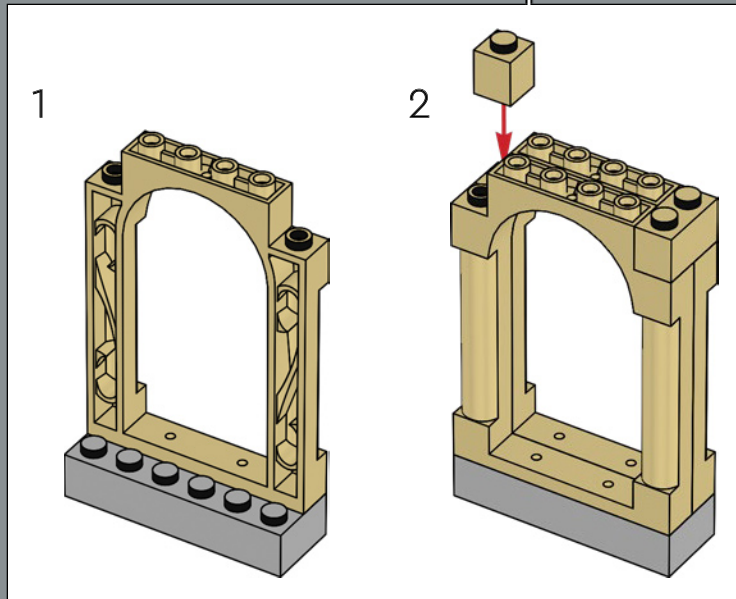

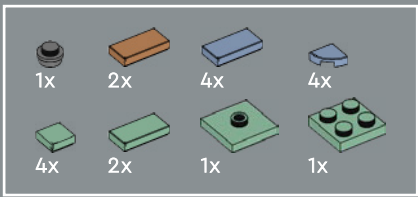

27

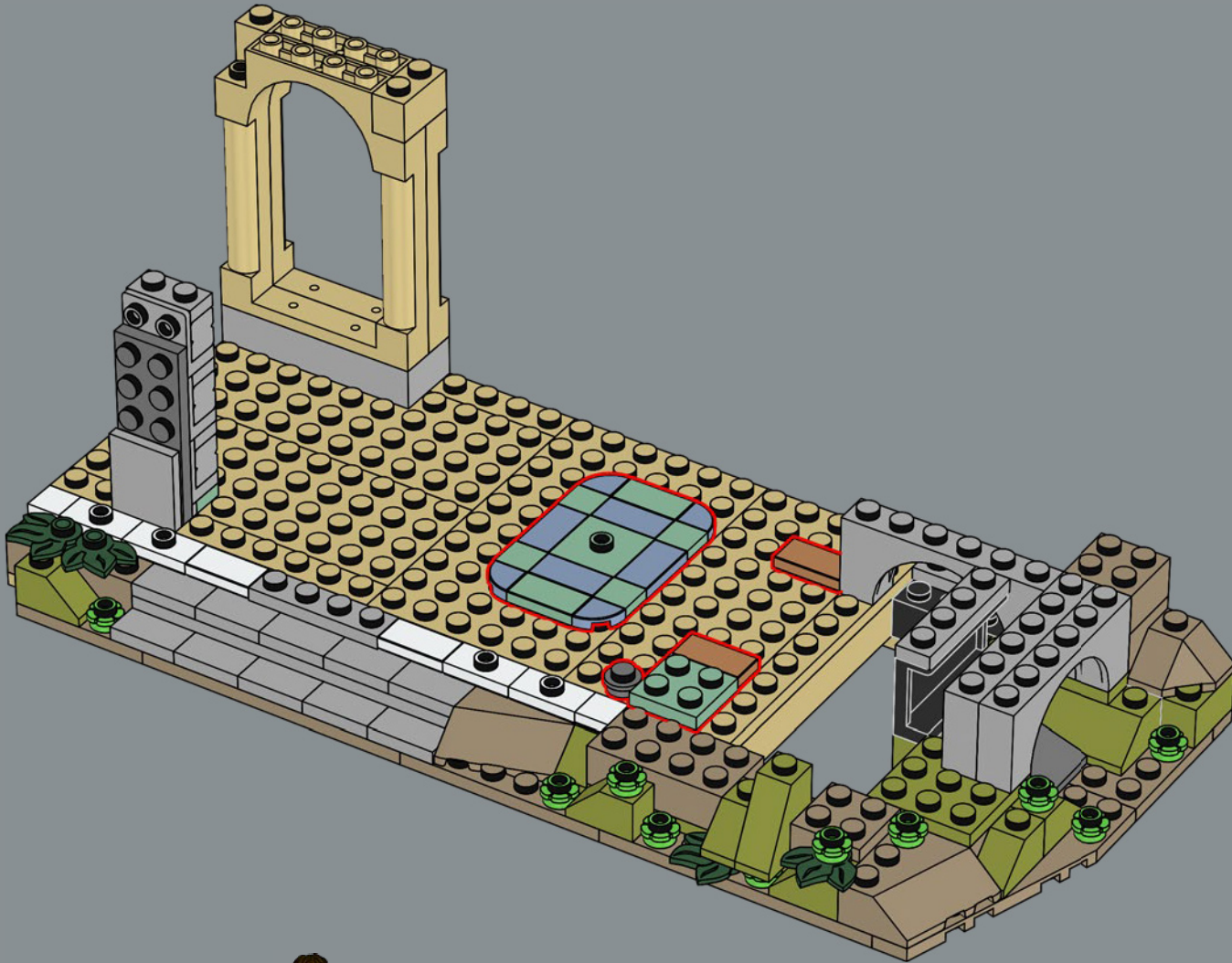

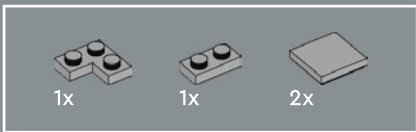

28

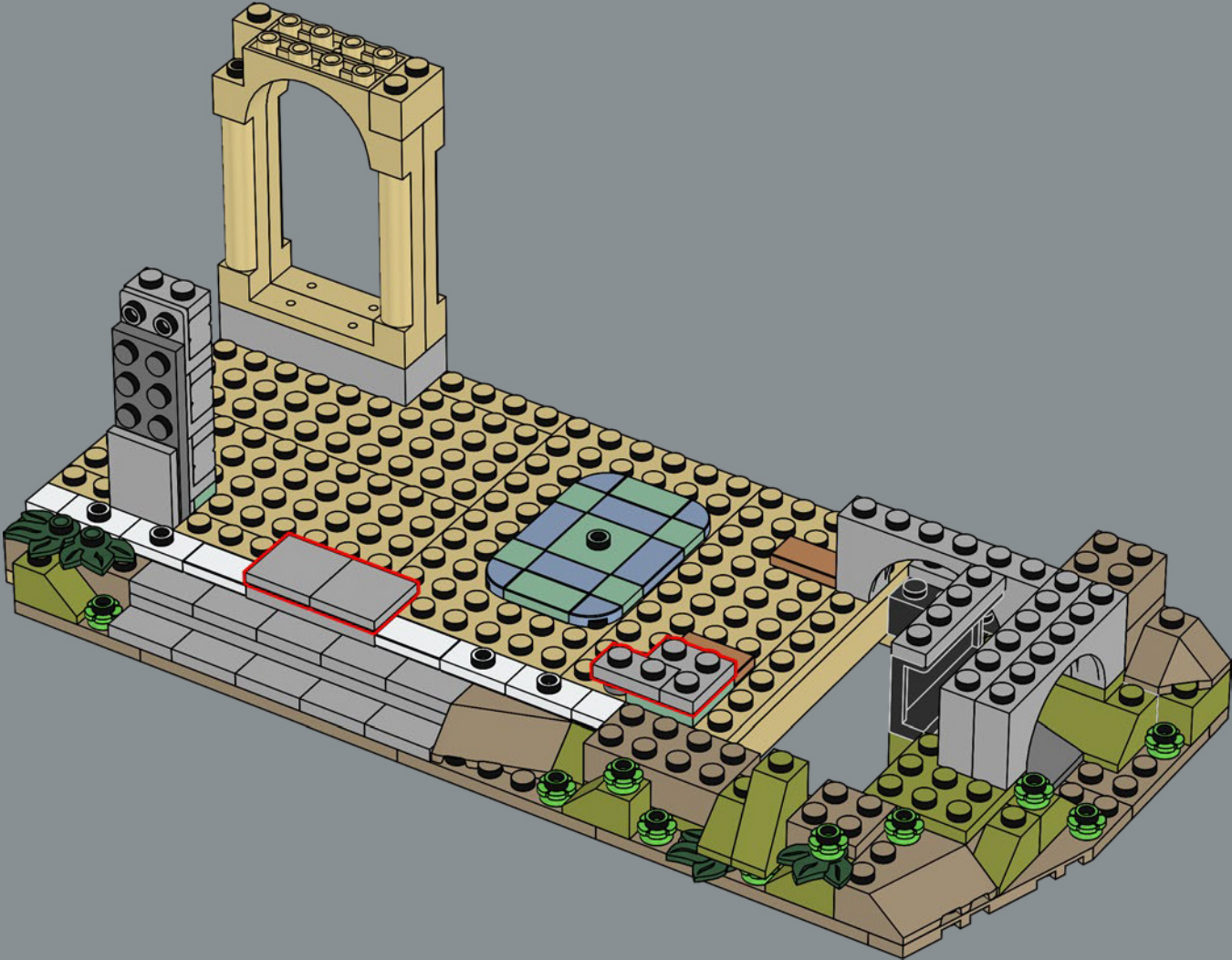



2x

29

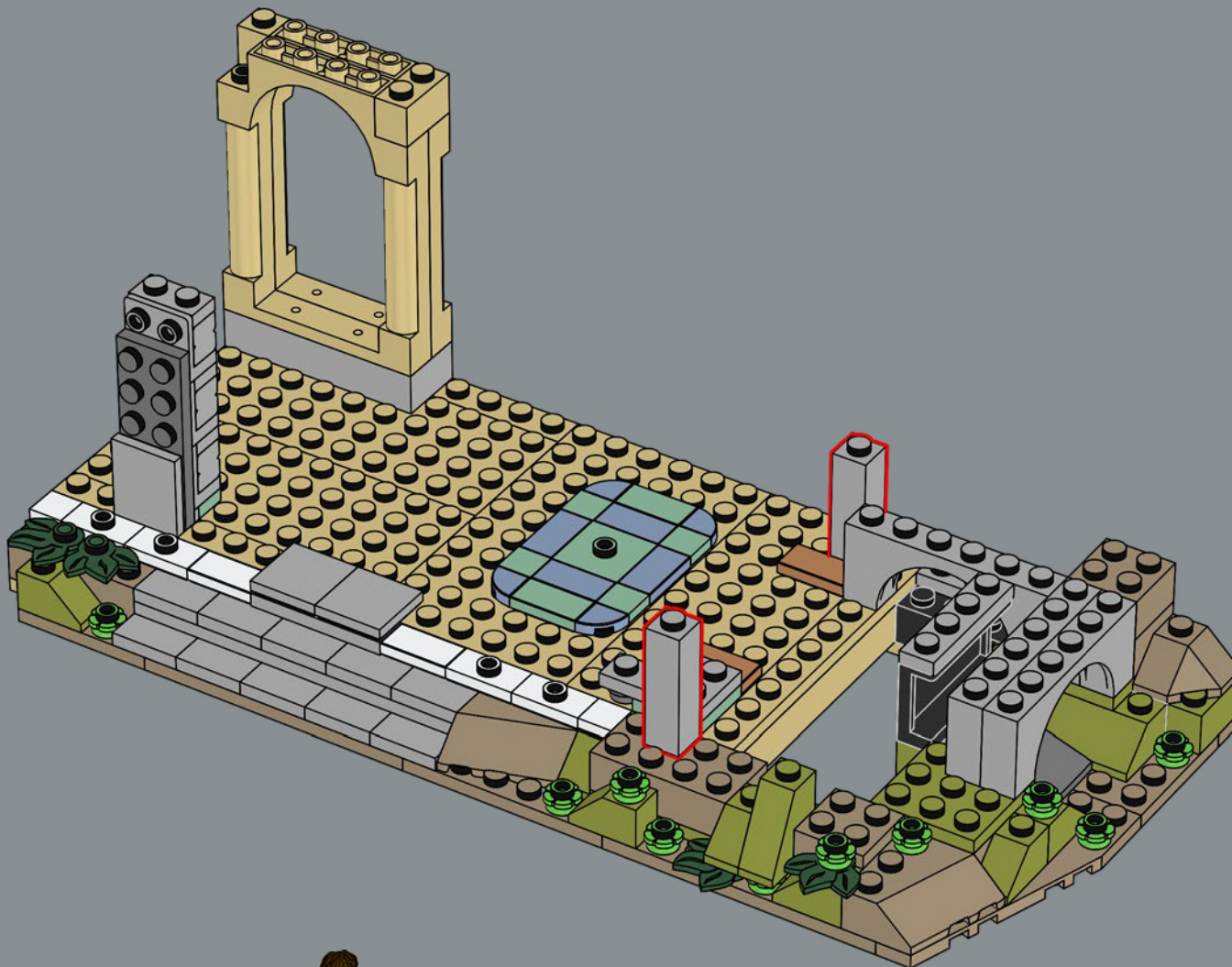



Dieser Farn ist ein völlig neu designtes Element. Er ist 2023 zum allerersten Mal in einem Set enthalten und kommt insgesamt 34 Mal in diesem Modell vor!

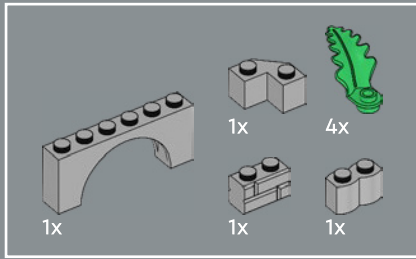

30

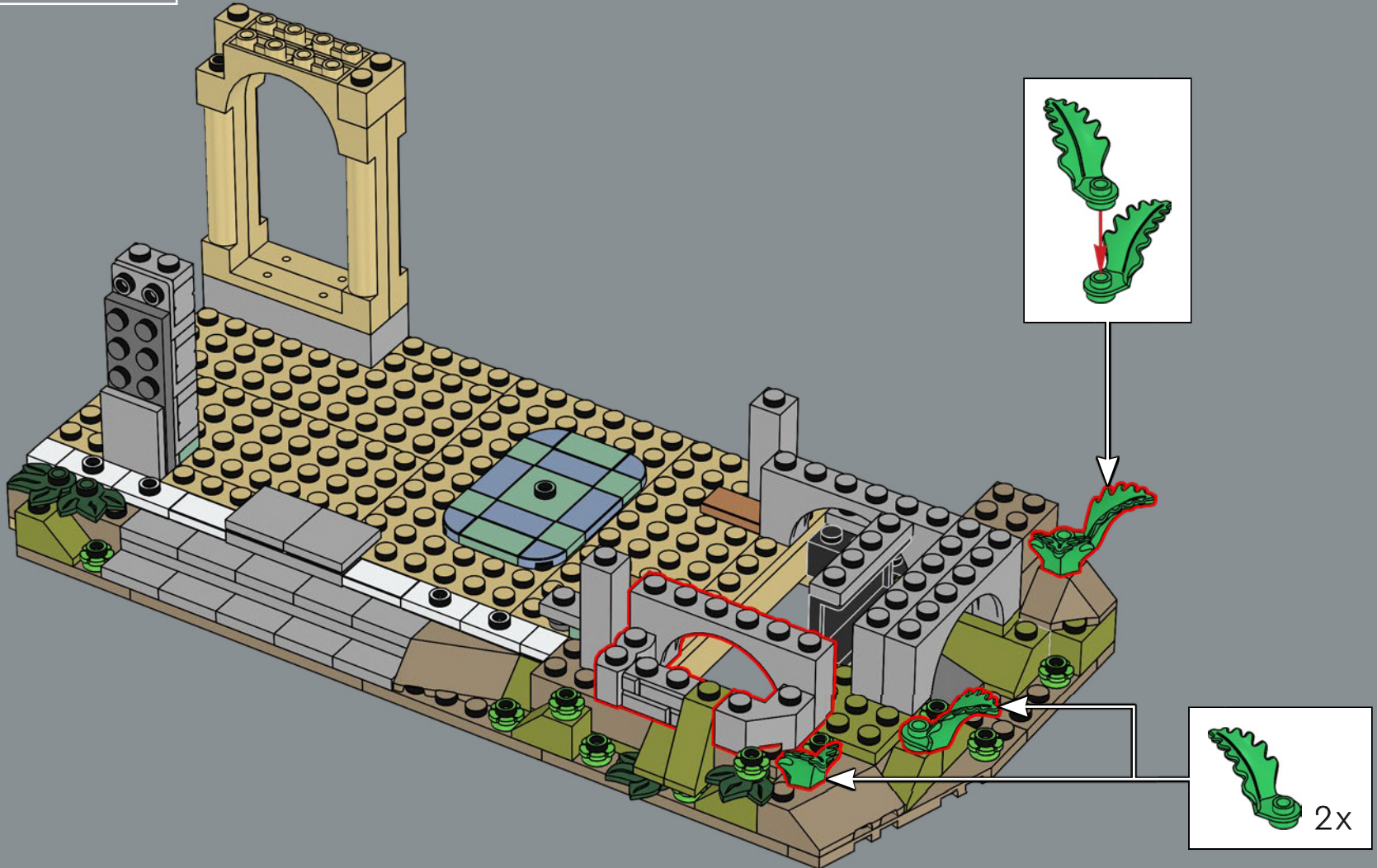

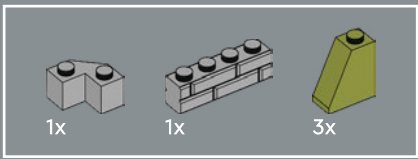

31

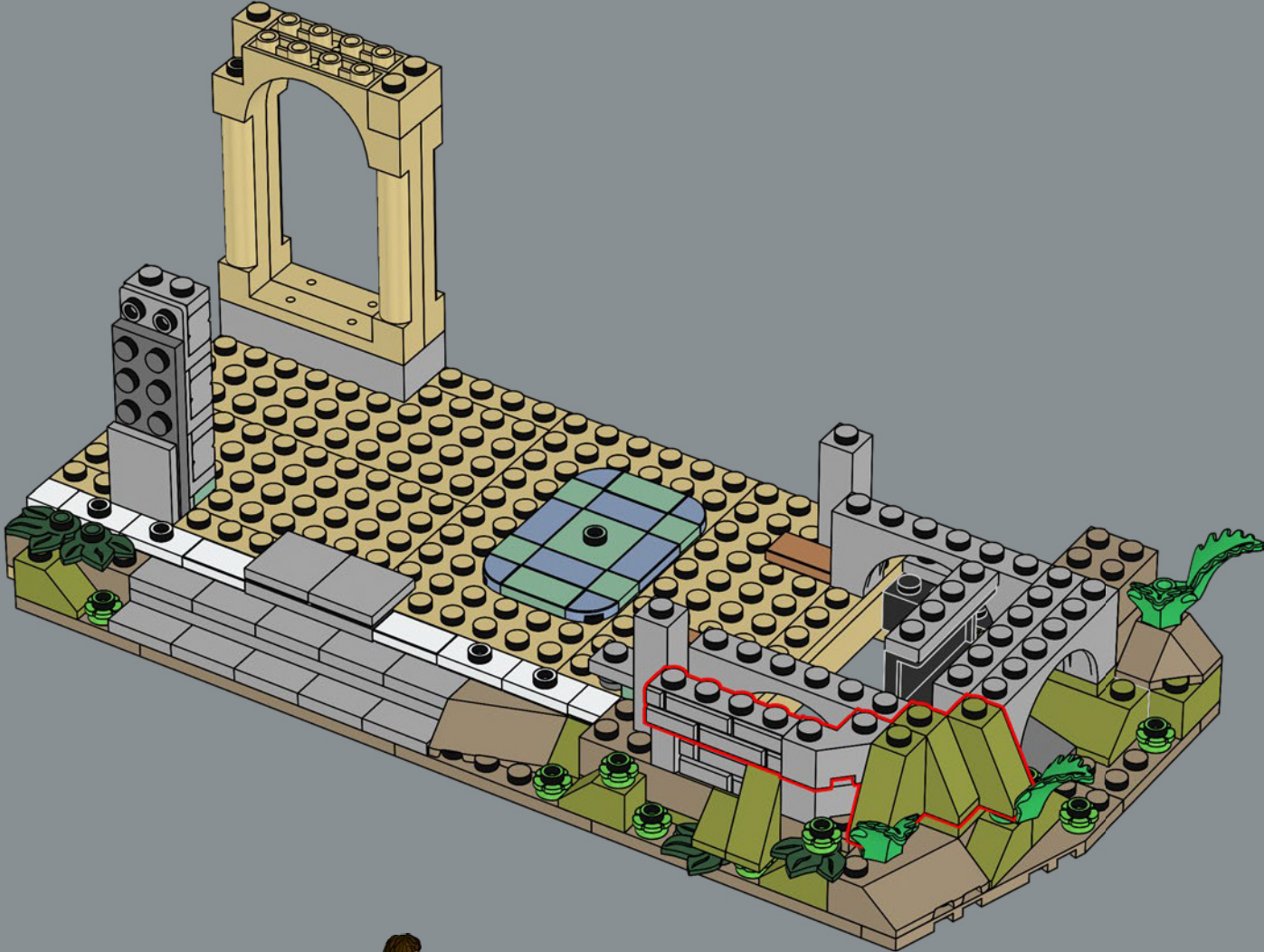

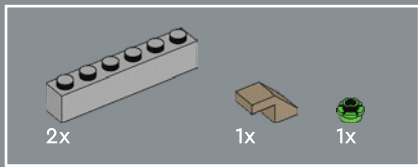

32

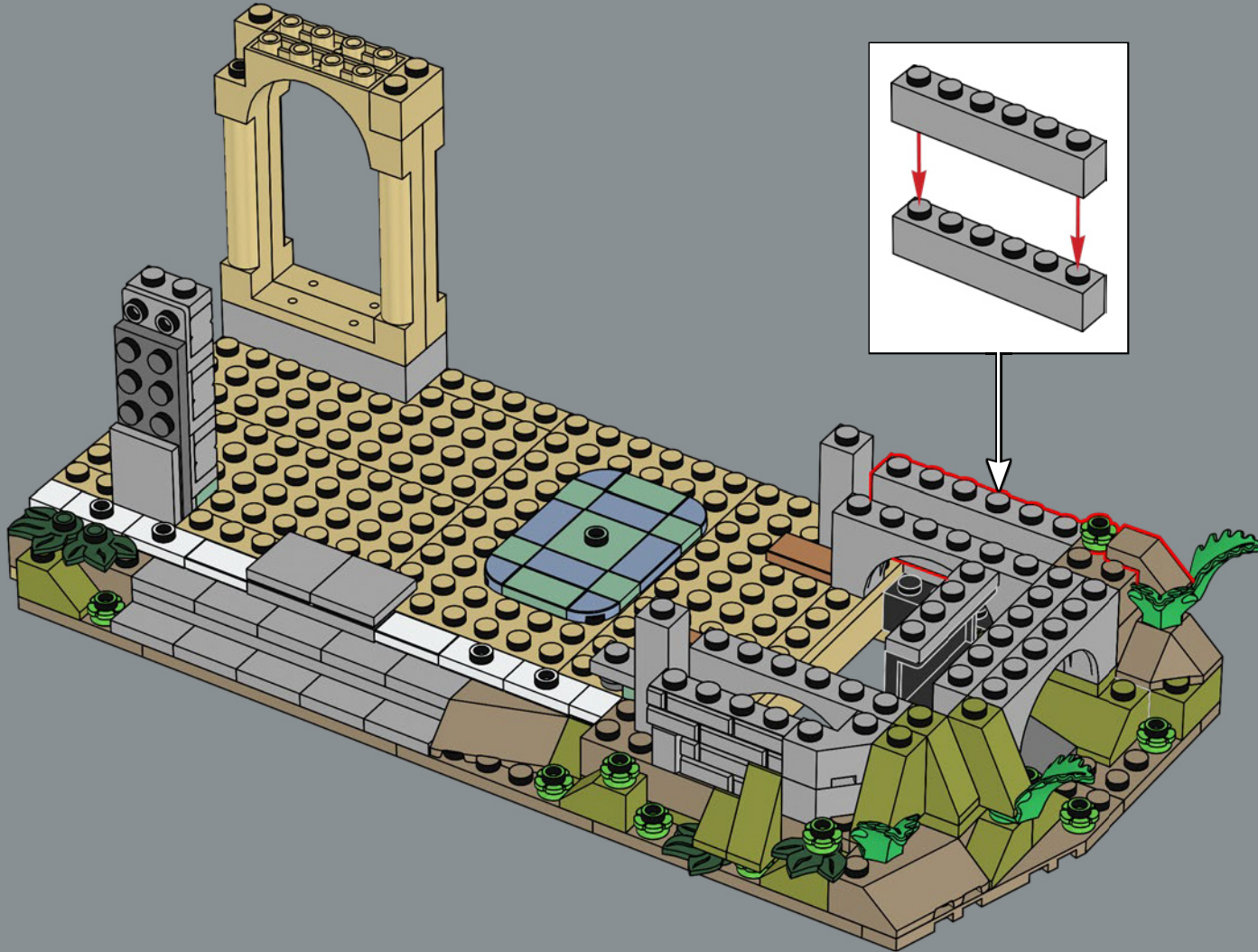

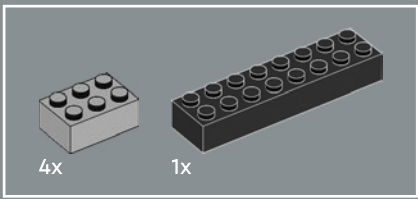

33

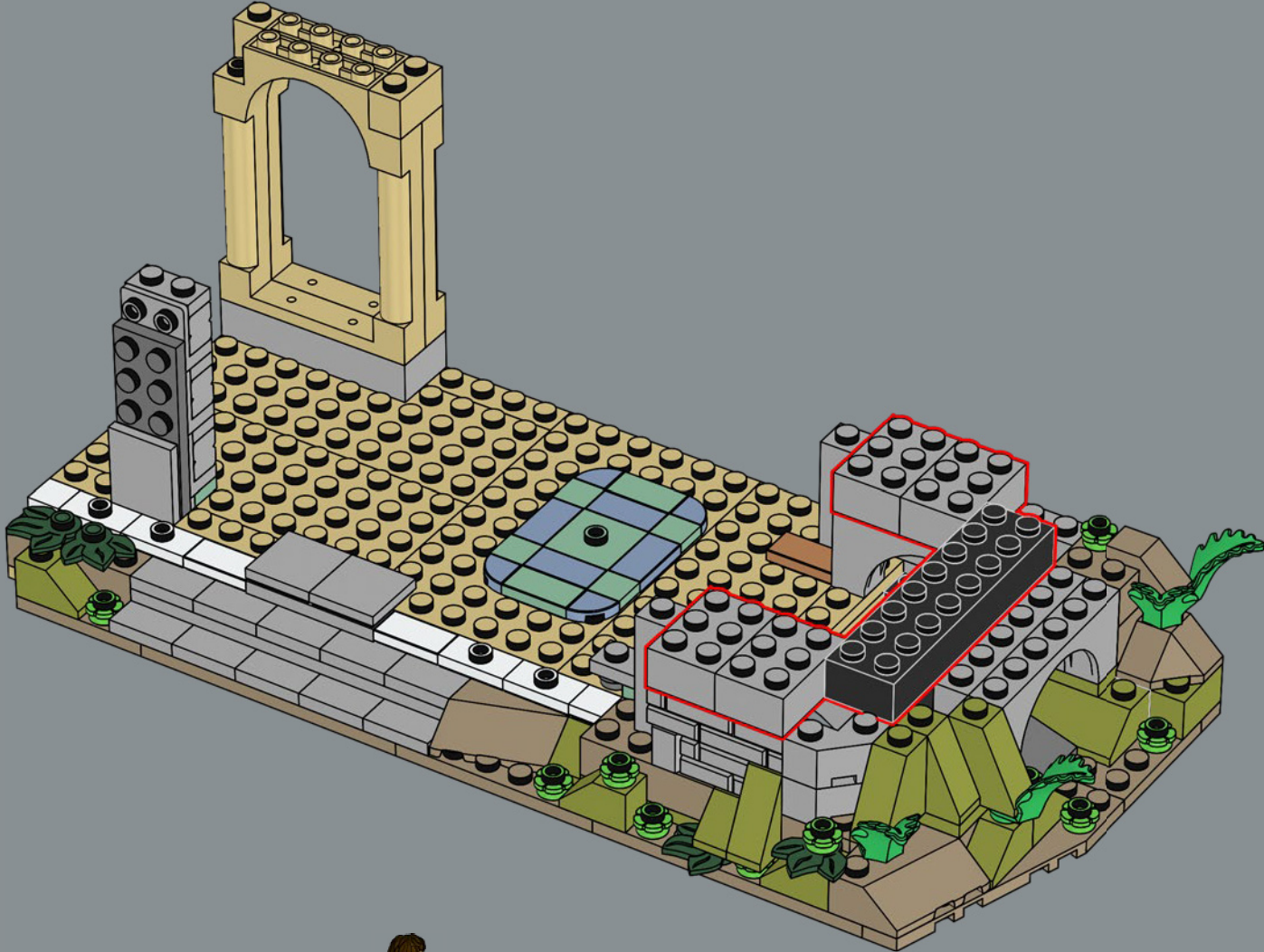

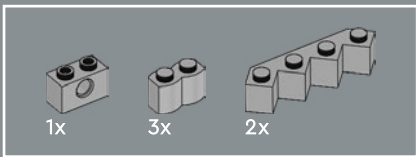

34

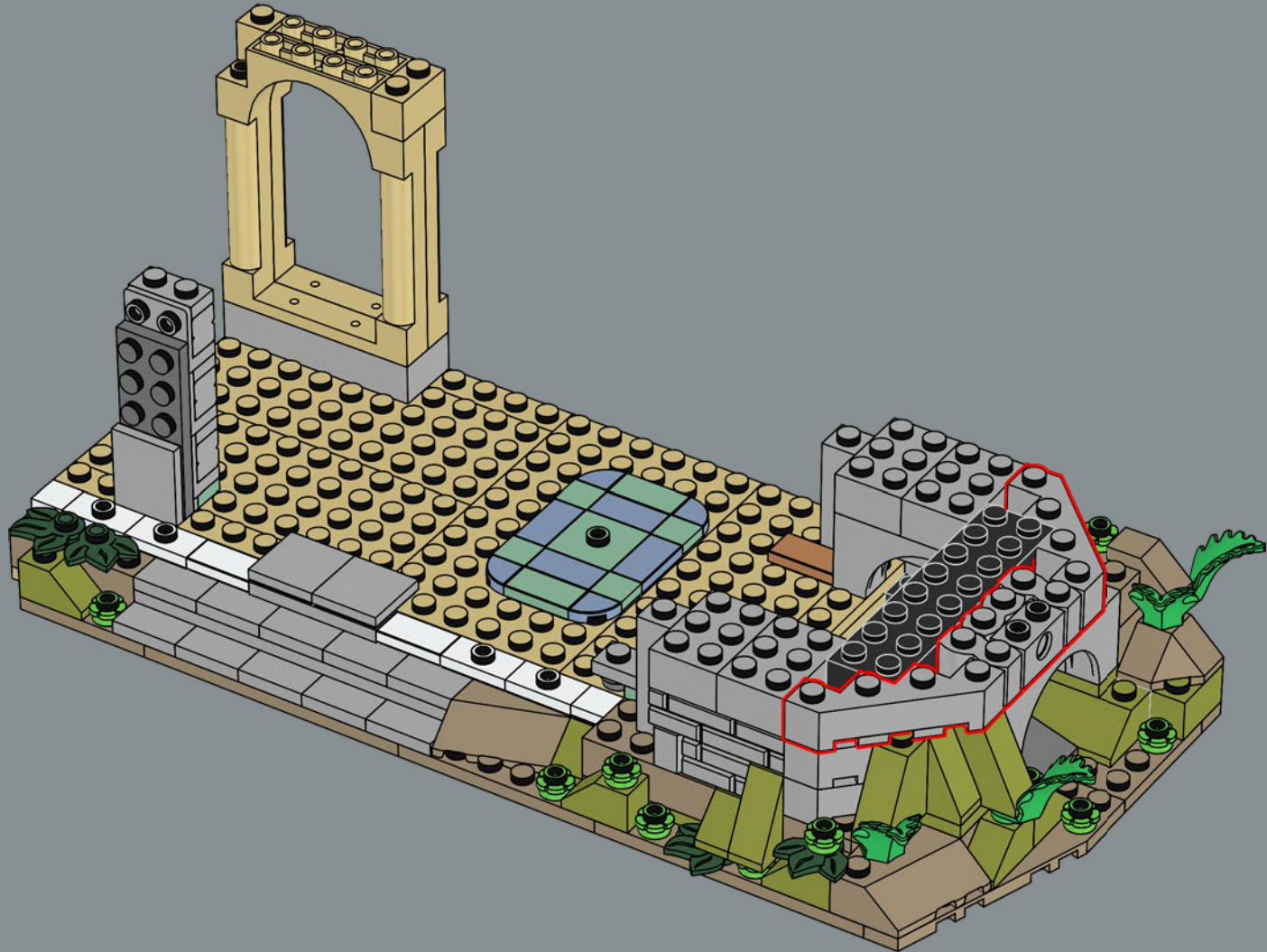

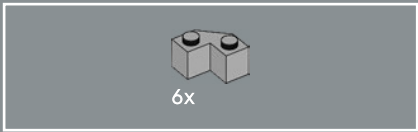

35

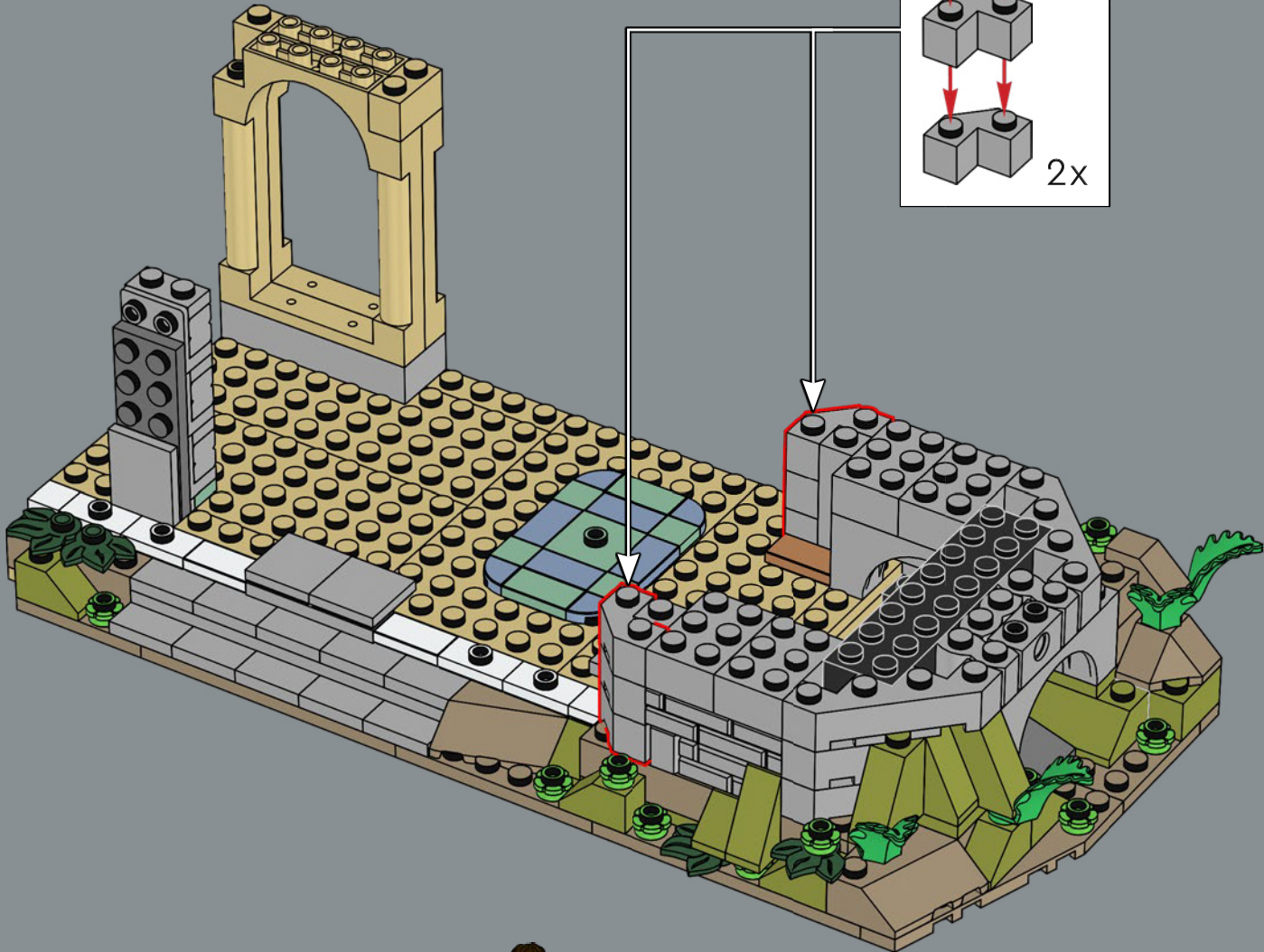
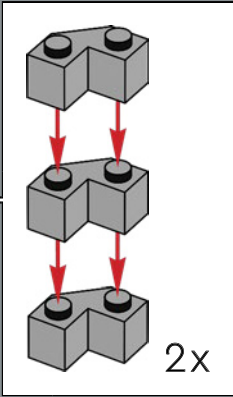

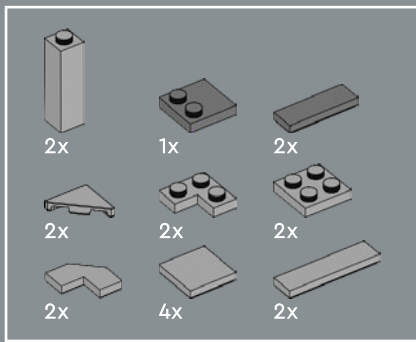

36

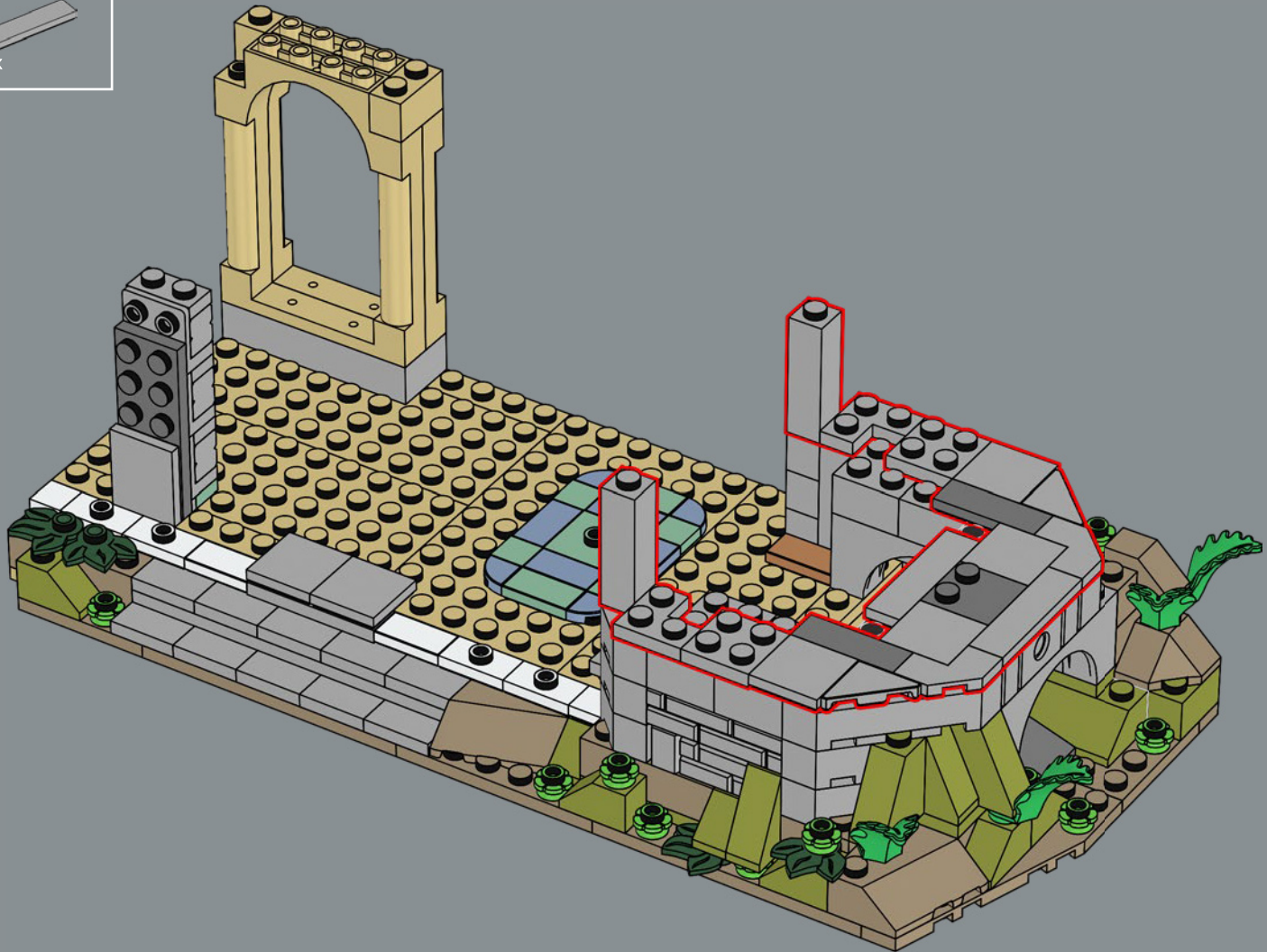

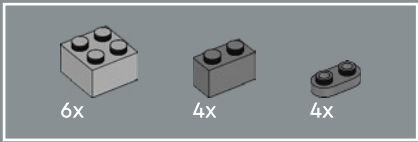

37

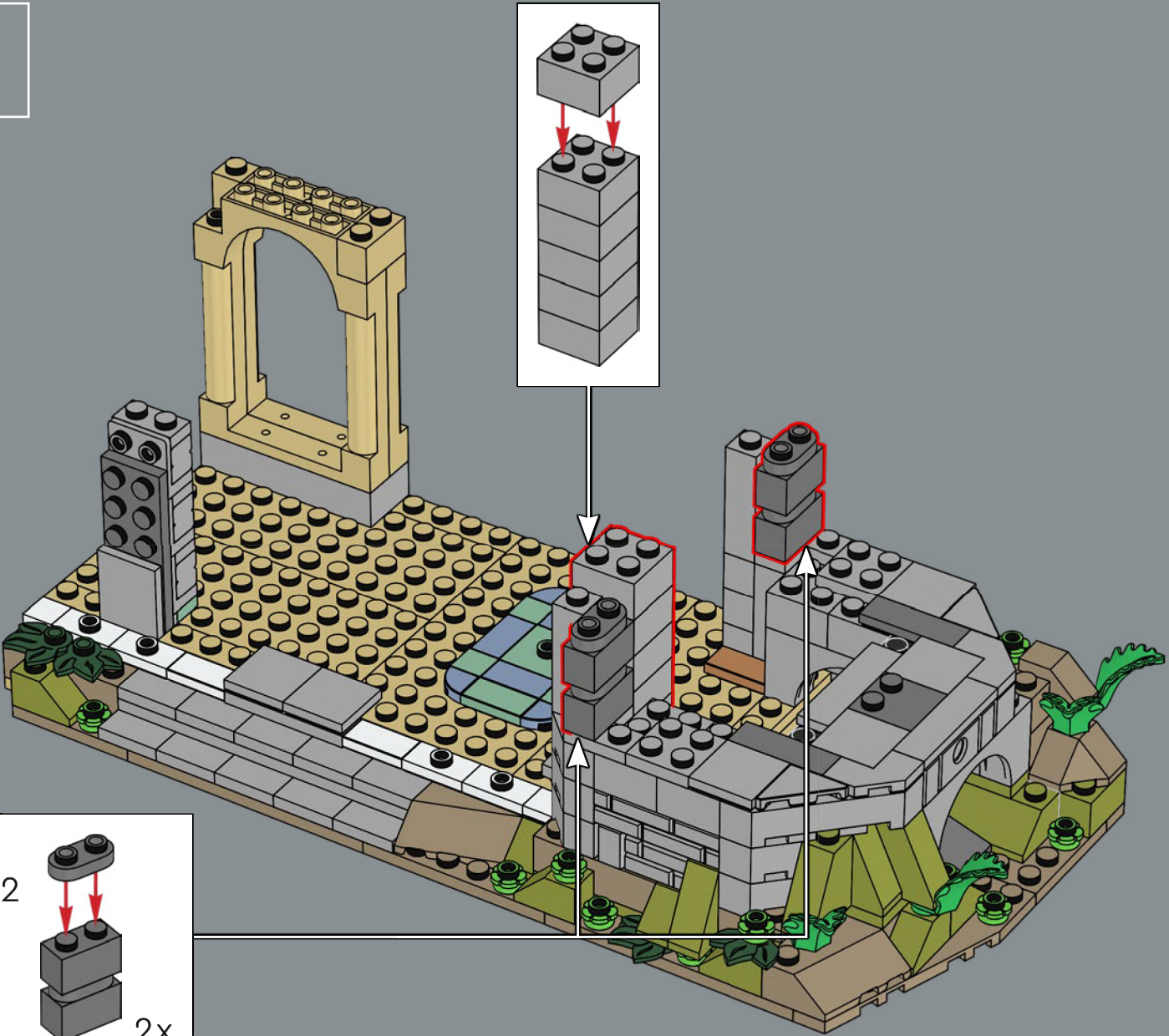

1

2

2x



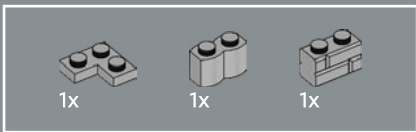

38

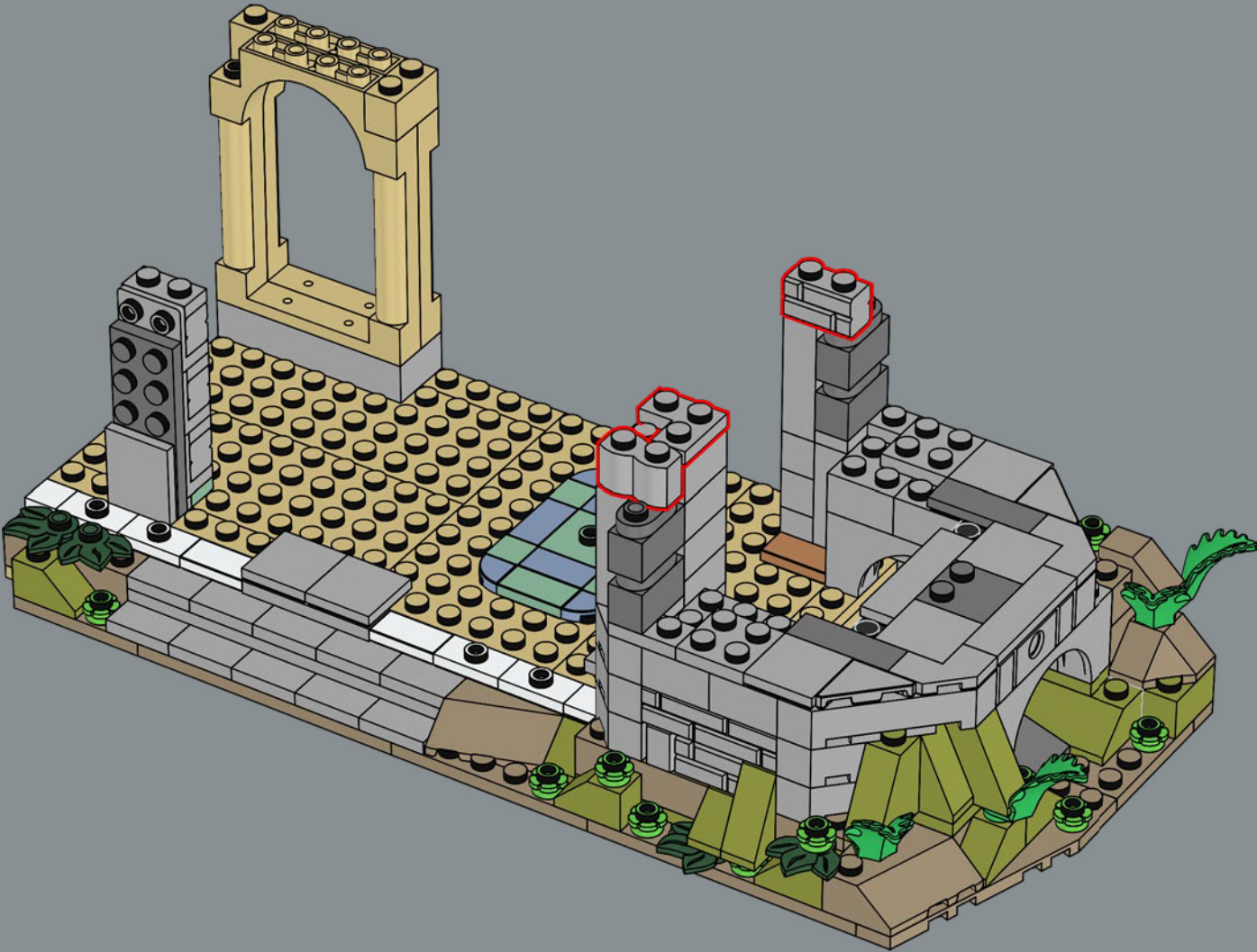



Dieses Versteck für Samweis Gamdschie war eines der letzten Details, das zum Modell hinzugefügt wurde.

- 3x
- 1x
- 1x
- 3x
- 1x

39

1



2



3



4



5



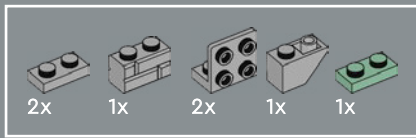

40

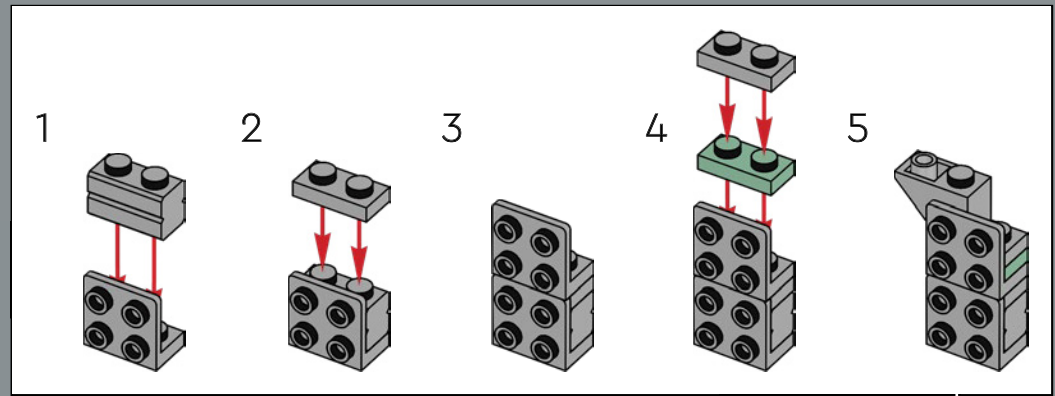
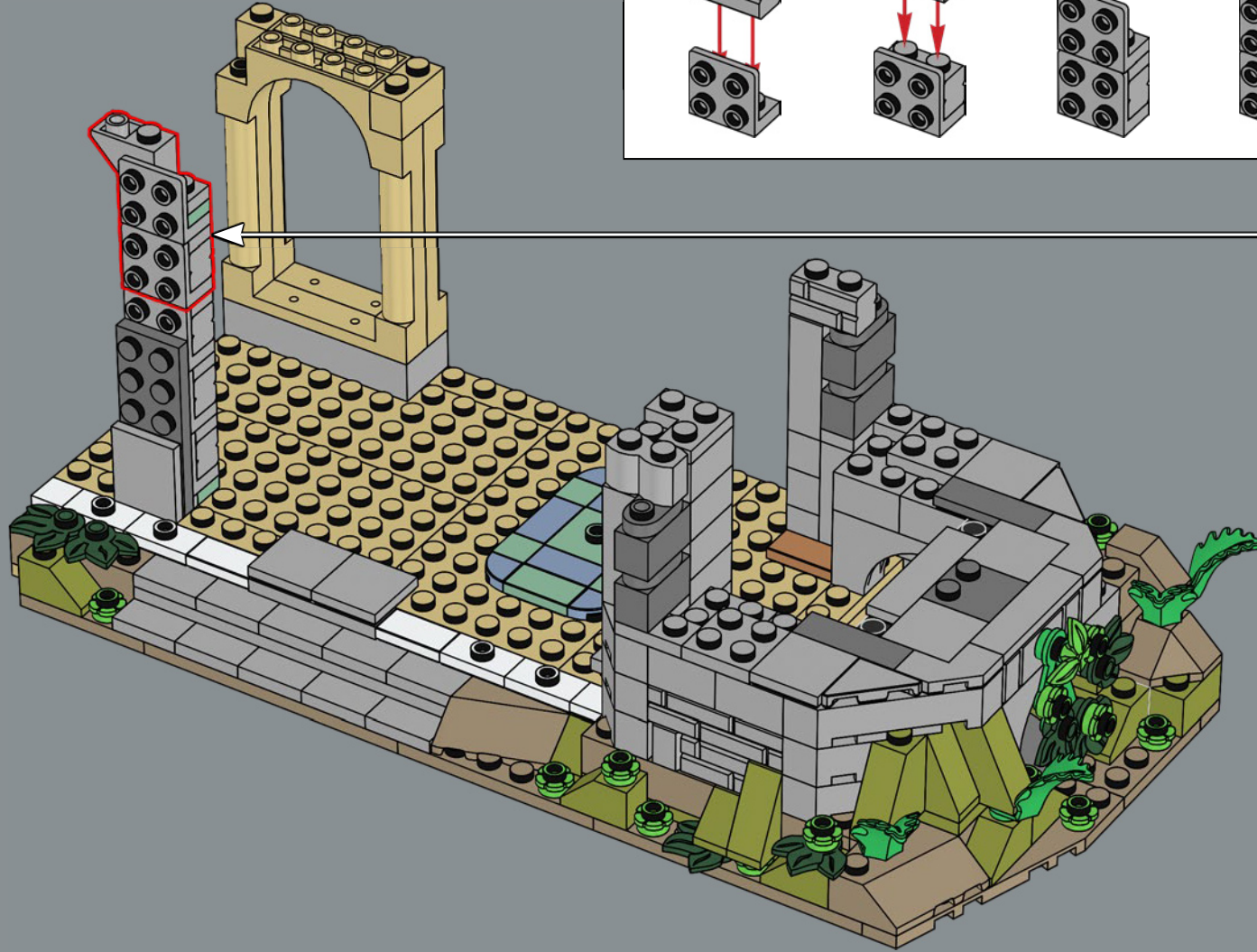

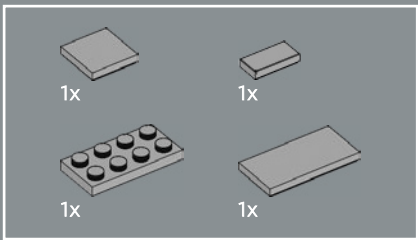

41

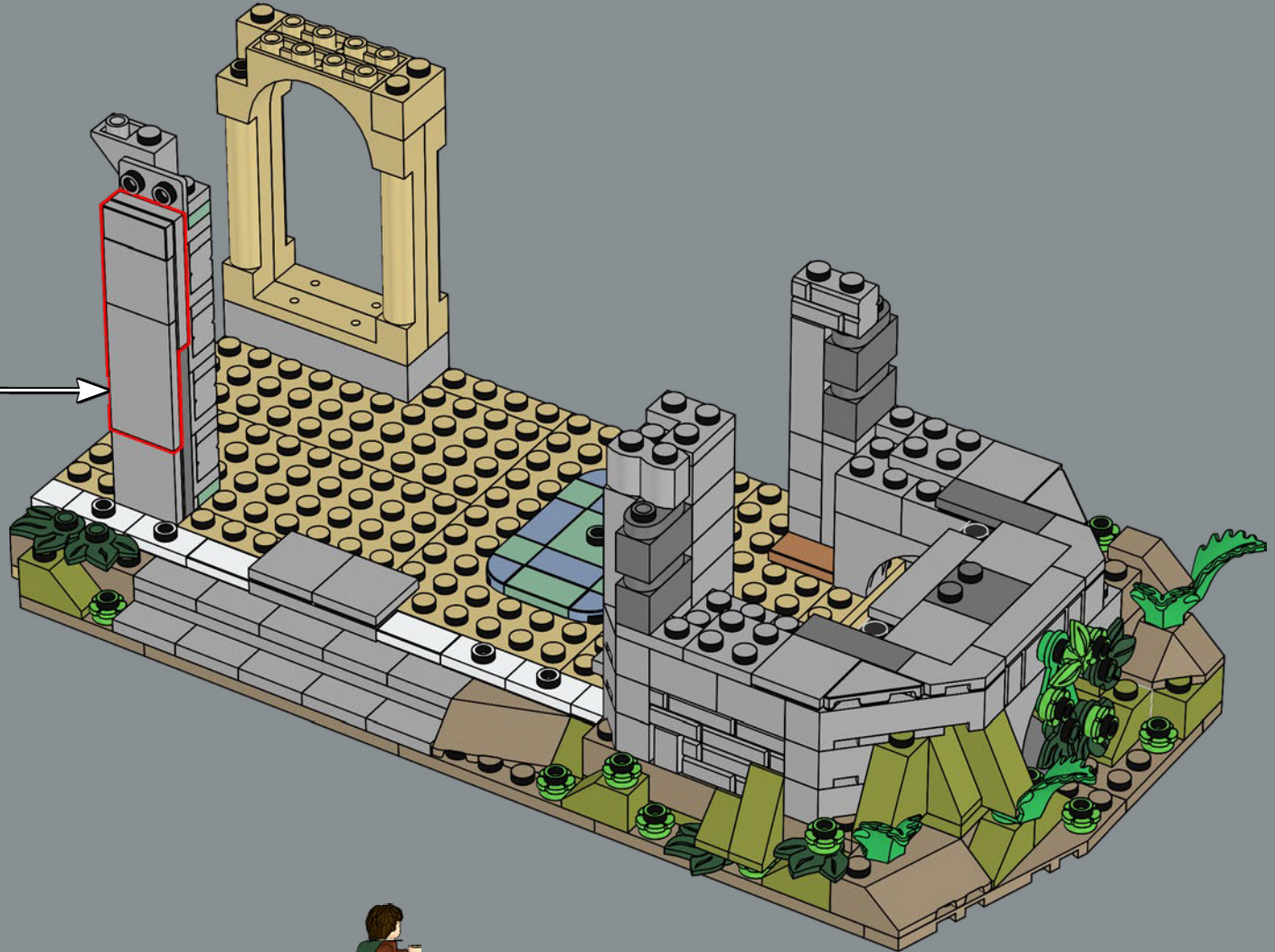
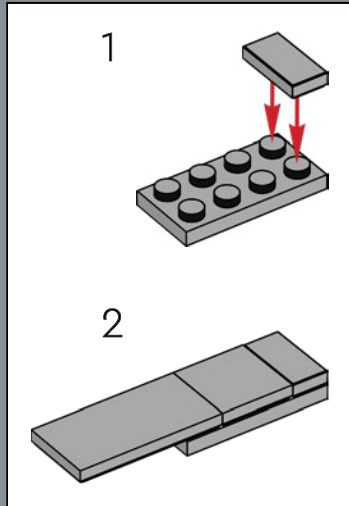

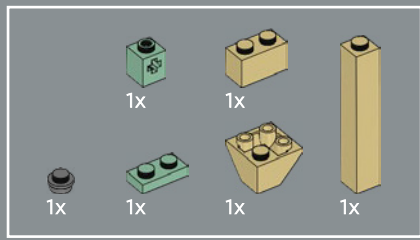

42

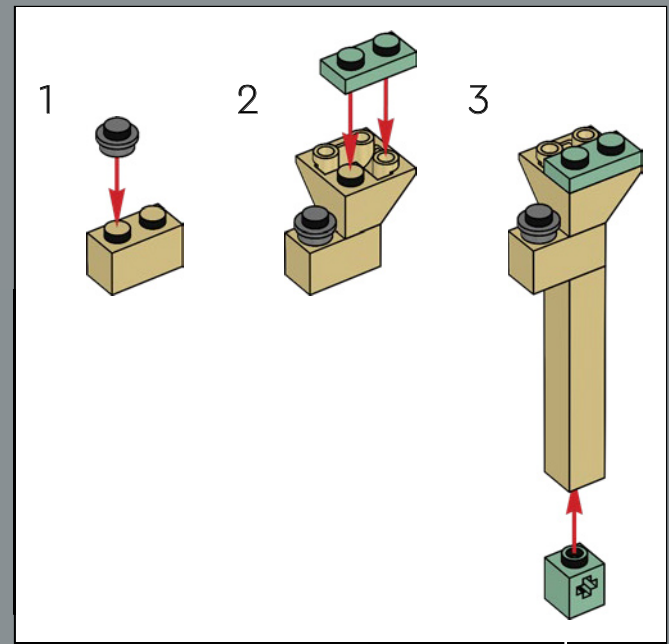
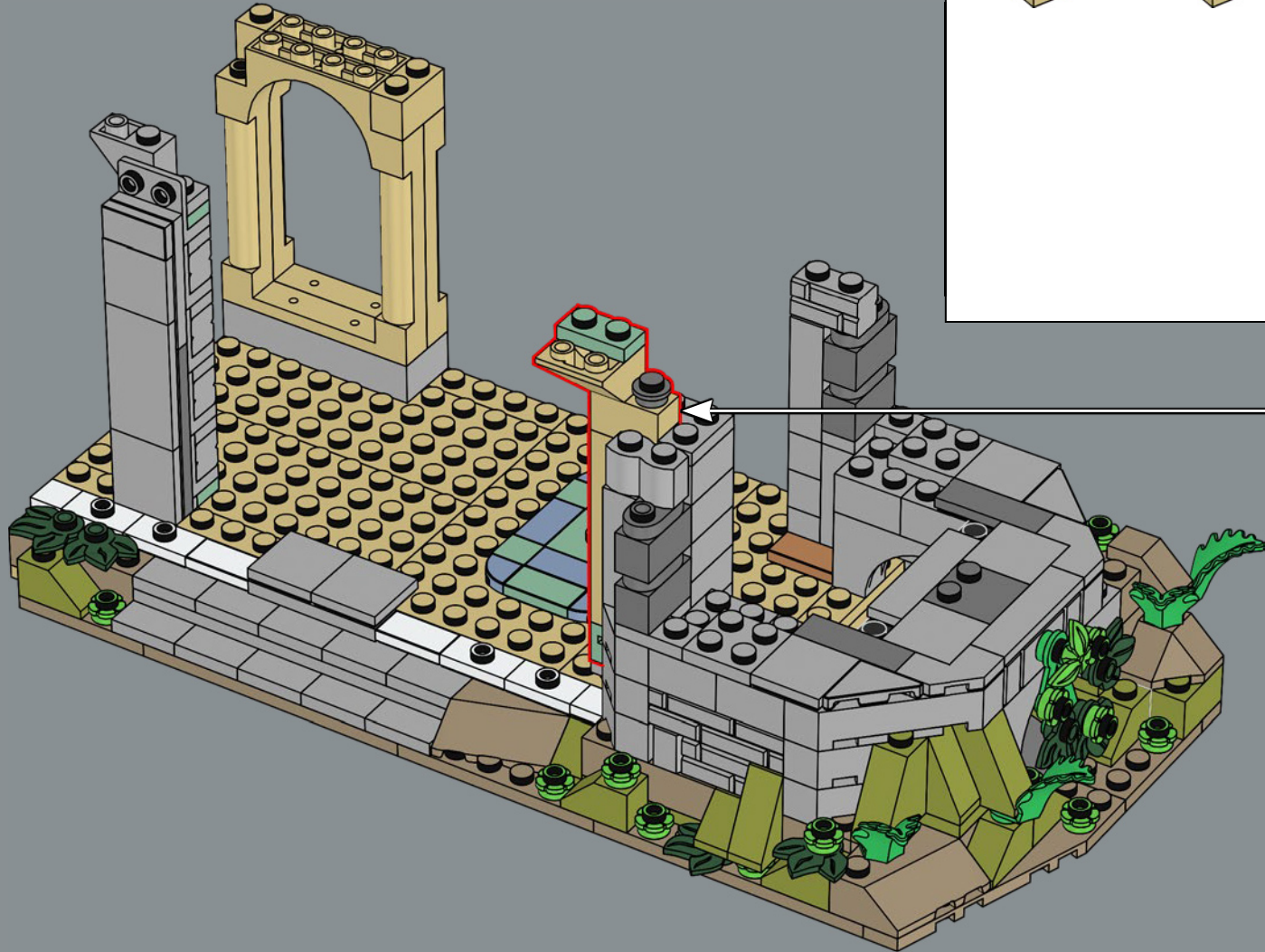

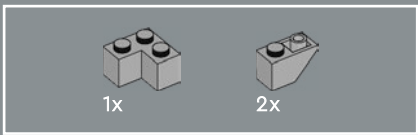

43

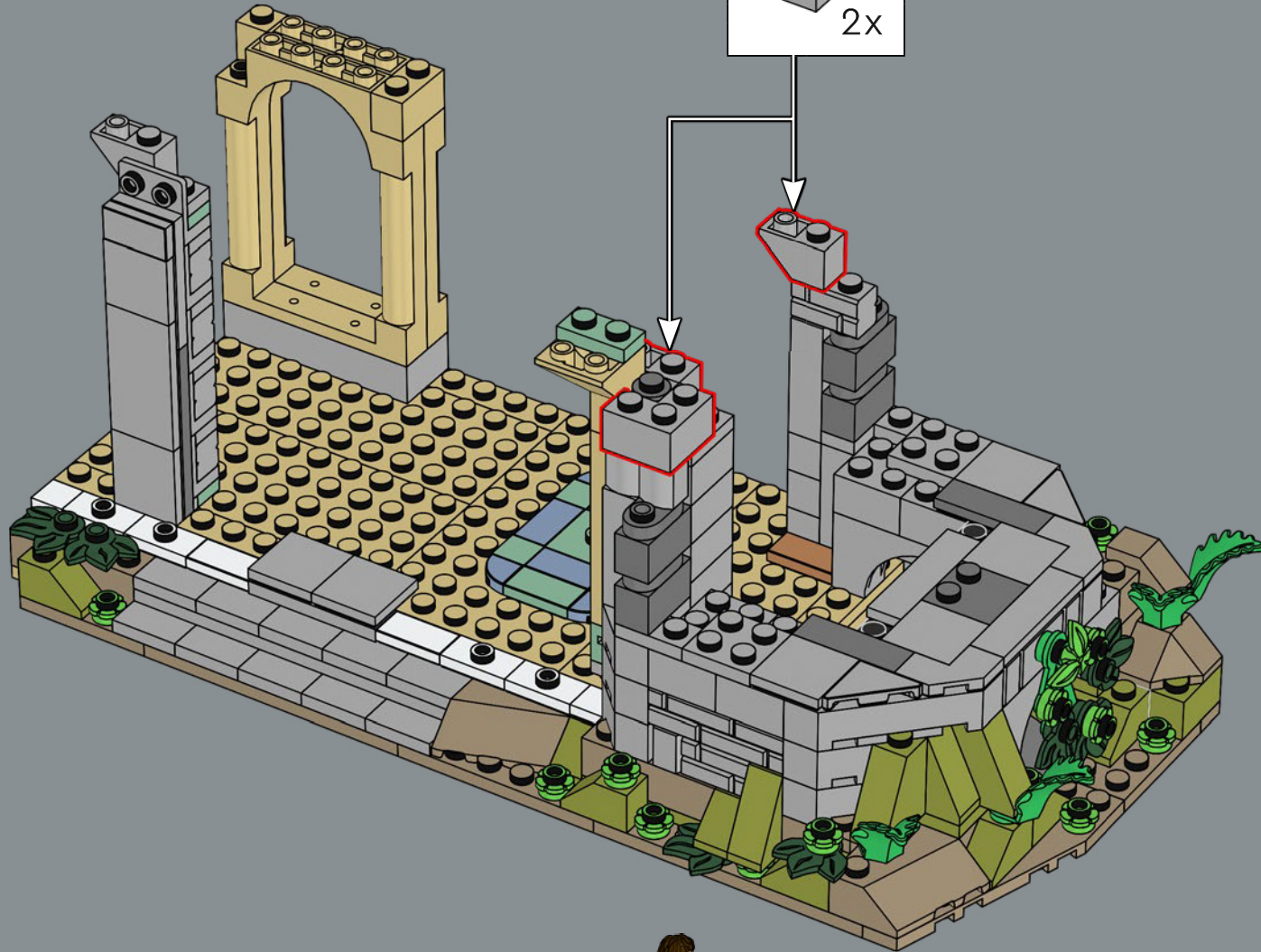
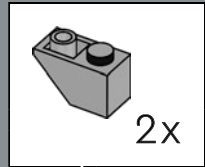

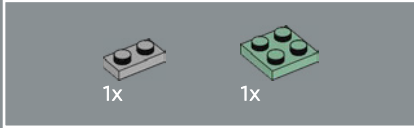
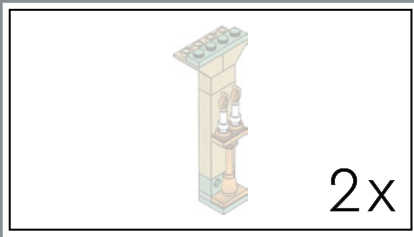

44

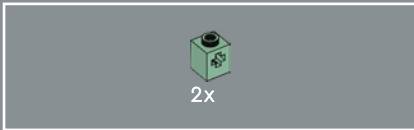
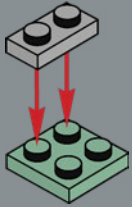

45

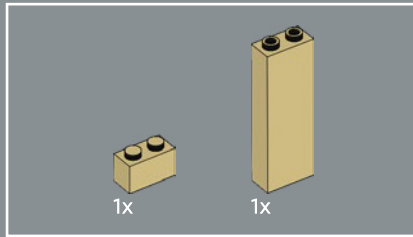
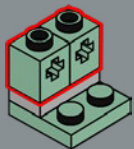

46

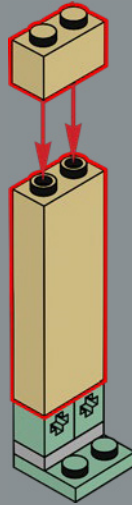

47

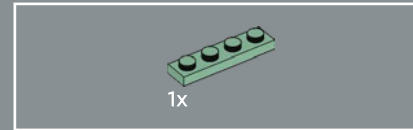
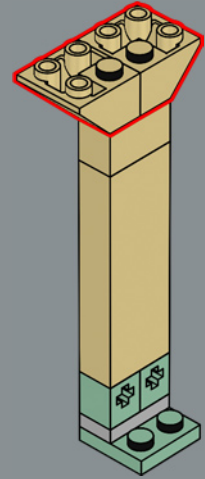

48

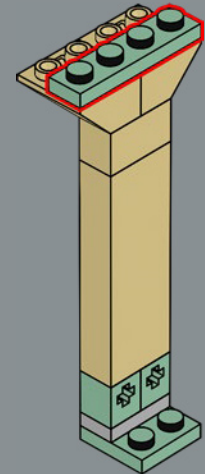

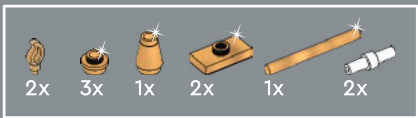

49

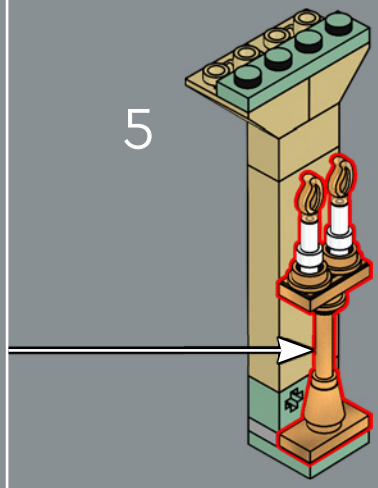
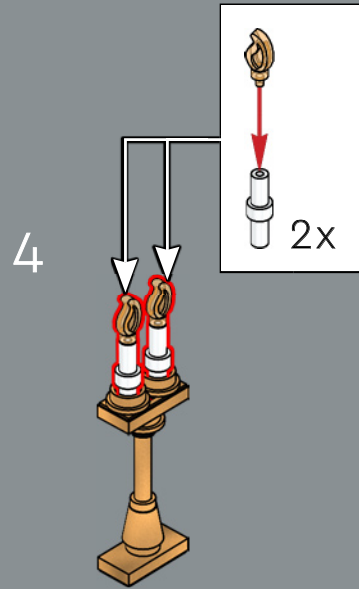
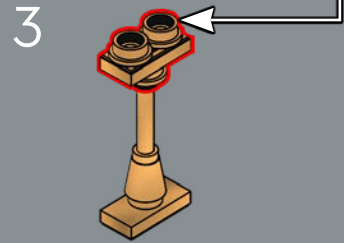
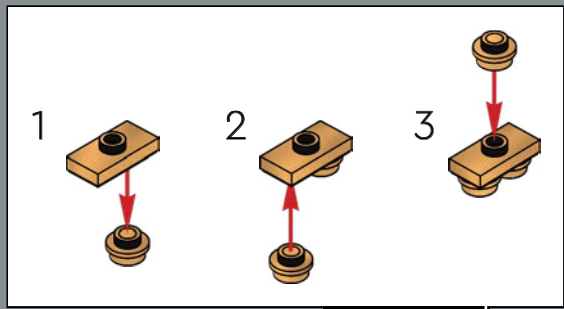
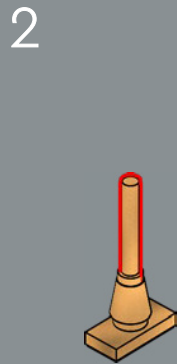
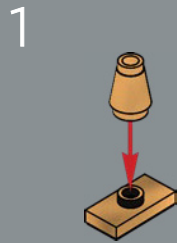

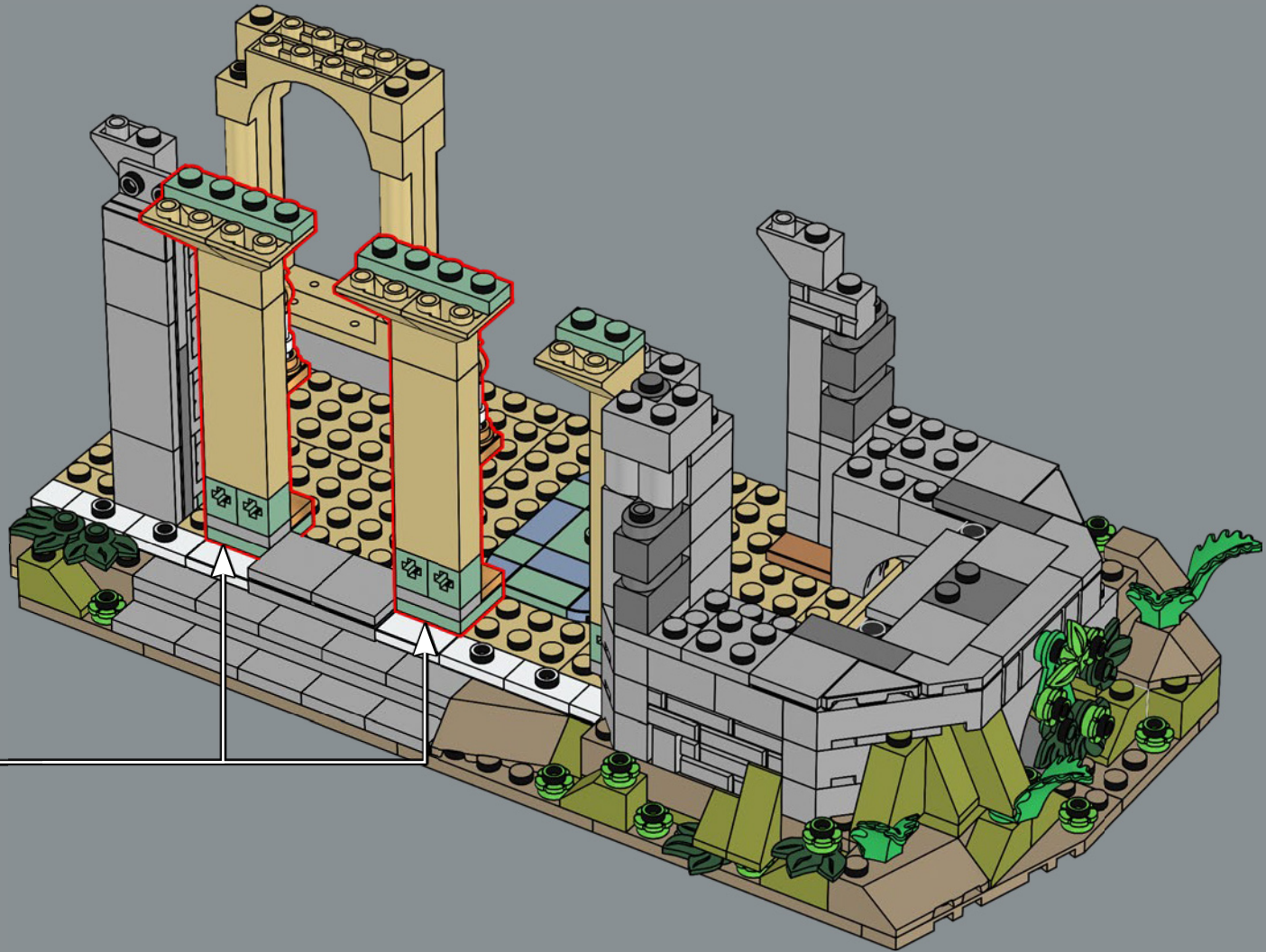

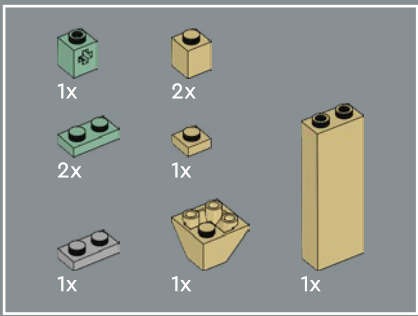

50

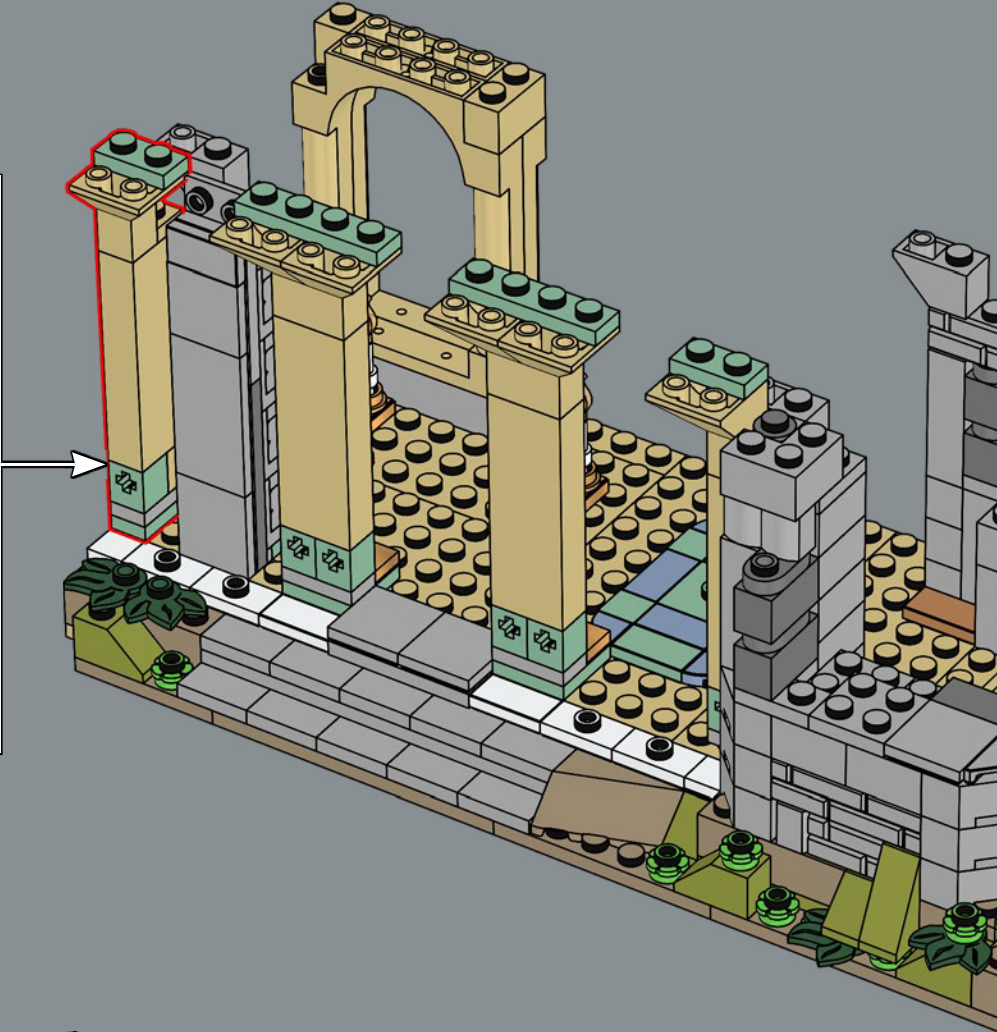
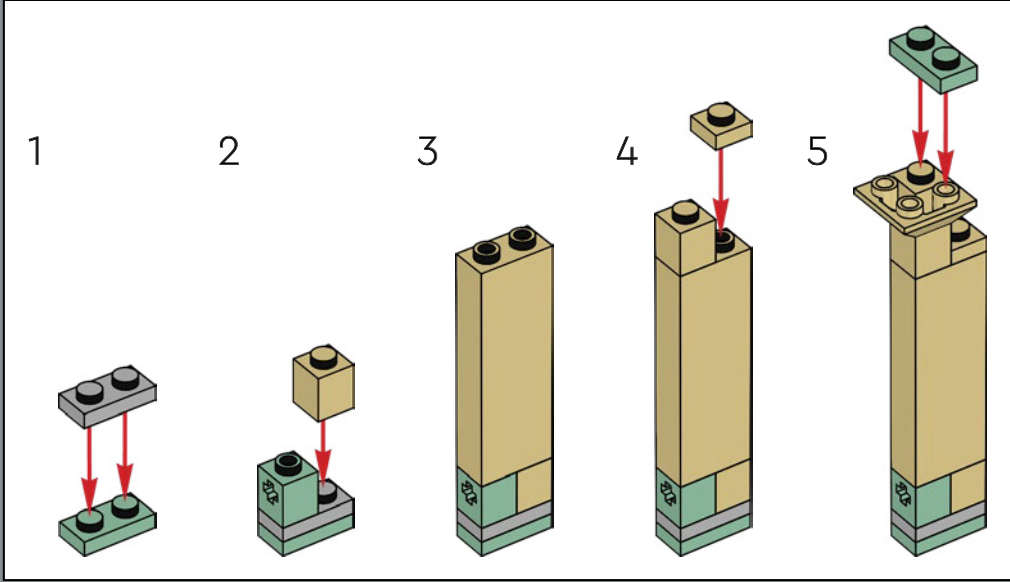

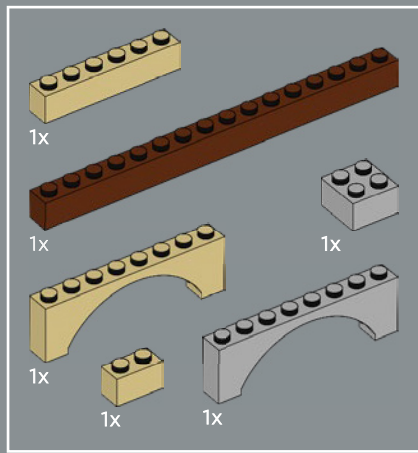

51

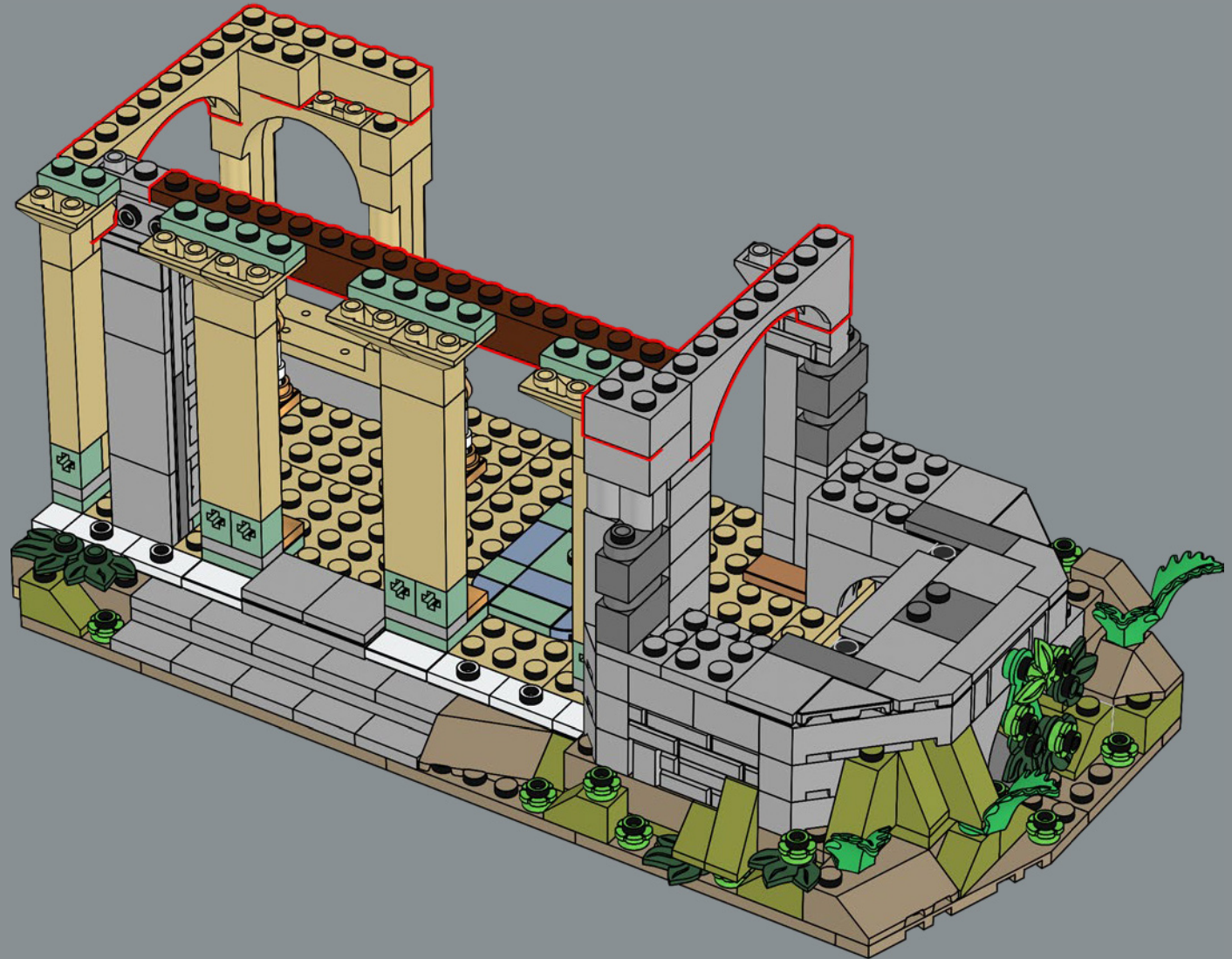

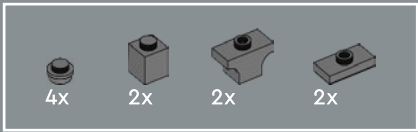

52

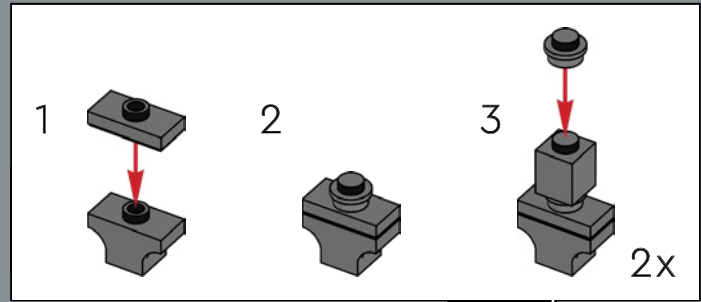
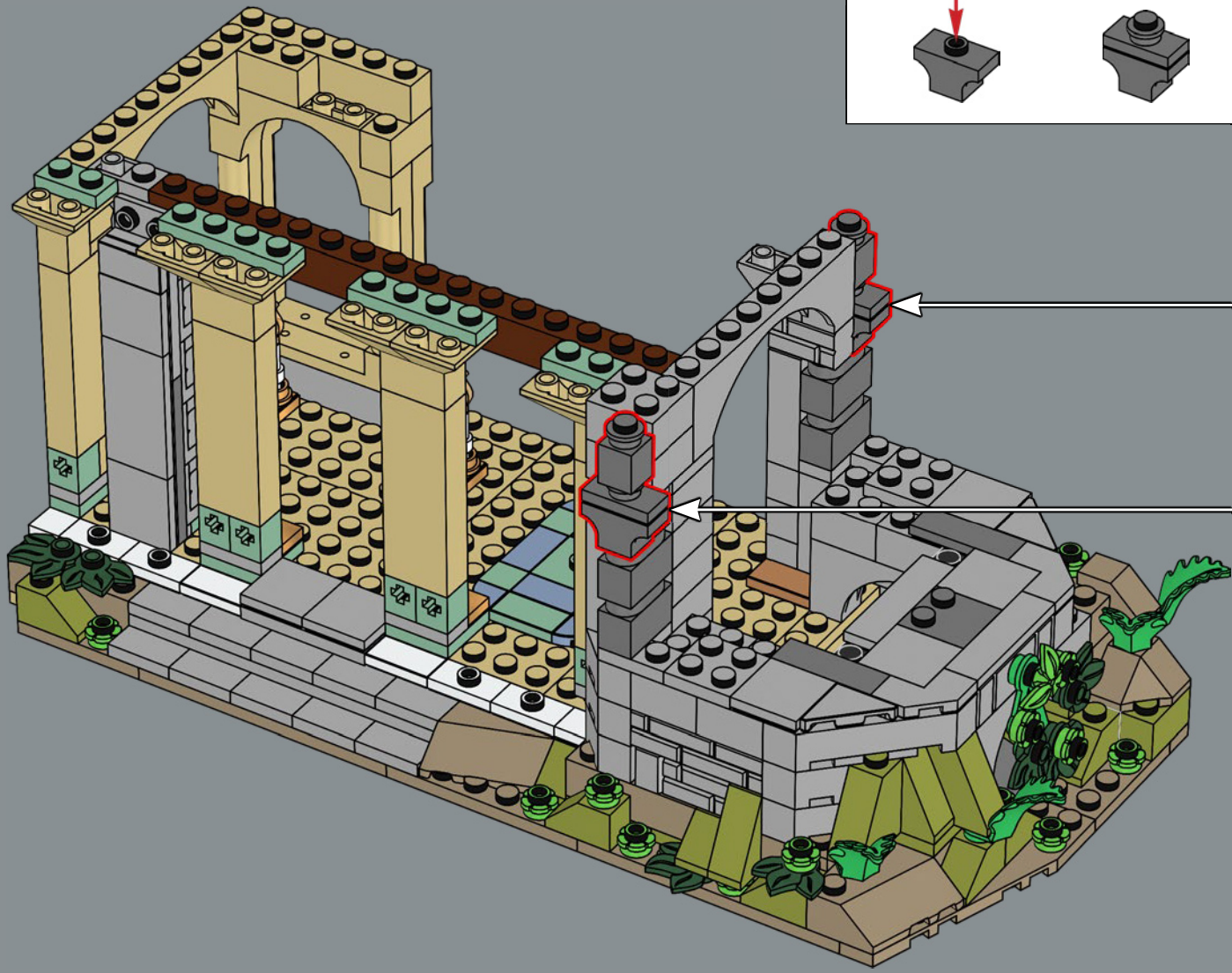

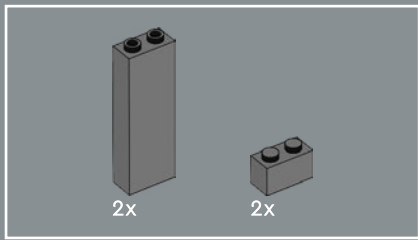

53

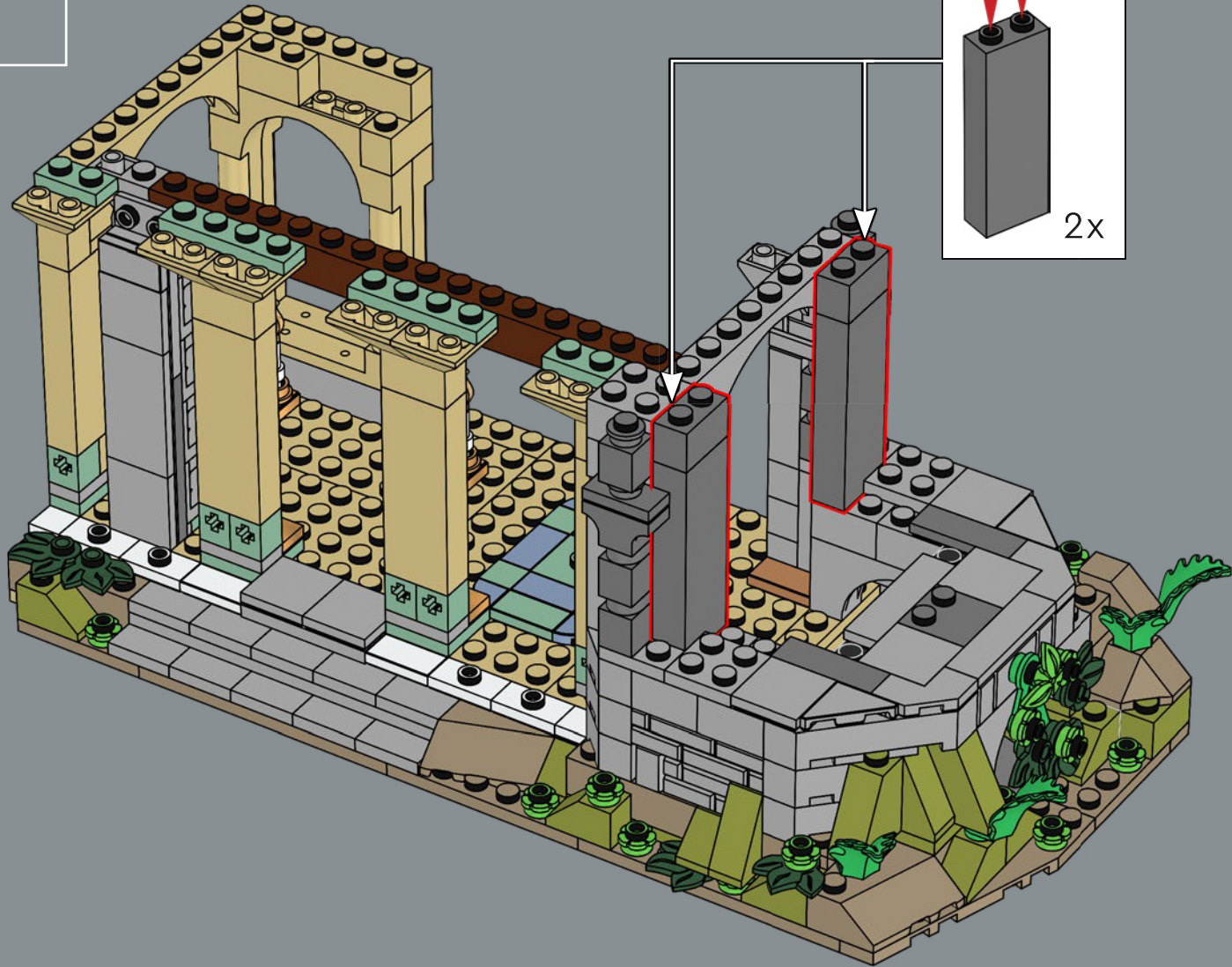



4x

54



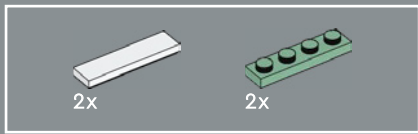

55

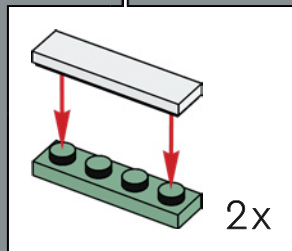
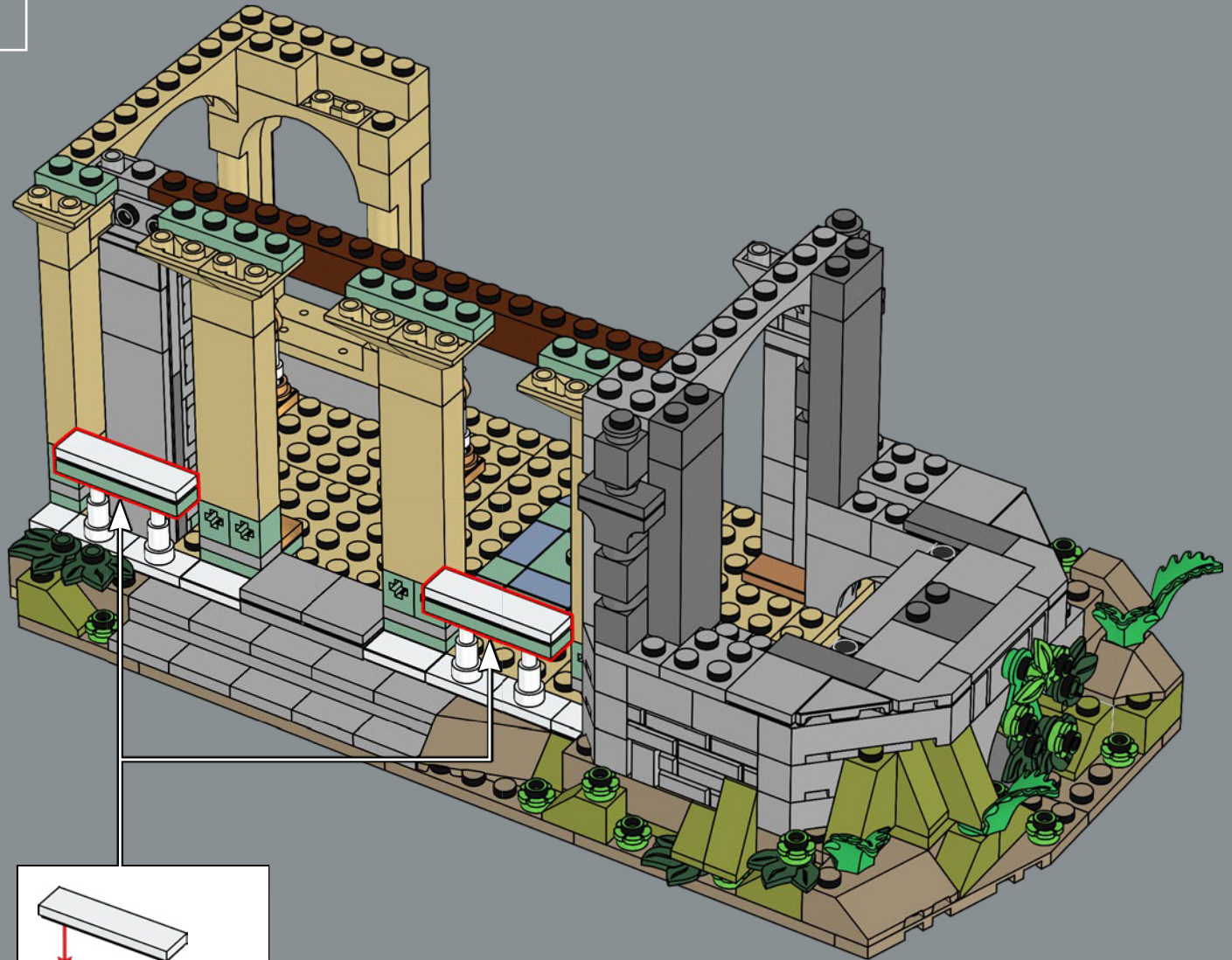

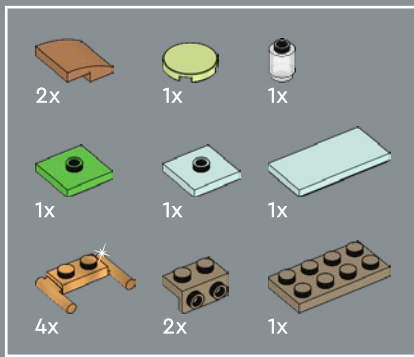

56

1

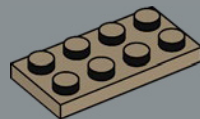

2

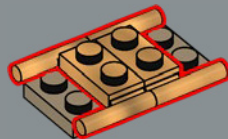

3

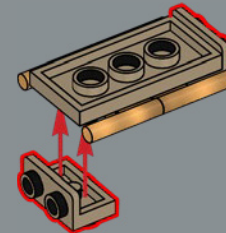

4

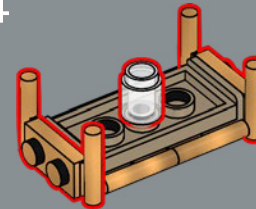

5

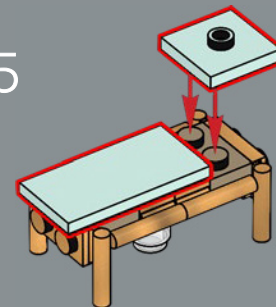

6

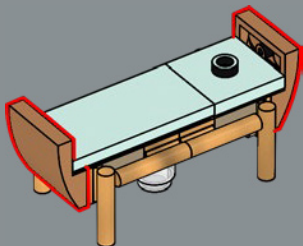

7

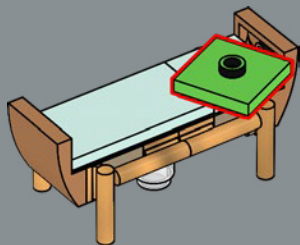

8

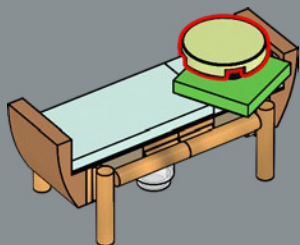

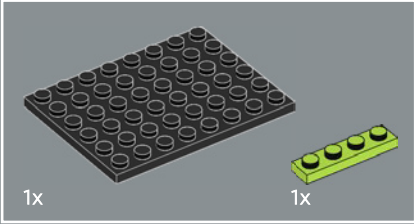
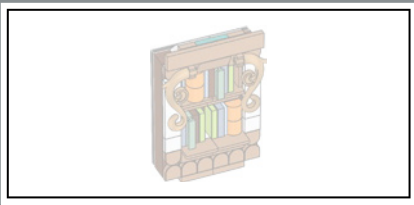

57

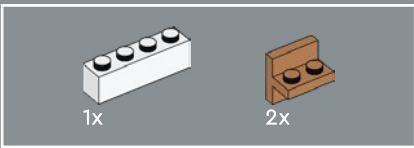
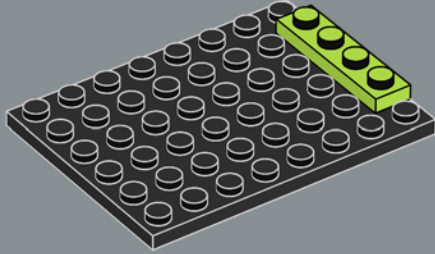

58

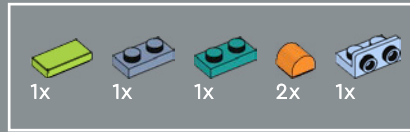
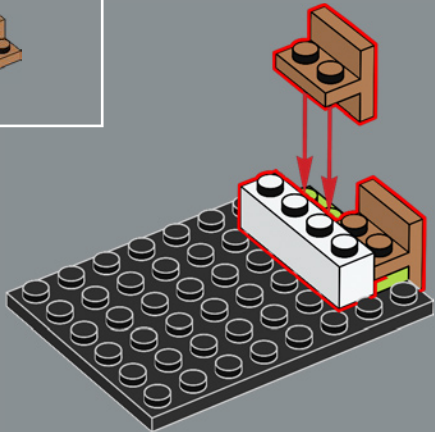

59

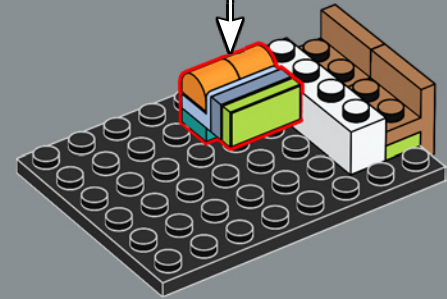
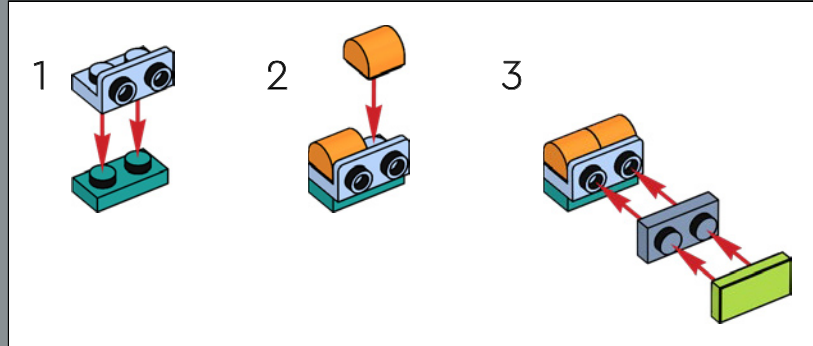

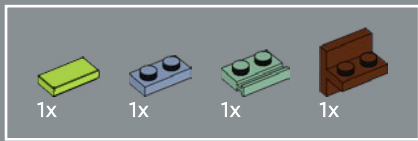

60

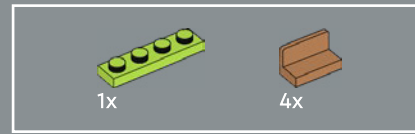
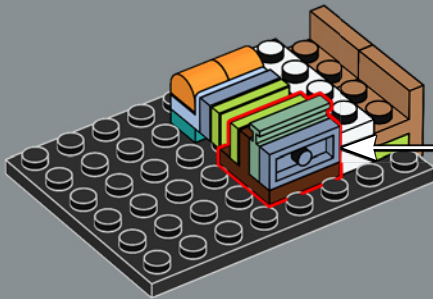
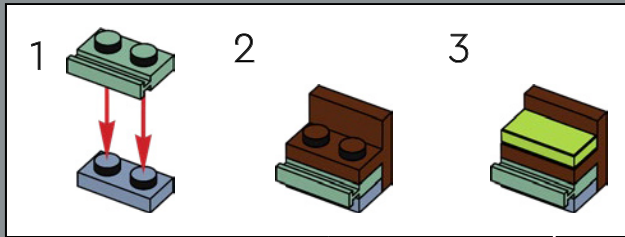

61

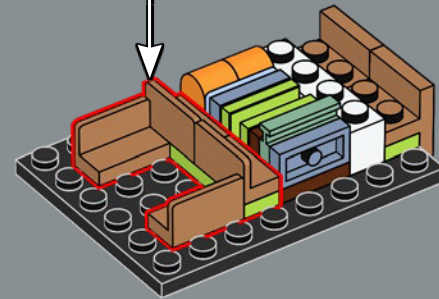
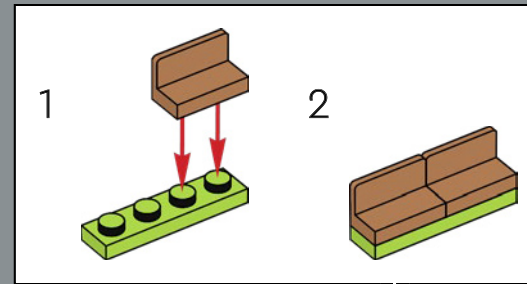

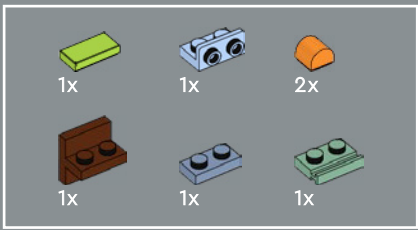

62

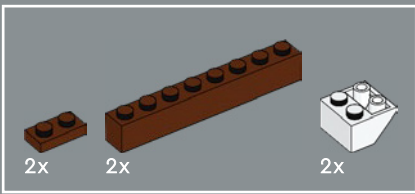
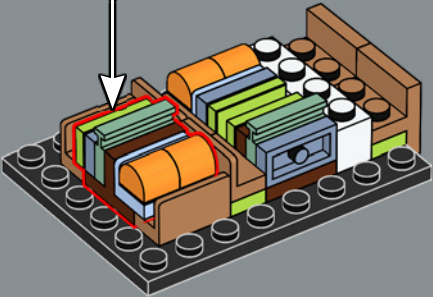
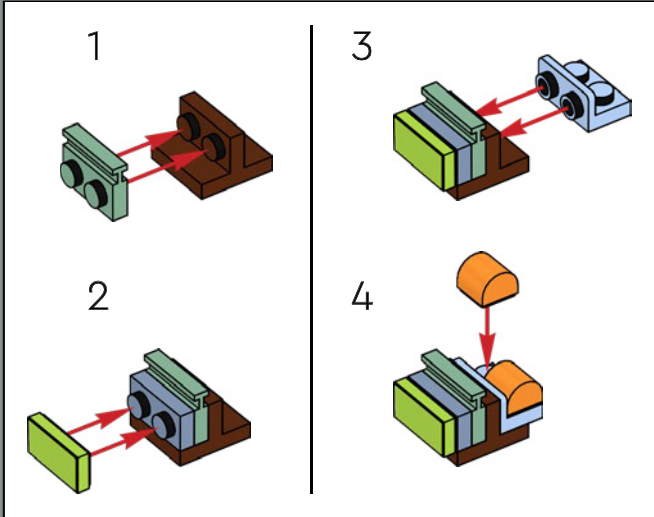

63

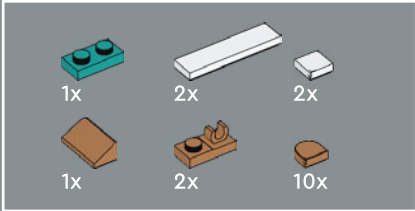
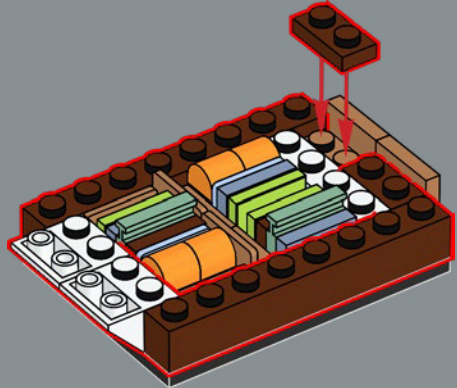

64

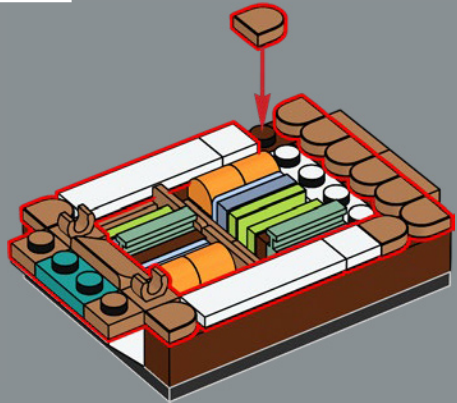

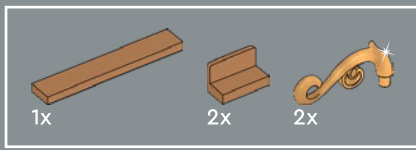

65

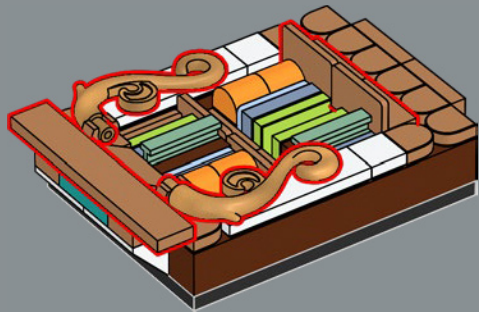

66



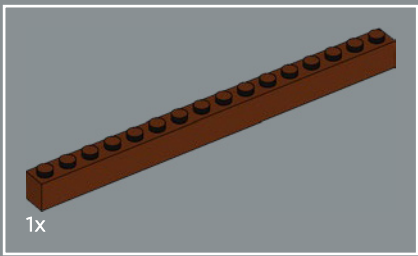

67



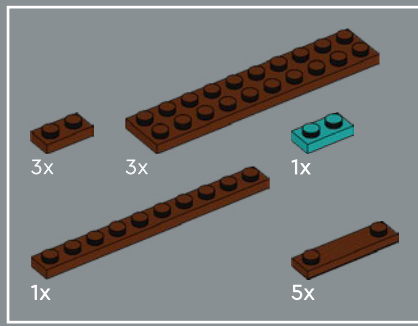

68

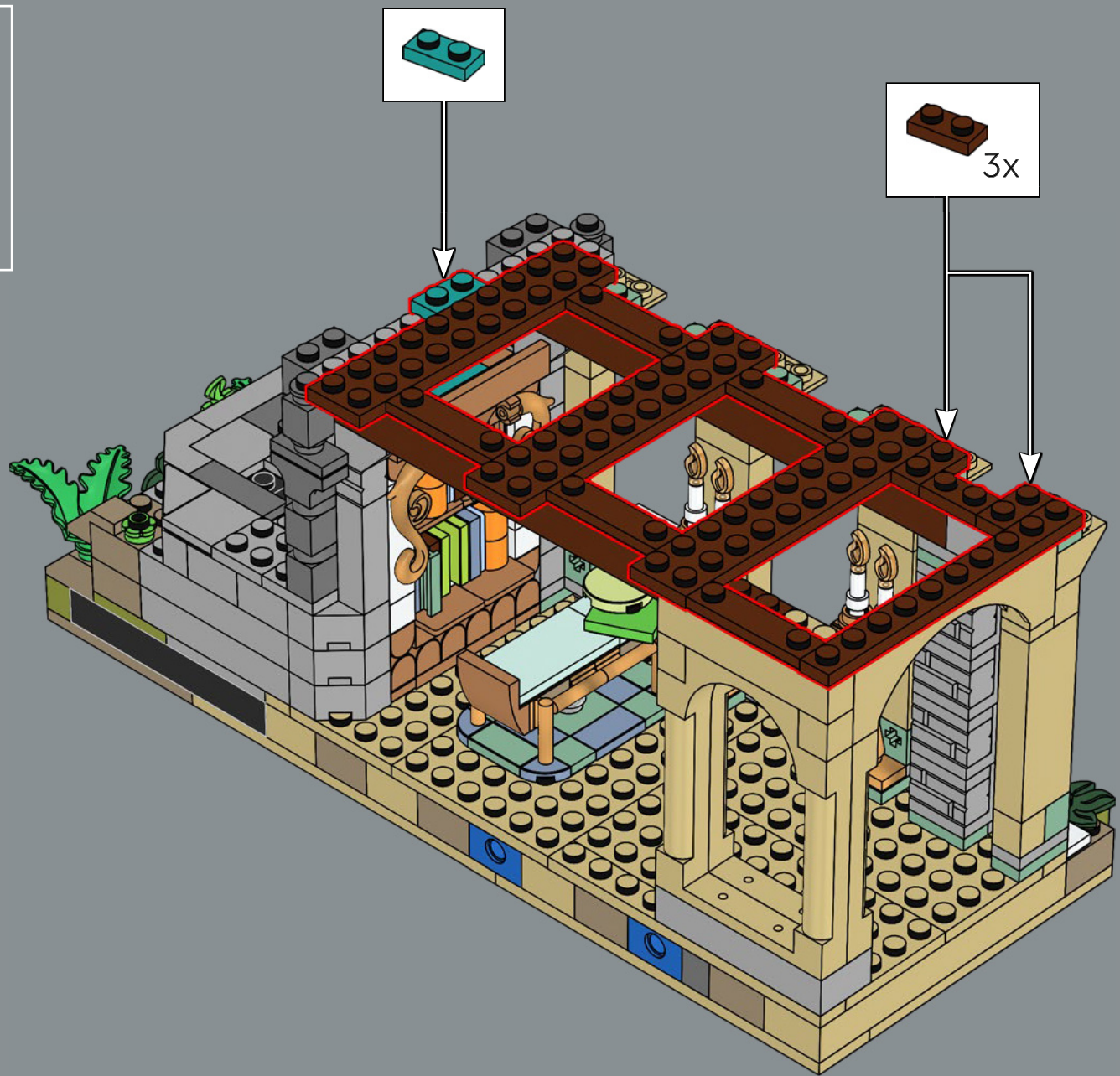

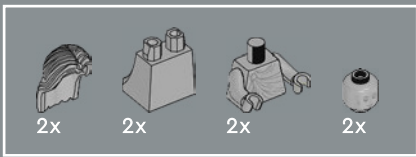

69

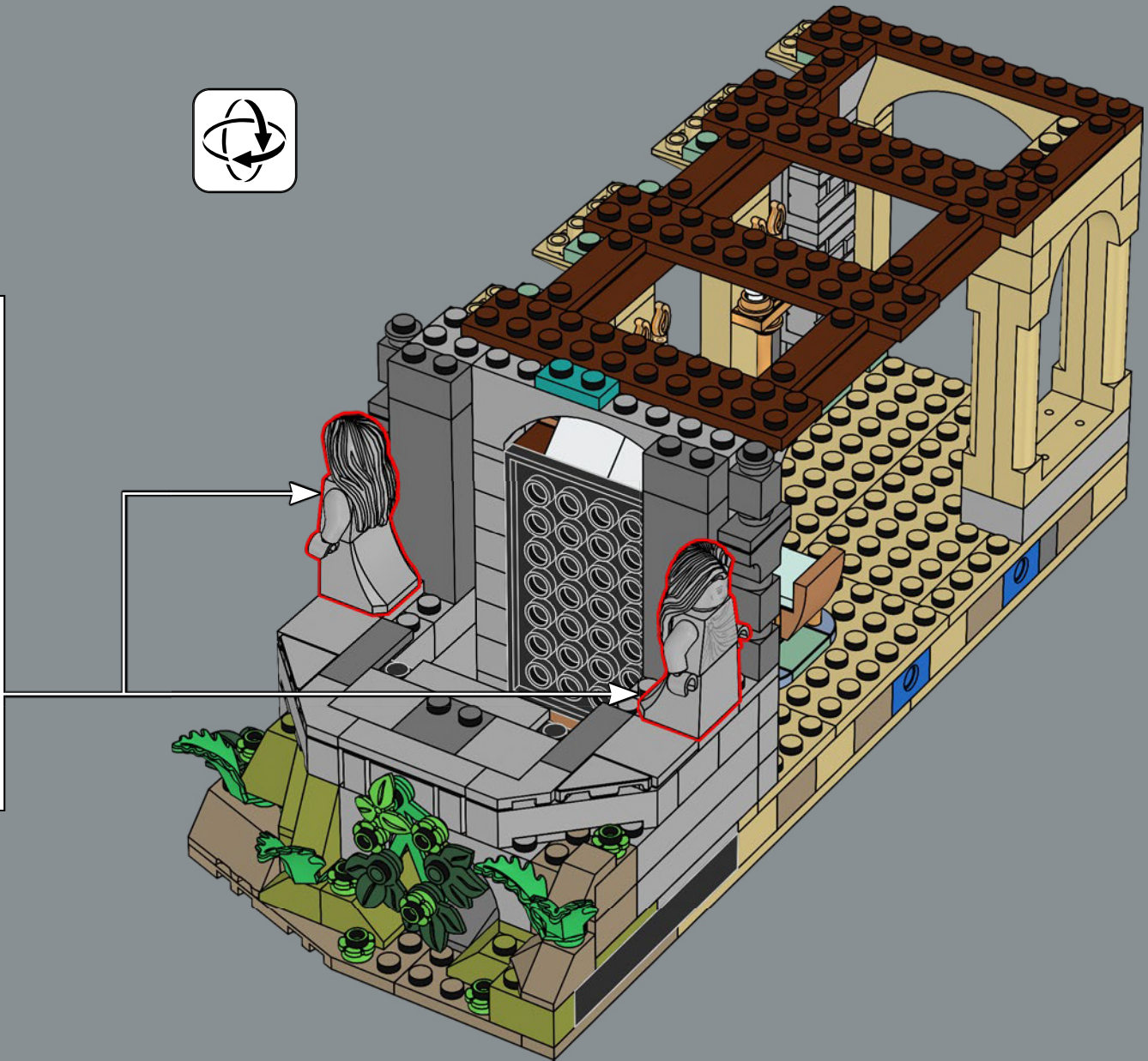
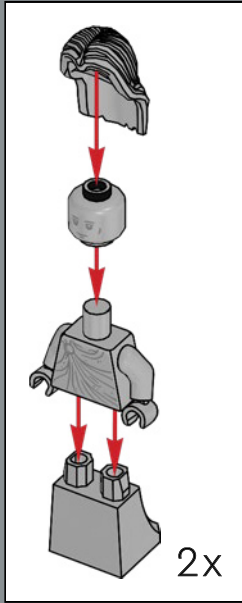

Die Köpfe der Statuen haben zwei markante neue Gesichtsausdrücke und zeigen sich entweder mit steinerner Miene oder mit steinhartem Blick!





70

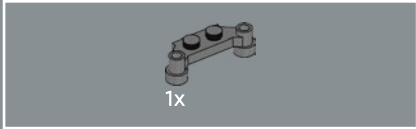
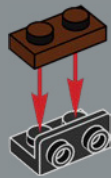

71

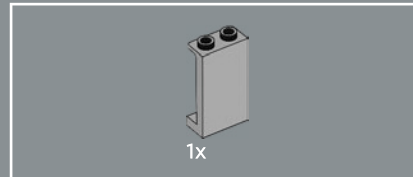
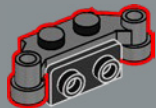

72

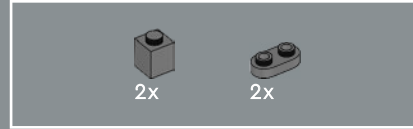
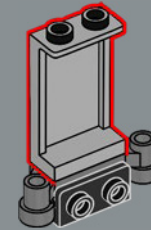

73

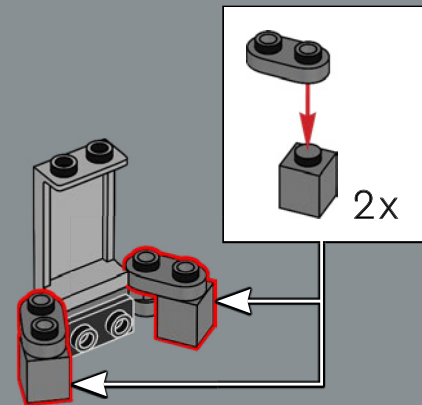



2x

74

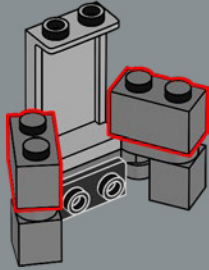

2x

75

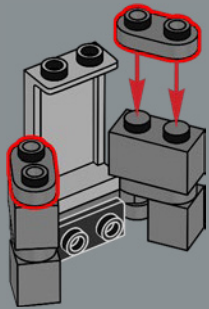

2x



2x

76

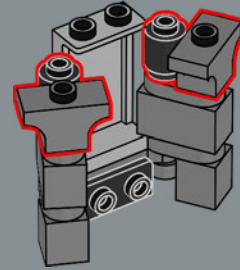

1x

77

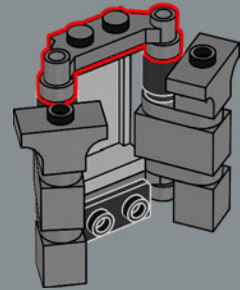

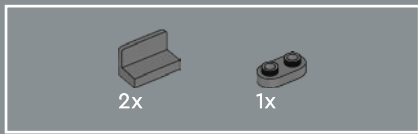

78

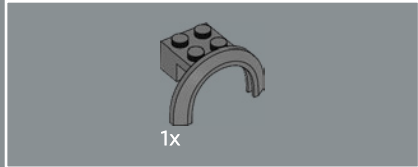
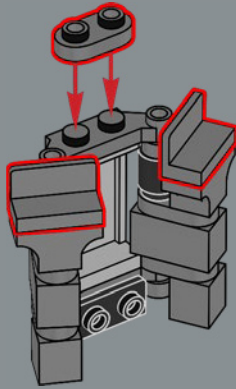

79

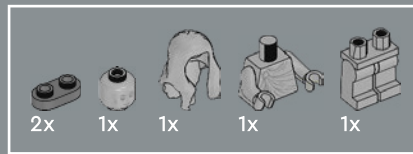
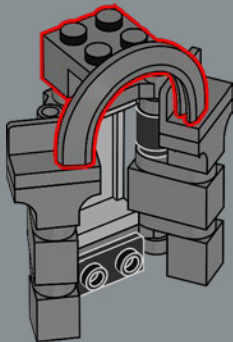

80

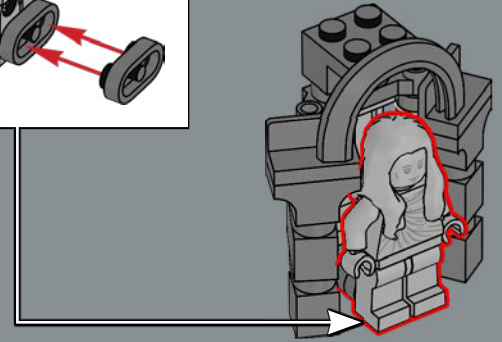
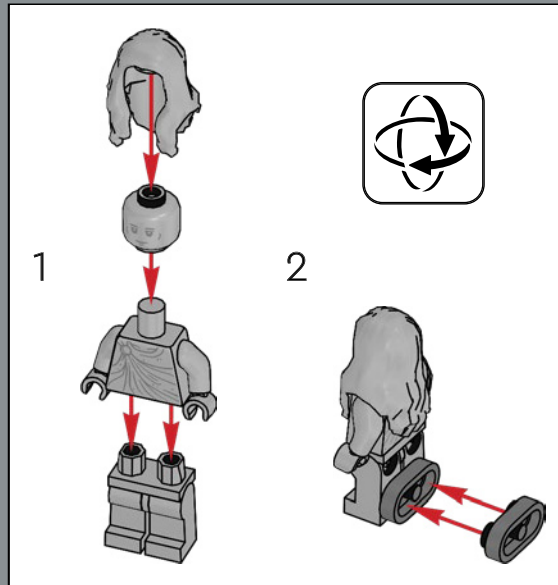



1x

81

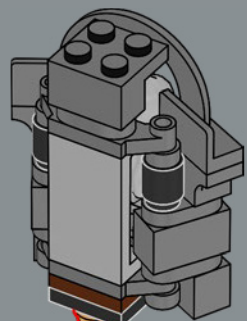

2x



82

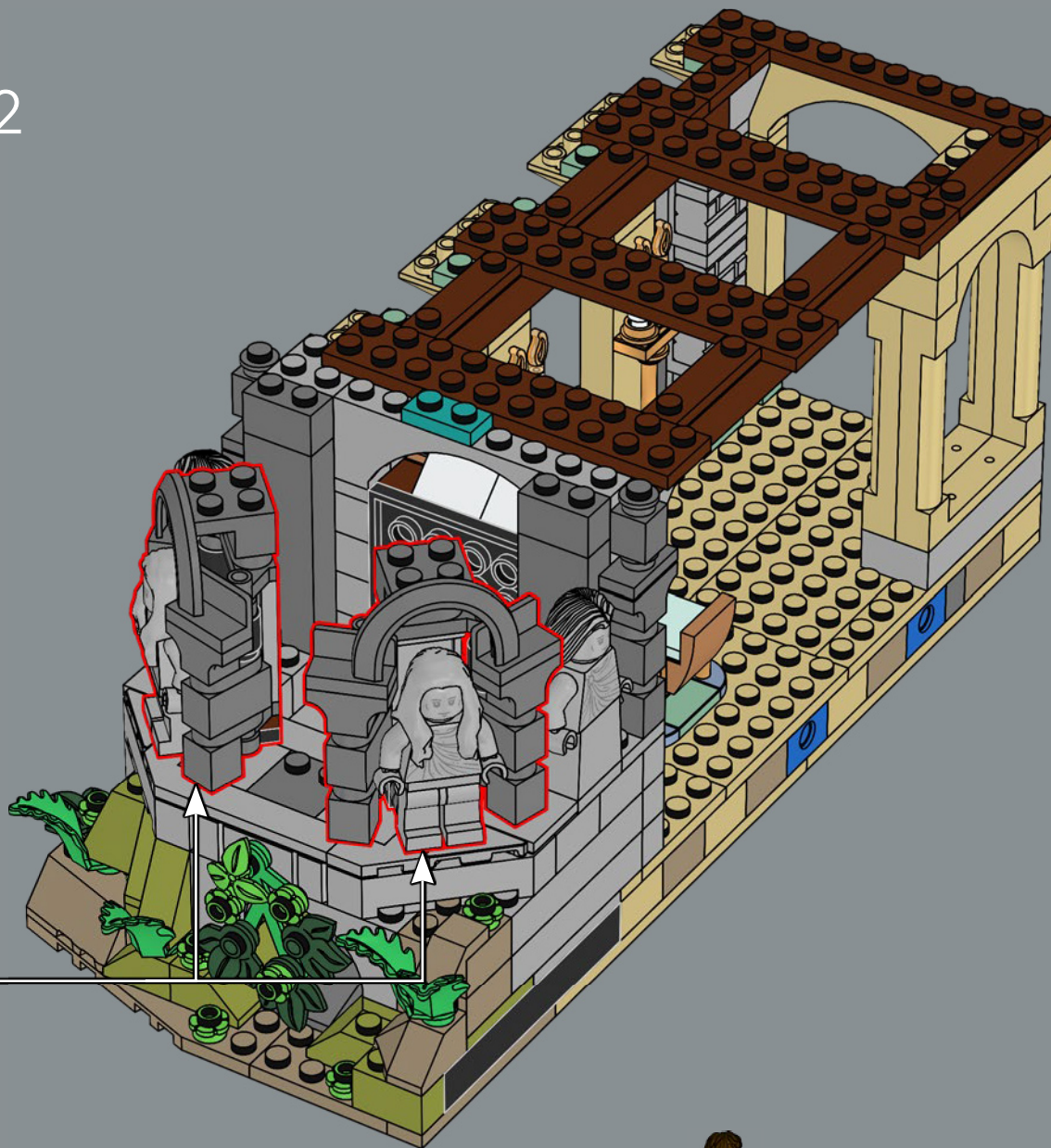

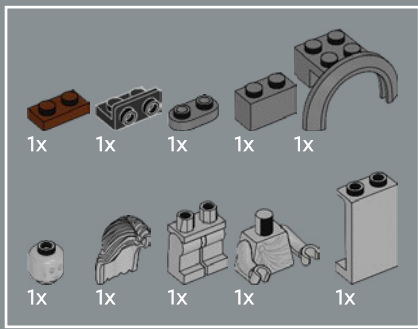

83

1

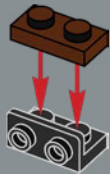

2

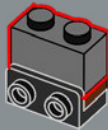

3

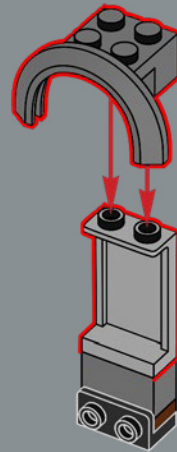

4

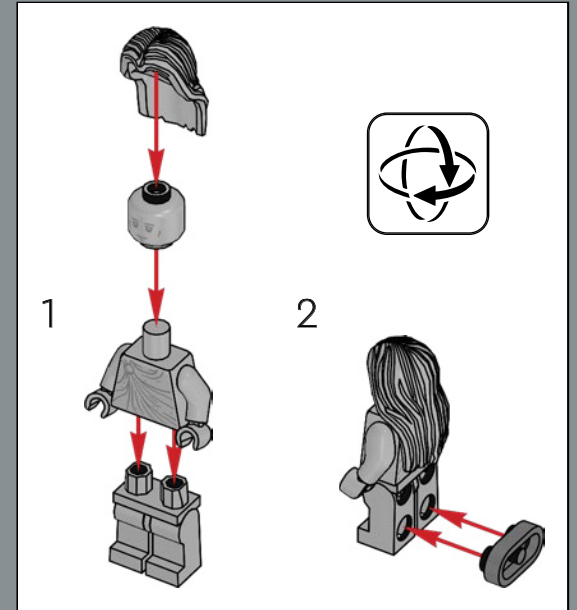

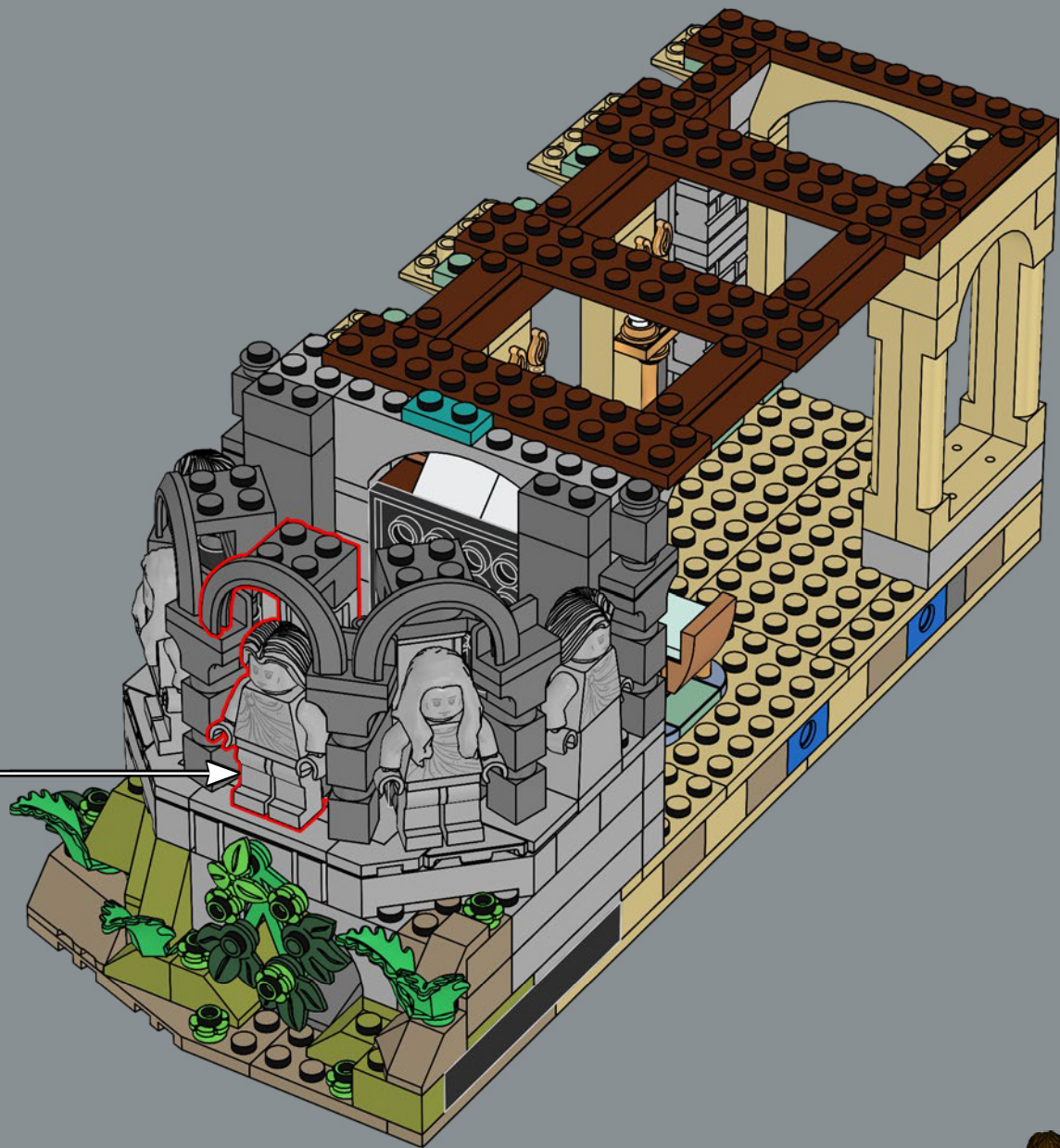

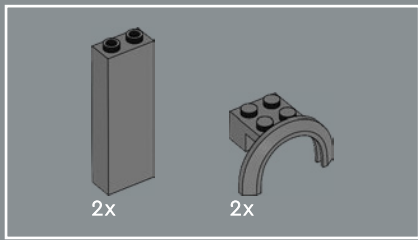

84

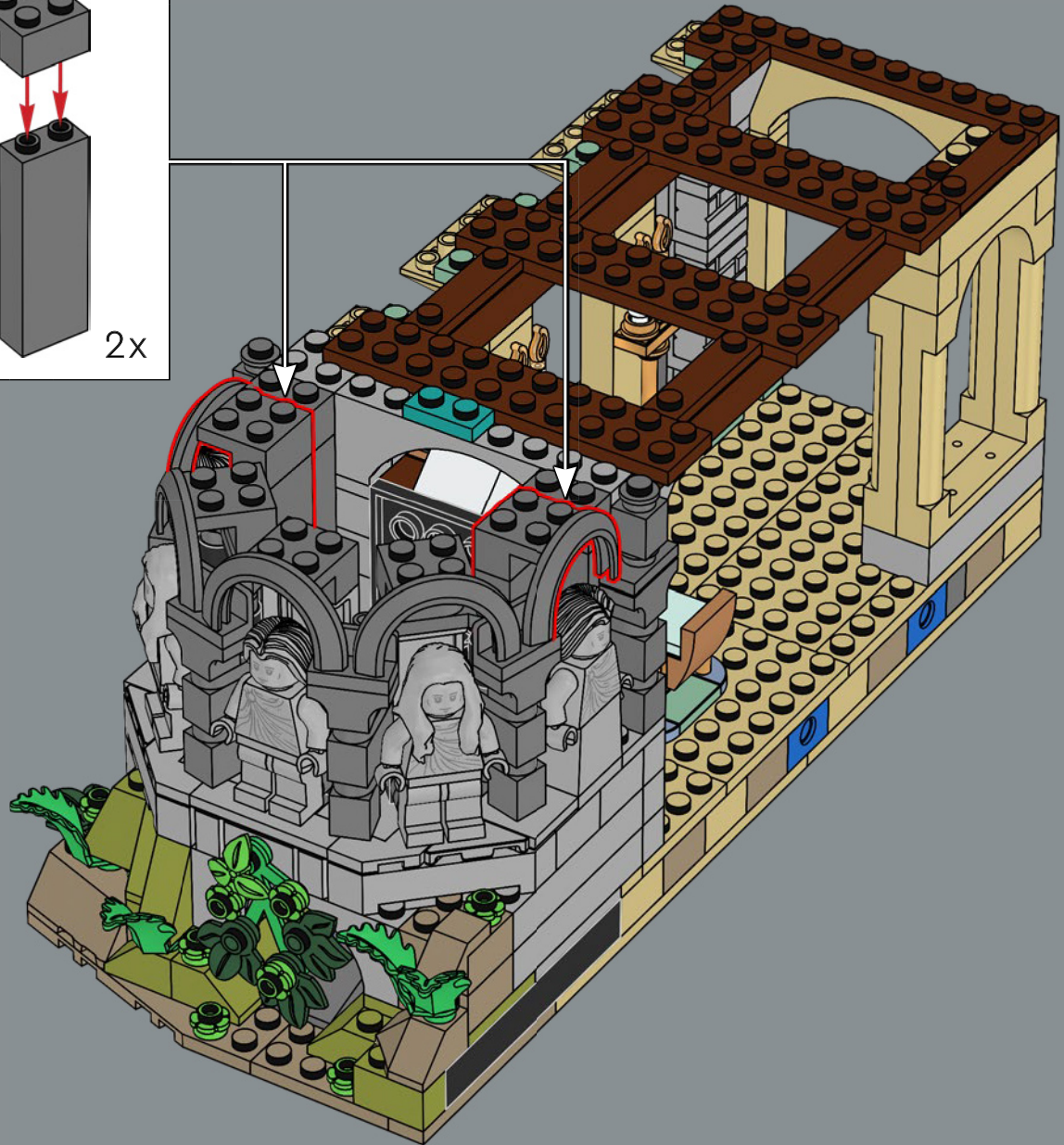
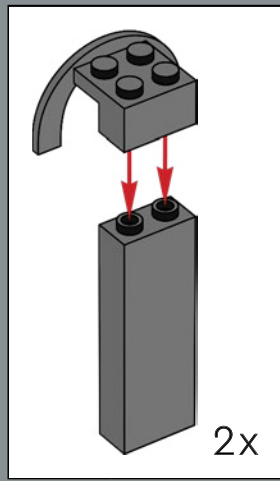

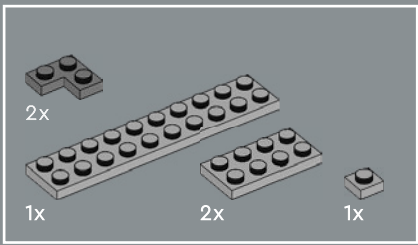

85

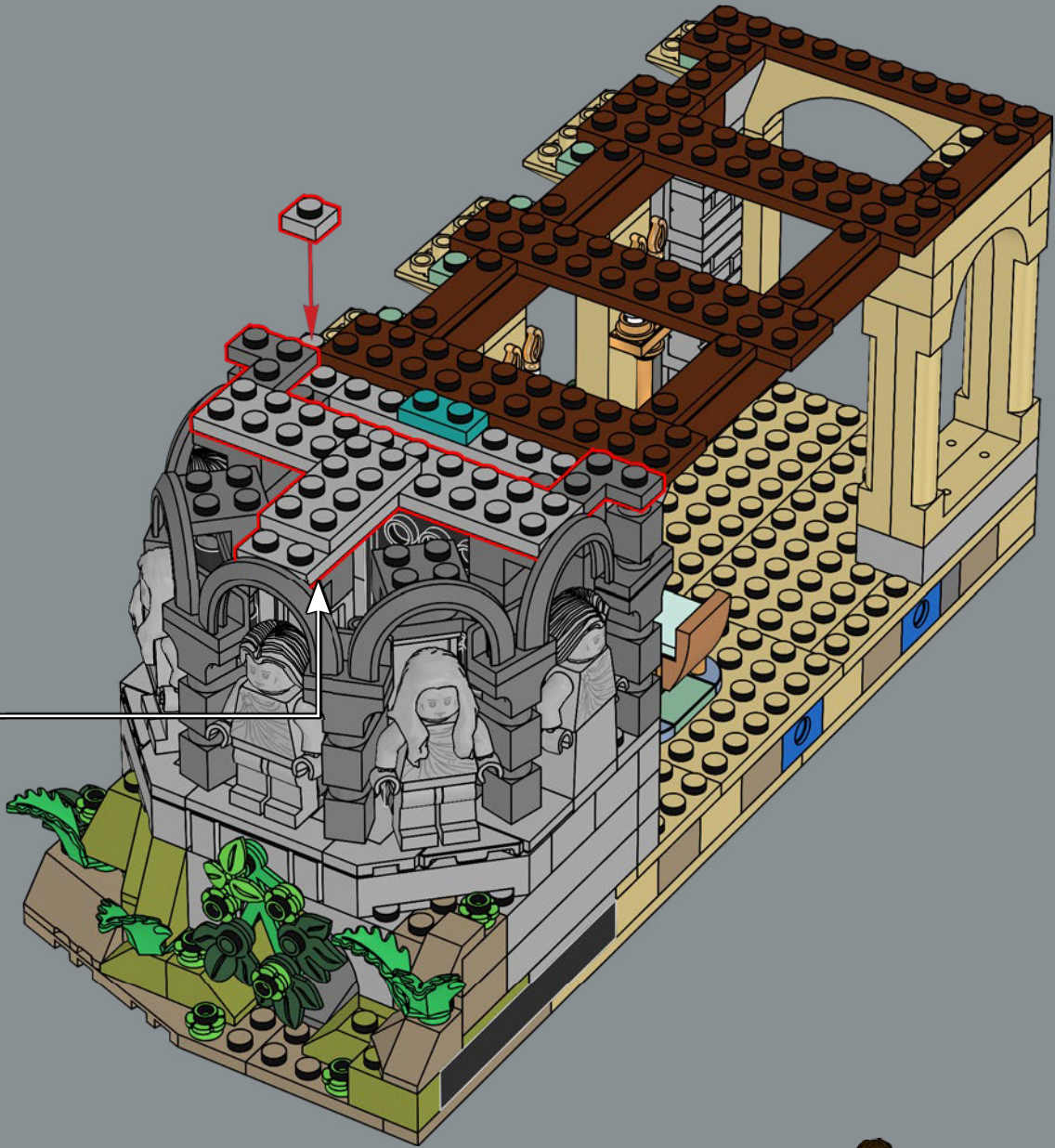
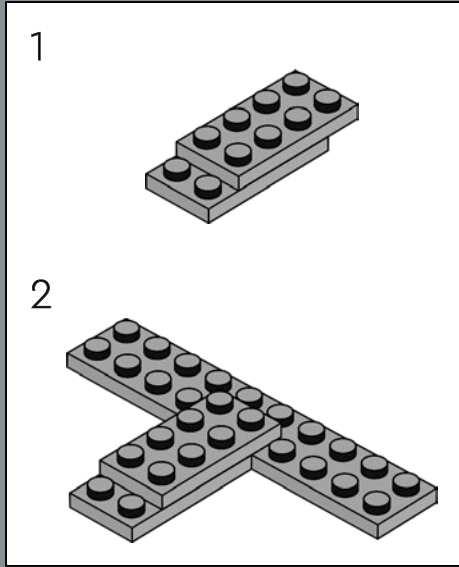

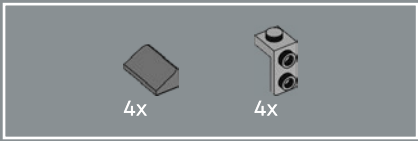

86

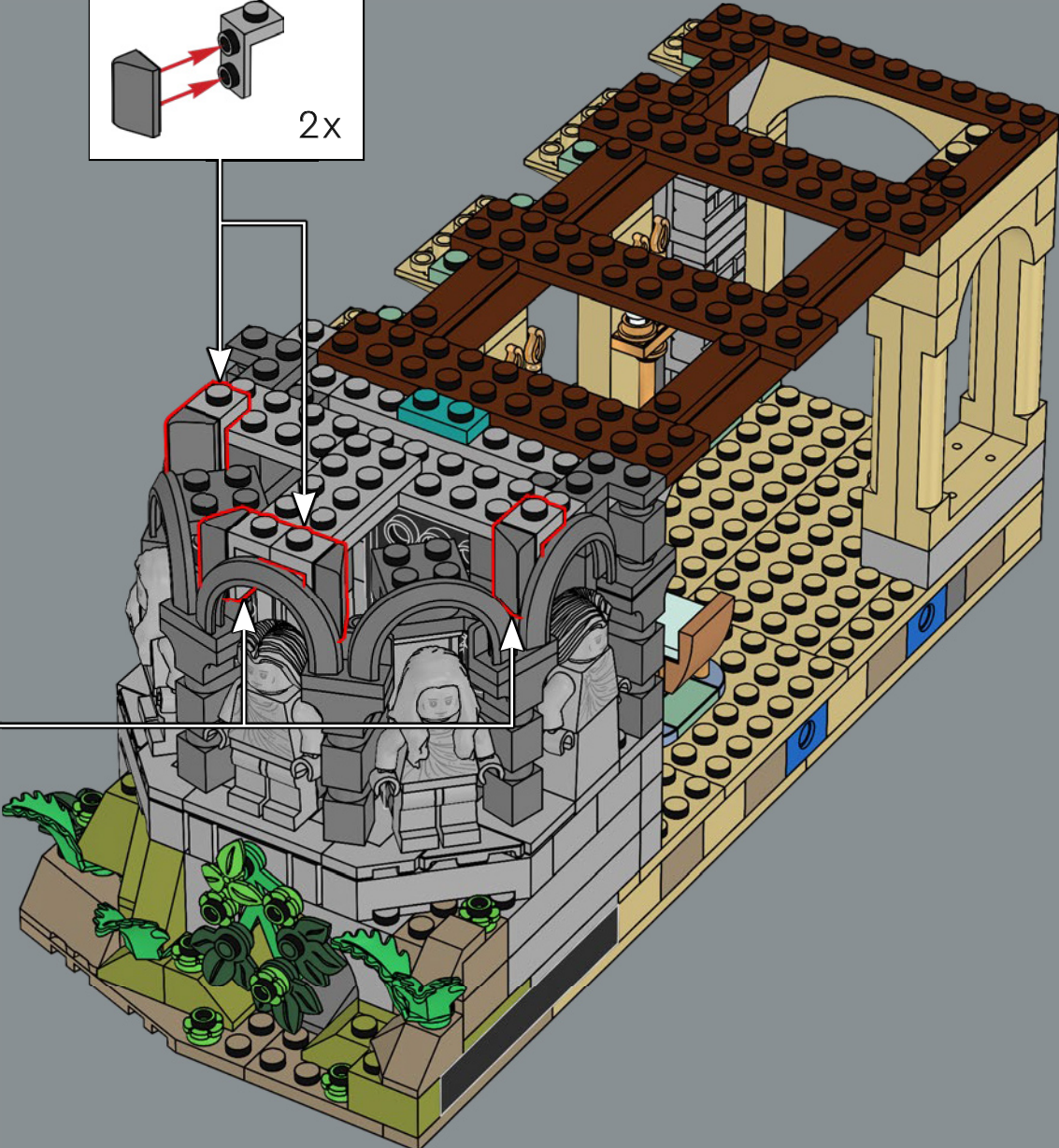
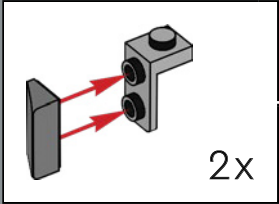
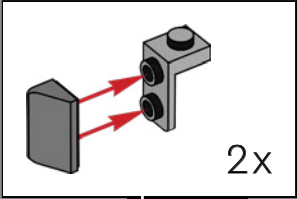

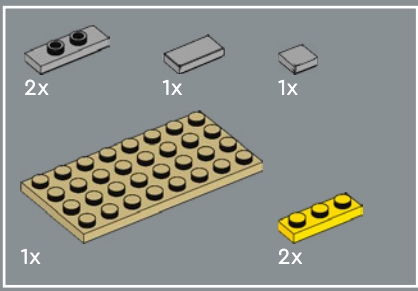

87



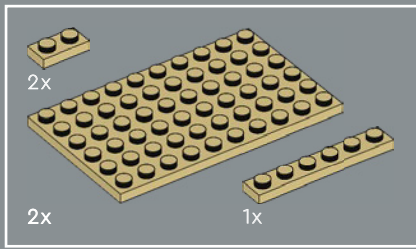

88



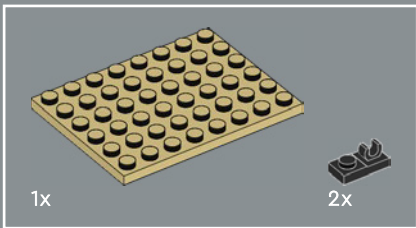
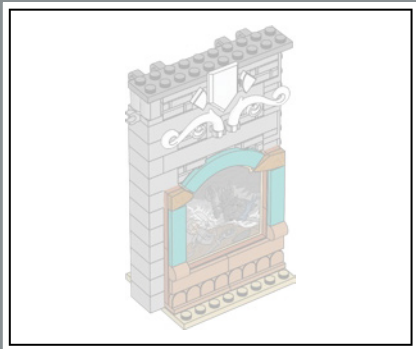

89

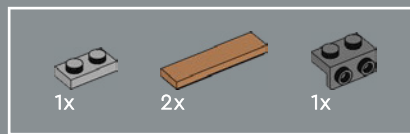
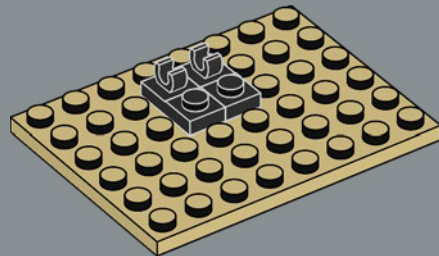

90

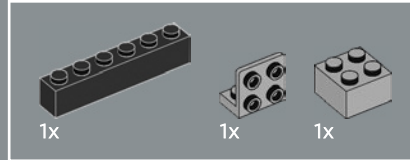
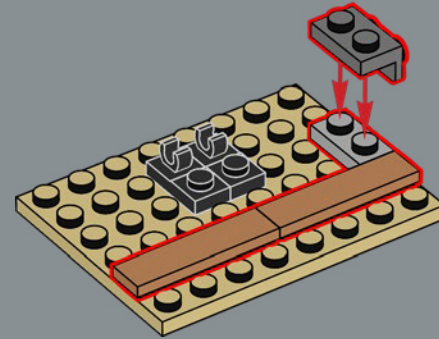

91

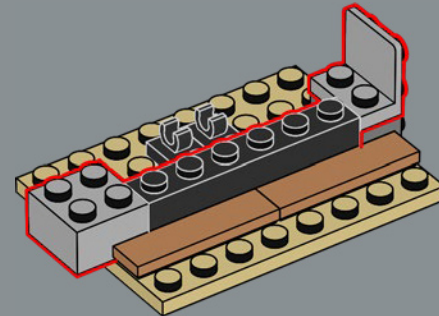

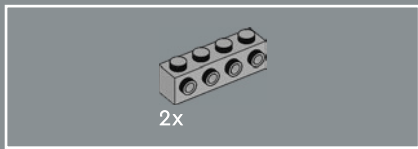

92

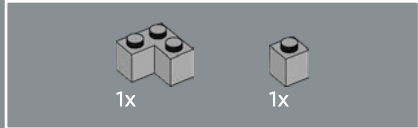
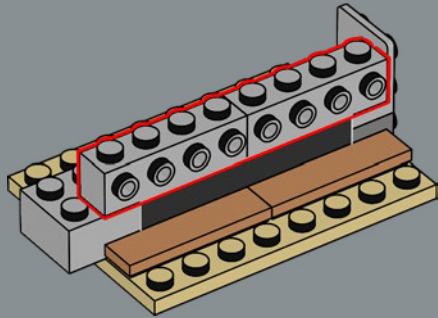

93

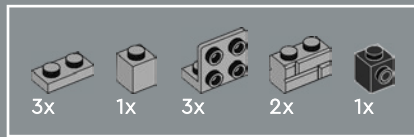
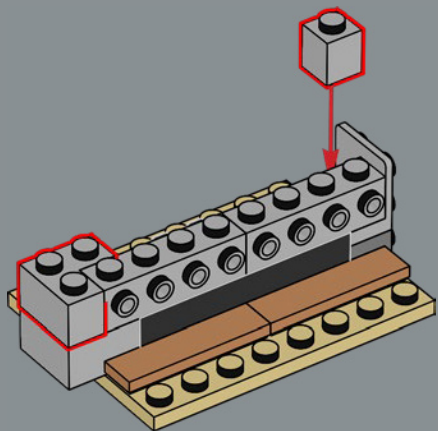

94

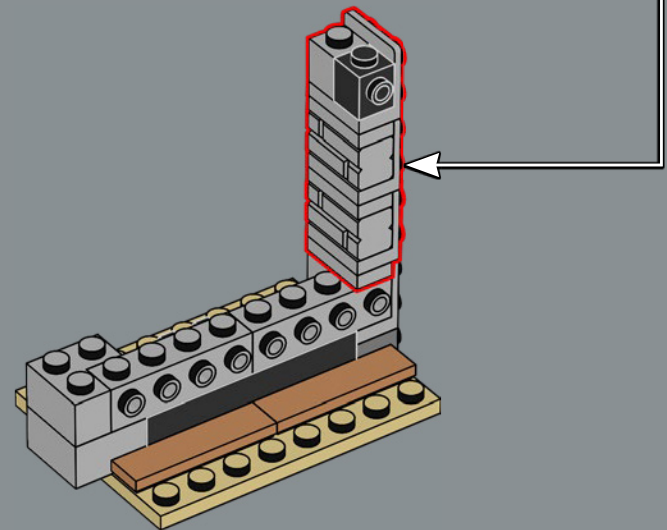
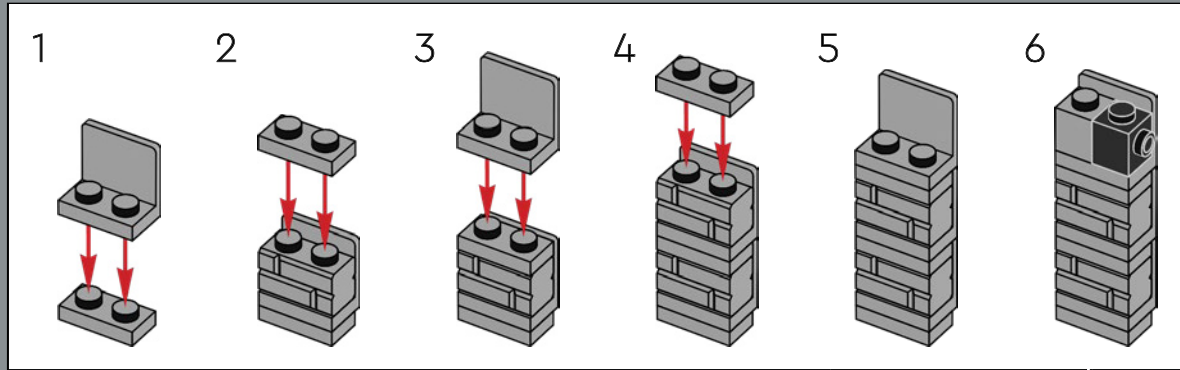

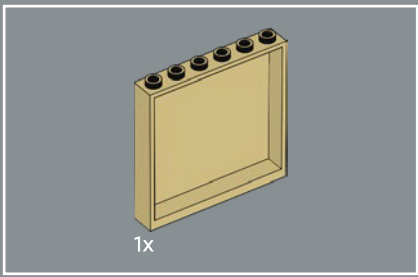

95

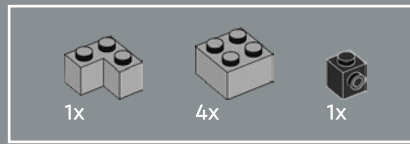
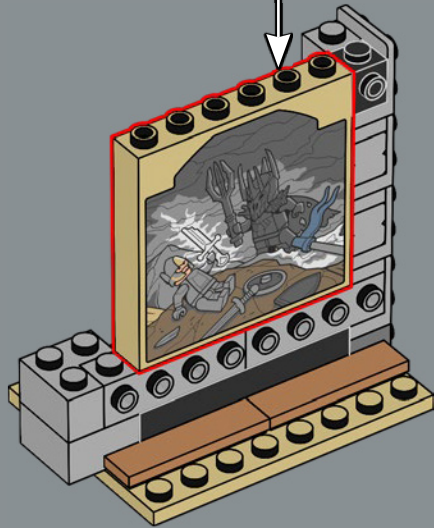
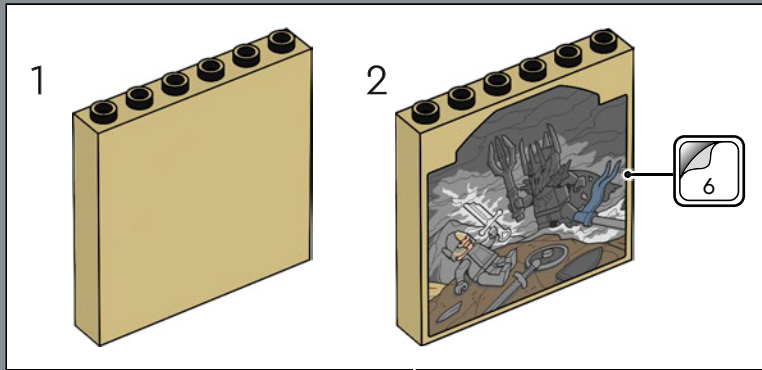

96

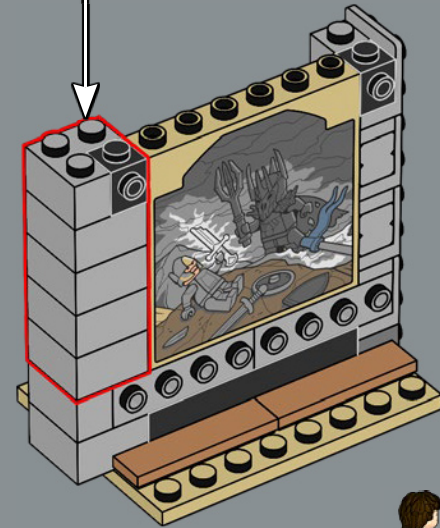
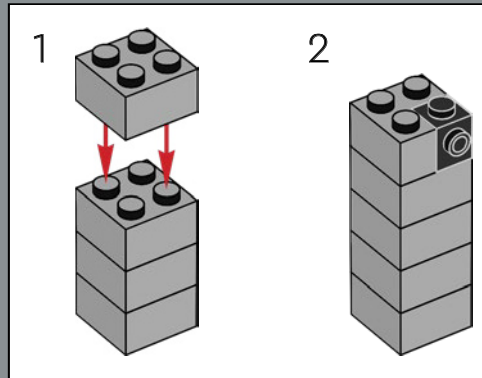

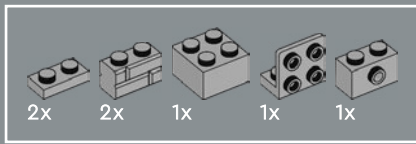

97

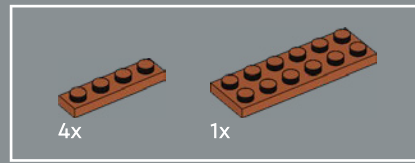
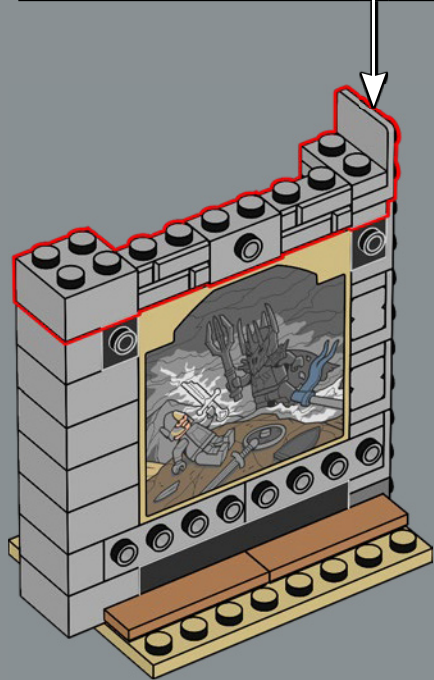
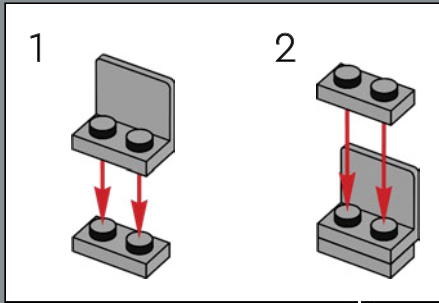

98

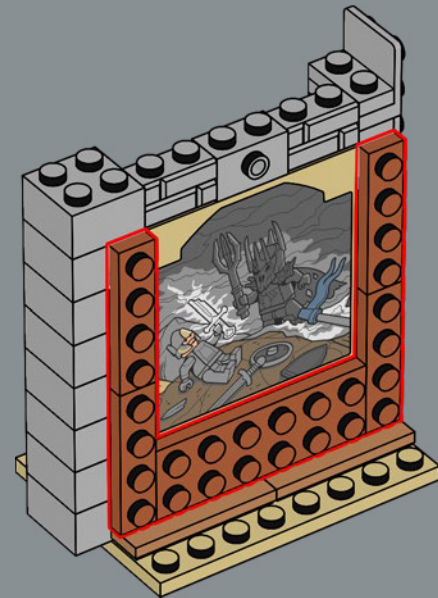

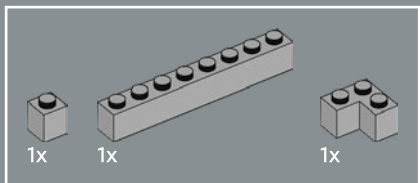

99

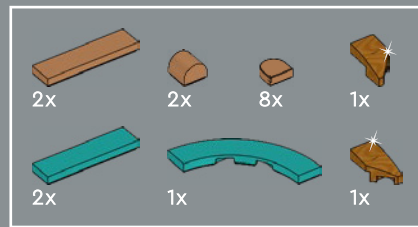
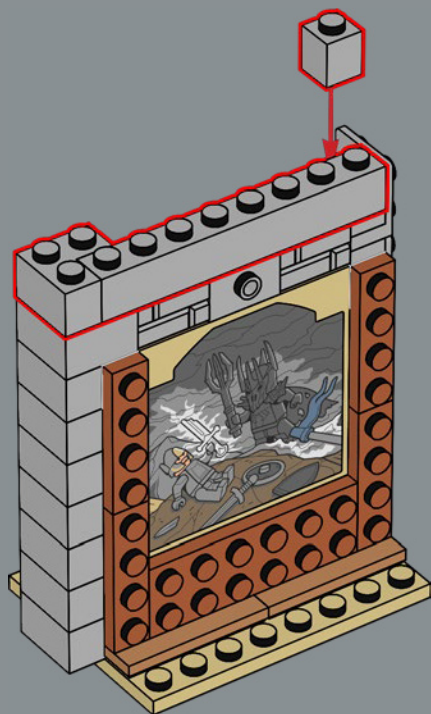

100

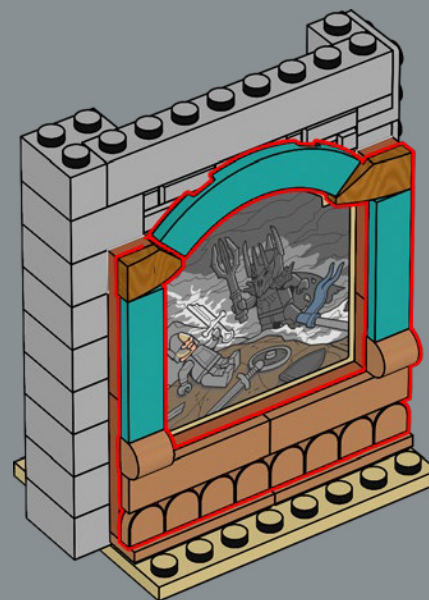

Saurons Untergang wird im LEGO® Universum mit einem neu designten Narsil-Heft und einem prächtigen blaugrünen Rahmen dargestellt.



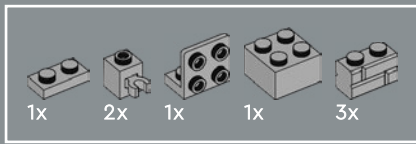

101

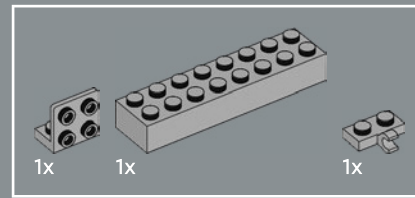
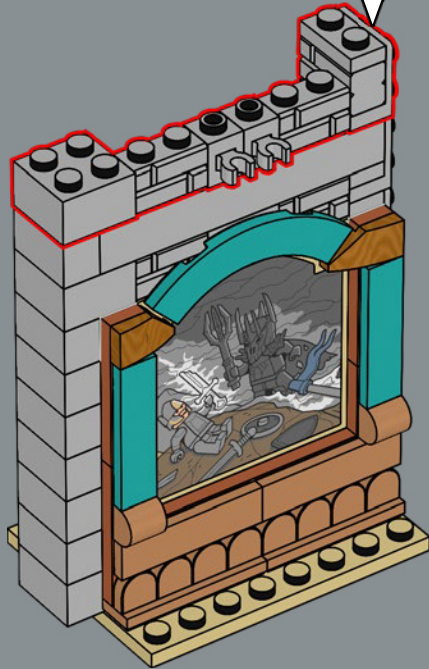
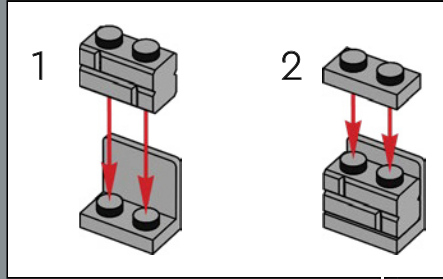

102

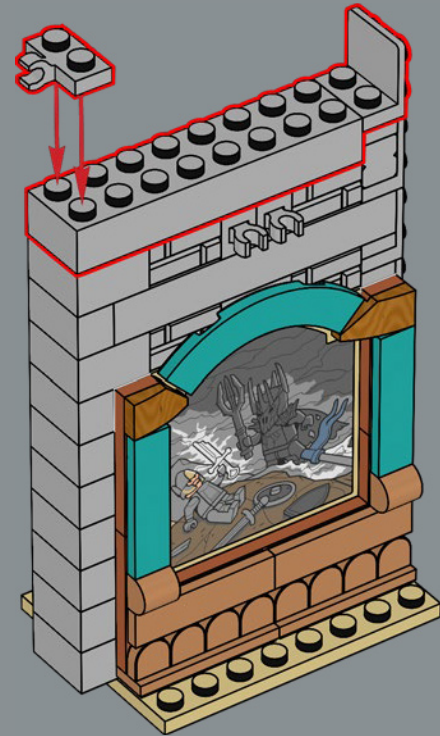

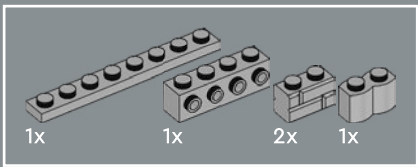

103

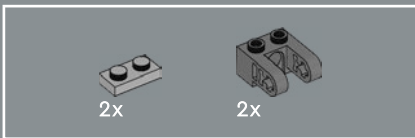
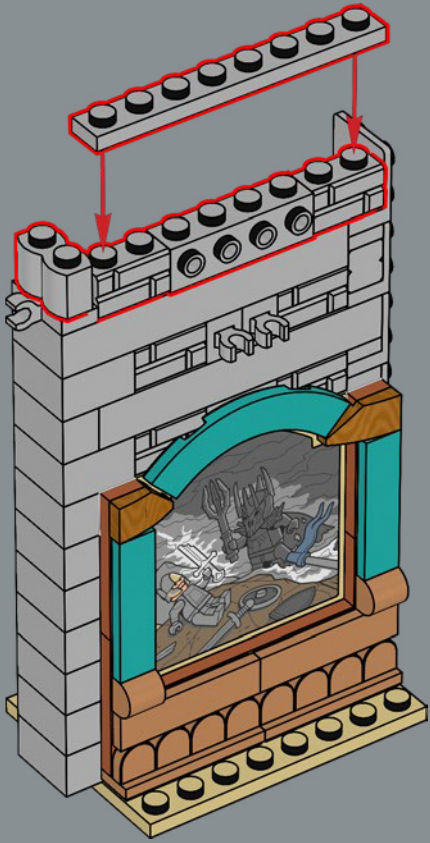

104

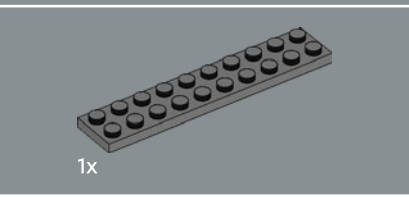
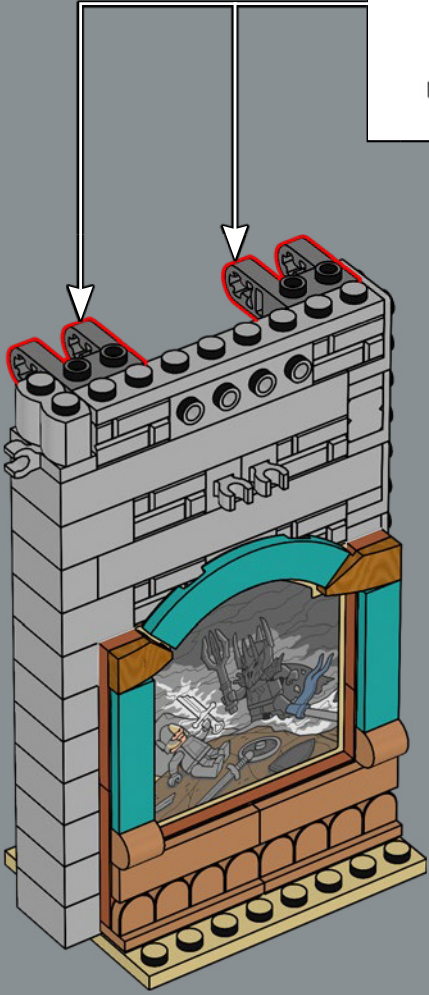
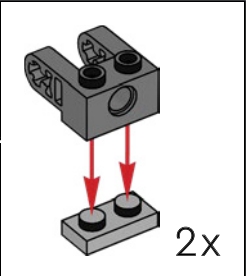

105

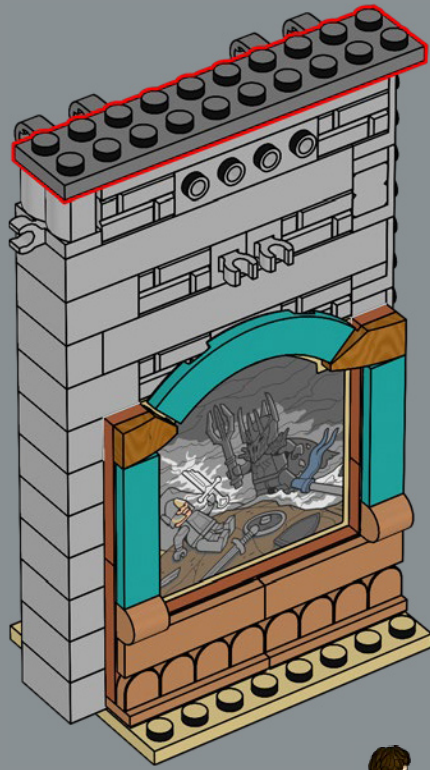



106



107

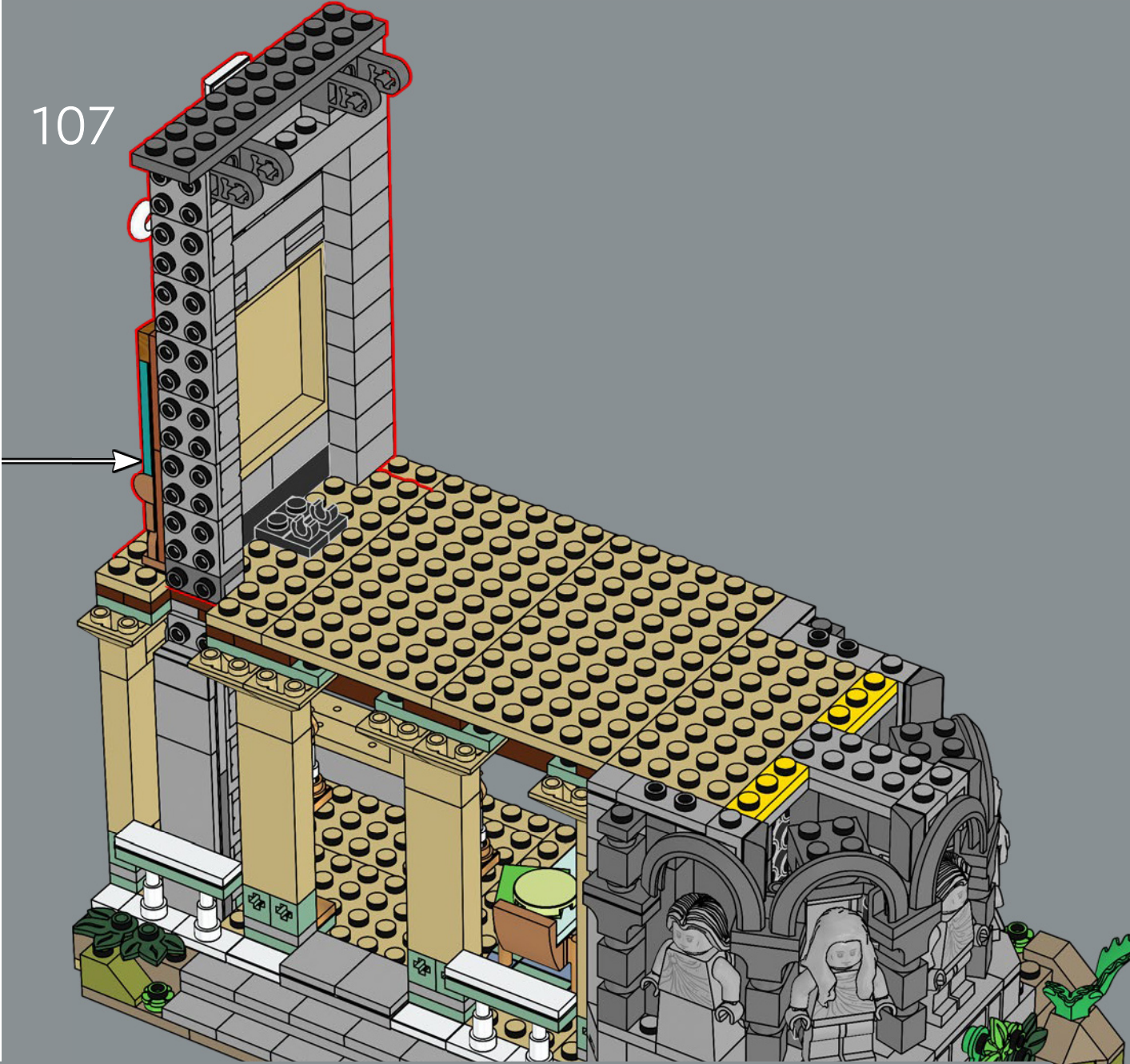

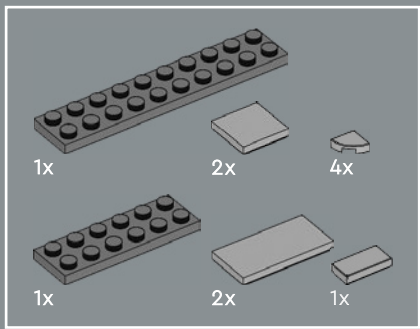

108

1

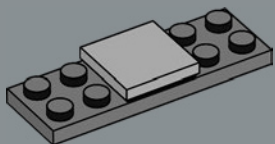

2

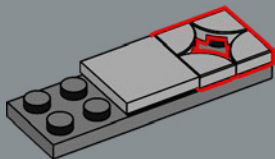

3

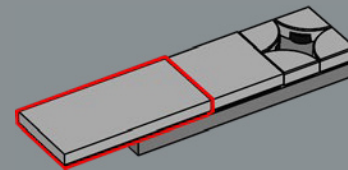

4

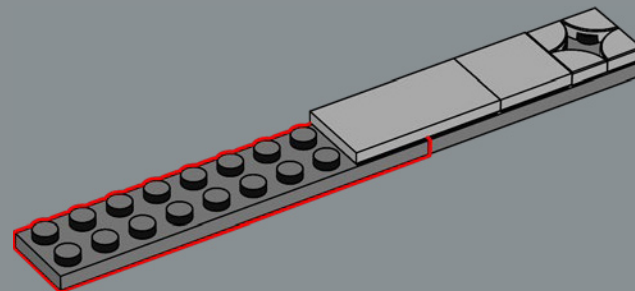

5

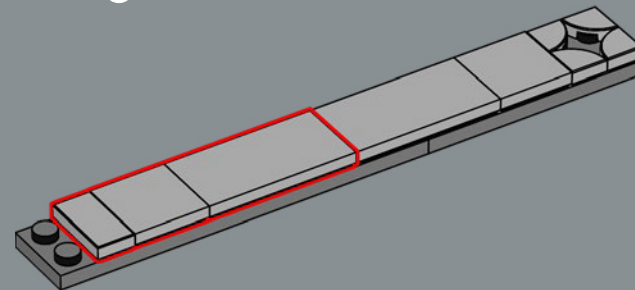

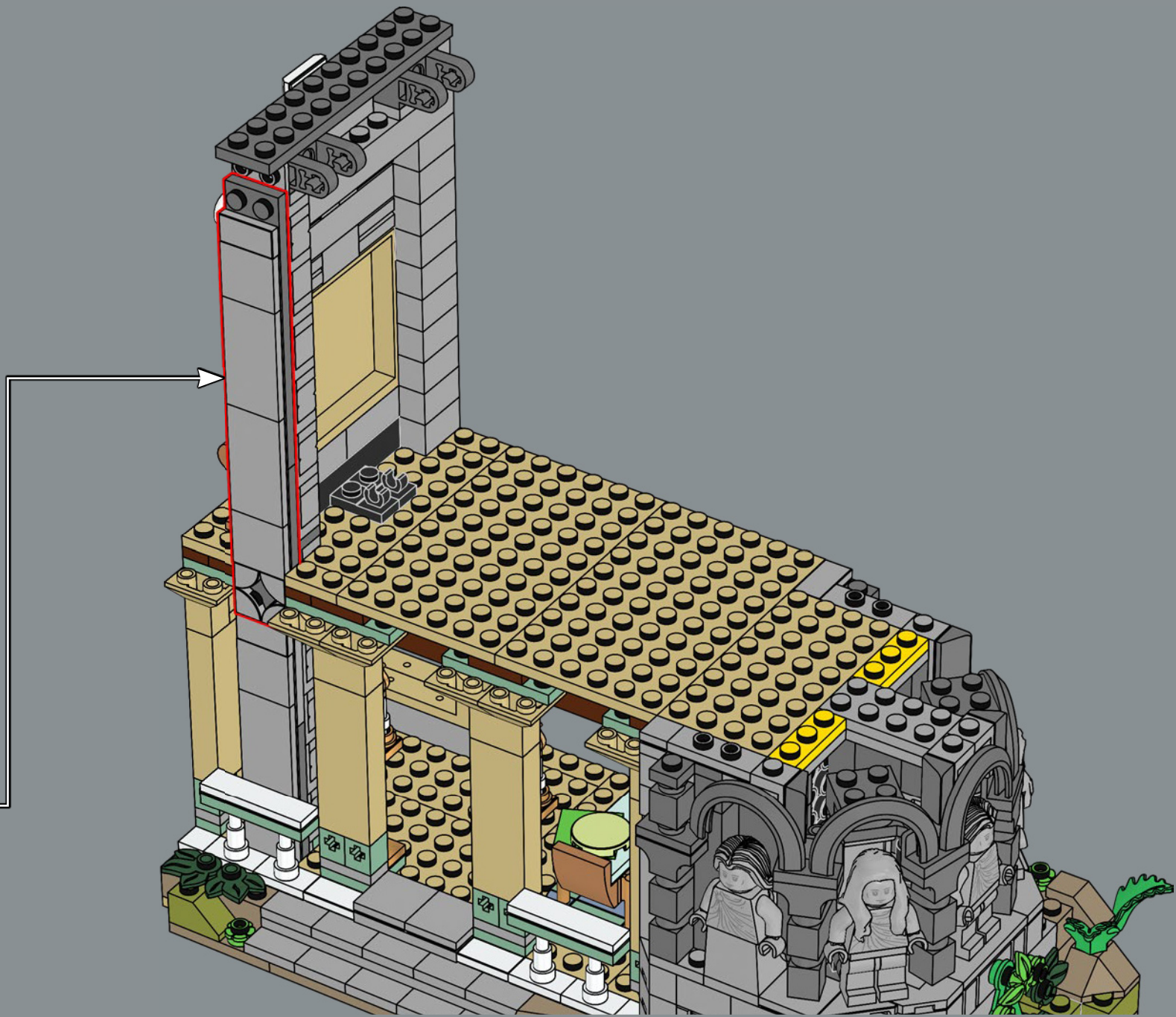

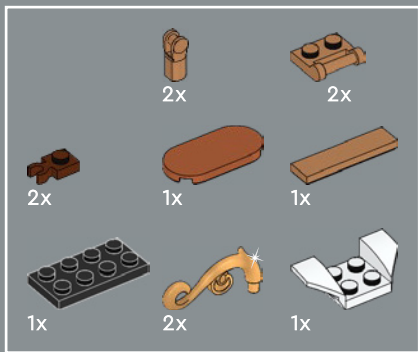

109

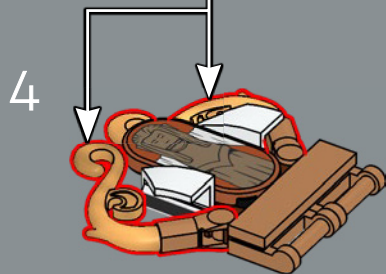
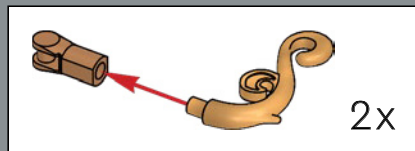
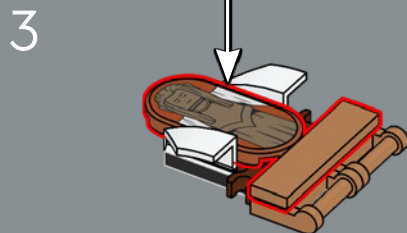
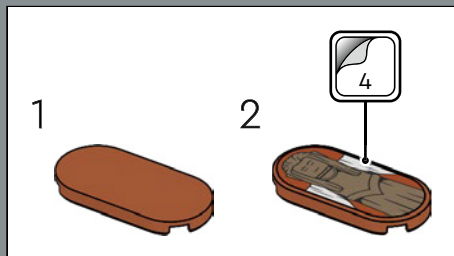
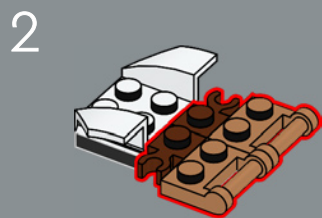
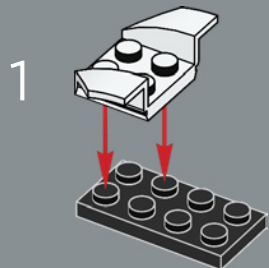

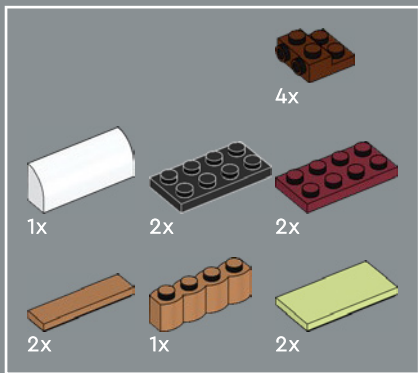

110

1

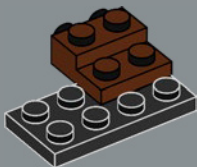

2

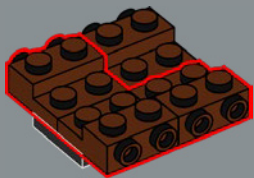

3

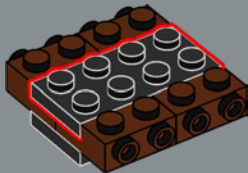

4



5



6

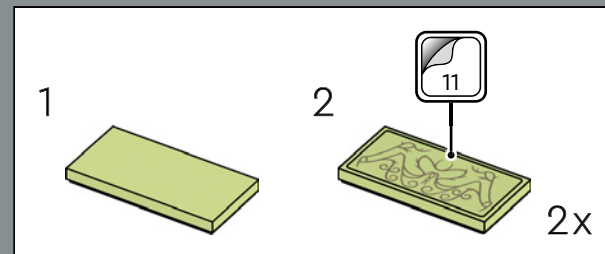
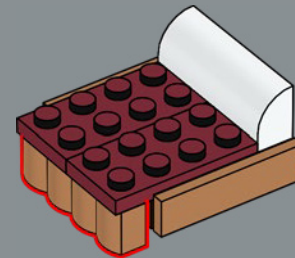

7

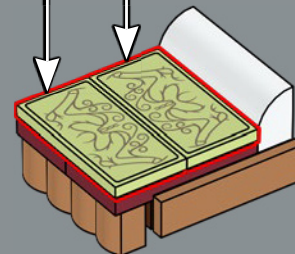

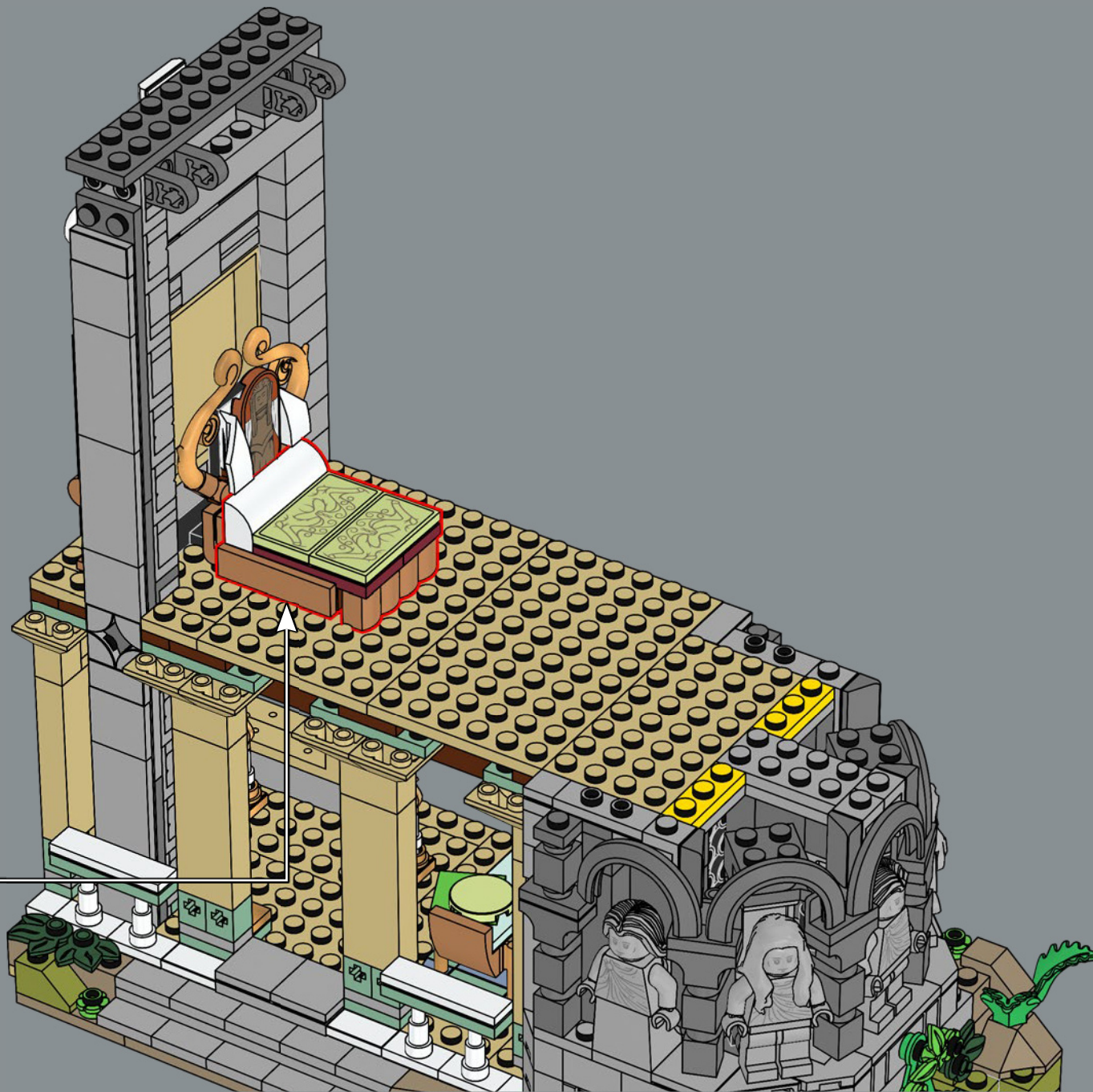



111

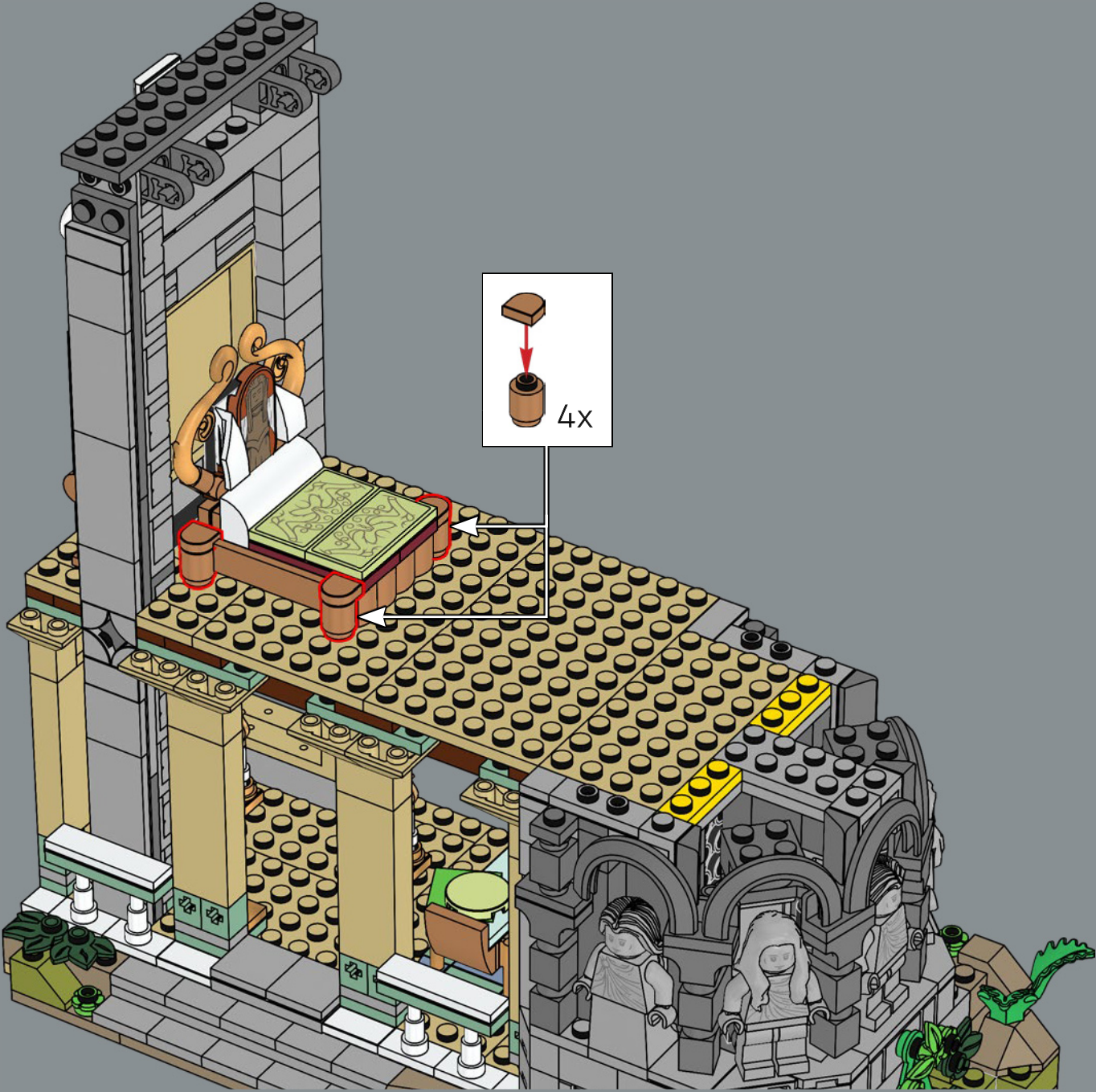

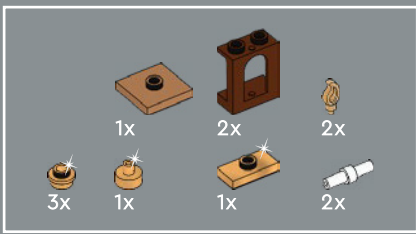

112

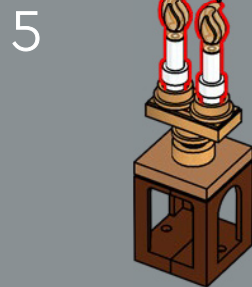
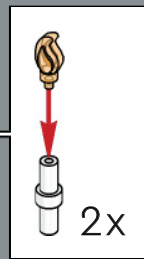
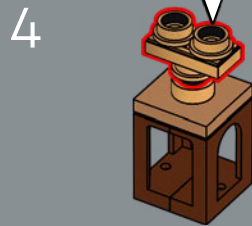
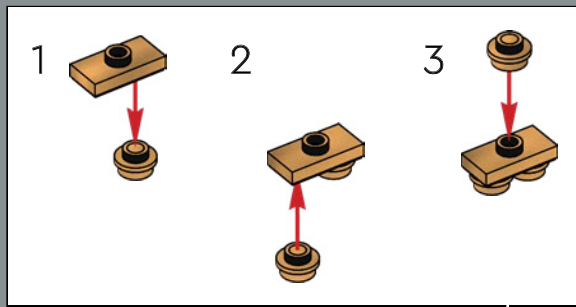
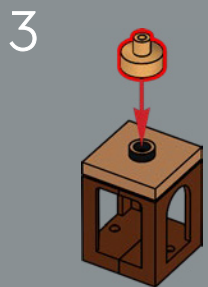
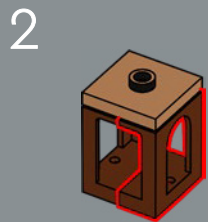
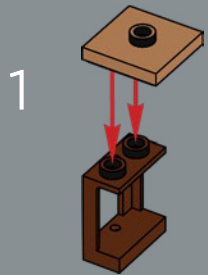

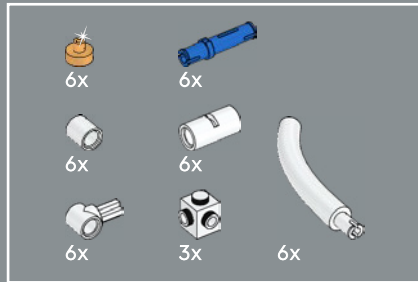
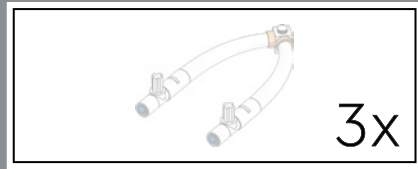

1



2



3

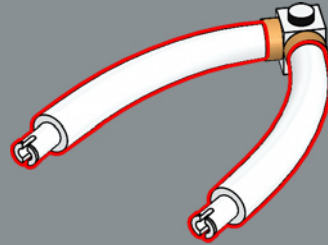

4

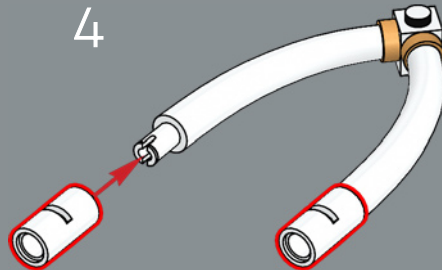

5

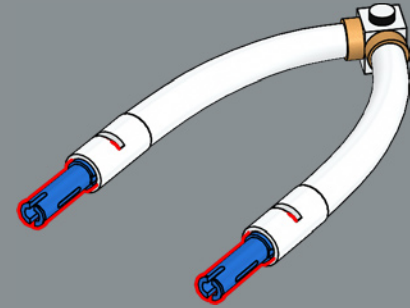

6

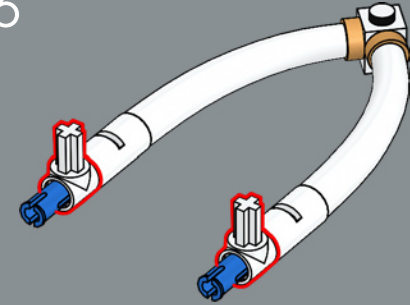

7

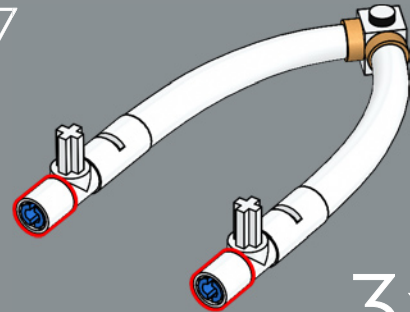

3x

113





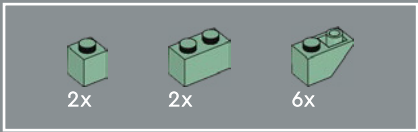

114



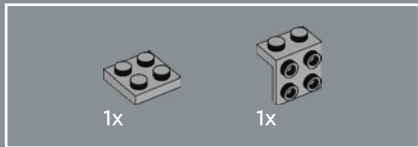
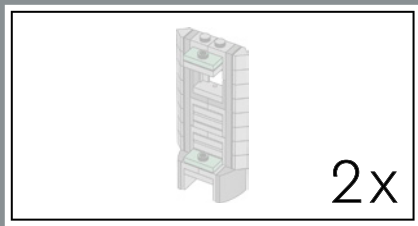

115

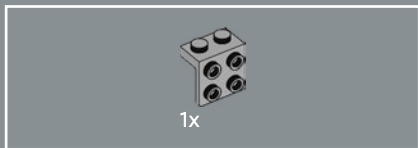
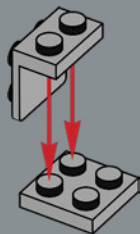

116

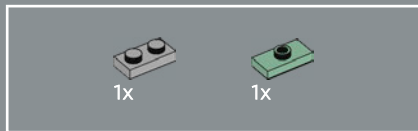
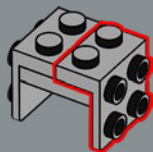

117

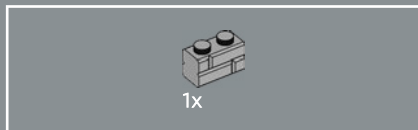
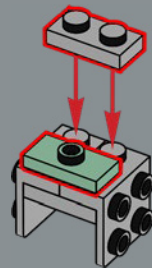

118

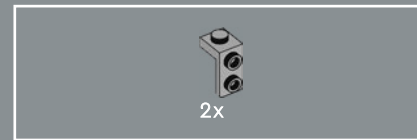
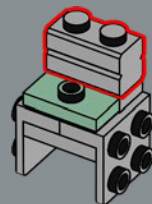

119

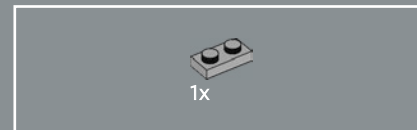
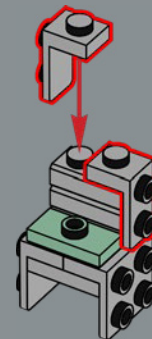

120

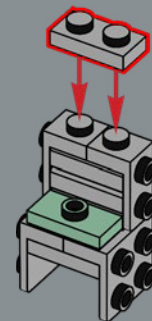

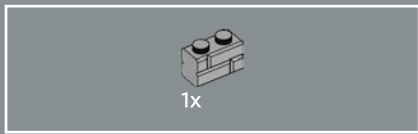

121

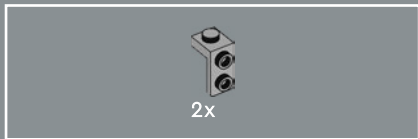
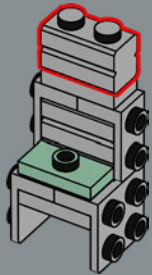

122

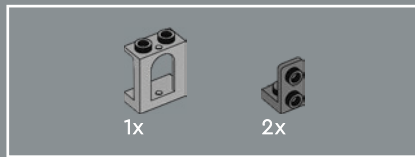
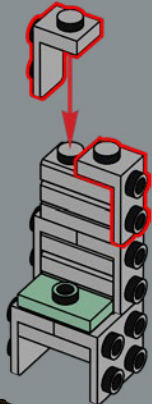

123

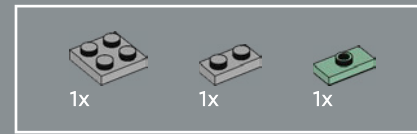
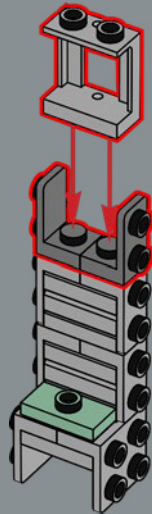

124

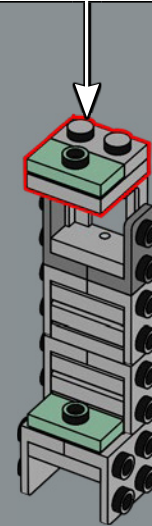
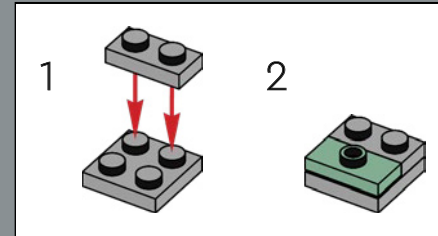



2x

125

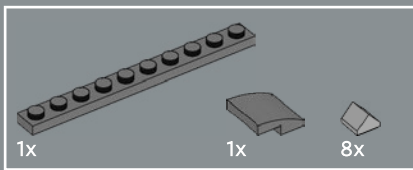
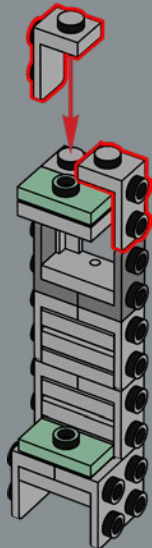

126

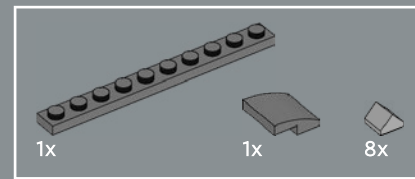
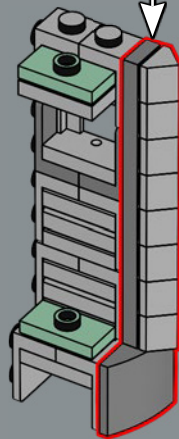
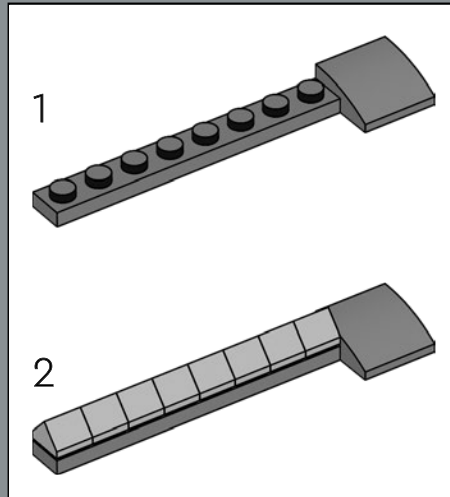

127

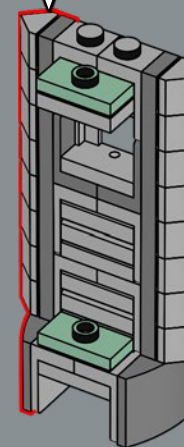
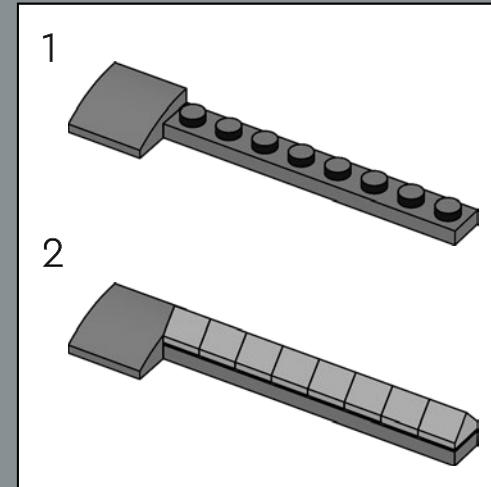

2x

128



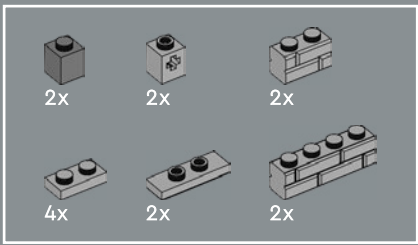

129

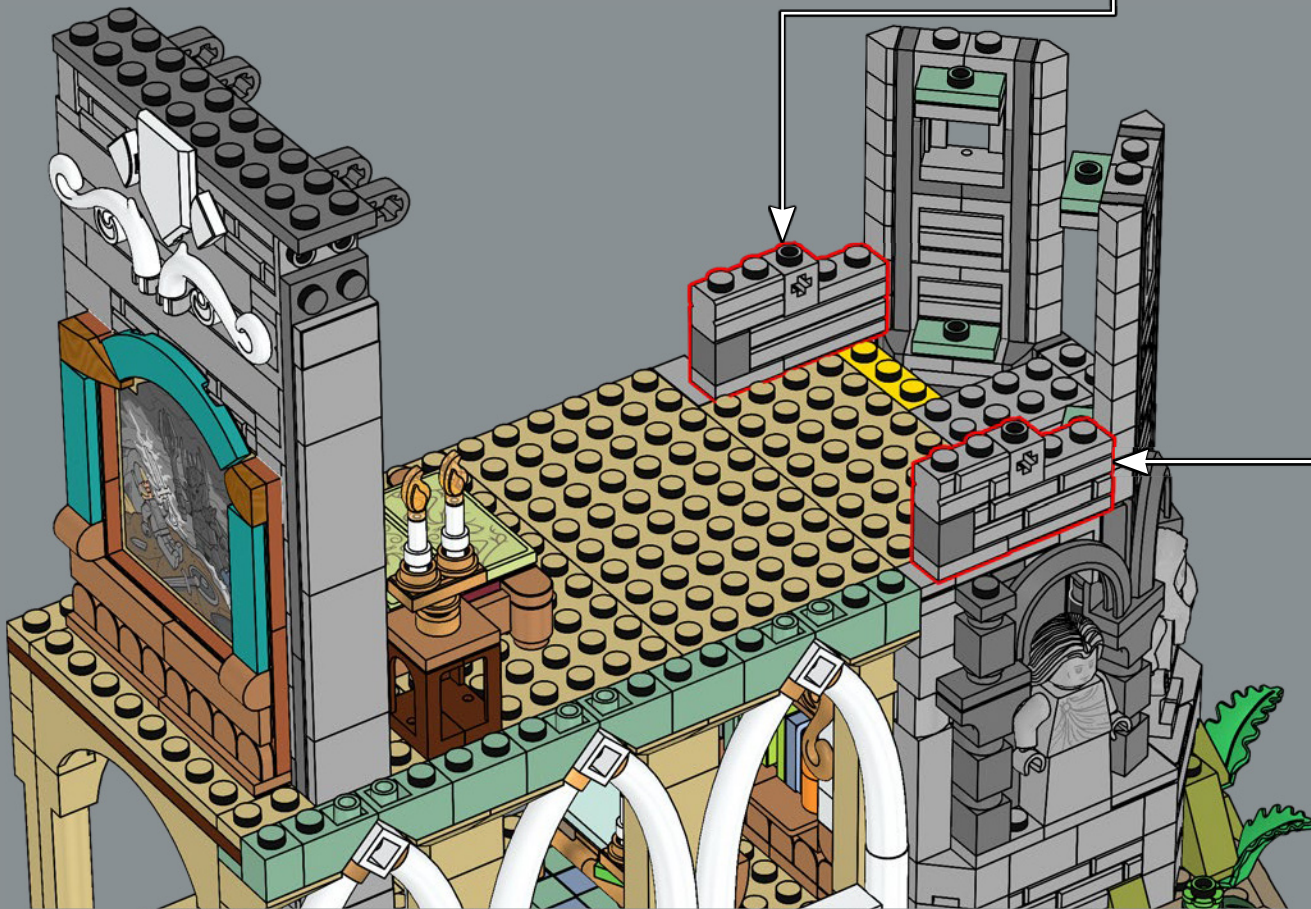
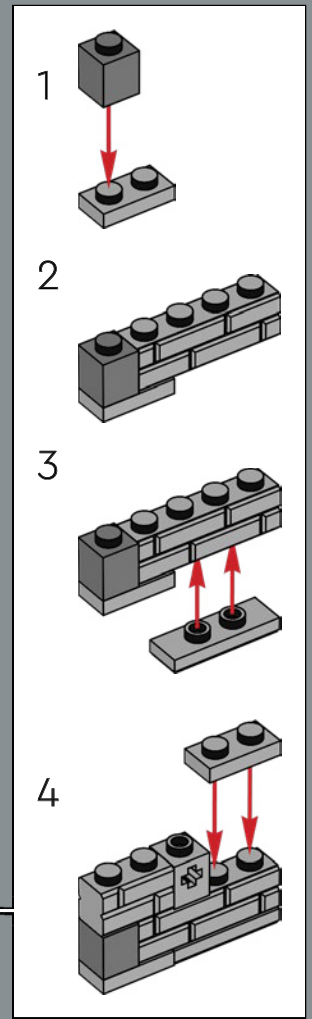
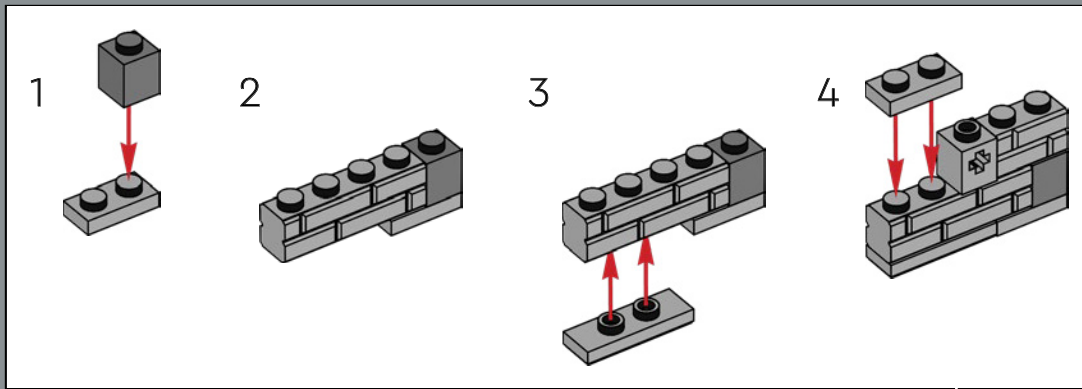

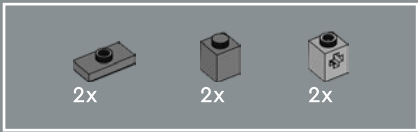

130

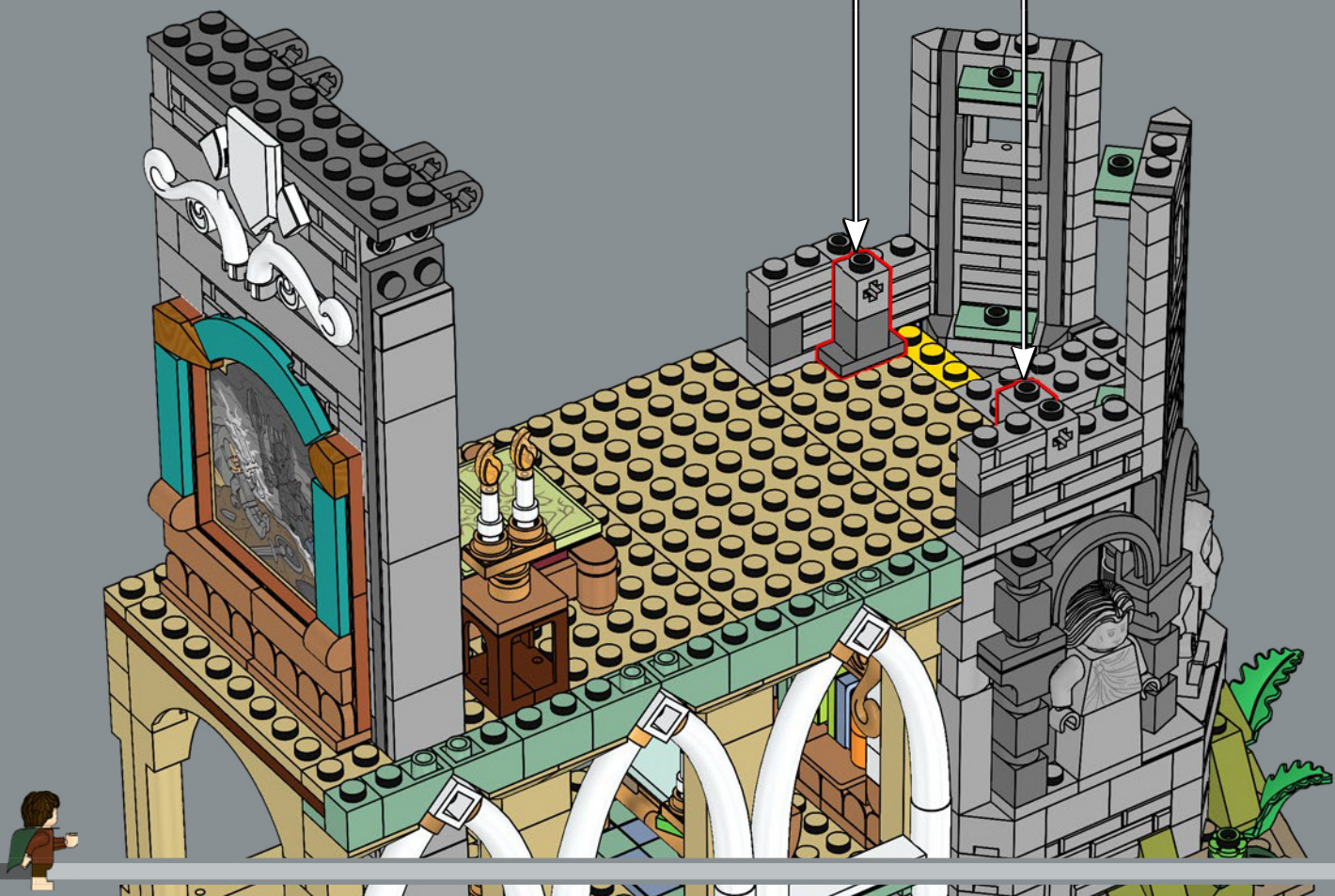
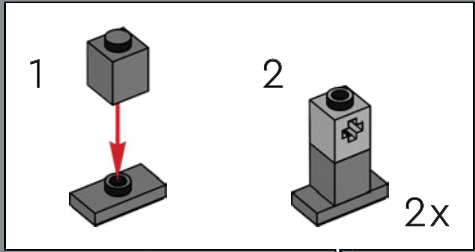

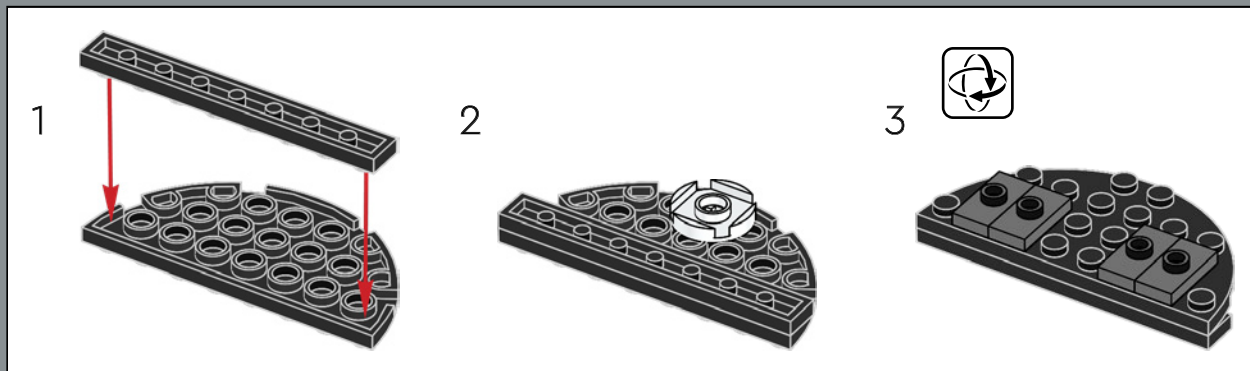
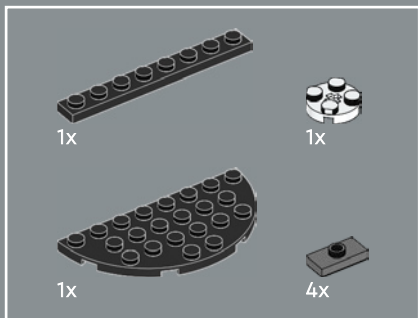

131

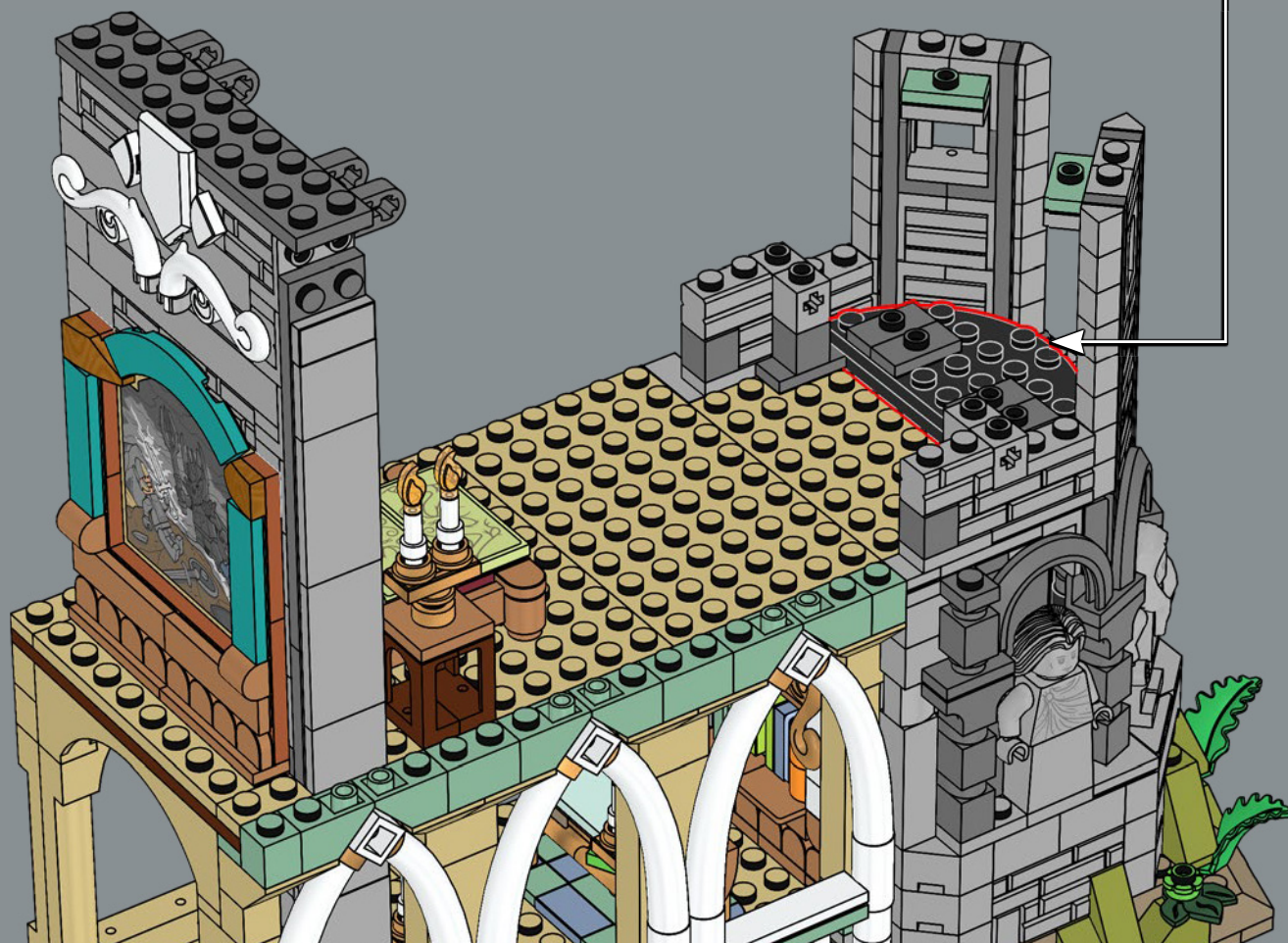

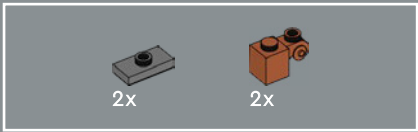

132

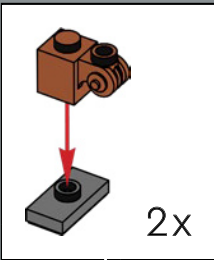

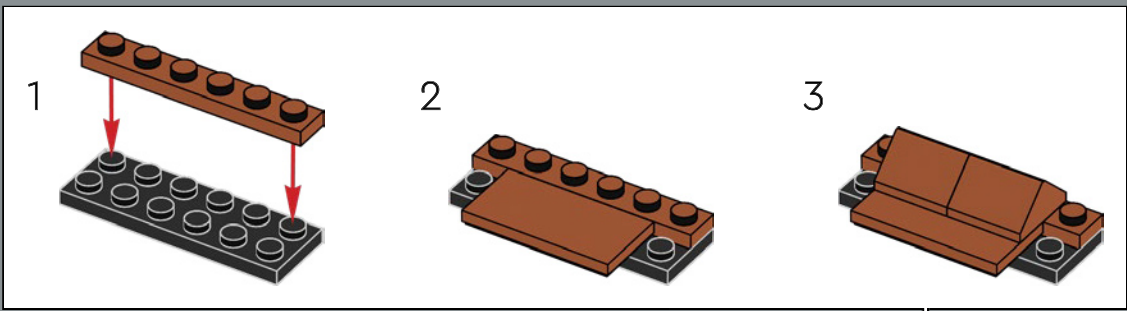
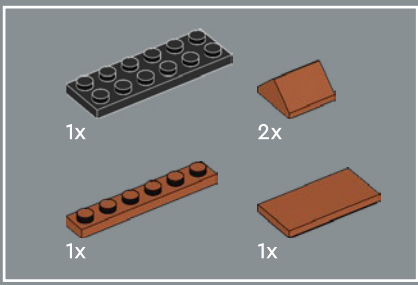

133



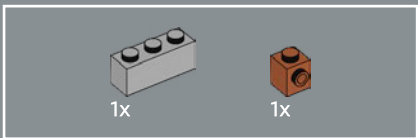

134

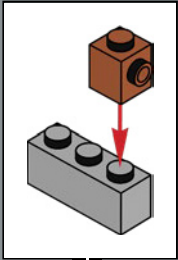



Dieser Schreibtisch ist nicht nur ein tolles Möbelstück, um ein Buch zu schreiben, sondern trägt auch das Dach und den Turm, die später angebaut werden.

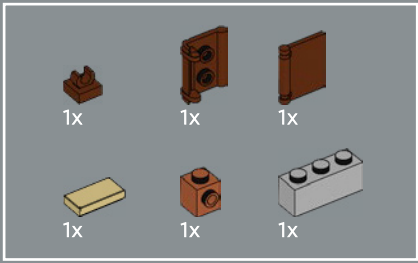

135

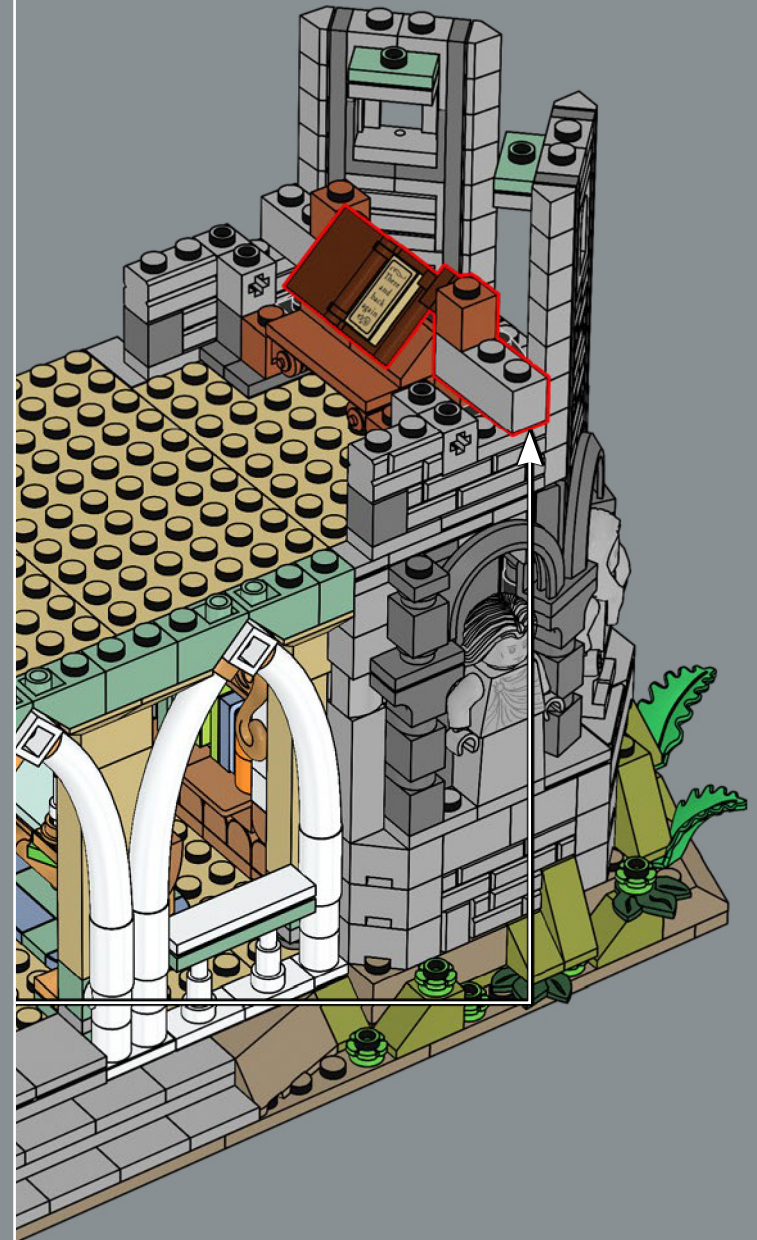
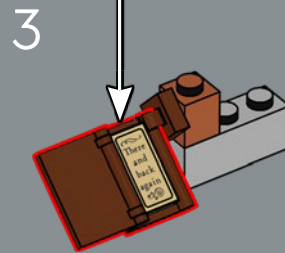
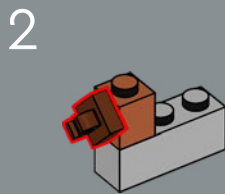
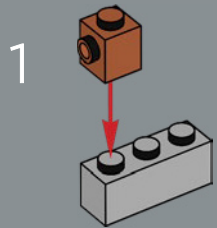
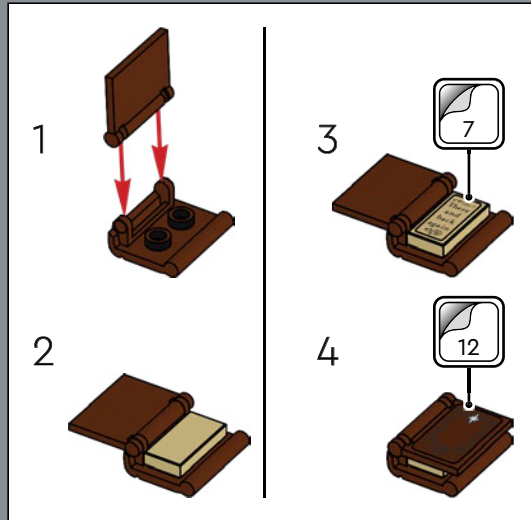

-  2x
-  1x
-  2x
-  1x
-  2x
-  2x
-  1x

136

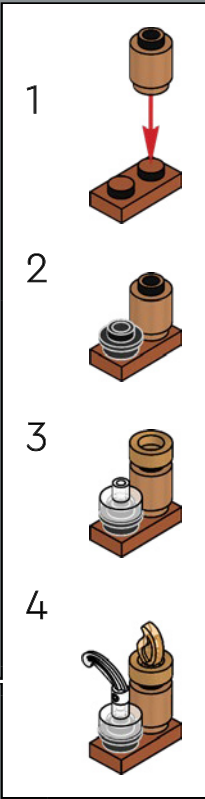
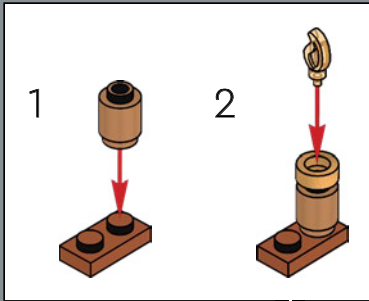

- 2x
- 4x
- 2x
- 2x

137

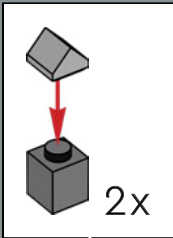



Dies ist das erste LEGO® Modell, in dem wir dem 111-jährigen Bilbo begegnen. Zeig ihm bloß nicht den Ring, um ihn nicht zu sehr aufzuregen!

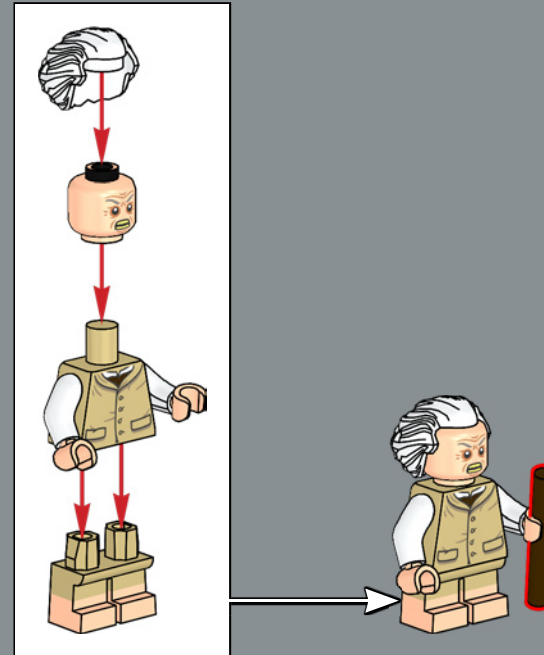

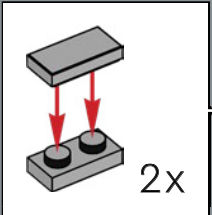
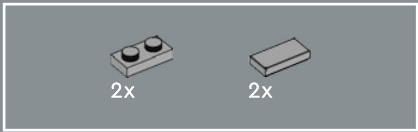

138

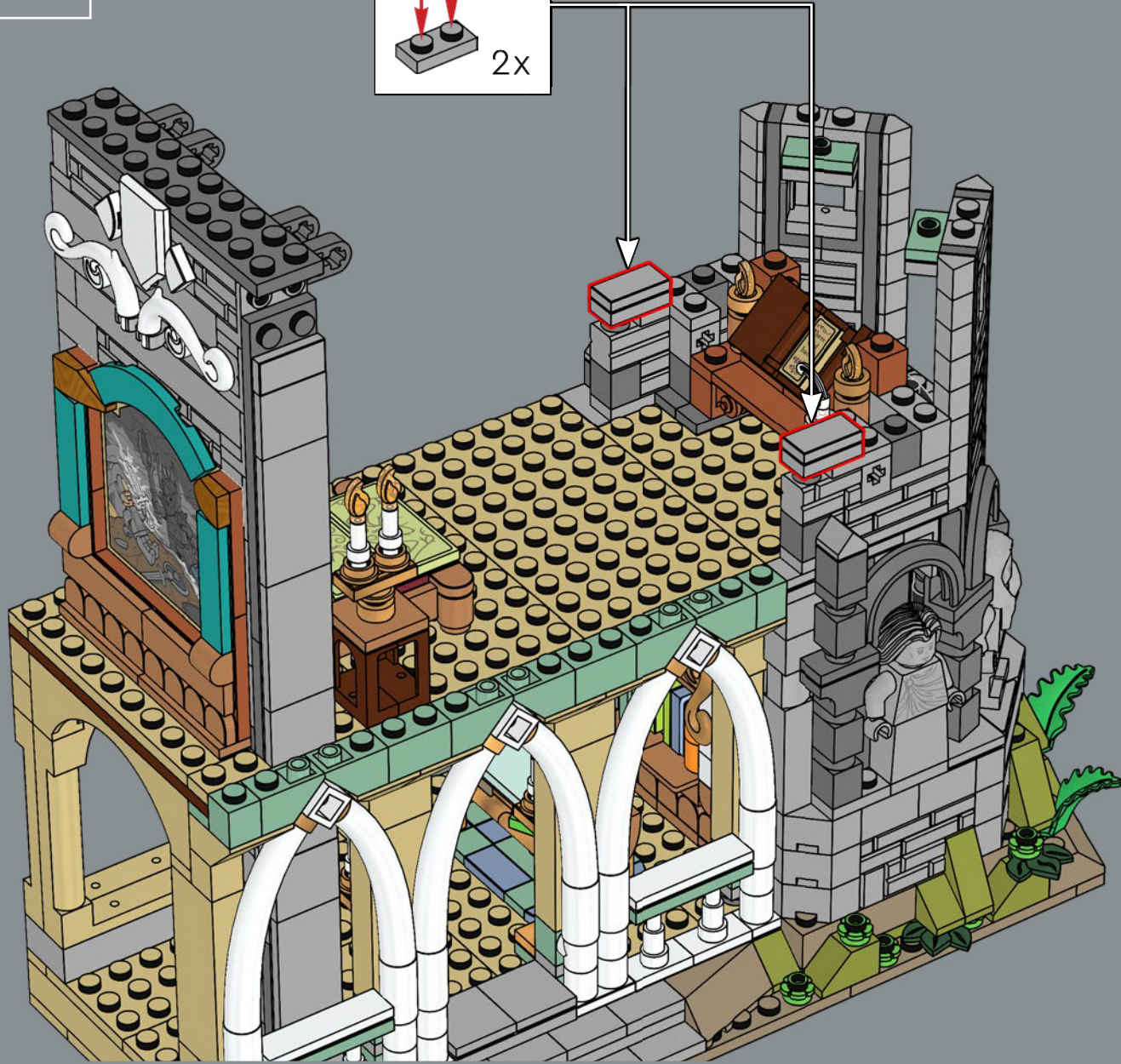

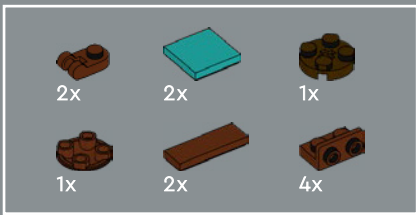

139

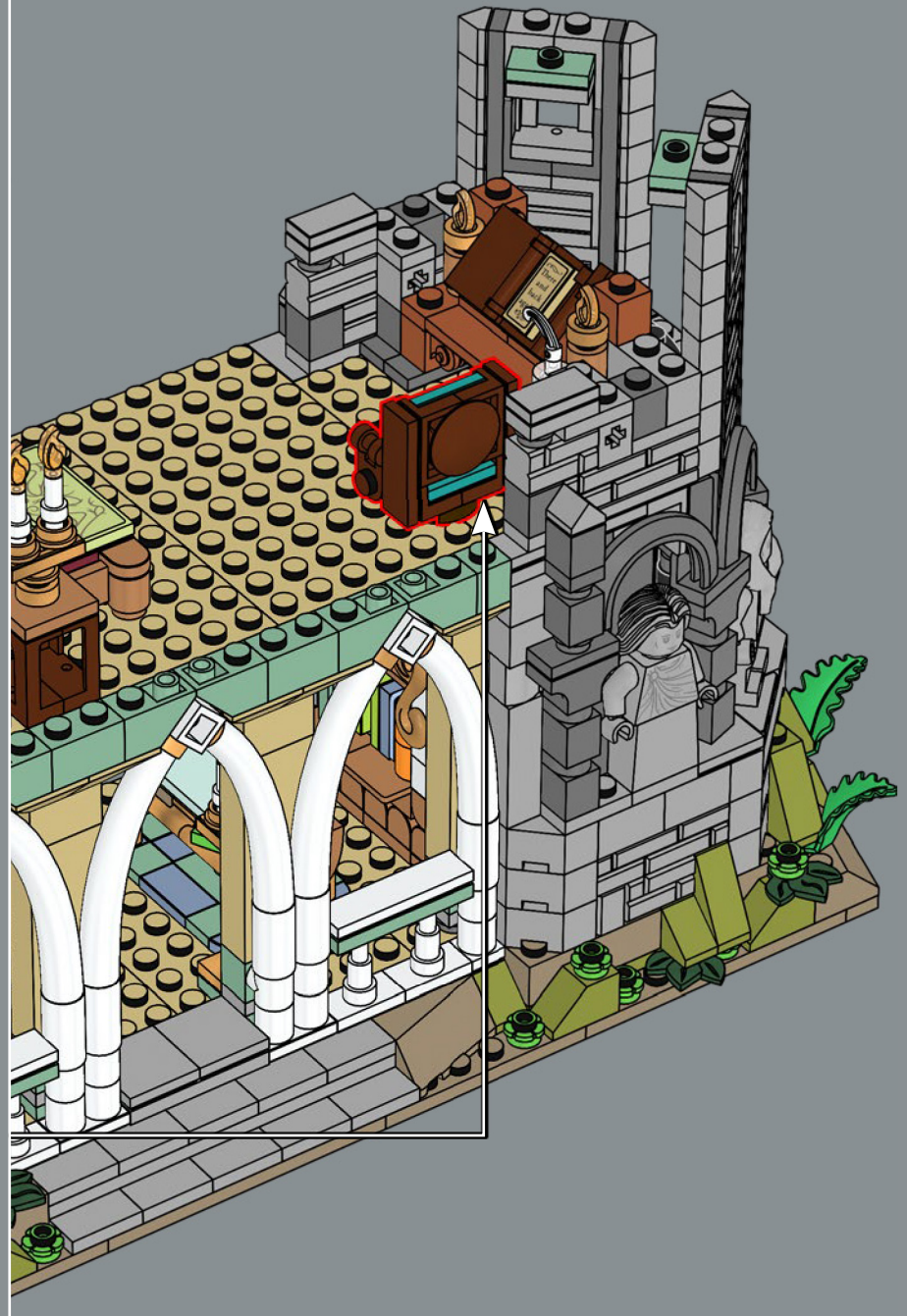
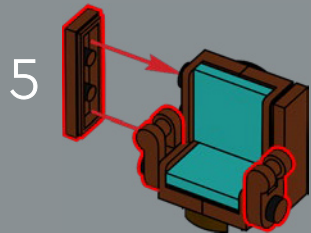
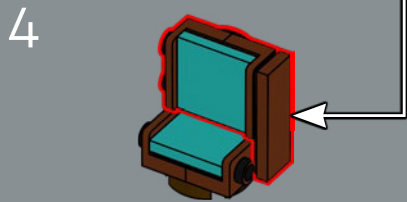
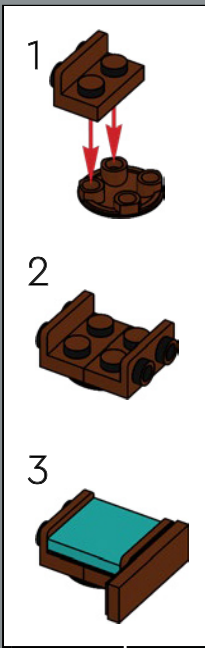
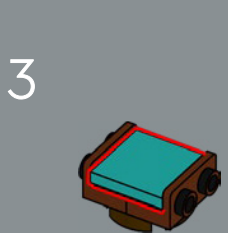
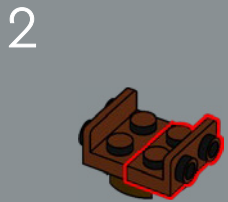
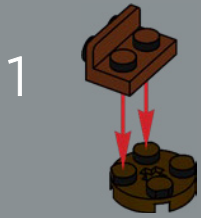

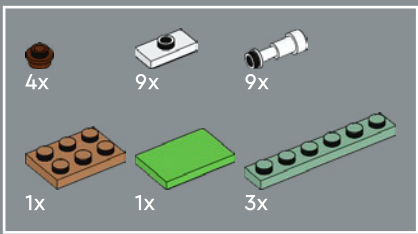

140

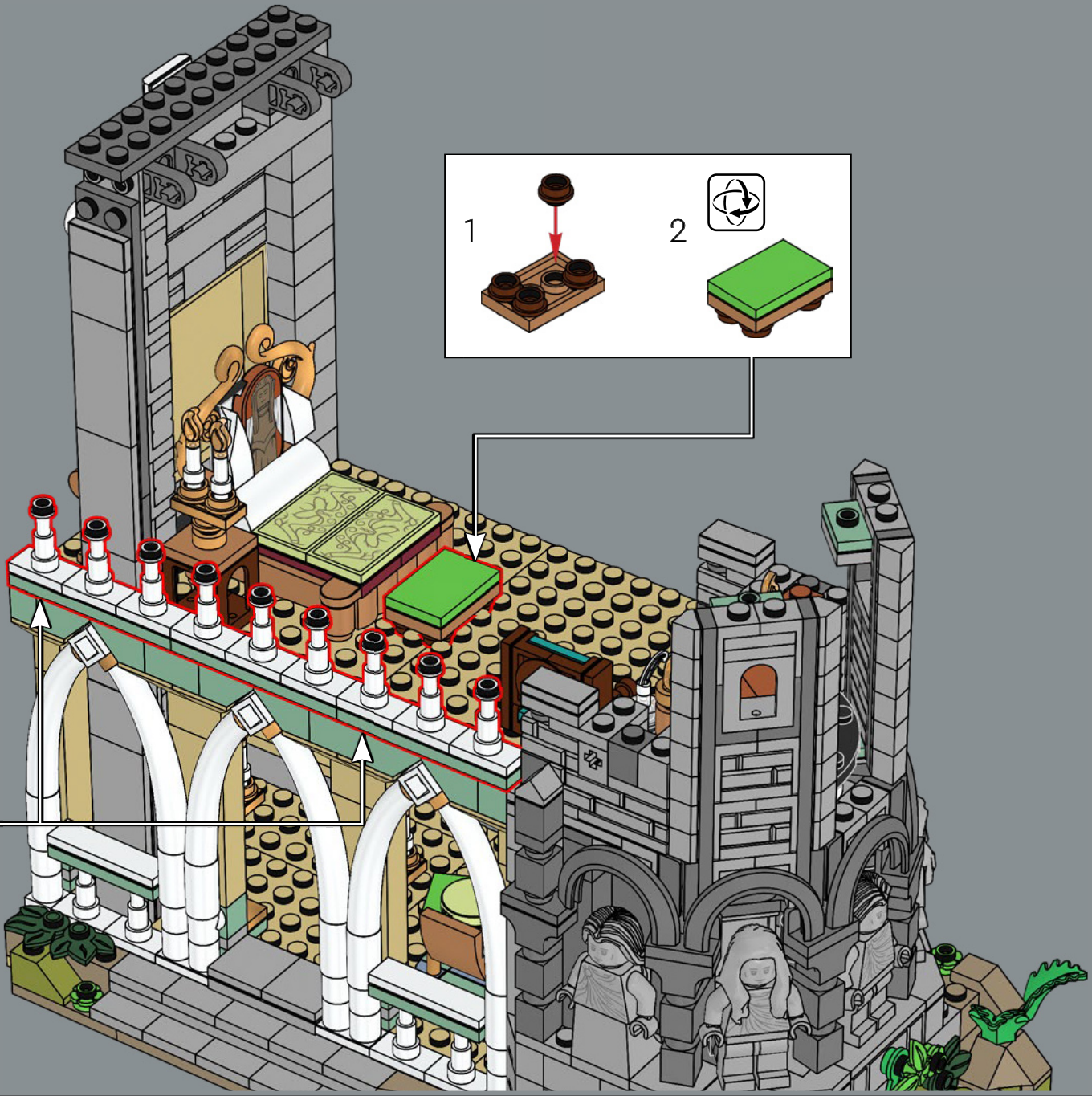
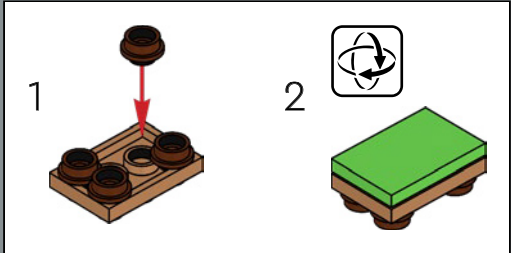
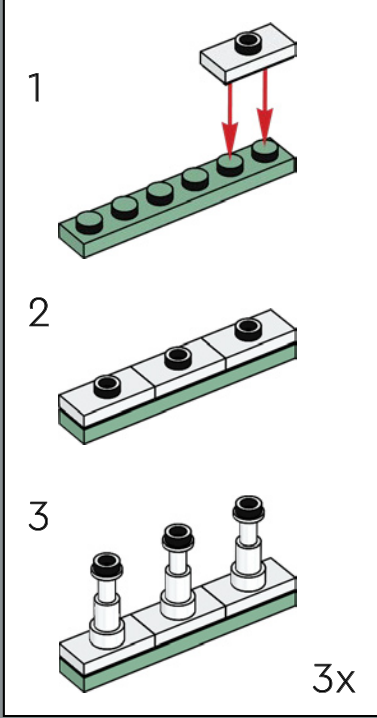

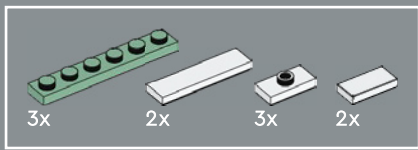

141

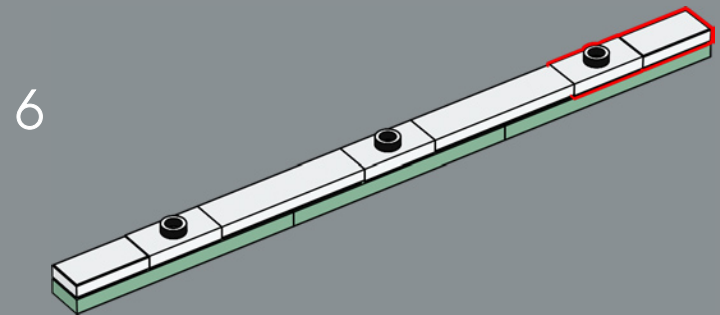
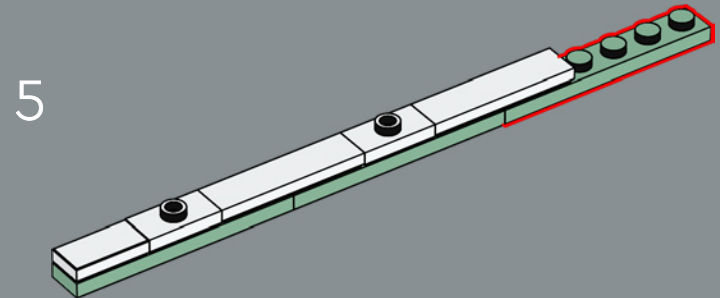
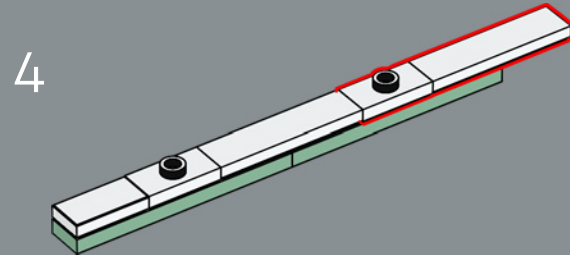
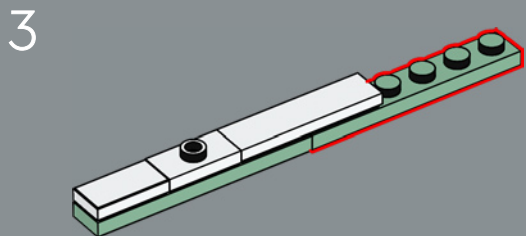
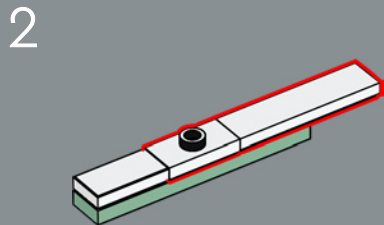
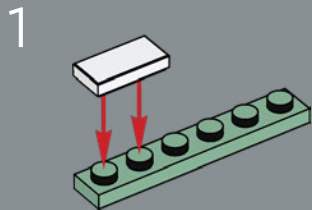



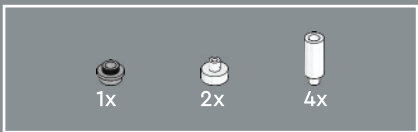

142

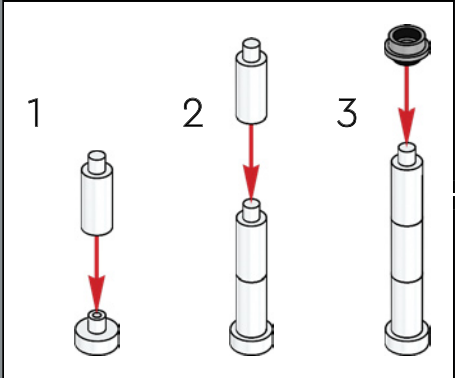

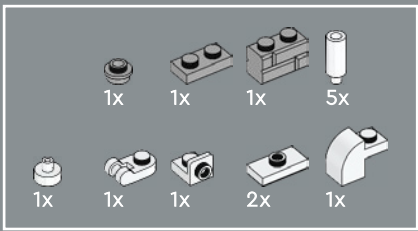

143

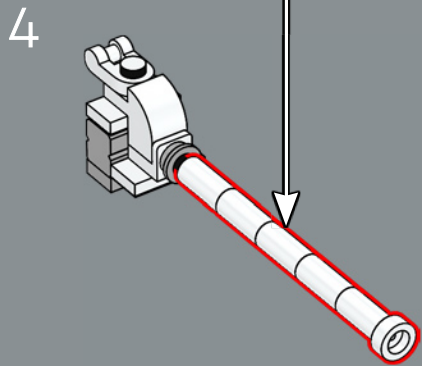
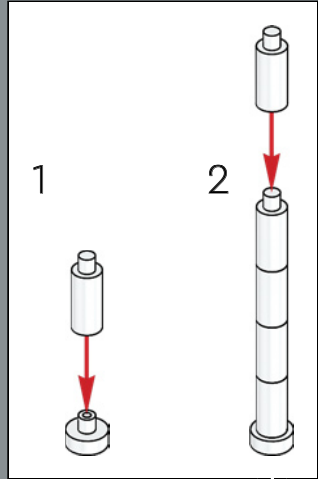
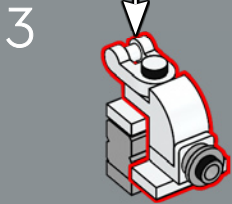
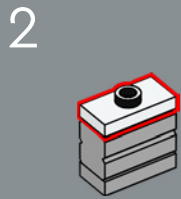
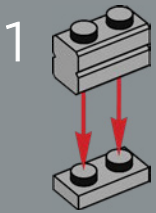
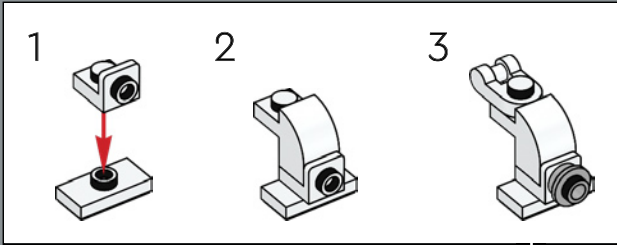



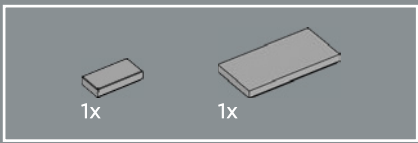

144



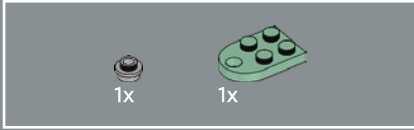
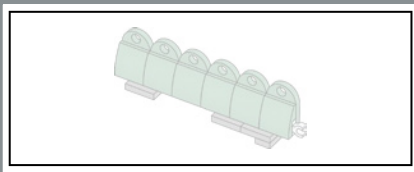

145

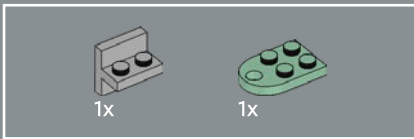
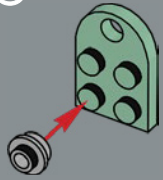

146

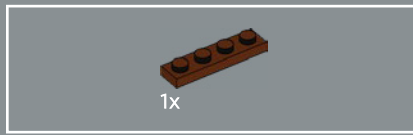
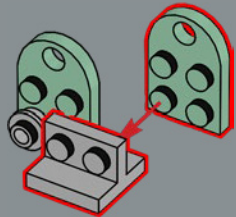

147

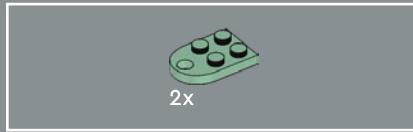
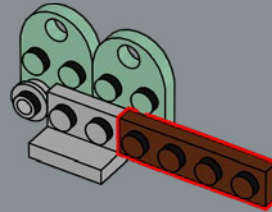

148

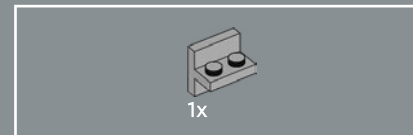
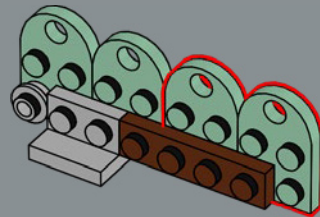

149

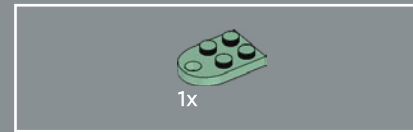
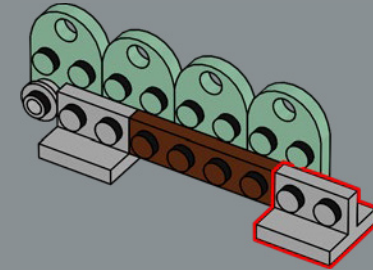

150

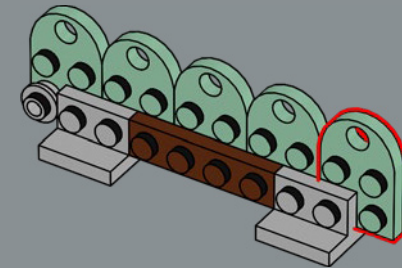

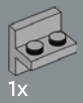

1x

151

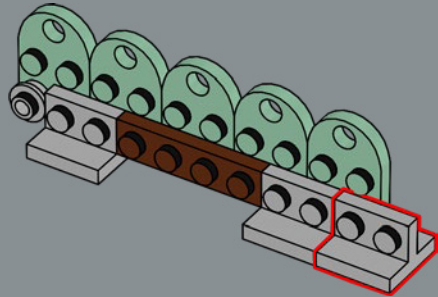

6x

153

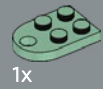
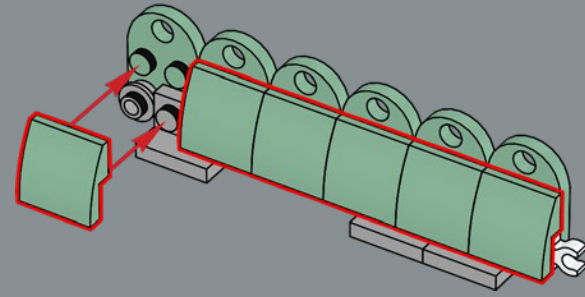

1x



1x

152

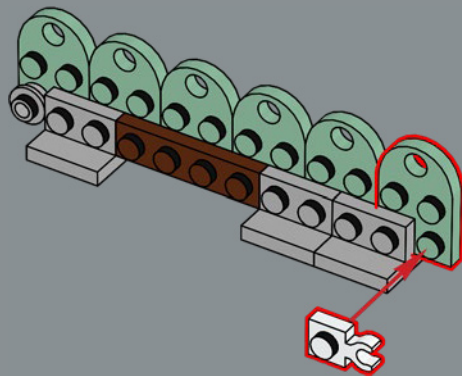

1x

154

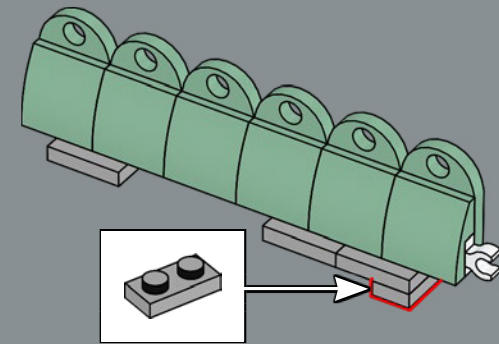

155



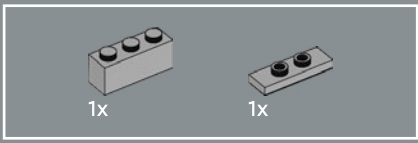

156

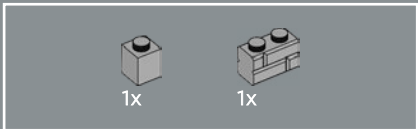
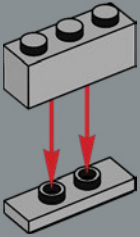

157

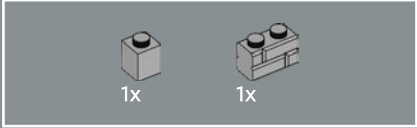
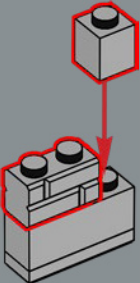

158

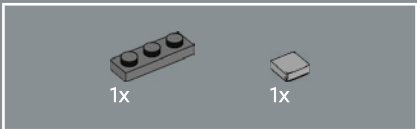
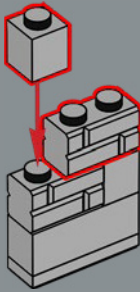

159

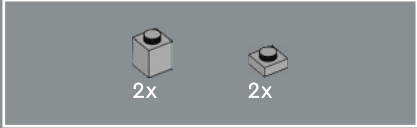
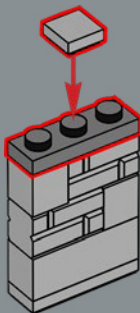

160

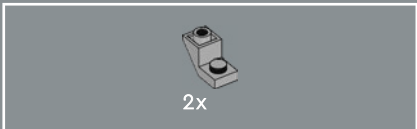
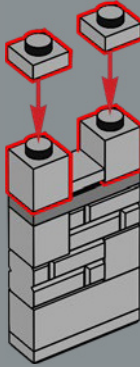

161

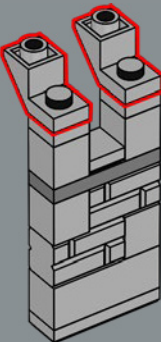

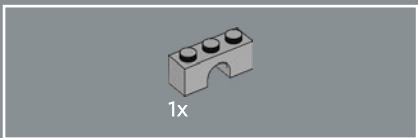

162

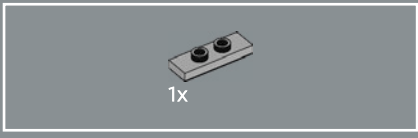
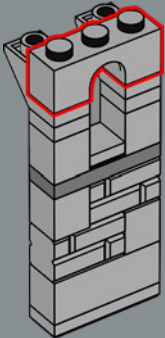

163

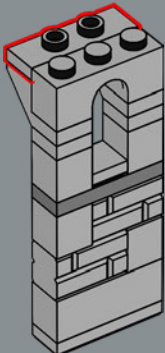

164

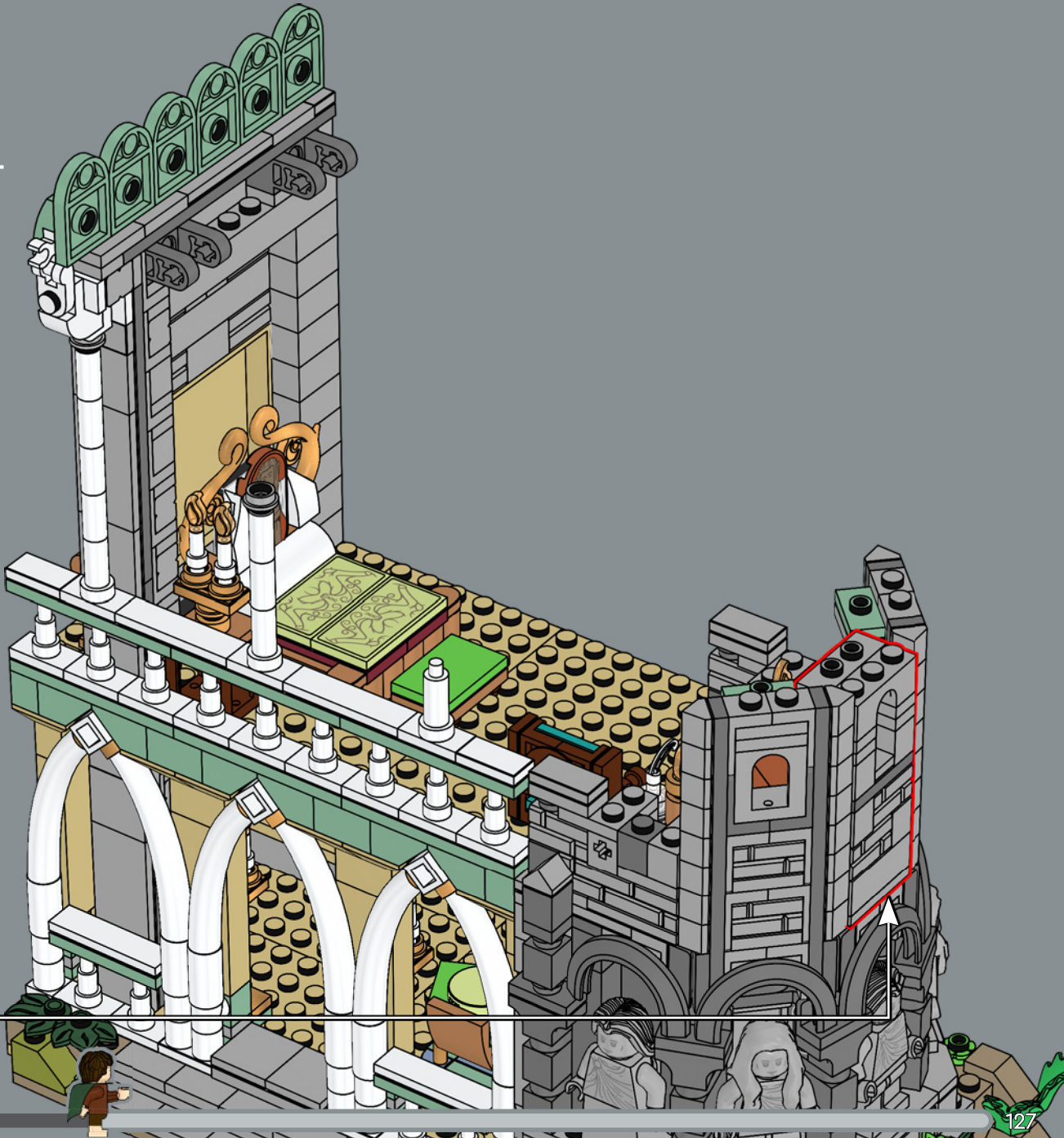

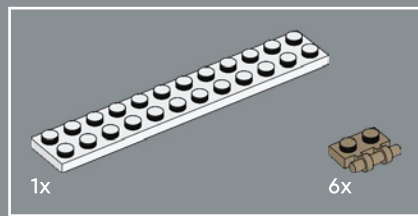

165

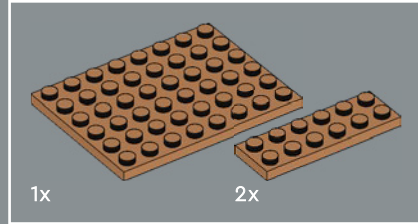
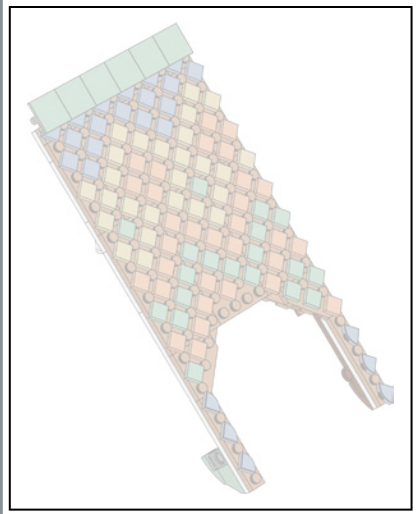
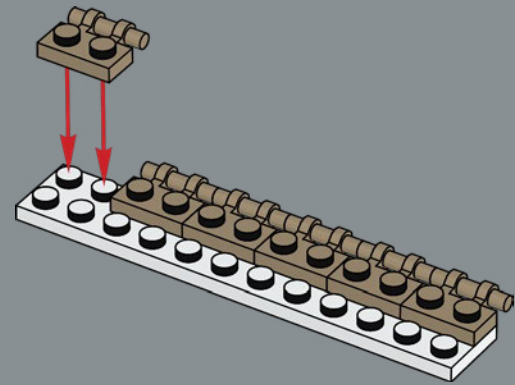

166

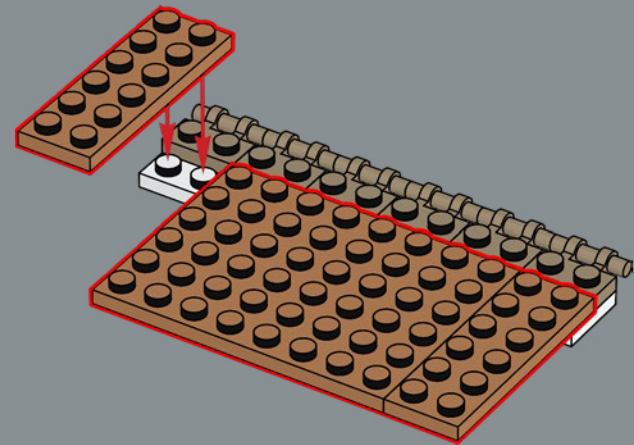

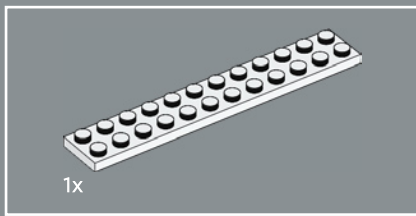

167

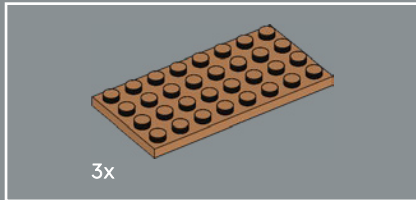
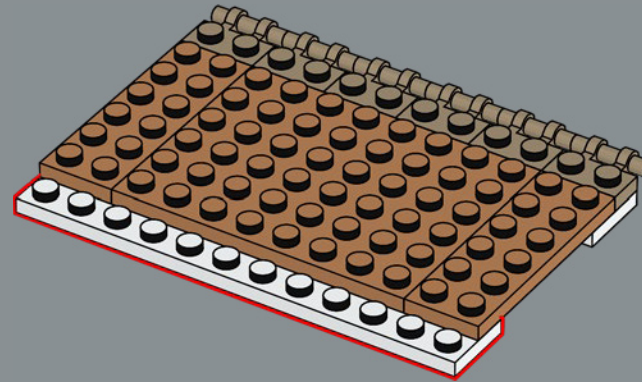

168

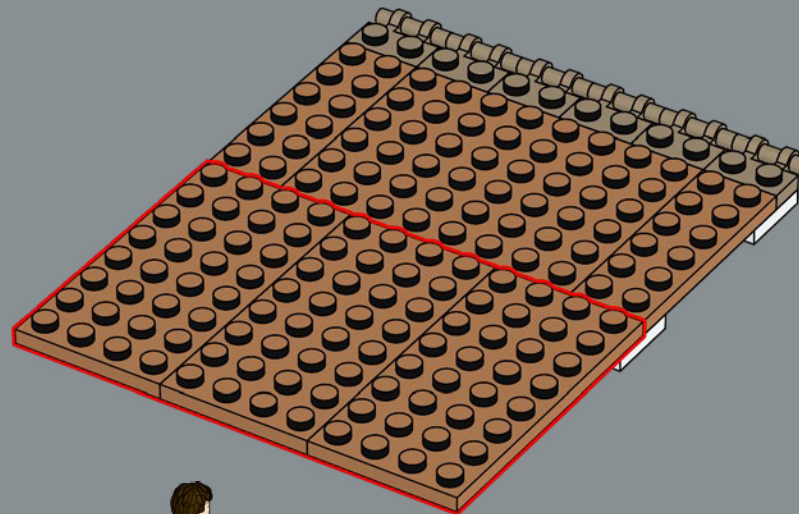

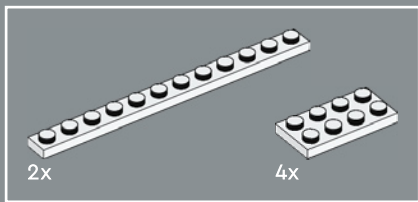

169

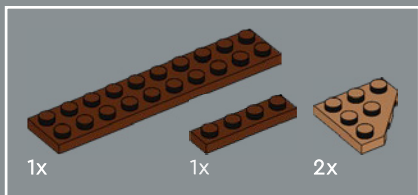
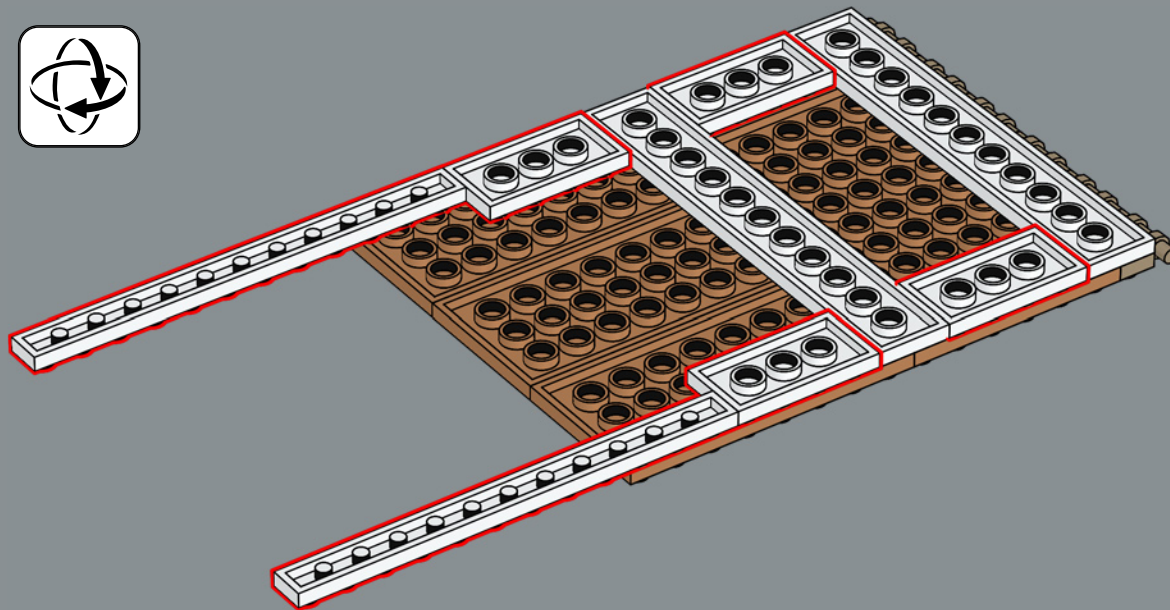

170

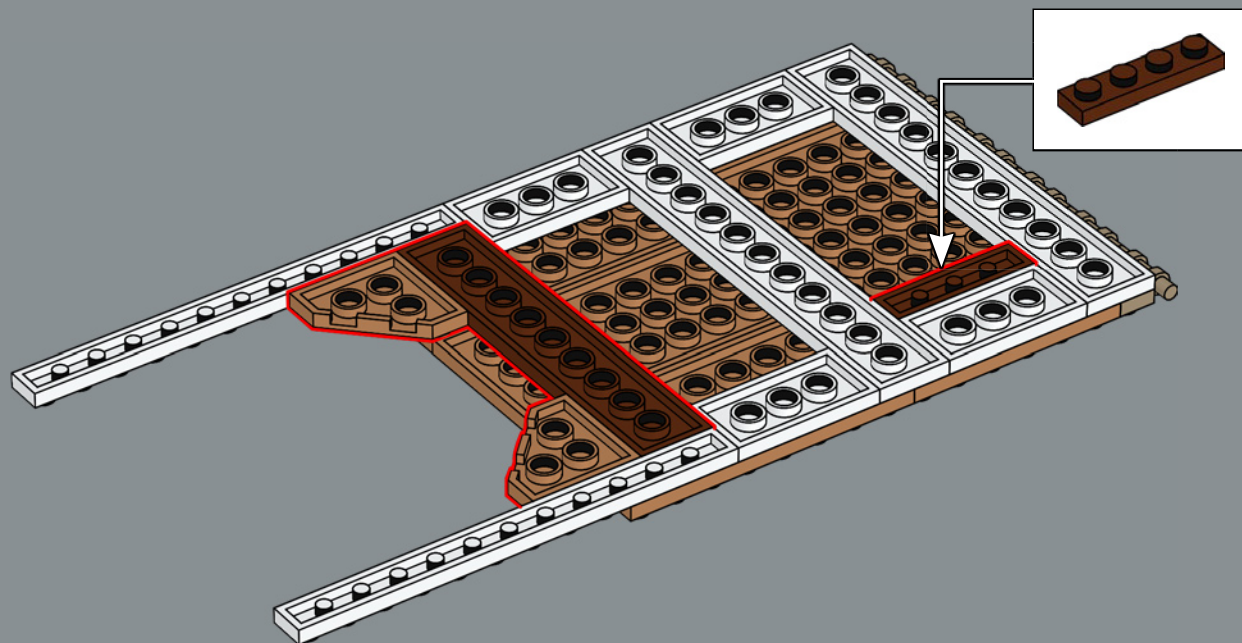

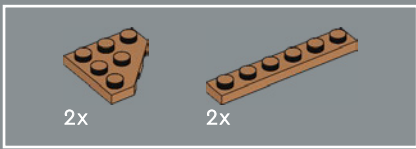

171

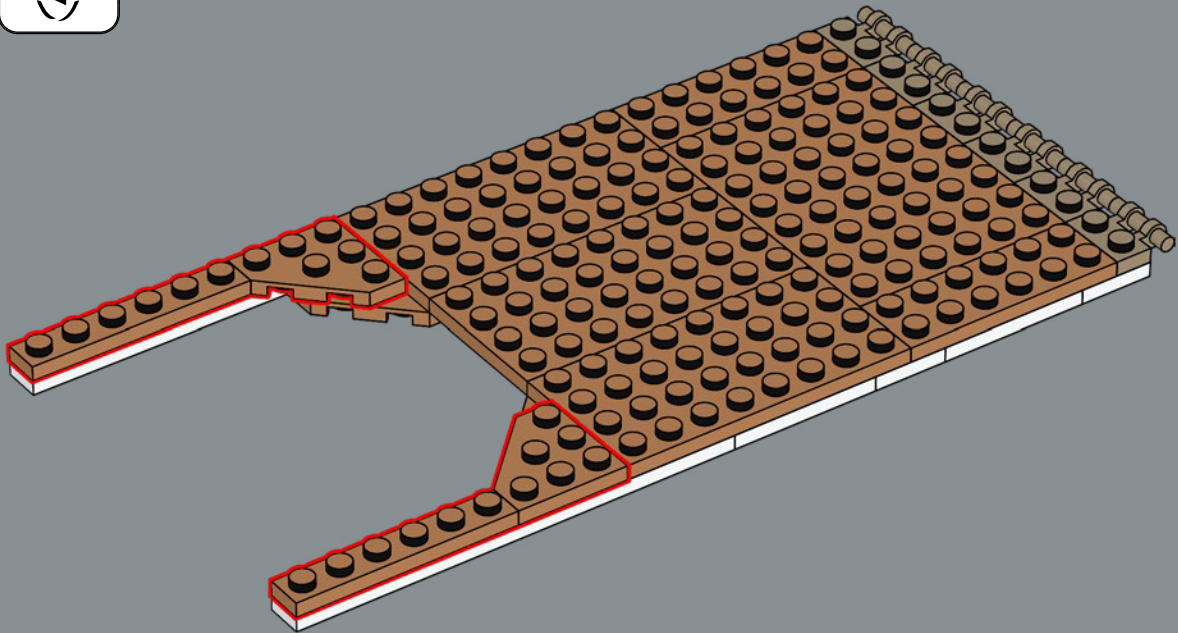



18x



172

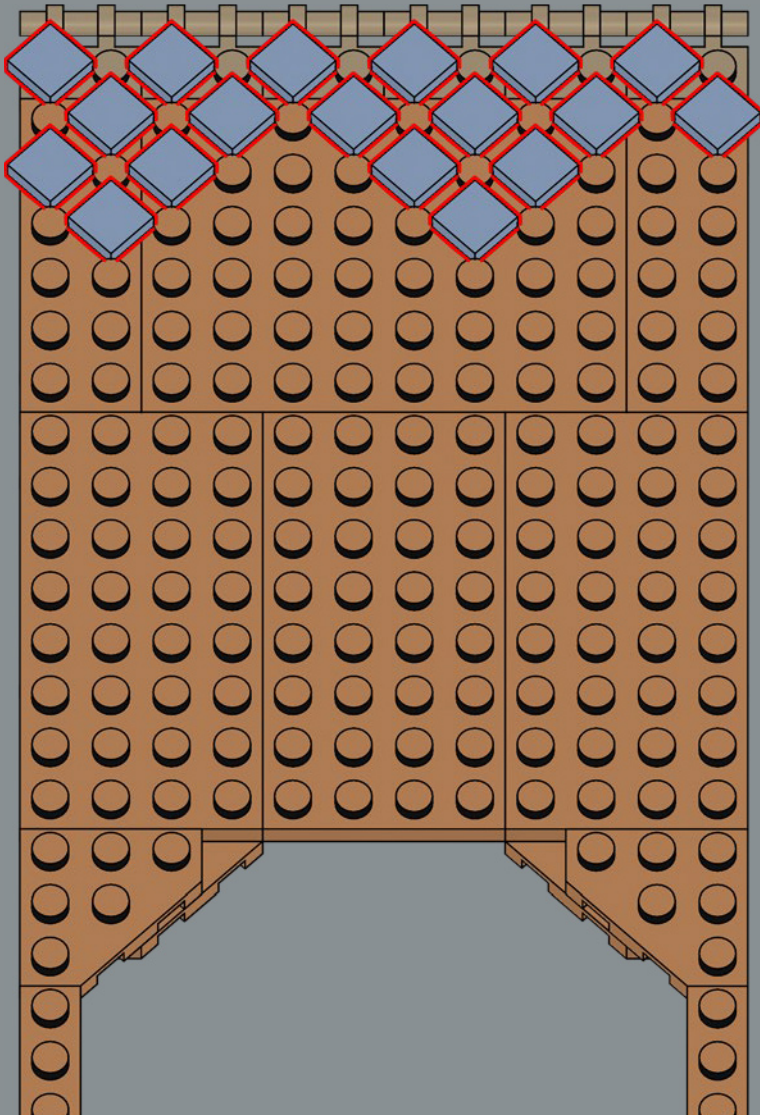

12x



8x

173

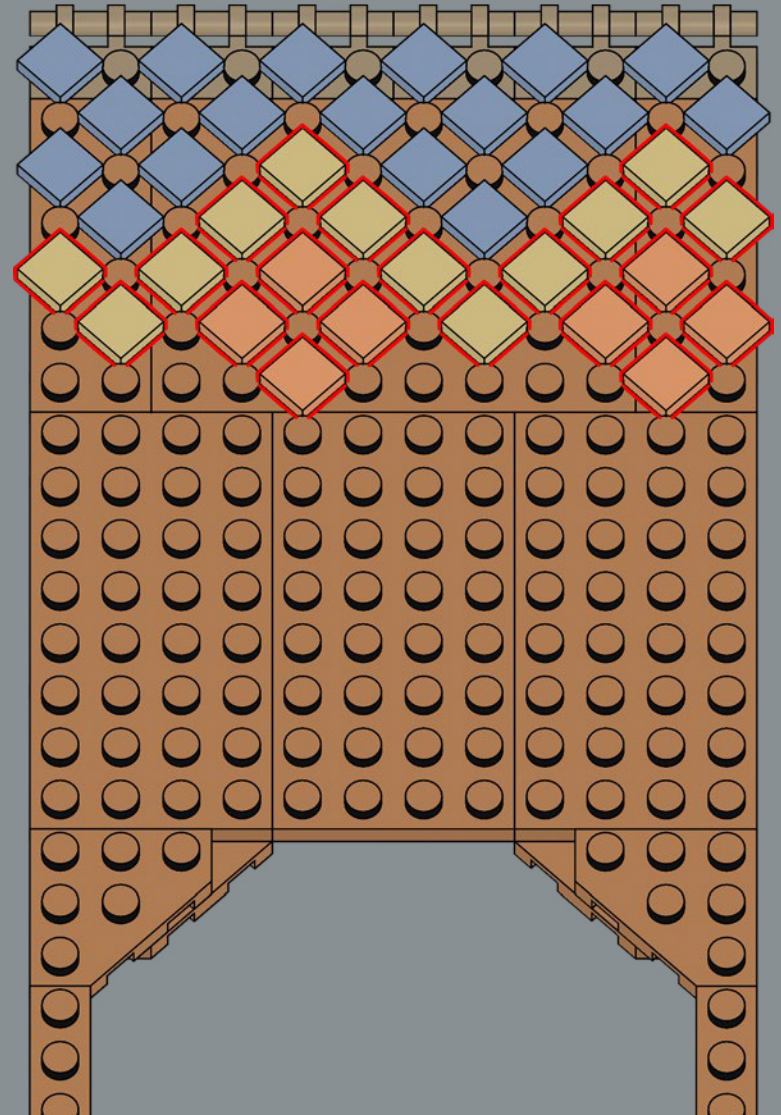

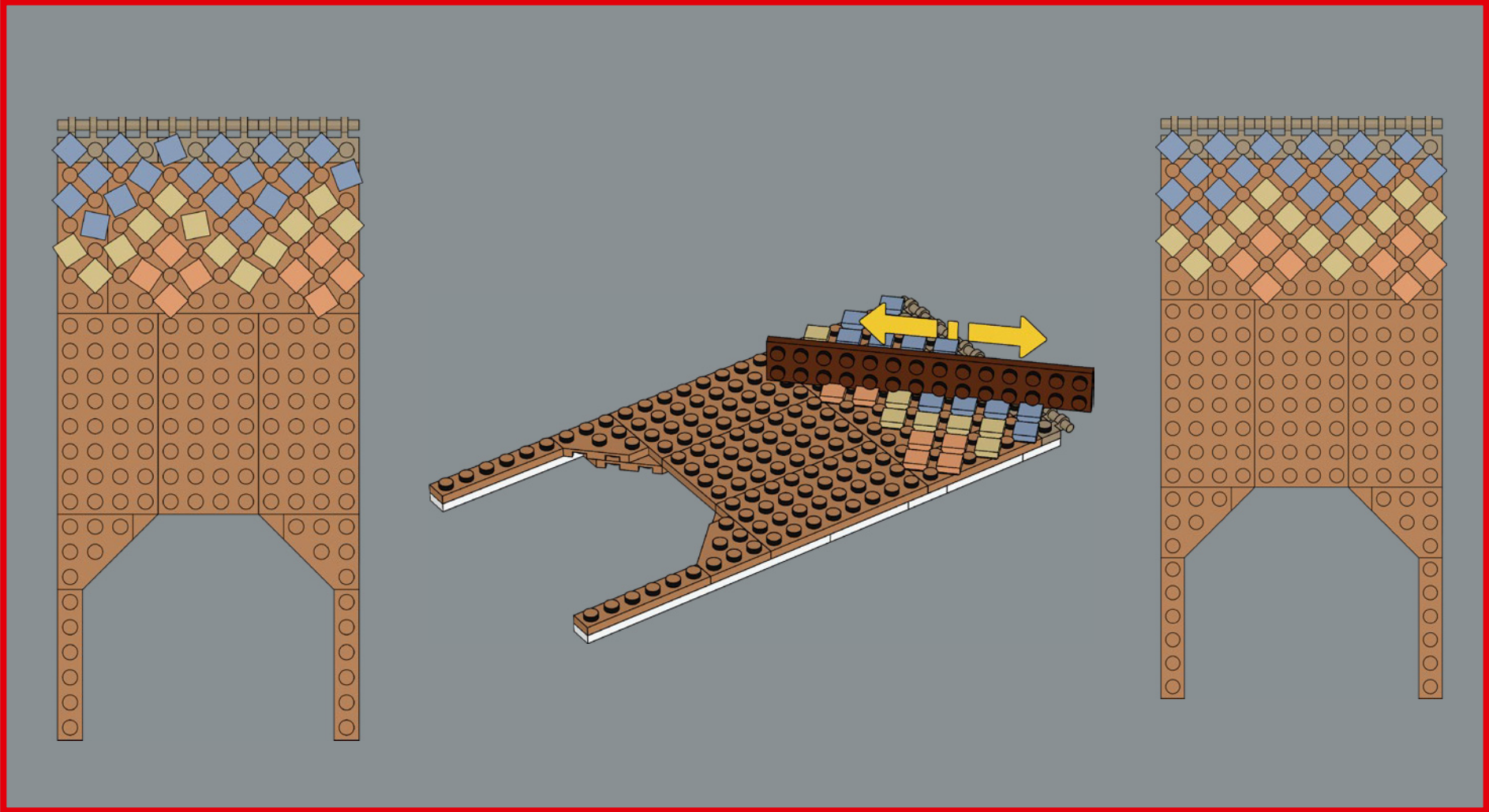



		
5x	6x	11x

176

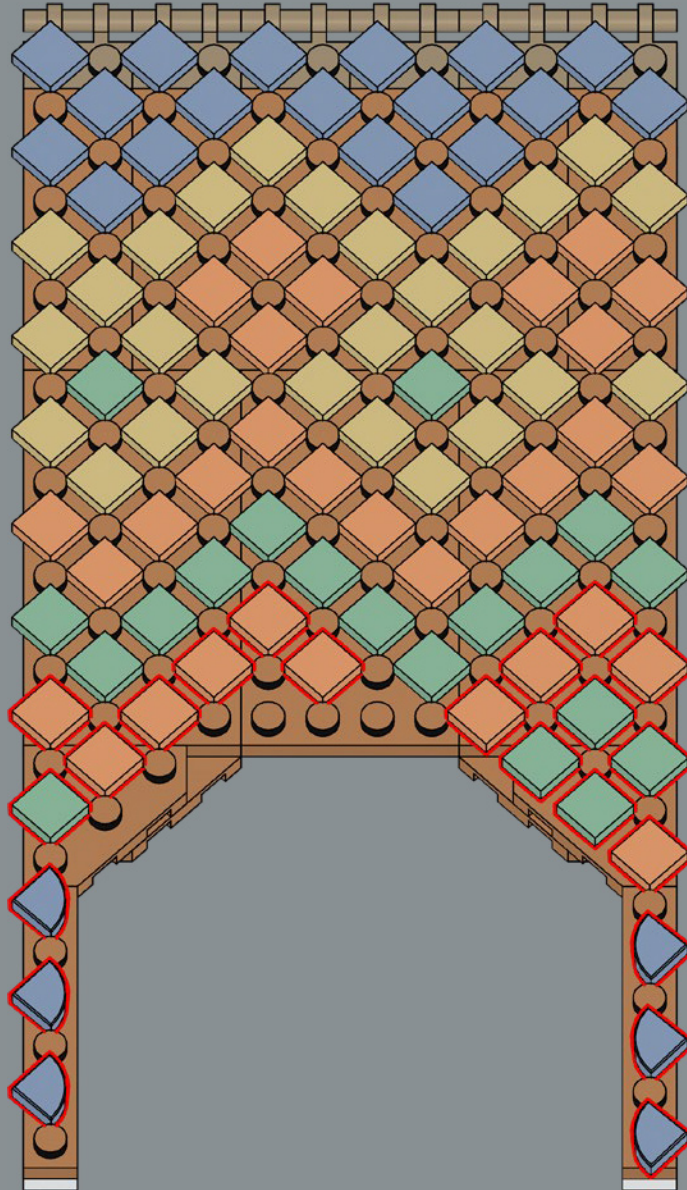

Jeder der 94 1x1 Dachziegel sollte in einem 45-Grad-Winkel befestigt werden. Wenn alle Teile an Ort und Stelle sind, lassen sie sich perfekt ausrichten, indem du eine lange Platte oder Kachel durch die Fugen ziehst.



6x

177

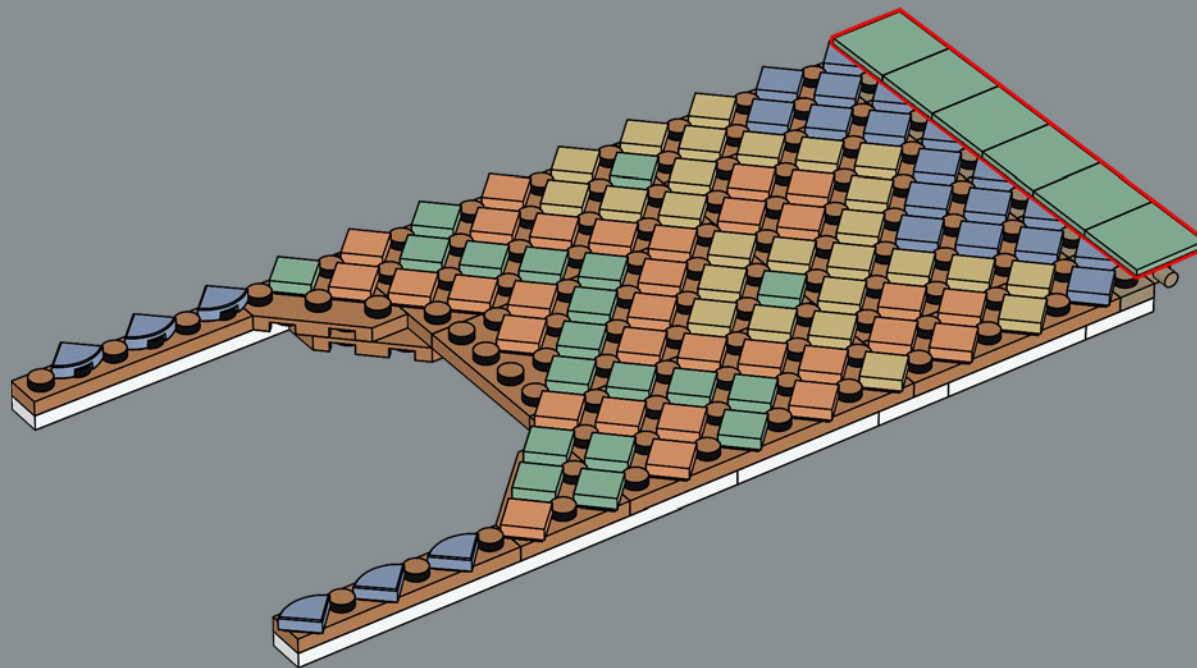

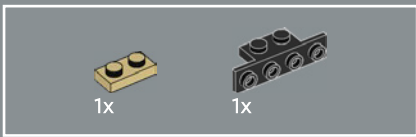

178

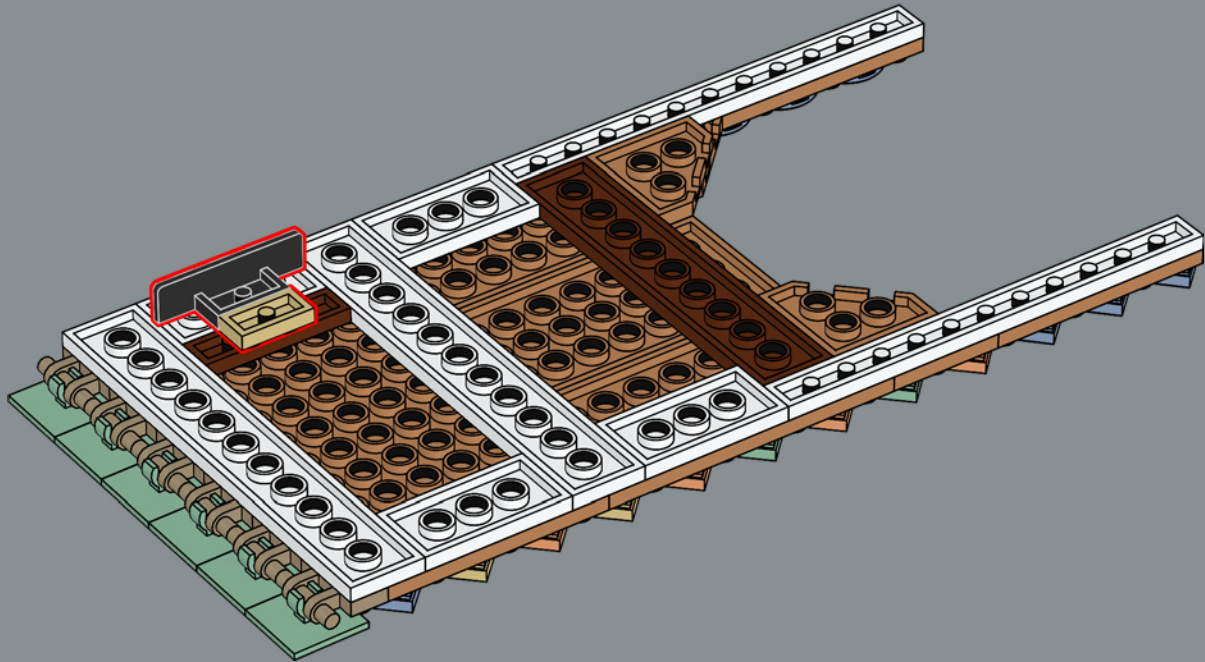



179

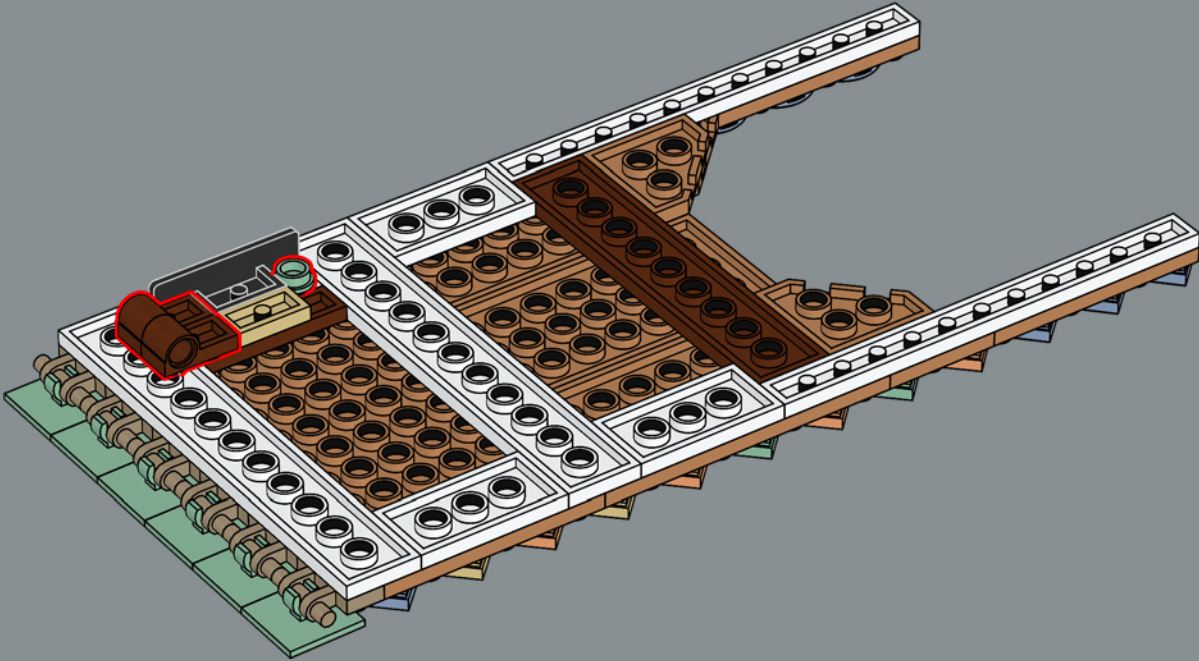

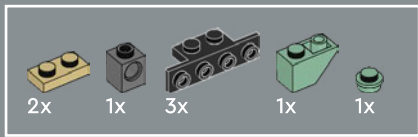

180

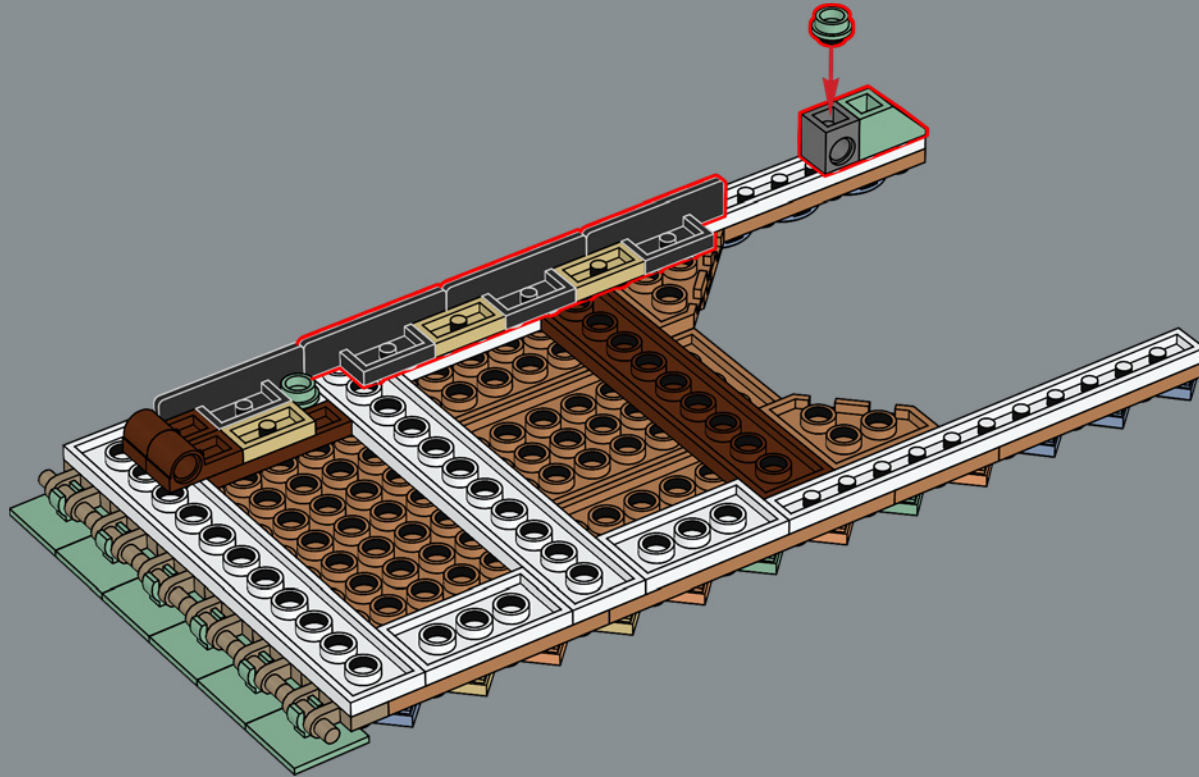

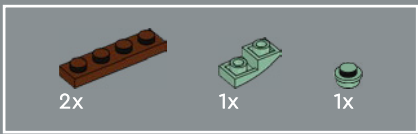

181

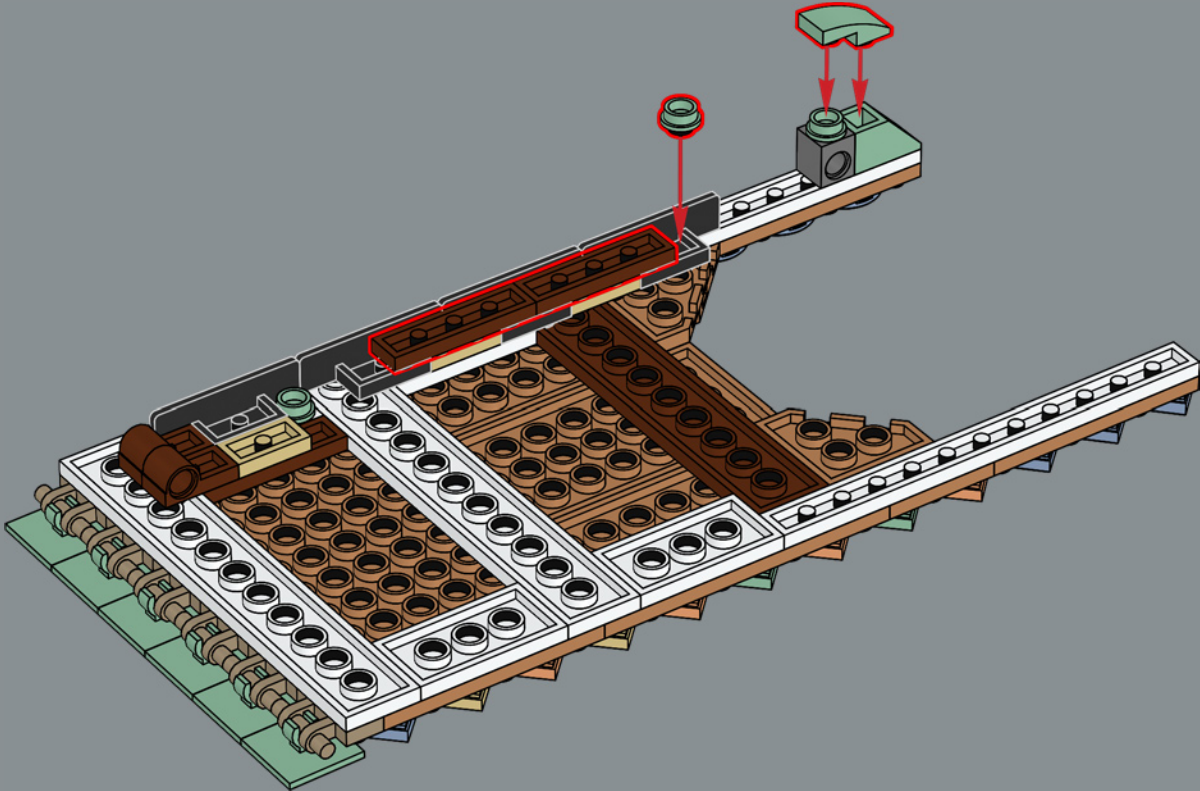

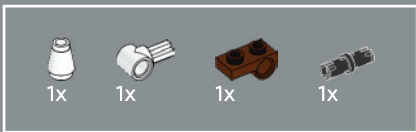

182

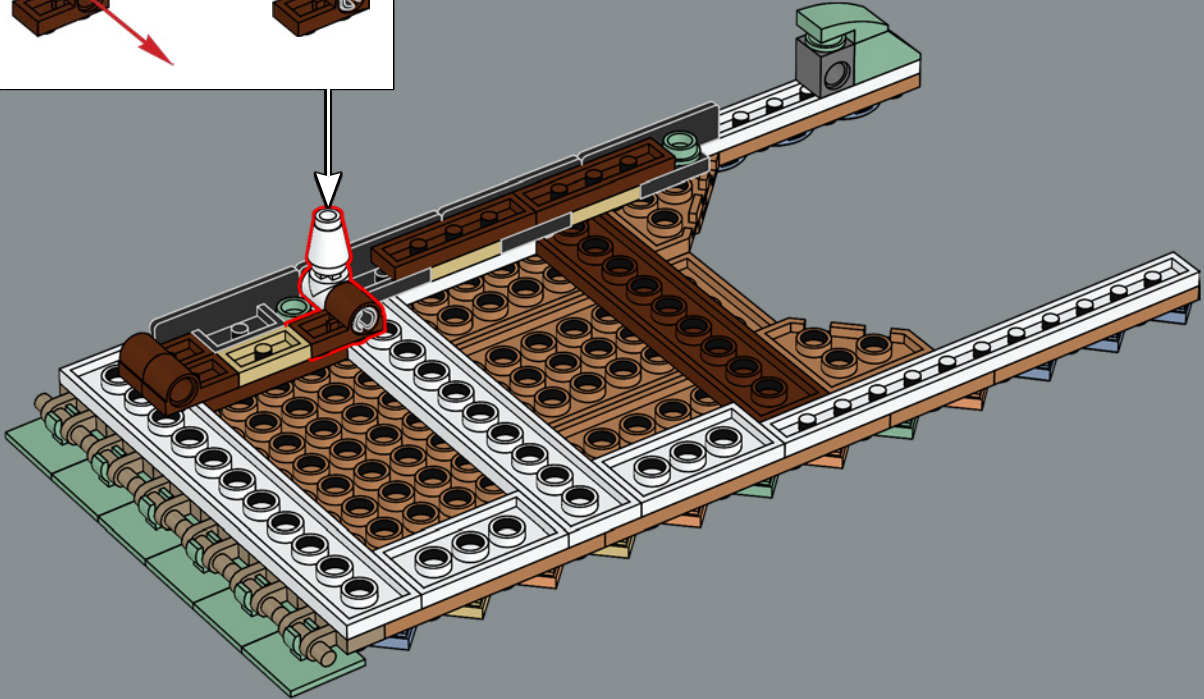
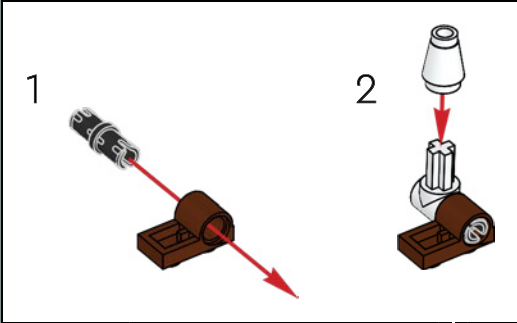

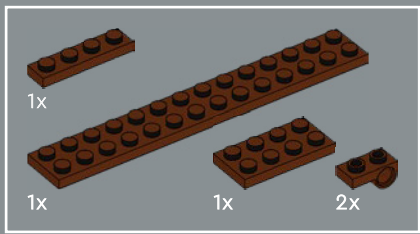

183

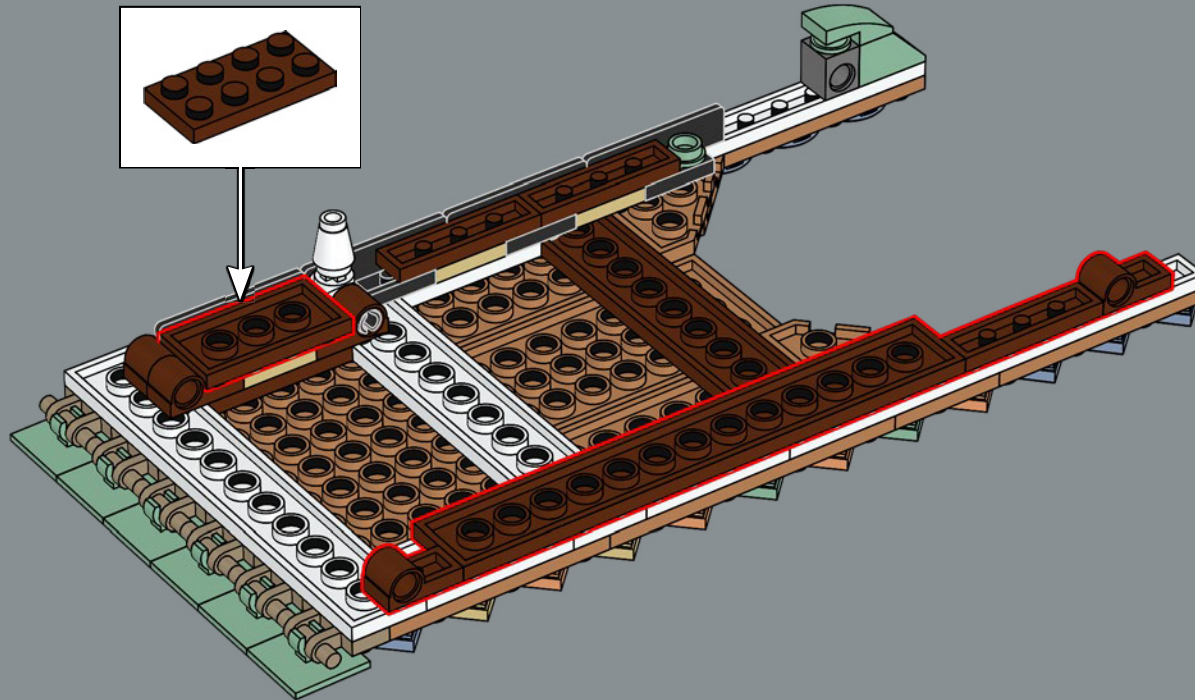

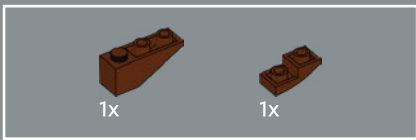

184

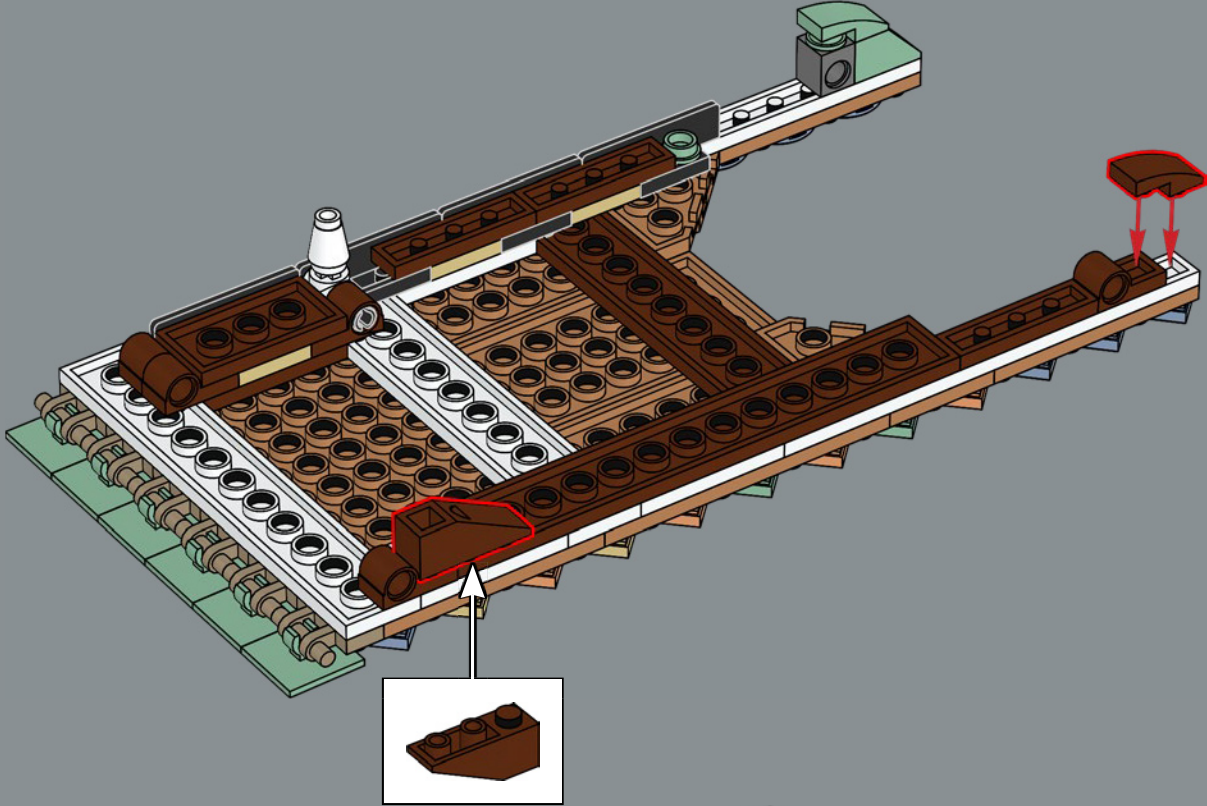

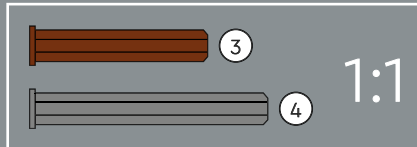
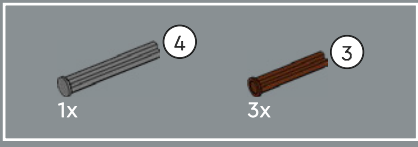

185

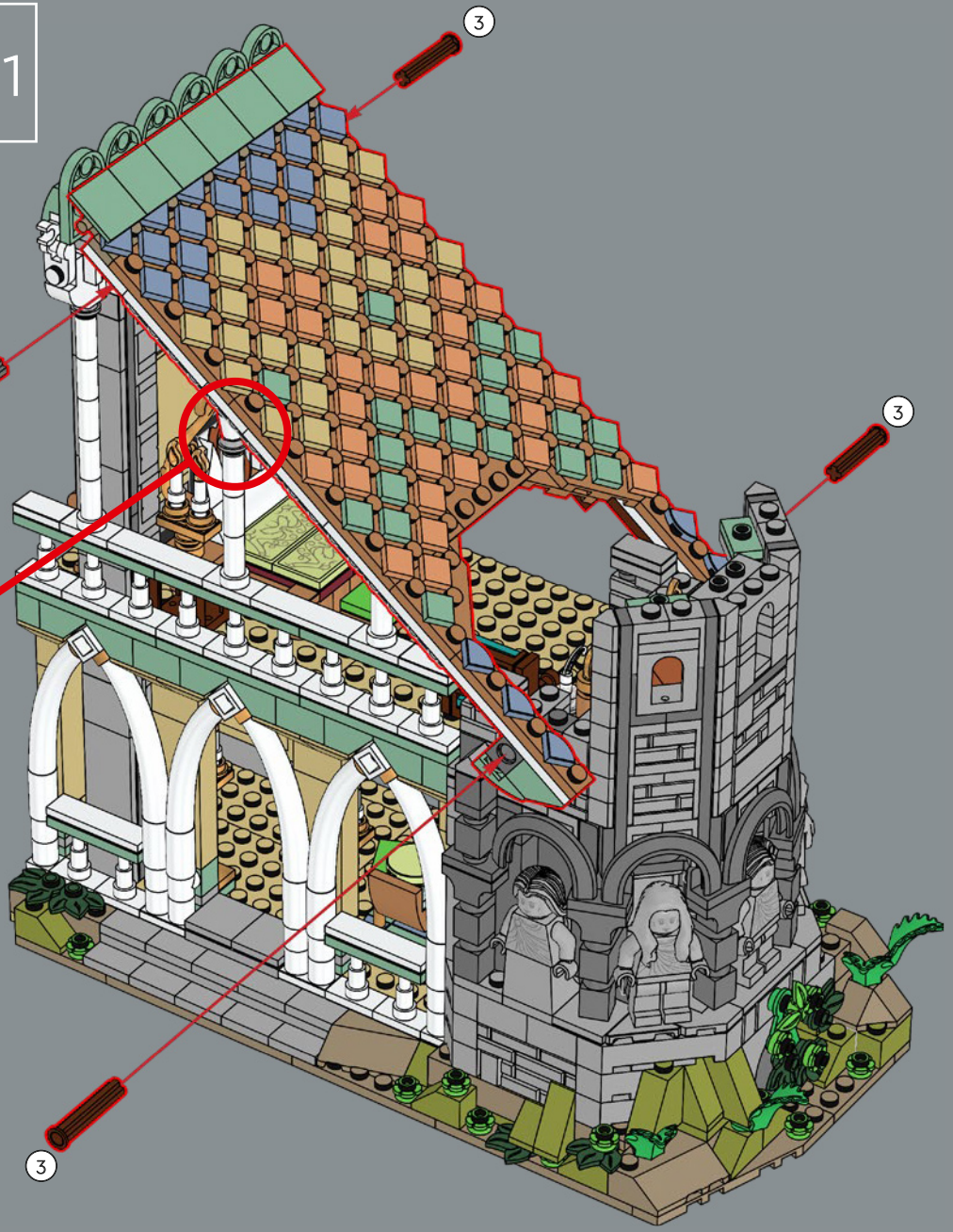
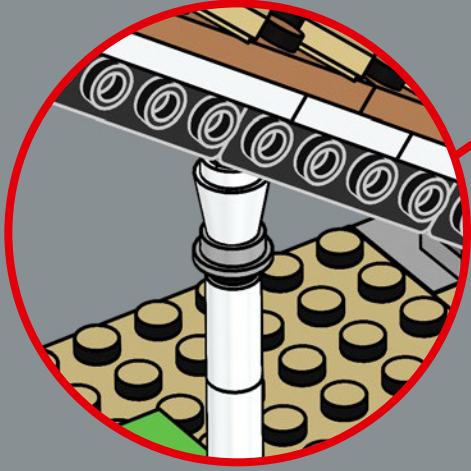
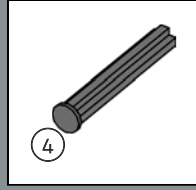

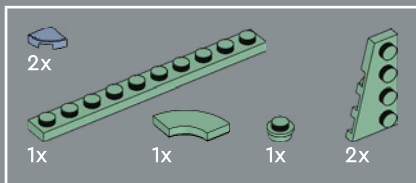

186

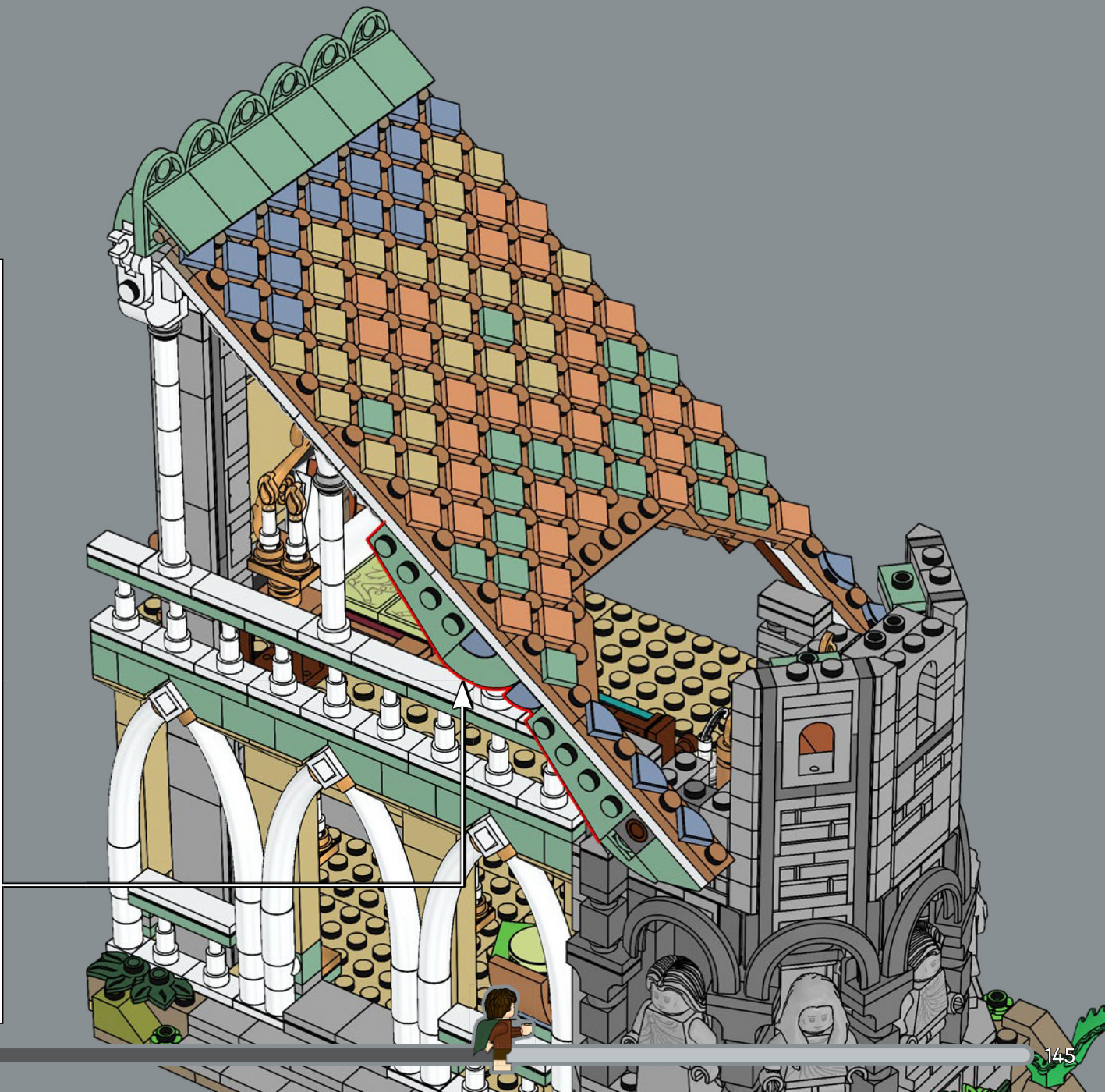
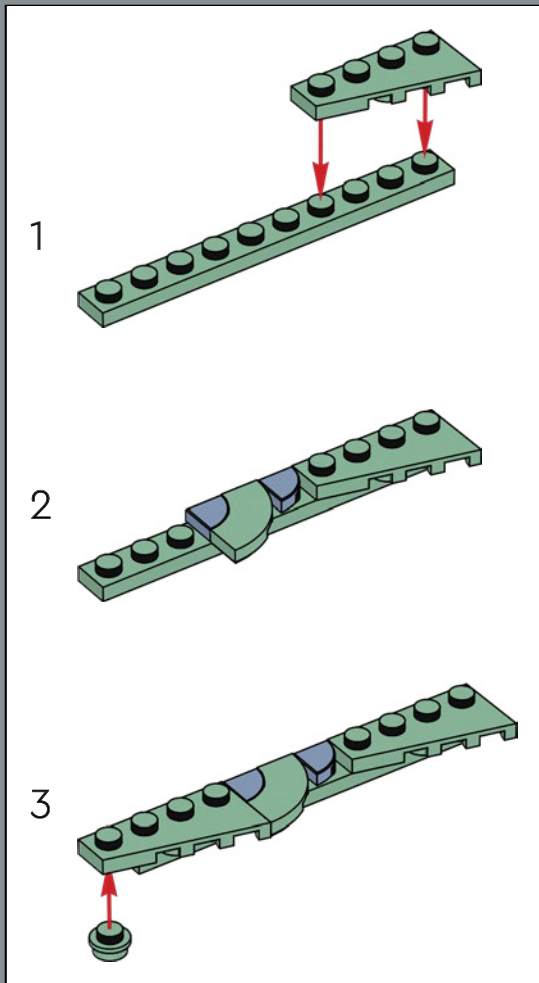

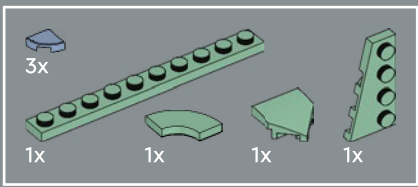

187

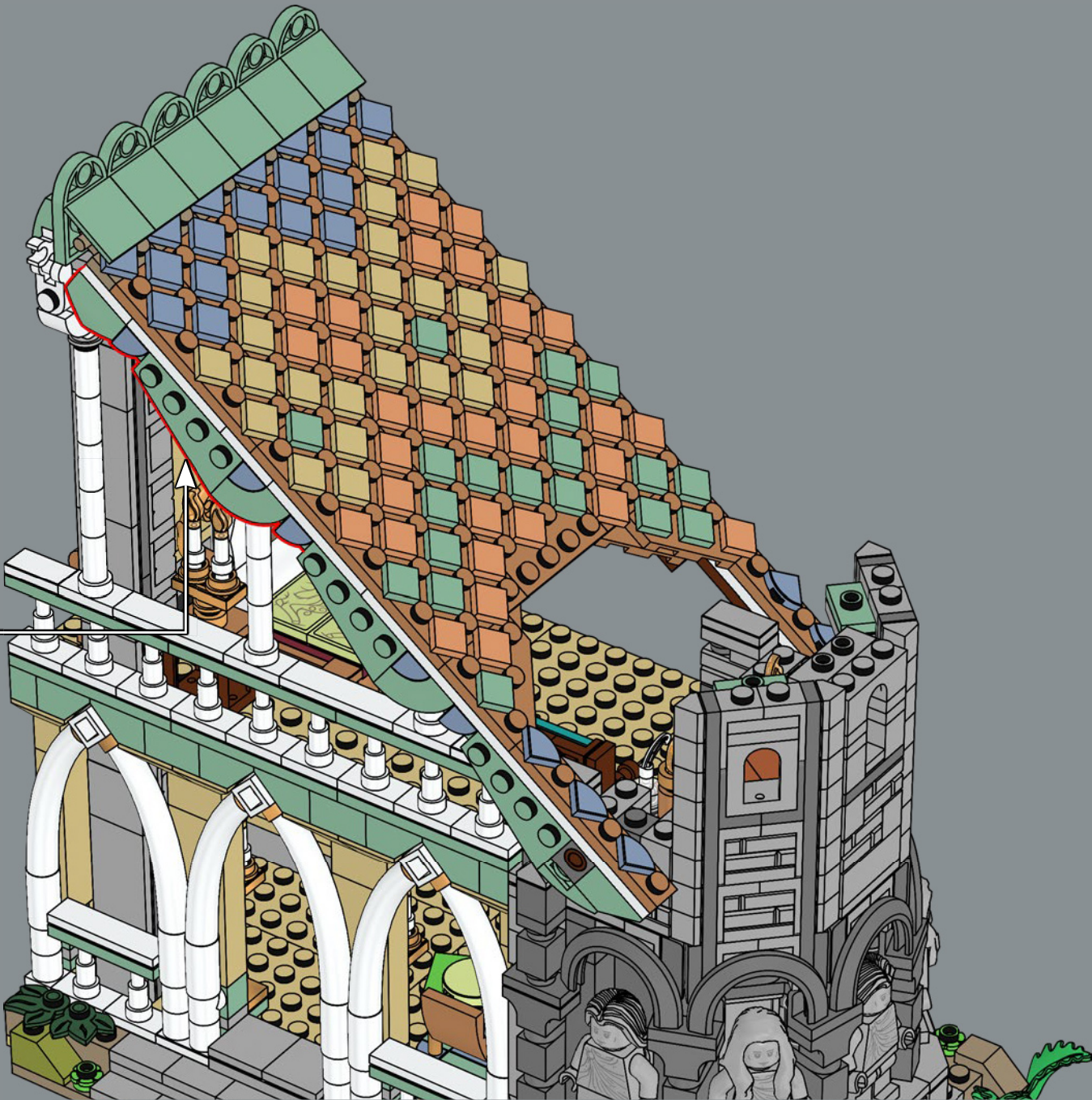
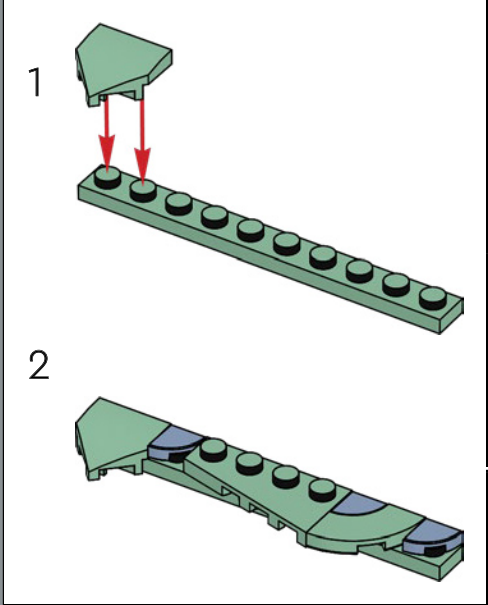

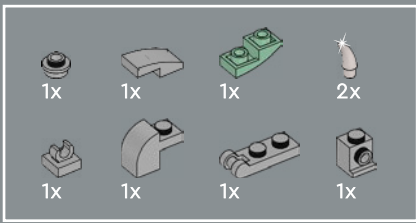

188

1

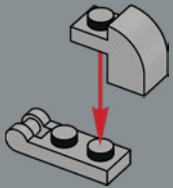

2

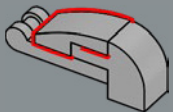

3

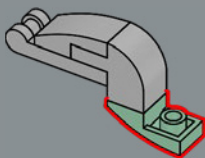

4

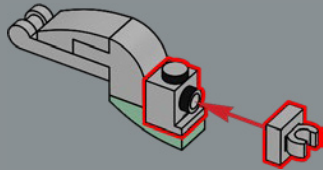

5

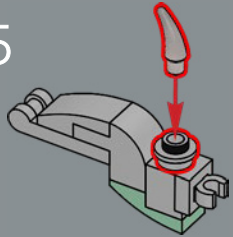

6

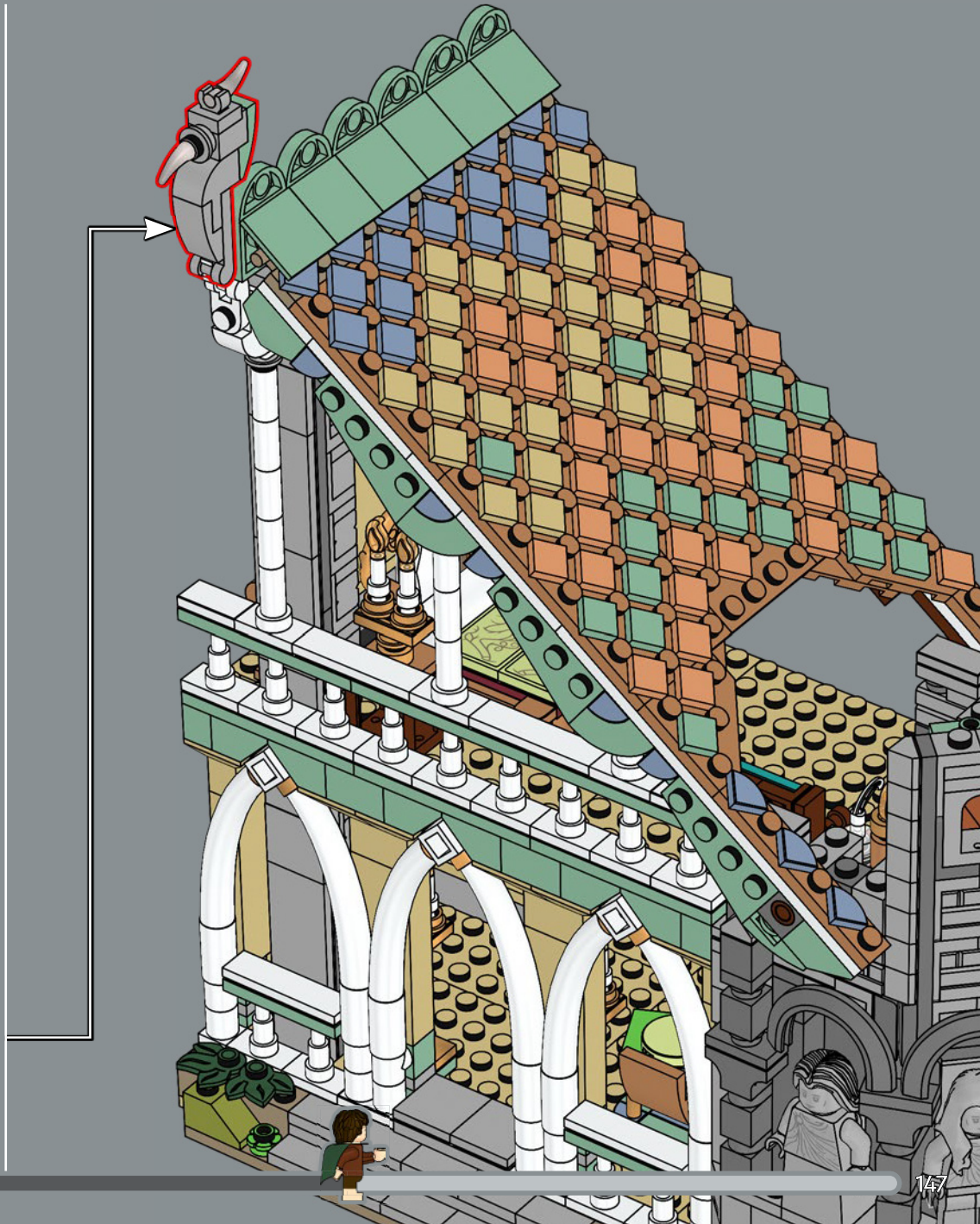
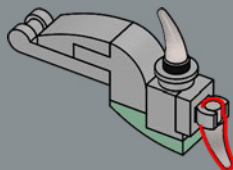

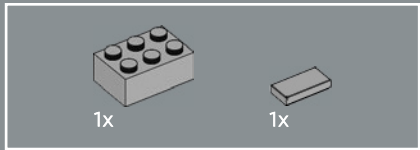

189

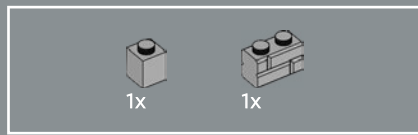
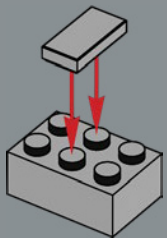

190

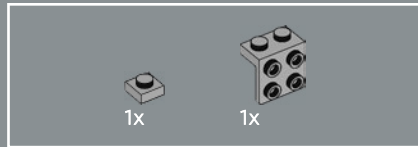
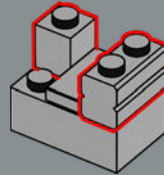

191

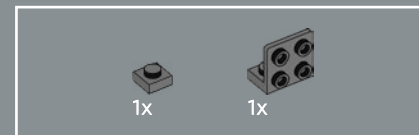
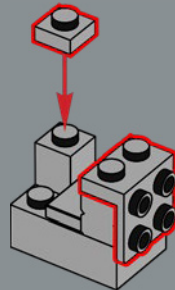

192

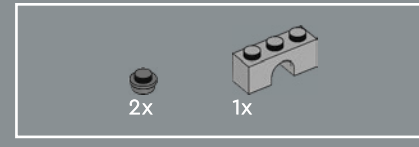
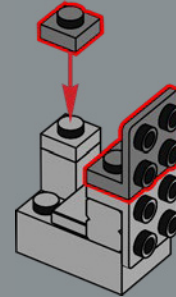

193

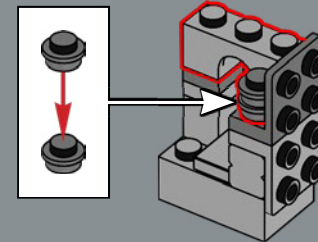

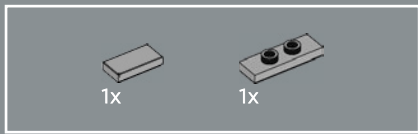

194

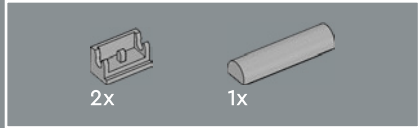
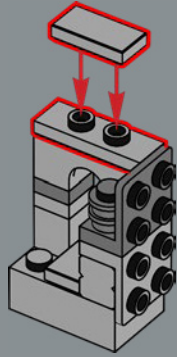

195

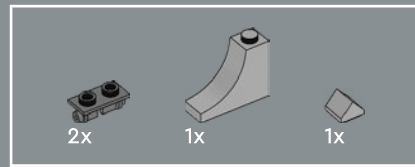
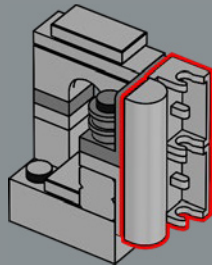

196

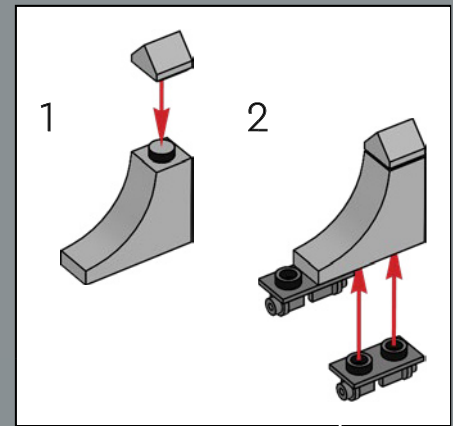
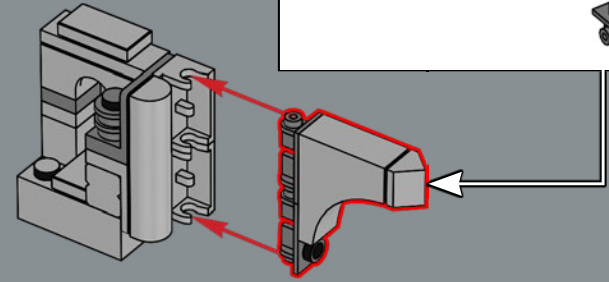

197

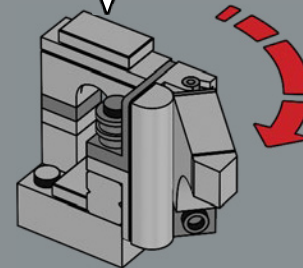



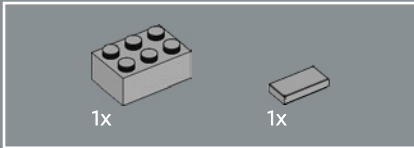
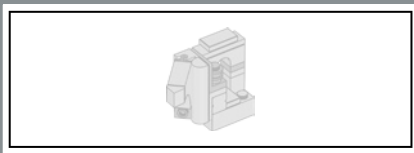

199

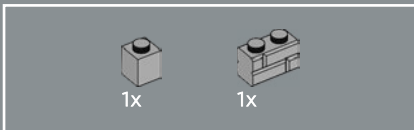
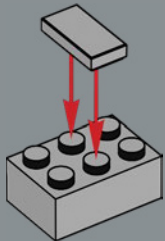

200

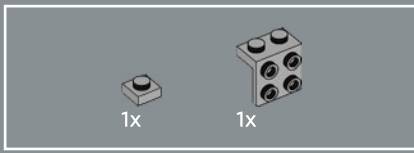
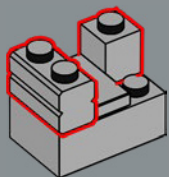

201

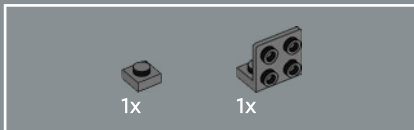
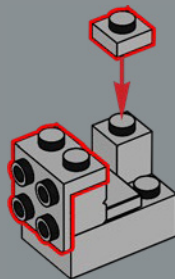

202

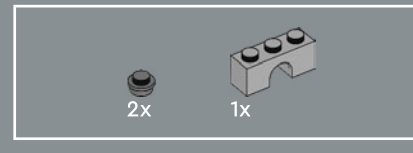
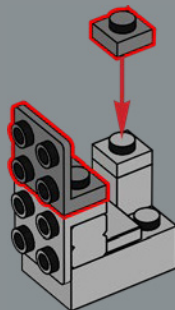

203

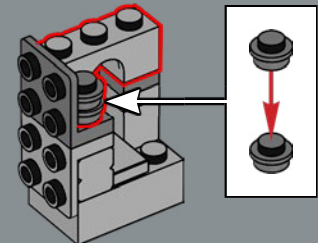

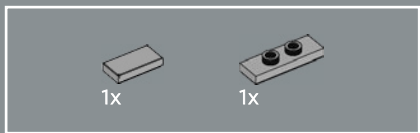

204

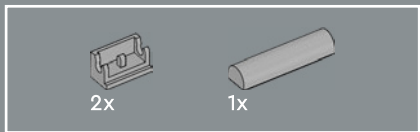
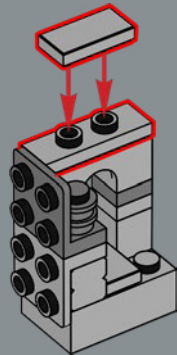

205

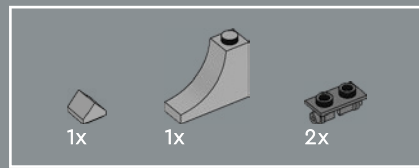
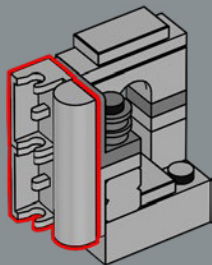

206

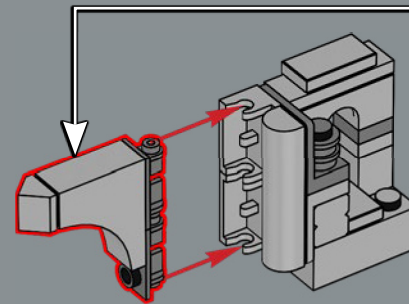
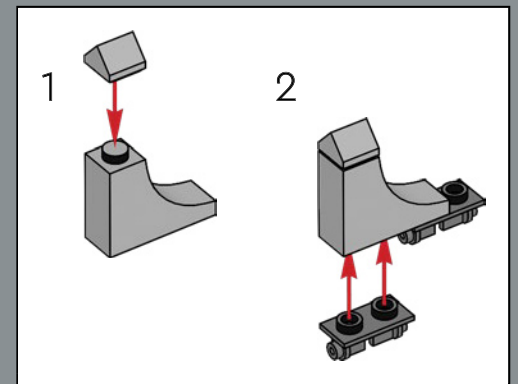

207

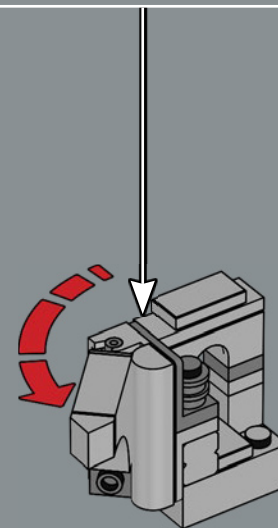

208

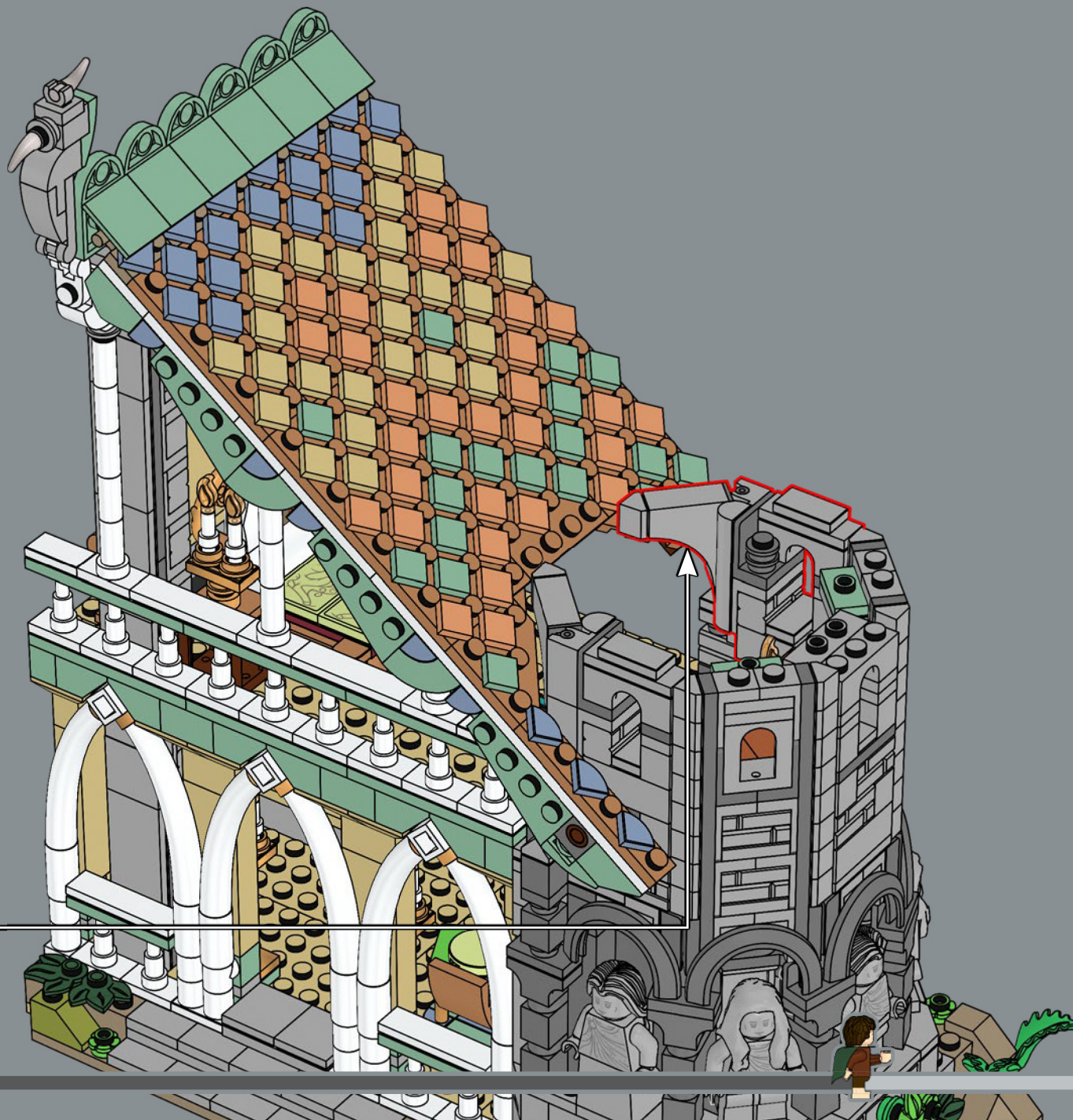

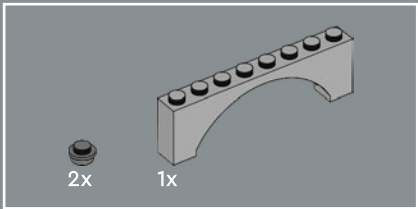

209

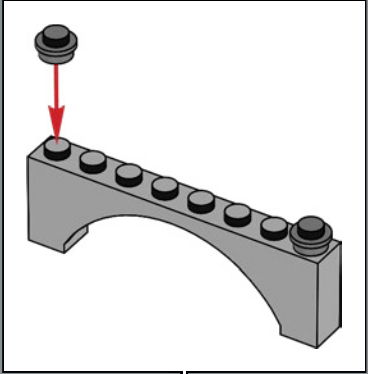
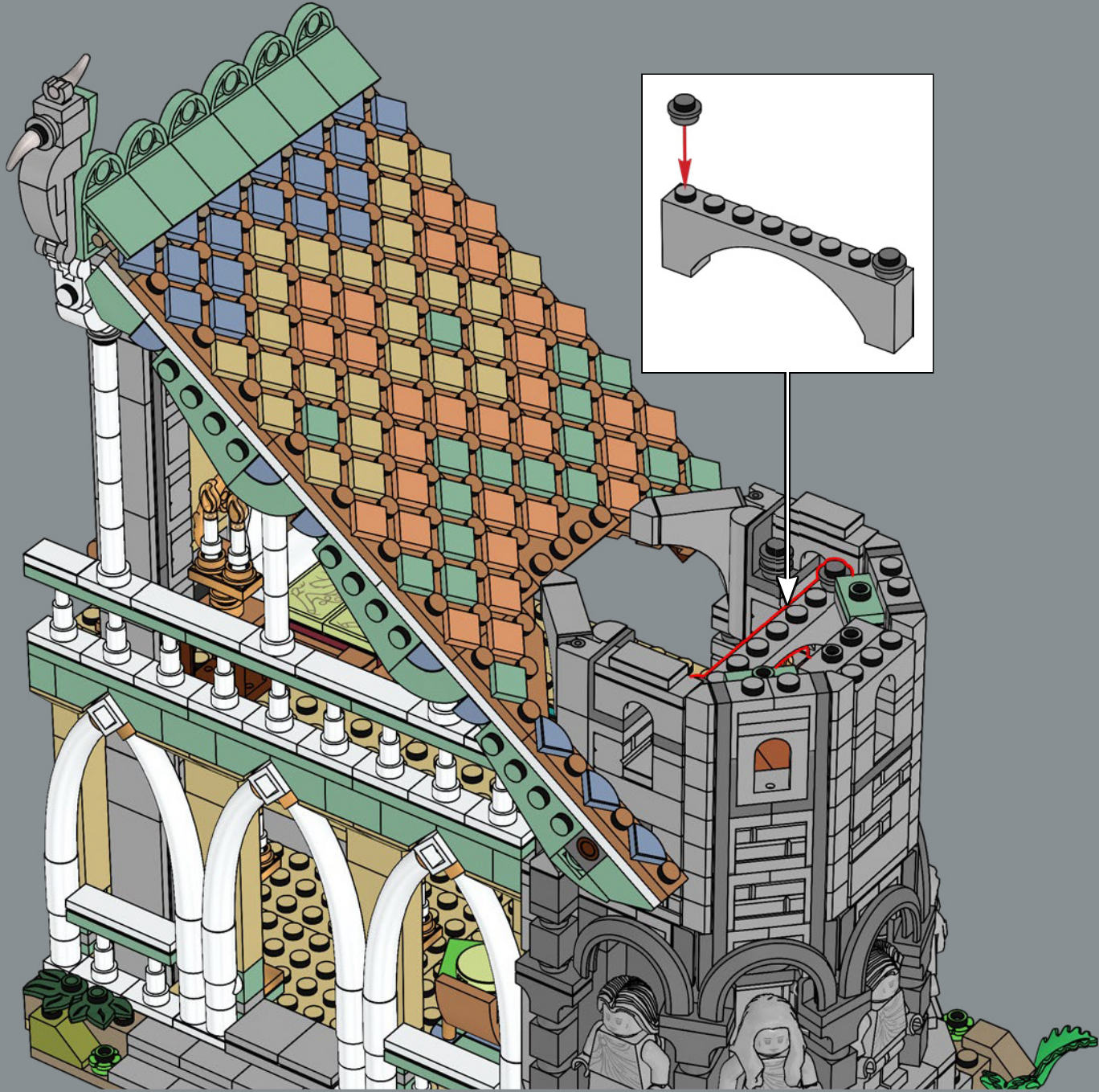

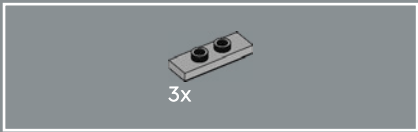

210

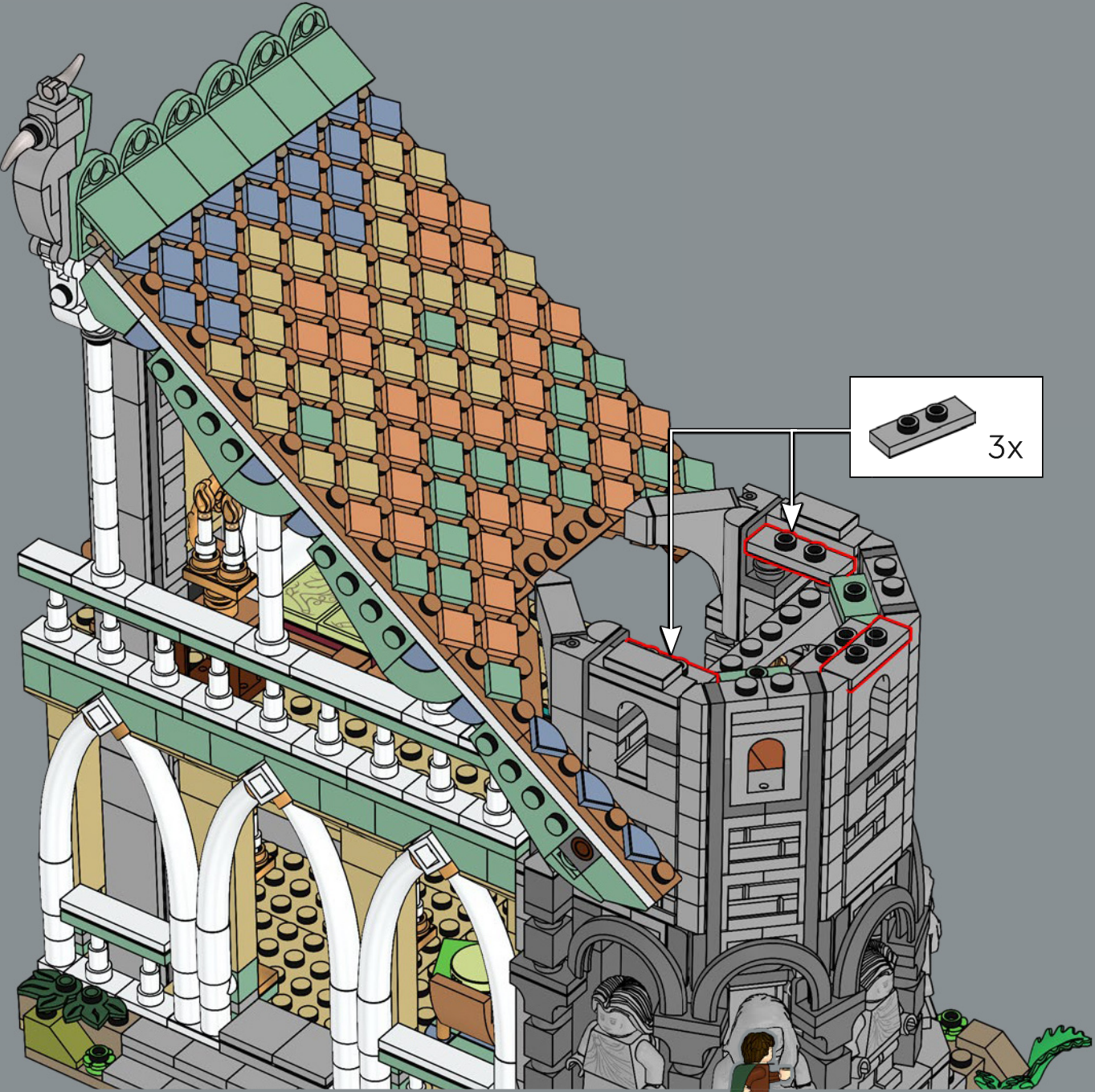



211

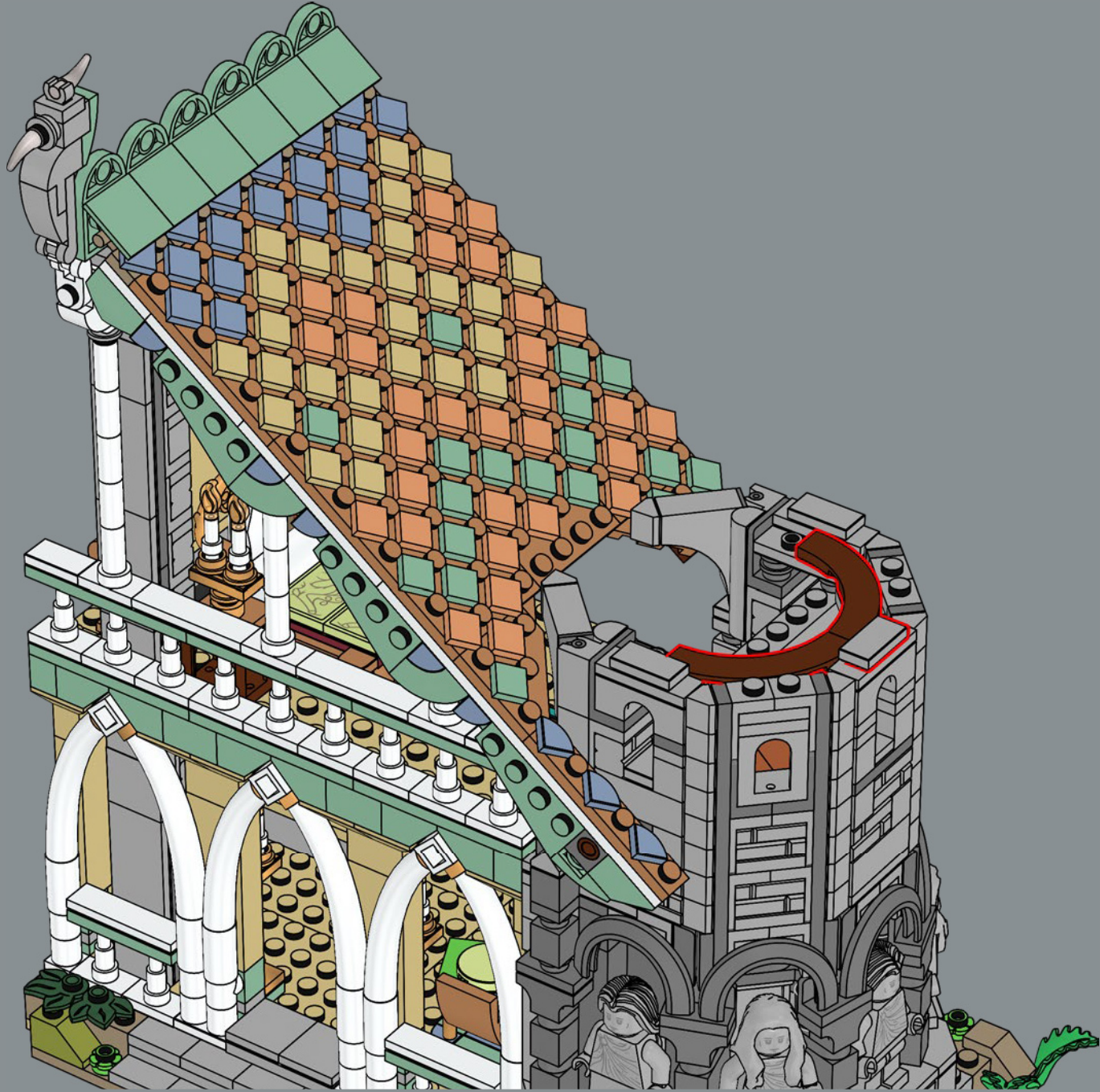

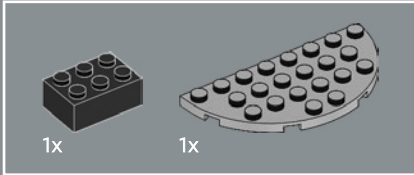
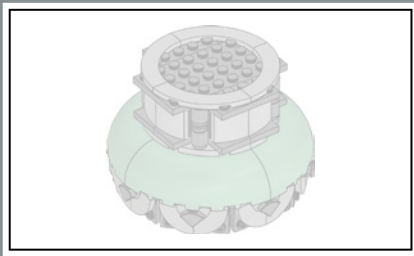

212

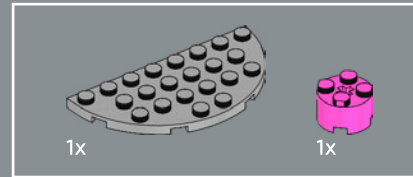
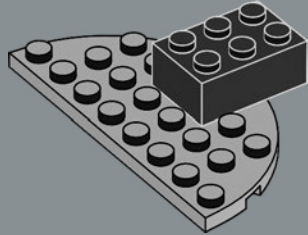

213

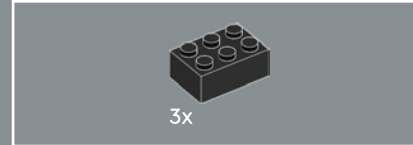
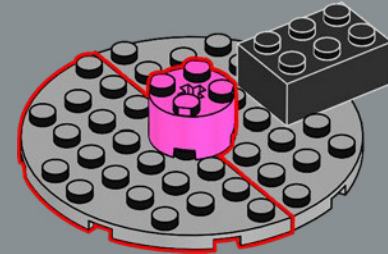

214

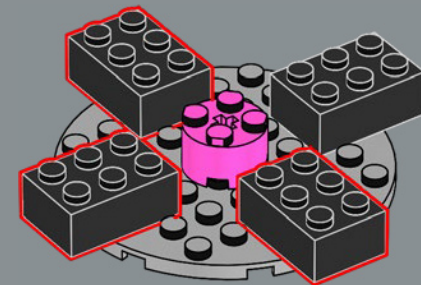

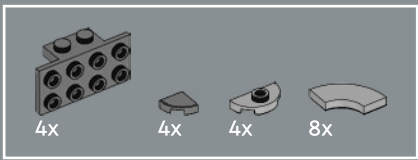

215

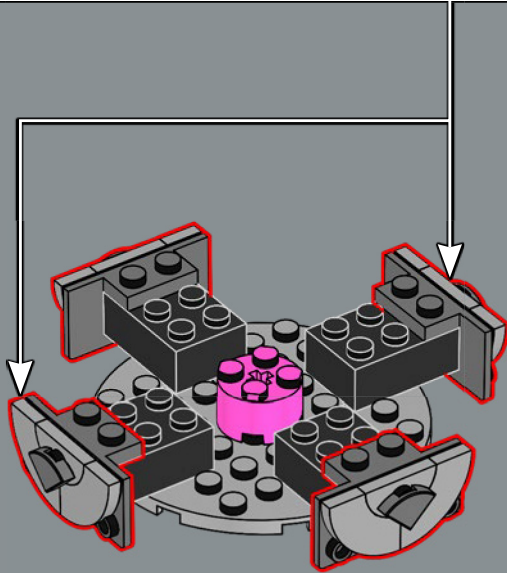
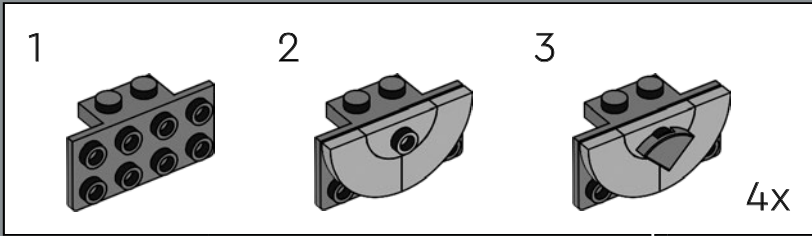

216

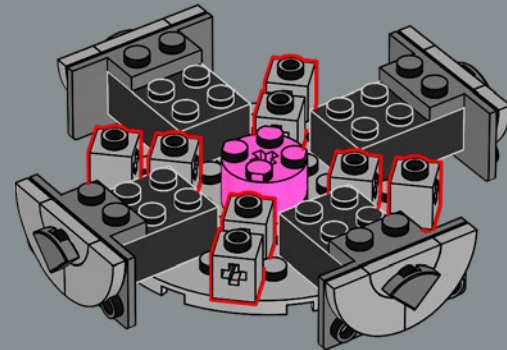

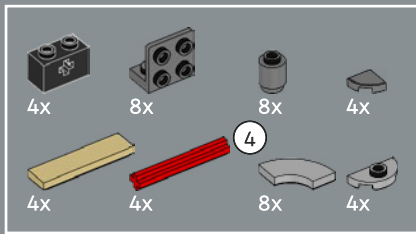

217

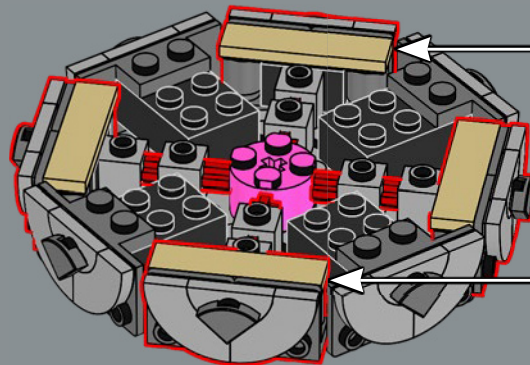
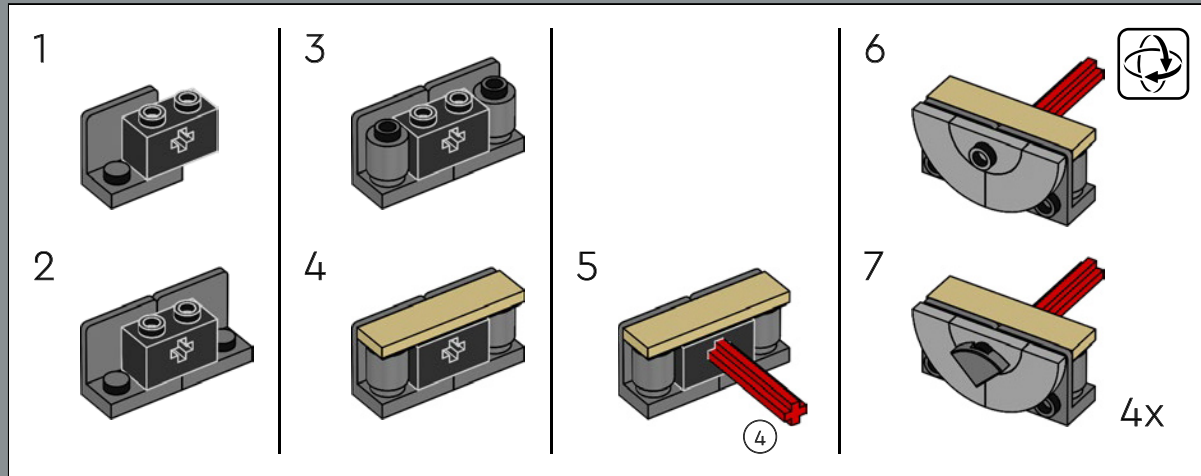

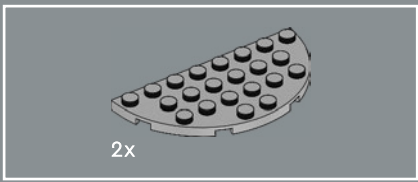

218

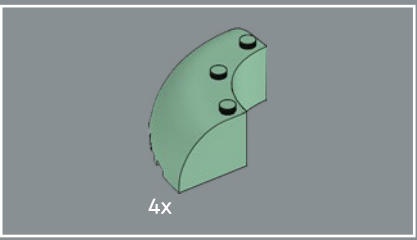
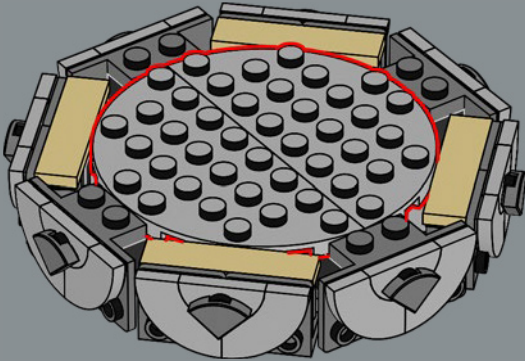

219

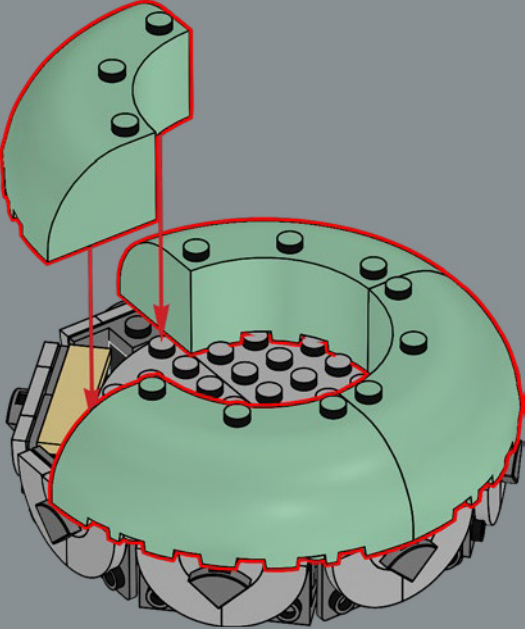

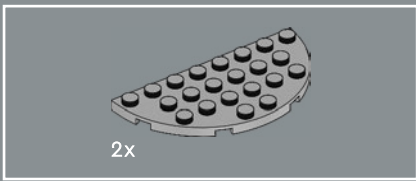

220

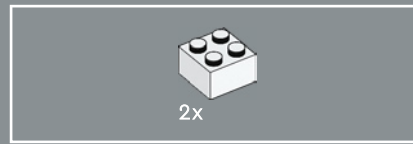
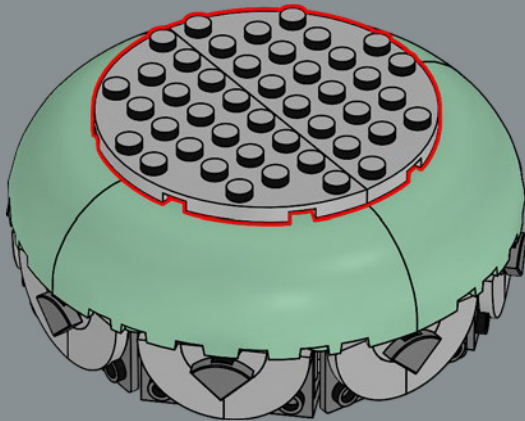

221

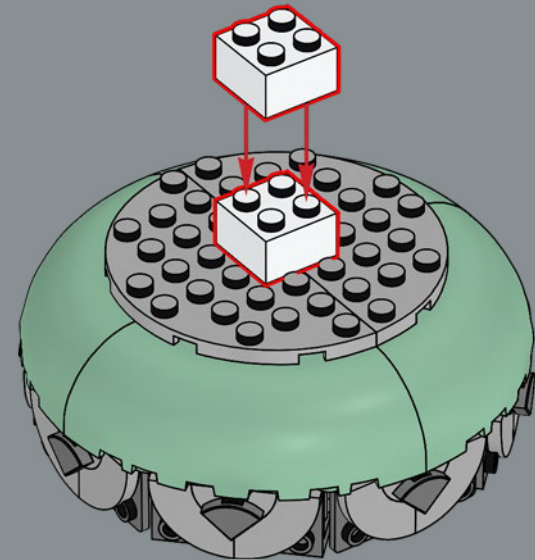

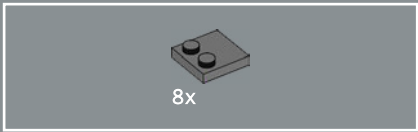

222

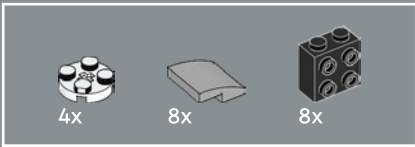
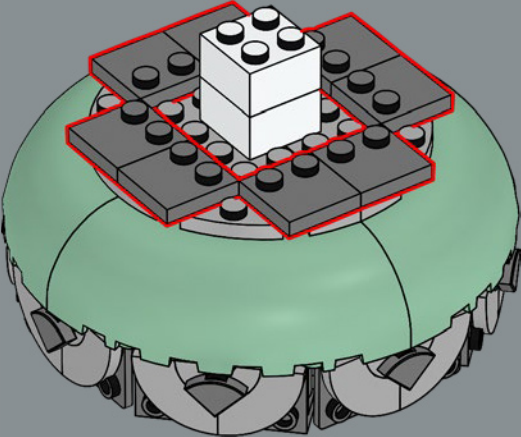

223

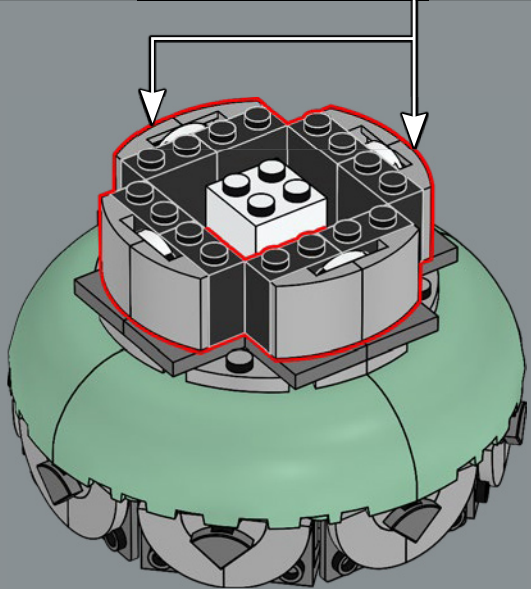
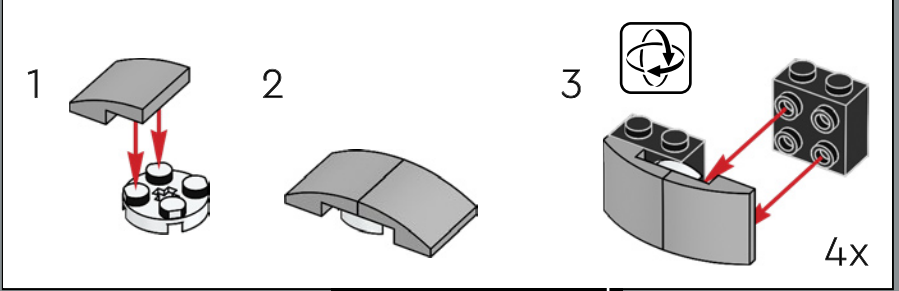

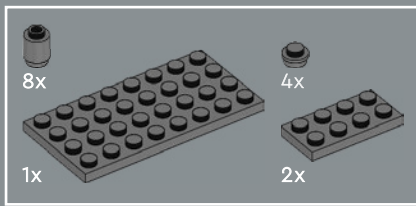

224

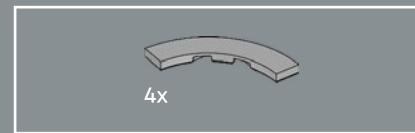
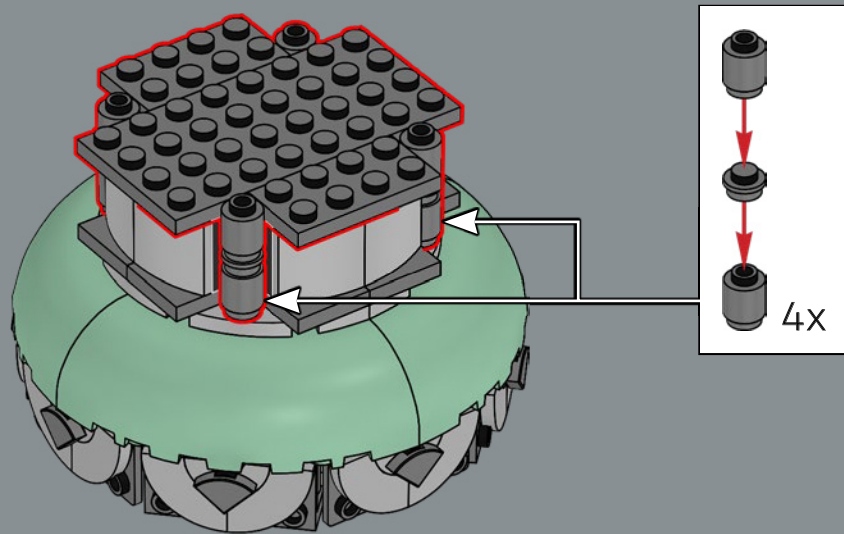

225

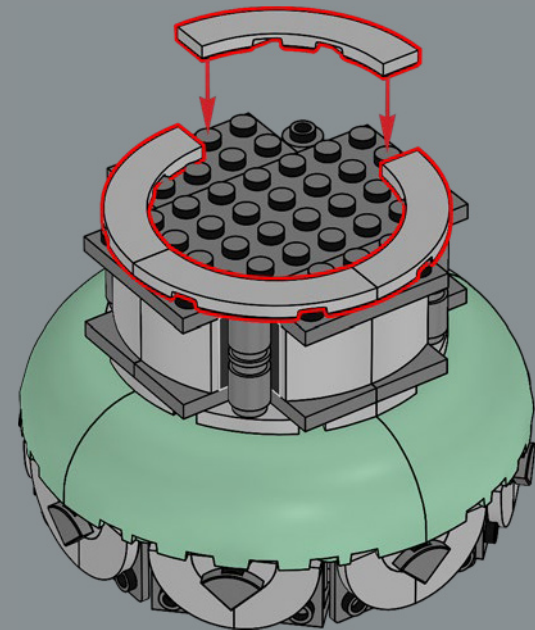



Das Turmdach lässt sich abnehmen, damit du Bilbos Fortschritte mit seinem Buch verfolgen kannst.

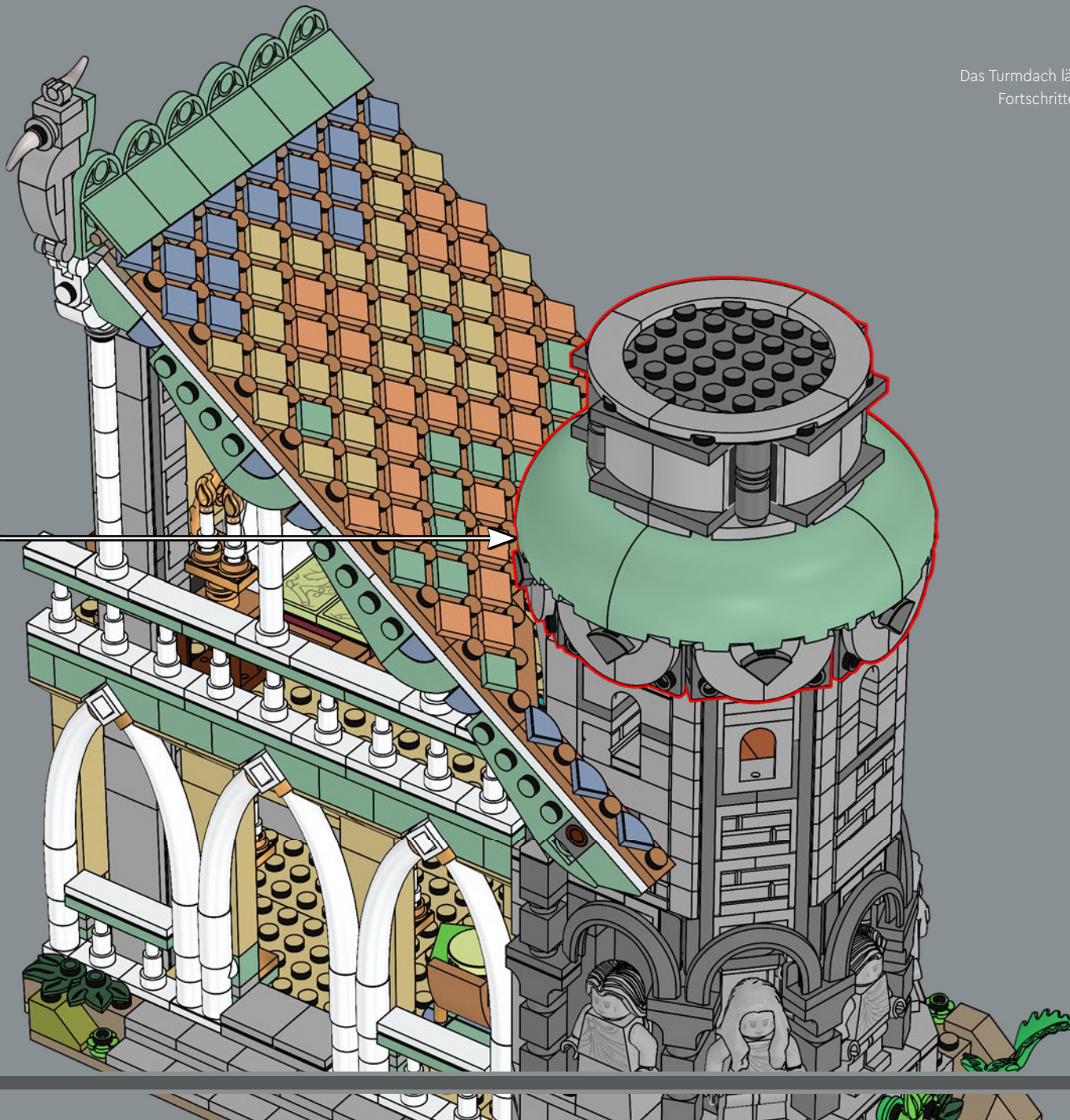



4x

231

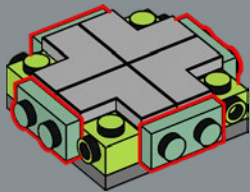

4x



8x



8x



4x

232

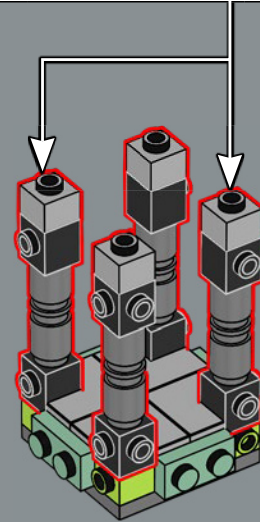
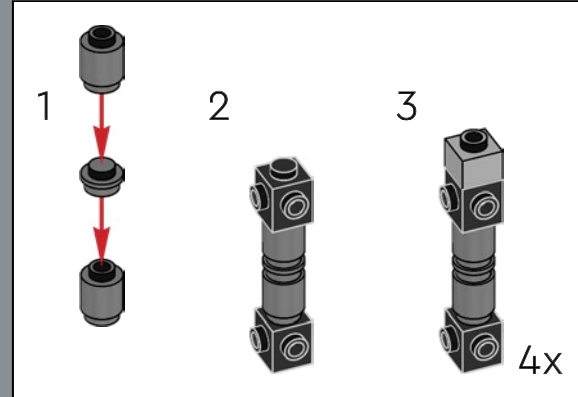

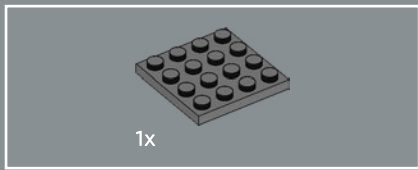

233

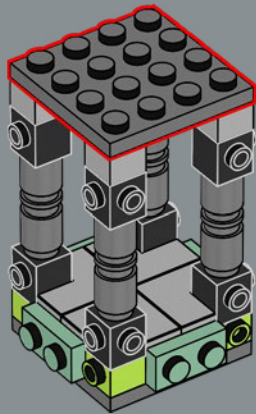

234

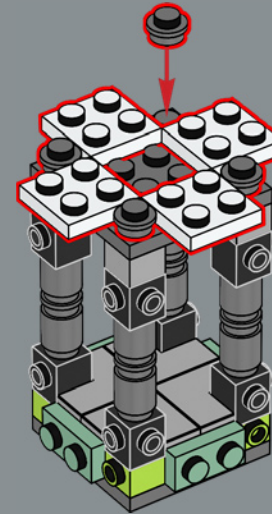

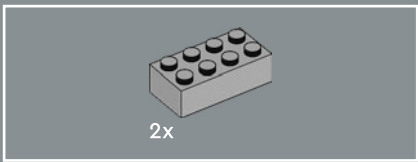

235

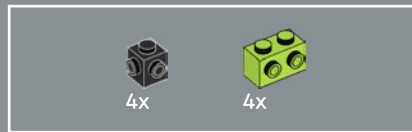
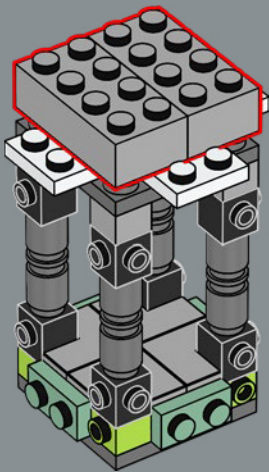

236

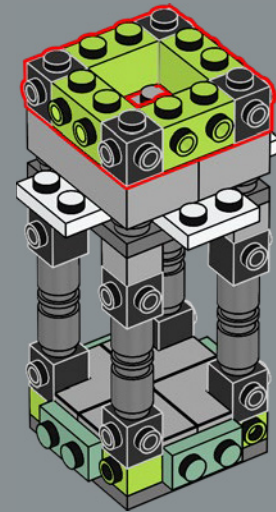

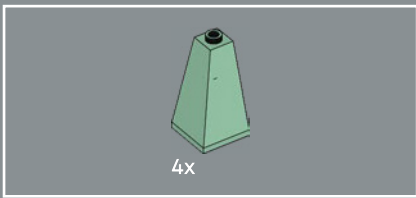

237

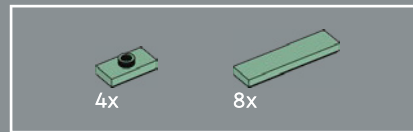
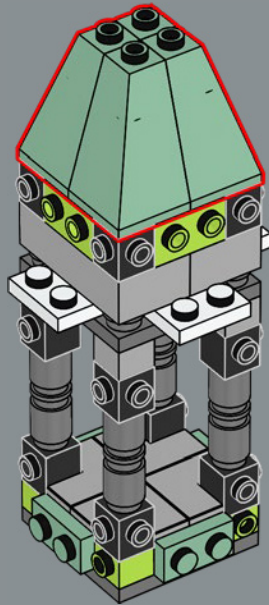

238

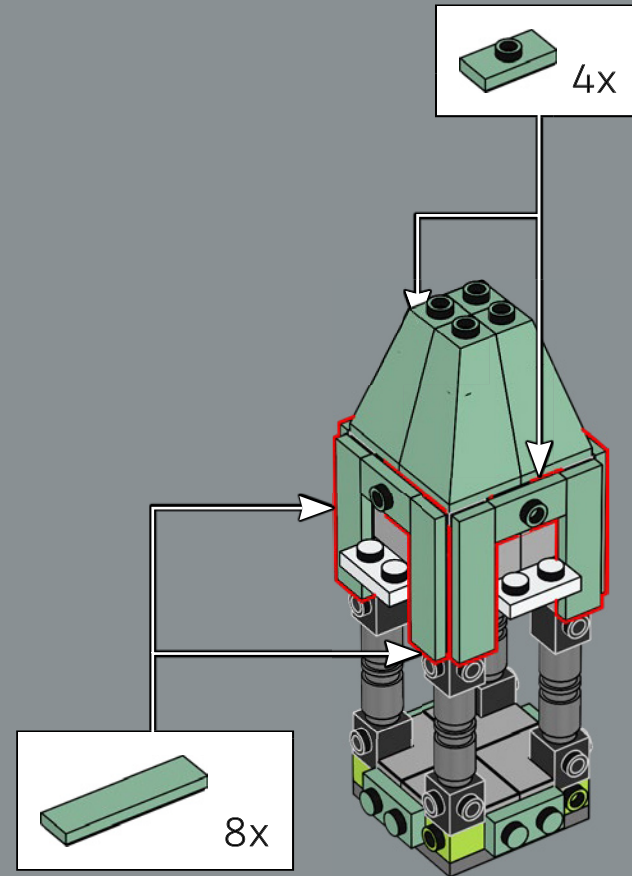

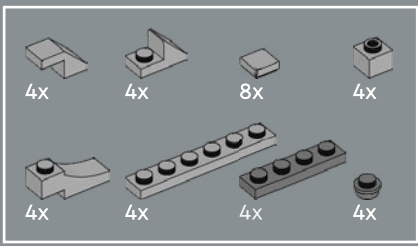

239

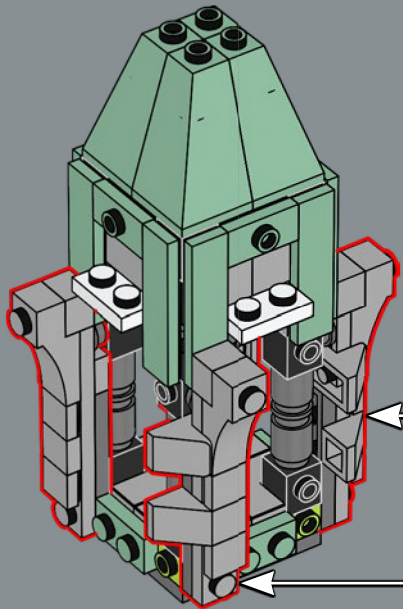
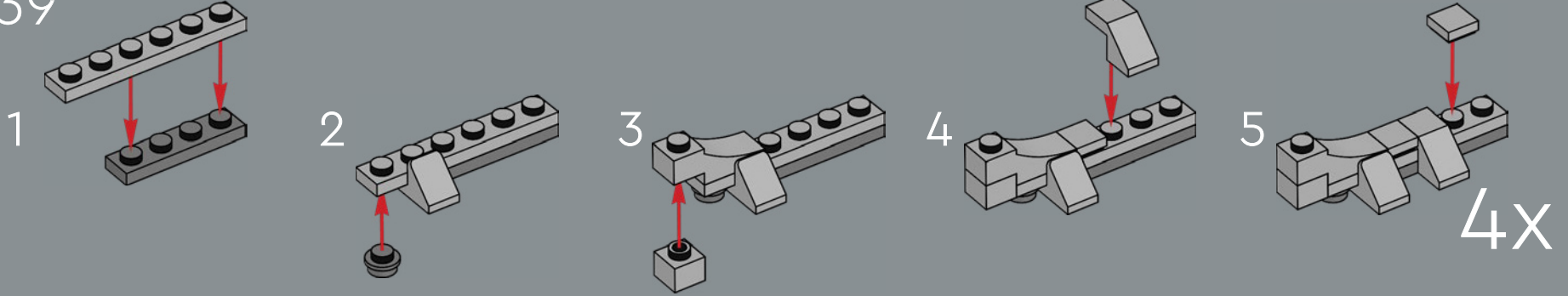

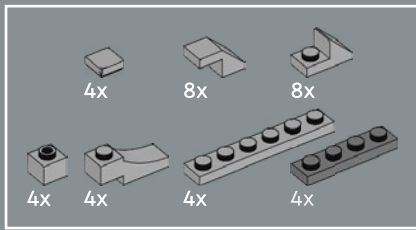

240

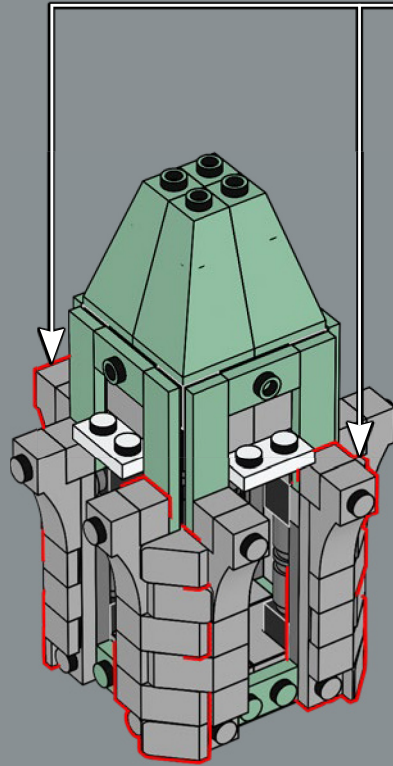
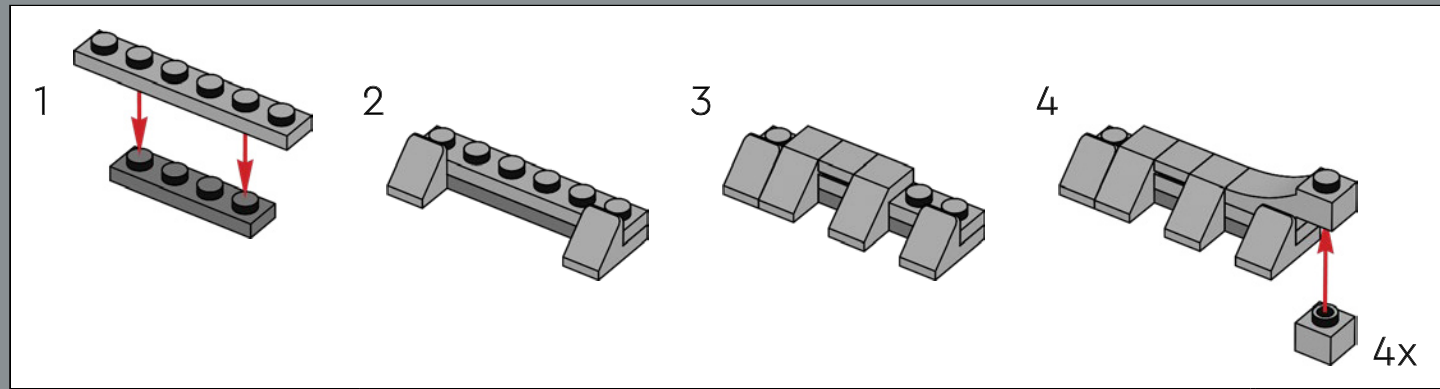

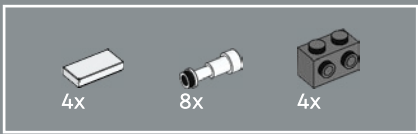

241

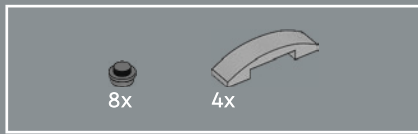
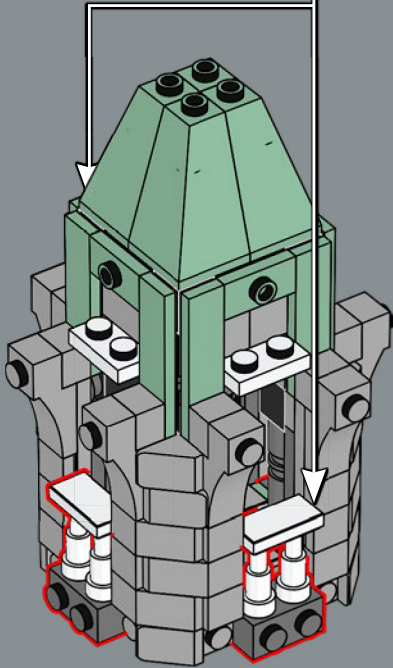
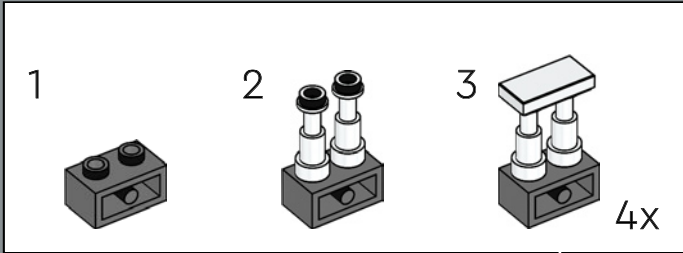

242

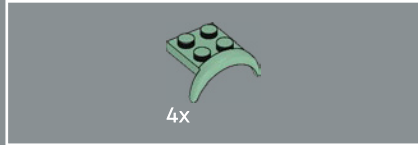
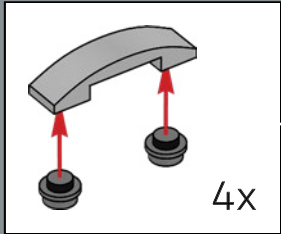

243

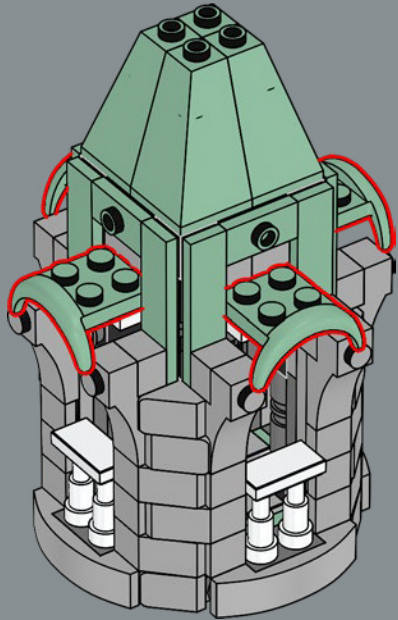
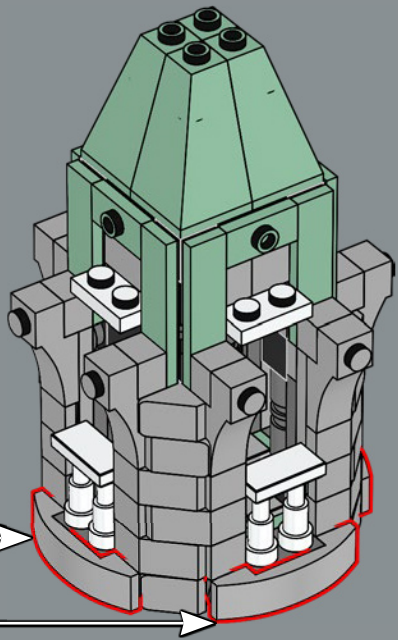

Das grüne Element, das hier den oberen Rand des Fensterrahmens bildet, wurde ursprünglich als Radlauf für ein Auto konzipiert.

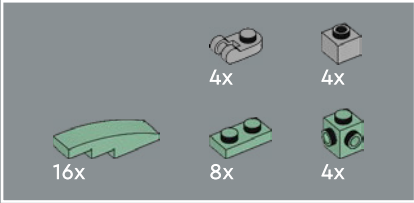

244

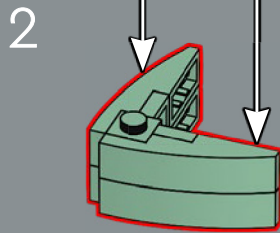
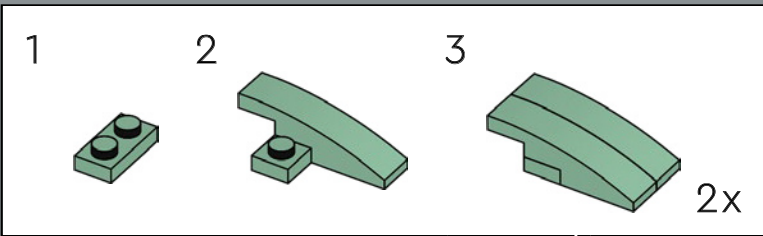
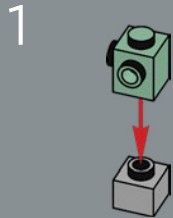

3

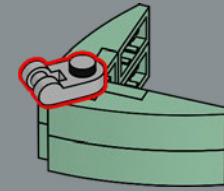

4x

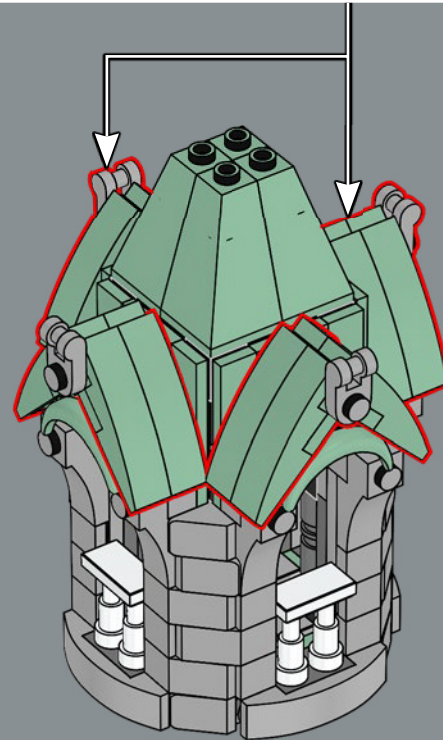



245

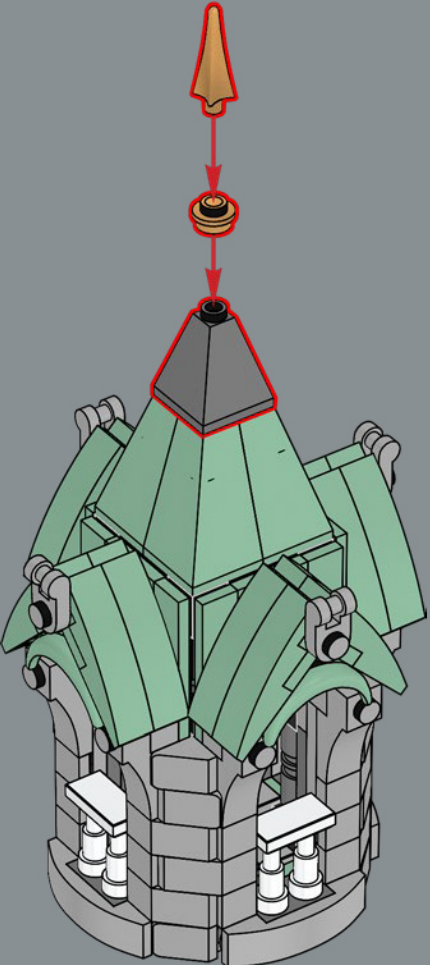

246

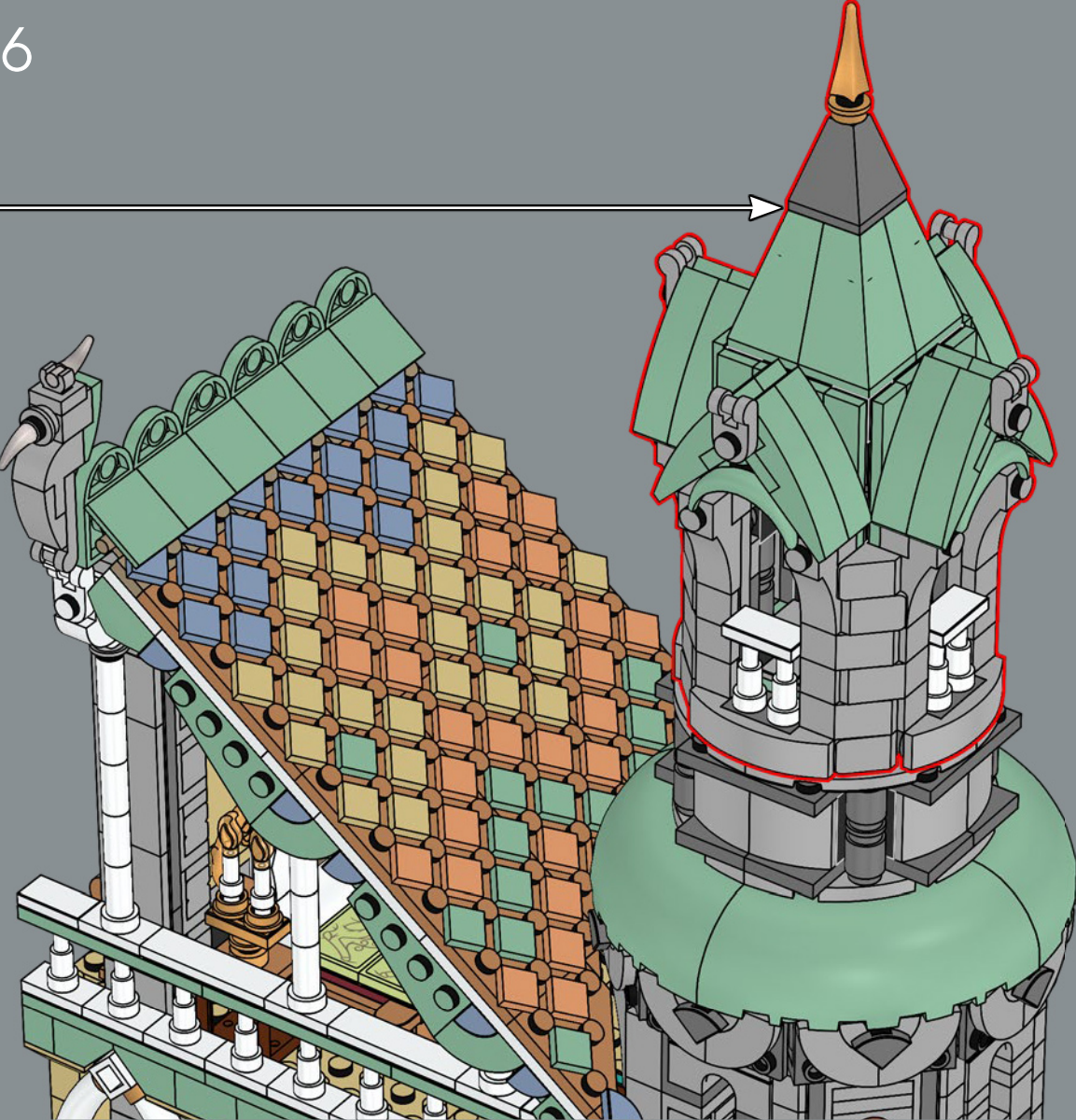

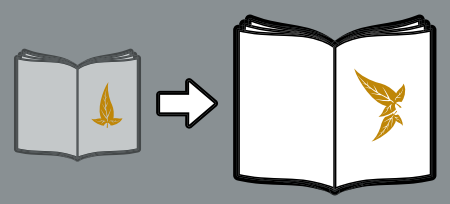

5x 4666579
2x 6145570
1x 6236914

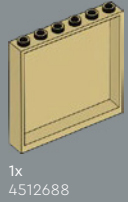

1x 4512688

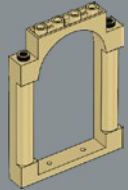

4x 6273864

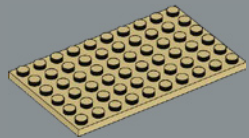

3x 4624185

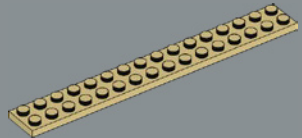

4x 6030980

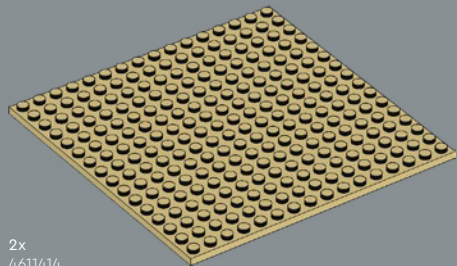

2x 4611414

1x 6310249
1x 6433765



3x 6429962



7x 6421843



1x 306921



2x 6347308



1x 6187620



1x 6001806



1x 6066342



2x 6378120



18x 4142865



1x 6209519



5x 243121



5x 6129995

3x 6330584
130x 6419170
2x 6330418



2x 614323



2x 370023



2x 302323



2x 302123



1x 4206482



9x 6299413



4x 300823



1x 235724



2x 362324



1x 302024



2x 300224

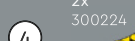

1x 300824

6x 614124
72x 6286830



1x 346024



2x 6130008



2x 4558954



2x 6228987



4x 407026



19x 300226



1x 300926



1x 4181144



9x 6037390



2x 611226



2x 611226



2x 611226

5

1x 4529236
4x 306226
1x 4504382



2x 6265091



4x 6170566



12x 6187572



1x 4214559



8x 473326



20x 6275806



5x 6138173



4x 6178922



1x 6039347



3x 302026



2x 366626



3x 379526

3x 6186675
1x 6335388
1x 6330189



2x 6347310



1x 6338799



3x 6020193



1x 6016172



2x 6250020



2x 6313191



7x 346026



1x 395826



1x 6115117



4x 6401209



1x 6133200



5x 6001494

1x 6168646
40x 614126
1x 474026



2x 6195325



10x 6052126



1x 452826



6x 6371584



6x 6116604



1x 6267045



6x 6168620



2x 6280168



1x 4558209



1x 6115117



4x 6401209



1x 6133200

1x 452226
1x 4189009



1x 6315887



3x 6278152



5x 6279875



8x 6280097



6x 4512363



5x 6390386



2x 6227901



1x 6315573



1x 6283610



1x 4517986



1x 6399780



6x 302128

1x 6299492
1x 6321770



1x 6171101



15x 6229130



2x 6331100



46x 6206150



4x 4119479



15x 6182261



1x 6235080



34x 6411022



16x 6268814



2x 6389695



1x 6406357



5x 6395814

1x 6293826

2x 6266964





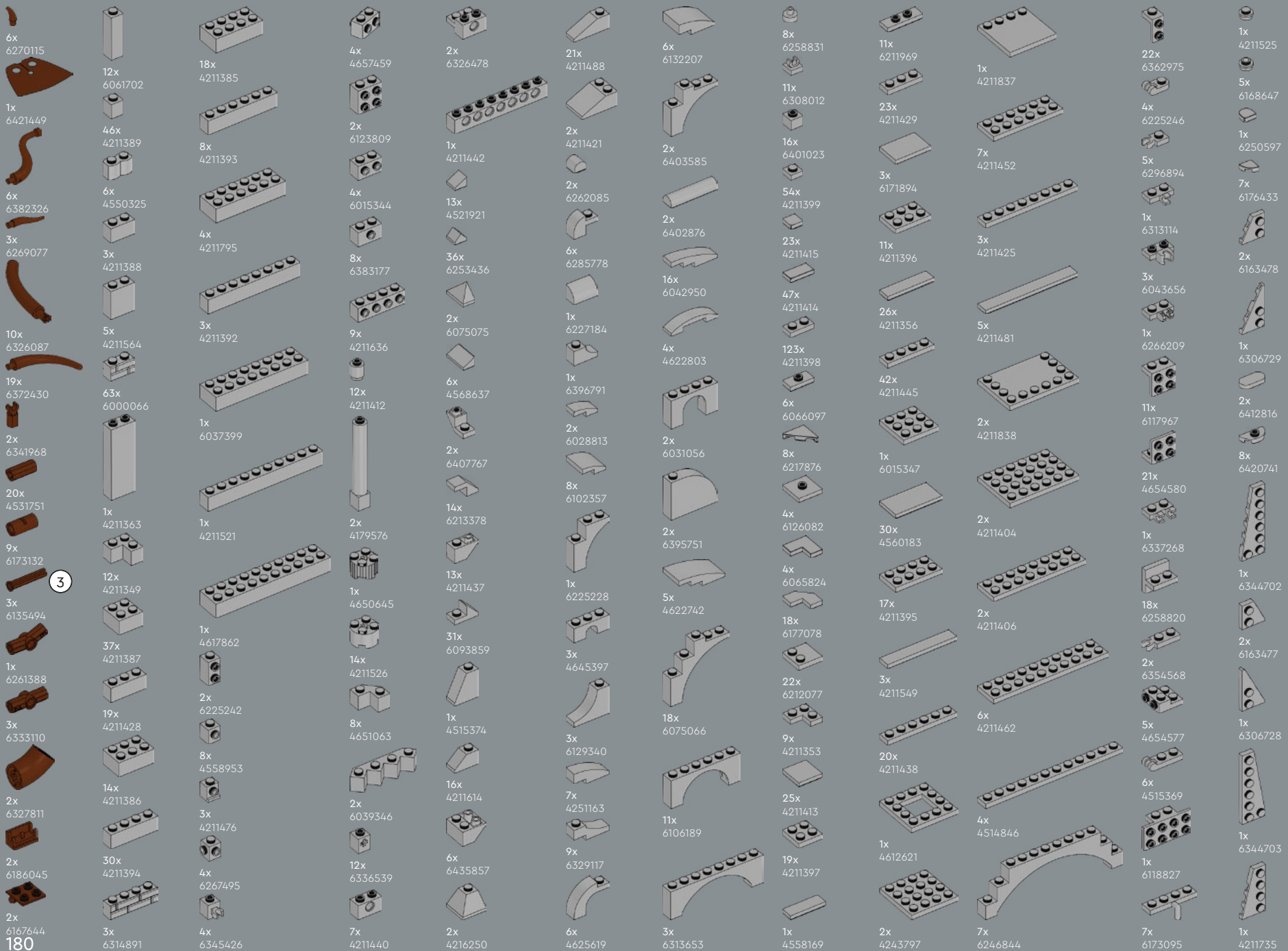



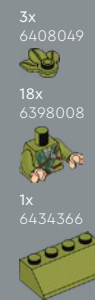
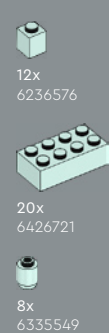
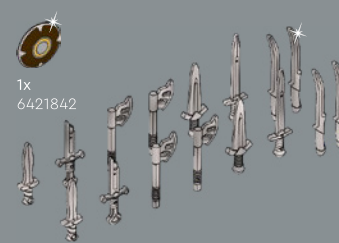
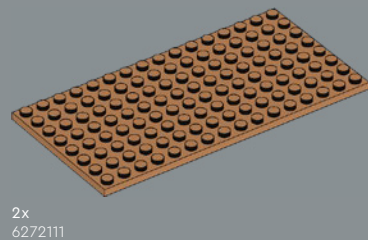

[LEGO.com/service](https://www.lego.com/service)



YOU COULD WIN



YOU COULD WIN

Your feedback will help shape the future development of this product series.

Visit:

DU KÖNNTEST GEWINNEN

Dein Feedback trägt zur Weiterentwicklung dieser Produktreihe bei.

Geh auf:

VOUS POURRIEZ GAGNER

Vos commentaires nous aideront à concevoir les futurs produits de cette gamme.

Visitez :

POTRESTI VINCERE TU

La tua opinione ci aiuterà a migliorare la creazione futura di questa linea di prodotti.

Visita:

PUEDES GANAR

Tu opinión contribuirá al futuro de esta serie de productos.

Visita:

轻松获奖

您的反馈将有助于我们在今后改进本产品系列。

请访问:

LEGO.com/productfeedback

You also have the chance to win a LEGO® set.

Terms and conditions apply.*

Außerdem hast du die Chance, ein LEGO® Set zu gewinnen.

Es gelten die Teilnahmebedingungen.*

Vous pourriez également gagner un ensemble LEGO®.

Des conditions s'appliquent.*

Hai anche la possibilità di vincere un set LEGO®.

Termini e condizioni sono applicabili.*

También tienes la oportunidad de ganar un set LEGO®.

Aplican términos y condiciones.*

您还有机会赢取乐高®套装。

条款和条件适用。*

*LEGO.com/productfeedback-terms

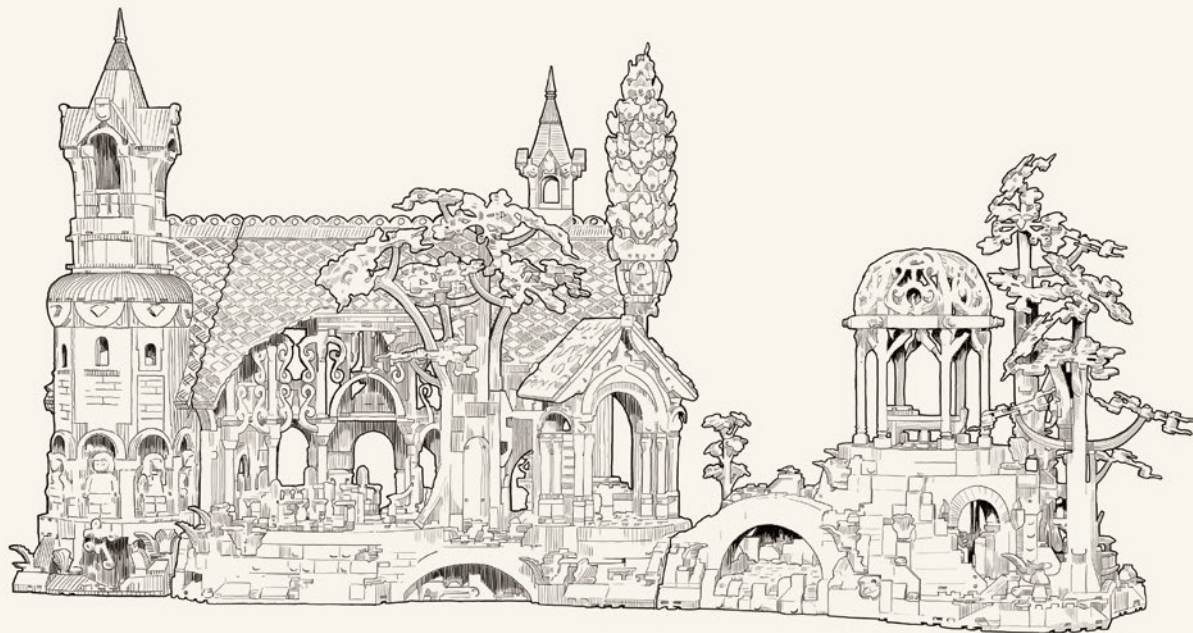

LEGO and the LEGO logo are trademarks of the LEGO Group. ©2023 The LEGO Group.

© 2023 New Line Productions, Inc. All rights reserved. The Lord of the Rings: The Fellowship of the Ring, The Lord of the Rings: The Two Towers, The Lord of the Rings: The Return of the King and the names of the characters, items, events and places therein are trademarks of The Saul Zaentz Company d/b/a Middle-earth Enterprises under license to New Line Productions, Inc. (s23)