





河流、 锻造厂 和军械库

比尔博和佛罗多在观景亭重逢。在议会受邀者到达后，他们将战斗装备存放在锻造厂旁边的军械库中。阿尔温和阿拉贡在护戒使者踏上危险旅程之前秘密会面。



阿尔温穿着她的精灵礼服出现，并带着她在《护戒使者》中送给阿拉贡的苍暮之星 (Evenstar) 吊坠。

阿尔温



吉姆利戴着装饰精美的战斗头盔，挥舞着他全新的斧头。根据设计，吉姆利比霍比特人高，但比精灵矮。

吉姆利







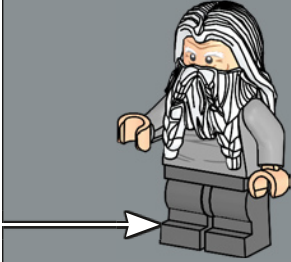
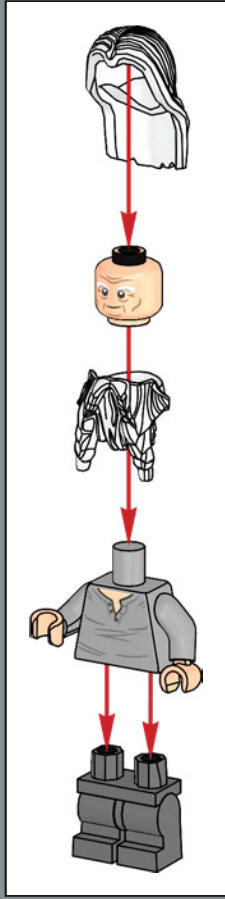
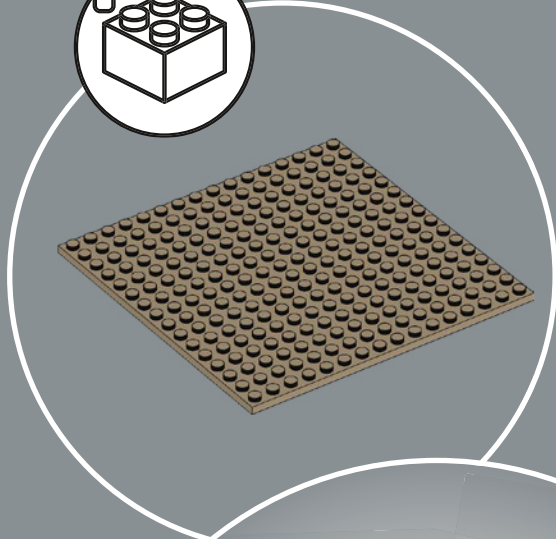
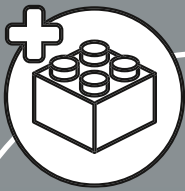

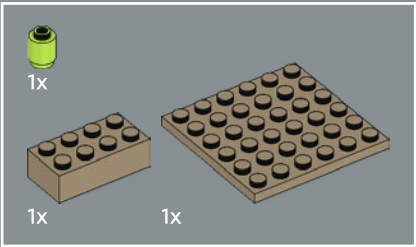
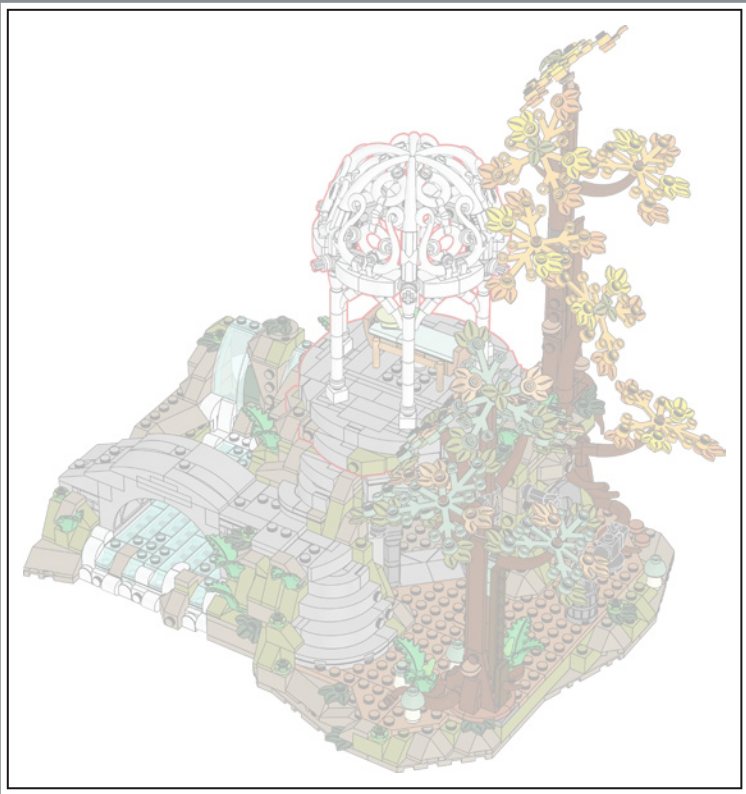

1

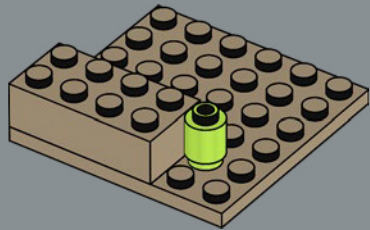

2

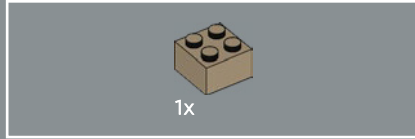
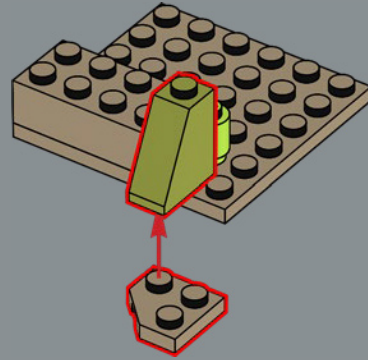

3

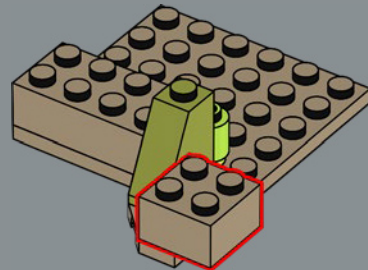

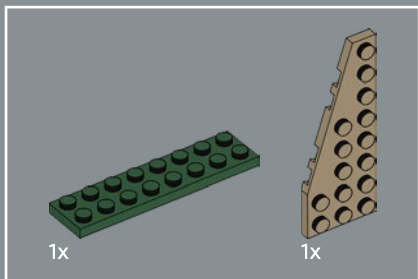

4

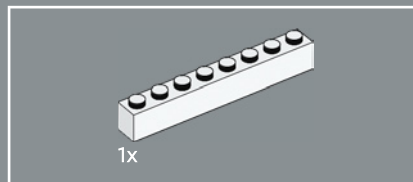
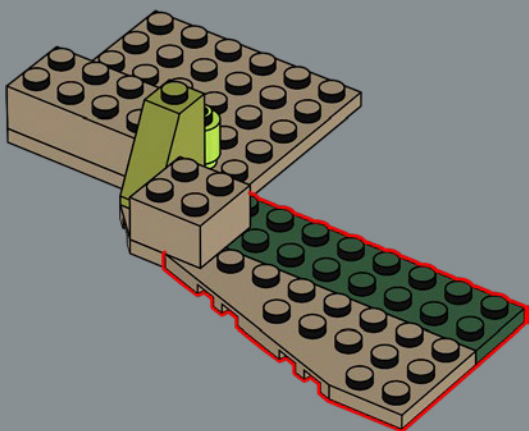

5

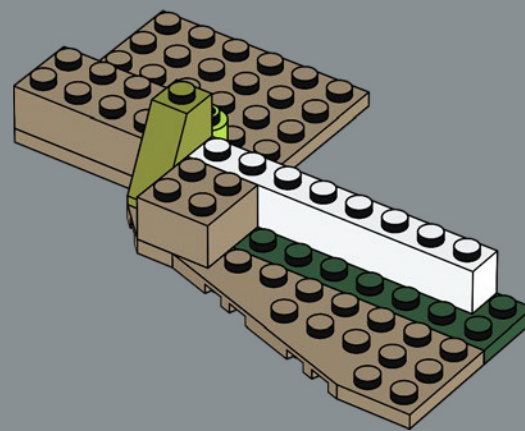

在此模型中, 我们使用数十块左向和右向组件来拼搭具有有机外观的景观。我们确保每个形状都包含相同数量的组件。看你能否发现它们都藏在了哪里!

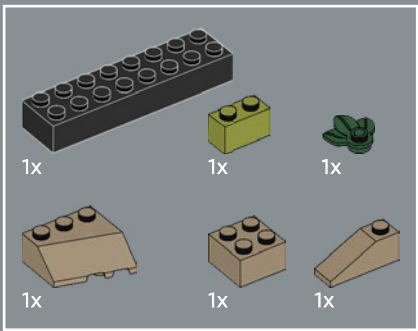

6

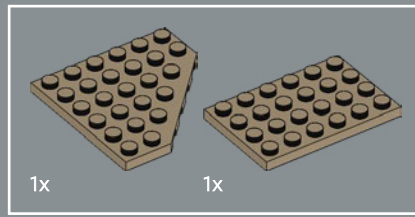
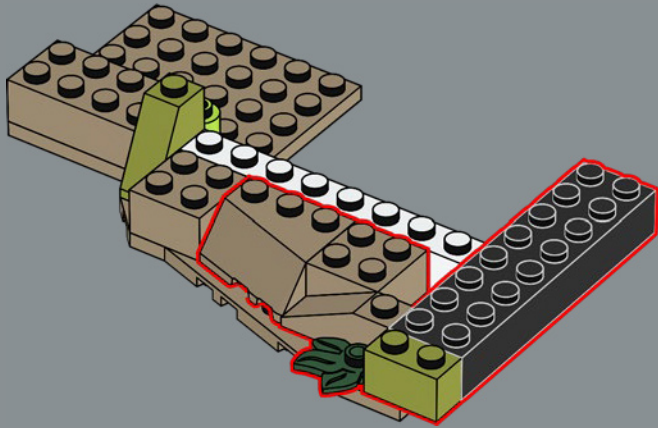

7

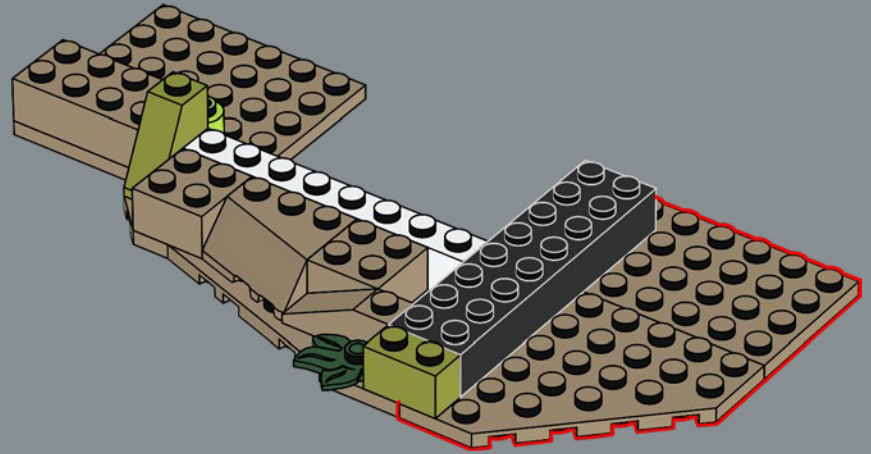

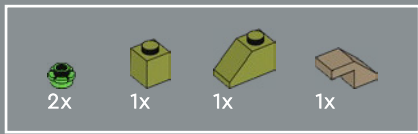

8

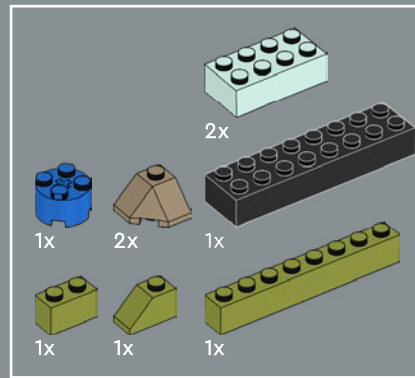
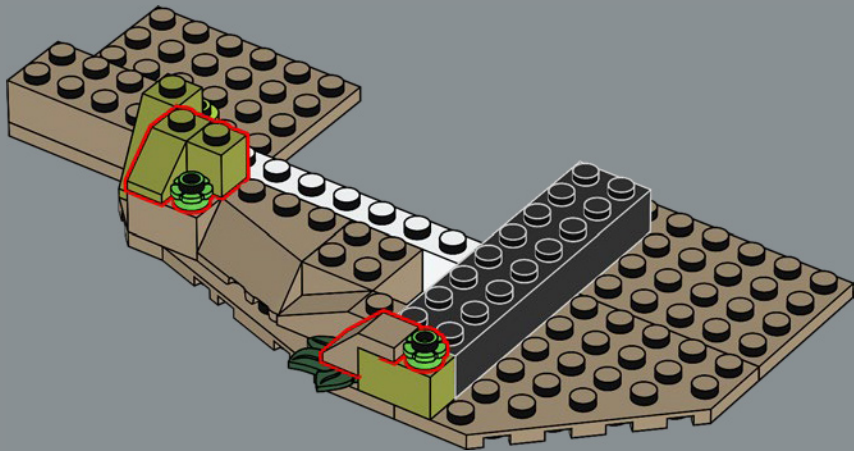

9

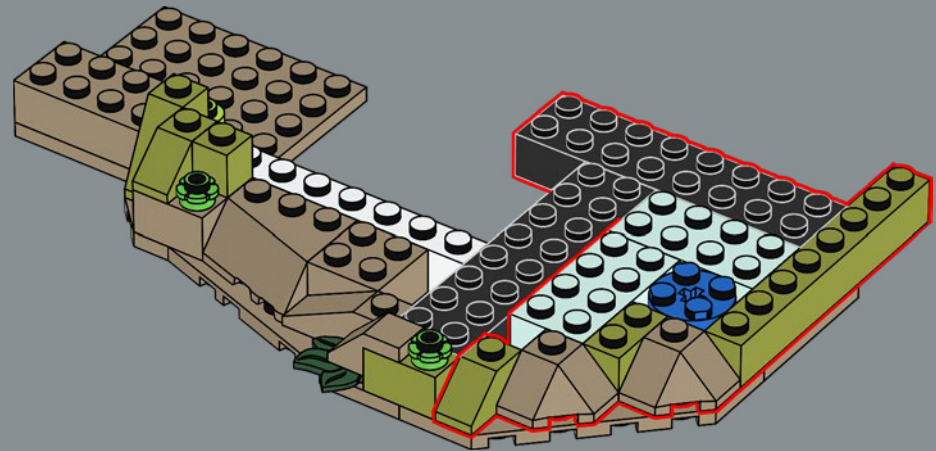

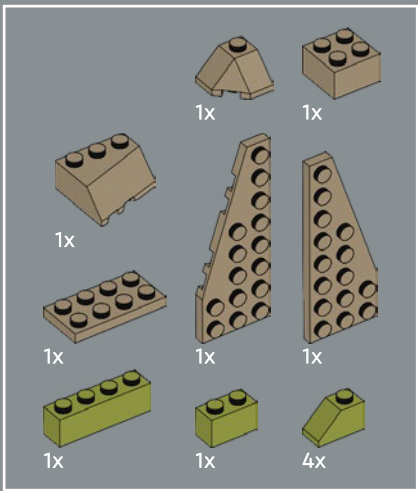

10

1

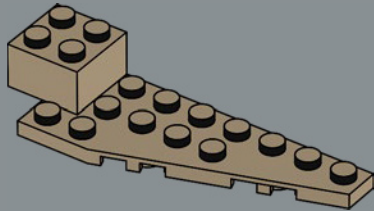

2

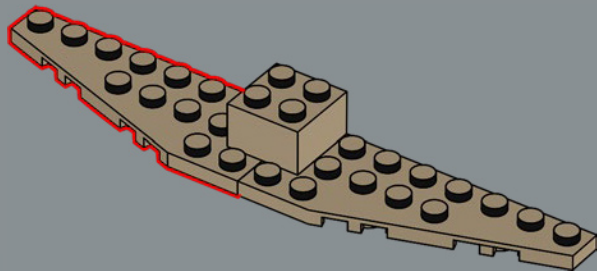

3

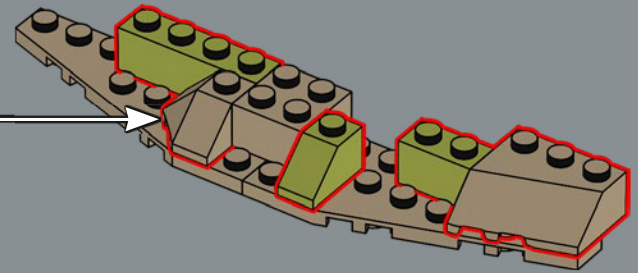

4

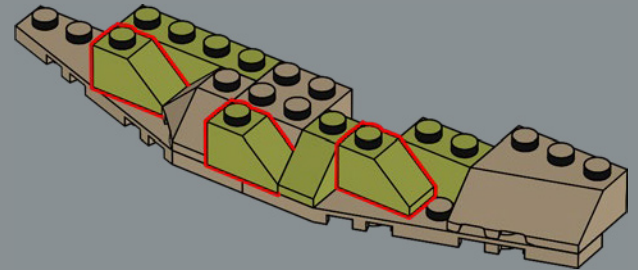

5

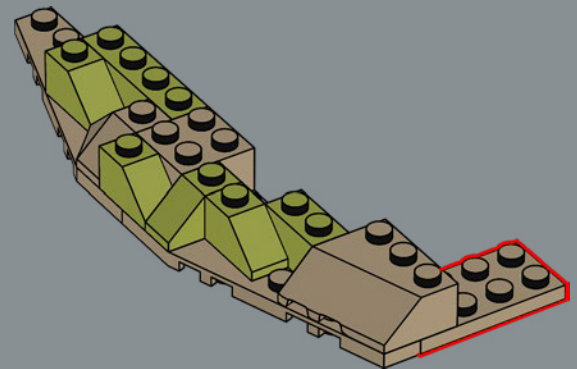

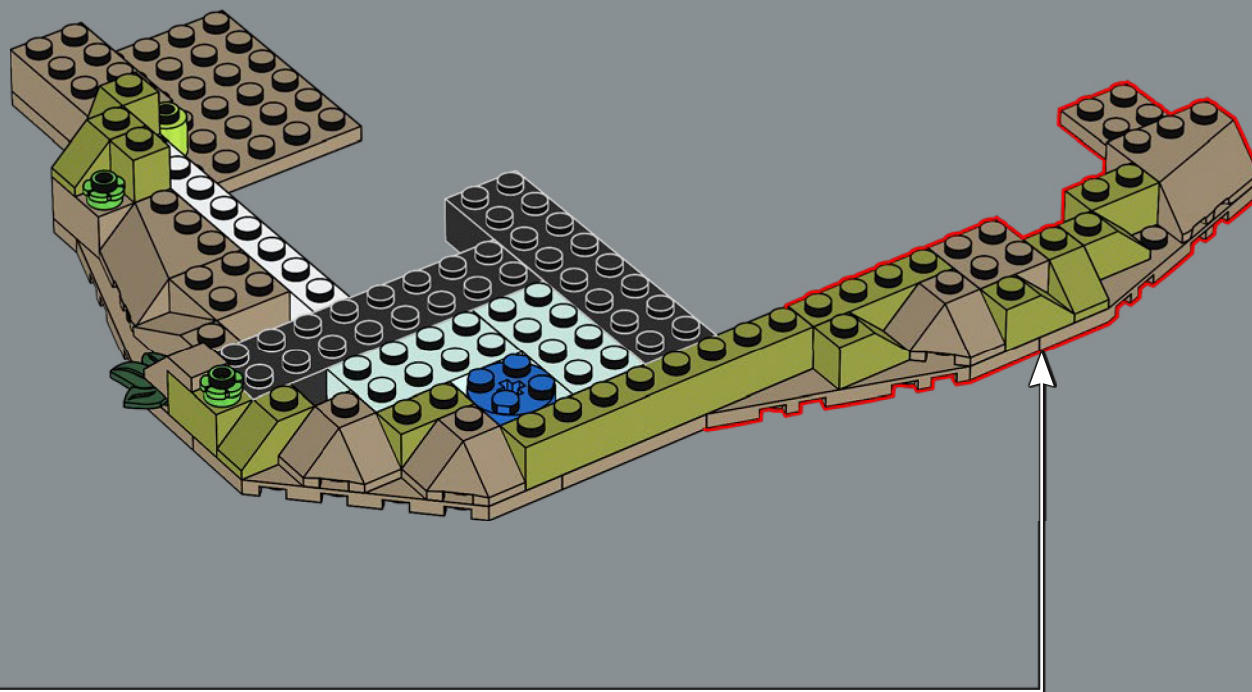

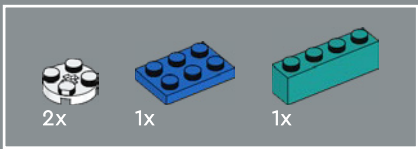

11

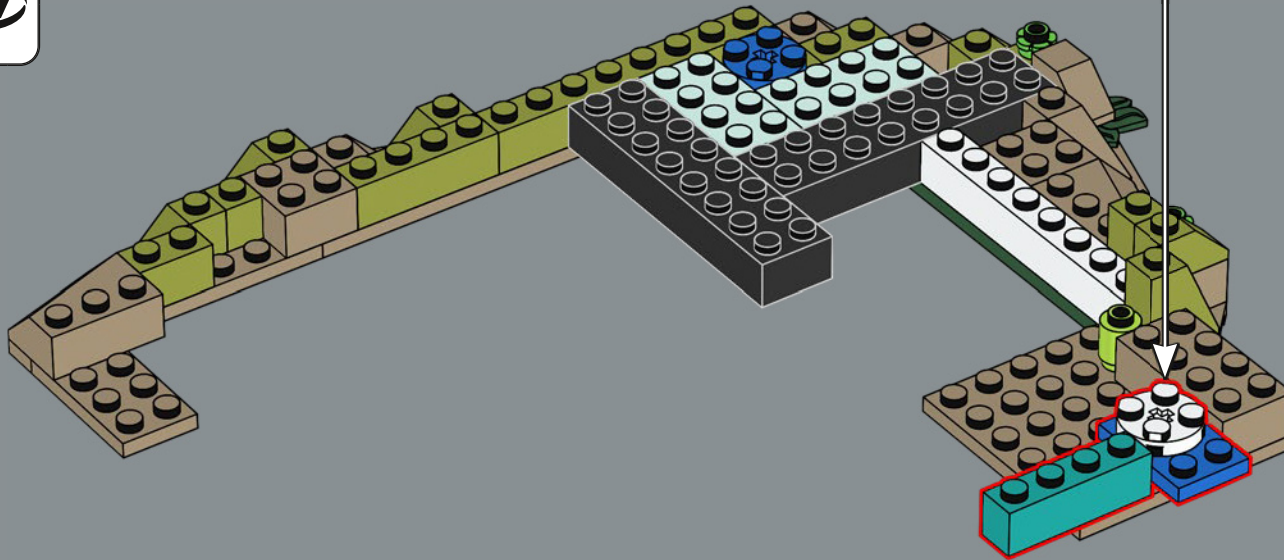
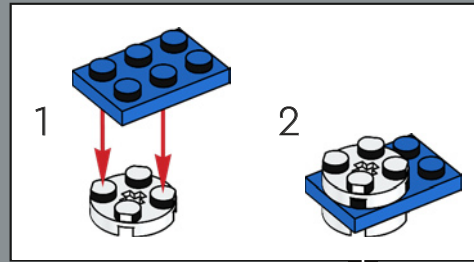

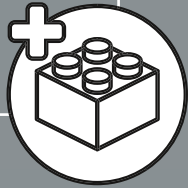
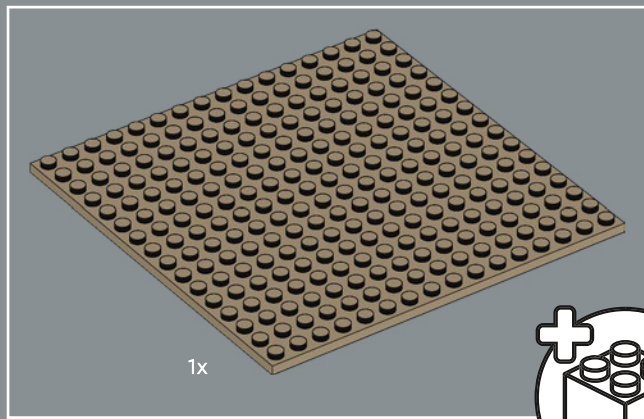

12

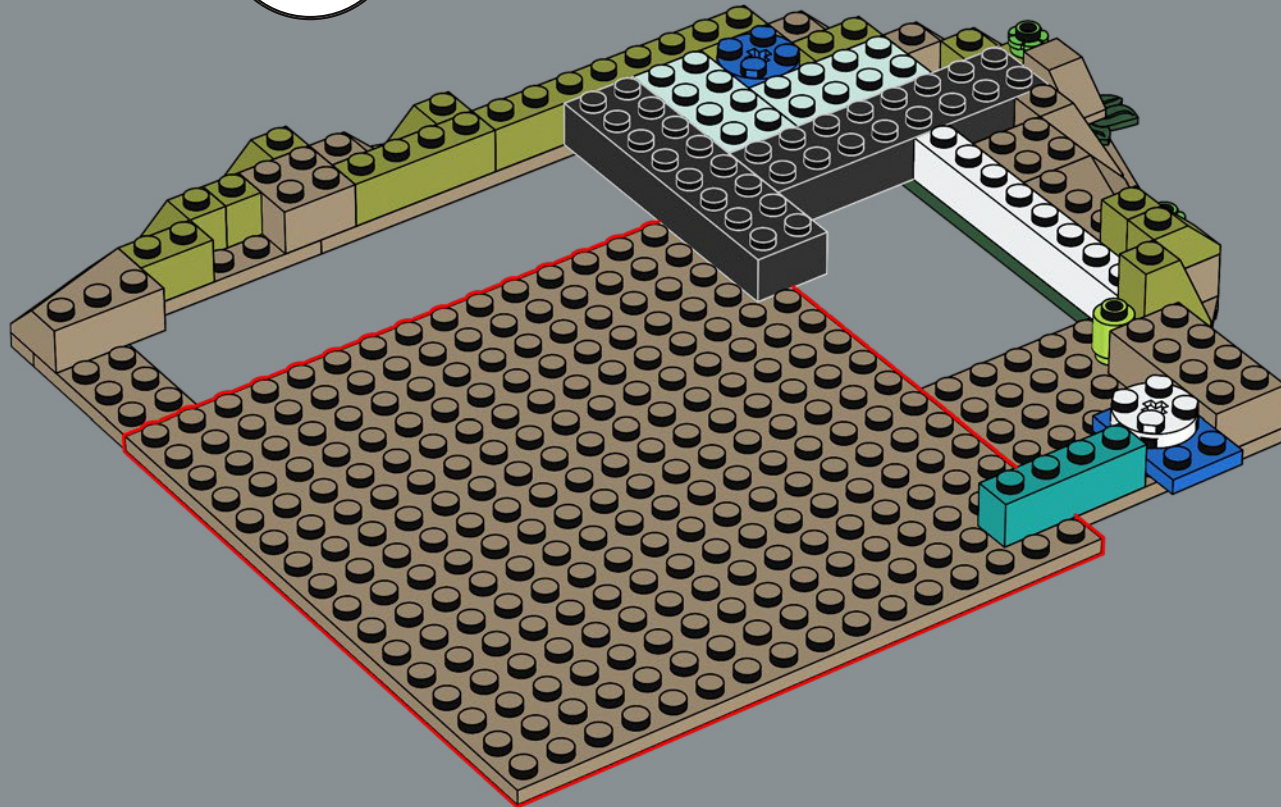

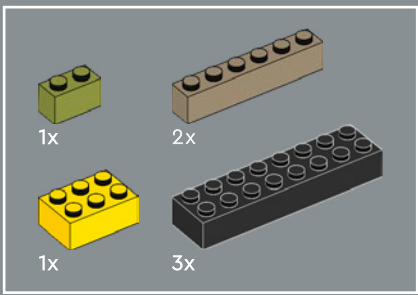

13

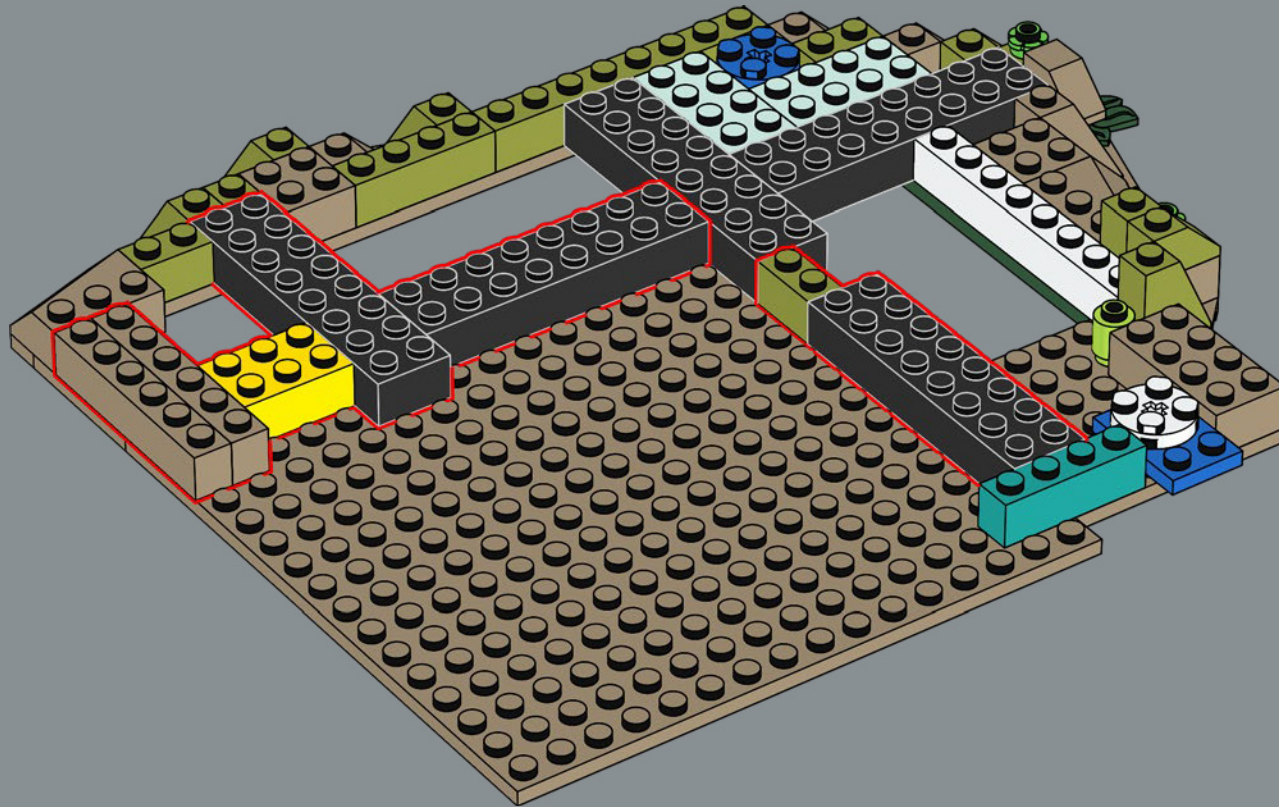

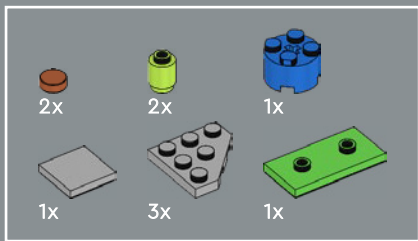

14

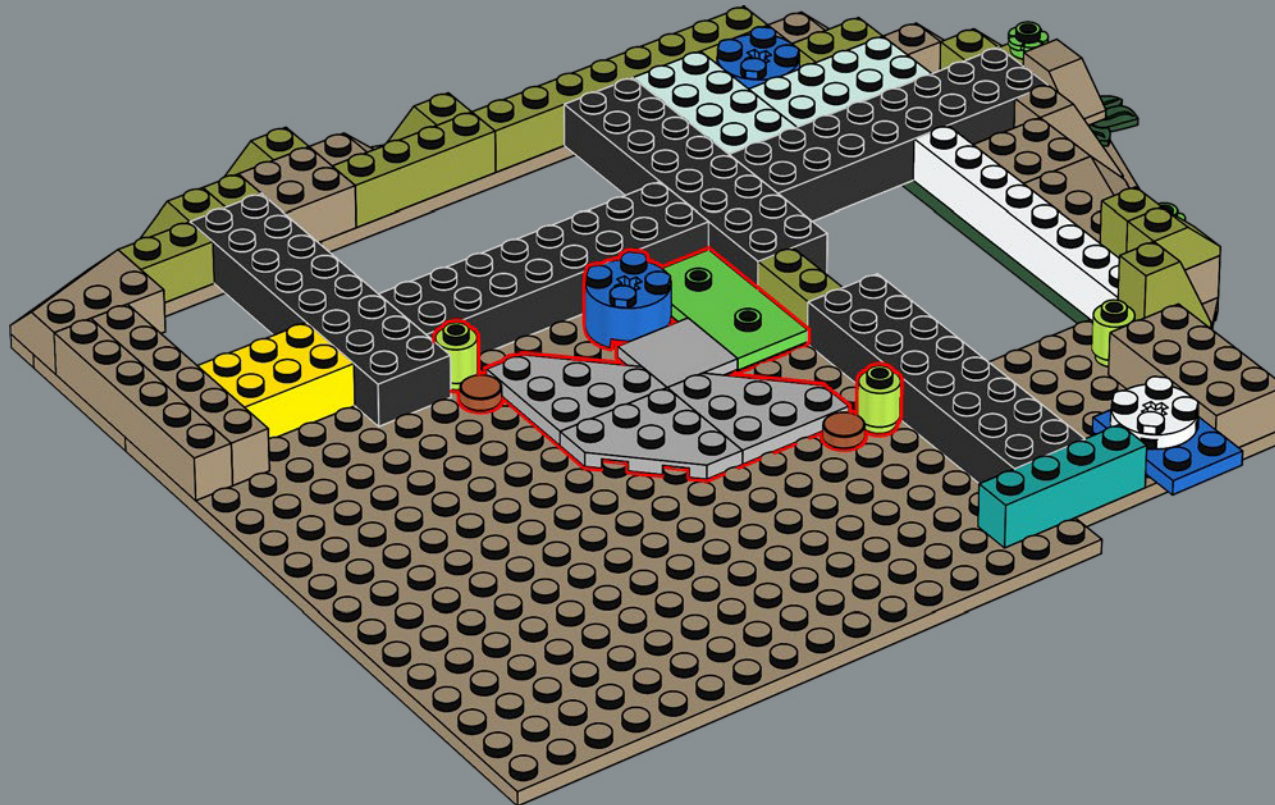

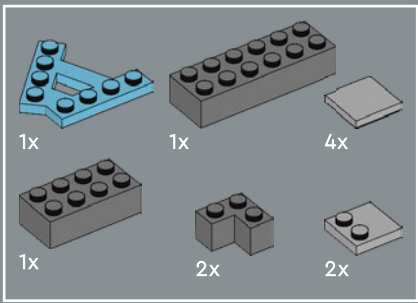

15

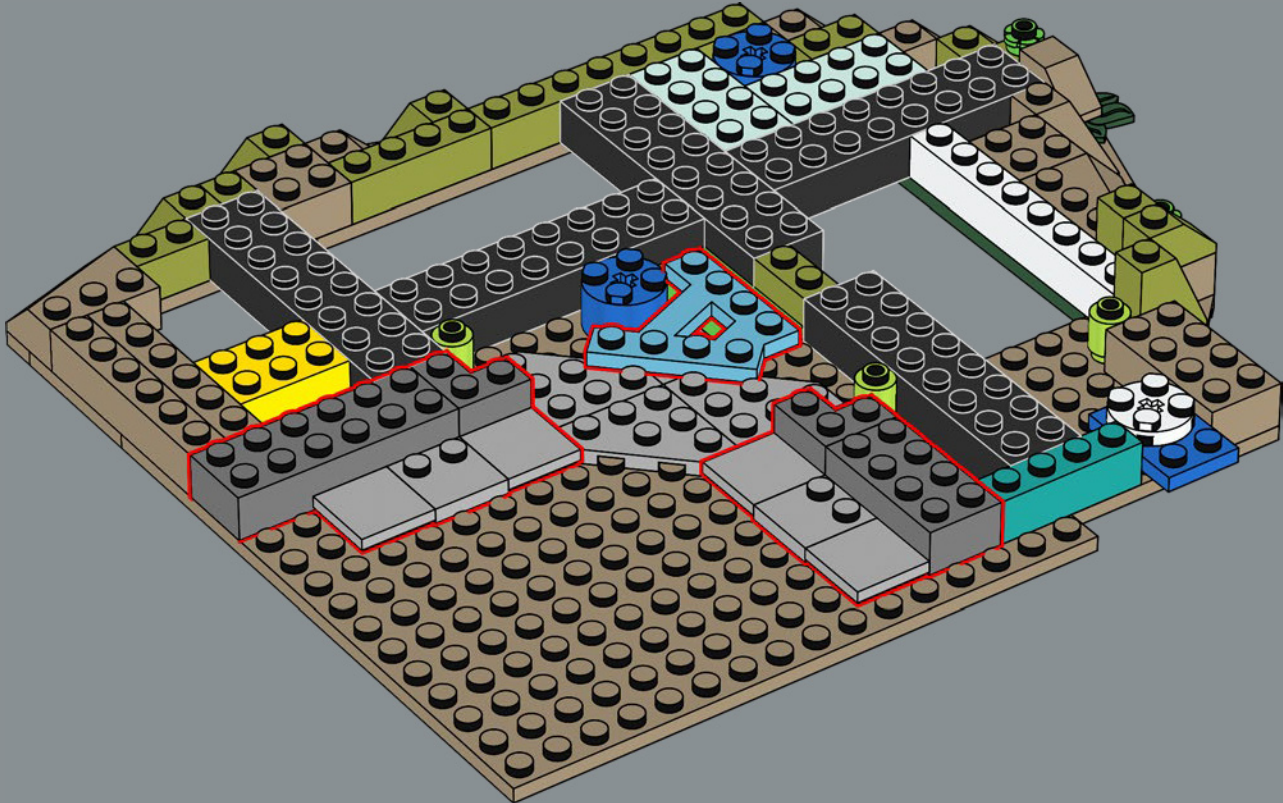



16

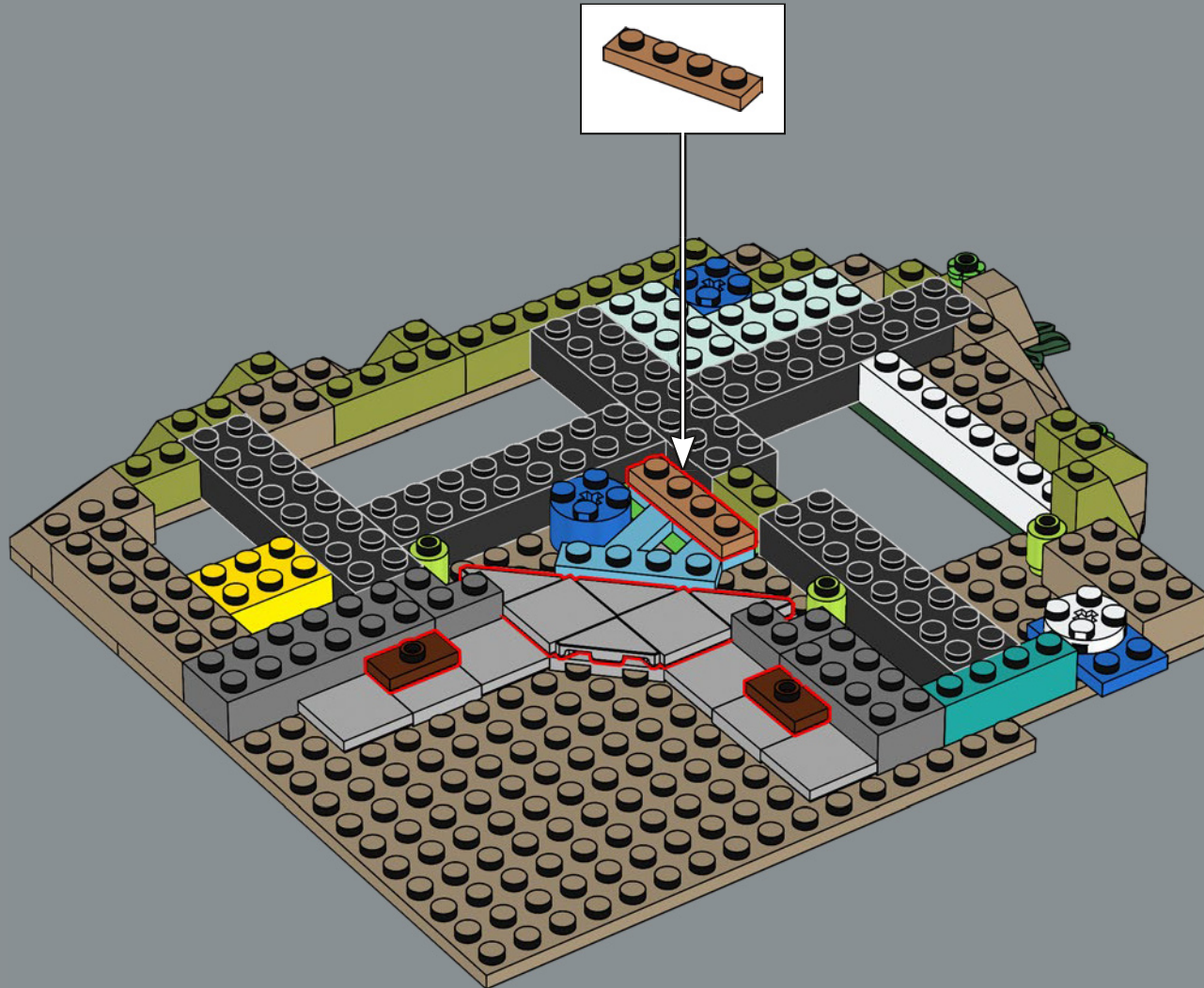

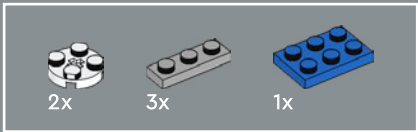

17

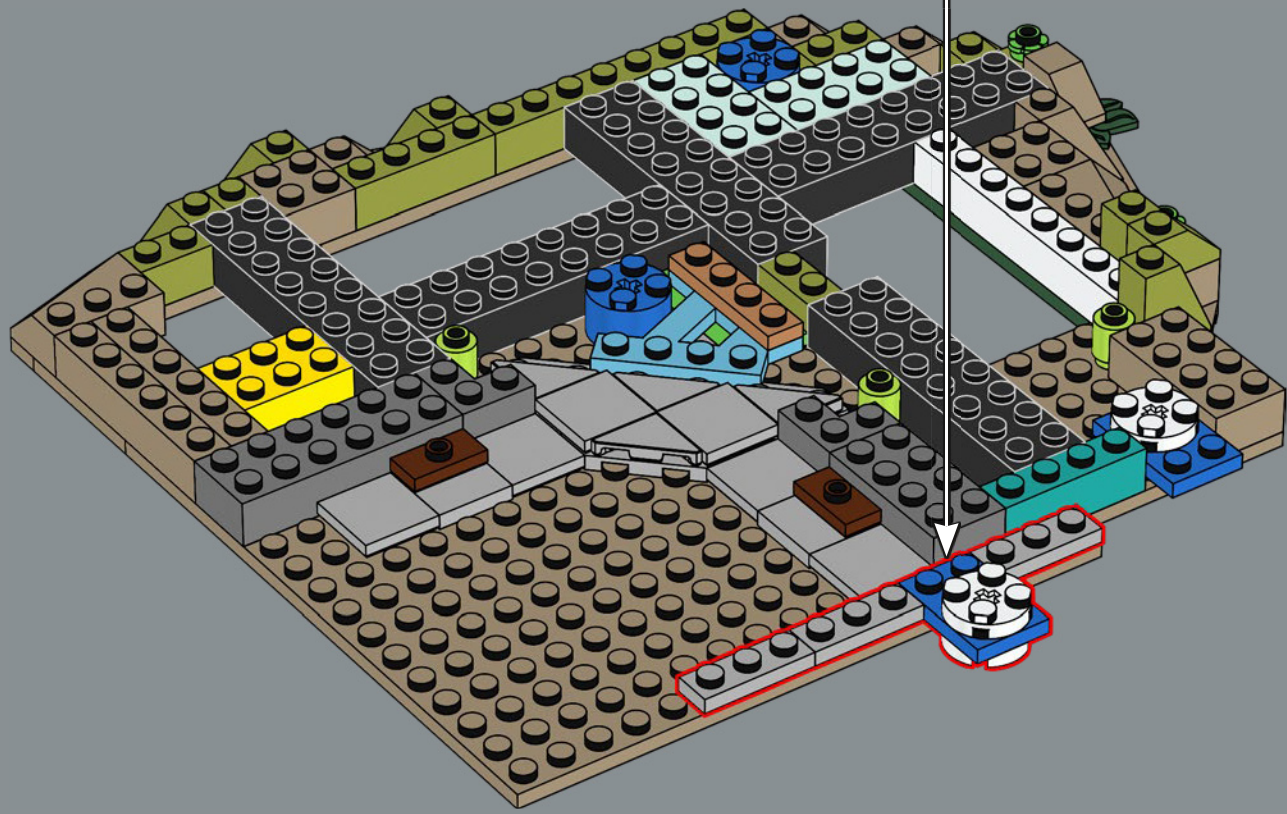
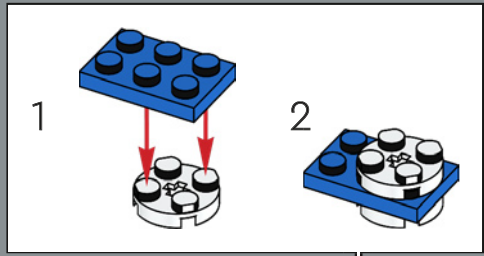

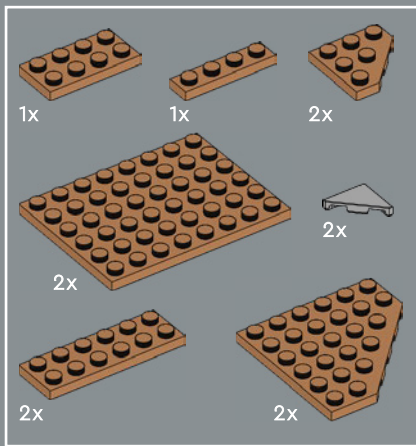

18

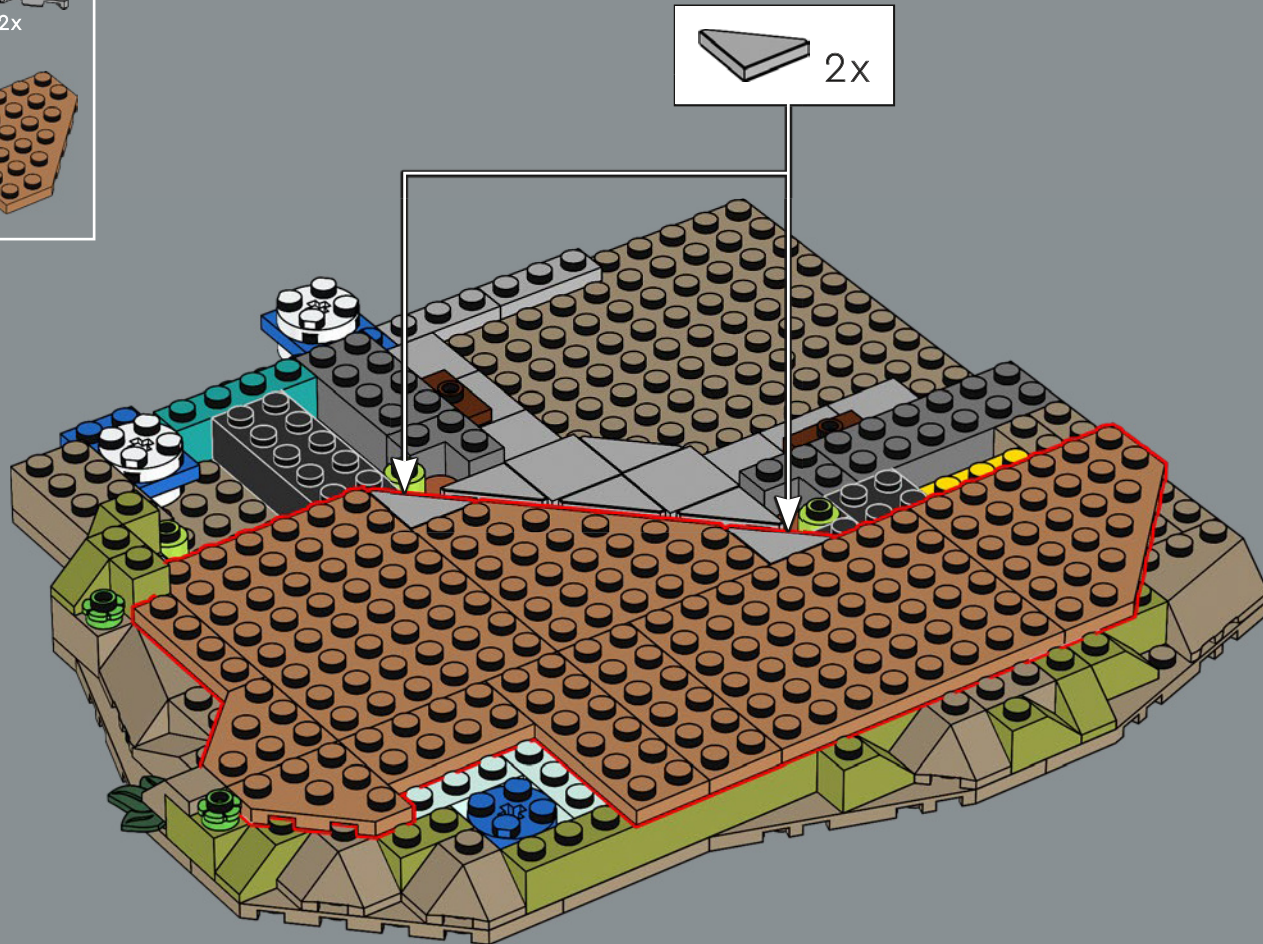

- 
2x
- 
1x
- 
2x
- 
1x
- 
1x

19

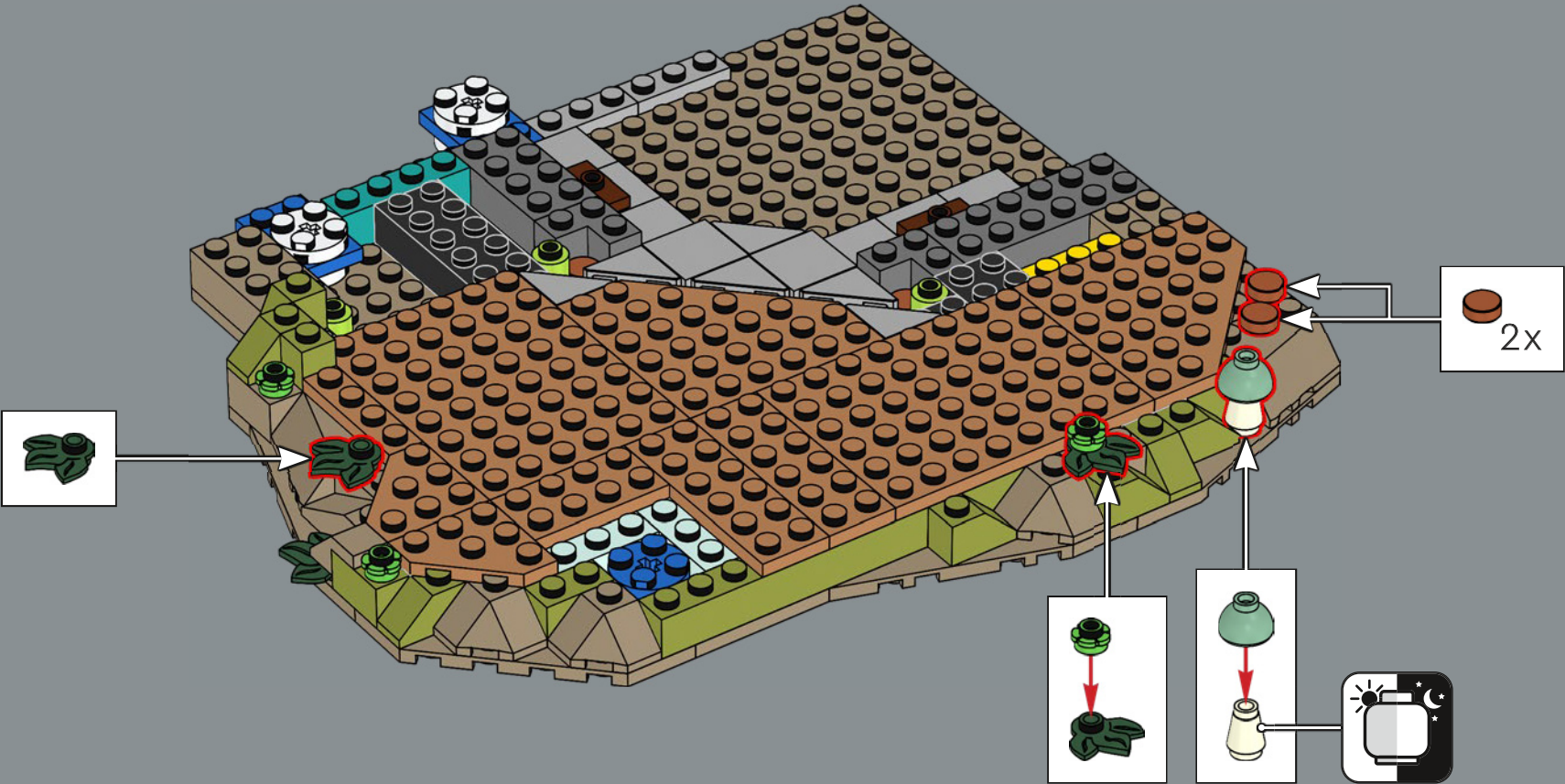

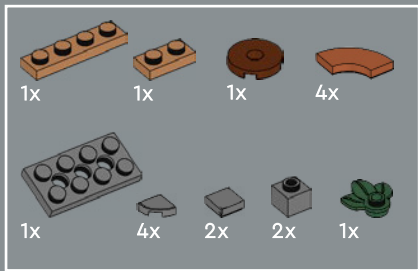

20

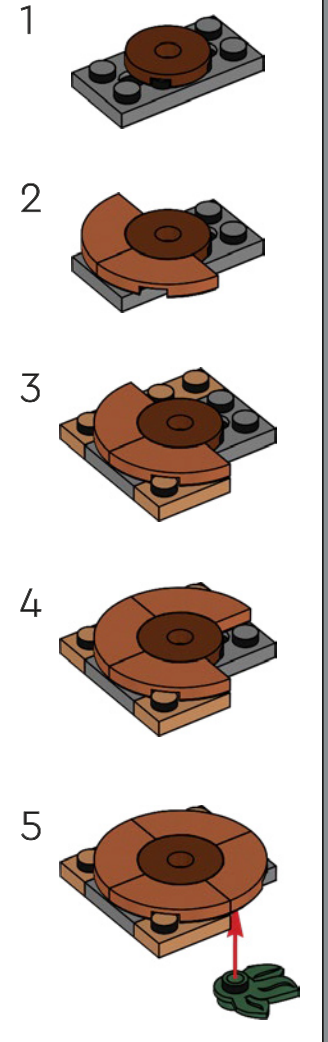
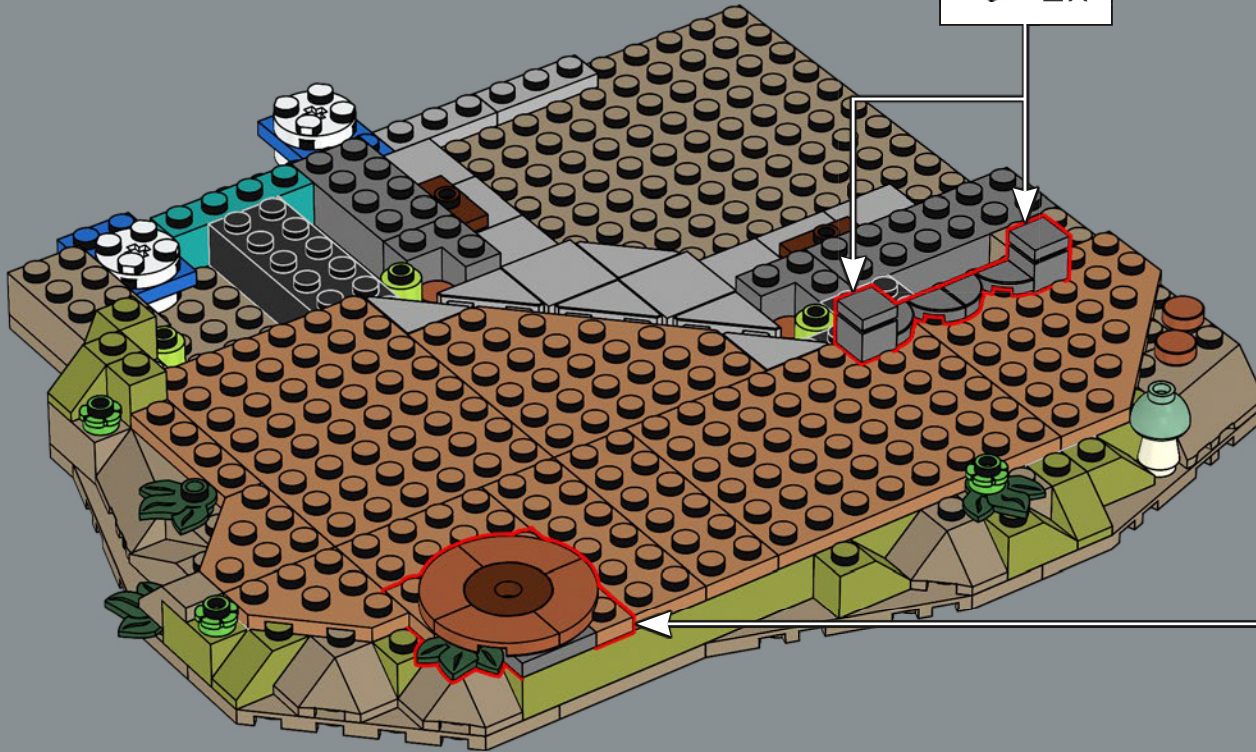
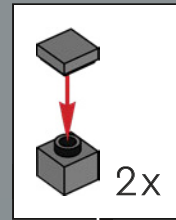

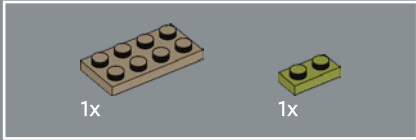
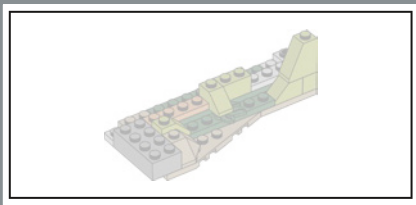

21

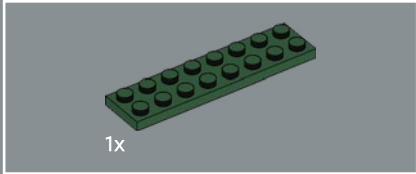
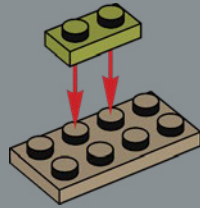

22

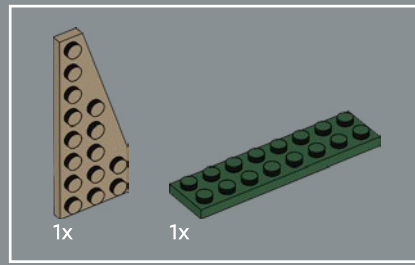
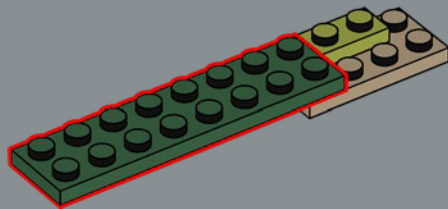

23

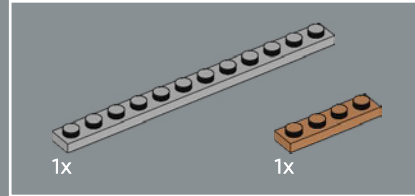
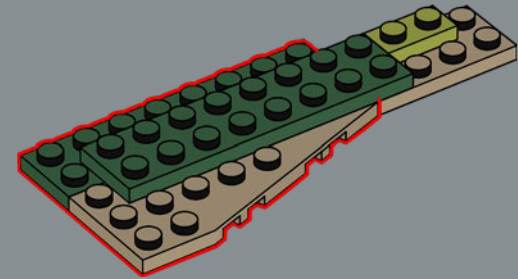

24

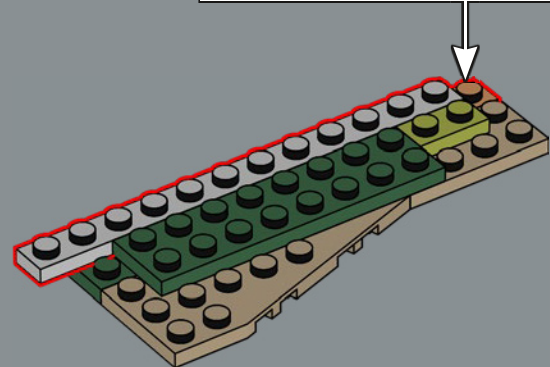
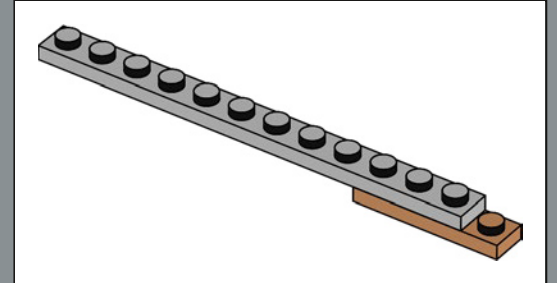

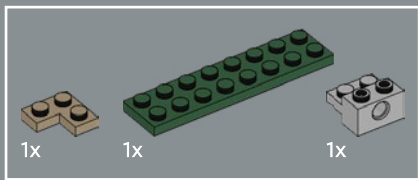

25

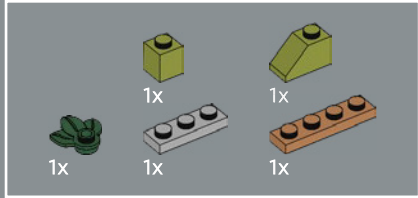
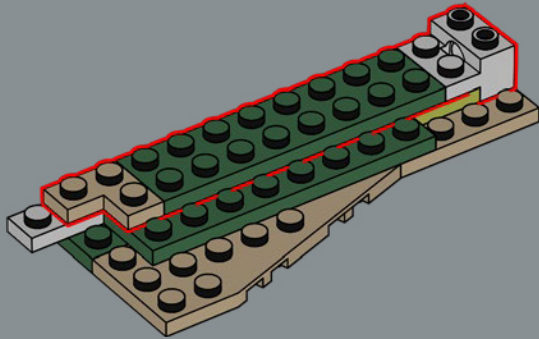

26

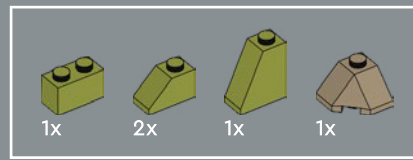
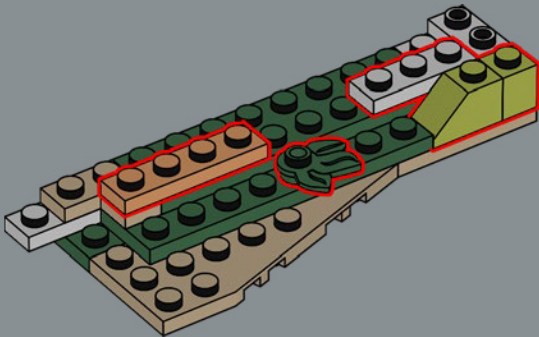

27

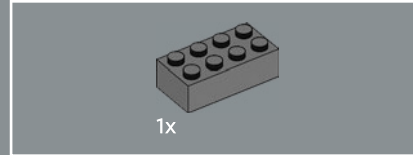
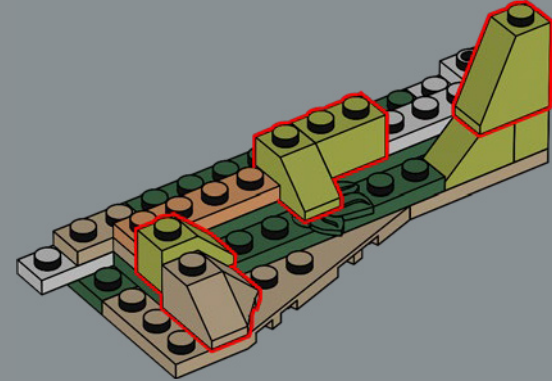

28

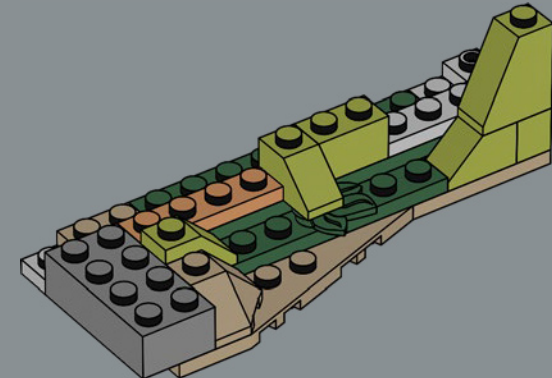

29

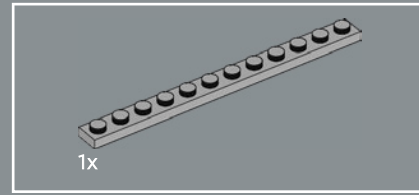
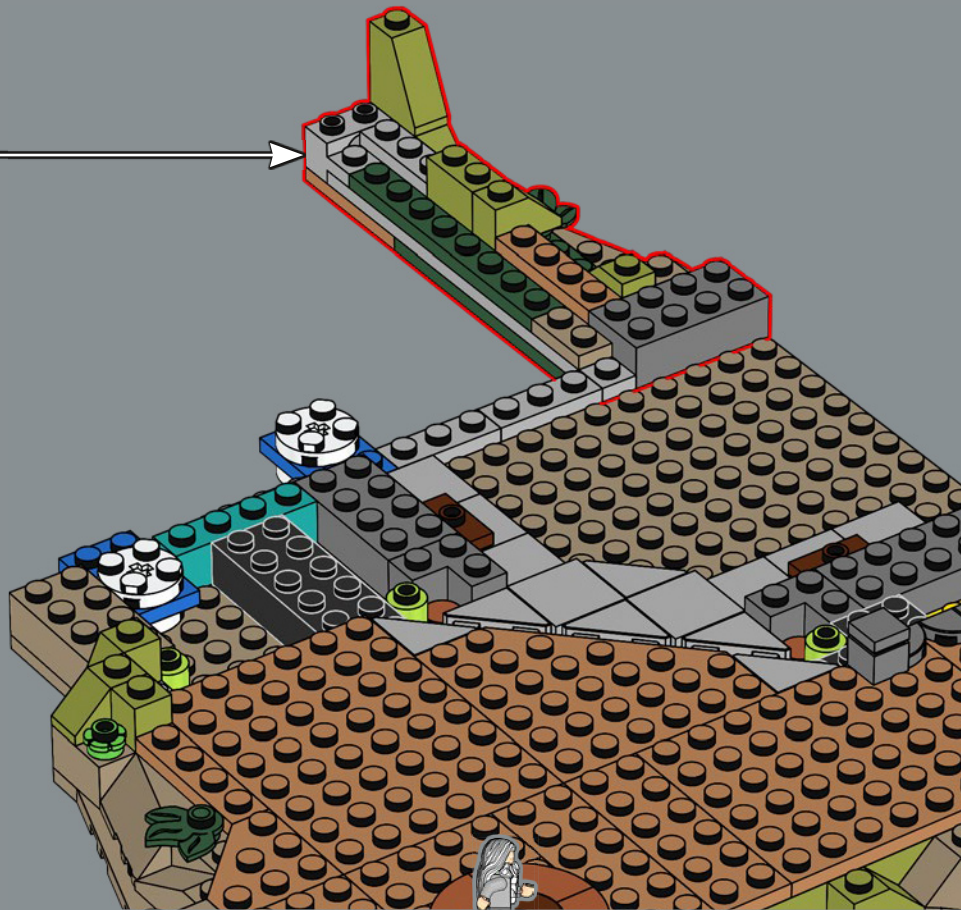

30

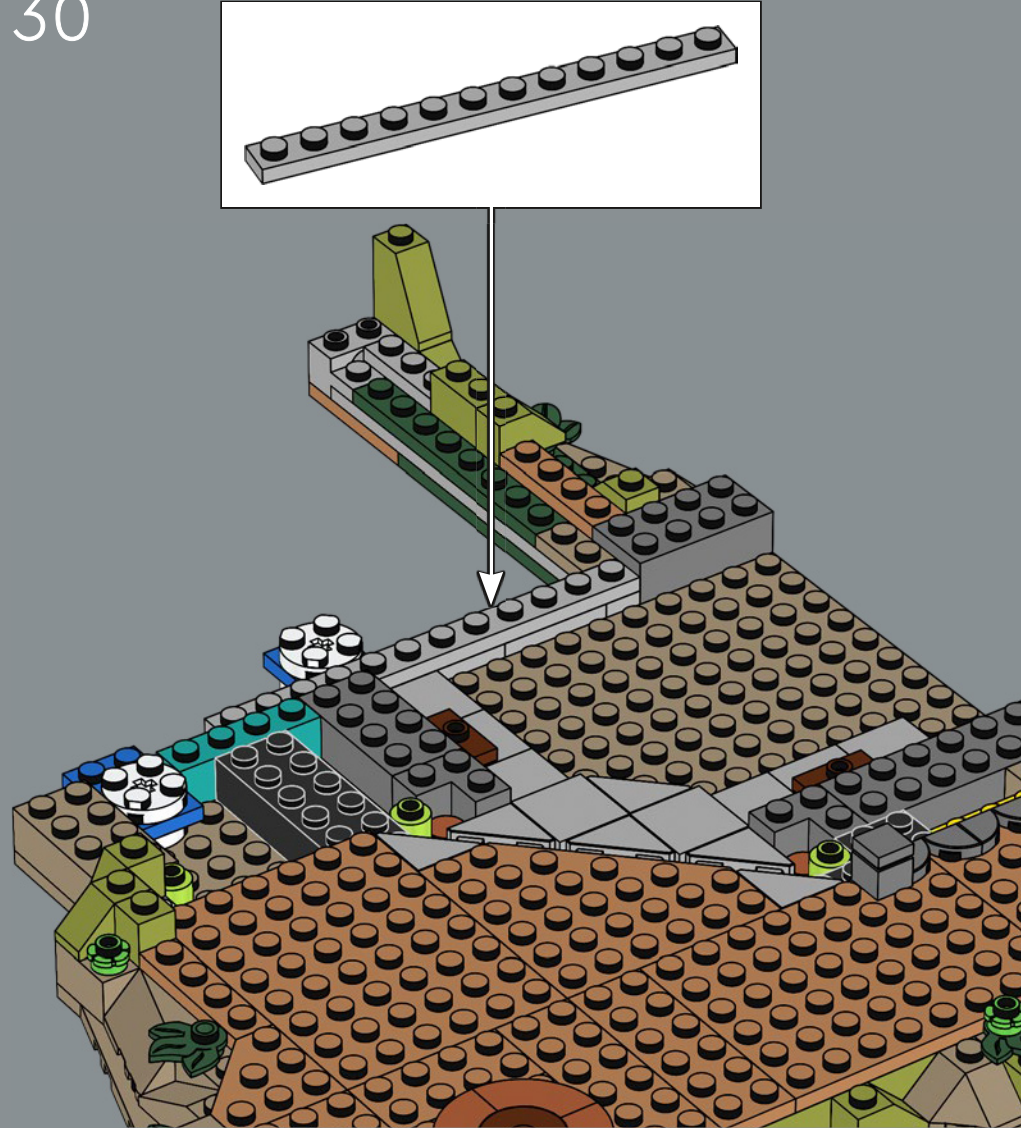

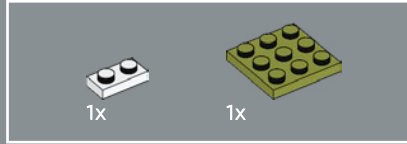
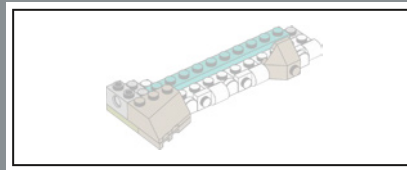
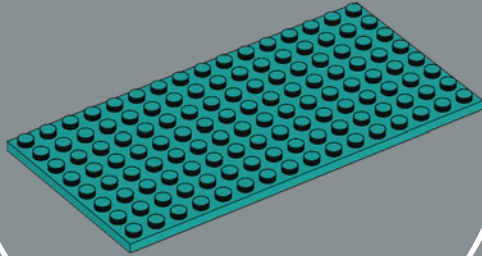
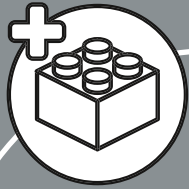

31

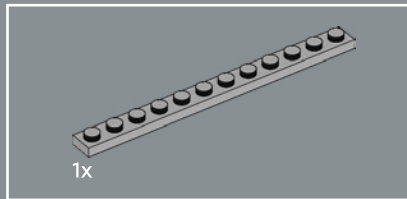
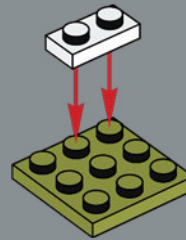

32

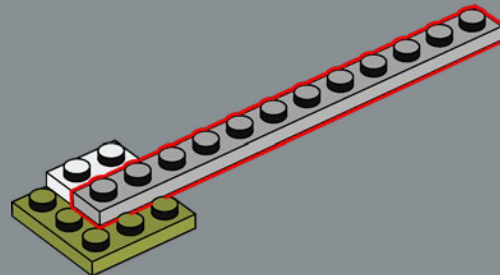



1x

33

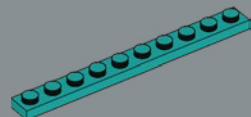
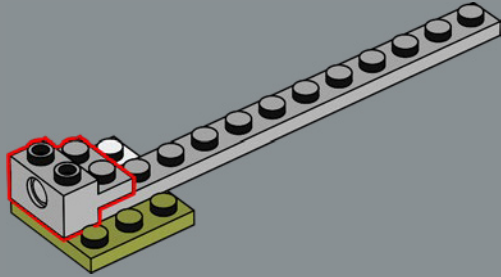

1x

35

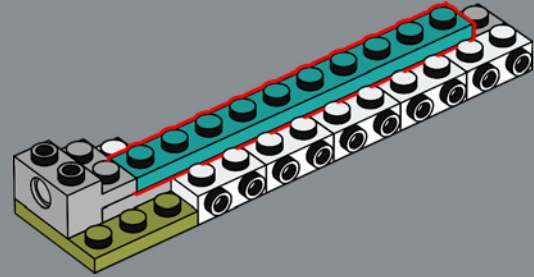

5x

34

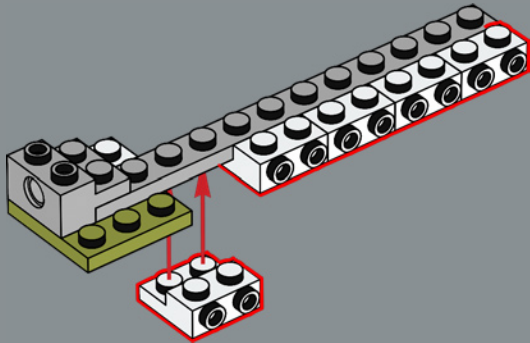

1x



1x



1x

36

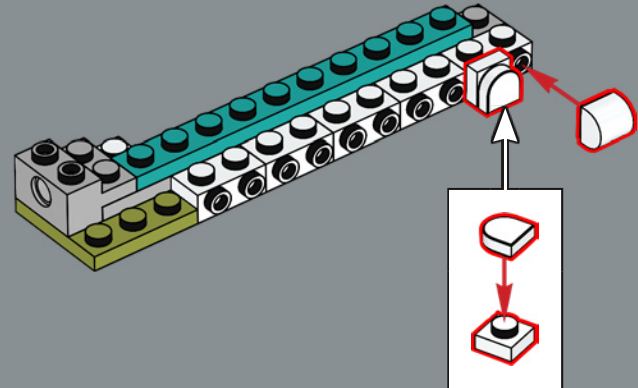



37

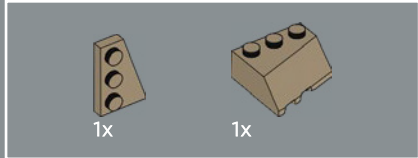
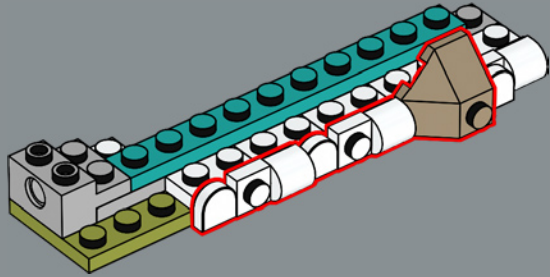

38

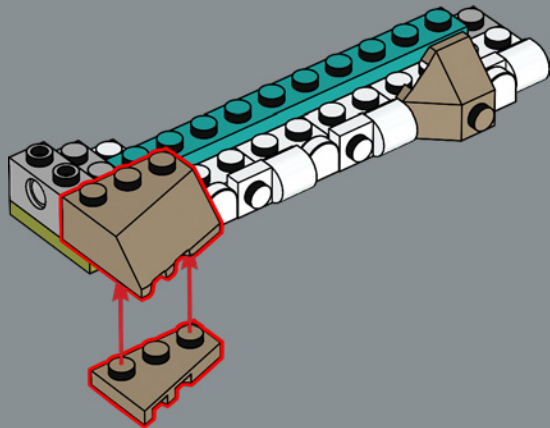

39

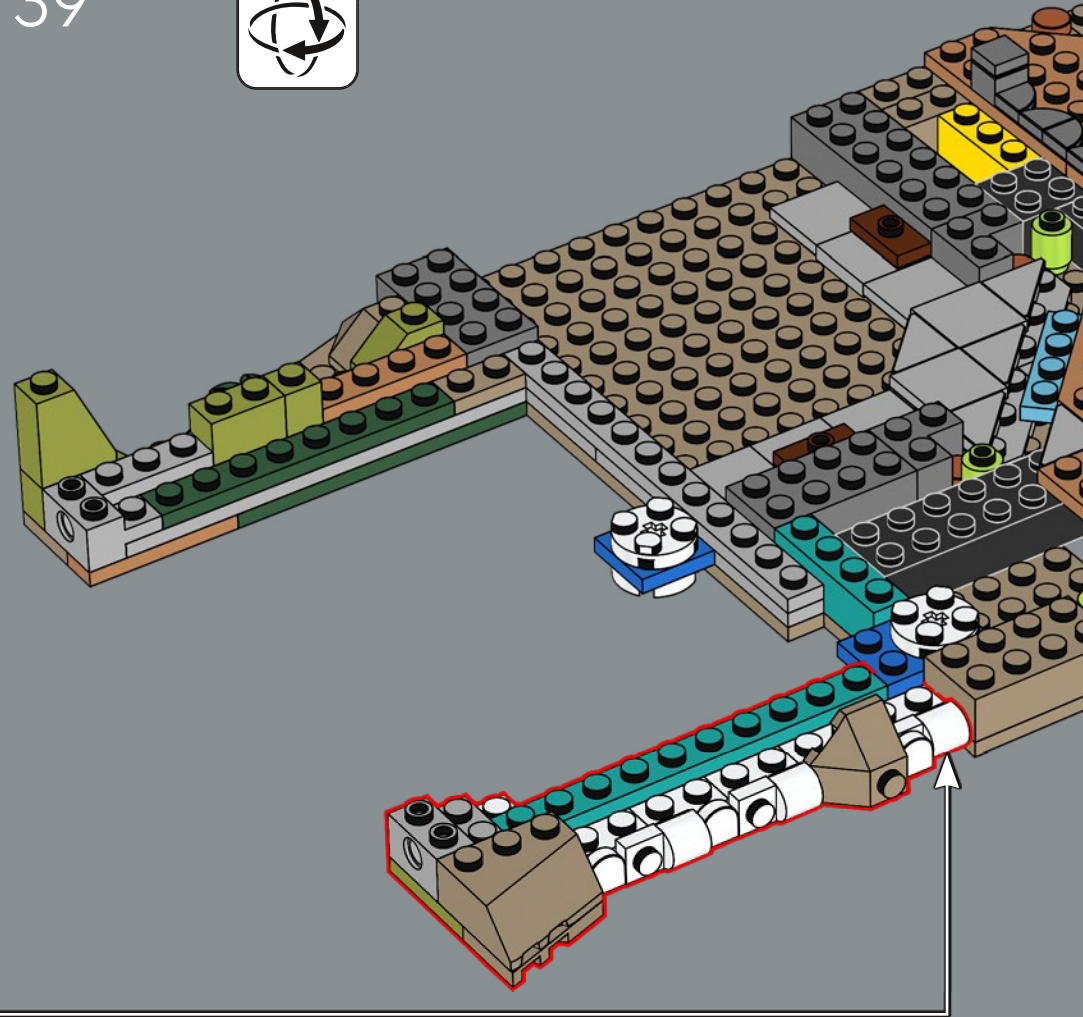

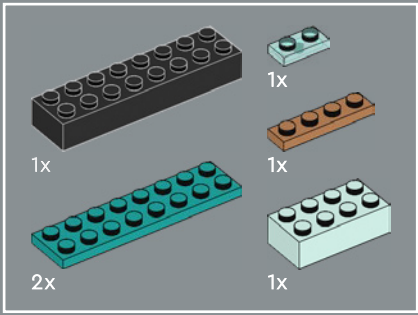

40

1

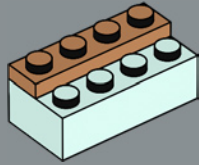

2

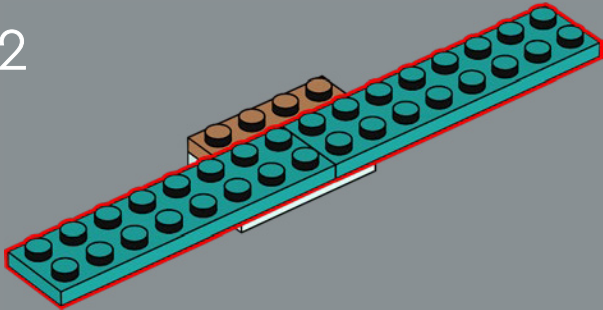

3

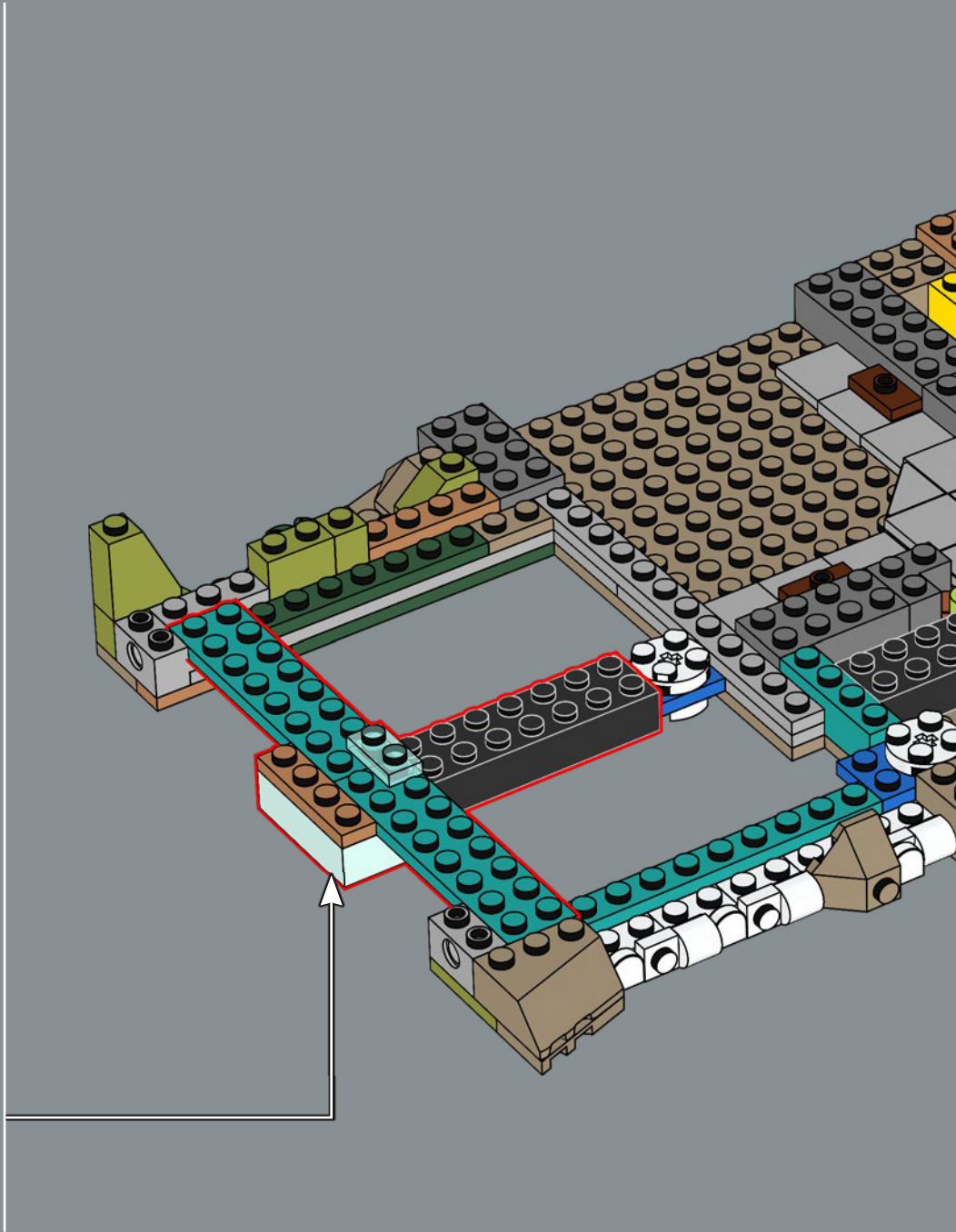
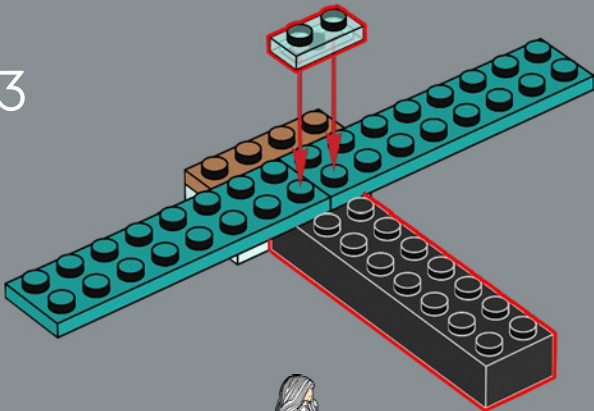

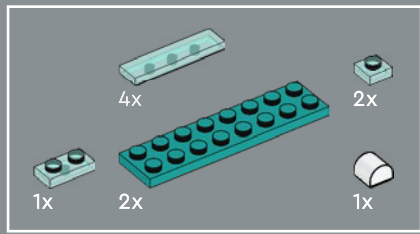

41

1

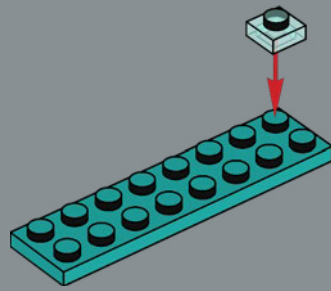

2

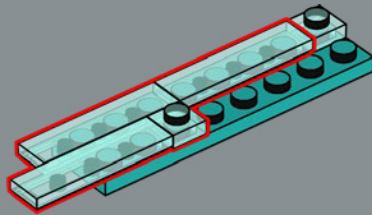

3

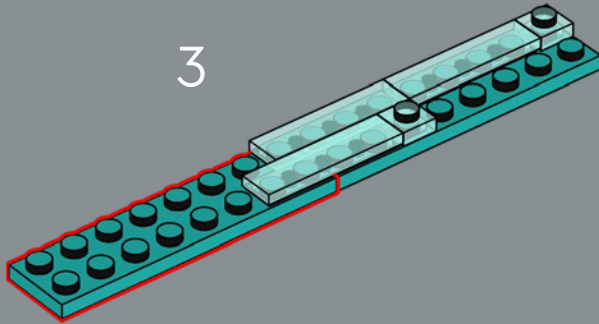

4

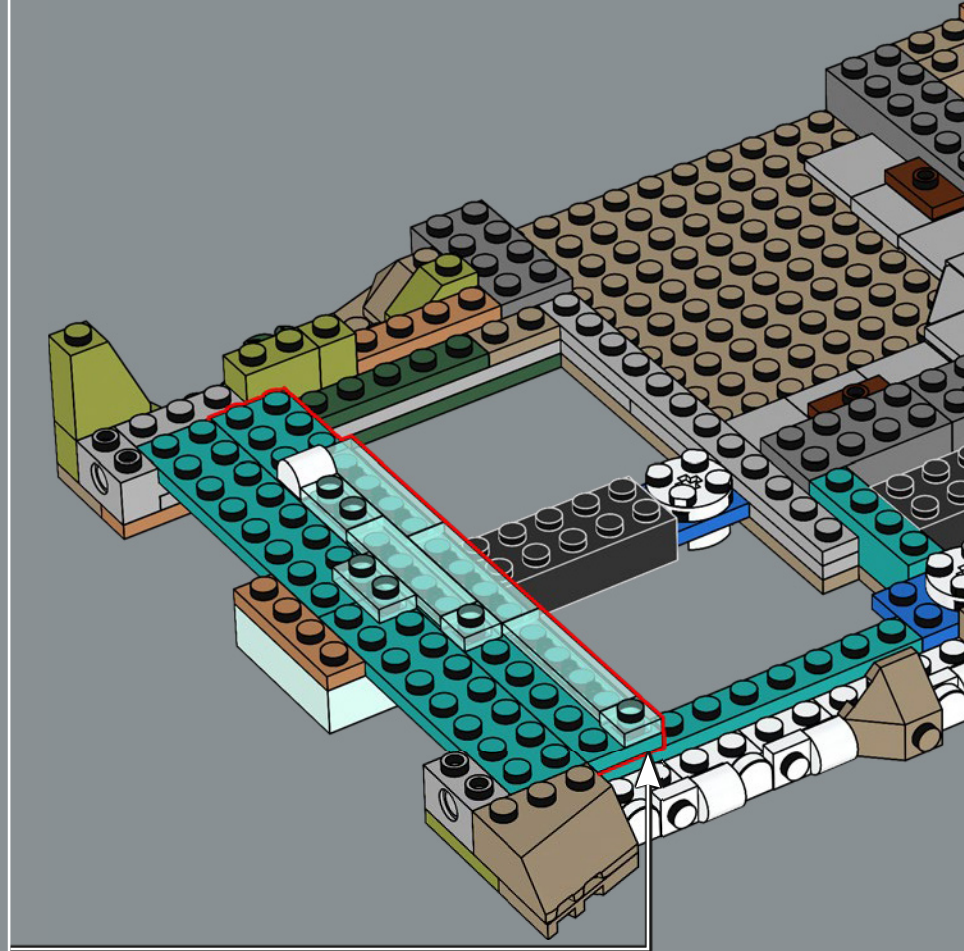
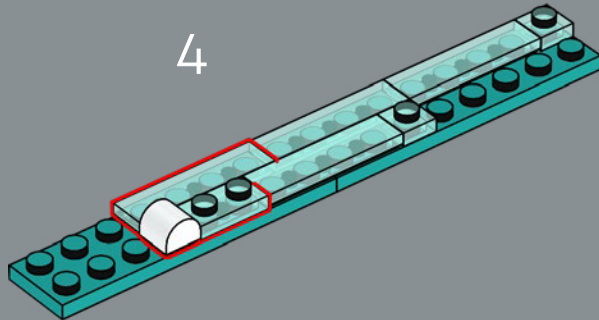

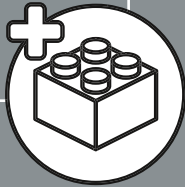
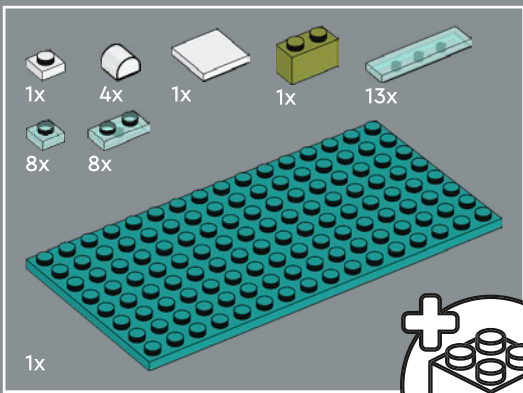

42

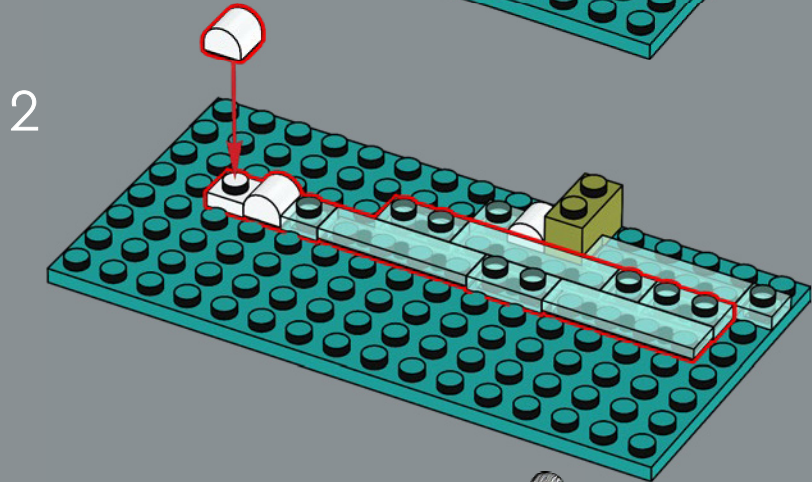
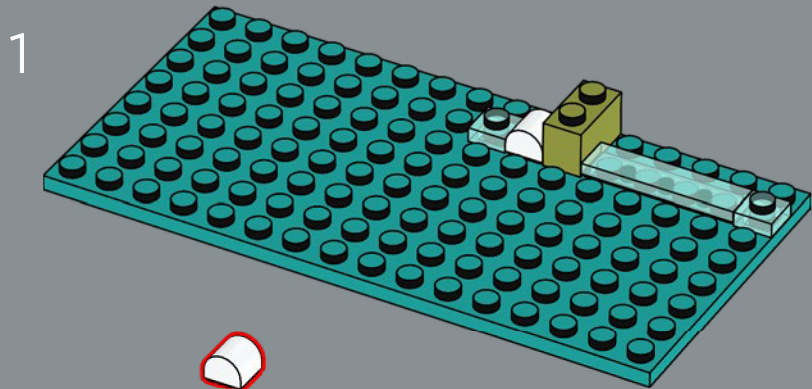

3

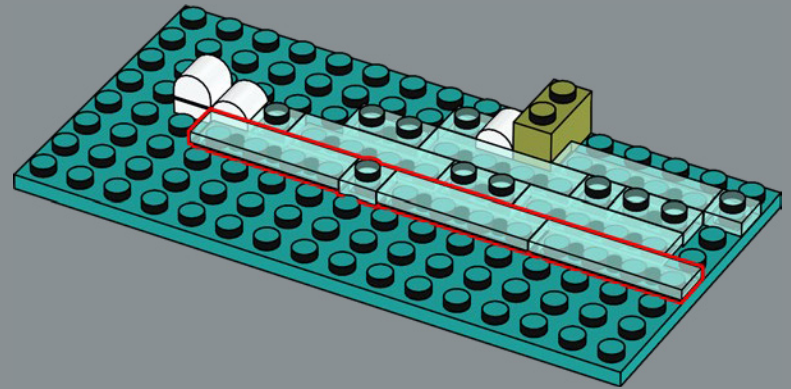

4

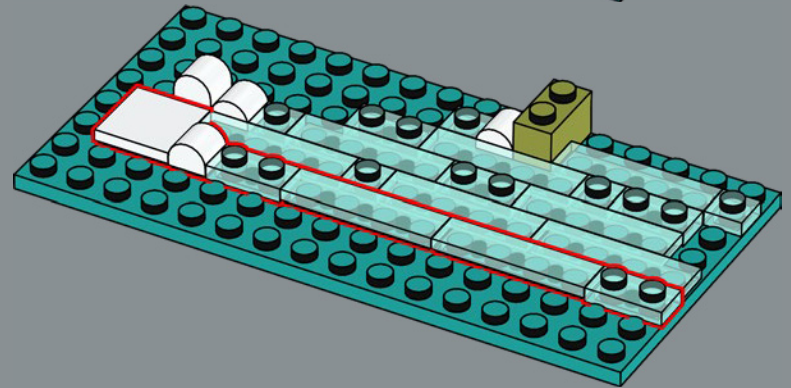

5

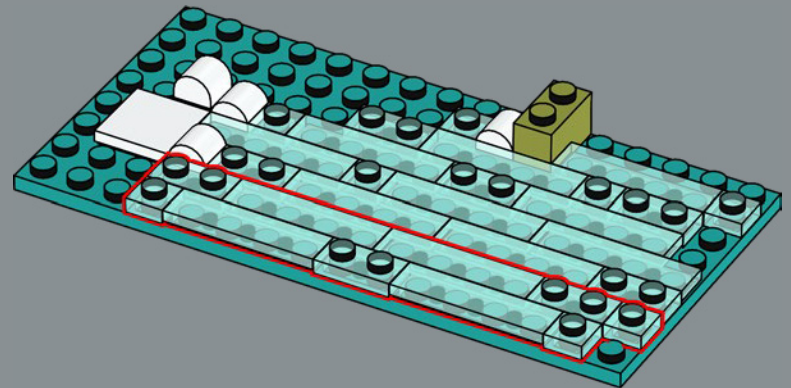

43

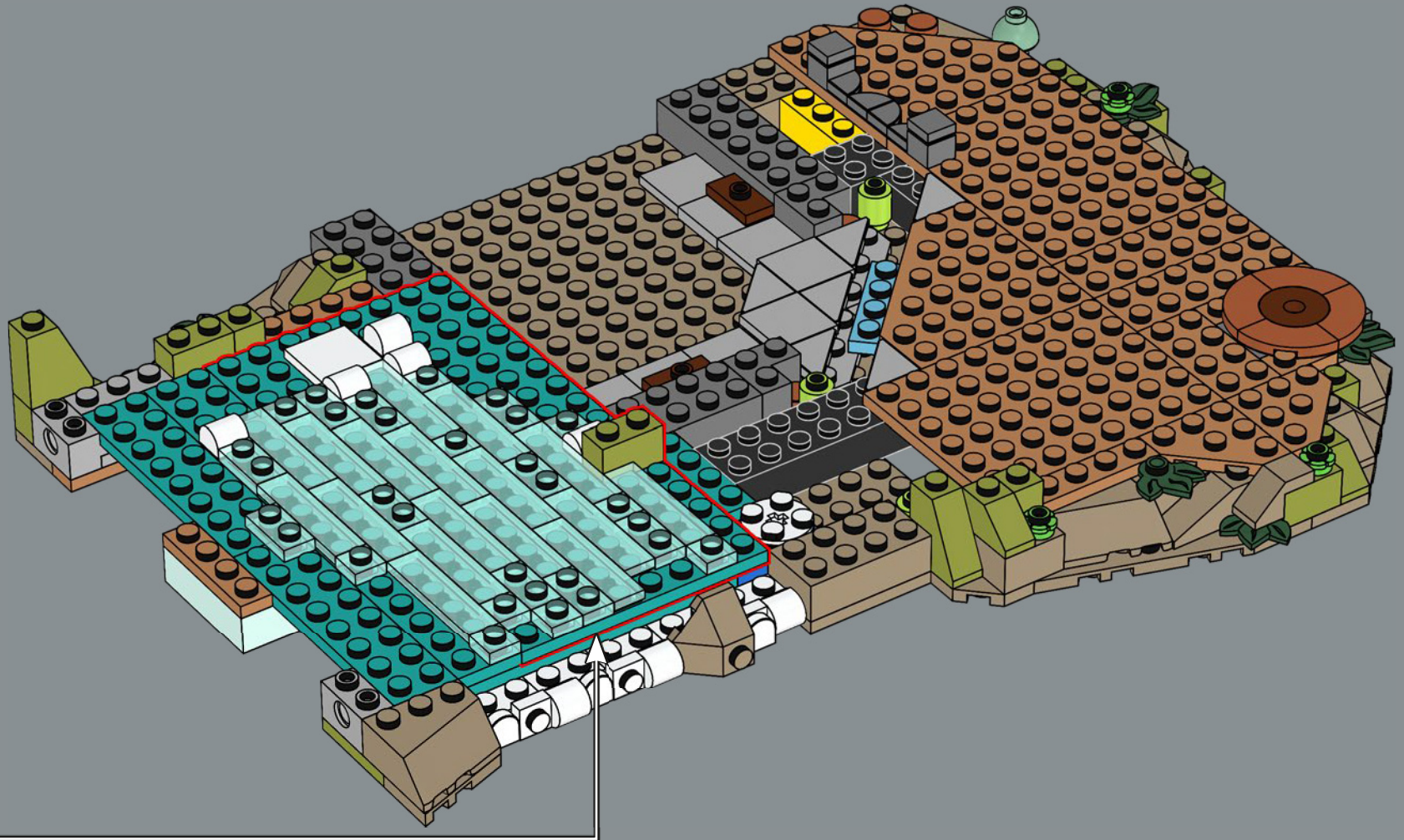

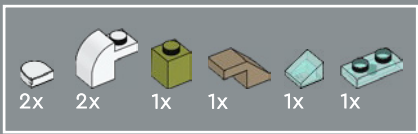

44

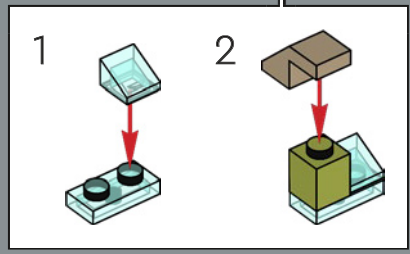
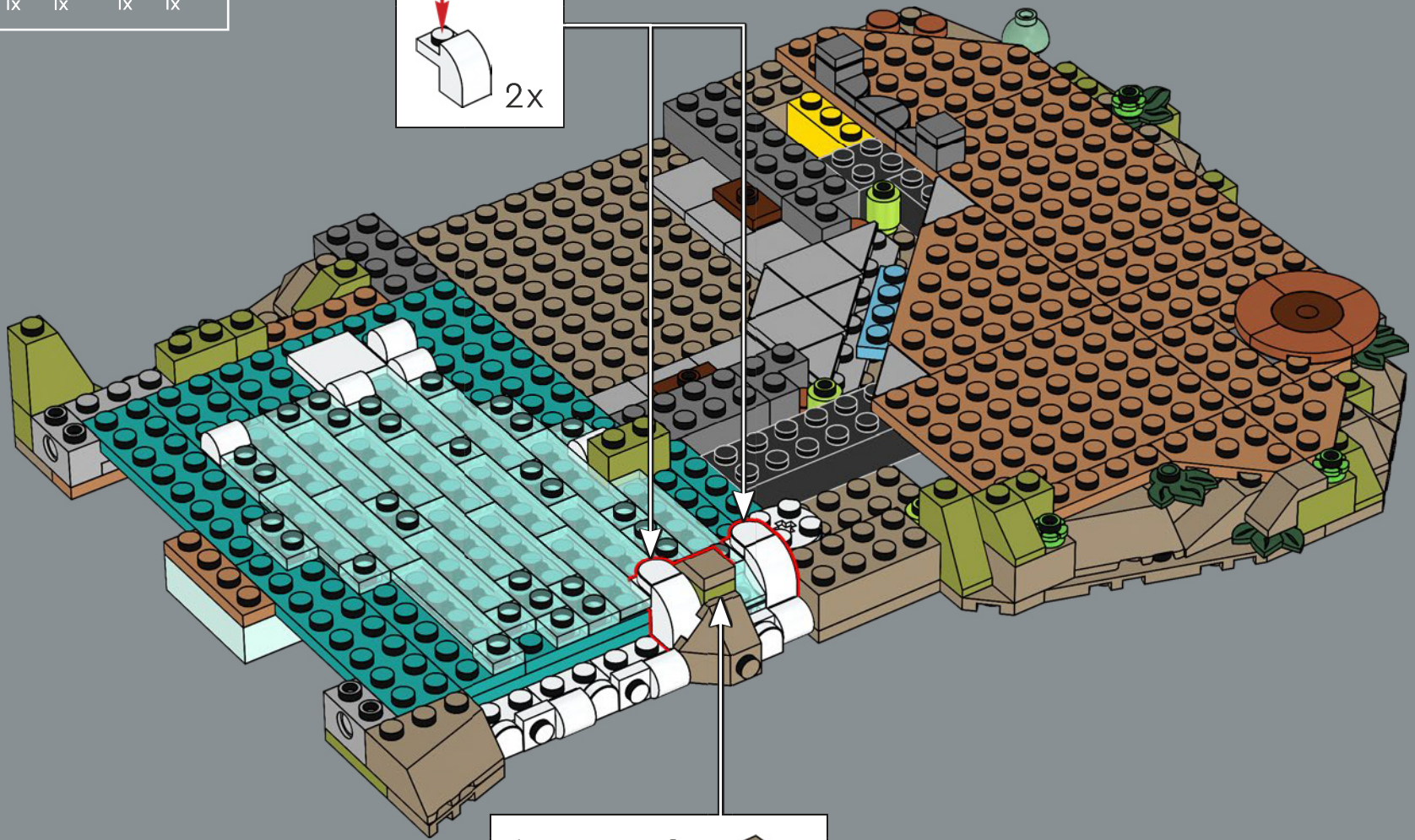
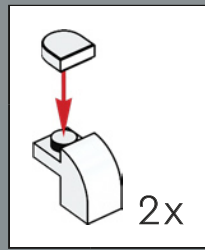

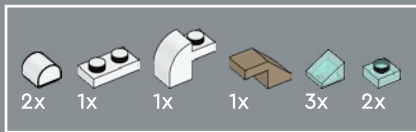

45

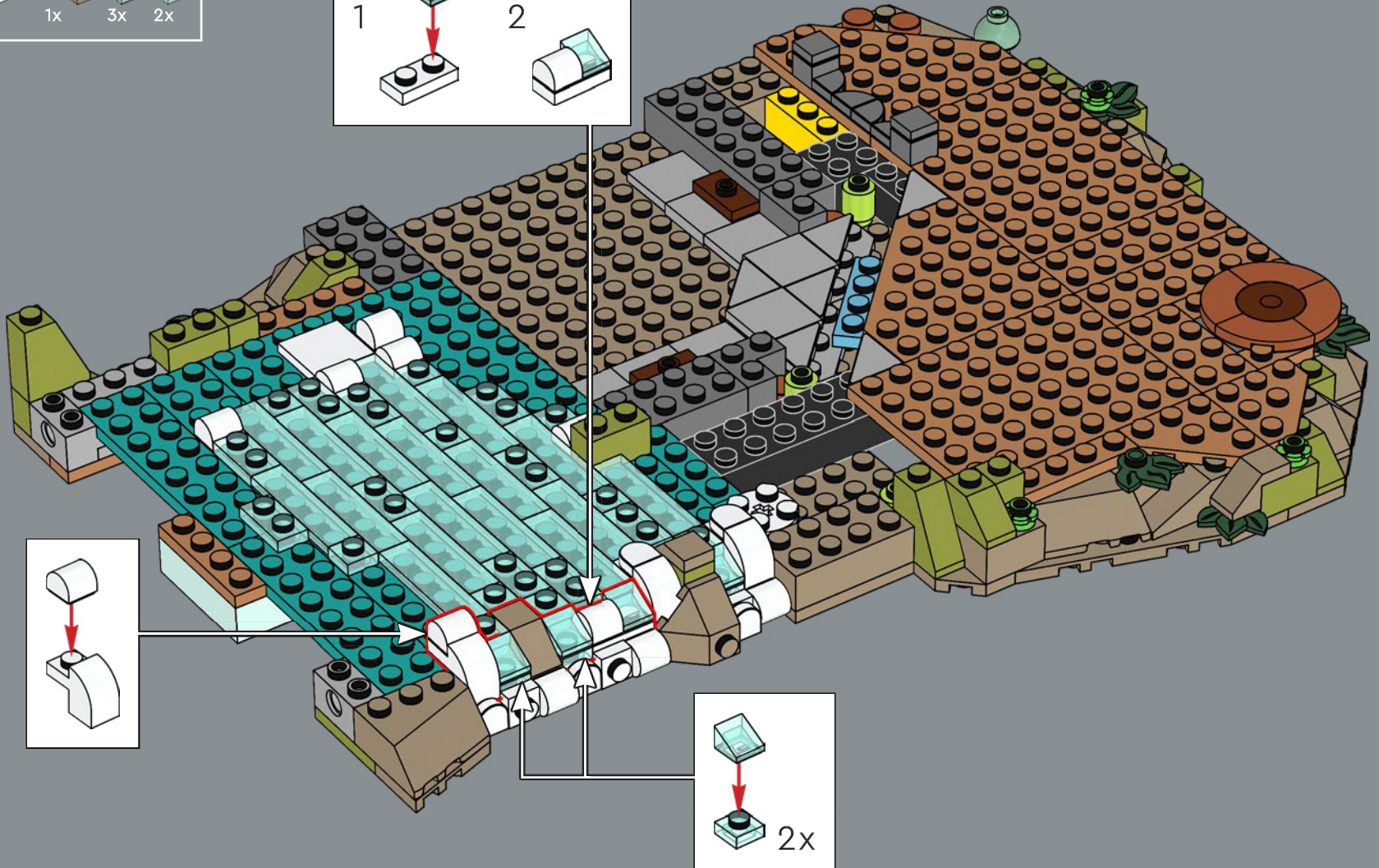
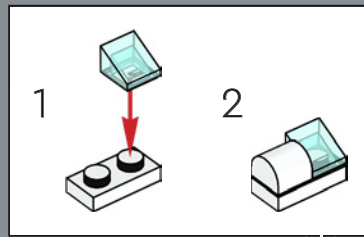



46

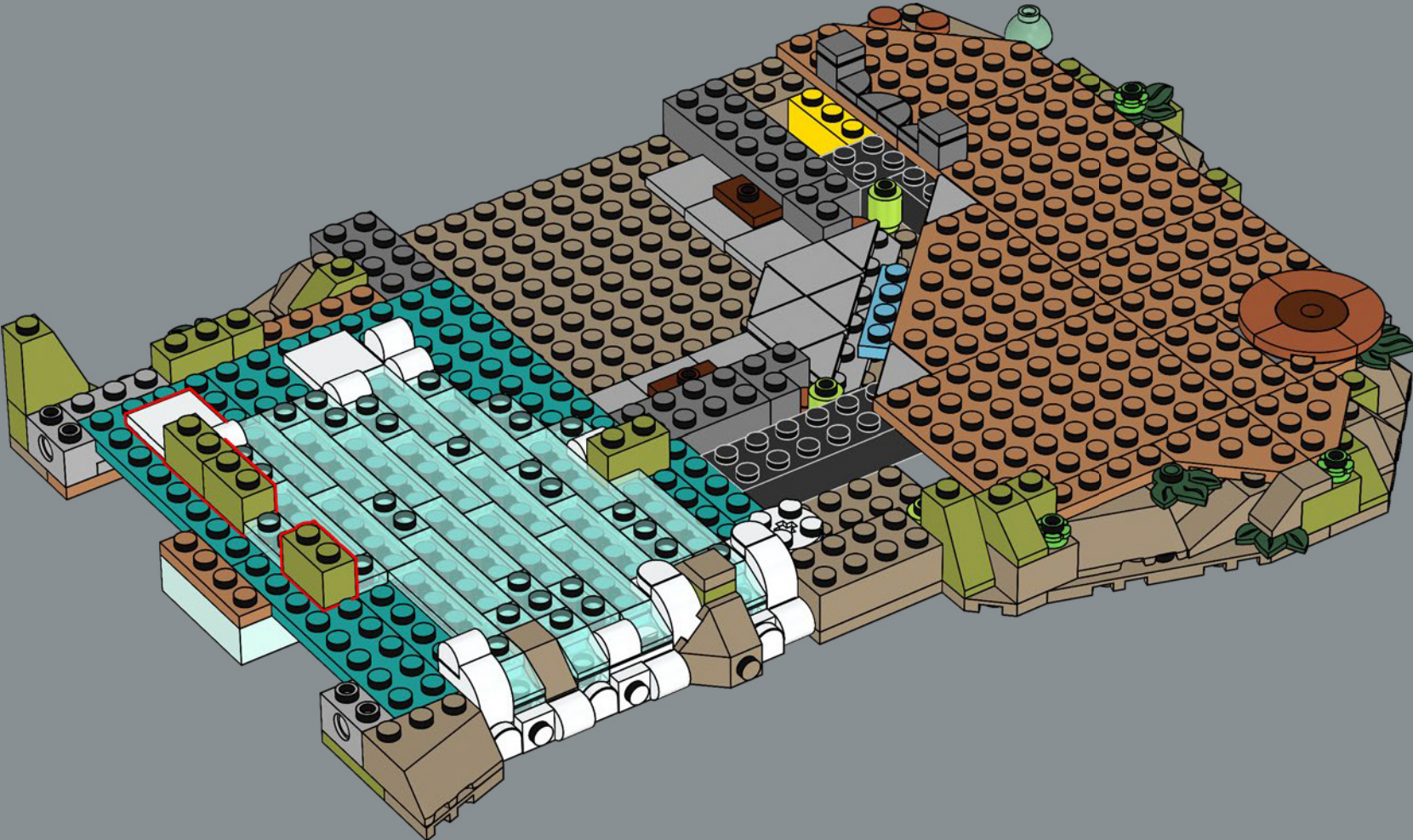

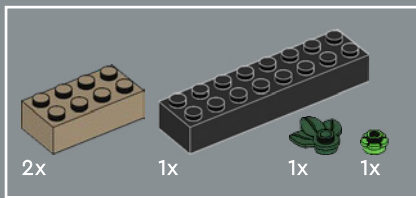

47



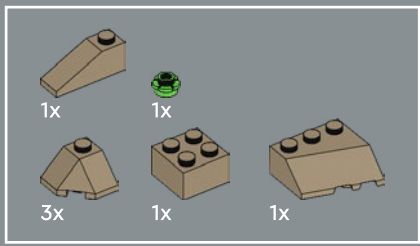

48

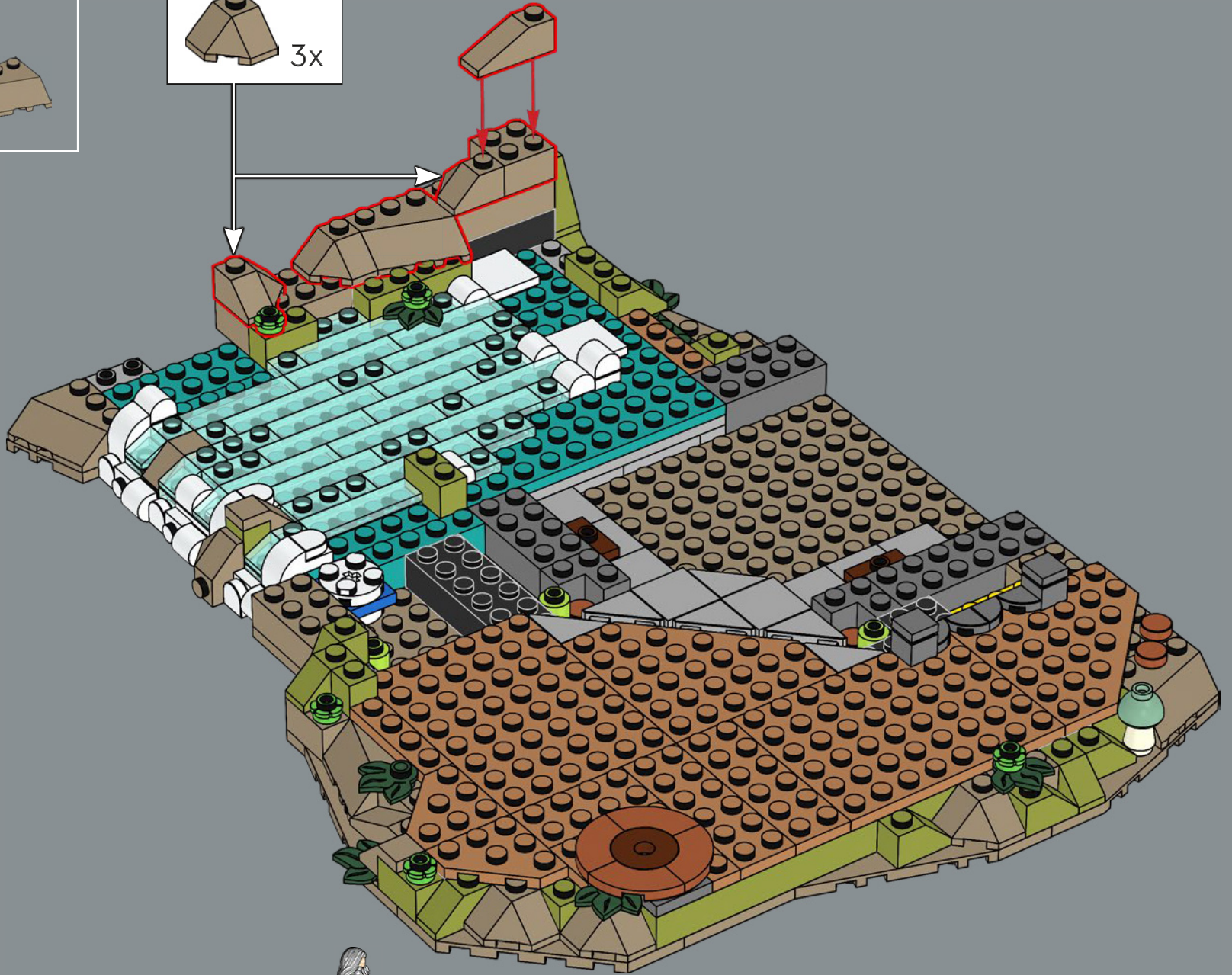

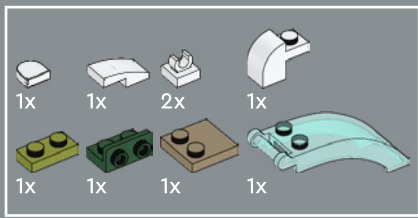

49

1

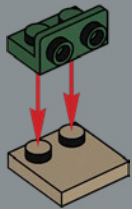

2

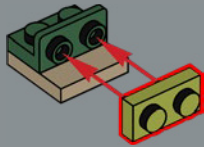

3

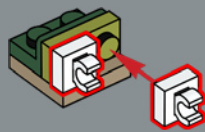

4

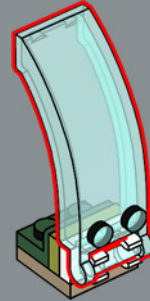

5



6

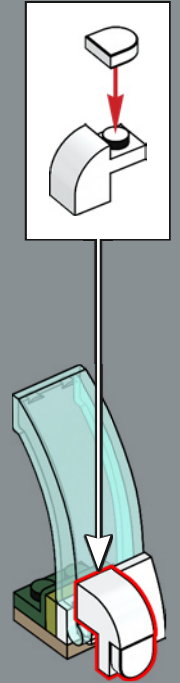

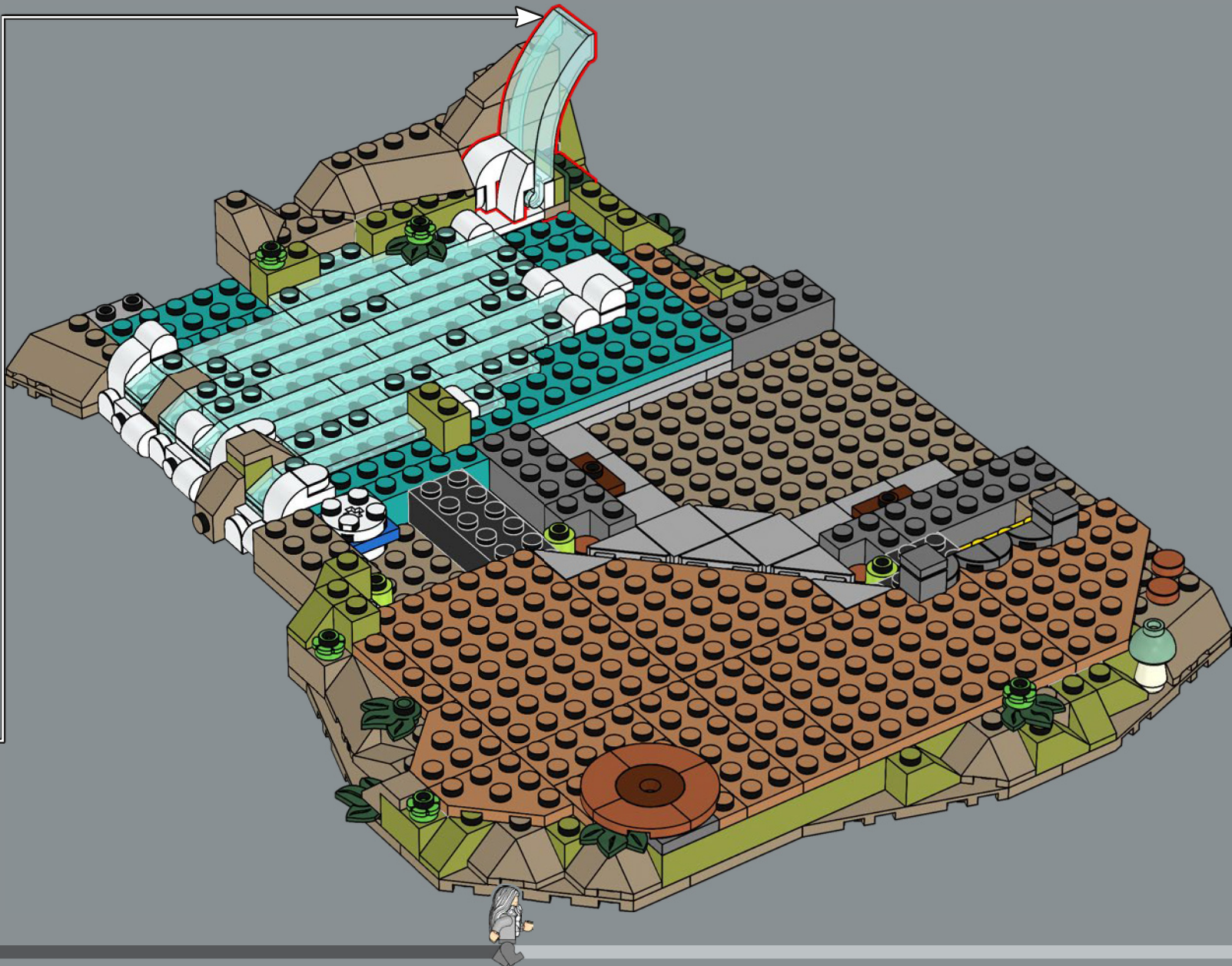

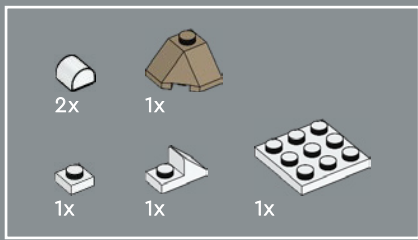

50

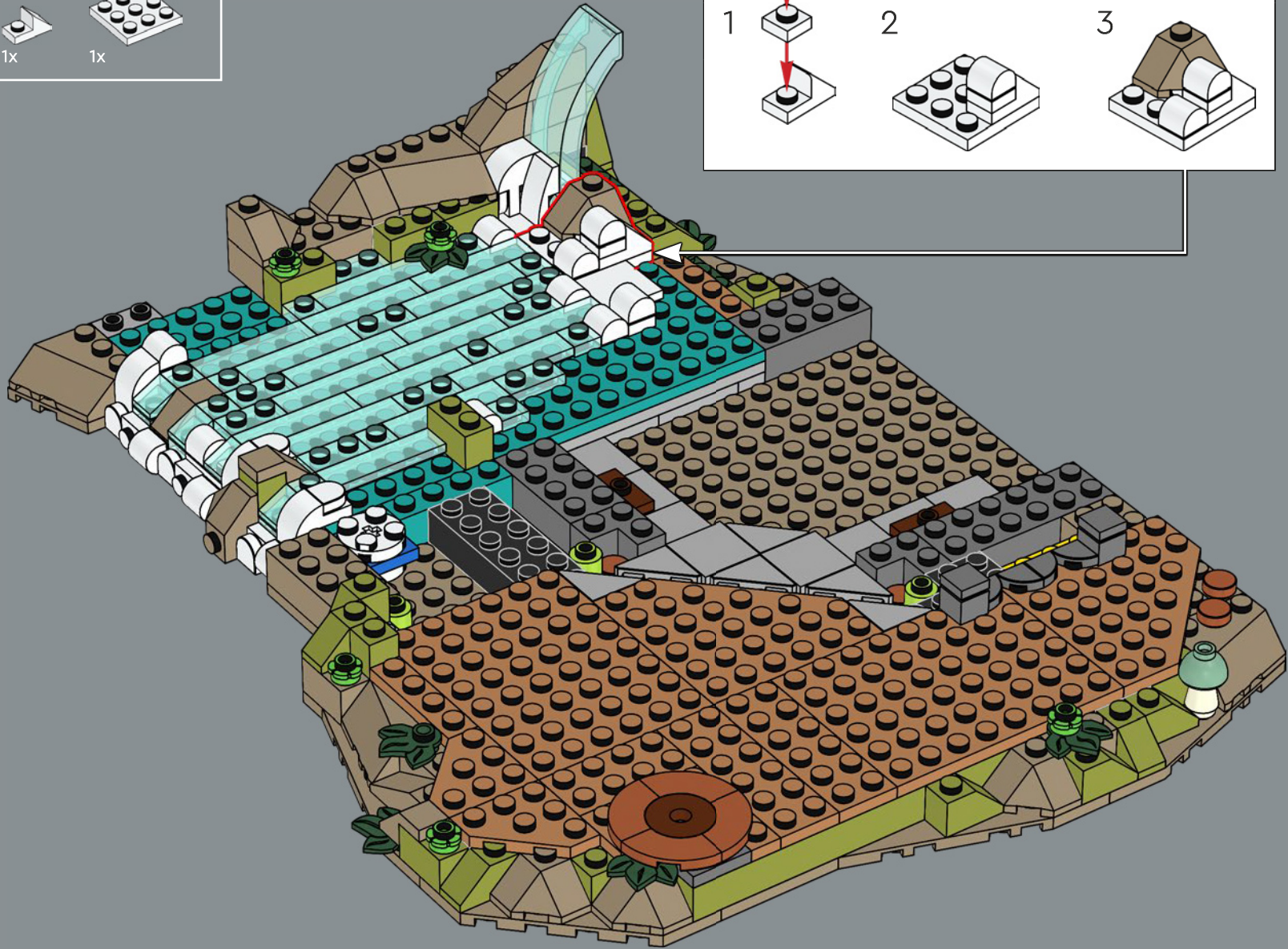
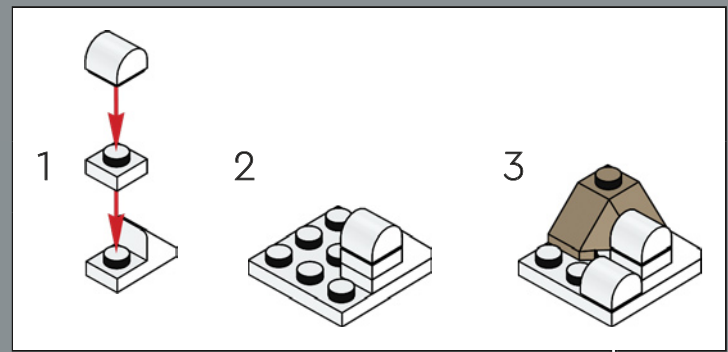

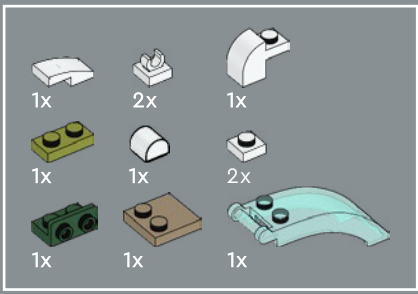

51

1

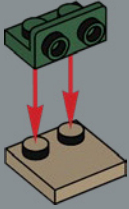

2

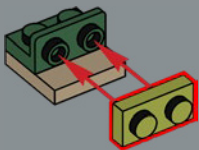

3

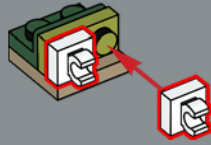

4



5

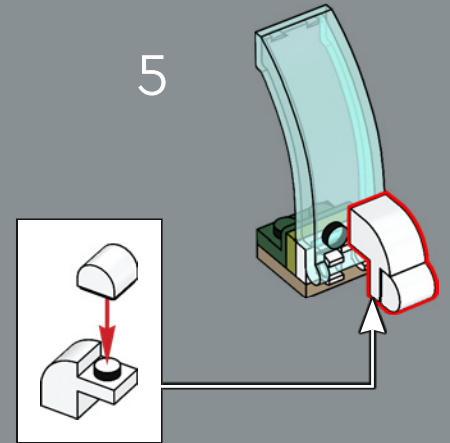

6

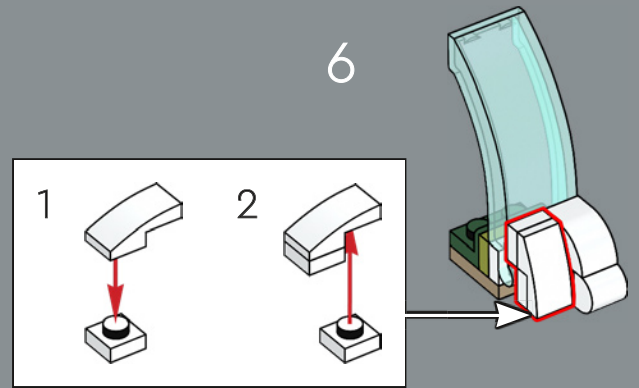

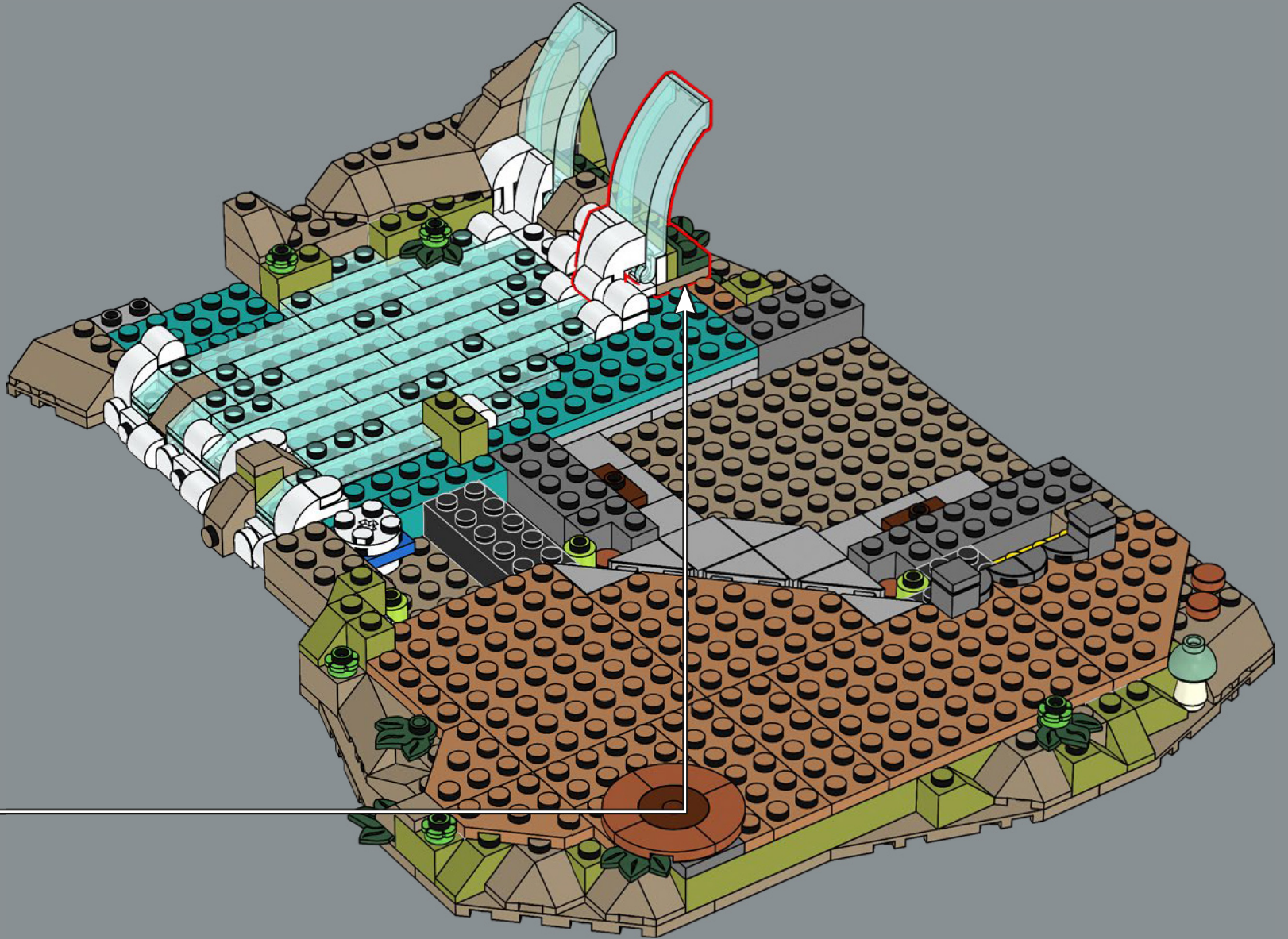

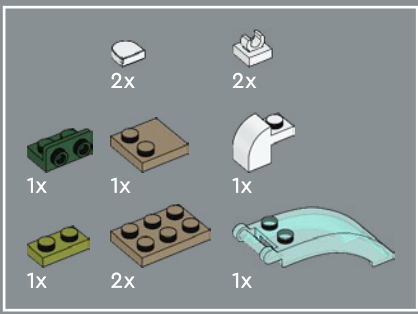

52

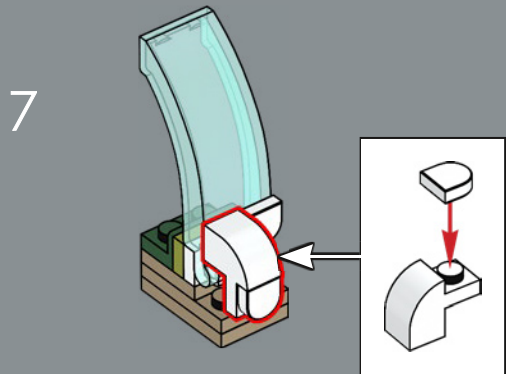
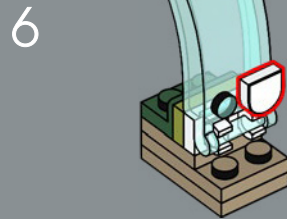
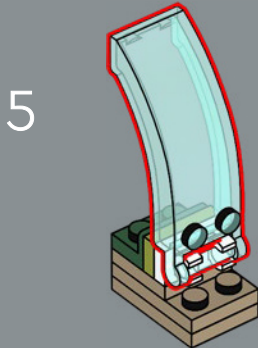
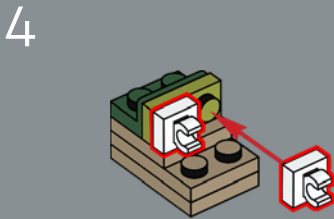
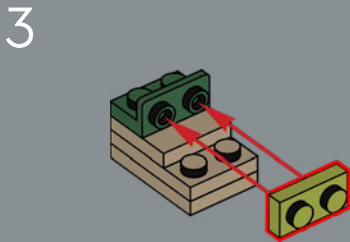
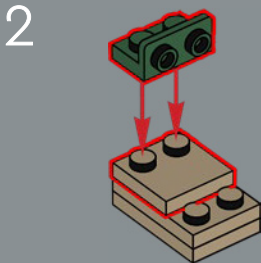
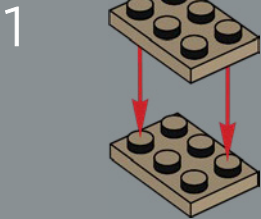

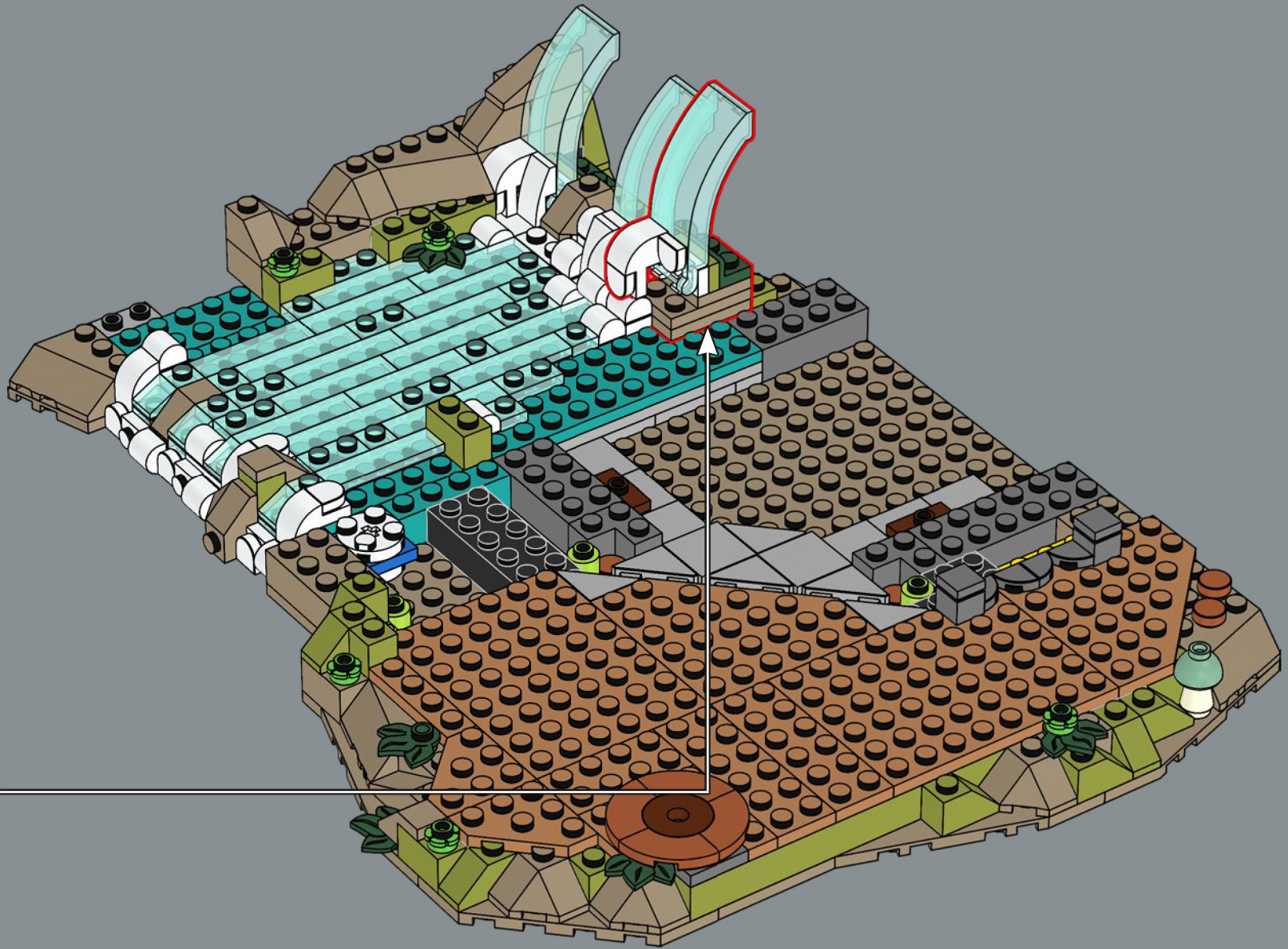

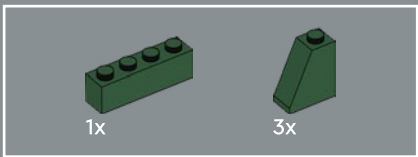

53

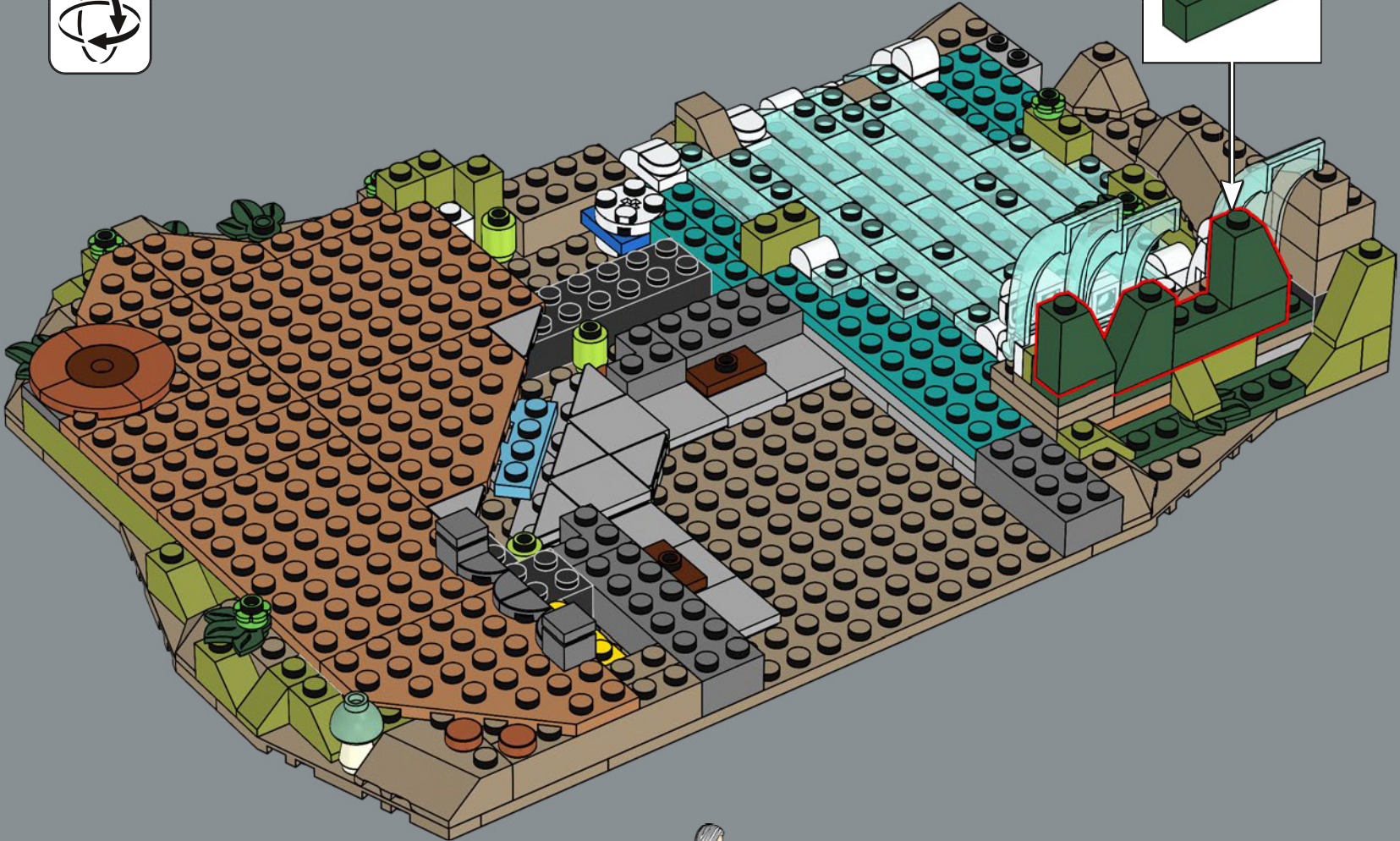
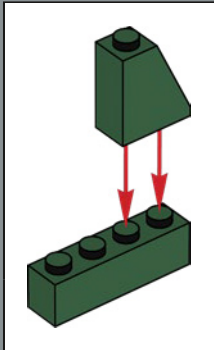



54

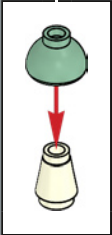
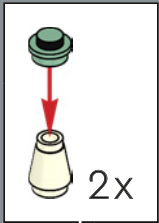
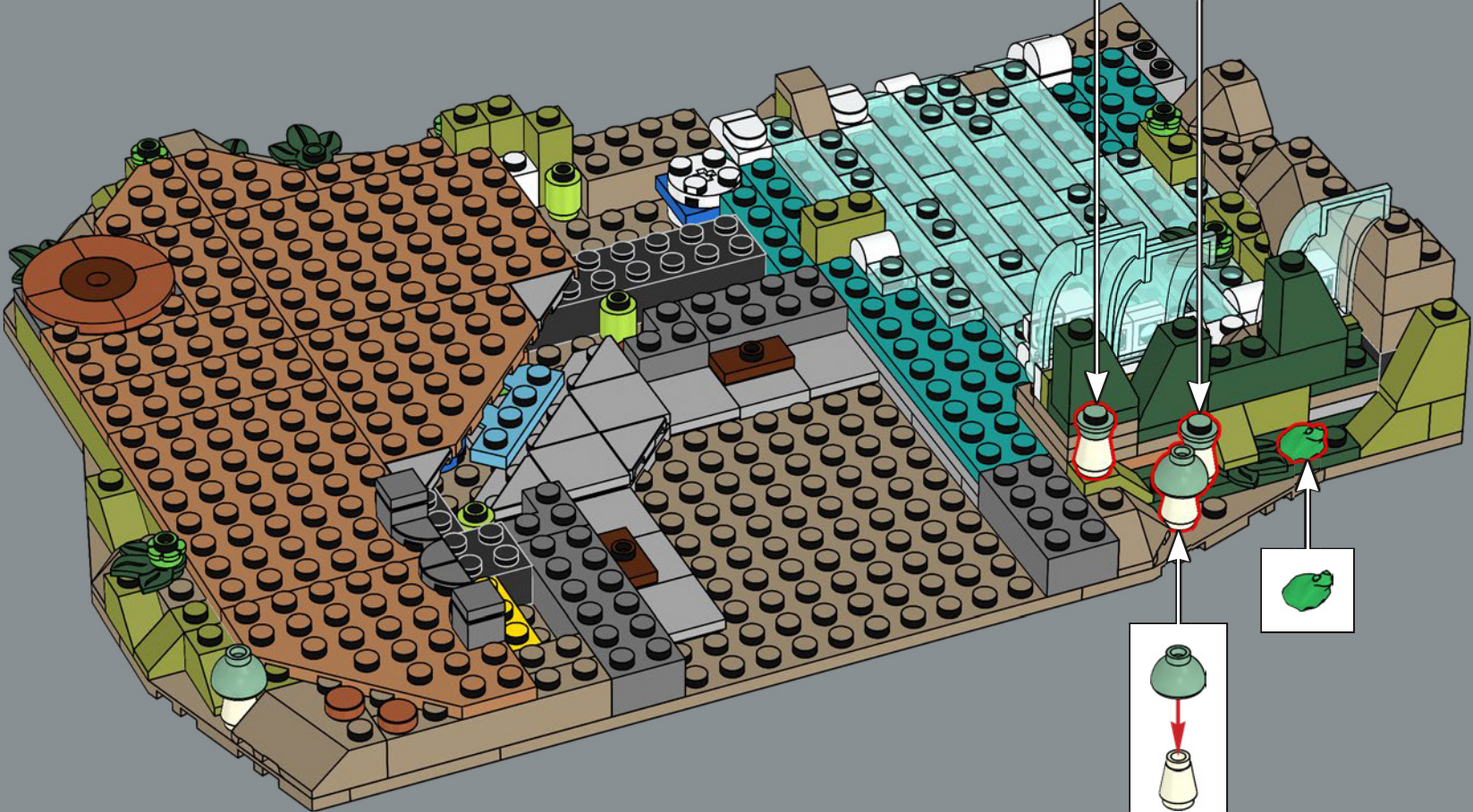

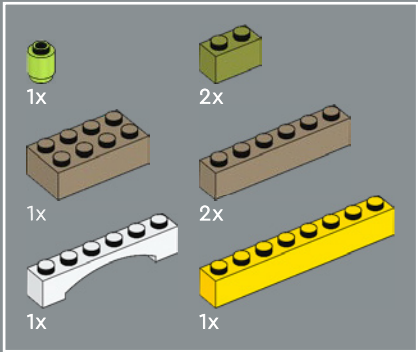
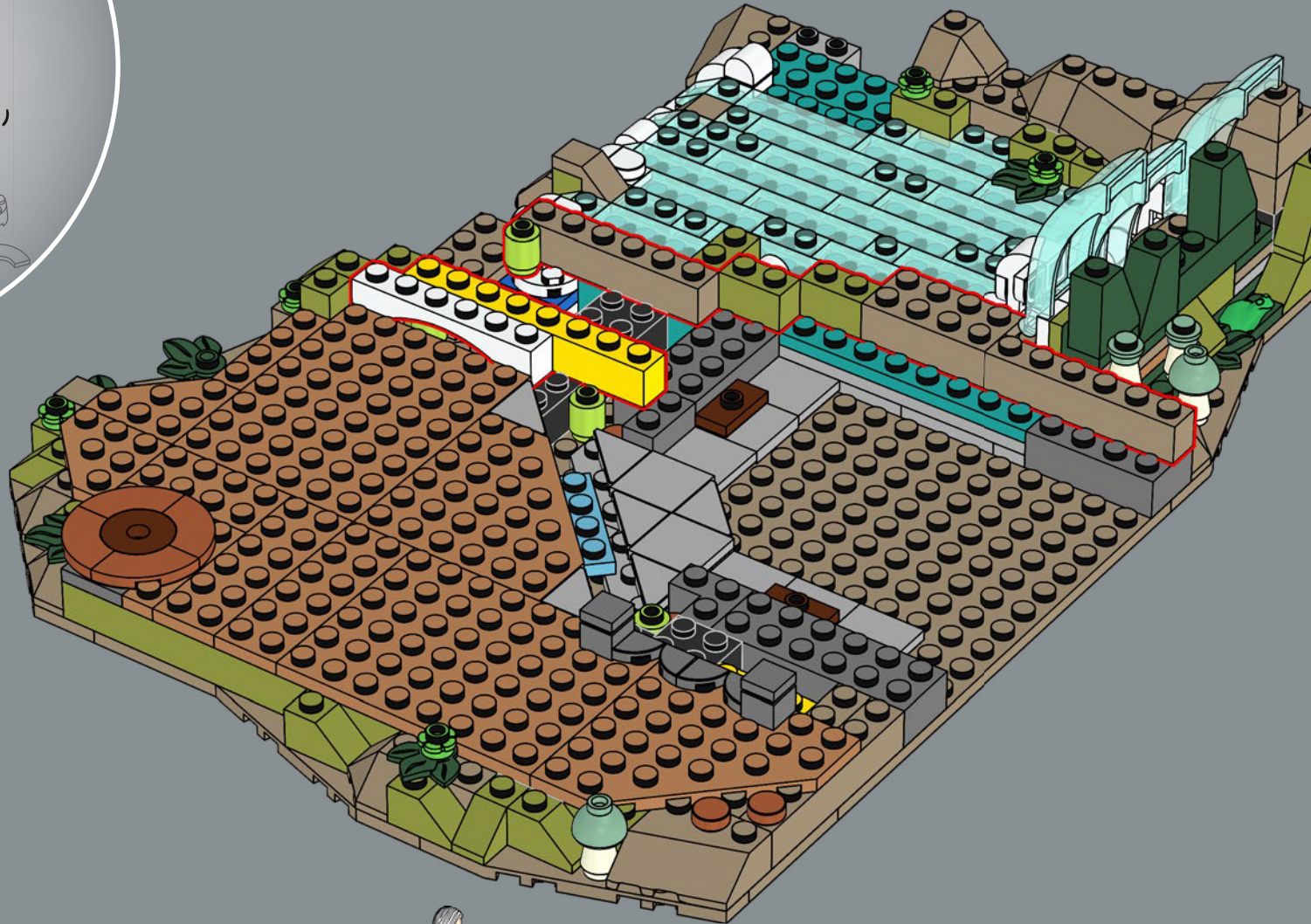

55



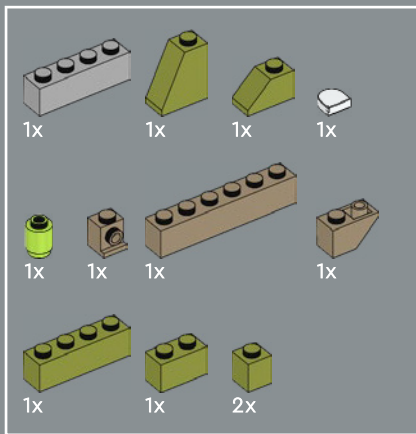

56

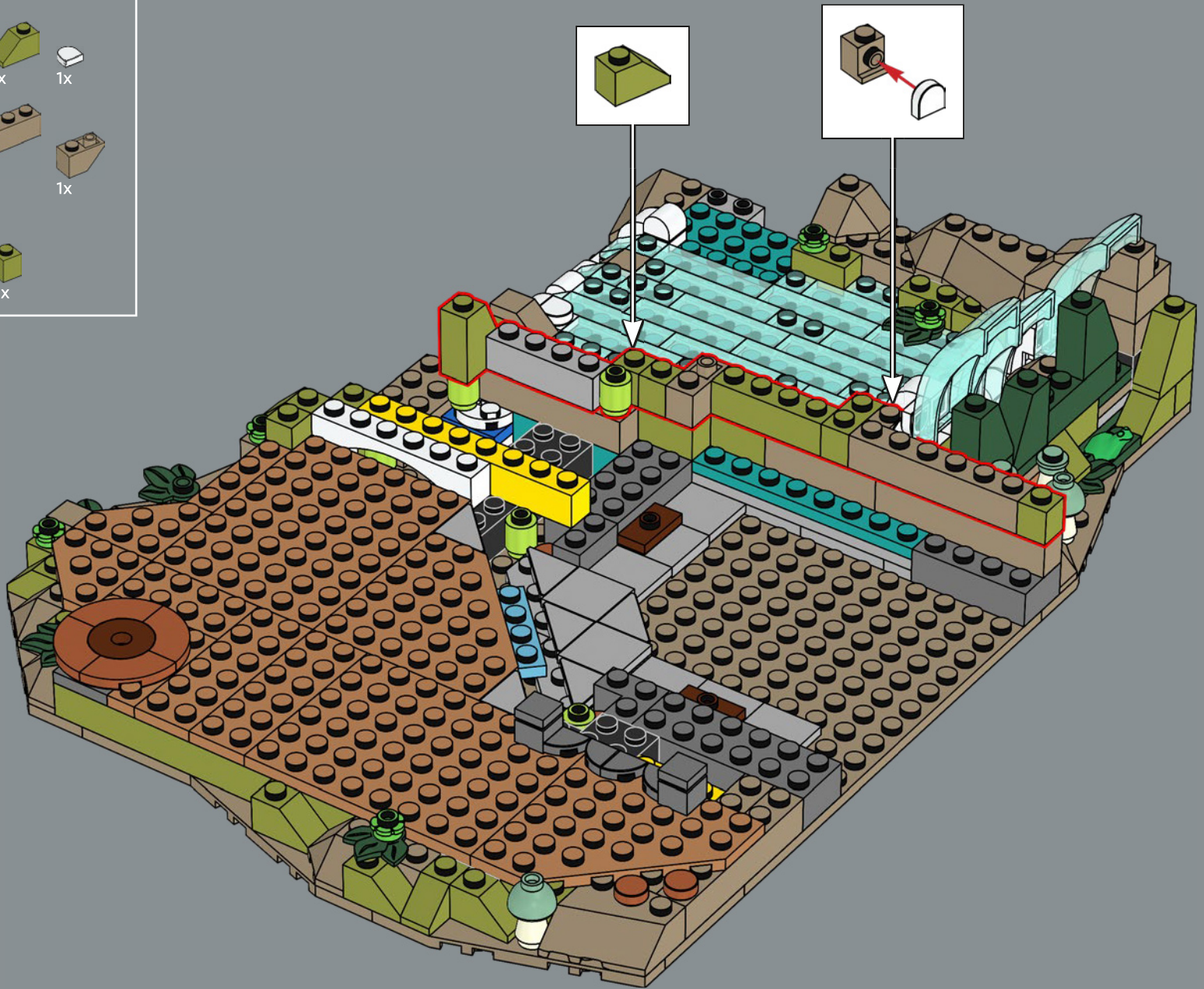

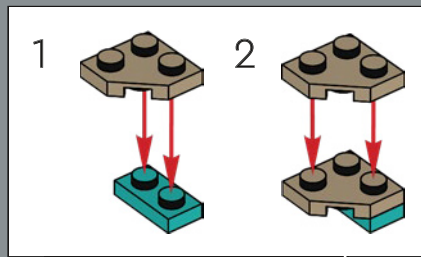
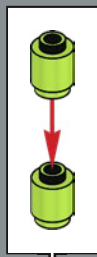
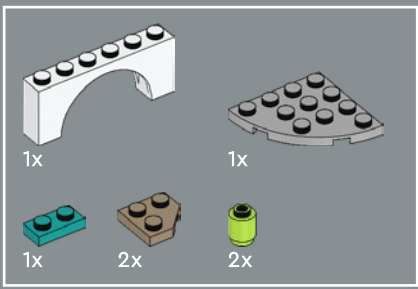

57

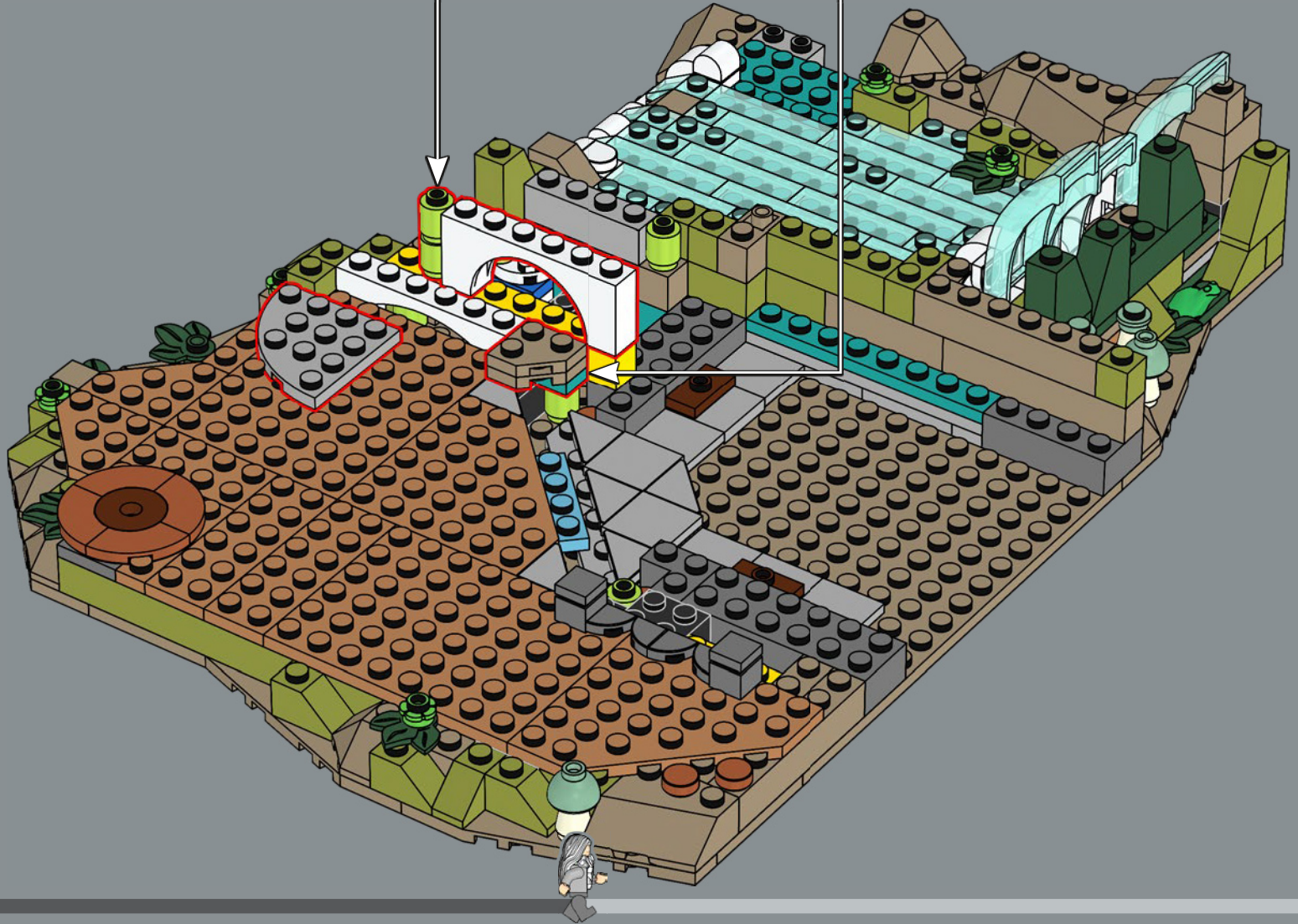

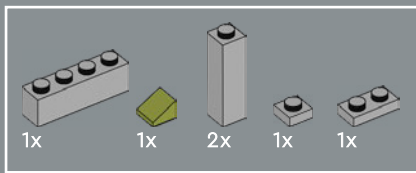

58

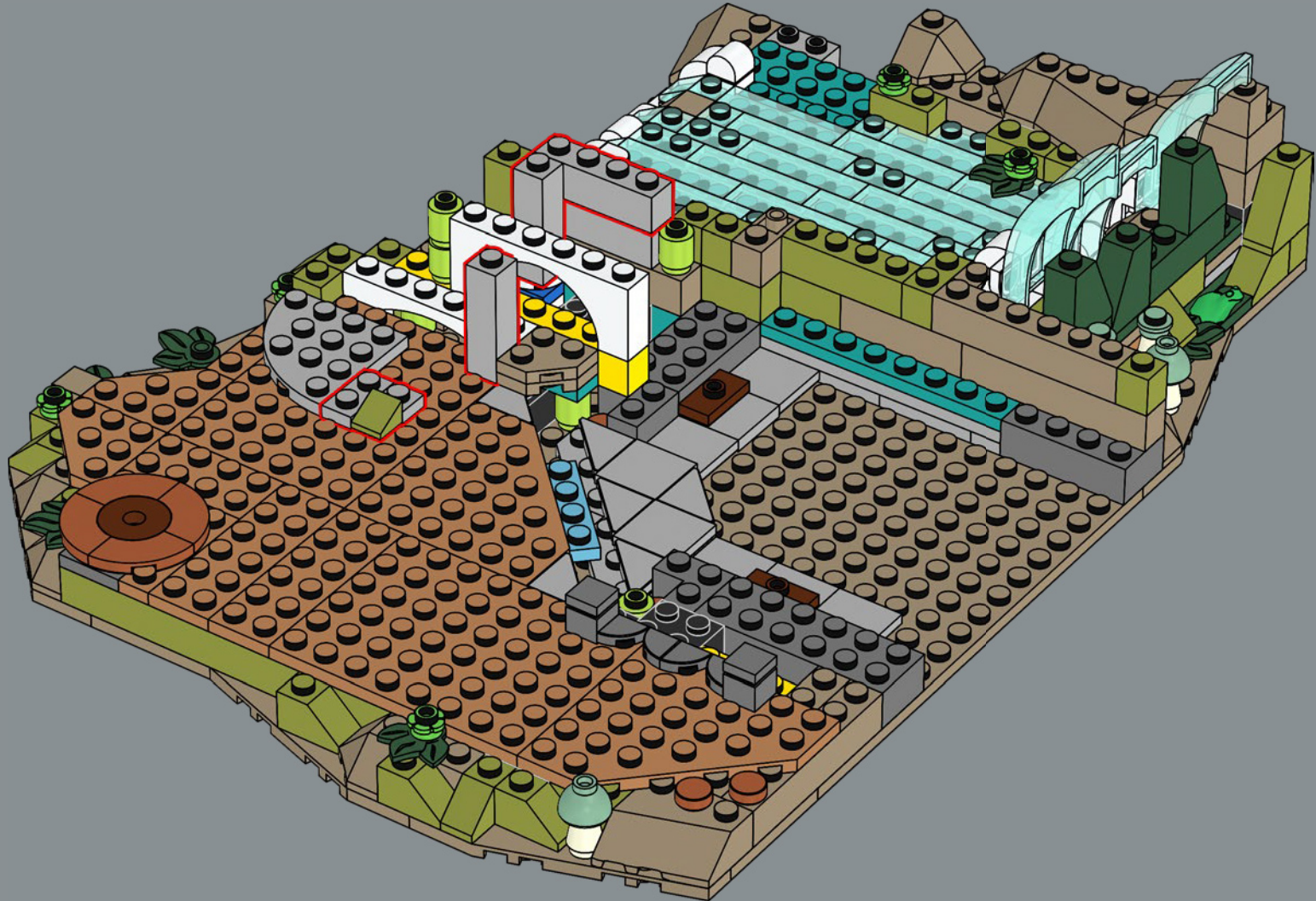

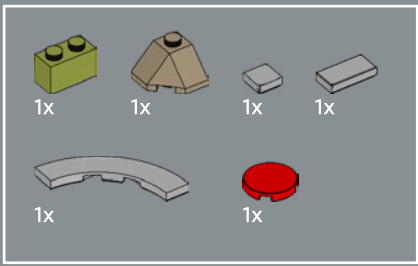

59

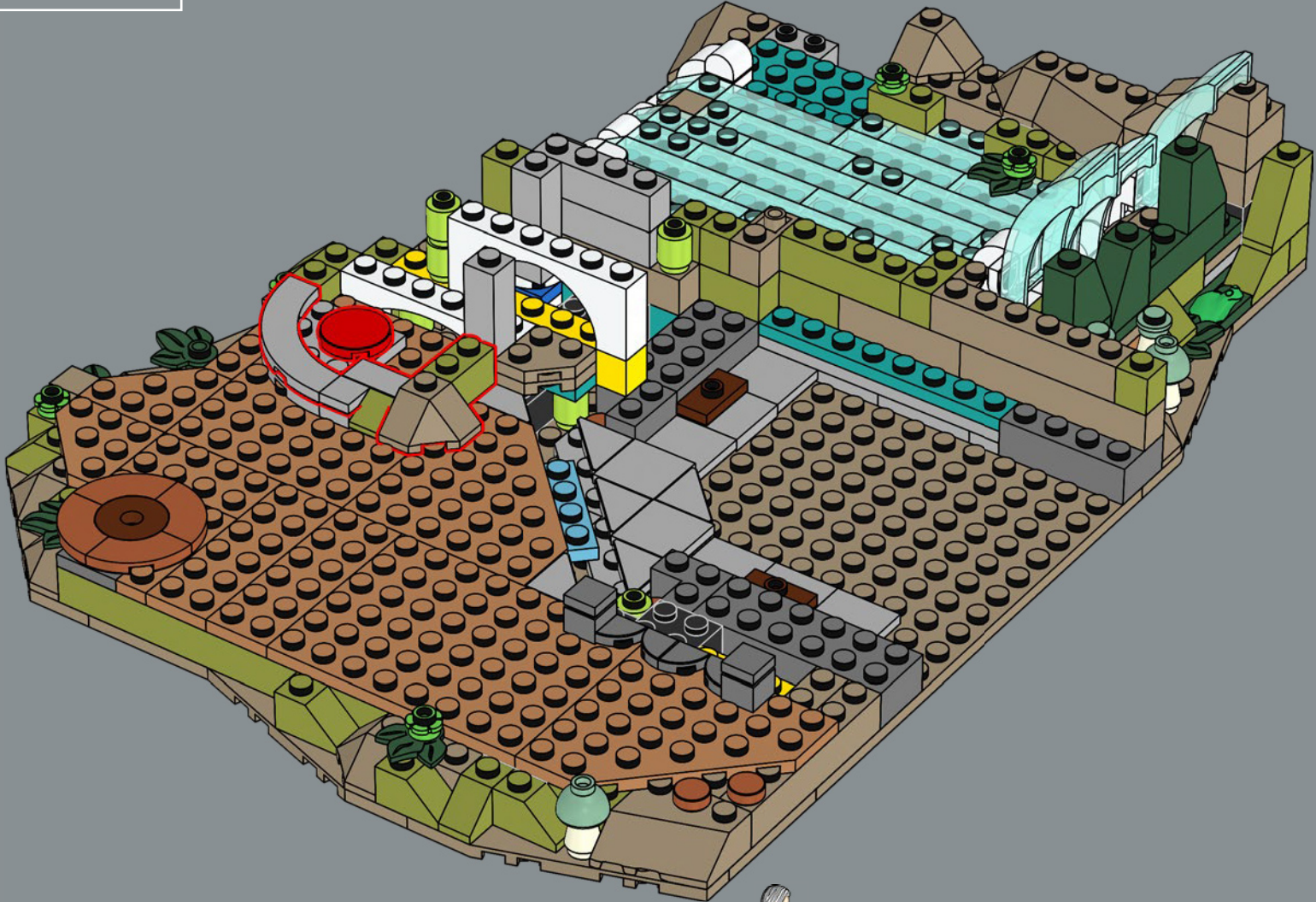

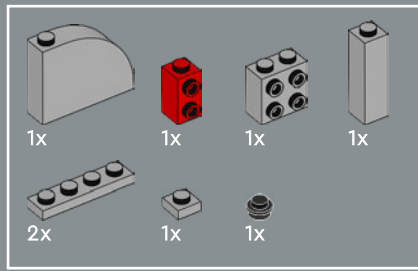

60

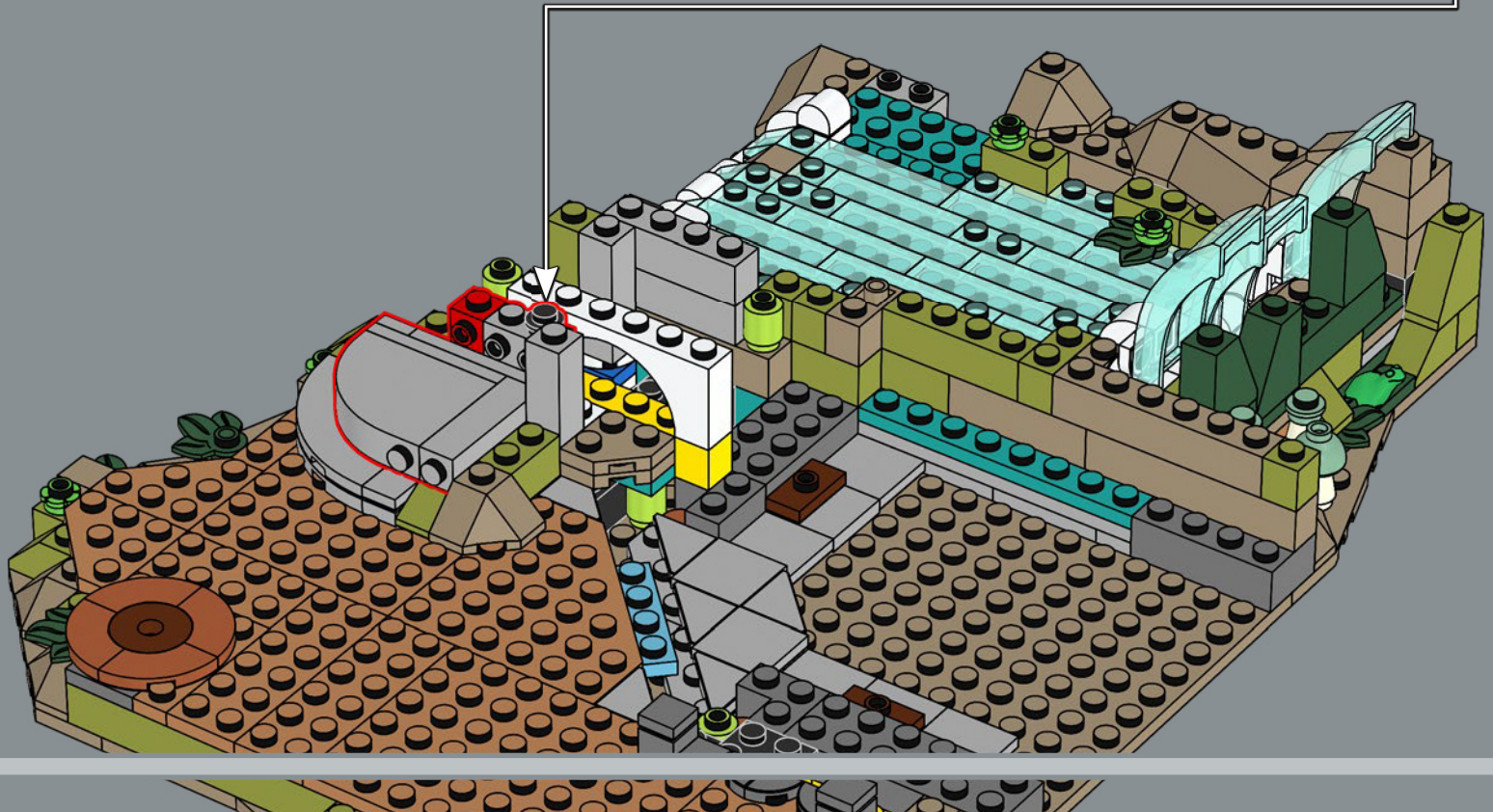
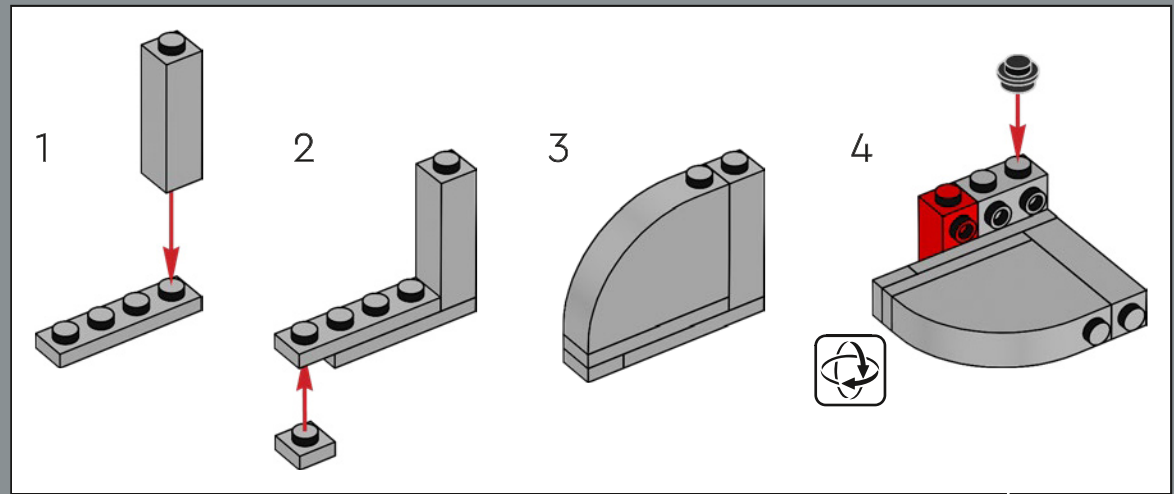

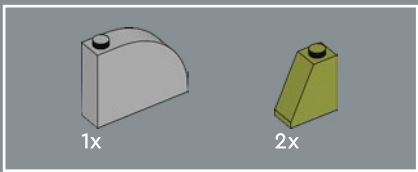

61

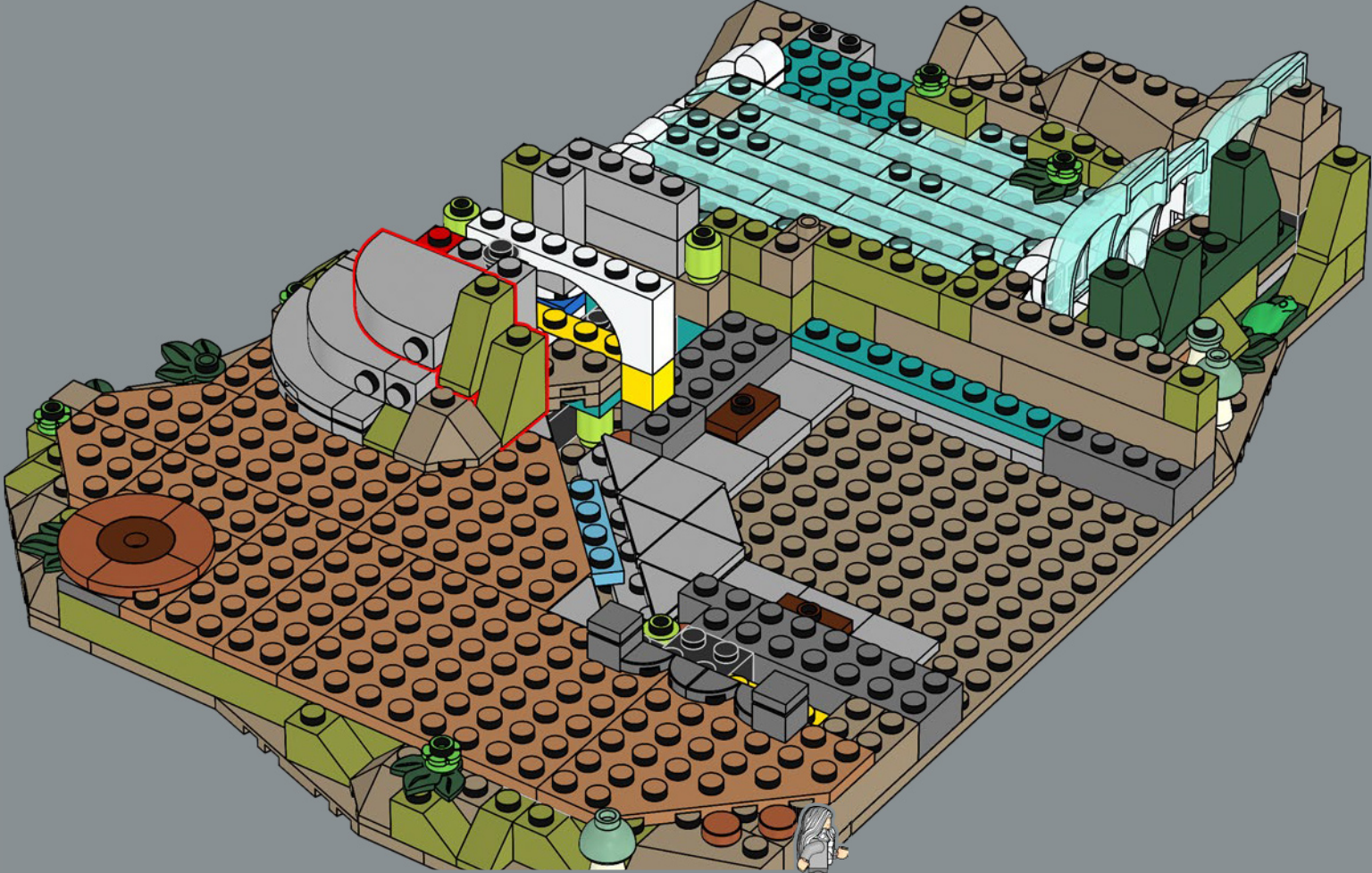

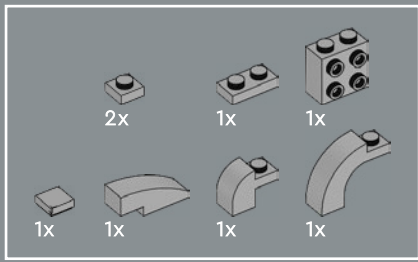

62

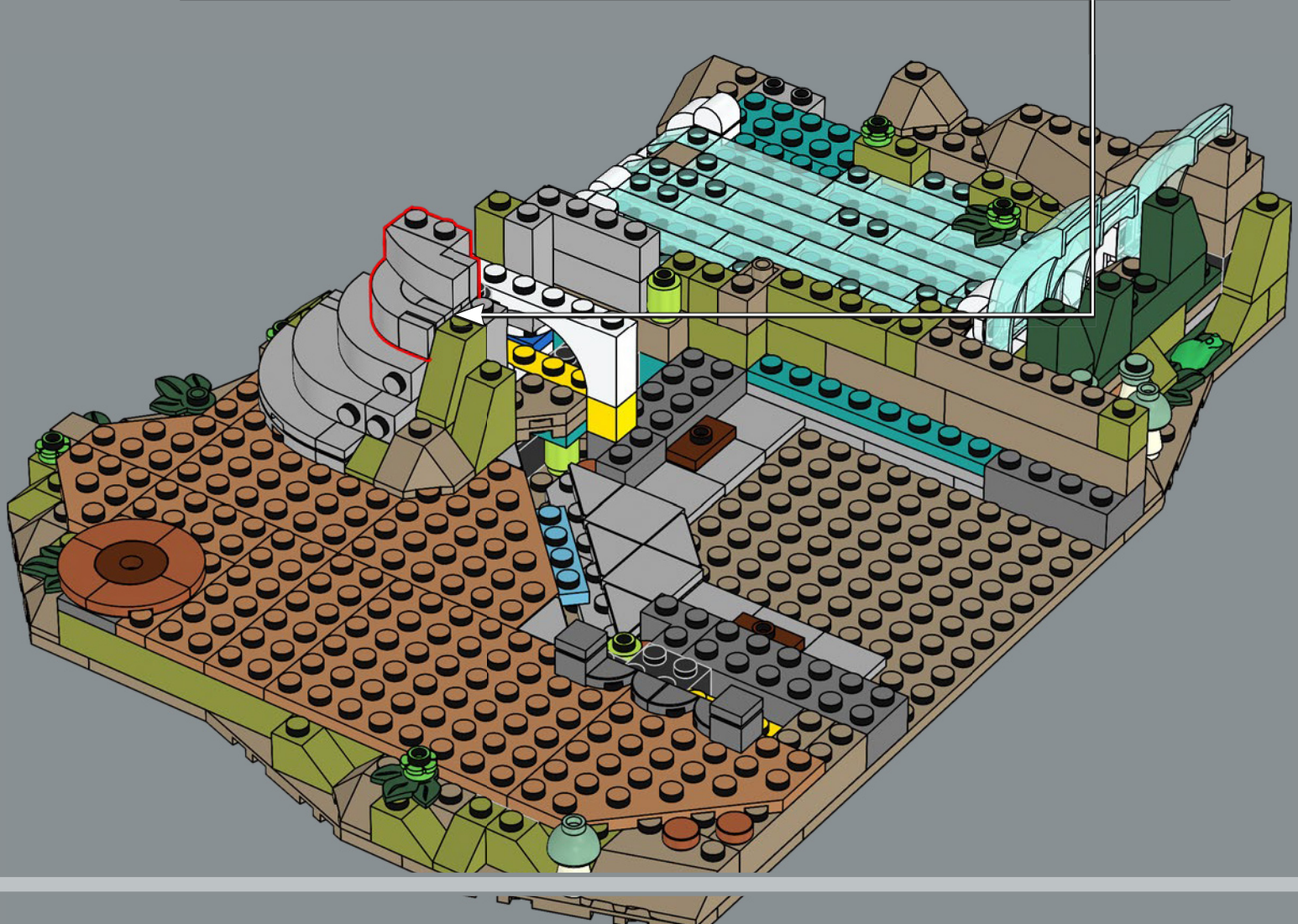
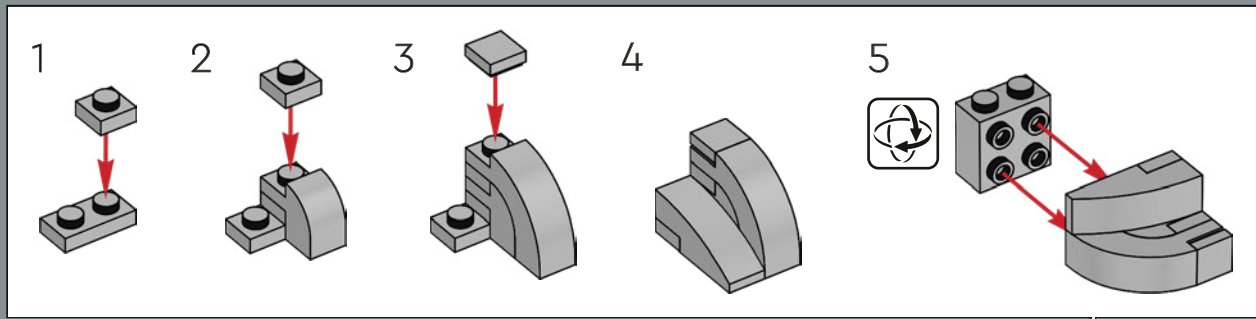

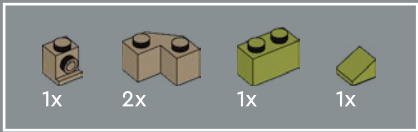

63

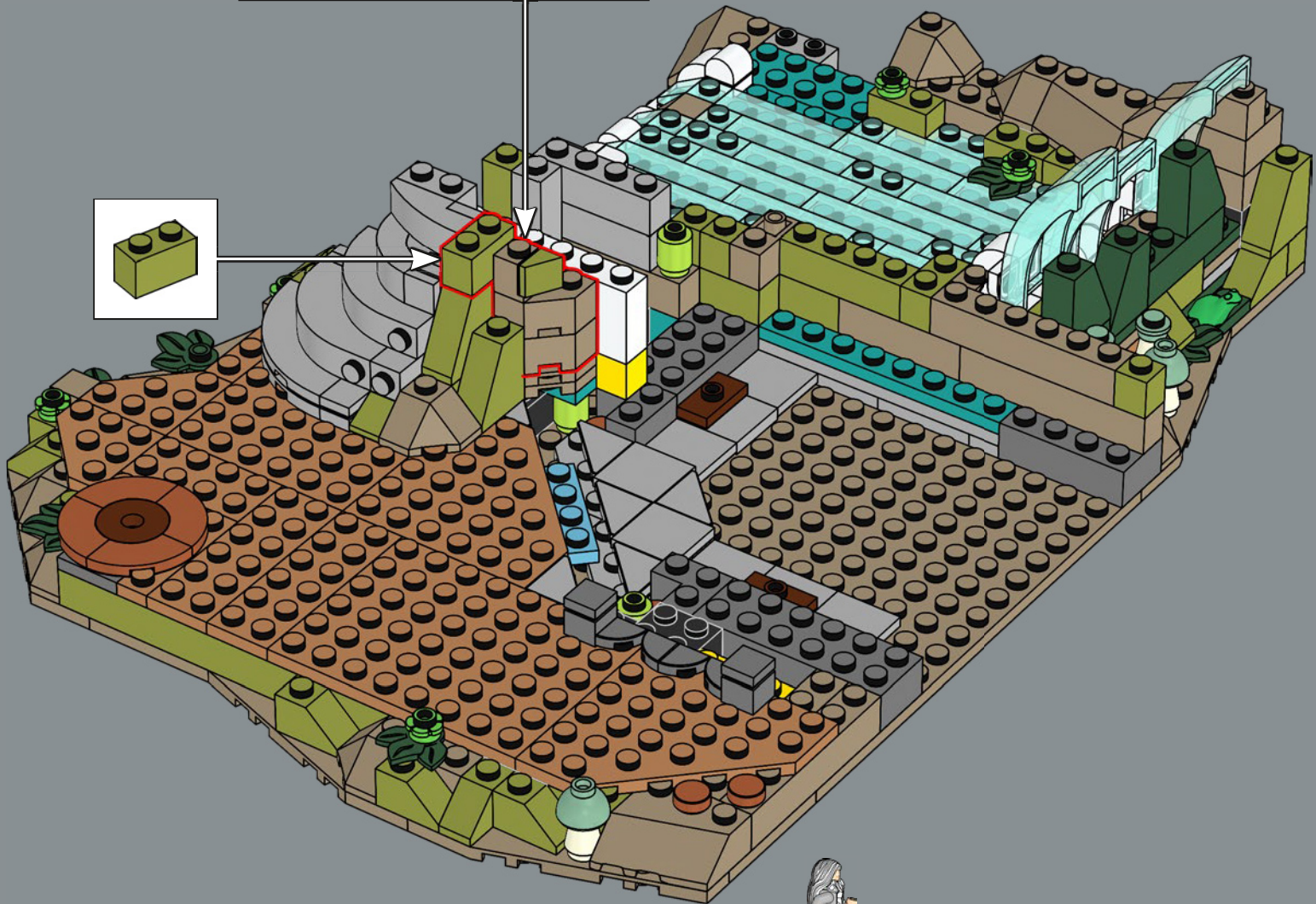
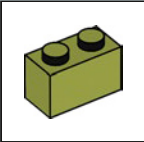
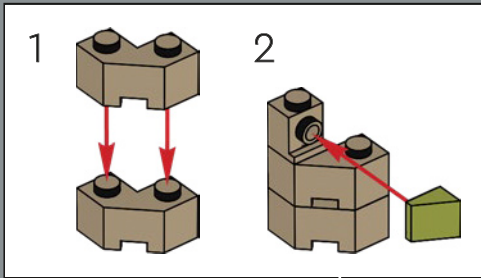

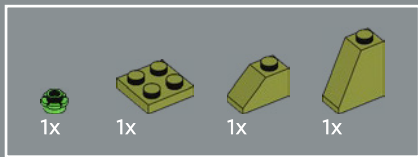

64

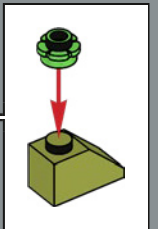
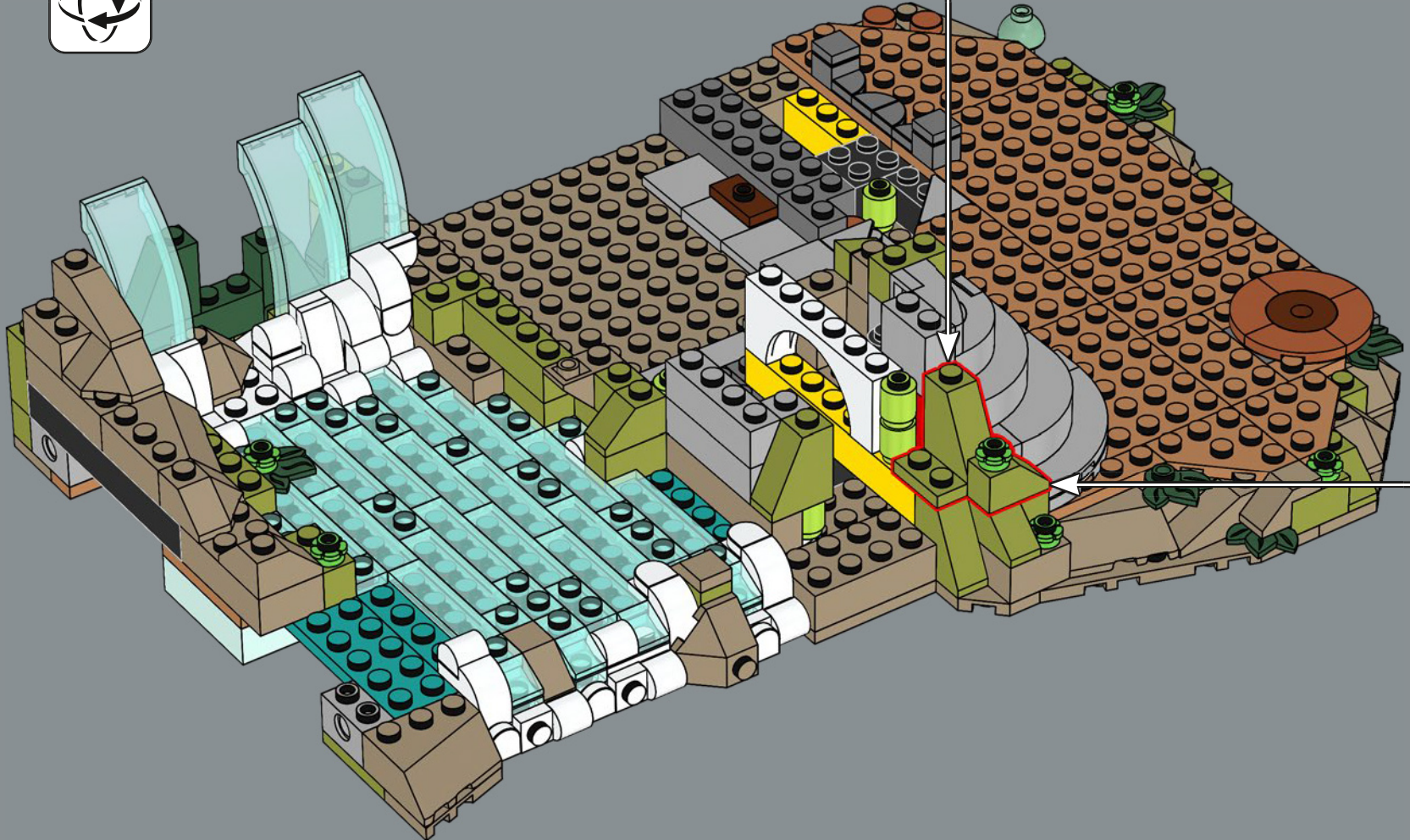
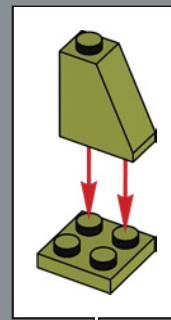

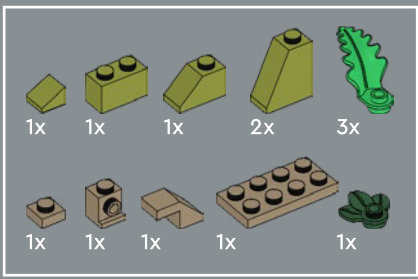

65

1

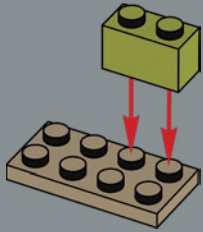

2

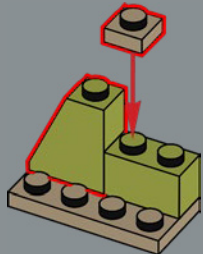

3

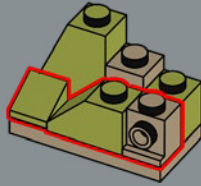

4

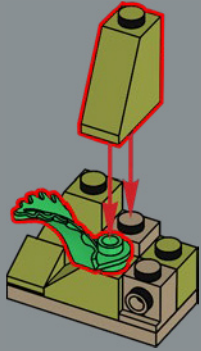

5

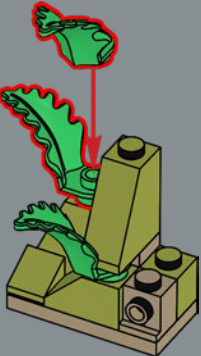

6

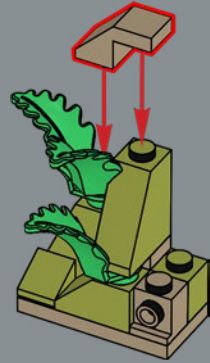

7

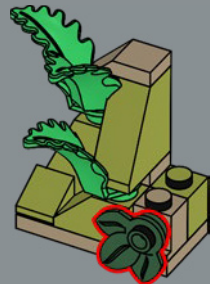

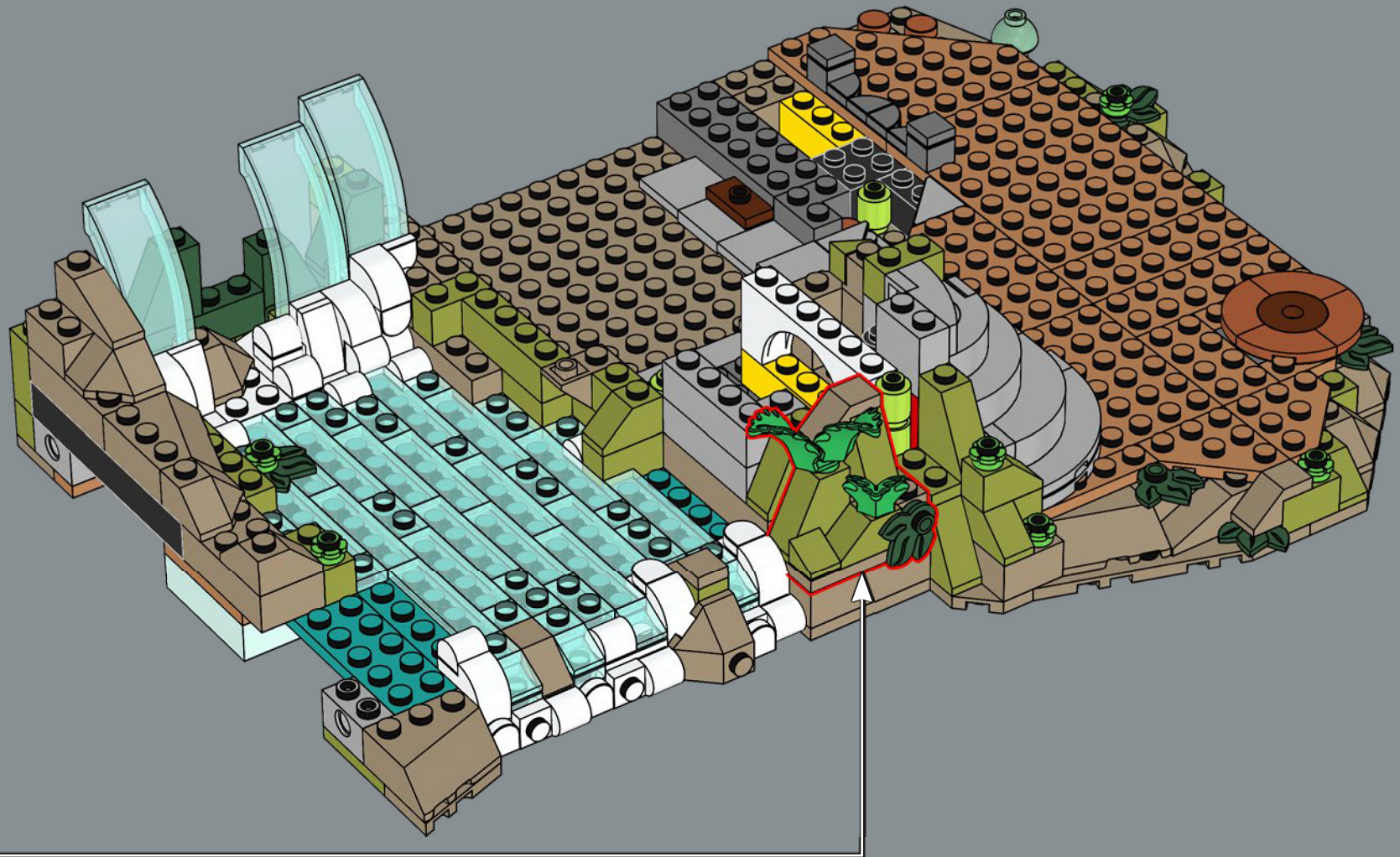

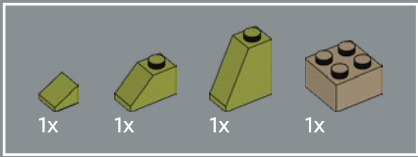

66

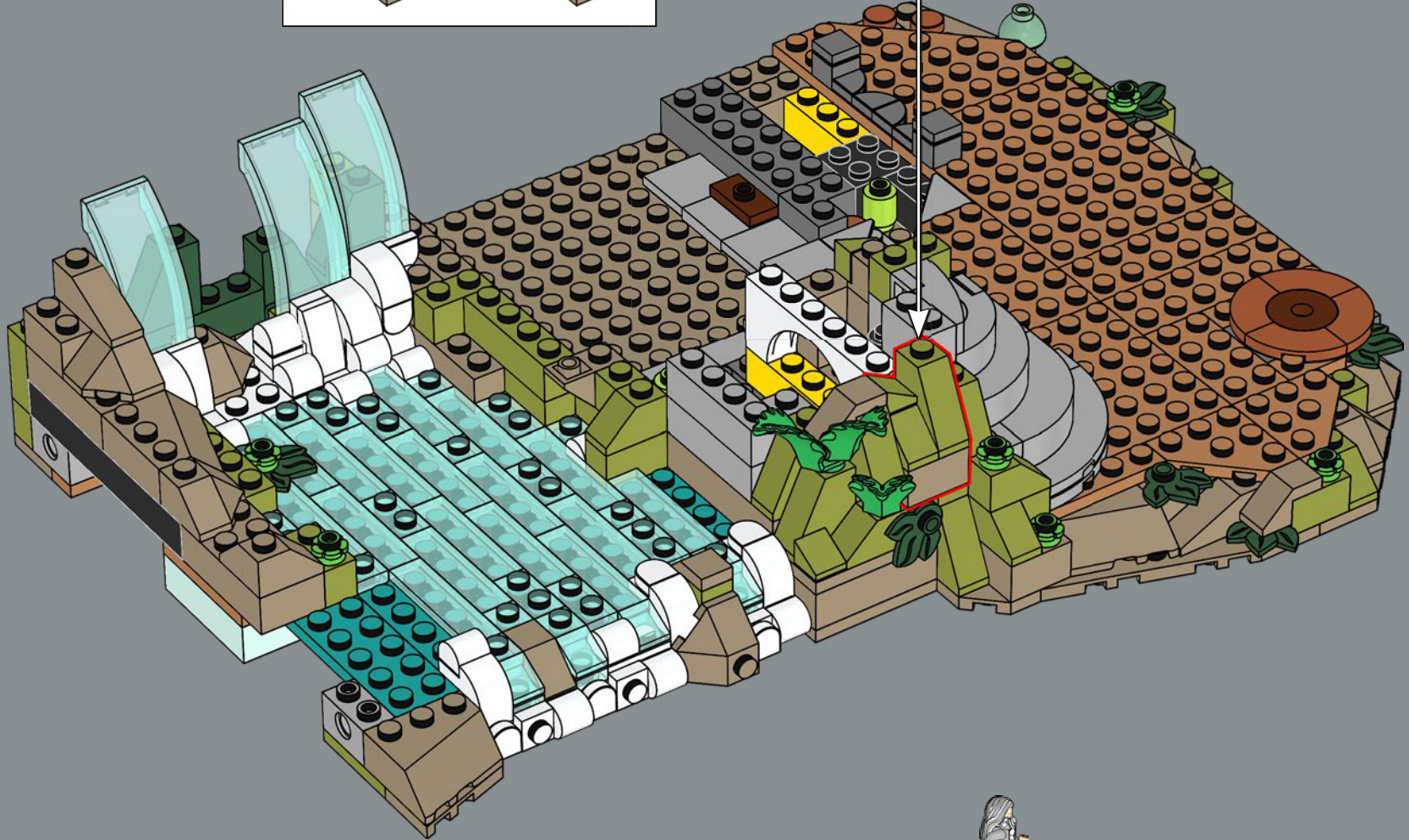
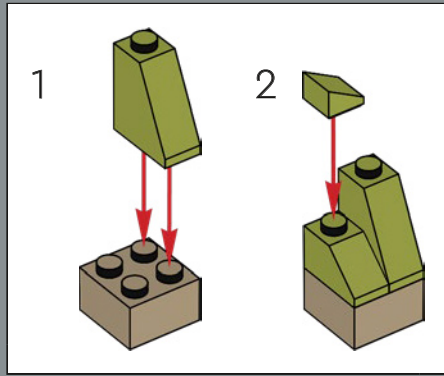

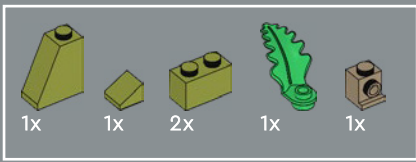

67

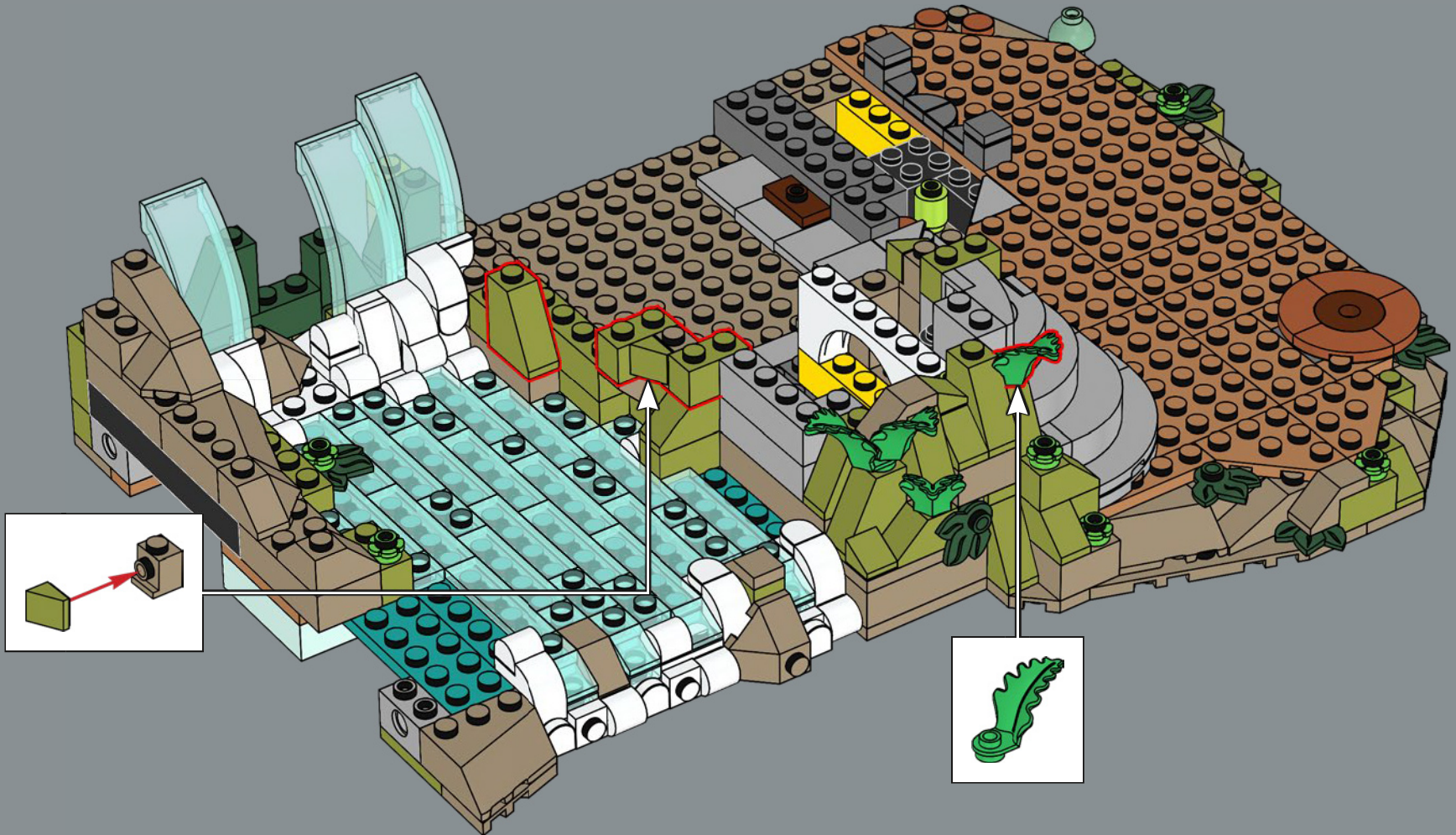

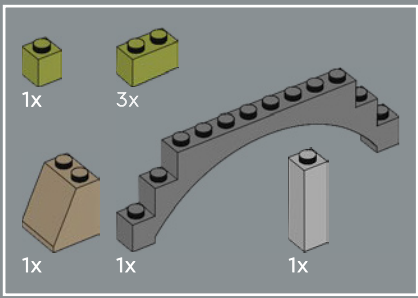

68



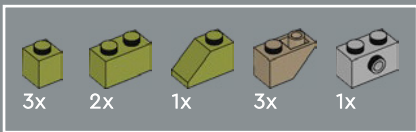

69

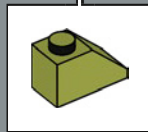
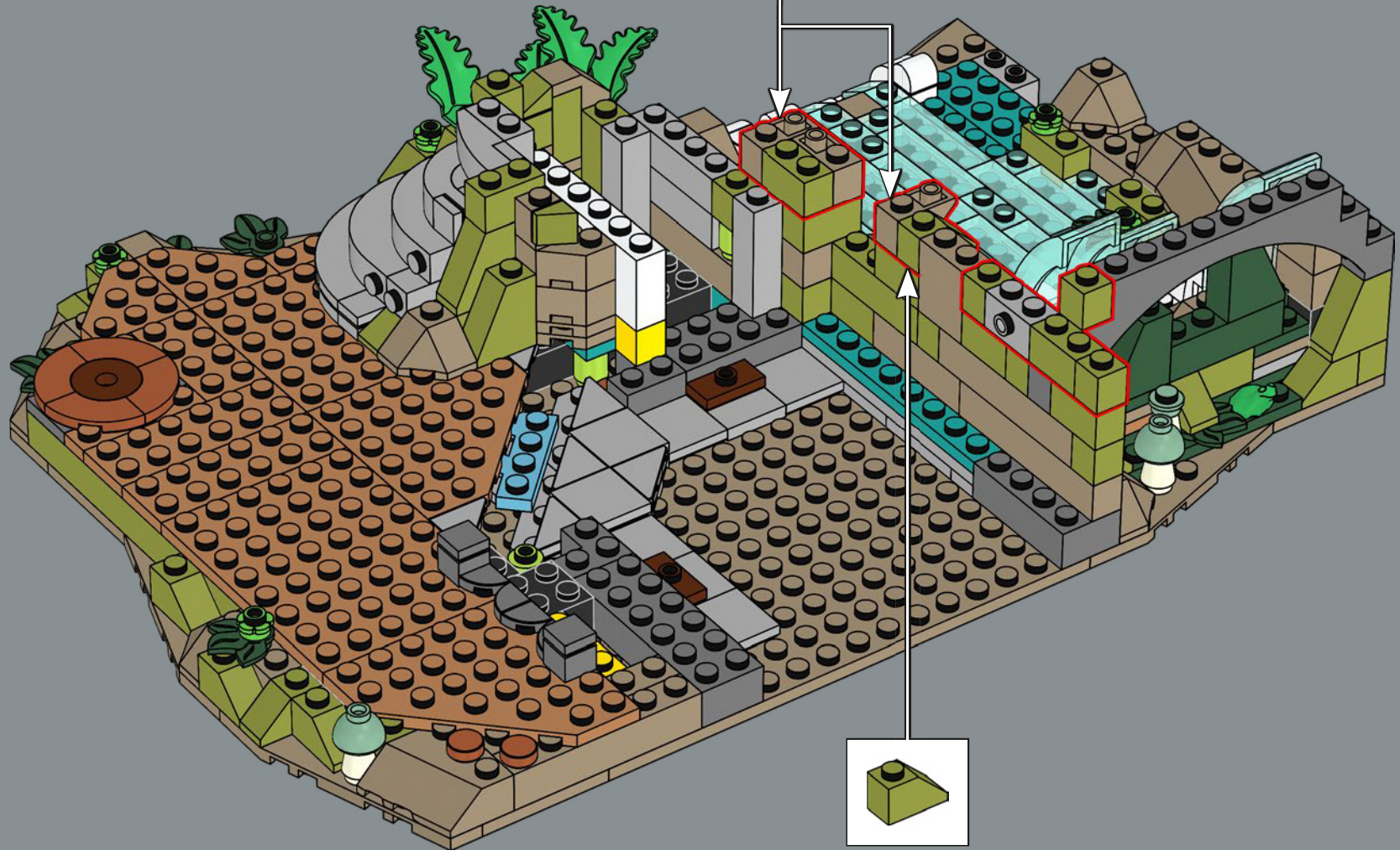
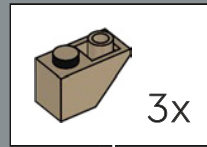

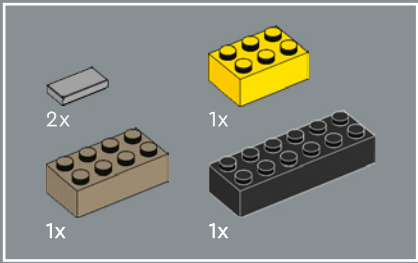

70

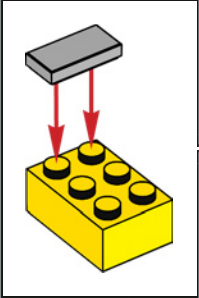
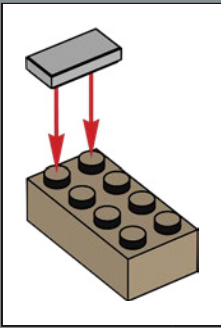

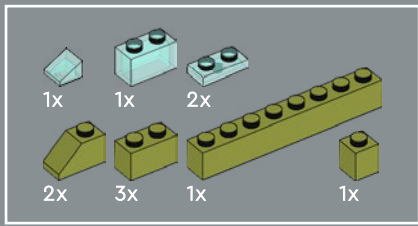

71



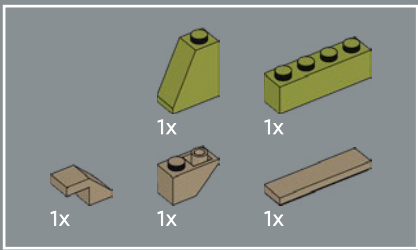

72



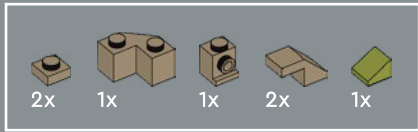

73

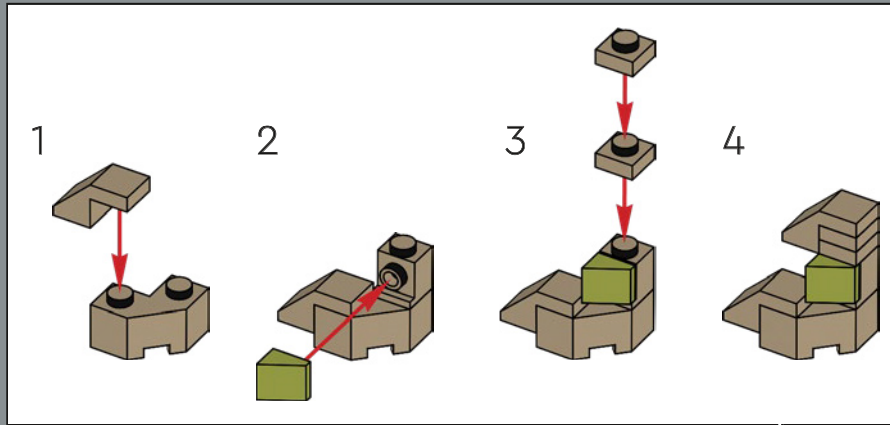

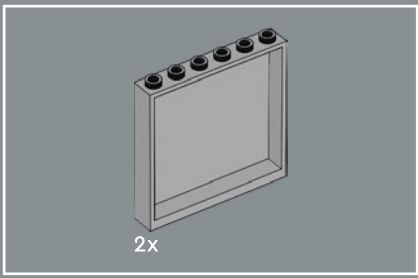

74

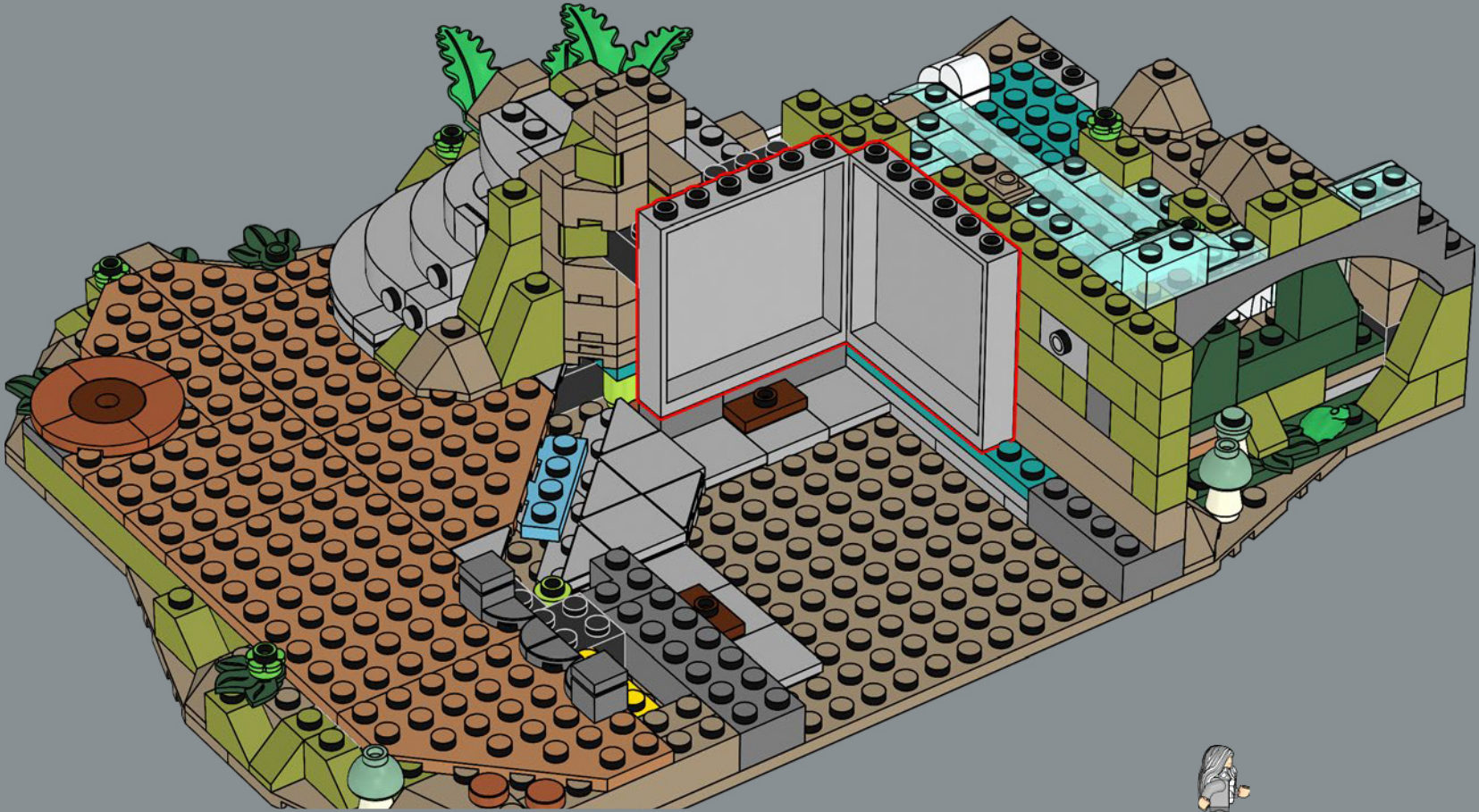

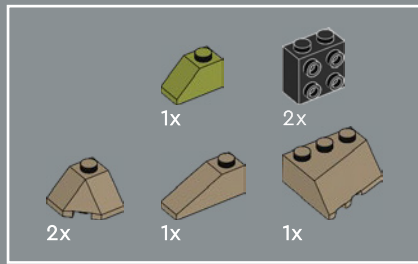

75

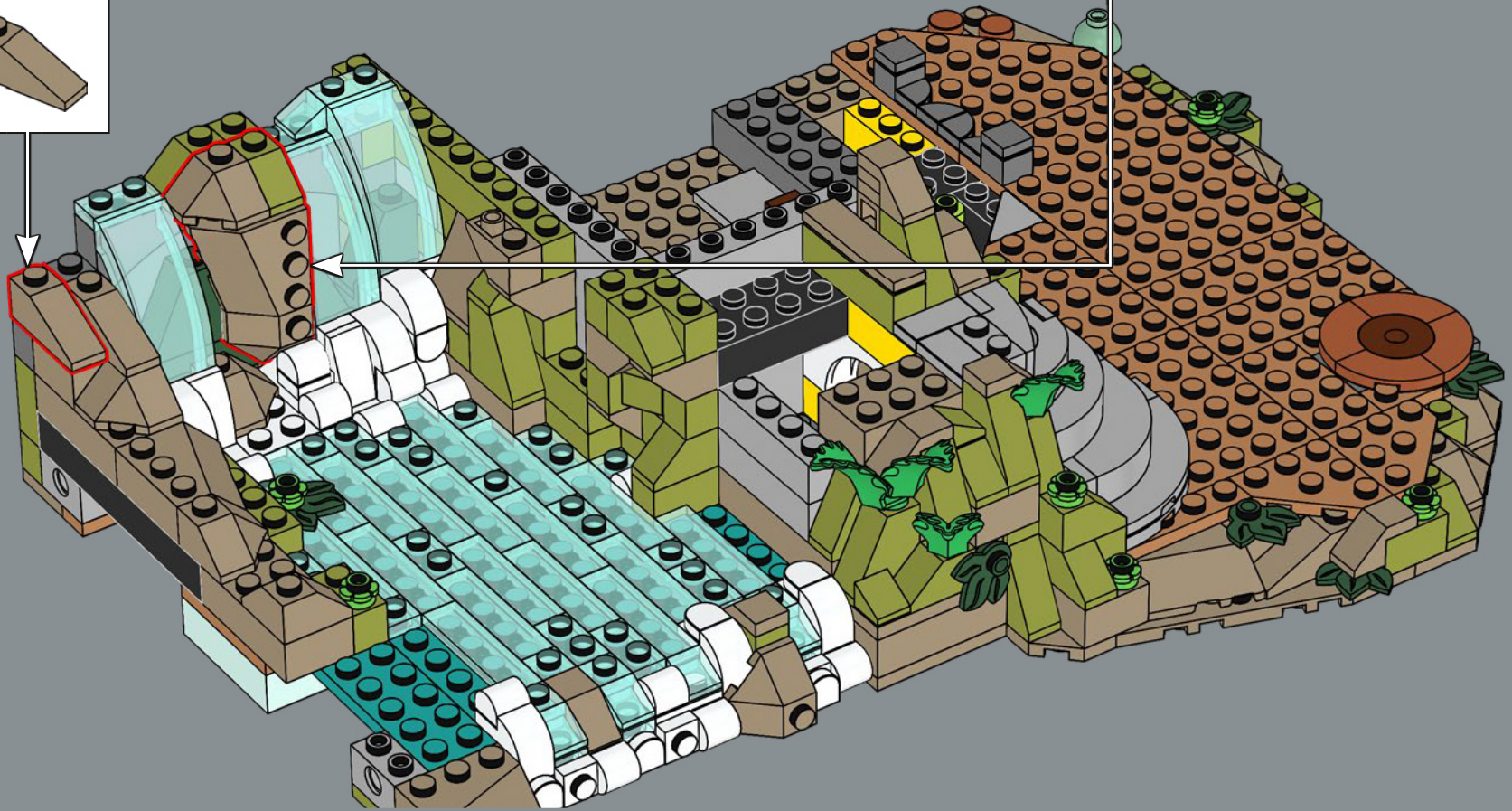
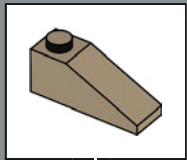
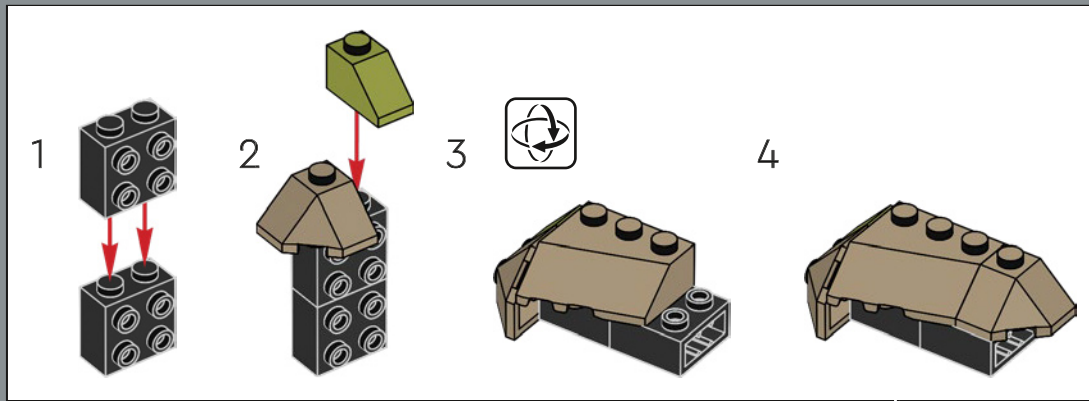

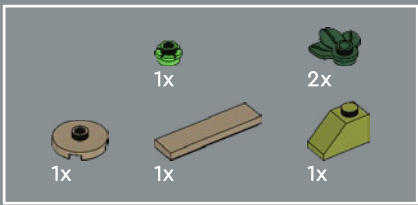

76

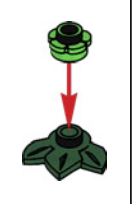
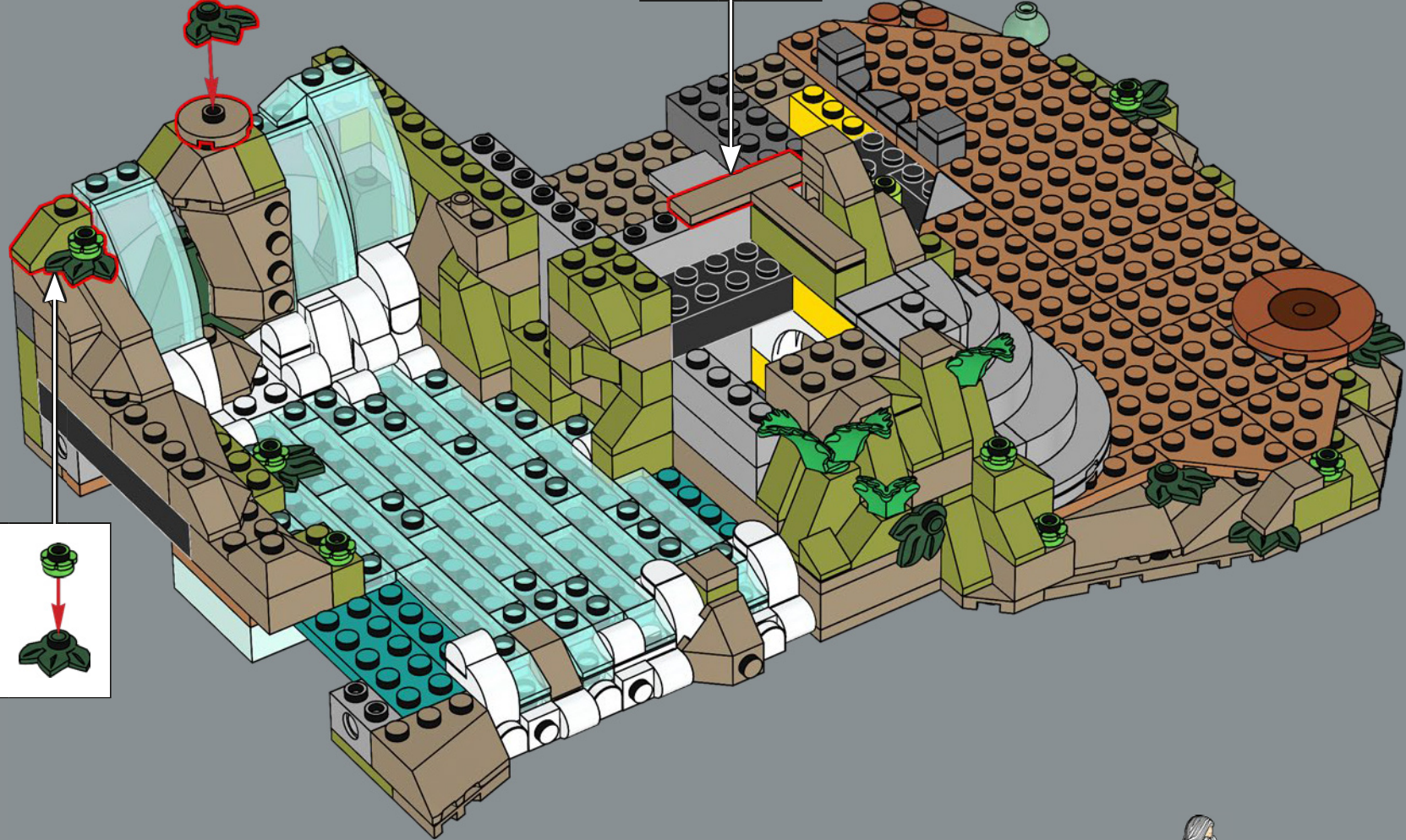
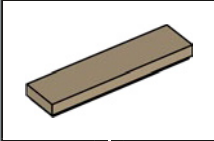

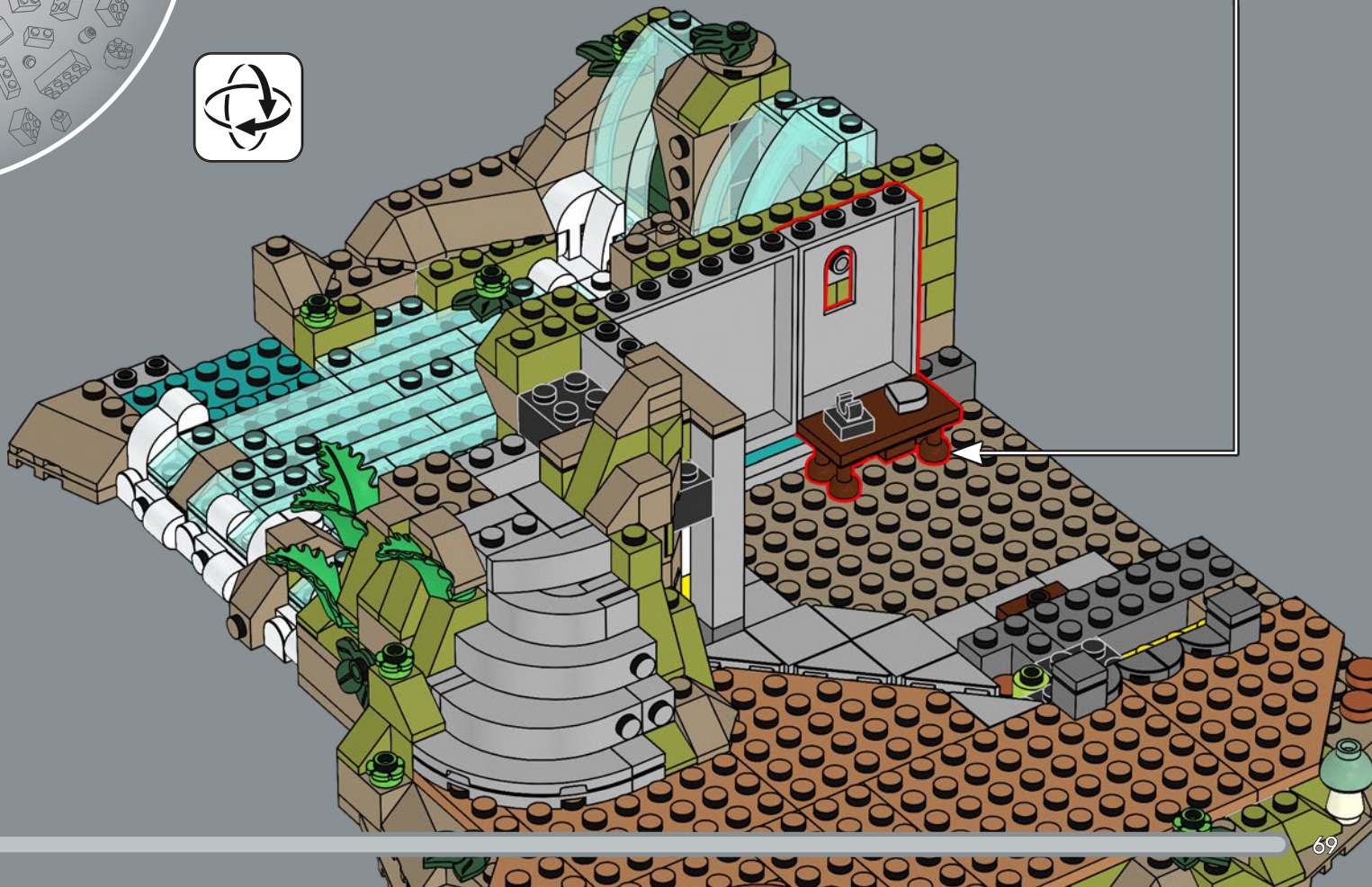
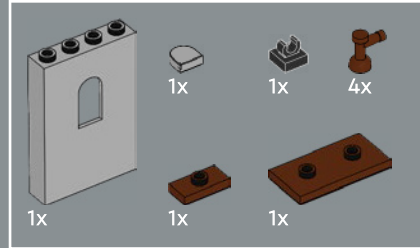
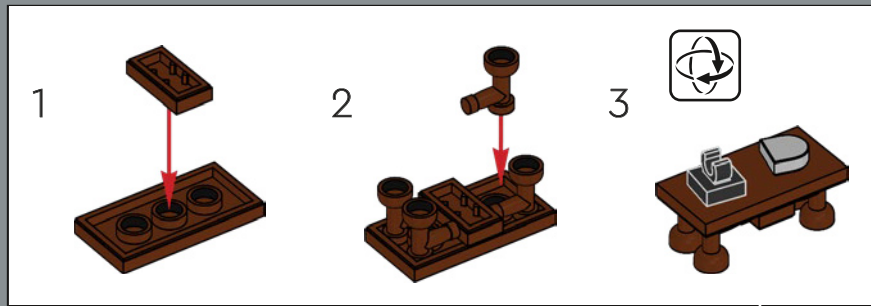

77

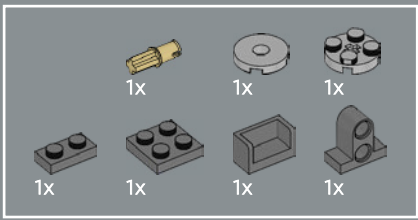

78

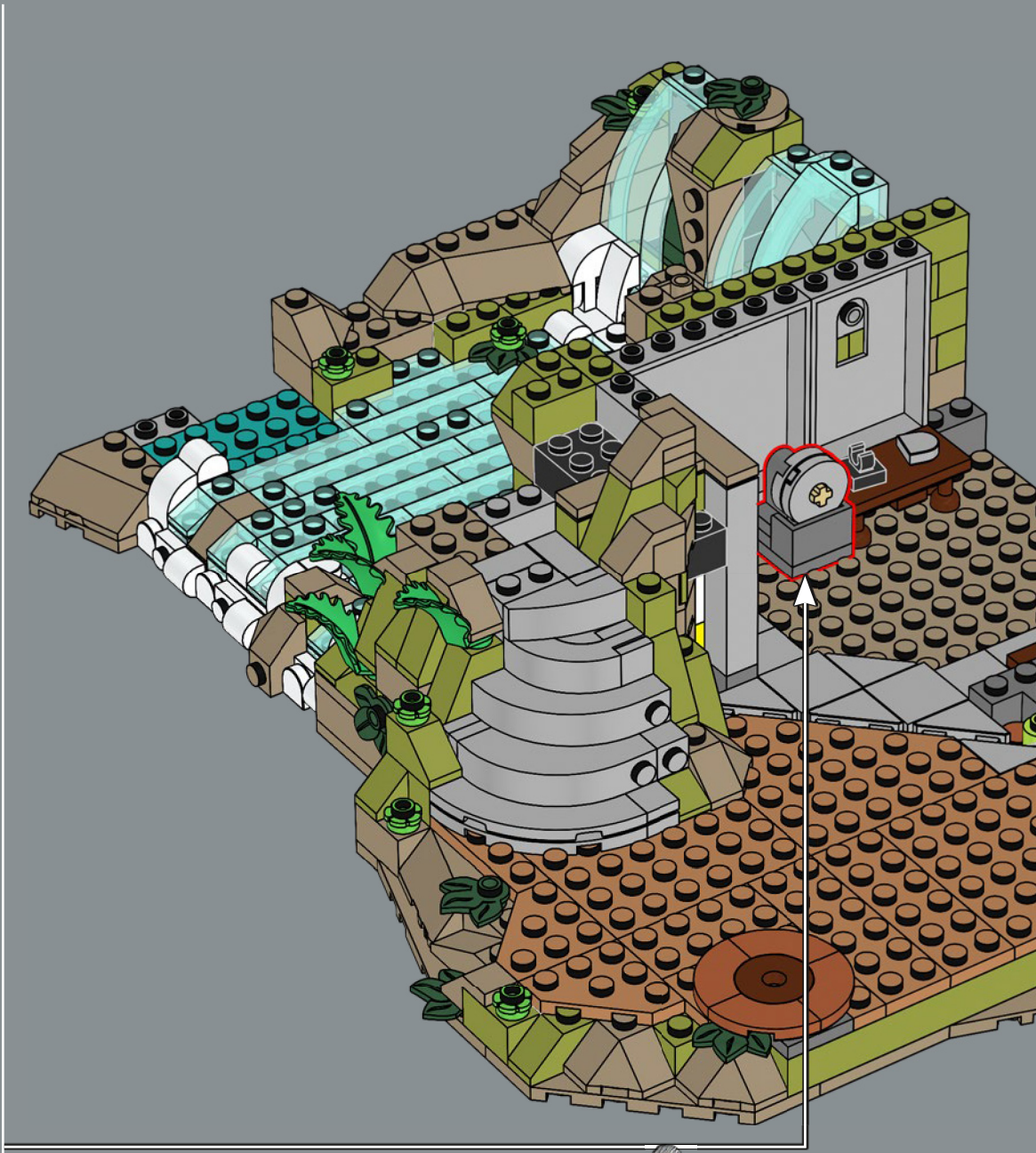
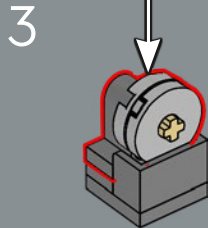
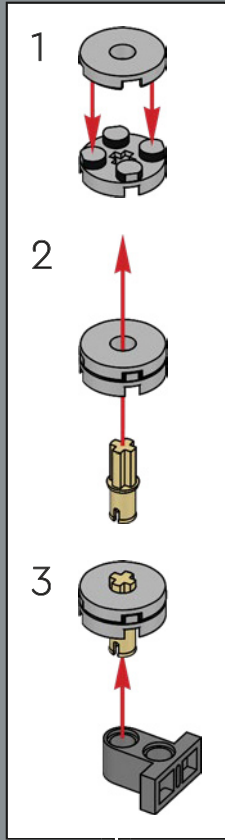
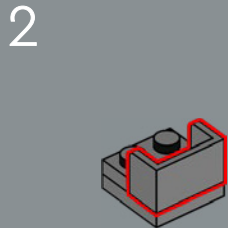
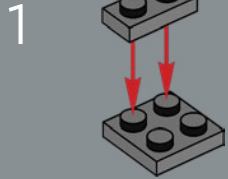



即使被挡住, 这扇位于 1×4×6 墙壁上的
窗户仍然可以为这个房间提供光线。



79

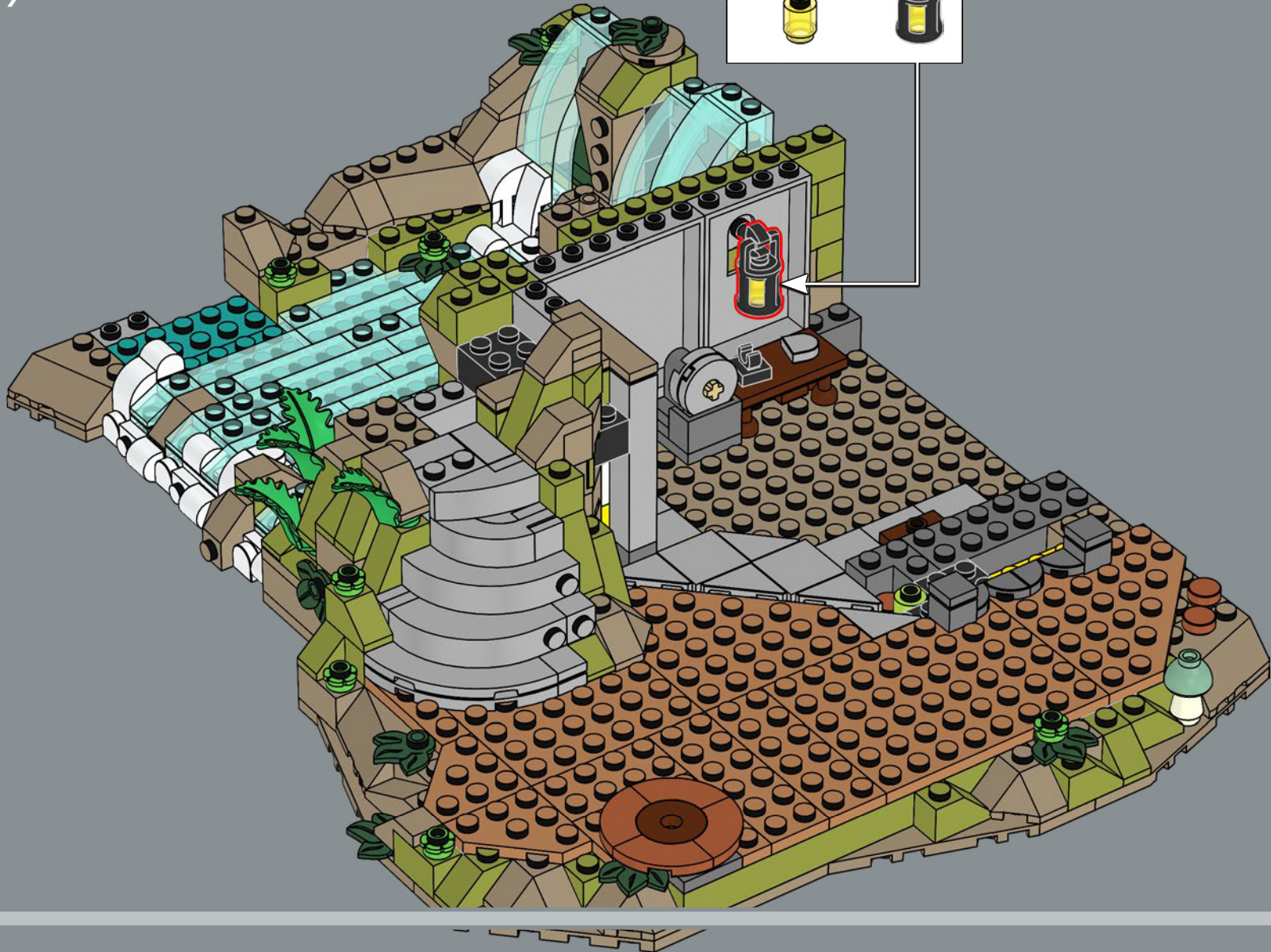
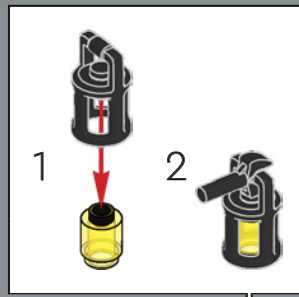

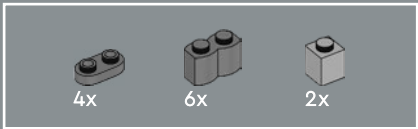



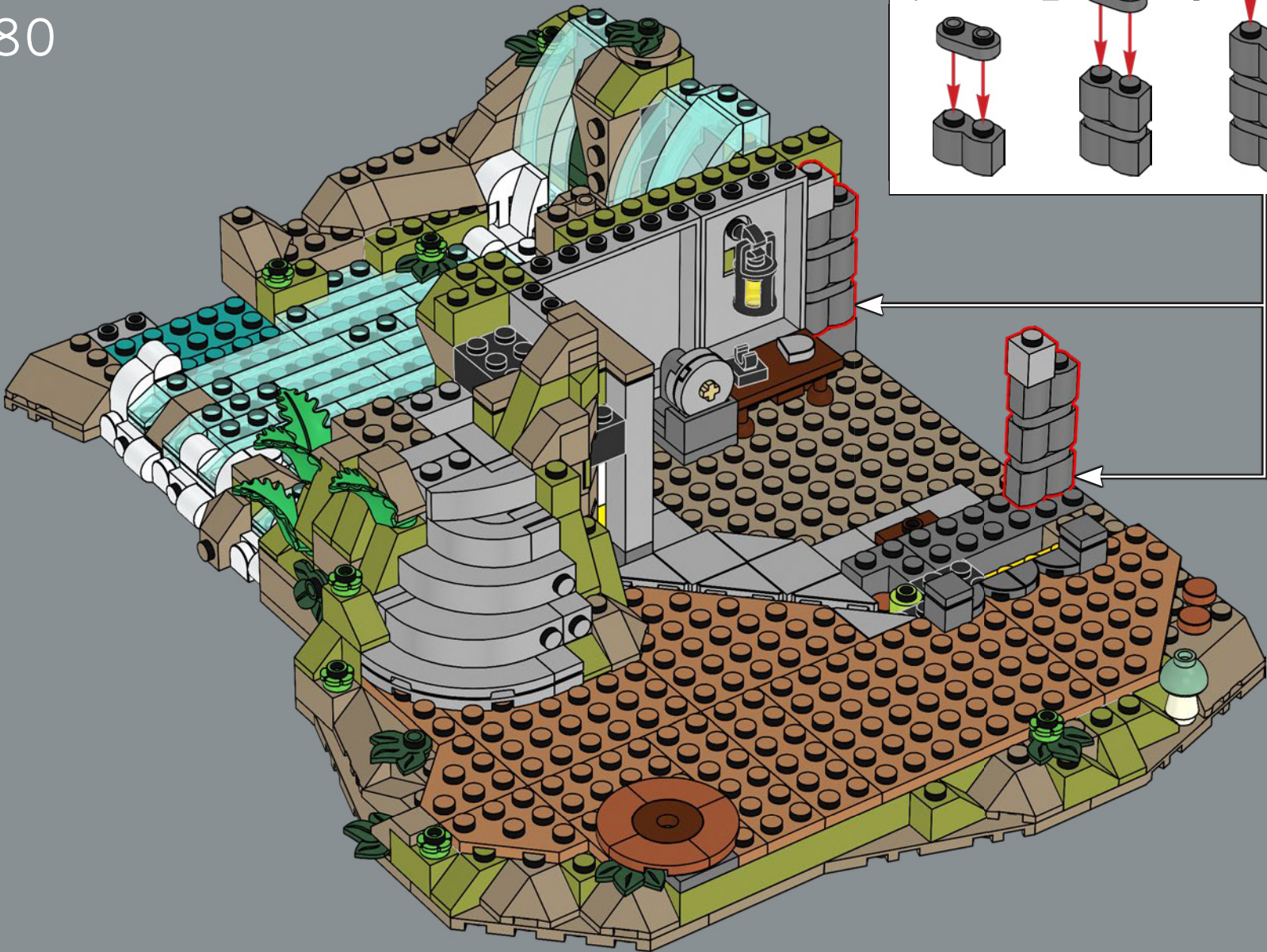
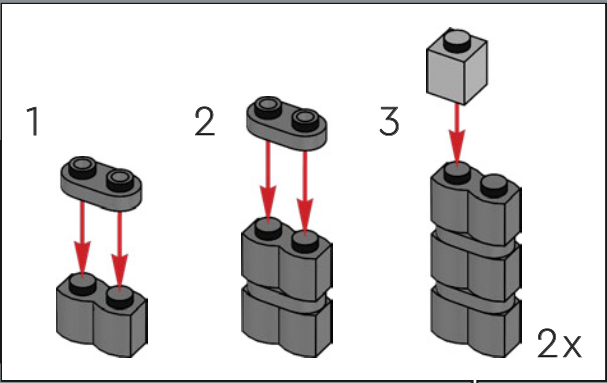

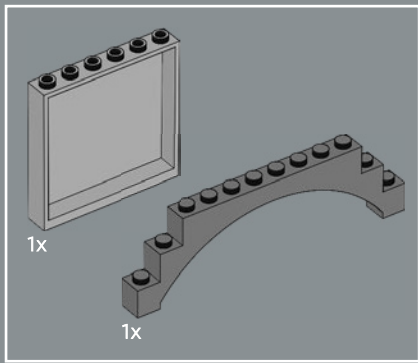
80



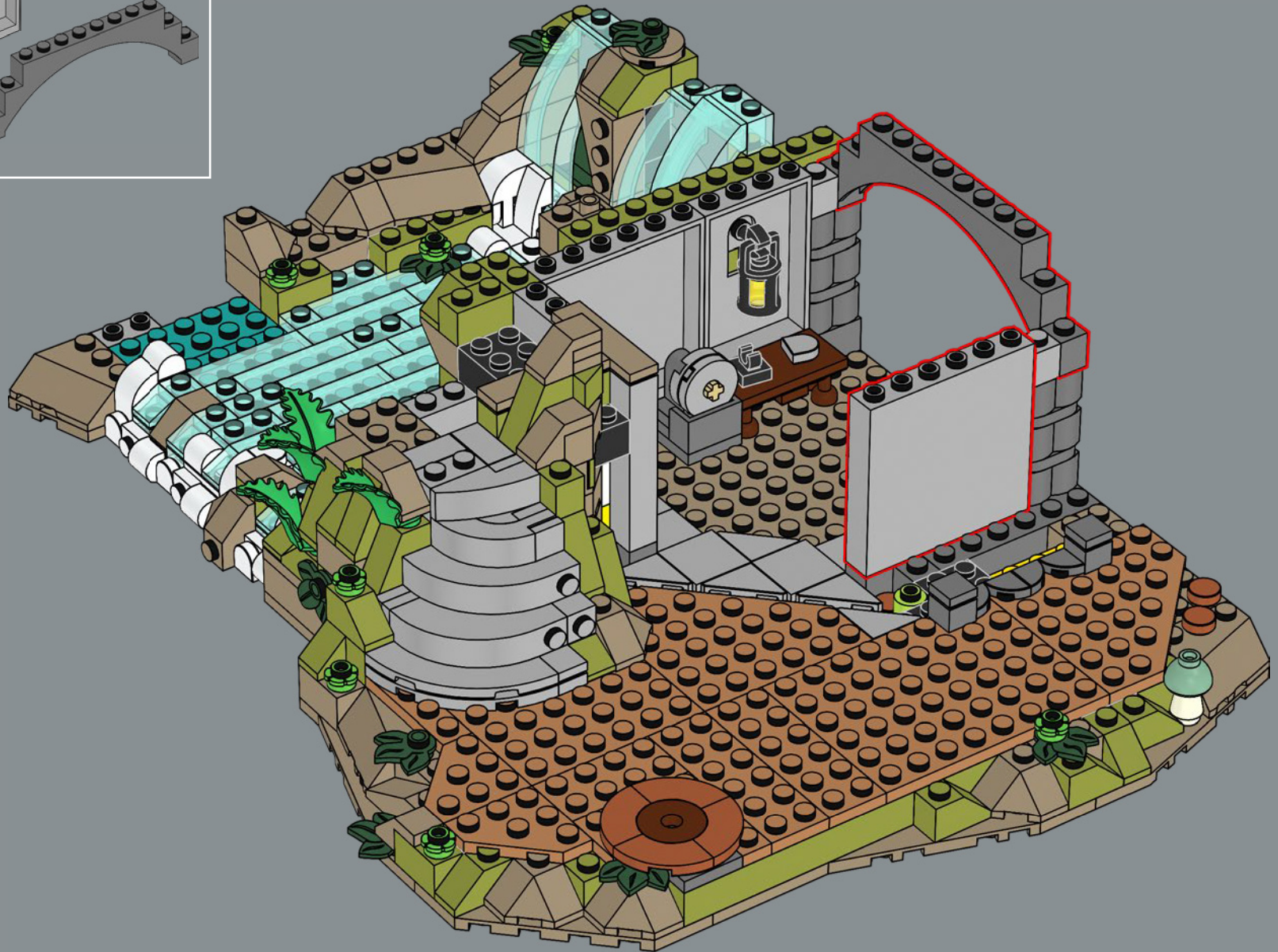

81



		
1x	2x	1x

82

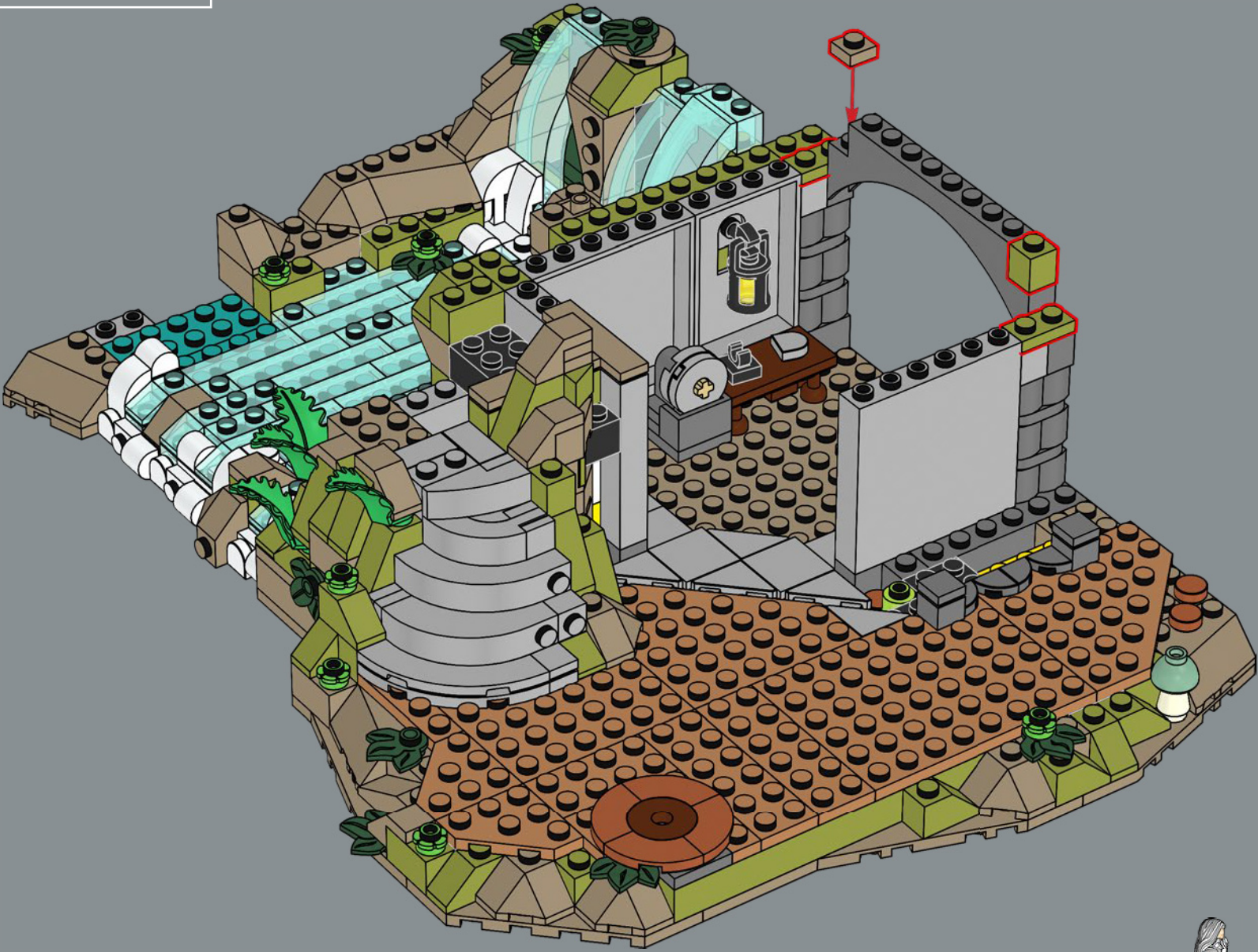

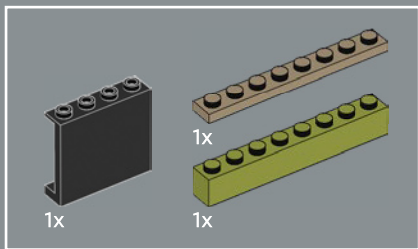

83

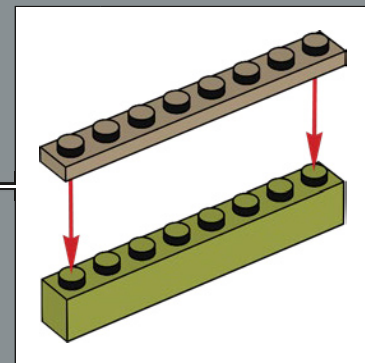
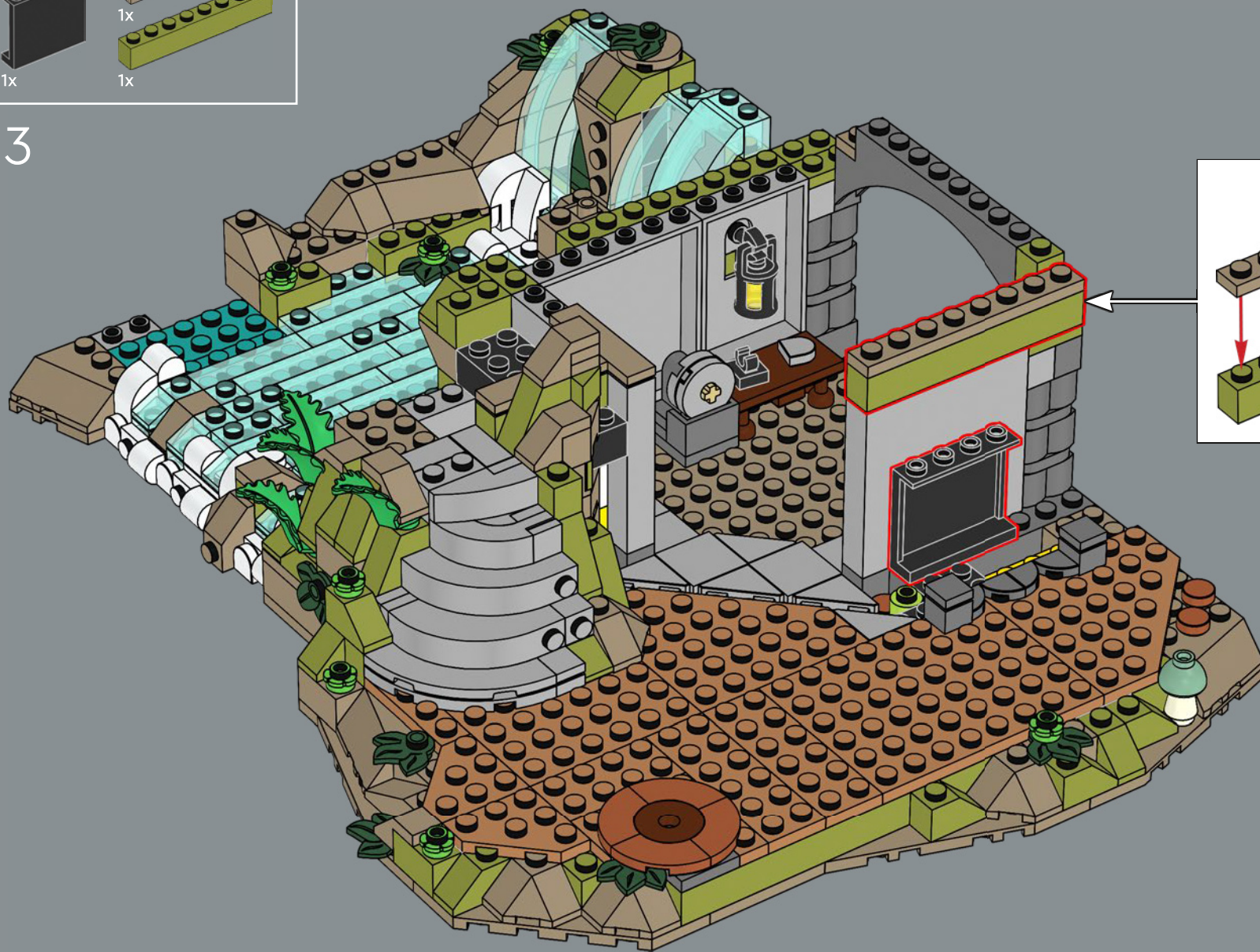

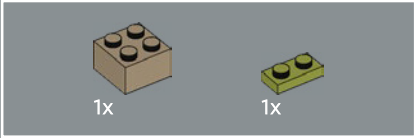
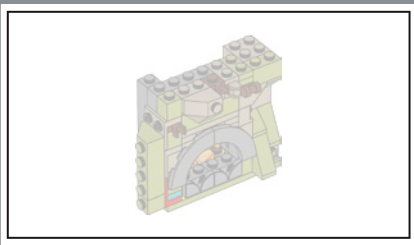

84

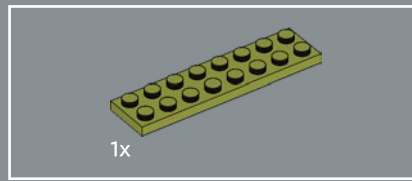
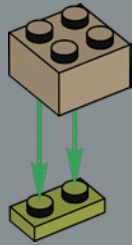

85

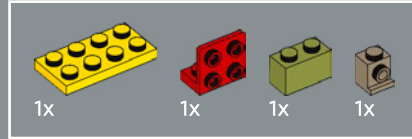
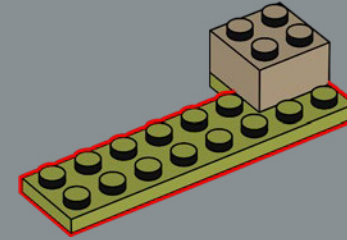

86

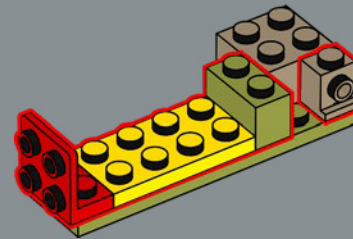



87

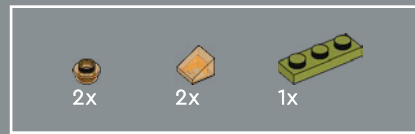
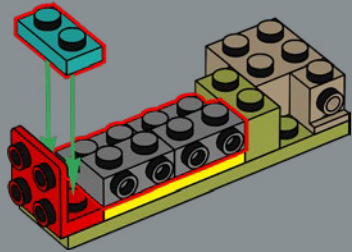

88

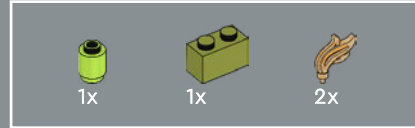
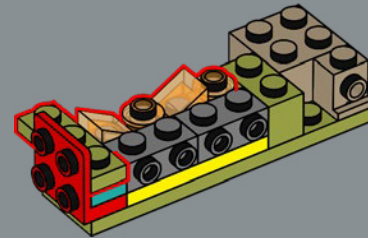

89

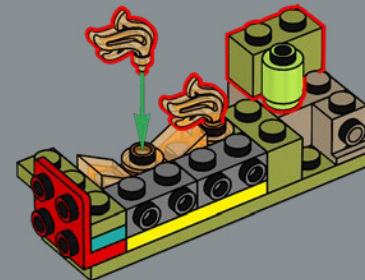

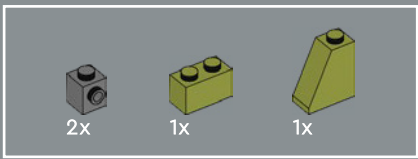

90

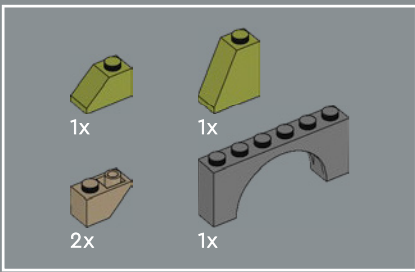
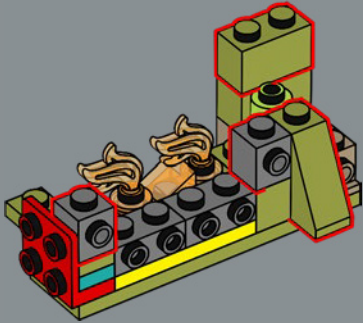

91

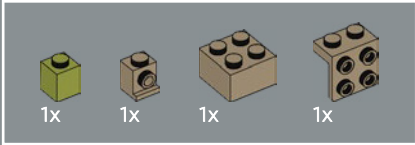
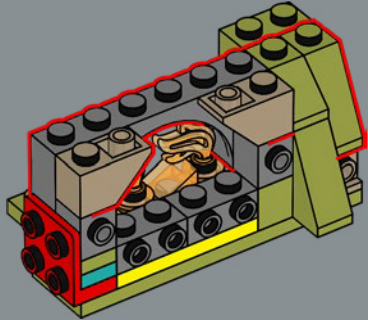

92

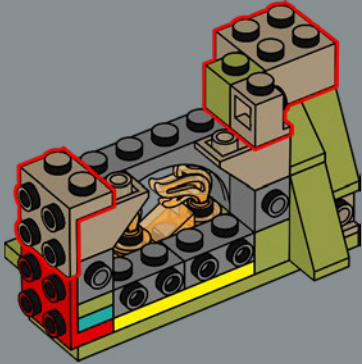

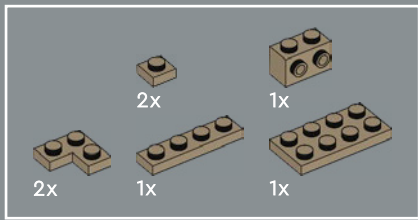

93

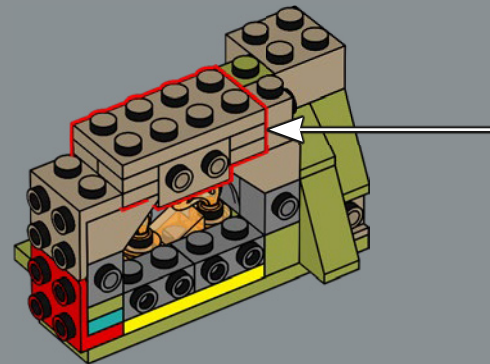
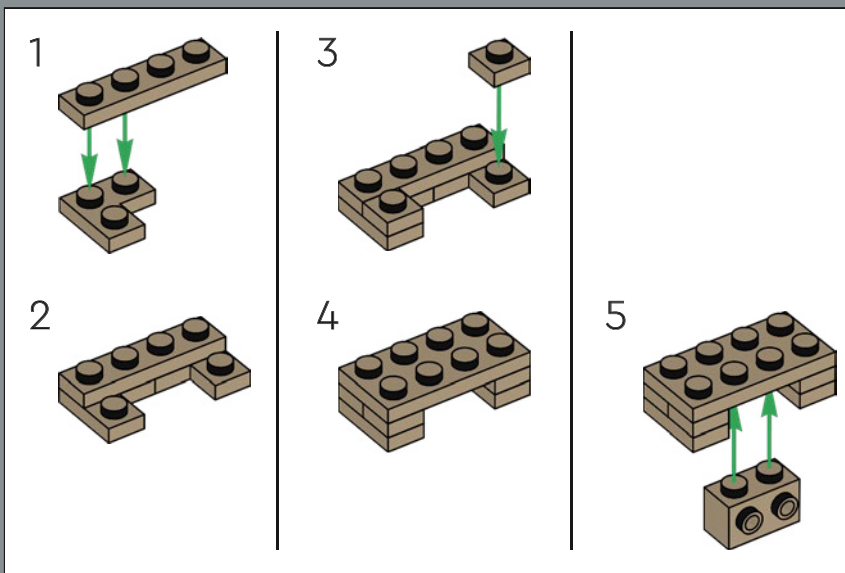

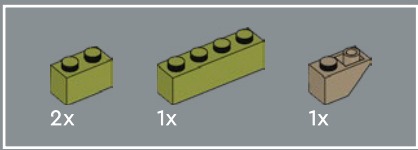

94

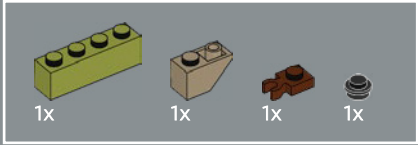
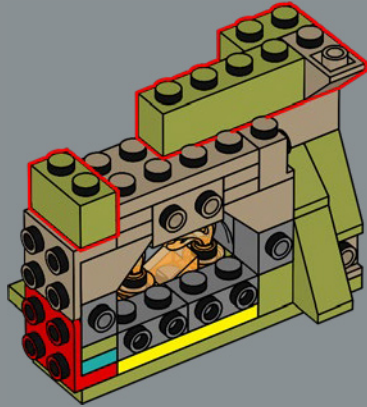

95

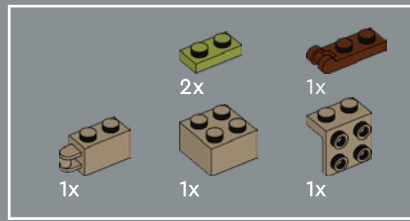
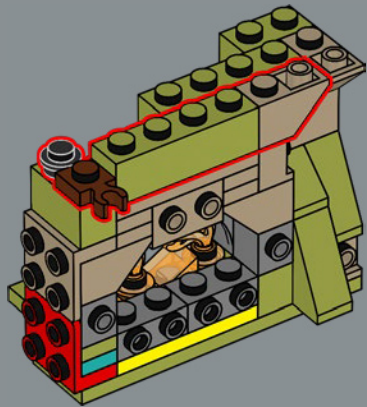

96

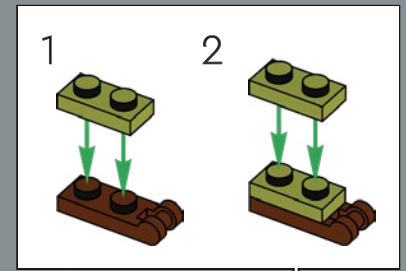
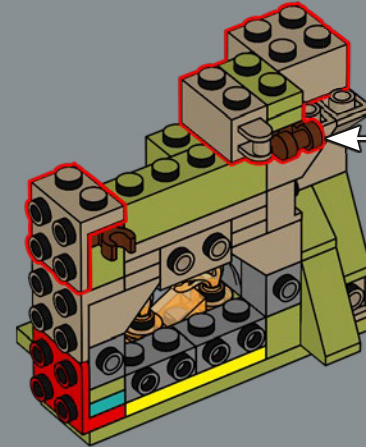

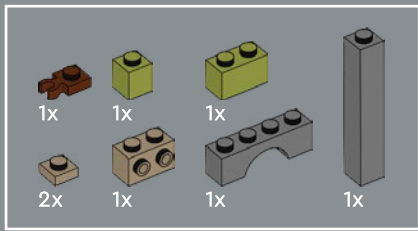

97

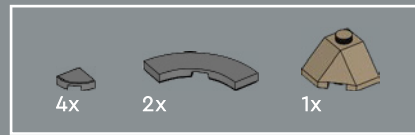
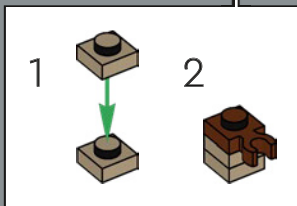
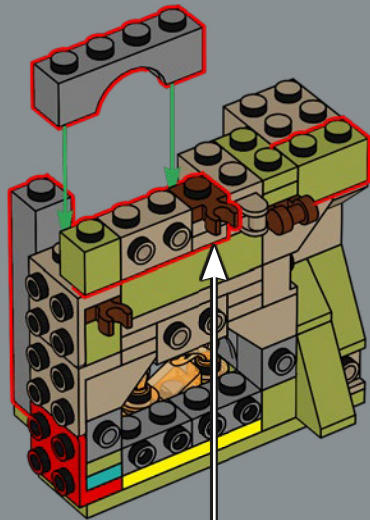

98

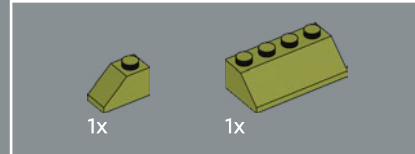
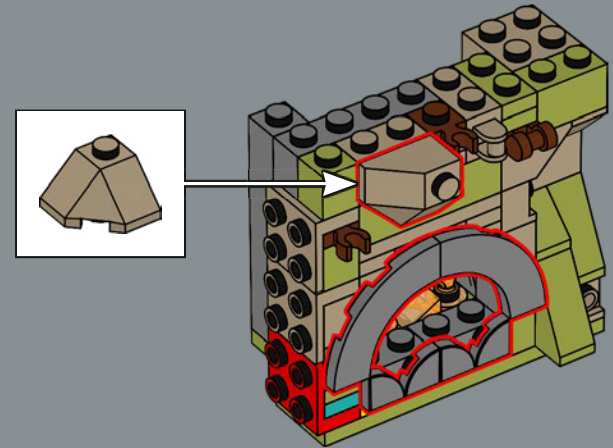

99

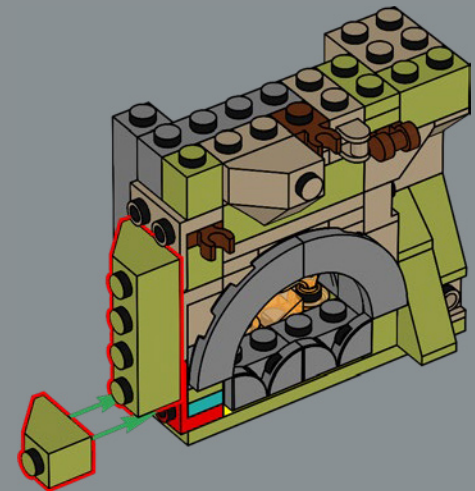

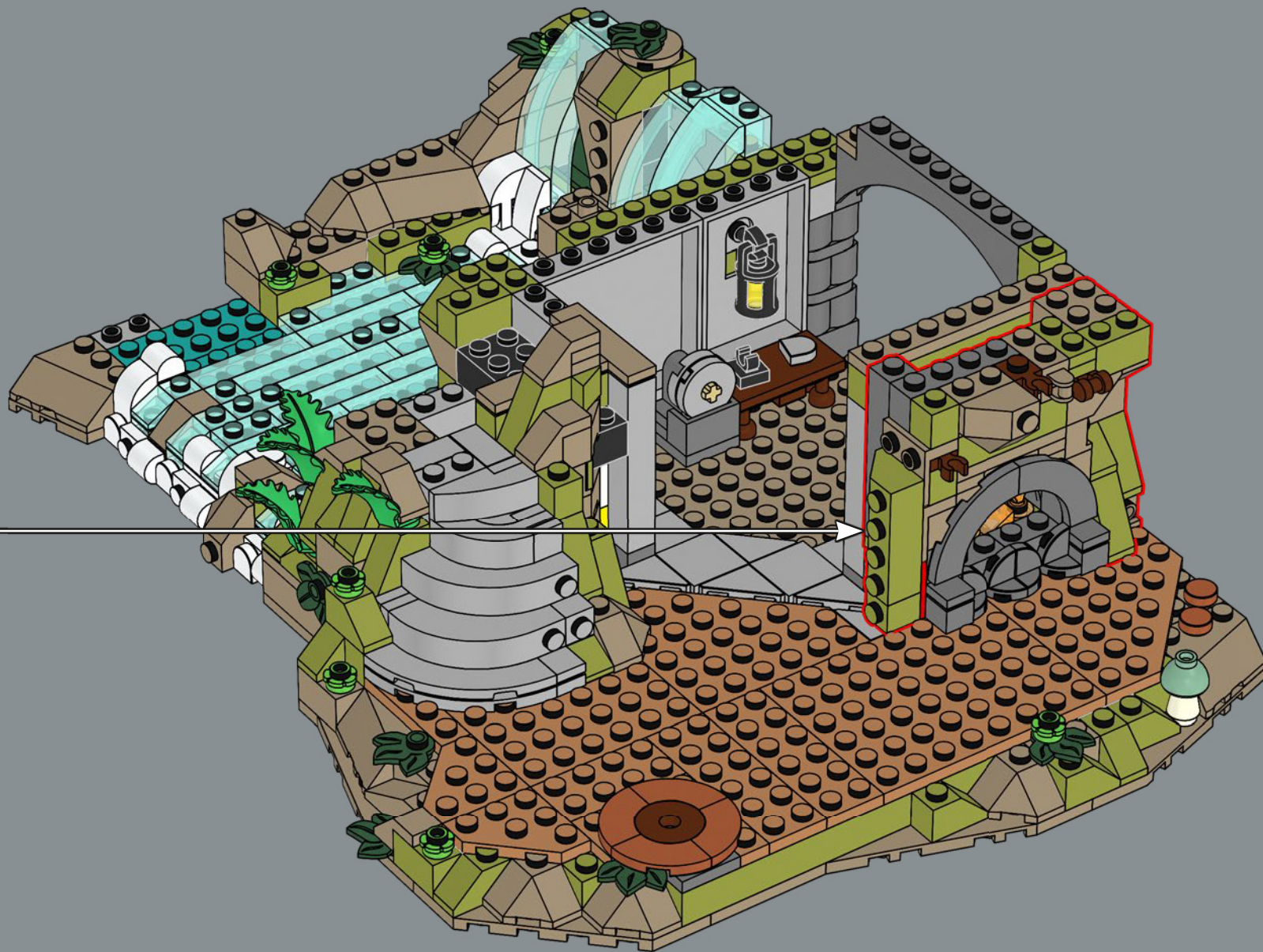

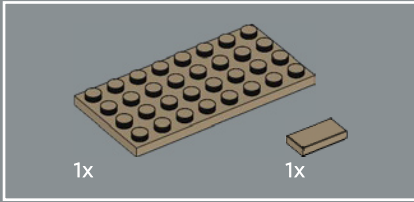
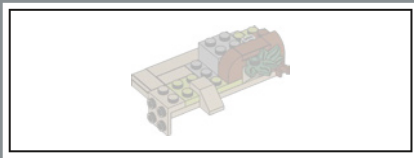

101

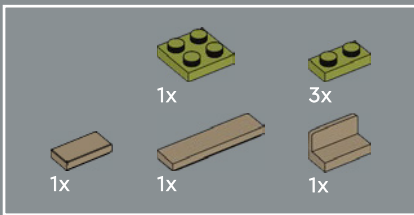
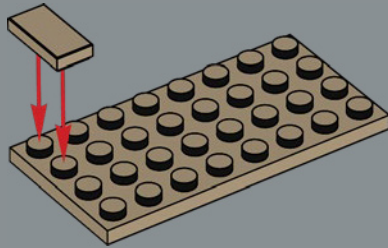

102

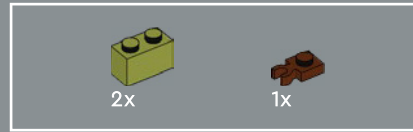
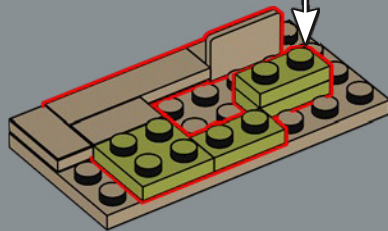
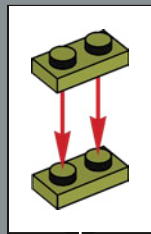

103

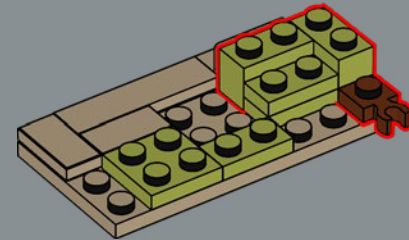

104

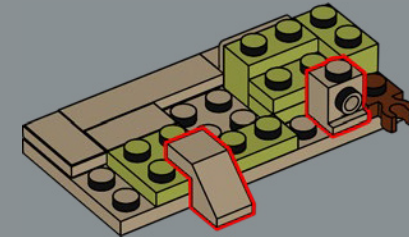

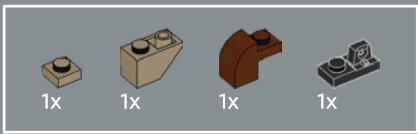

105

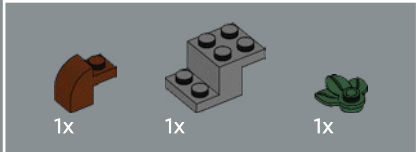
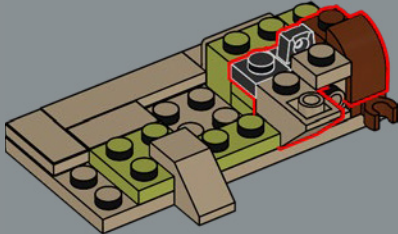

106

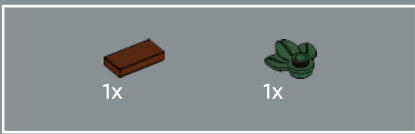
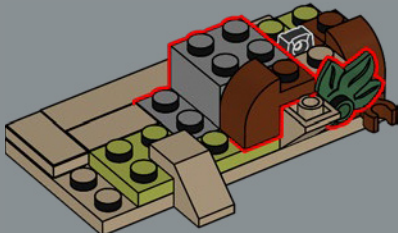

107

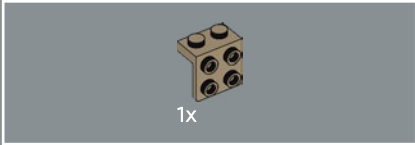
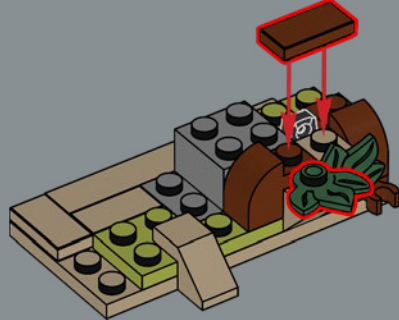

108

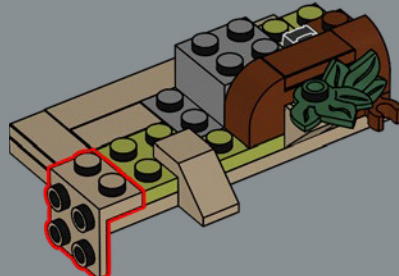

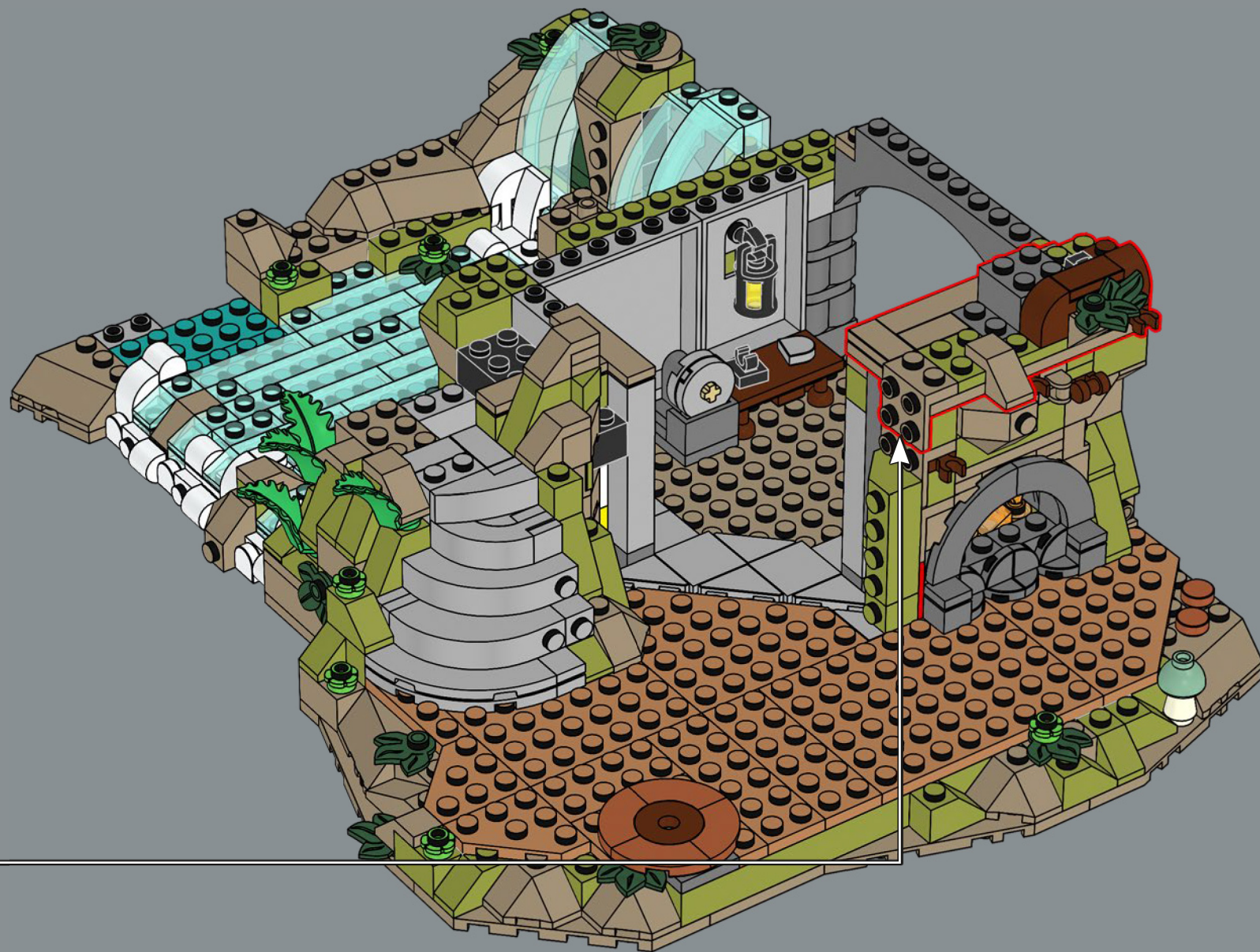

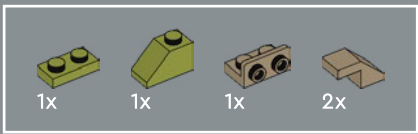

110

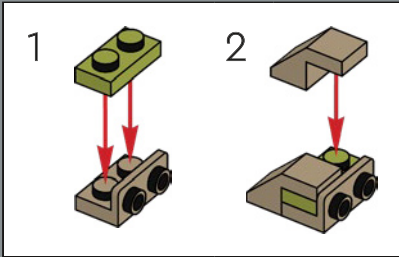
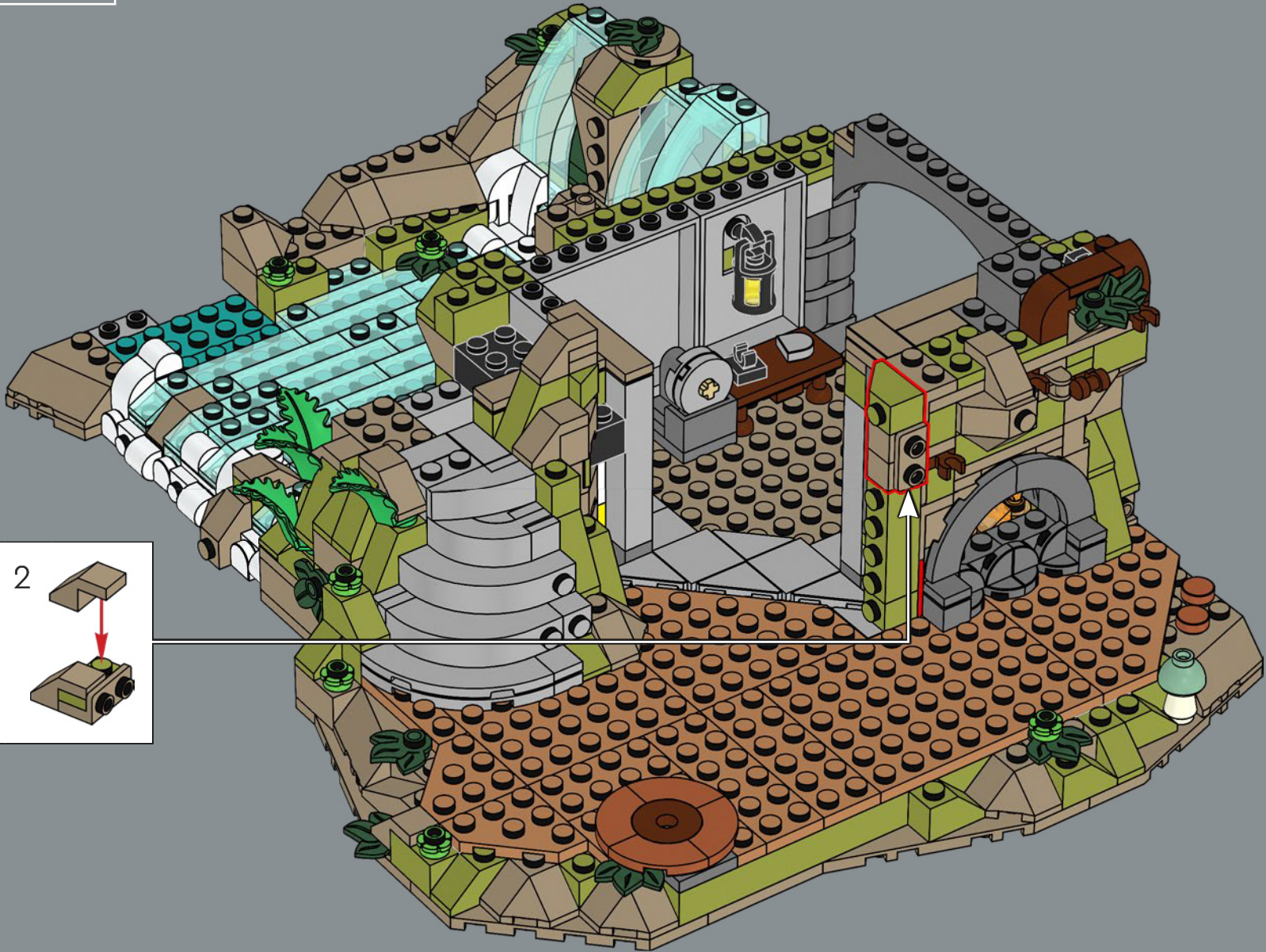

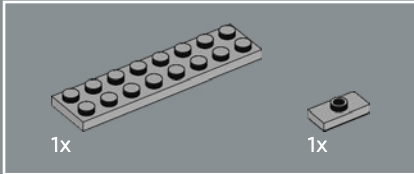
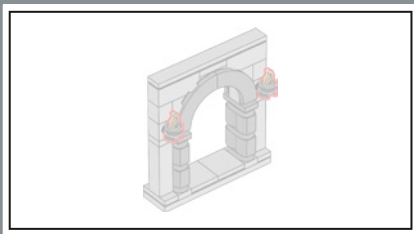

111

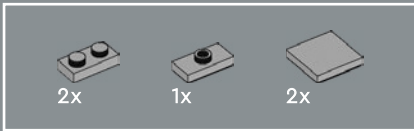
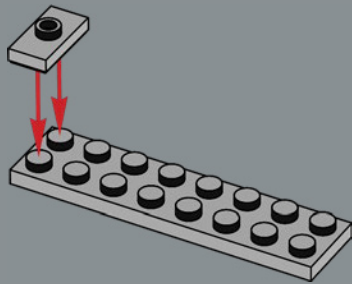

112

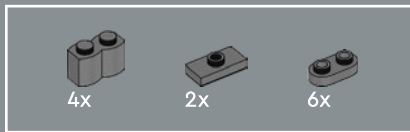
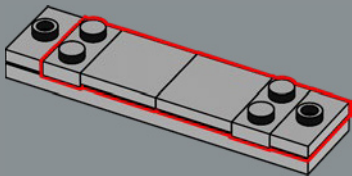

113

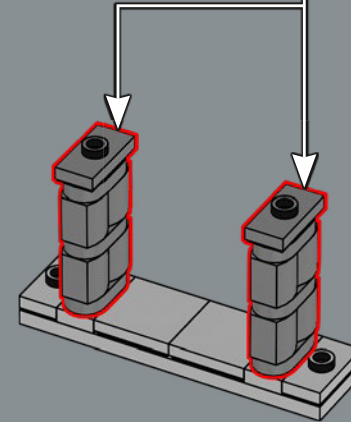
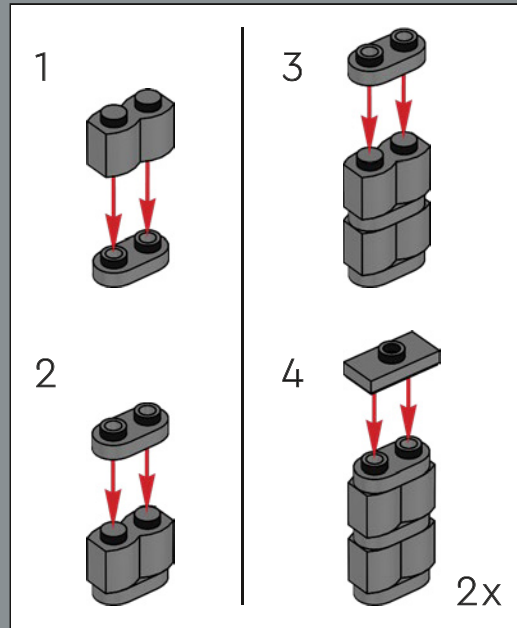

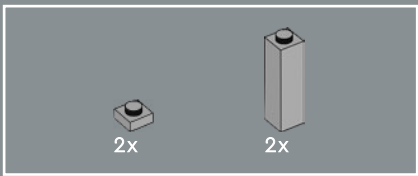

114

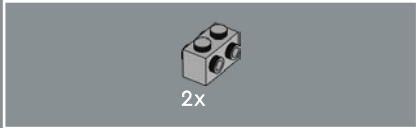
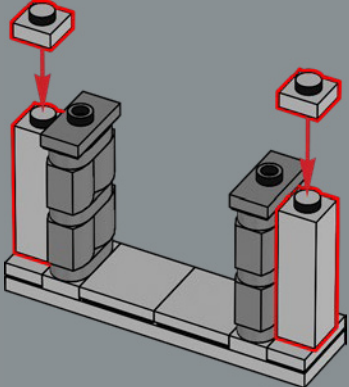

115

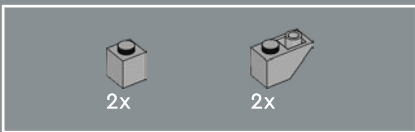
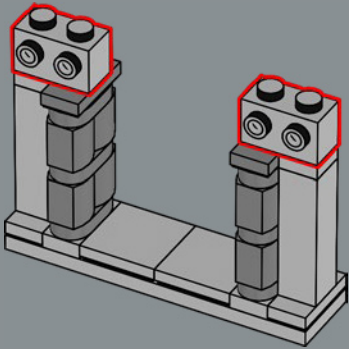

116

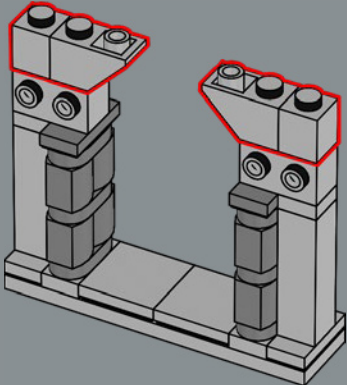

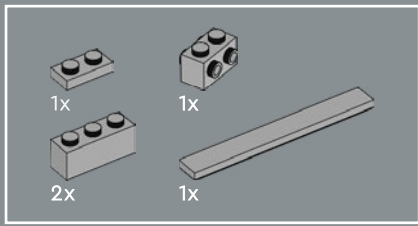

117

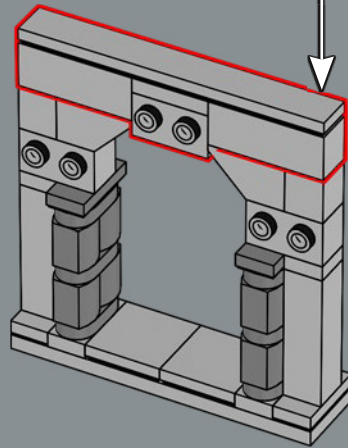
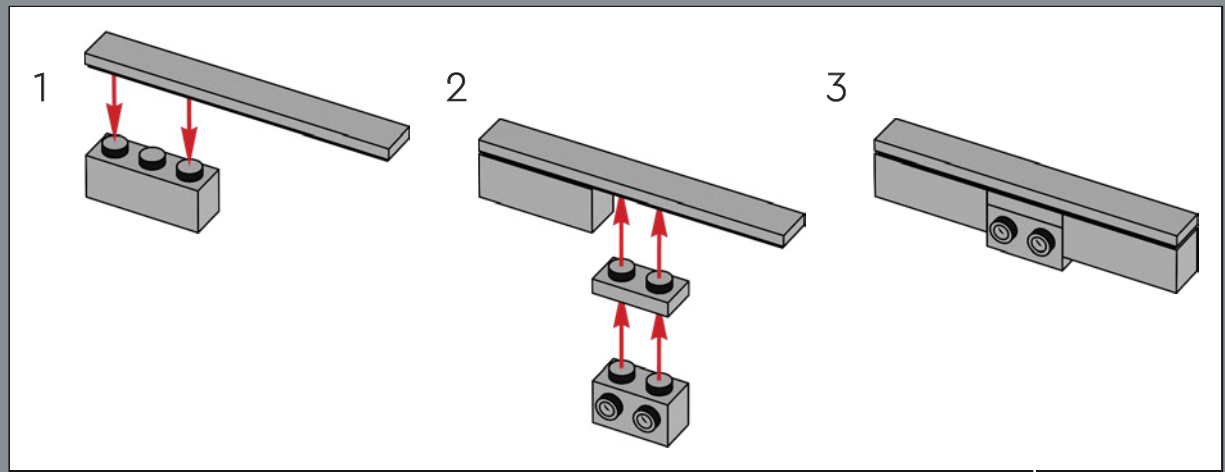

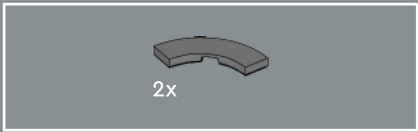

118

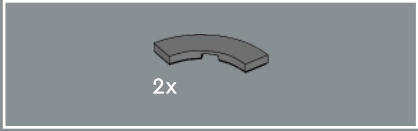
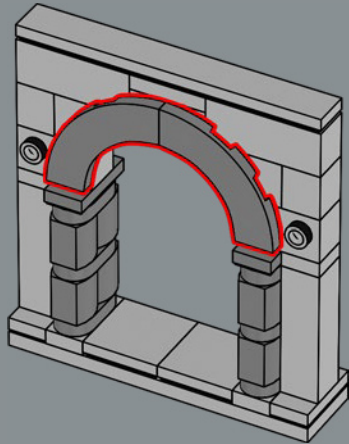

119

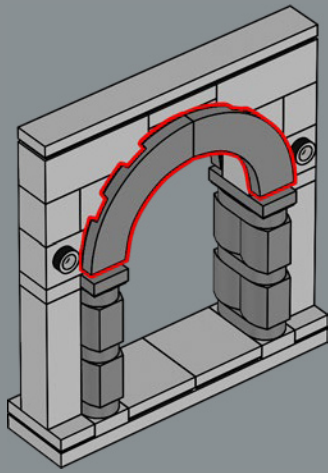

120

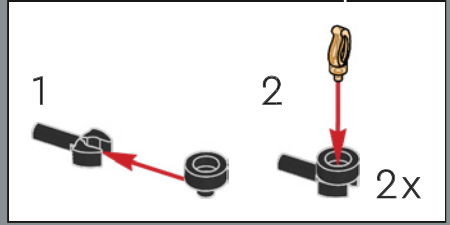
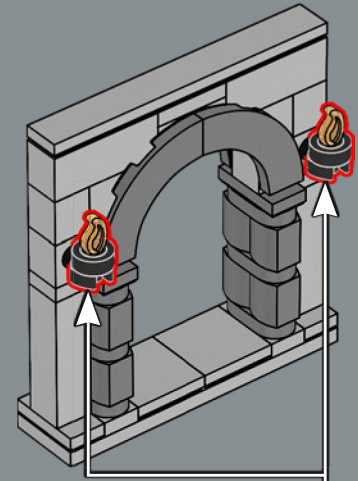

121

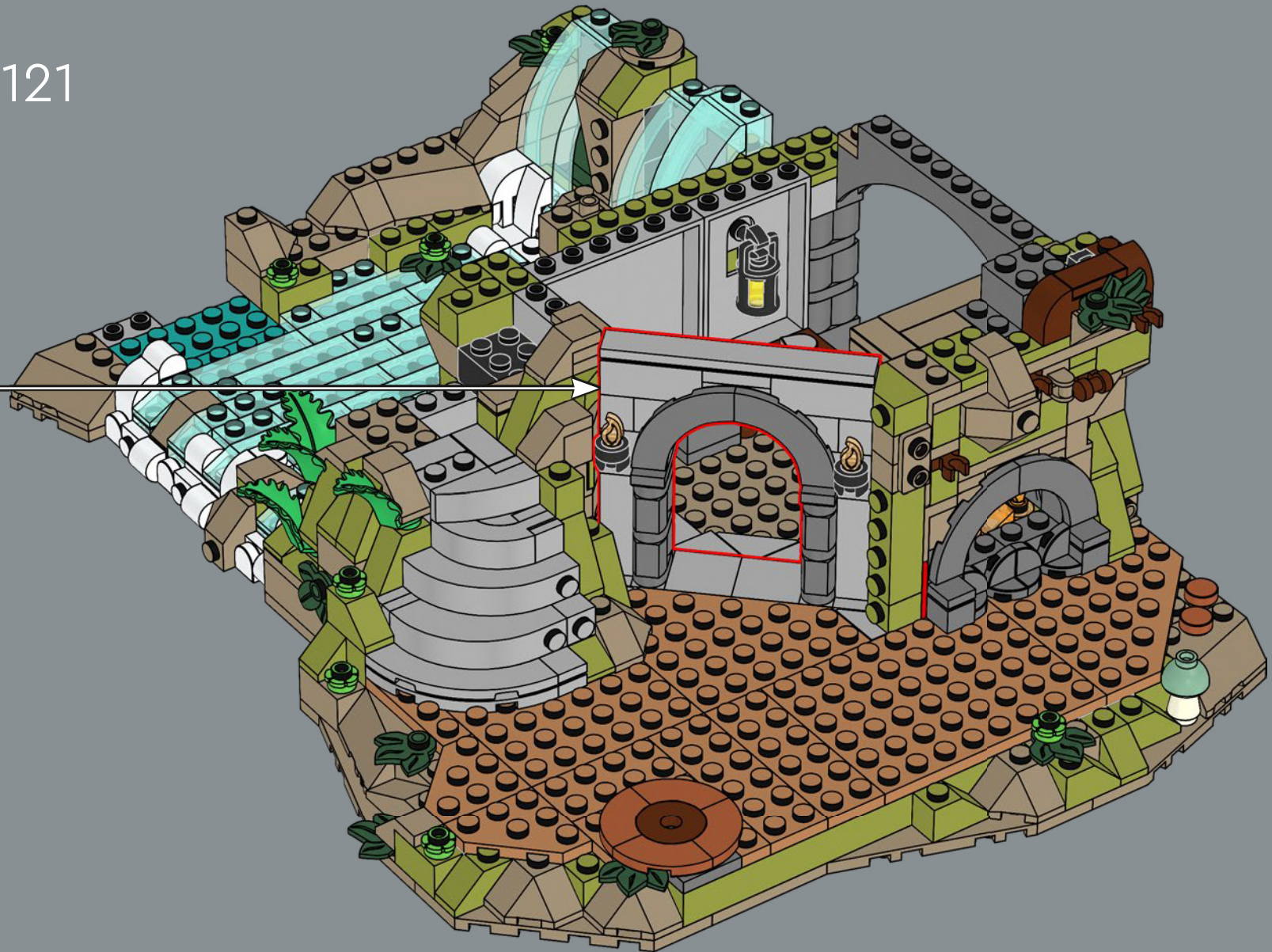

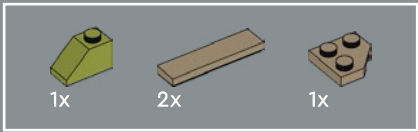

122

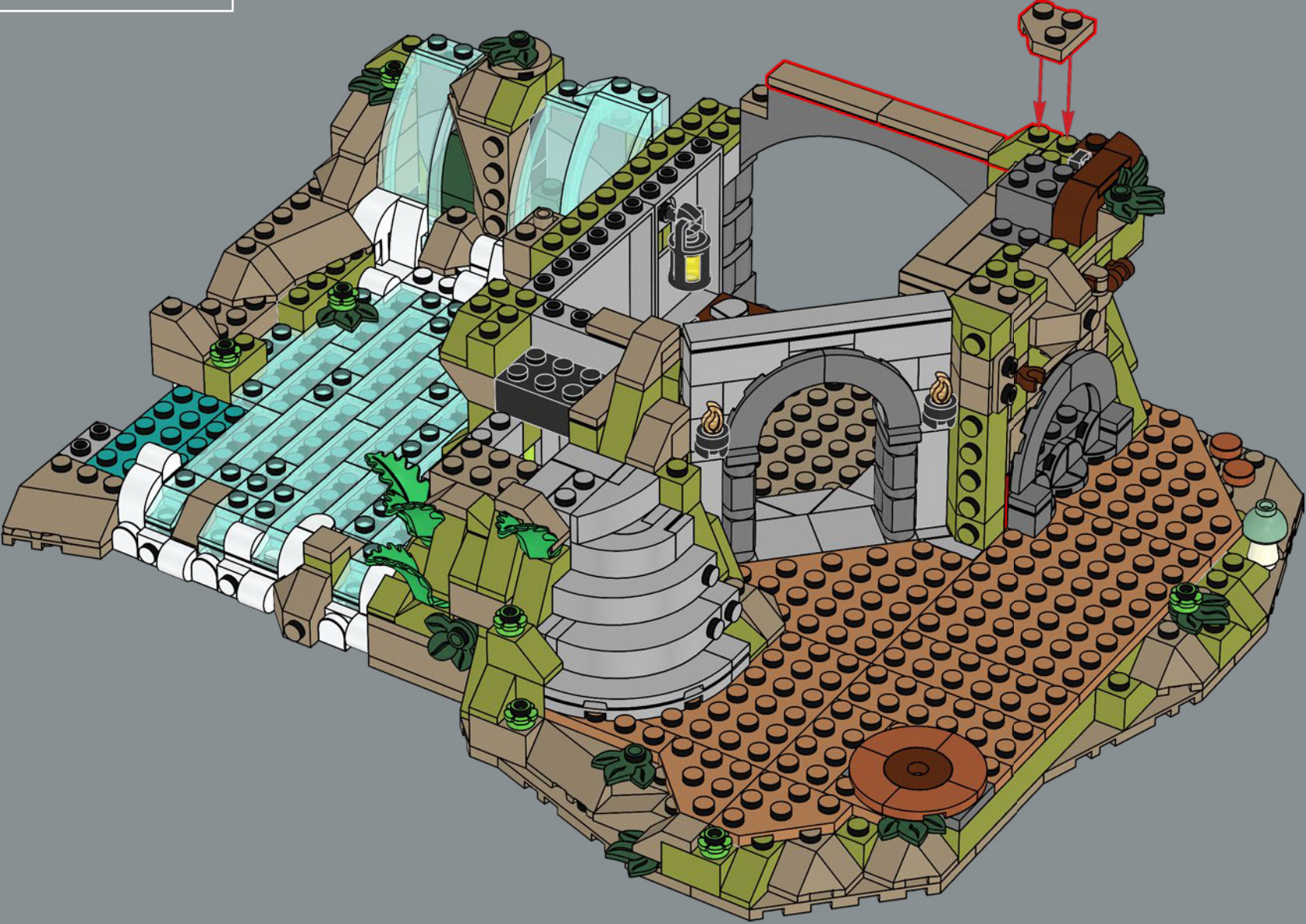

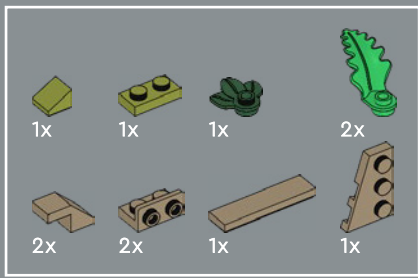

123

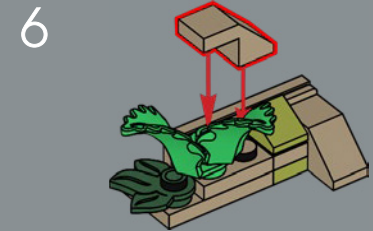
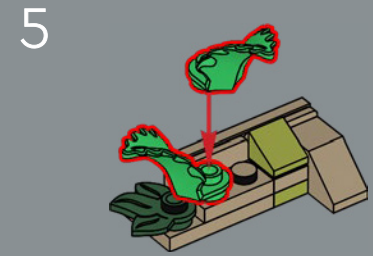
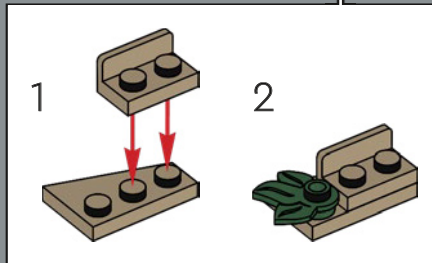
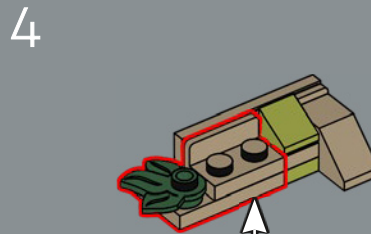
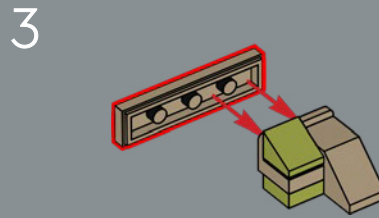
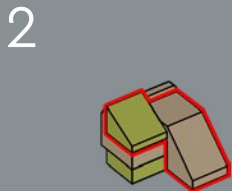
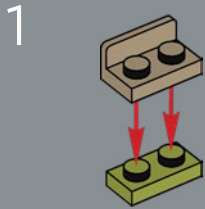

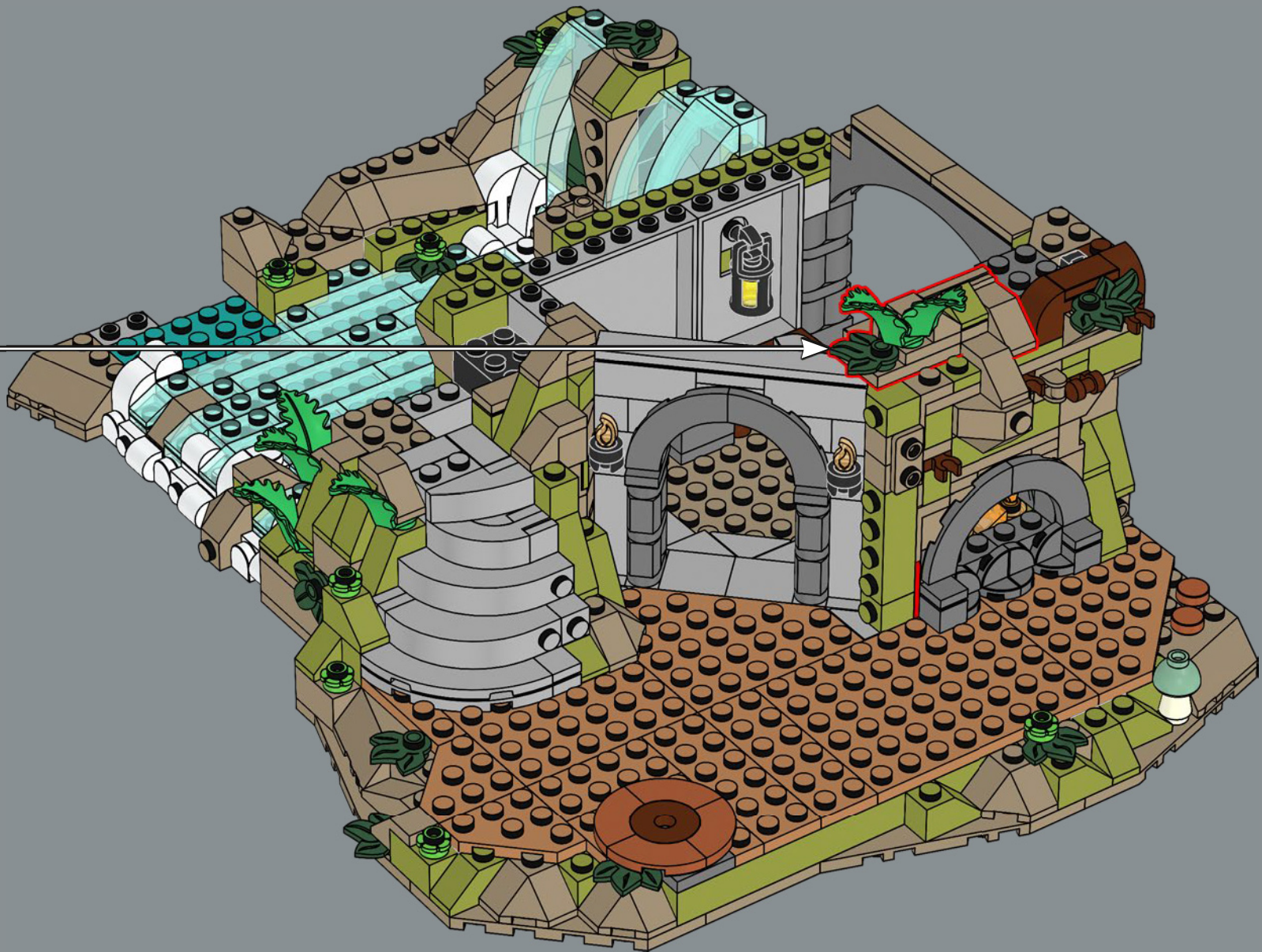

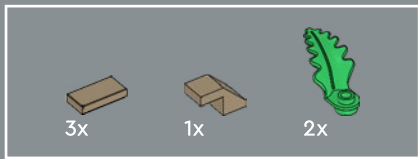

124

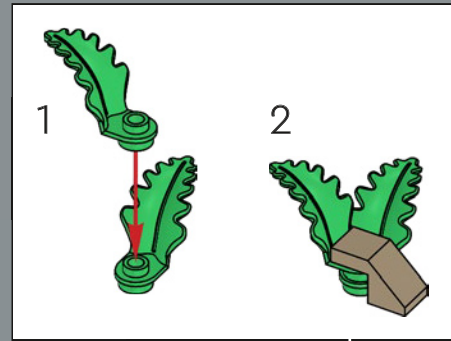

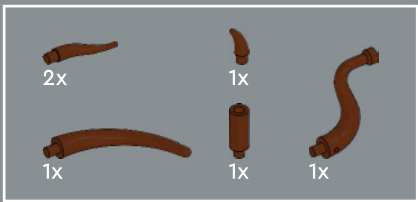

125

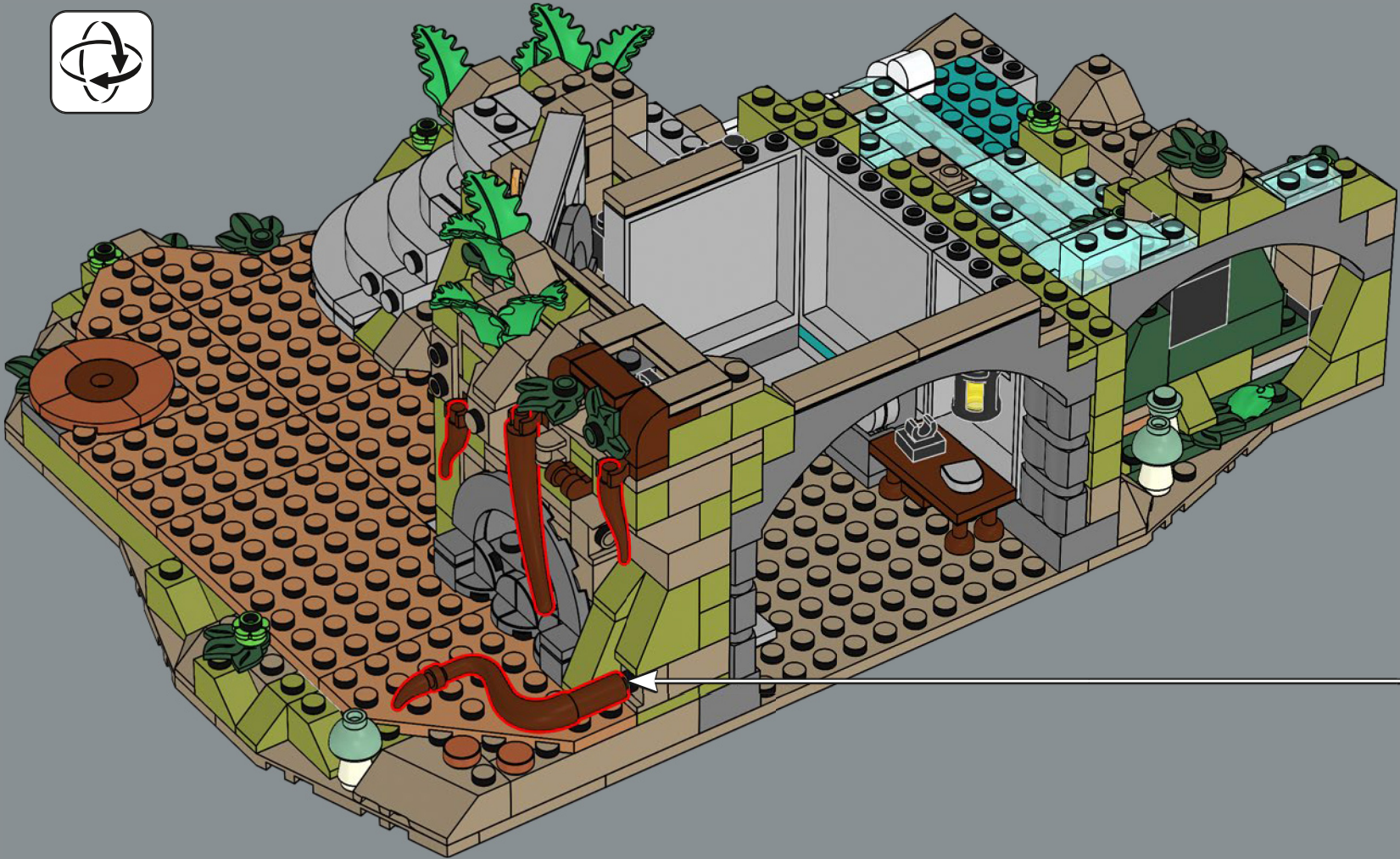
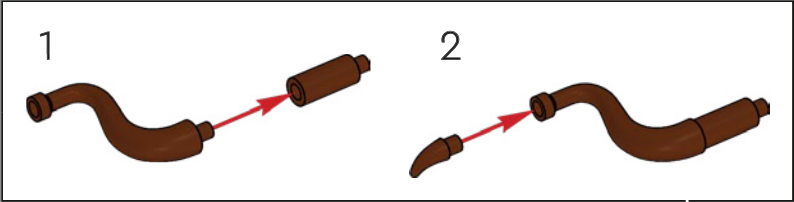

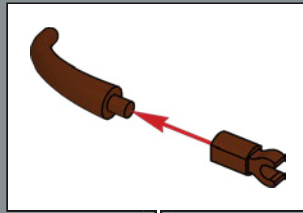
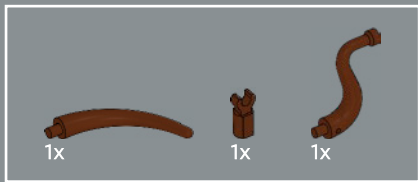

126

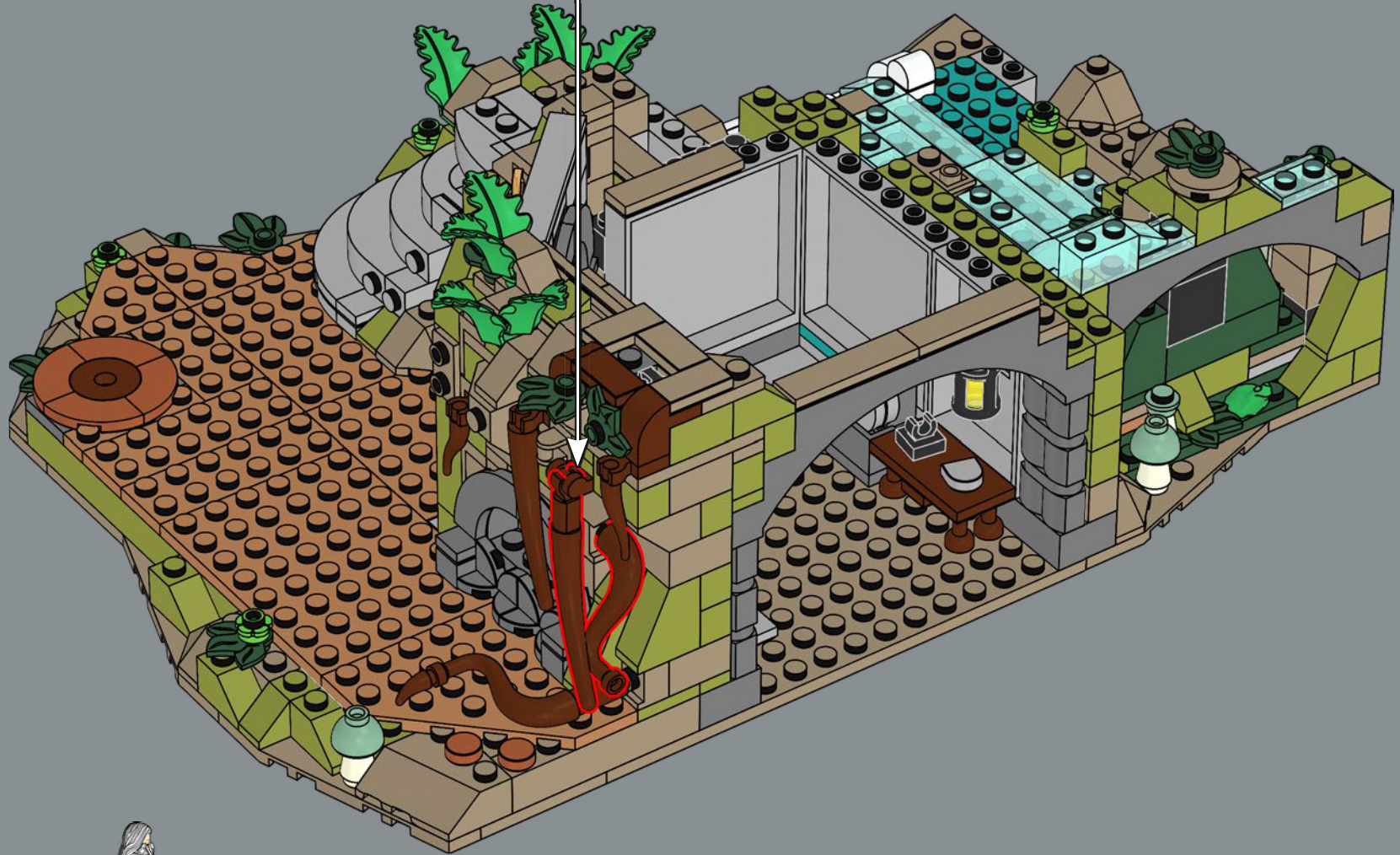

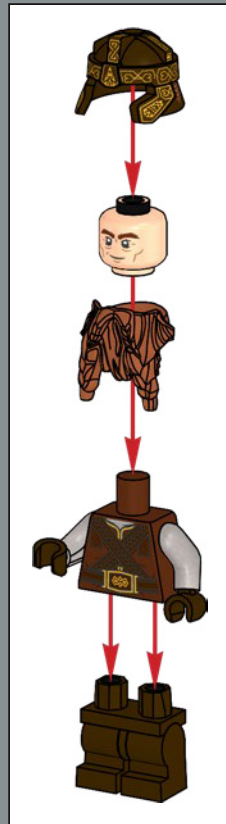
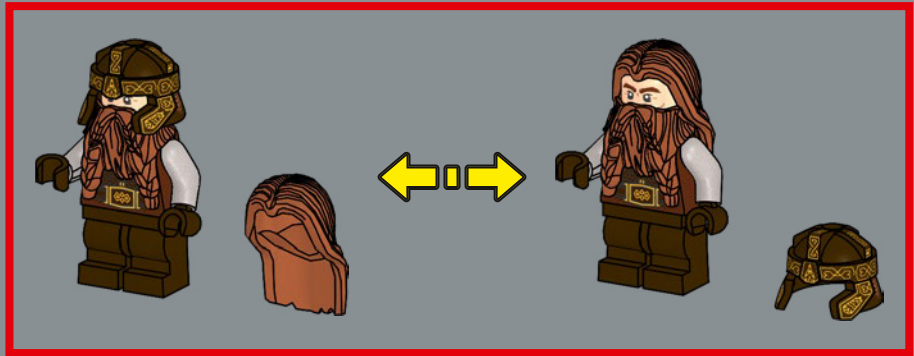

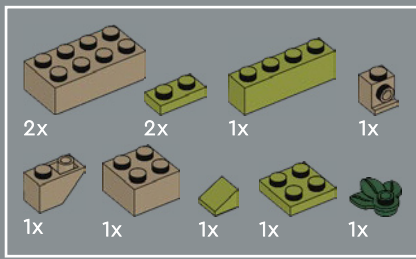

127

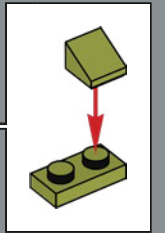
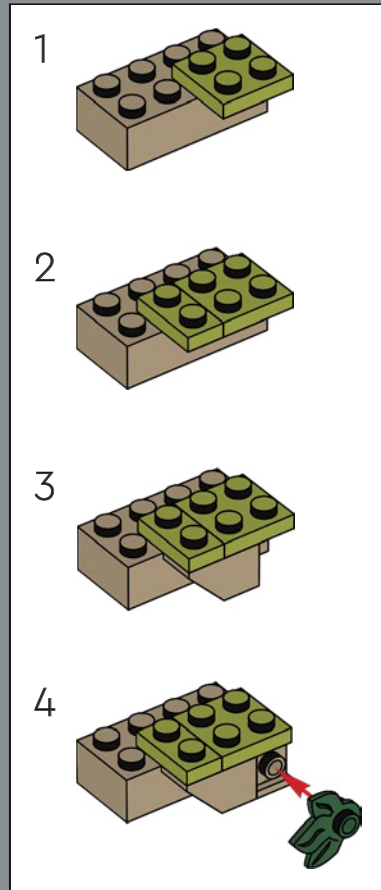

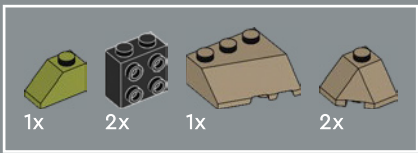

128

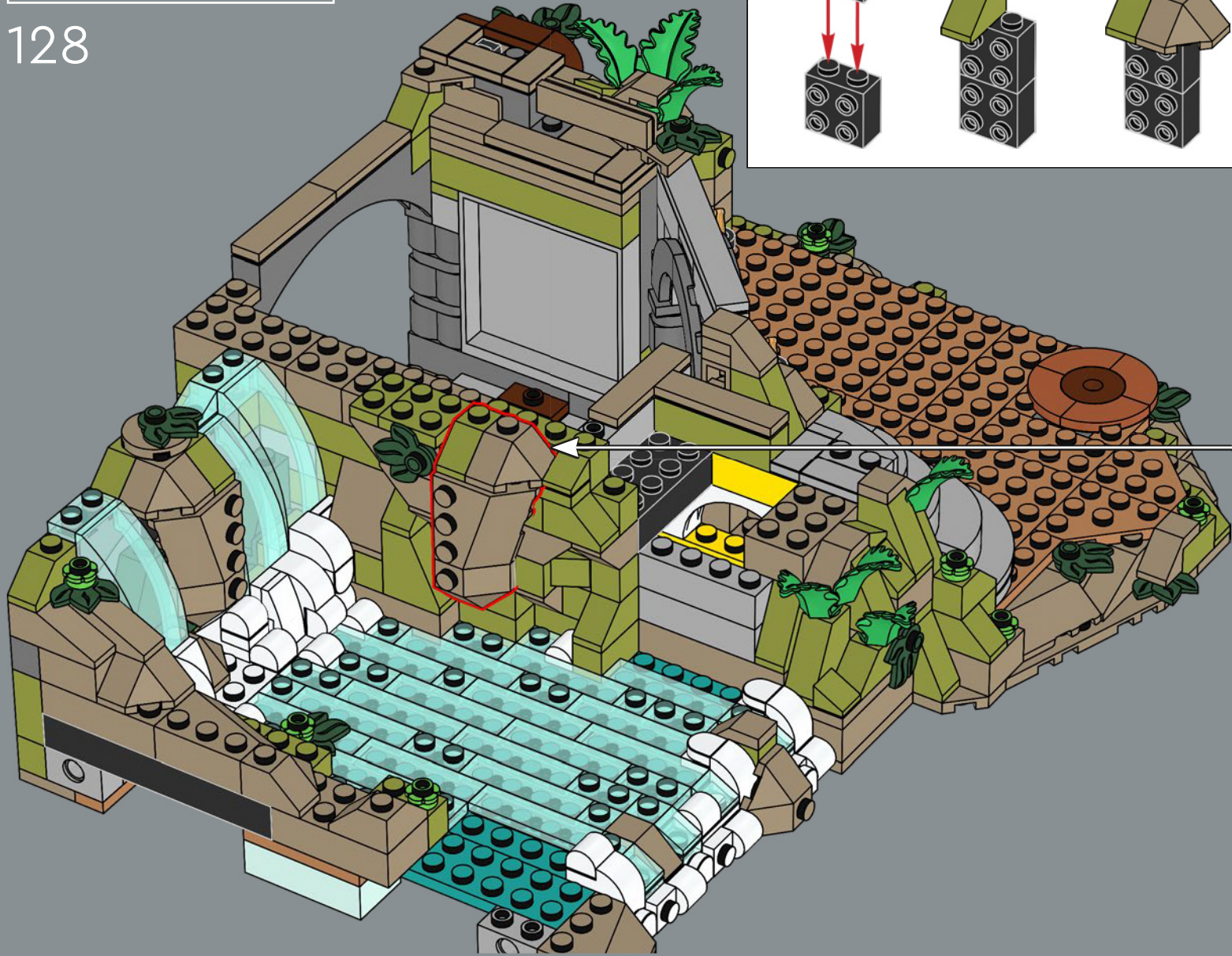
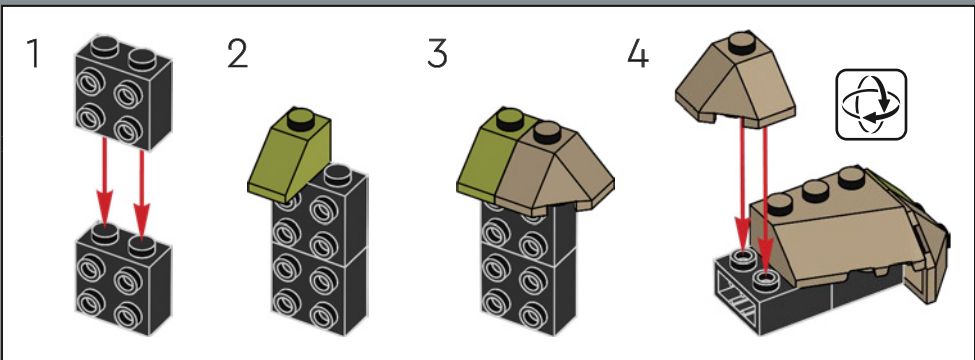

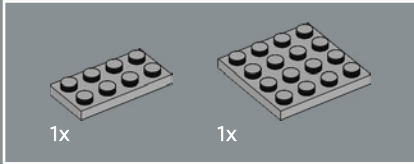
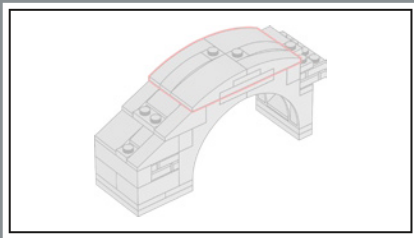

129

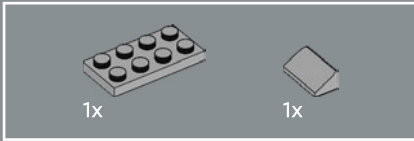
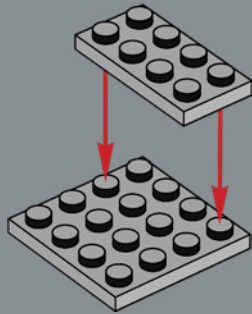

130

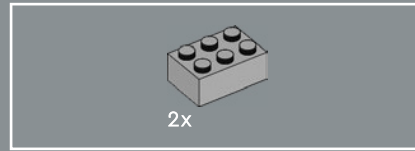
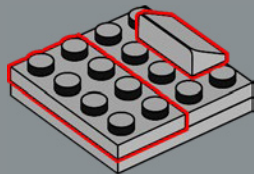

131

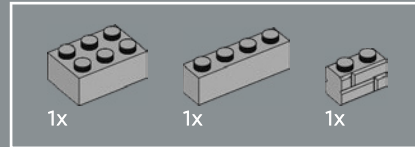
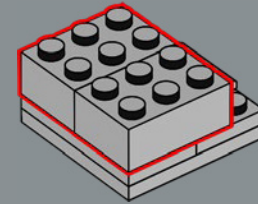

132

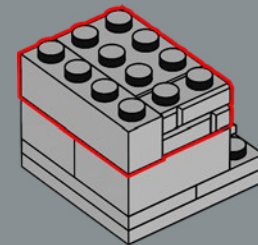

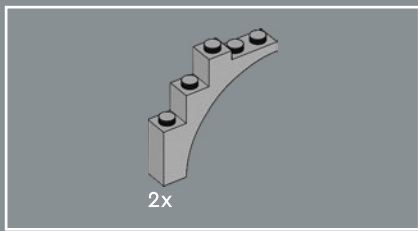

133

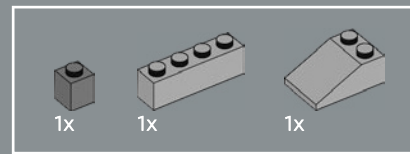
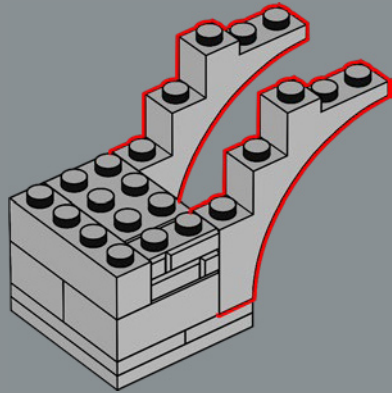

134

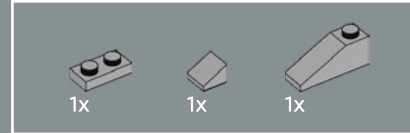
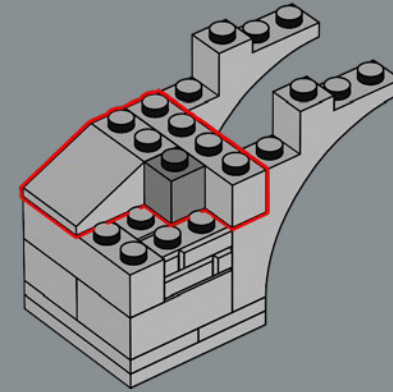

135

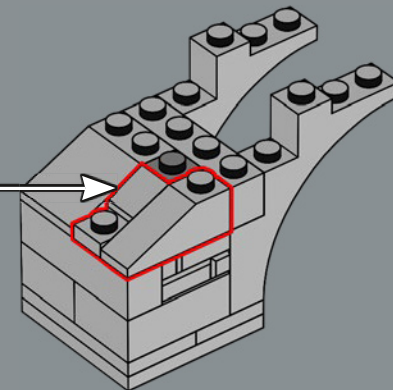
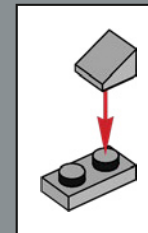

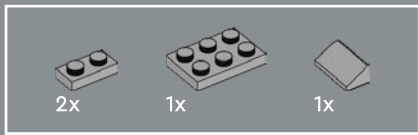

136

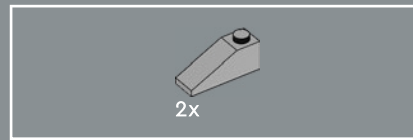
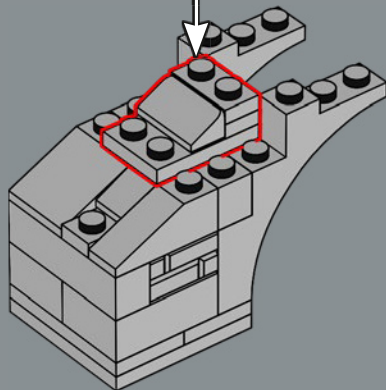
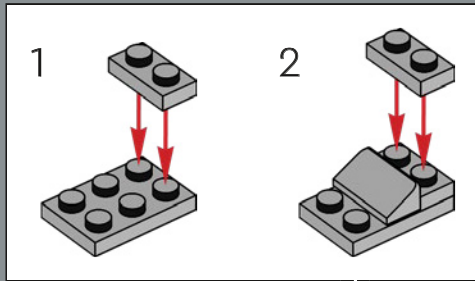

137

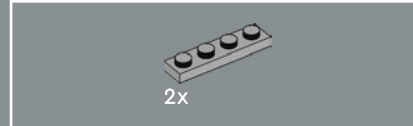
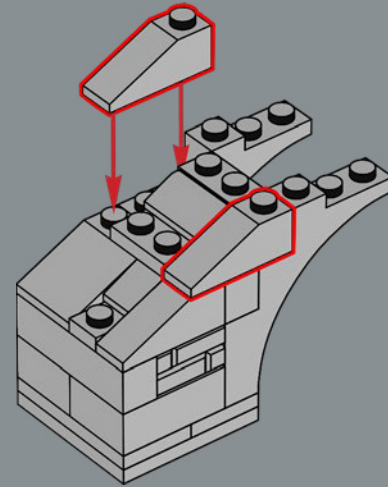

138

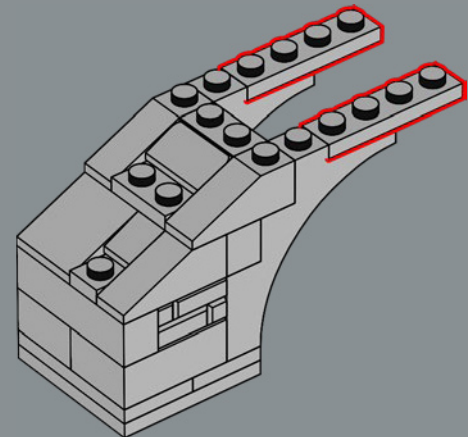

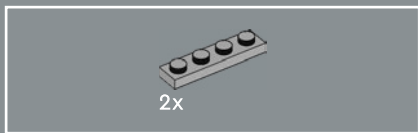

139

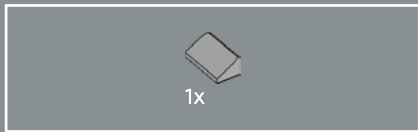
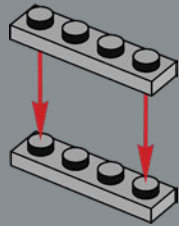

140

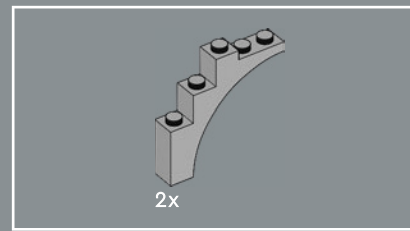
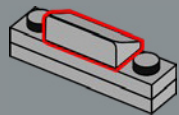

141

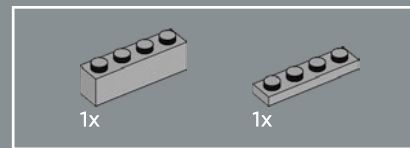
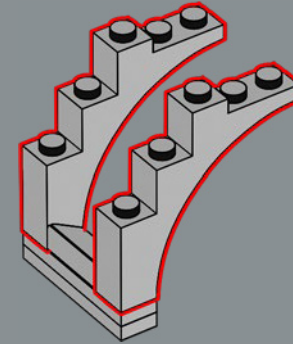

142

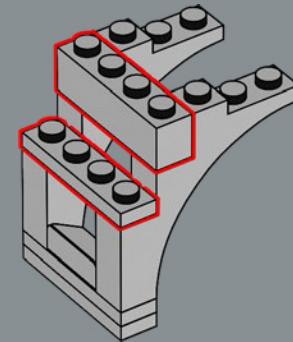

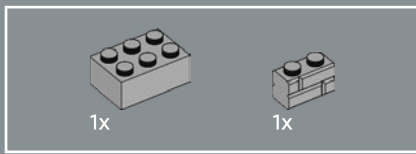

143

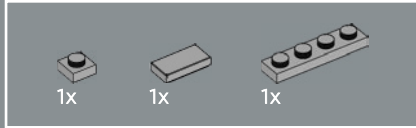
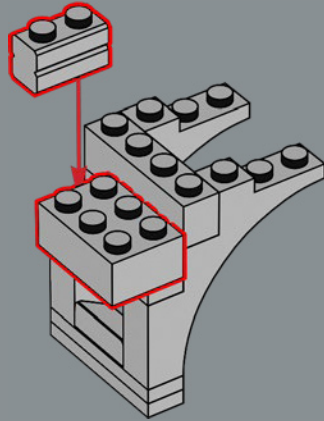

144

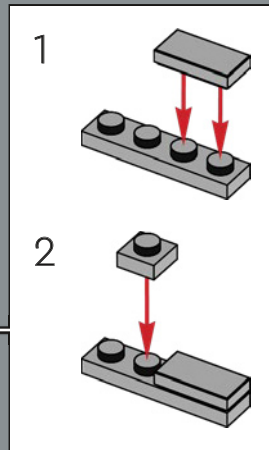
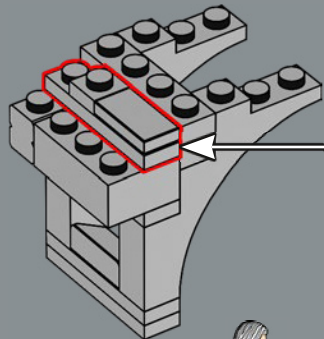

145

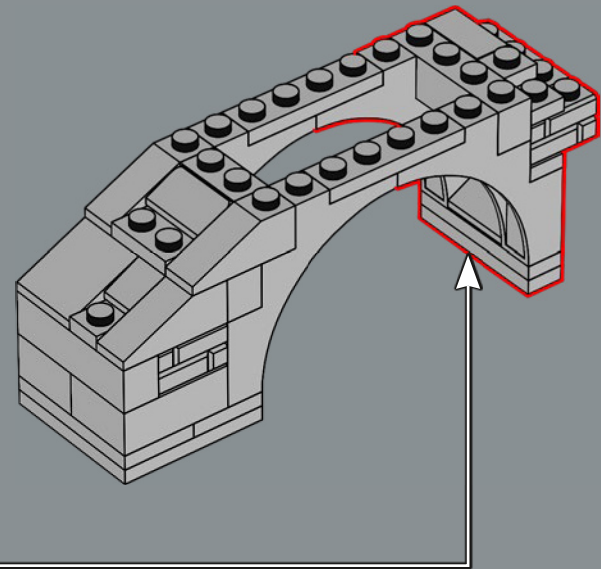

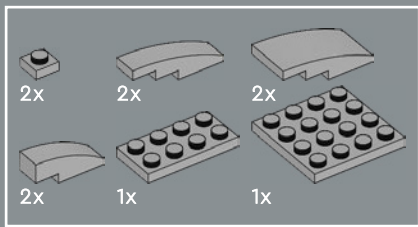

146

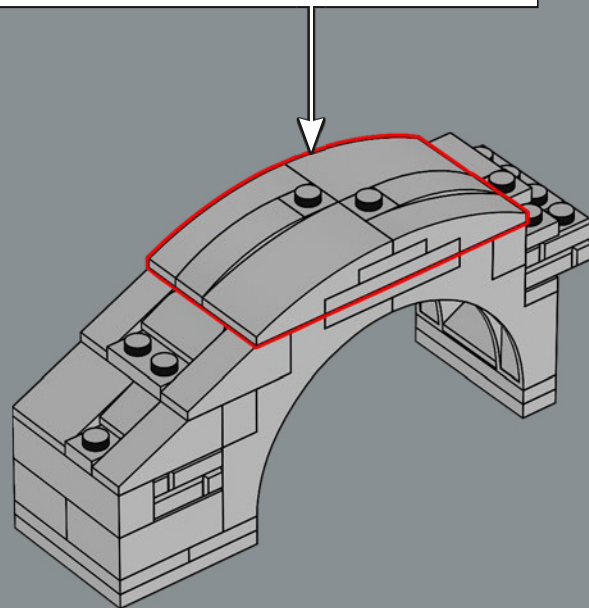
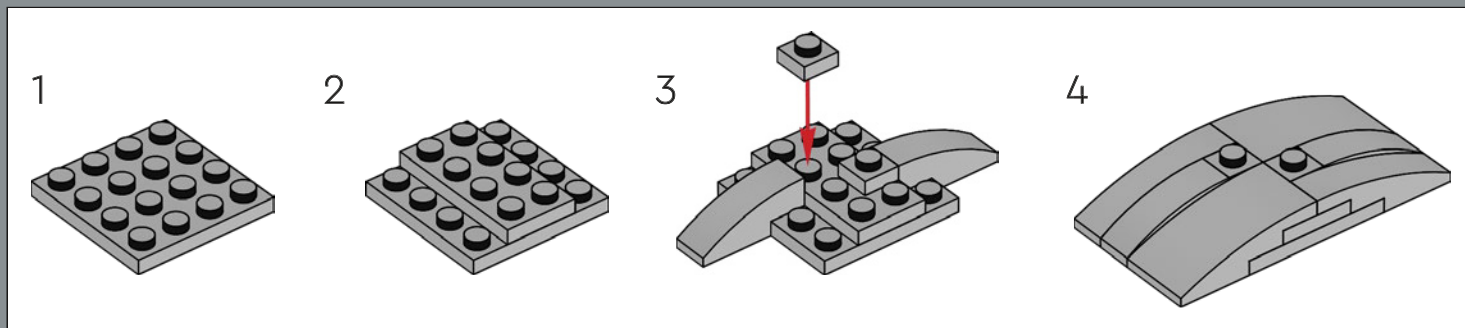

由于这座桥没有扶手，所以我们在桥面上添加了大量凸粒，以确保小人仔的安全。

147

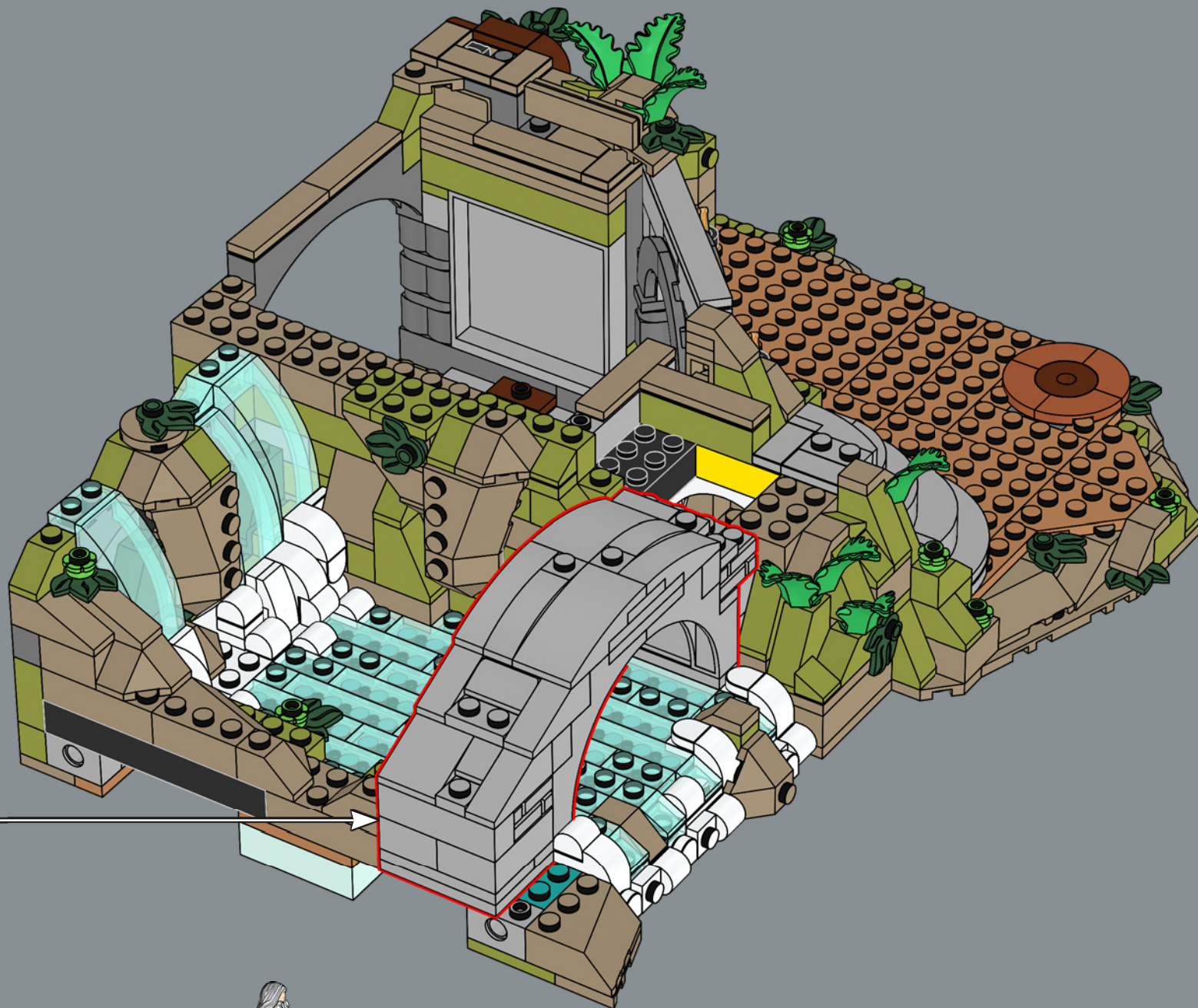

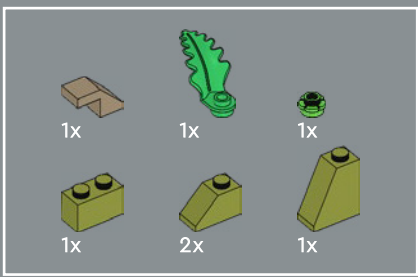

148

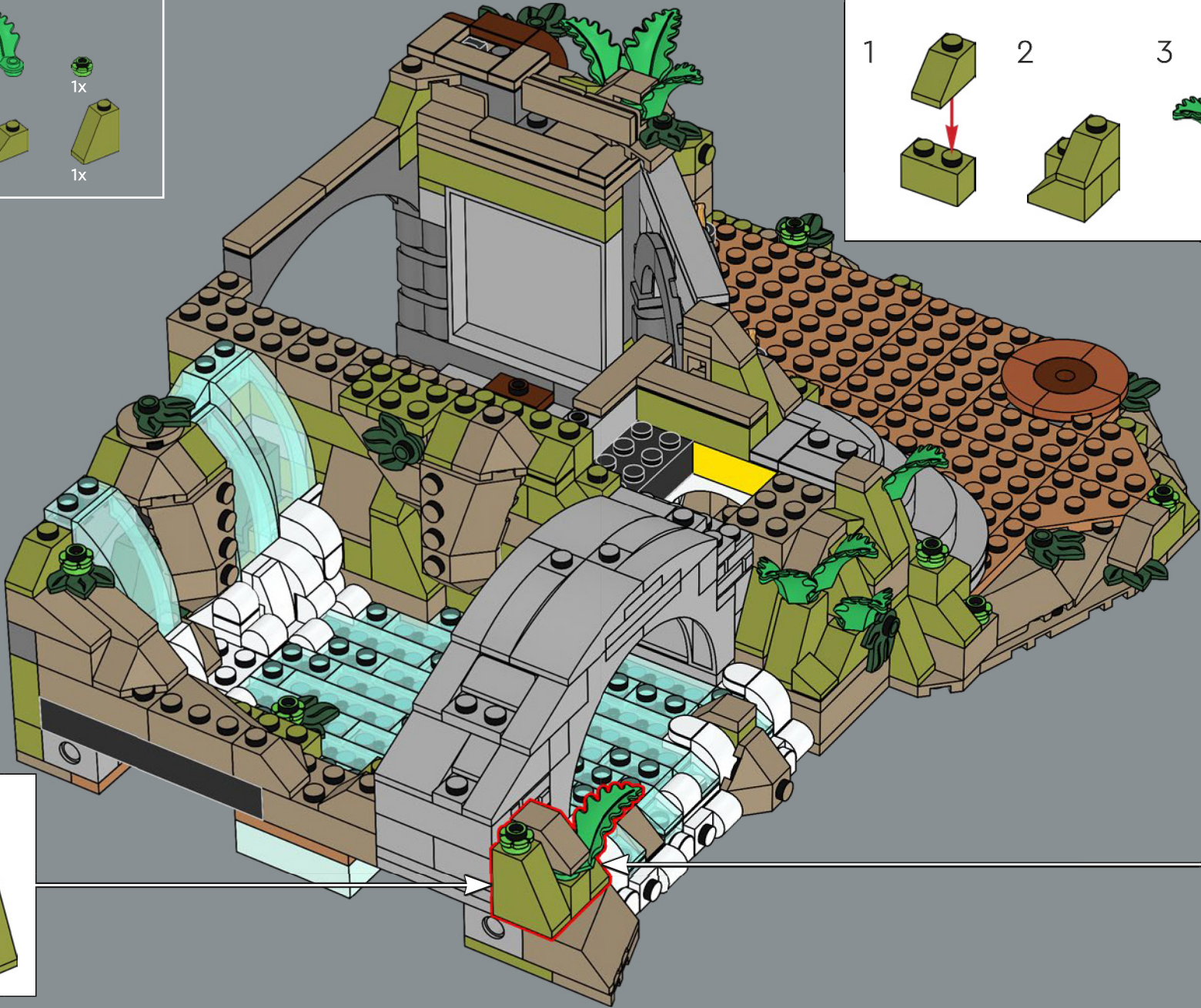
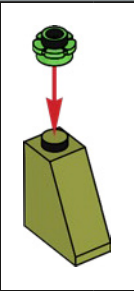
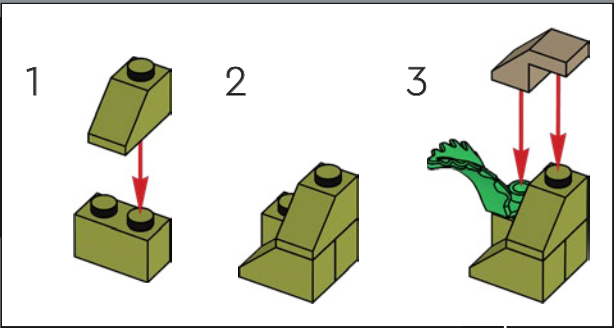

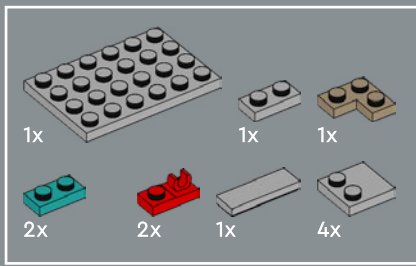

149

1

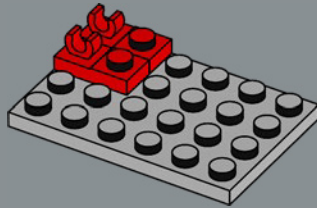

2

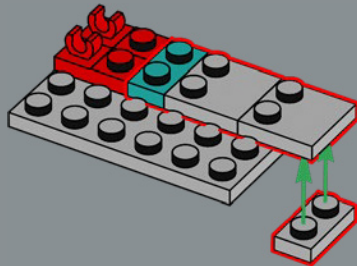

3

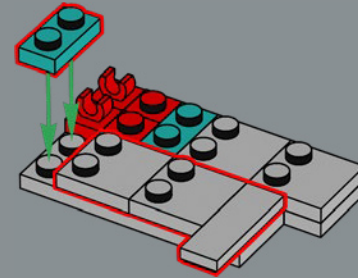

4

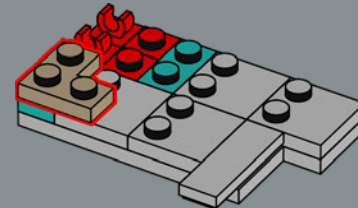

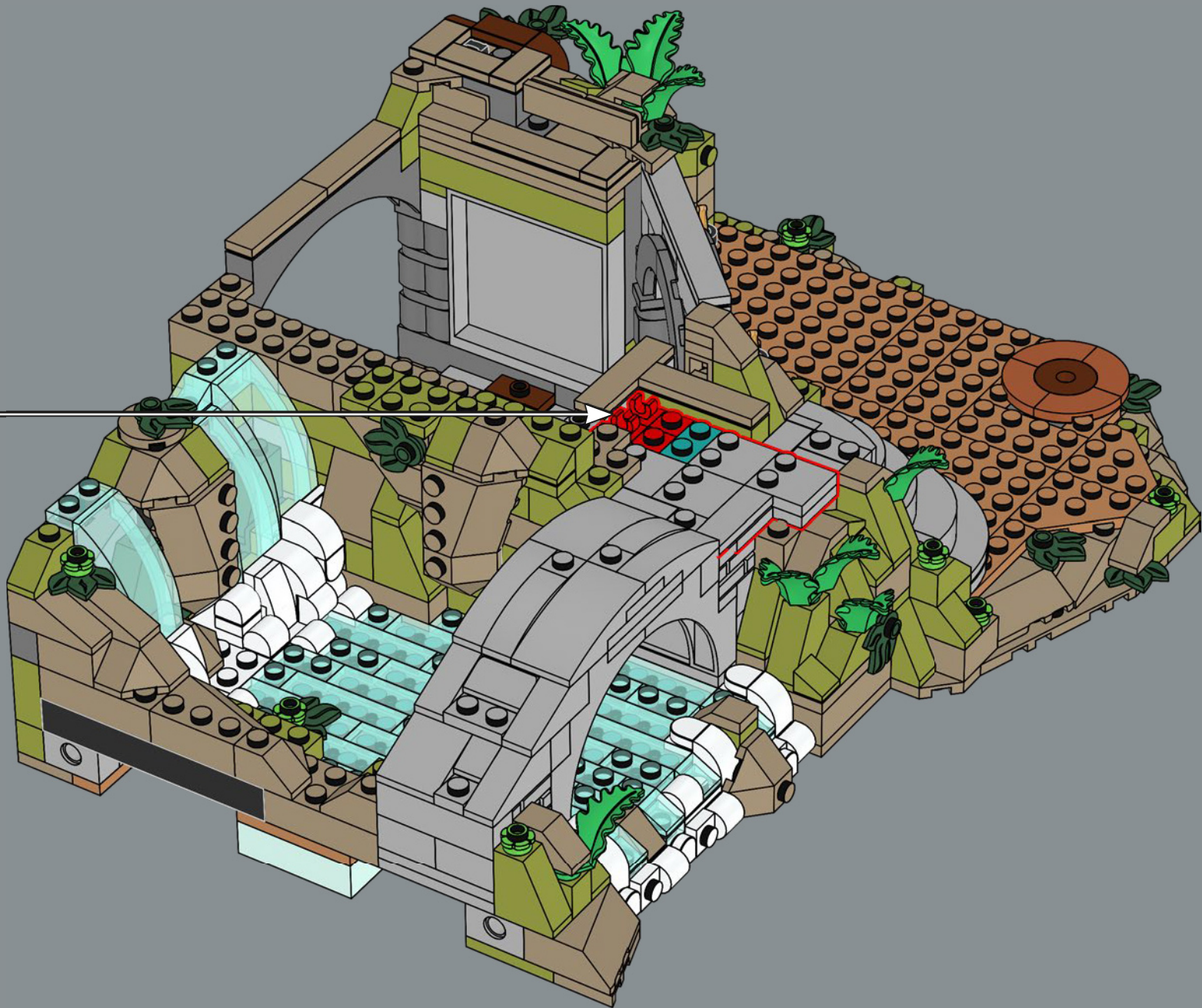



150

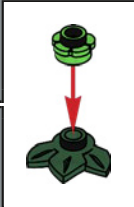
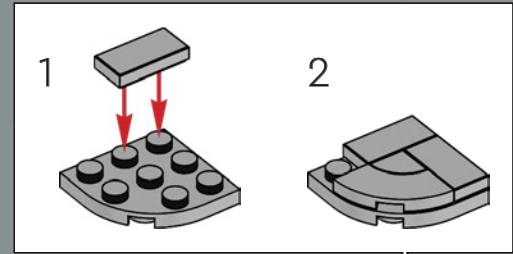
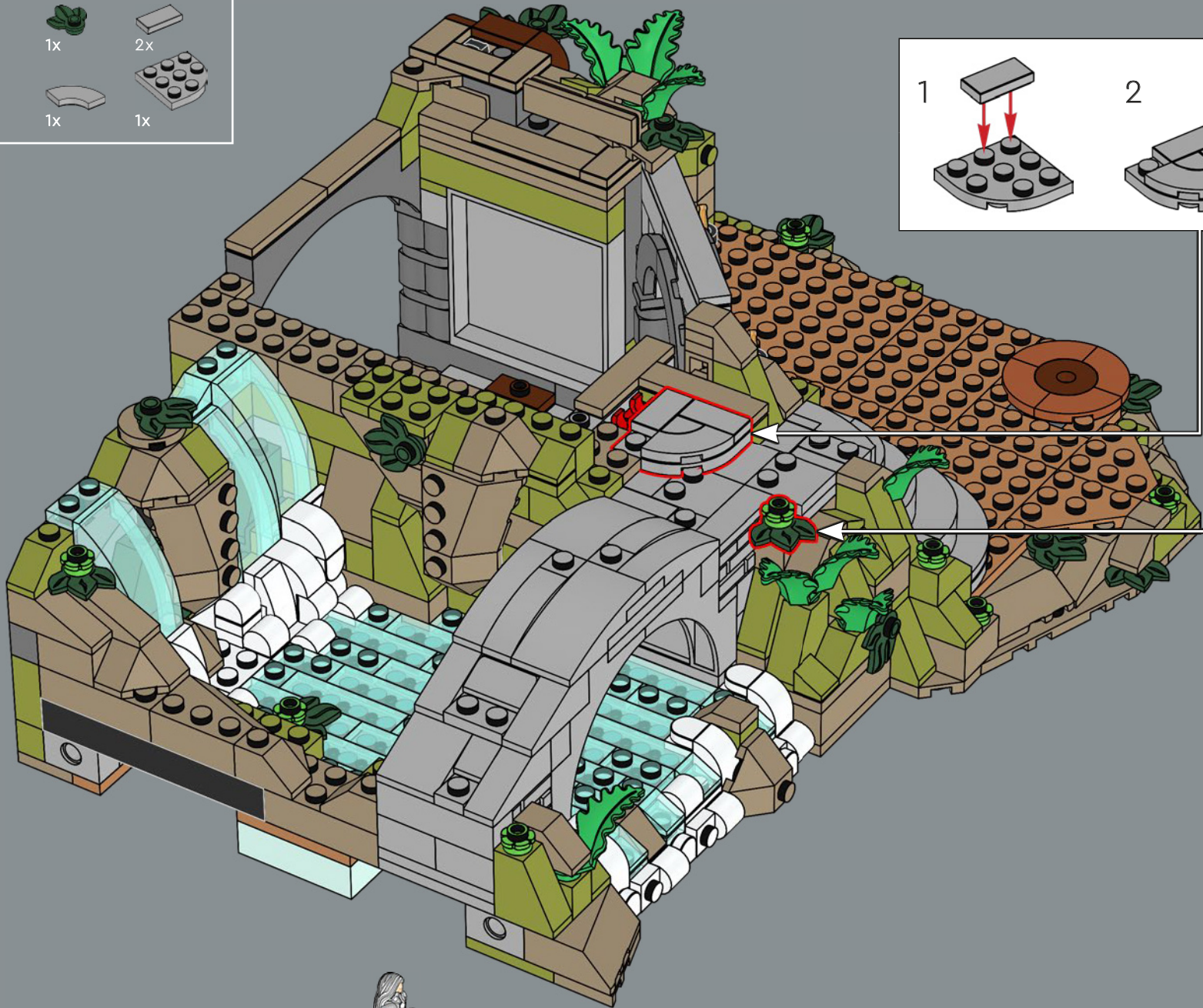

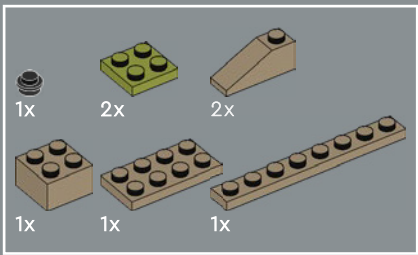

151

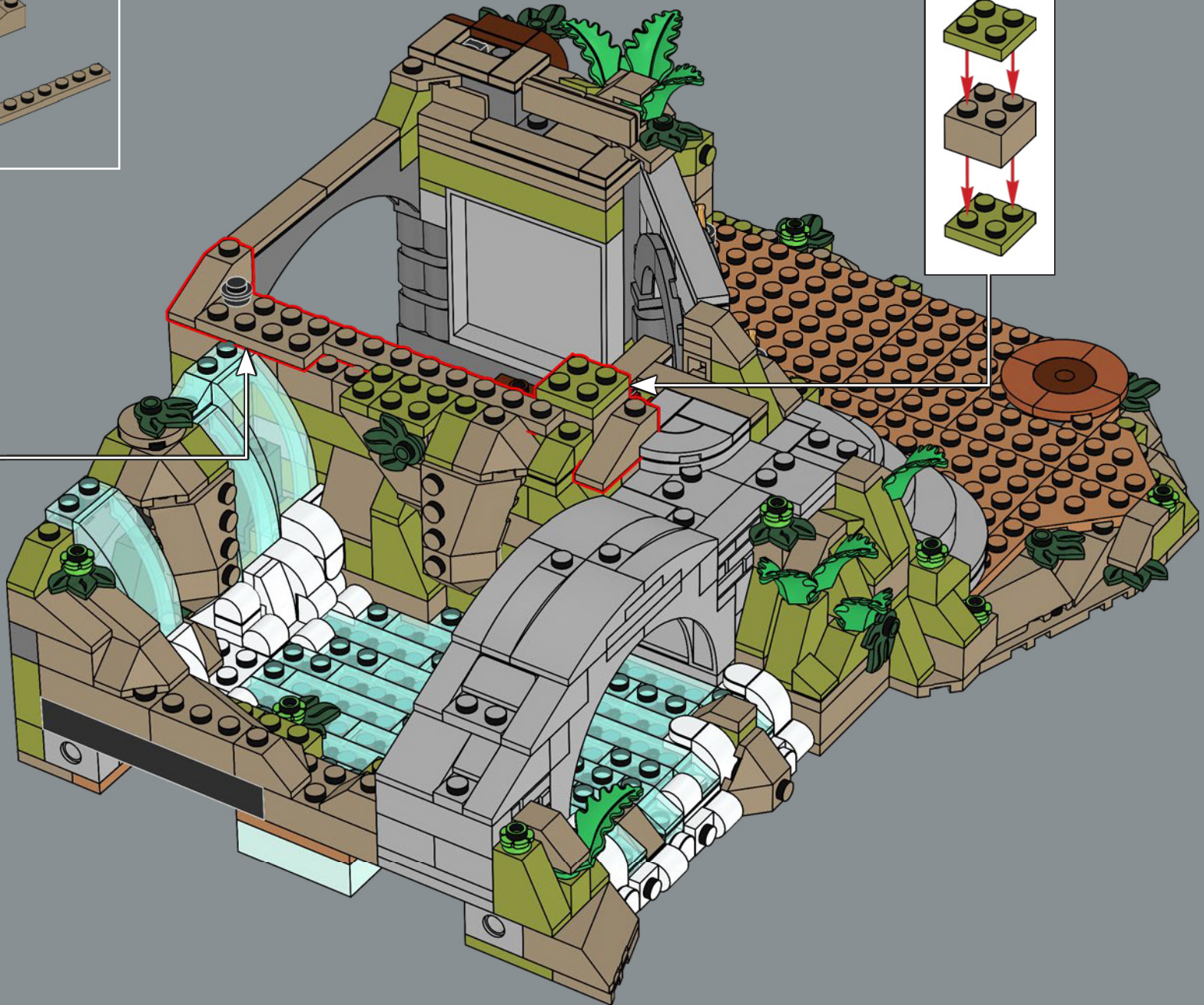
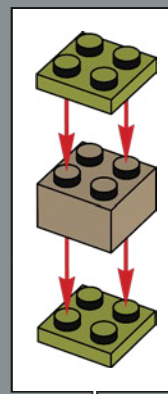
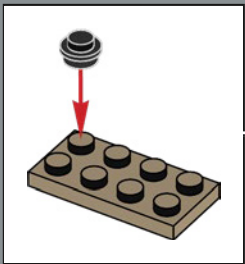

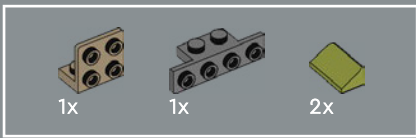

152

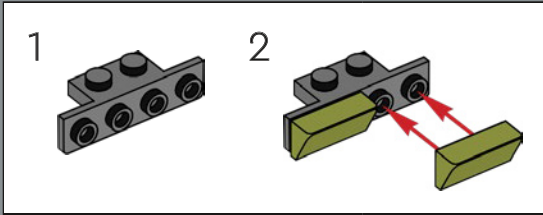

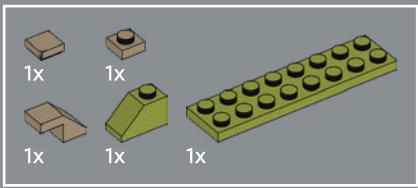

153

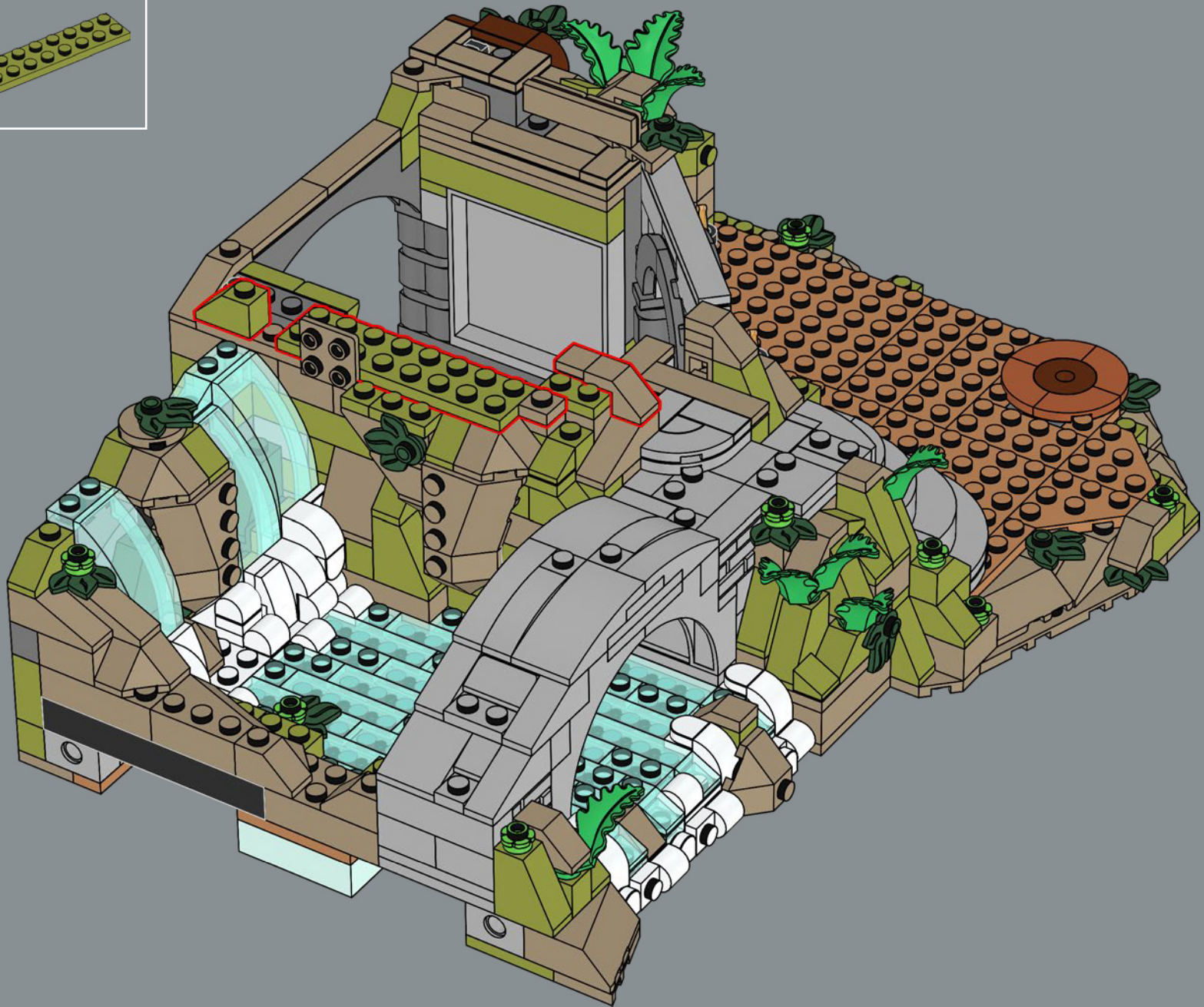

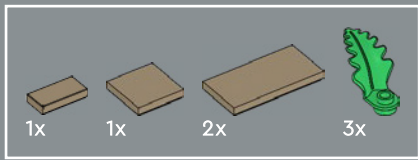

154

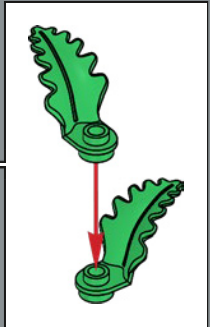
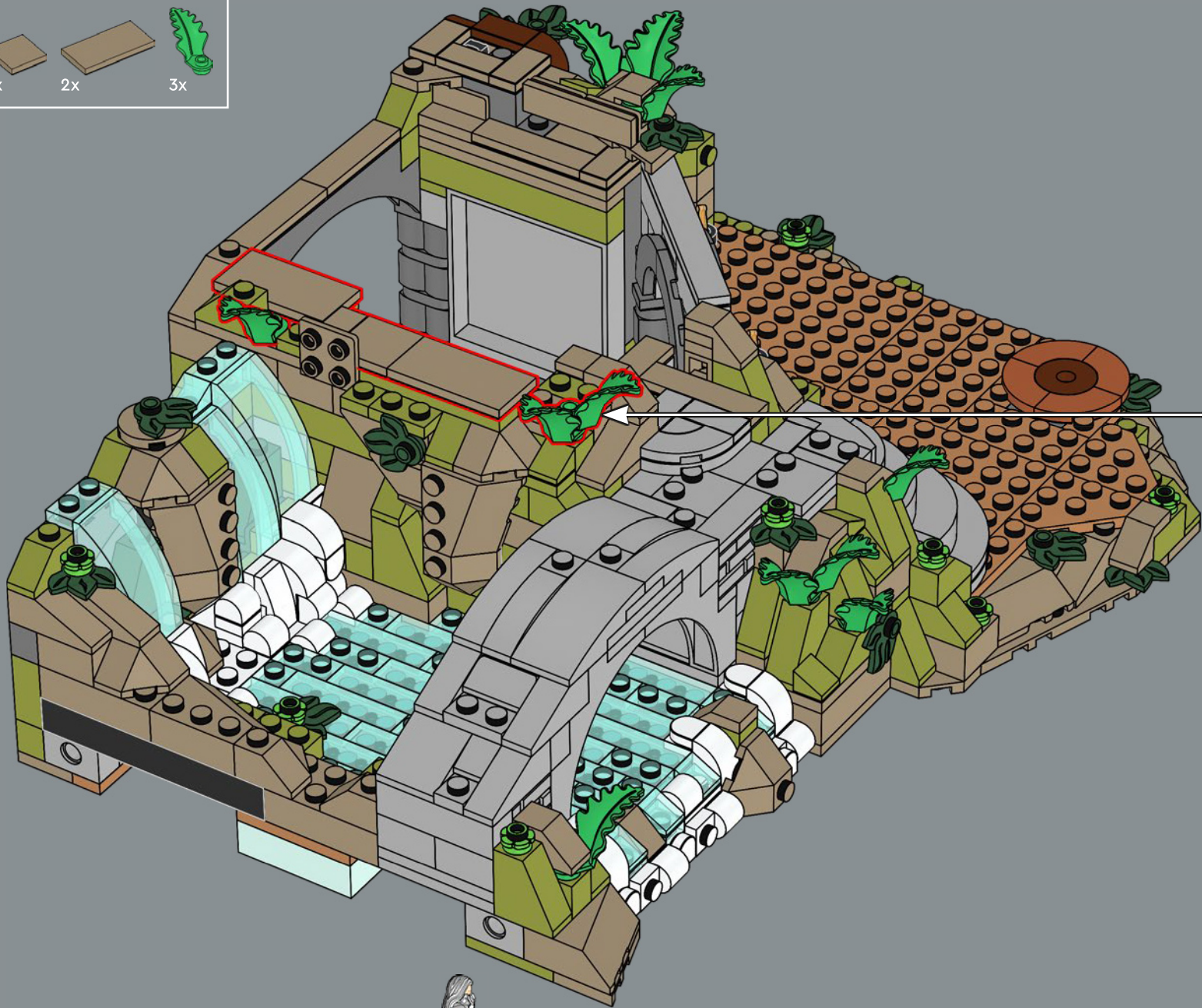

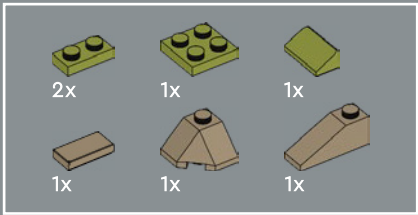

155

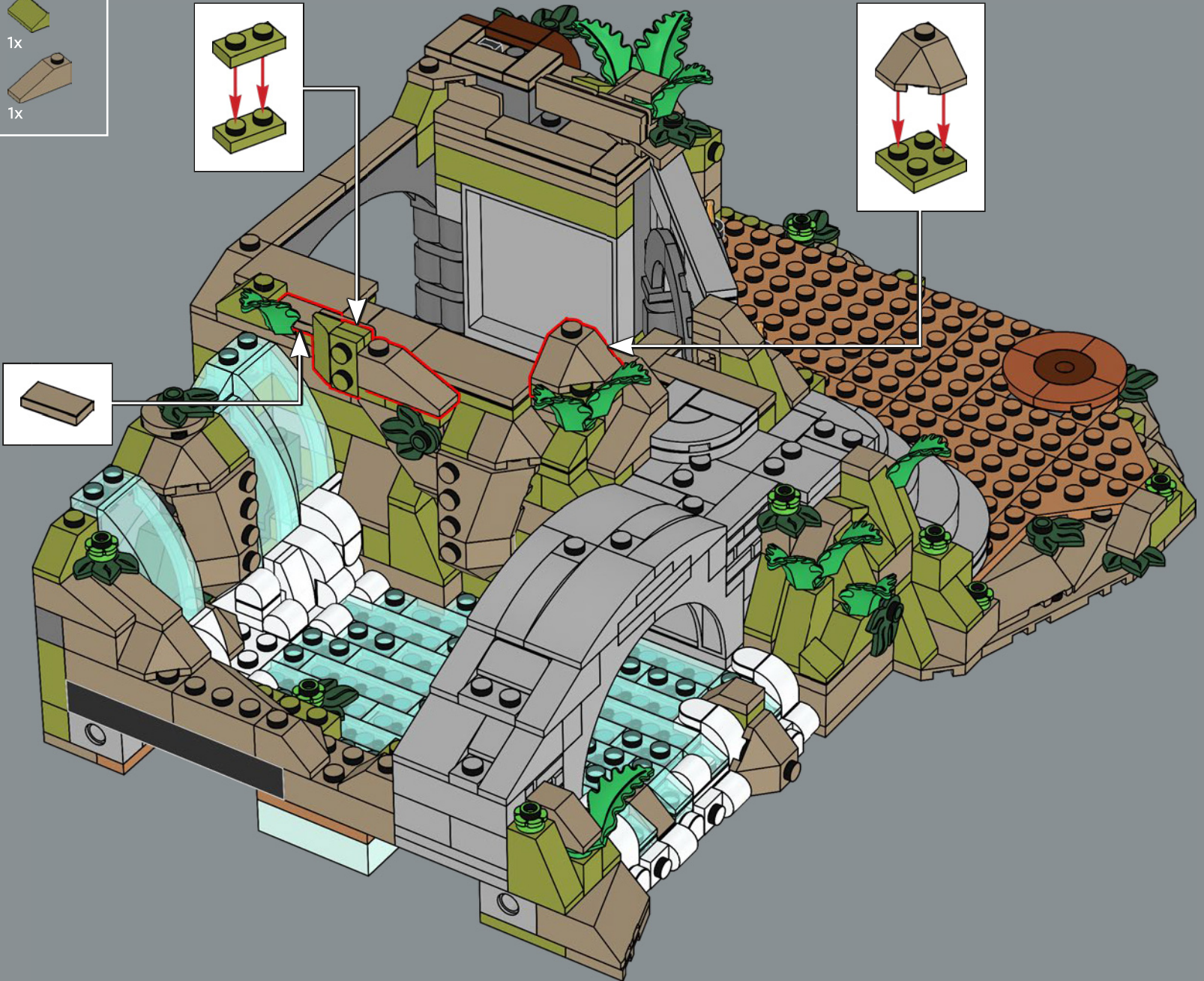
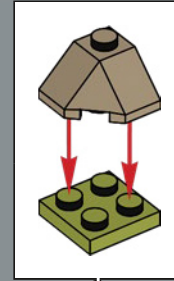
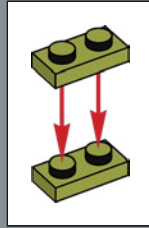

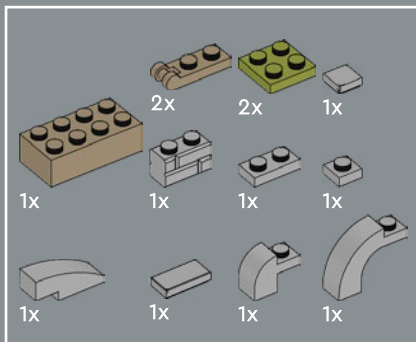

156

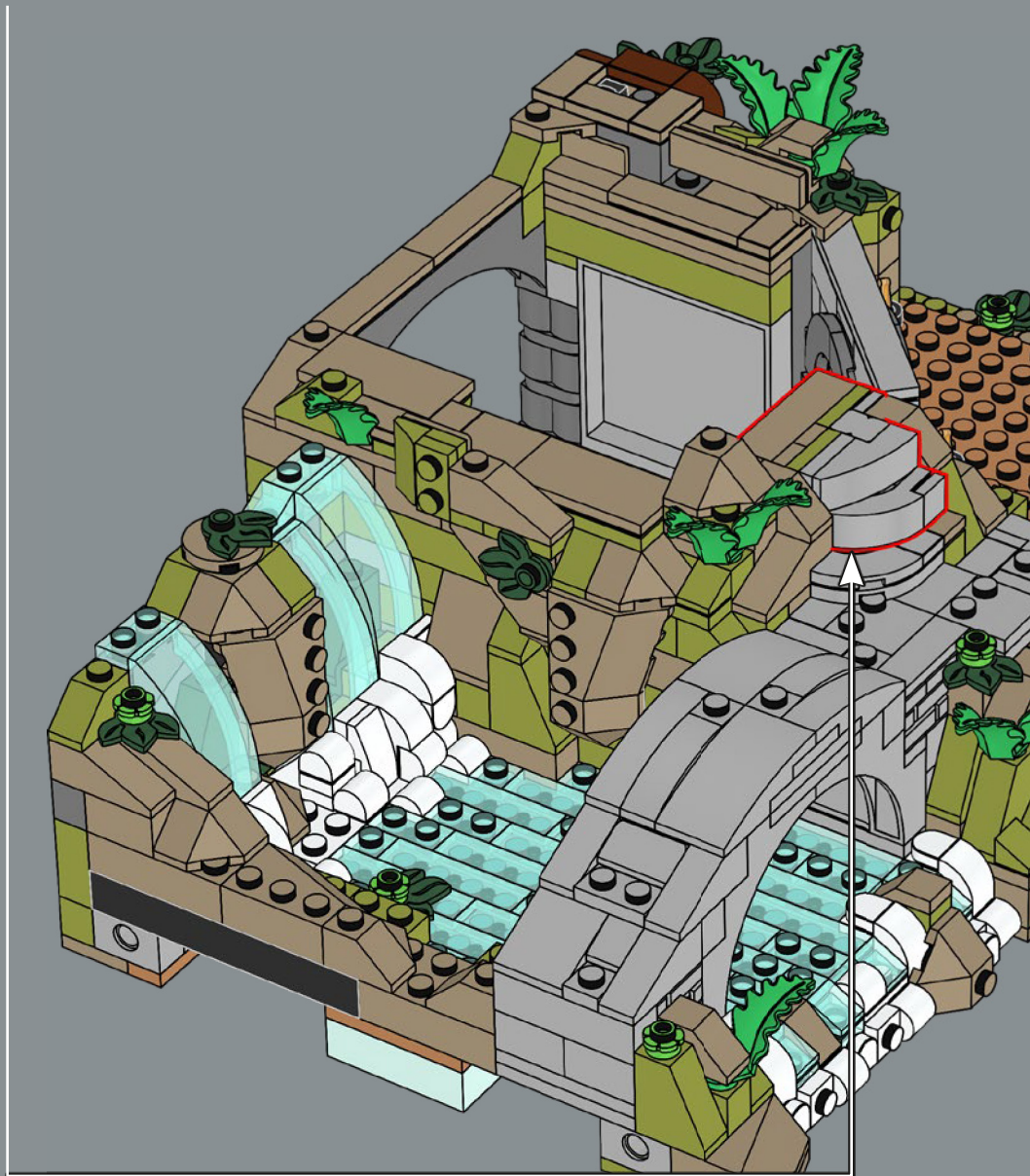
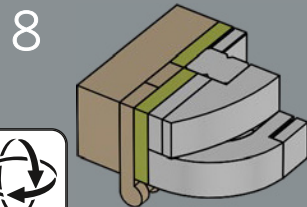
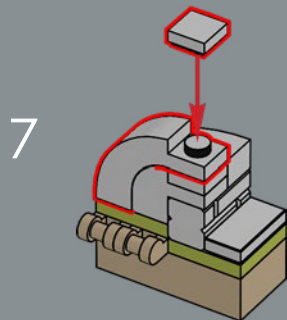
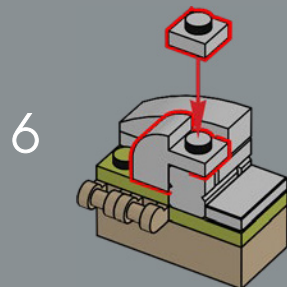
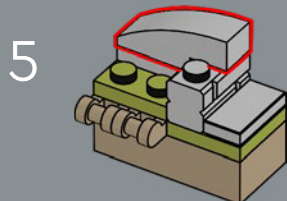
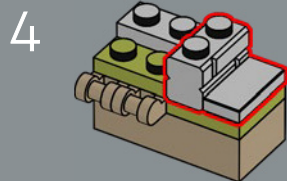
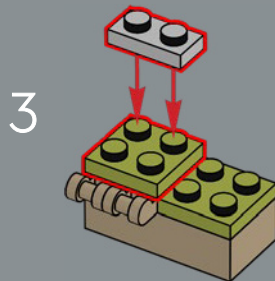
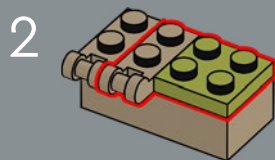
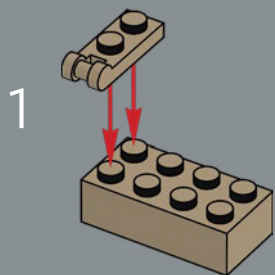



精灵假发是这款套装的全新组件,采用两种不同的材料模塑而成,以使耳朵和头发拥有不同的颜色。

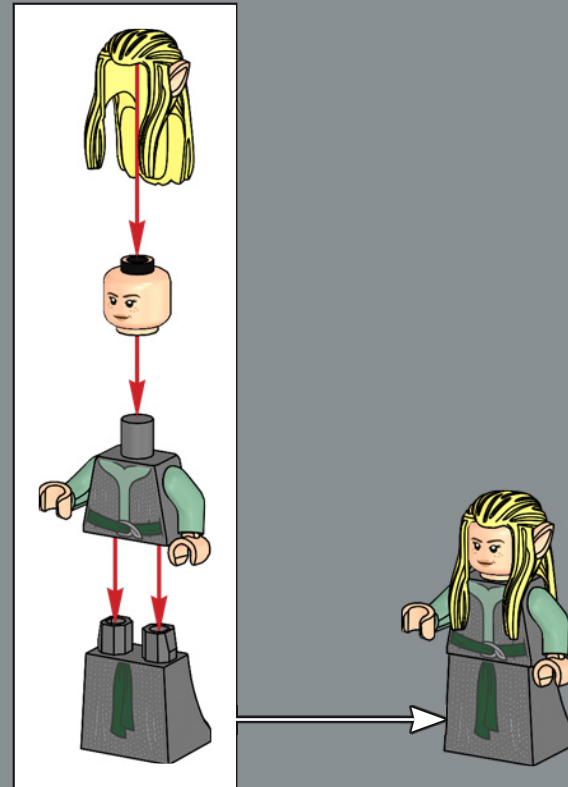

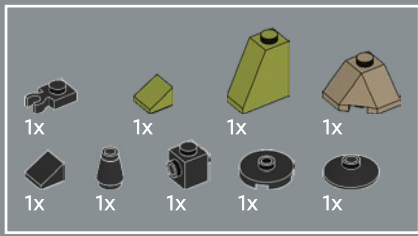

157

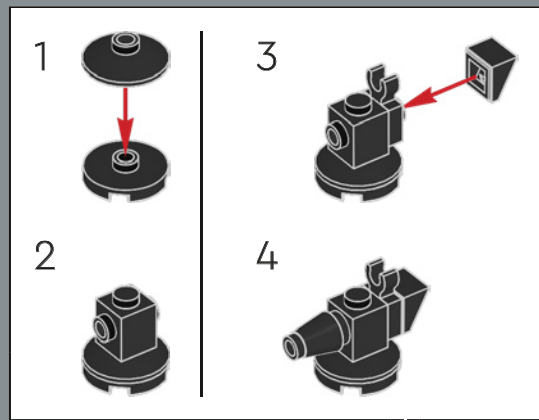

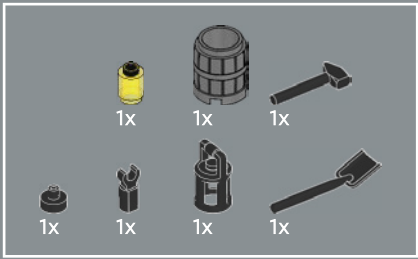

158

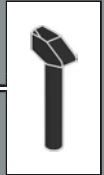
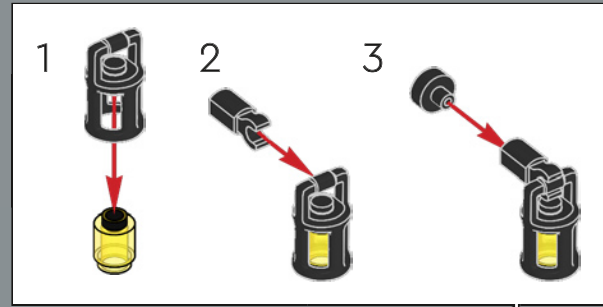

-  2x
-  2x
-  3x
-  2x
-  1x

159

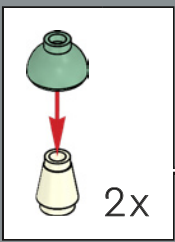
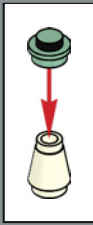
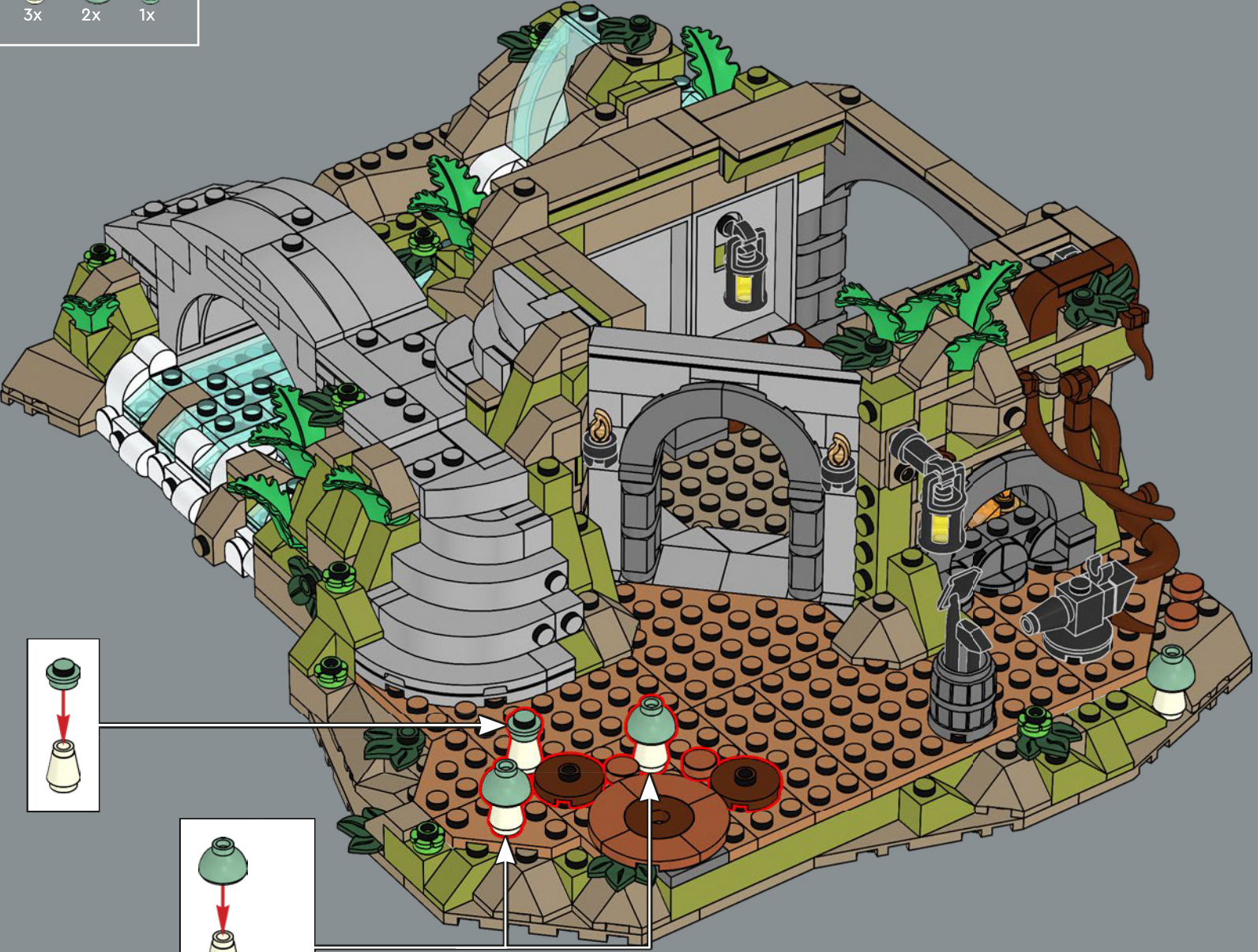

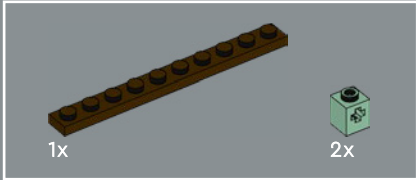
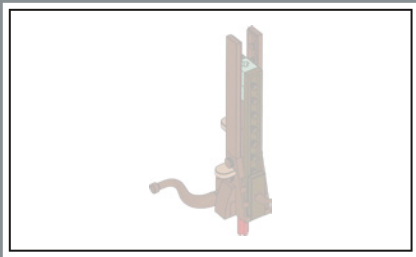

160

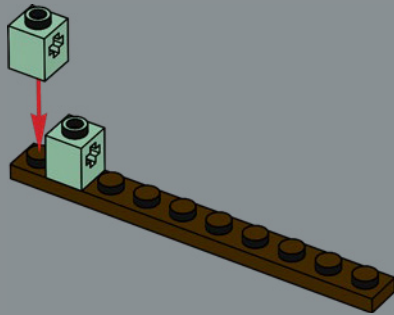

161

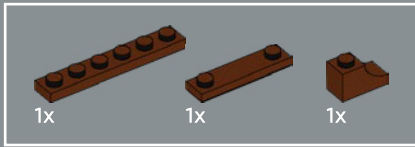
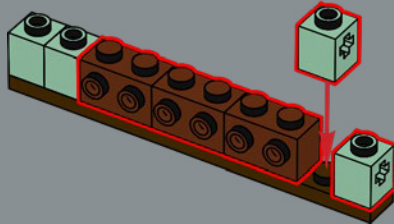

162

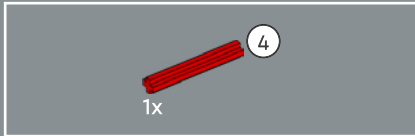
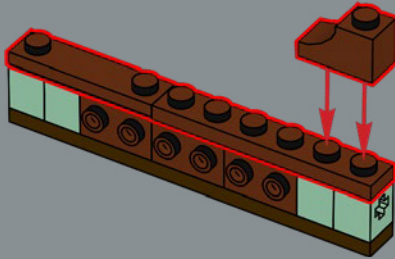

163

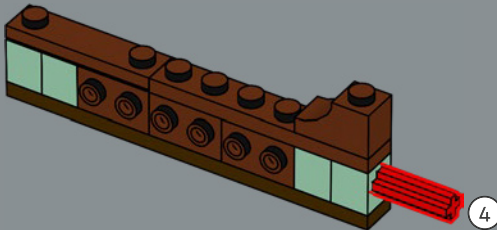

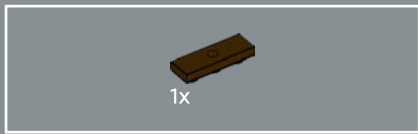

164

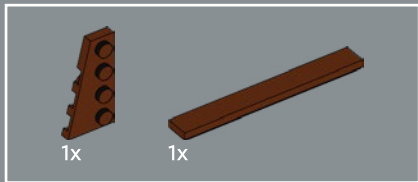
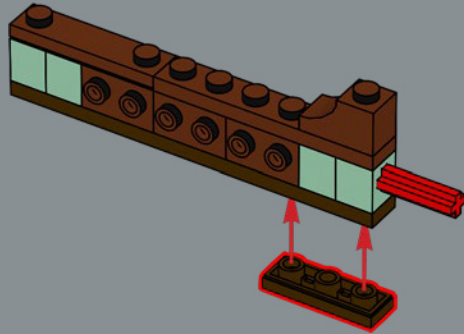

165

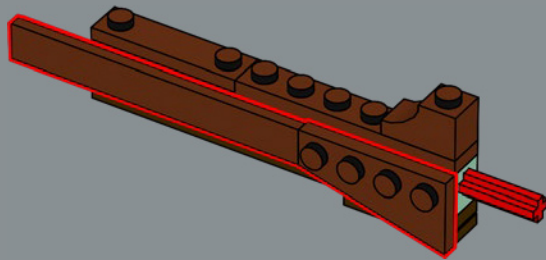

166

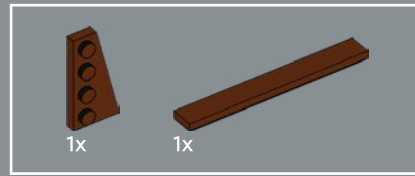
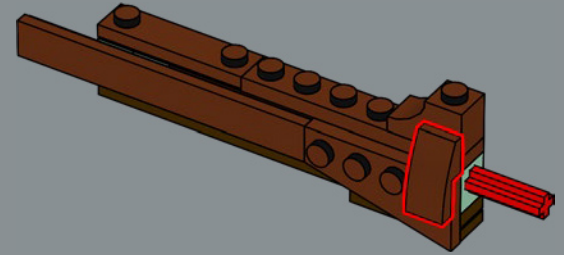

167

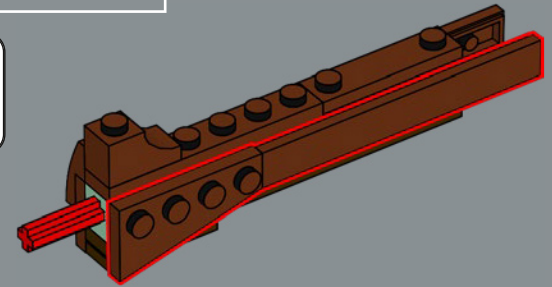



168

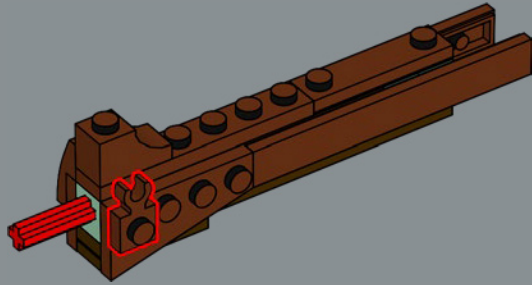

169

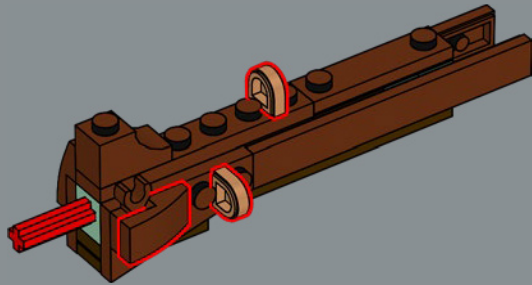

170

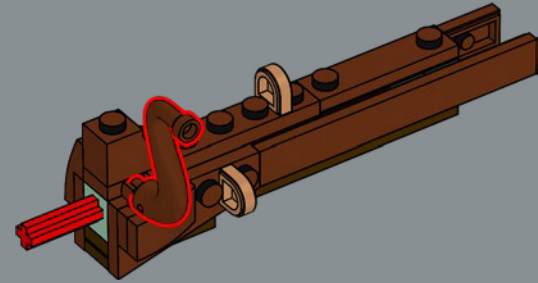

171

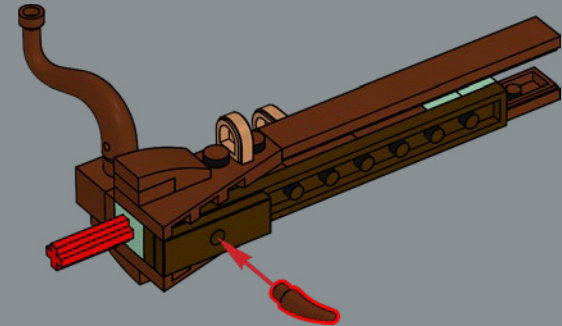



此模型包含三种不同的真菌类植物模型, 其中一种仅由一块组件构成, 这是拼搭蘑菇的捷径!

172





173

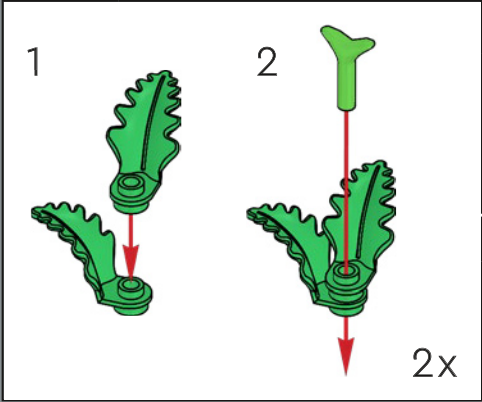
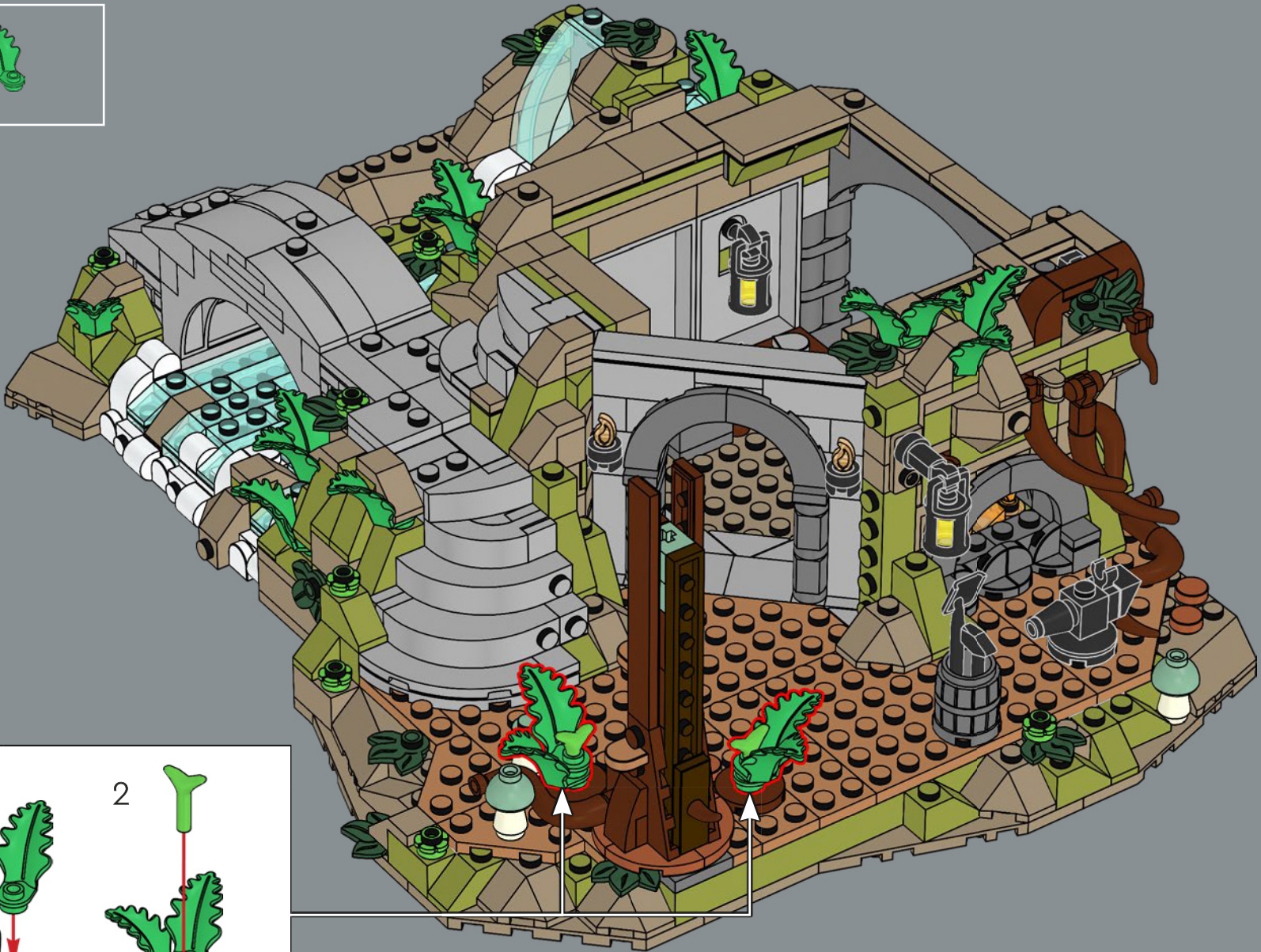

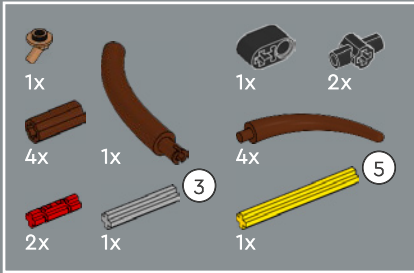
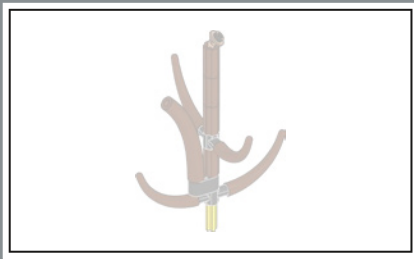

174

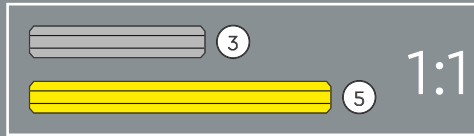

1



2

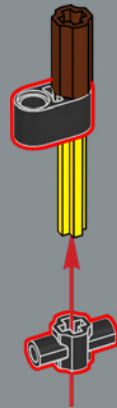

3

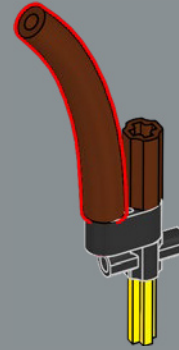

4

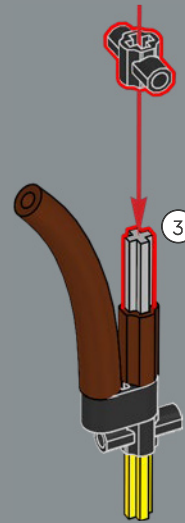

5

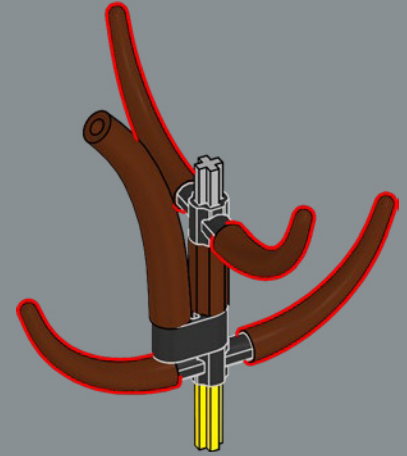

6

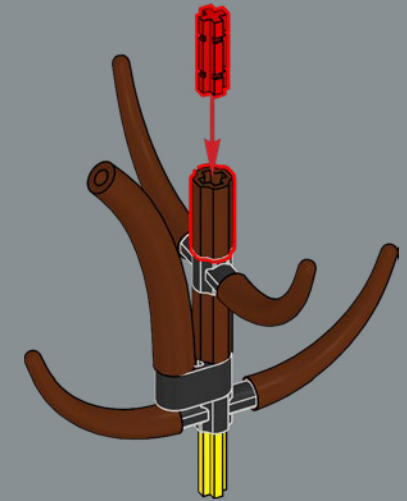

7

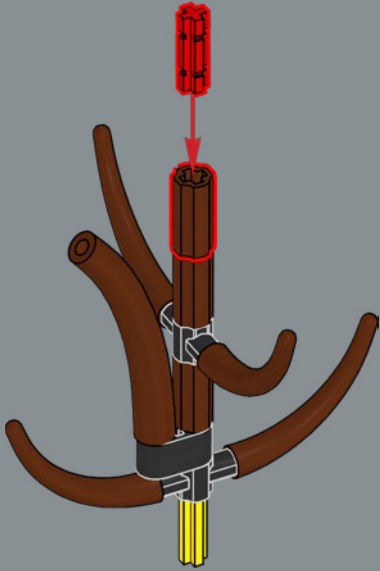

8

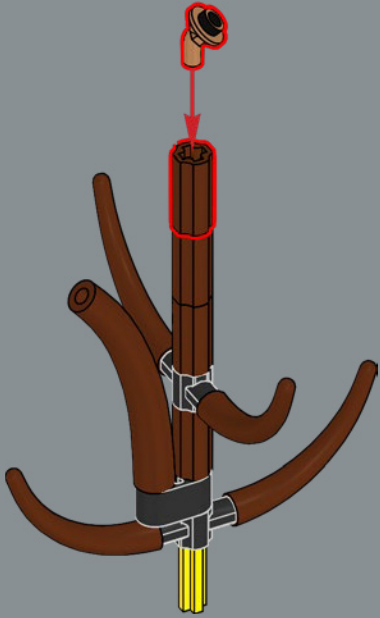



175

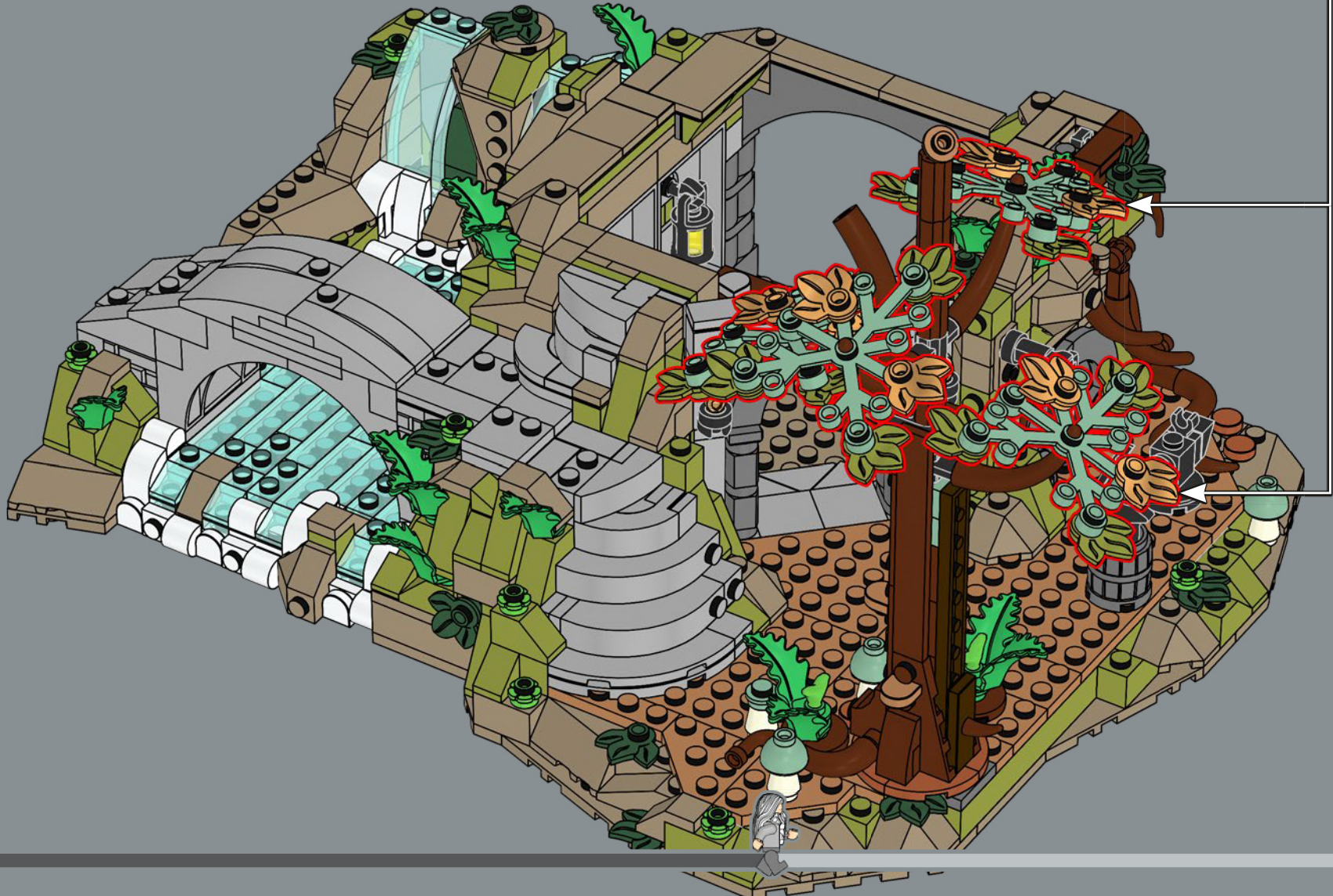
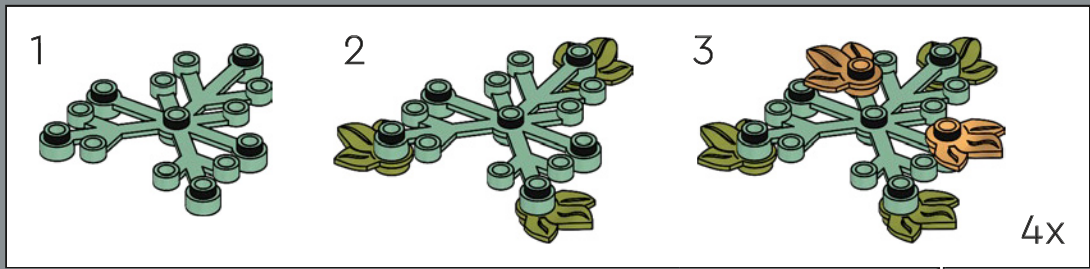

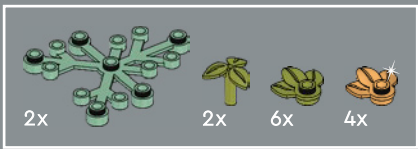

176

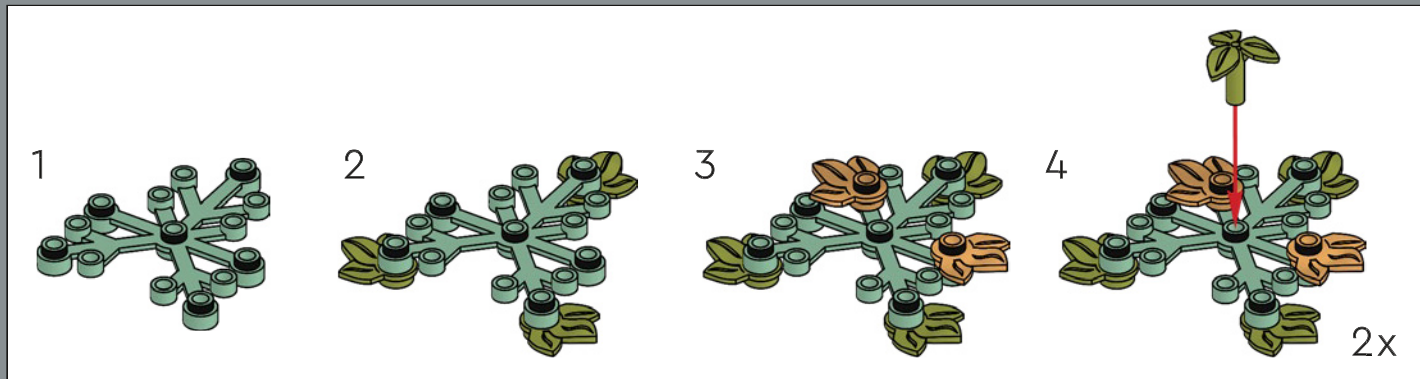

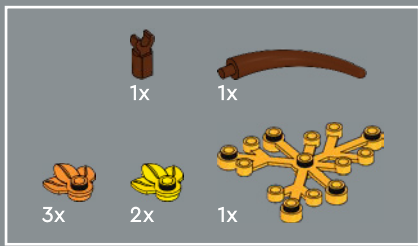

177

1

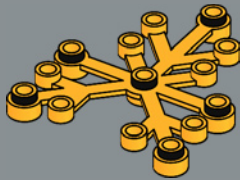

2

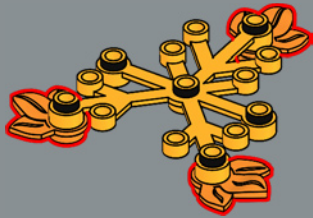

3

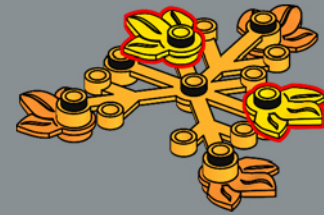

4

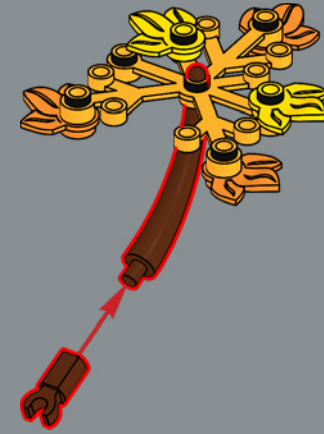

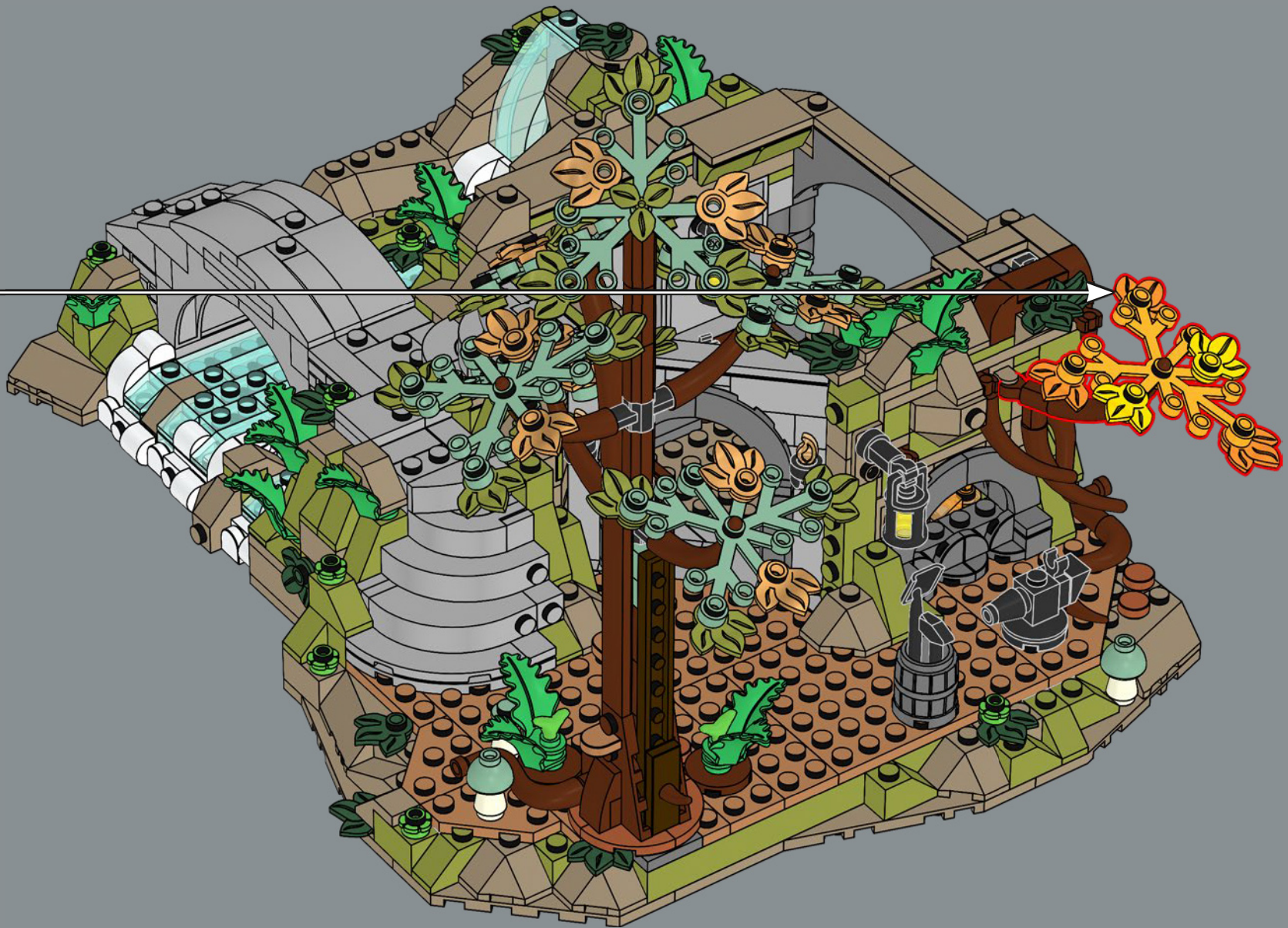

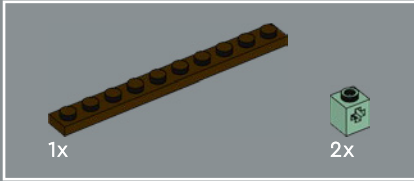
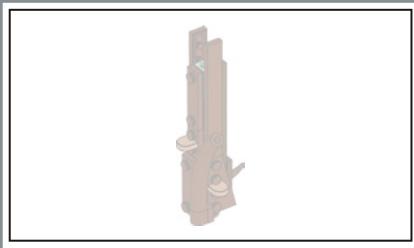

178

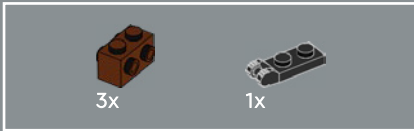
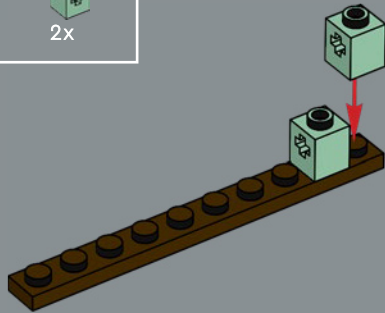

179

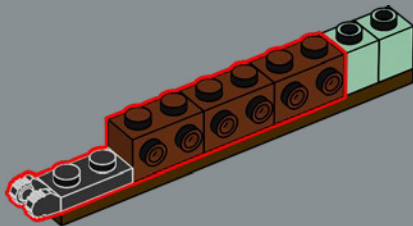

180

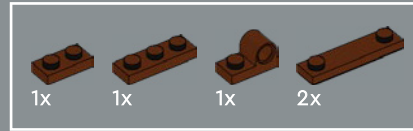
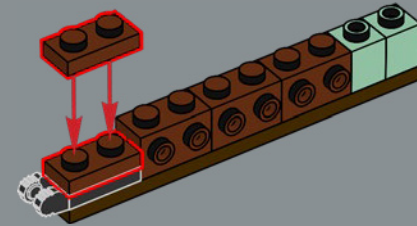

181

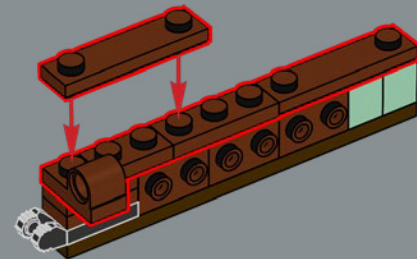

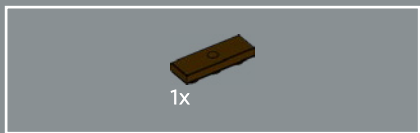

182

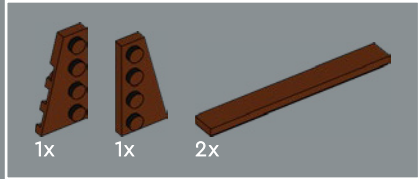
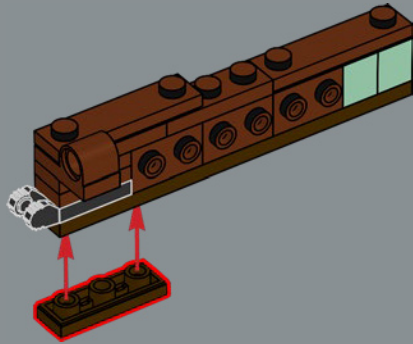

183

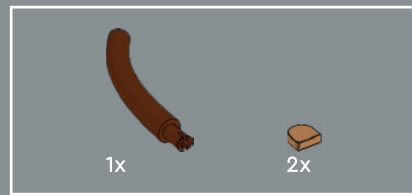
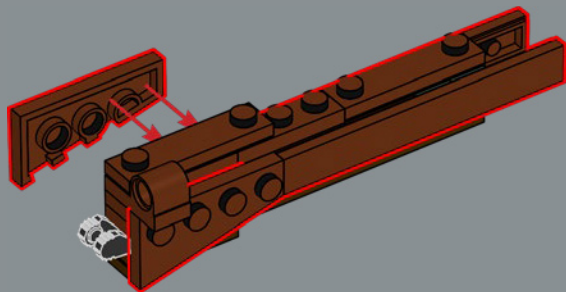

184

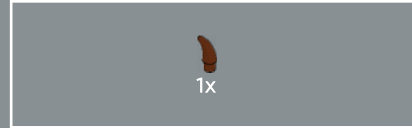
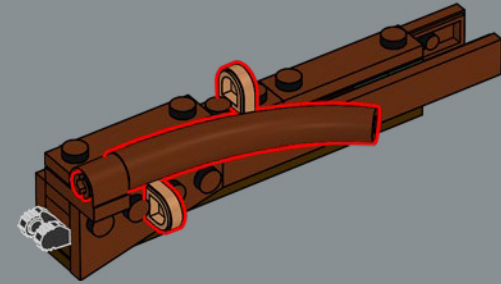

185

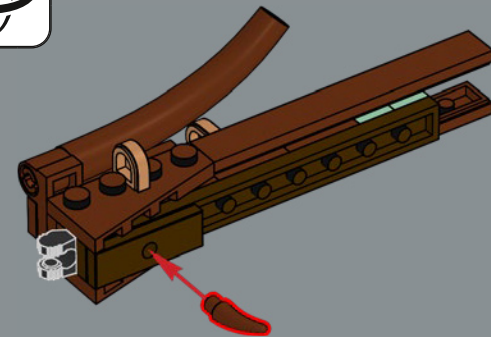

186



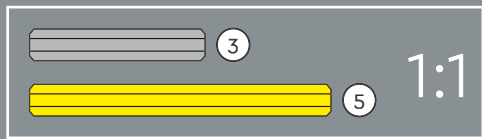
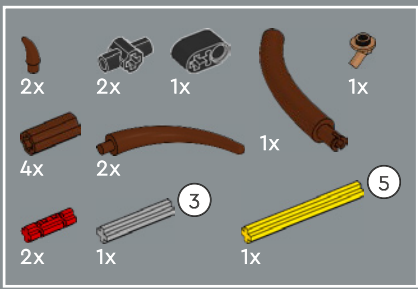

187

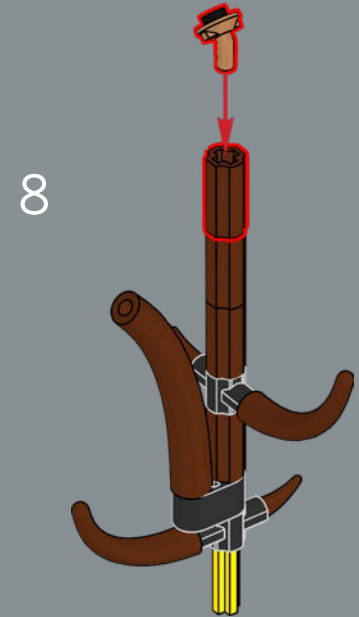
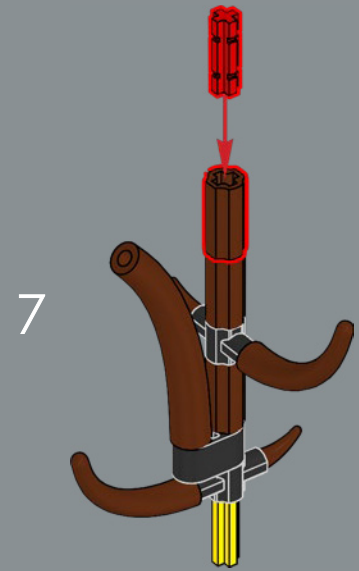
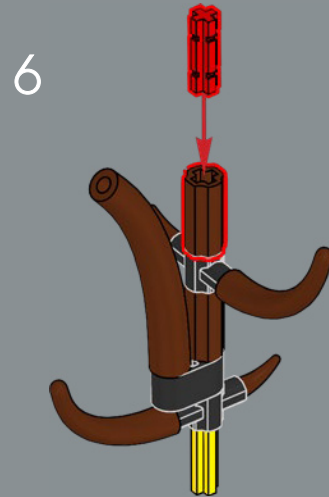
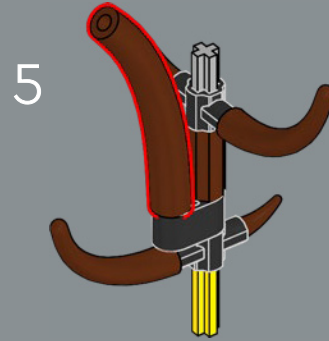
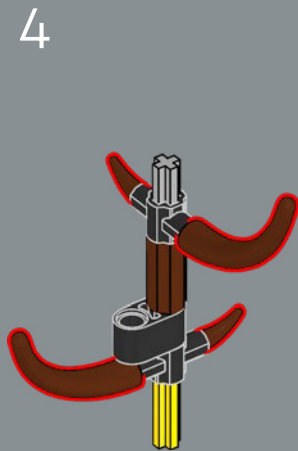
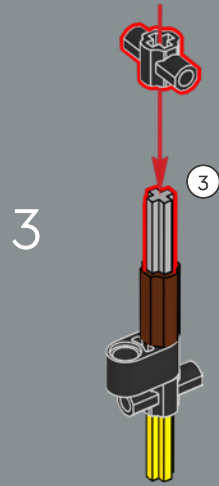
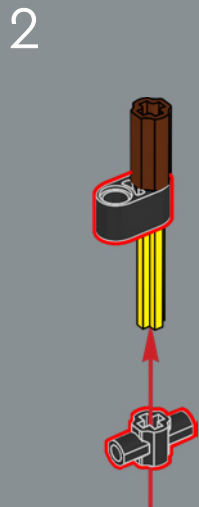
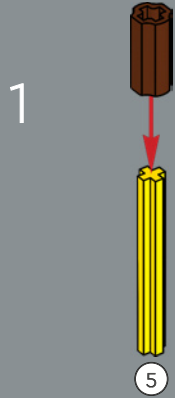





188

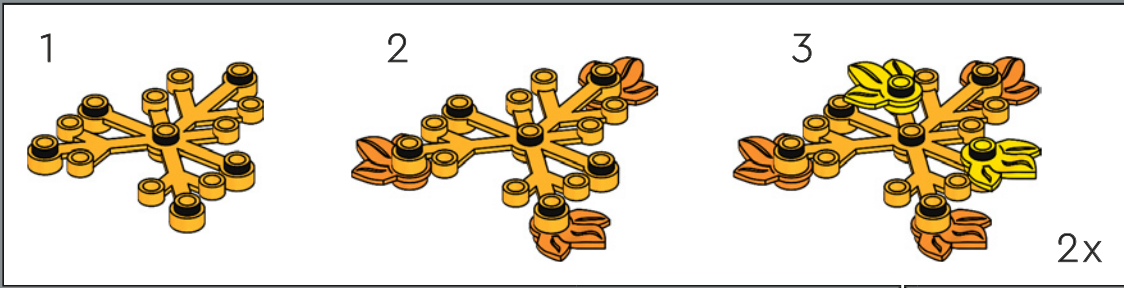



189

1

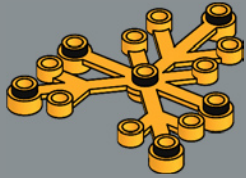

2

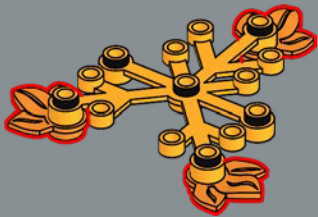

3

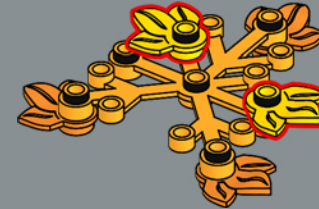

4

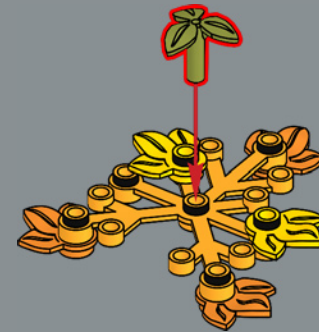

3x



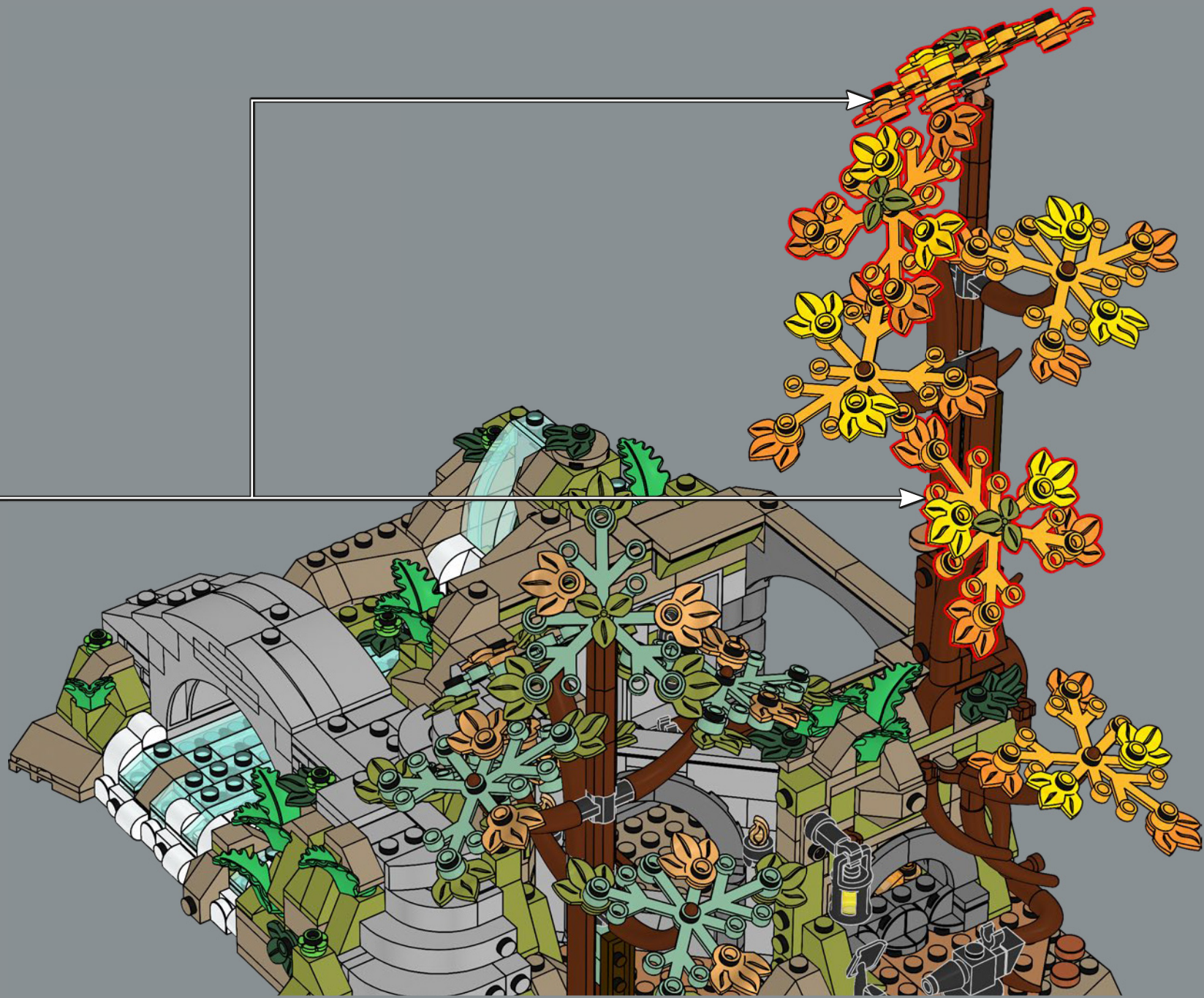

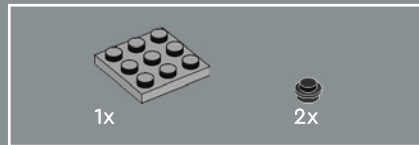
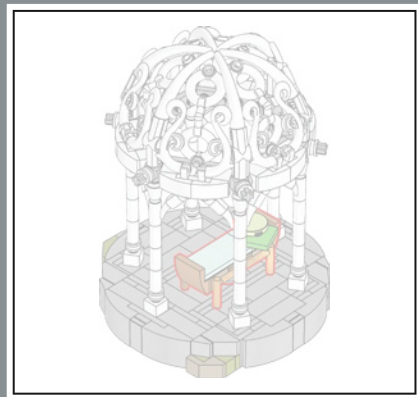

190

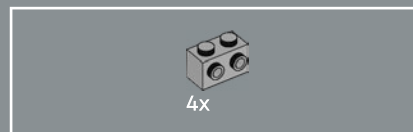
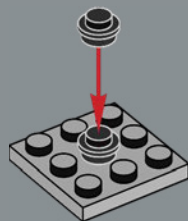

191

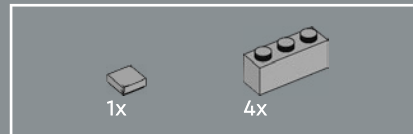
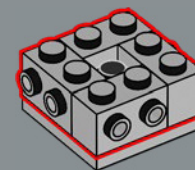

192

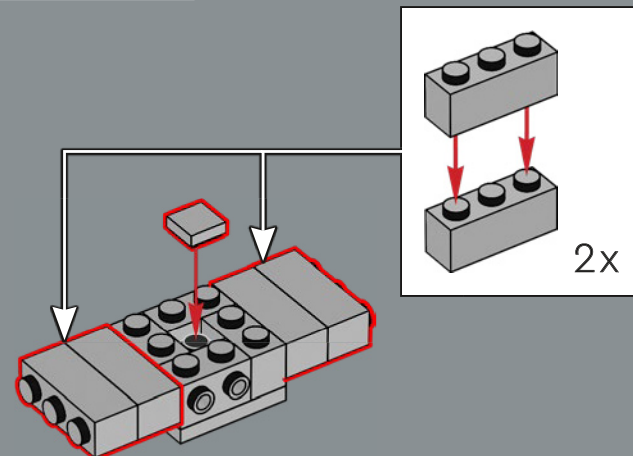

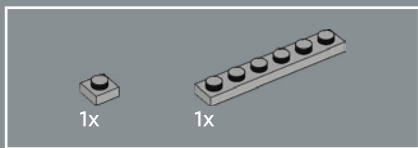
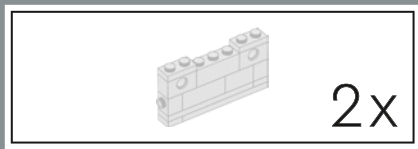

193

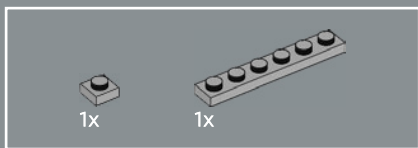
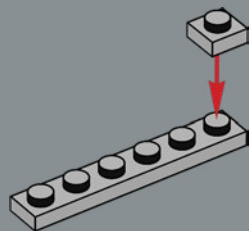

194

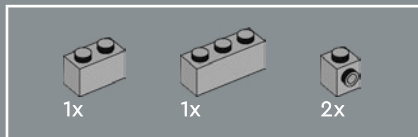
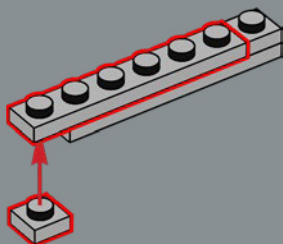

195

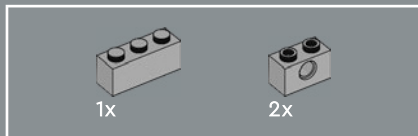
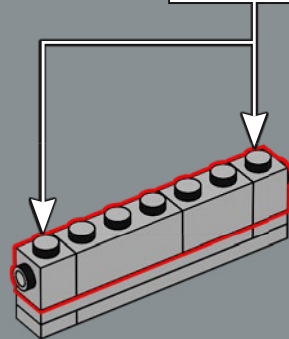

196

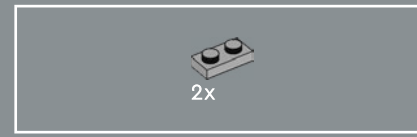
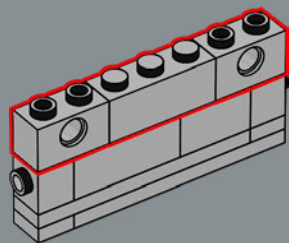

197

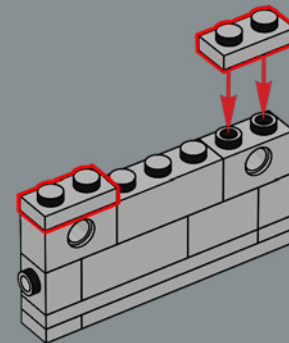

2x

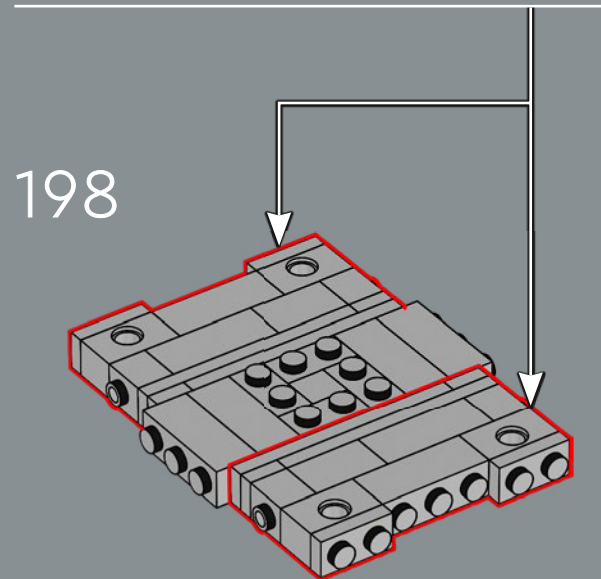

198

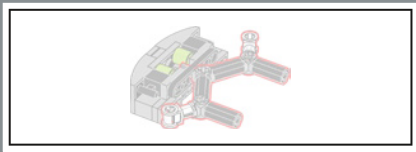

199

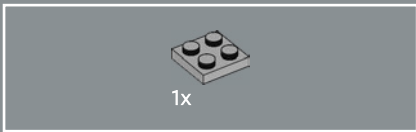
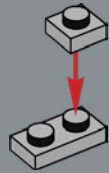

200

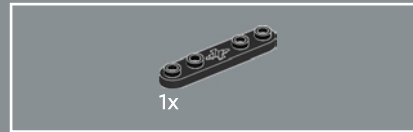
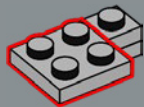

201

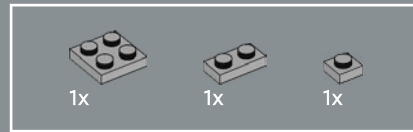
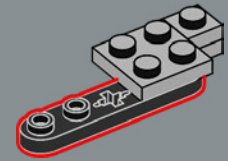

202

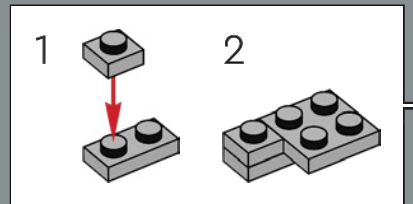

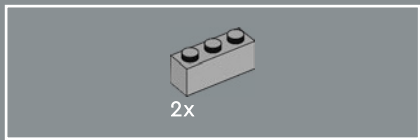

203

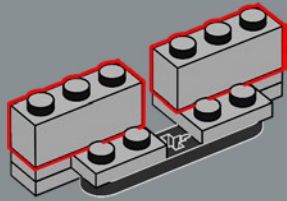

204

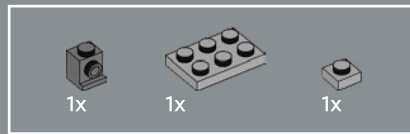
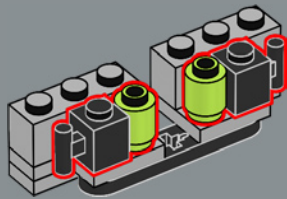

205

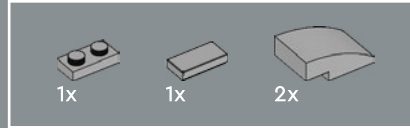
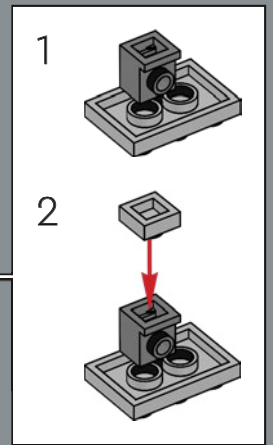
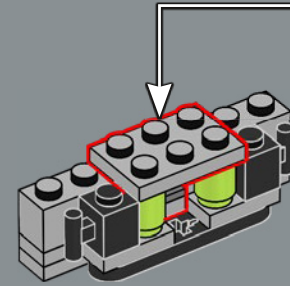

206

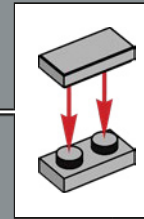
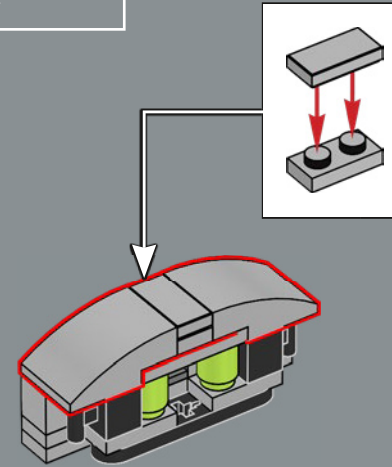



观景亭的底座是我们在开发此模型过程中遇到的最具挑战性的几何难题之一。

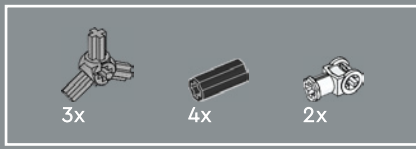

207

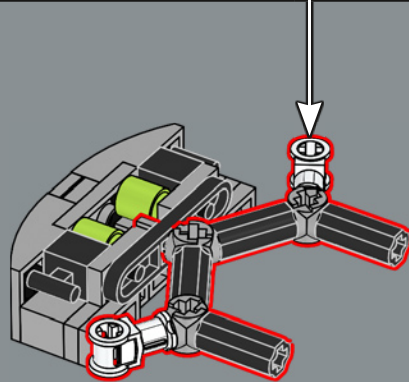
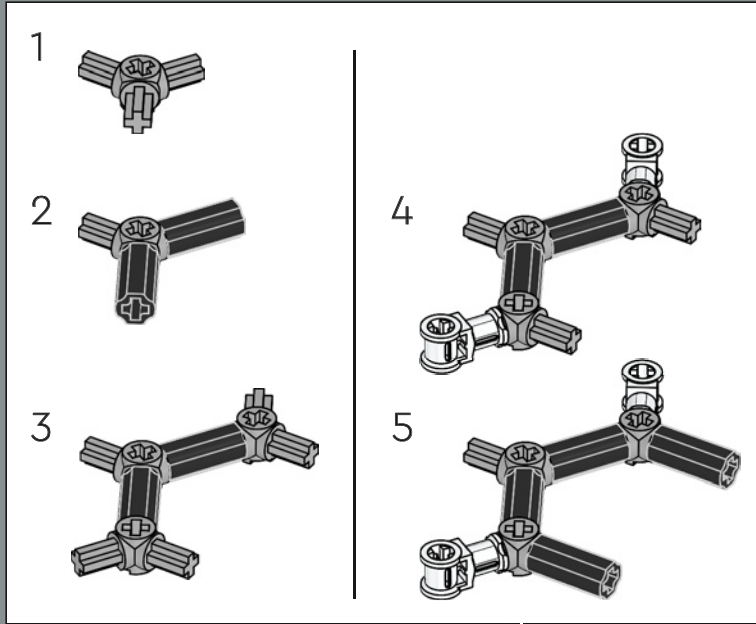

208

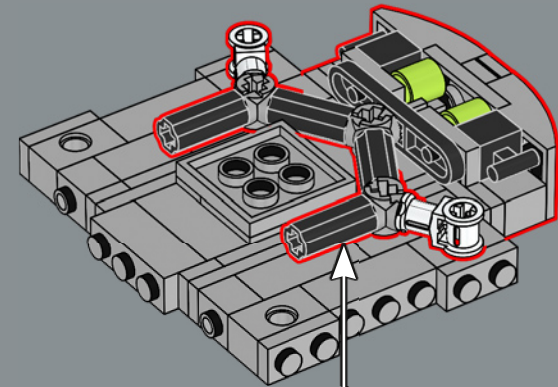

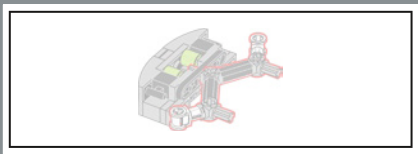

209

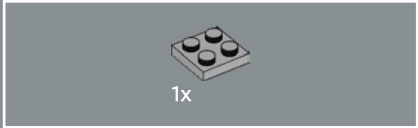
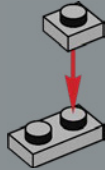

210

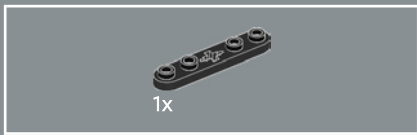
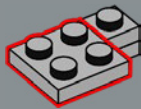

211

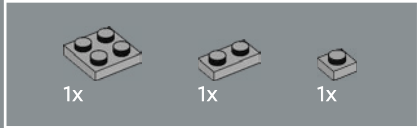
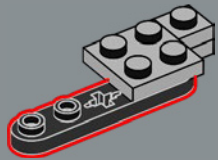

212

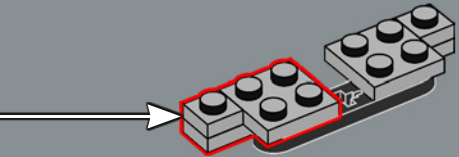
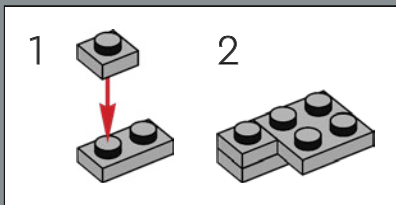

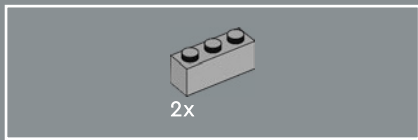

213

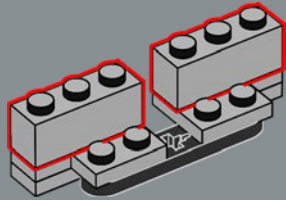

214

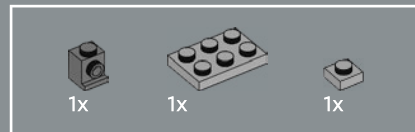
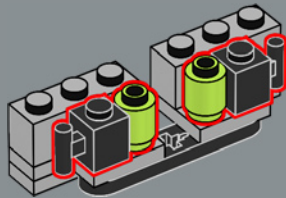

215

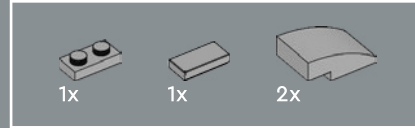
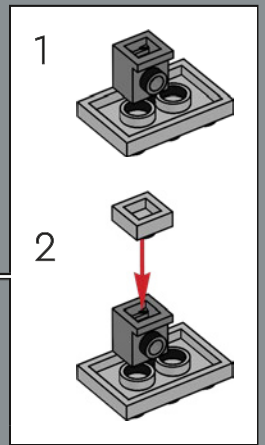
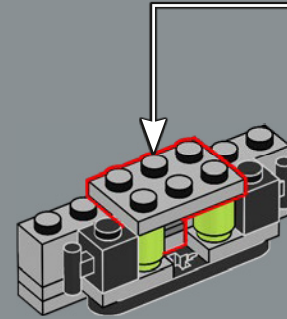

216

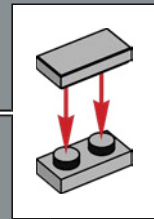
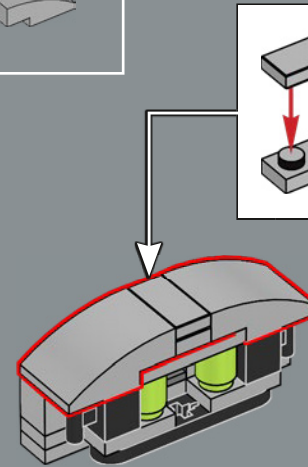



217

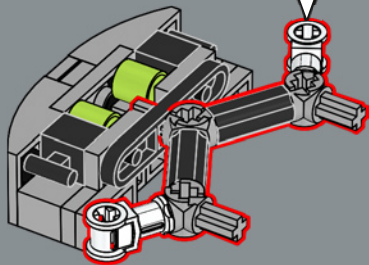
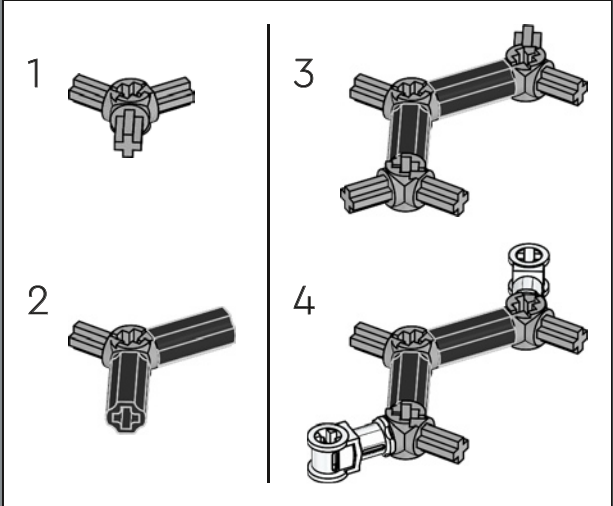

218

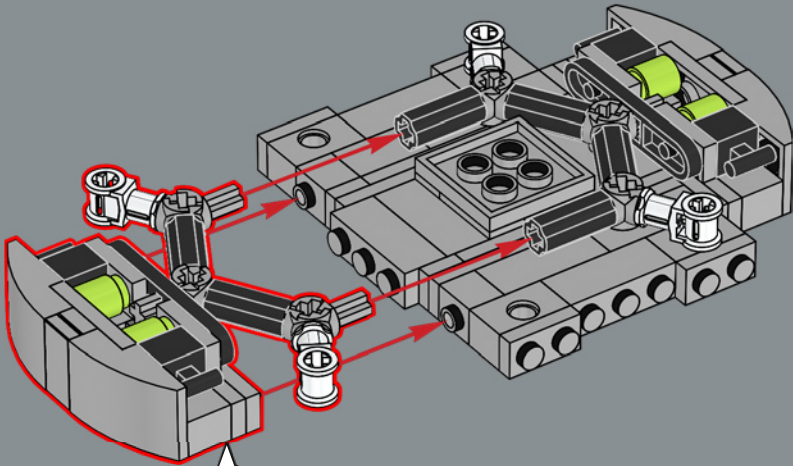

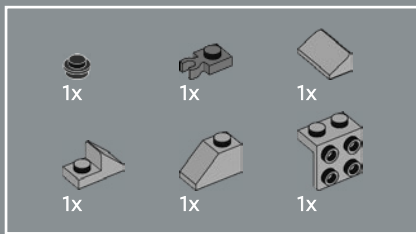

219

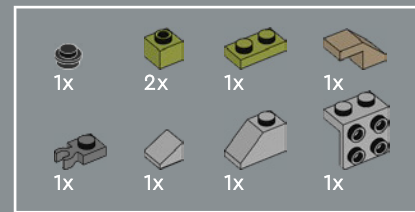
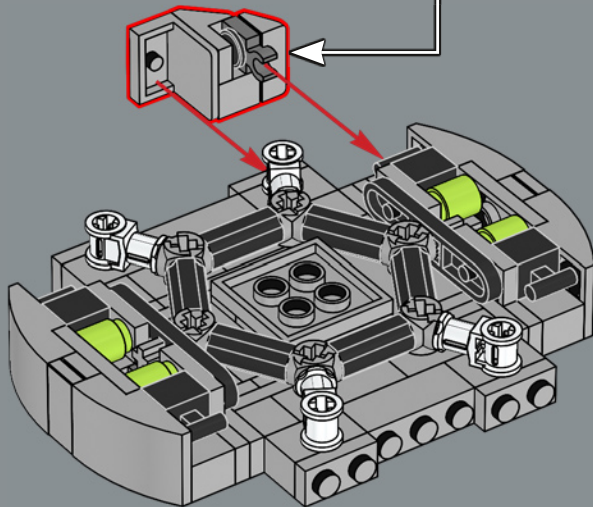
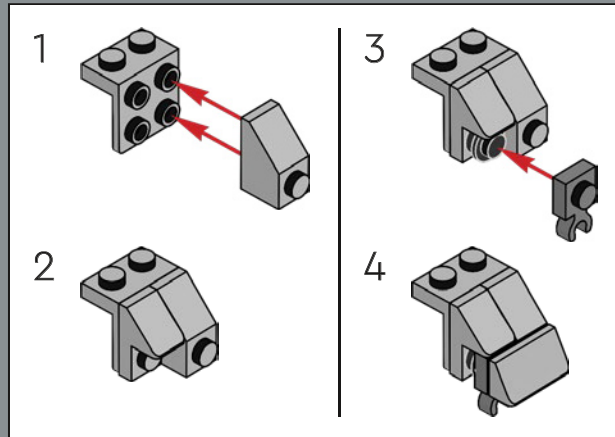

220

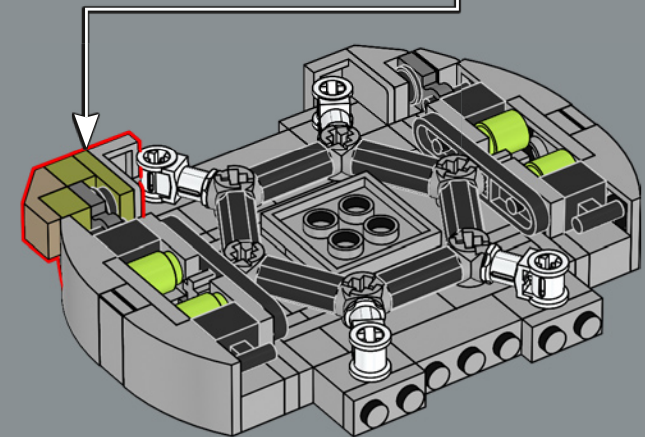
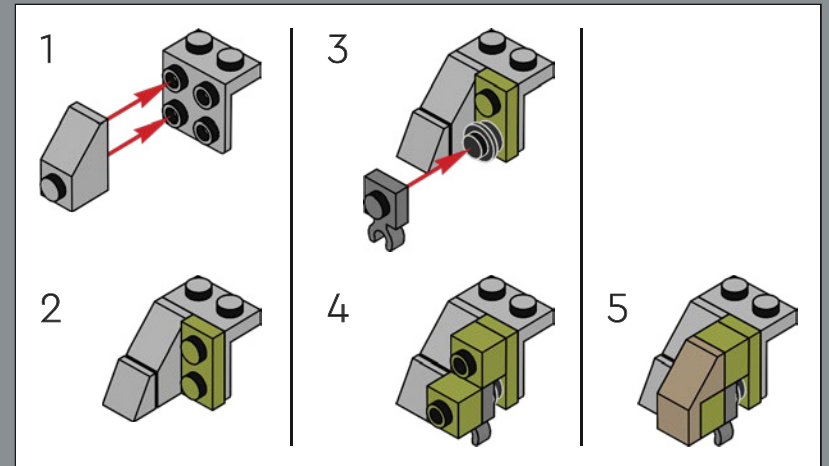



221

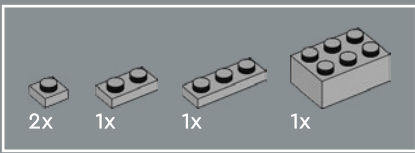
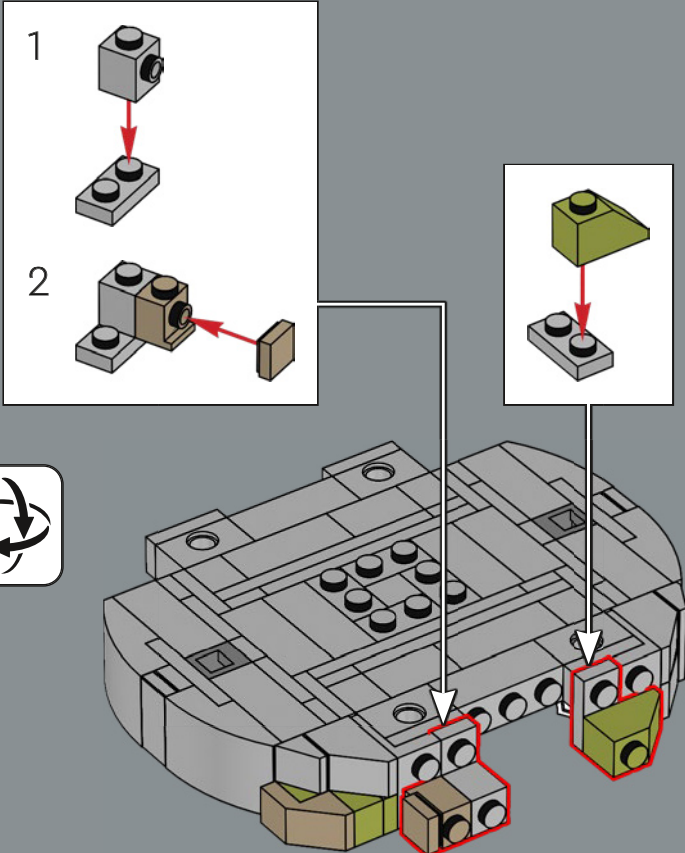

222

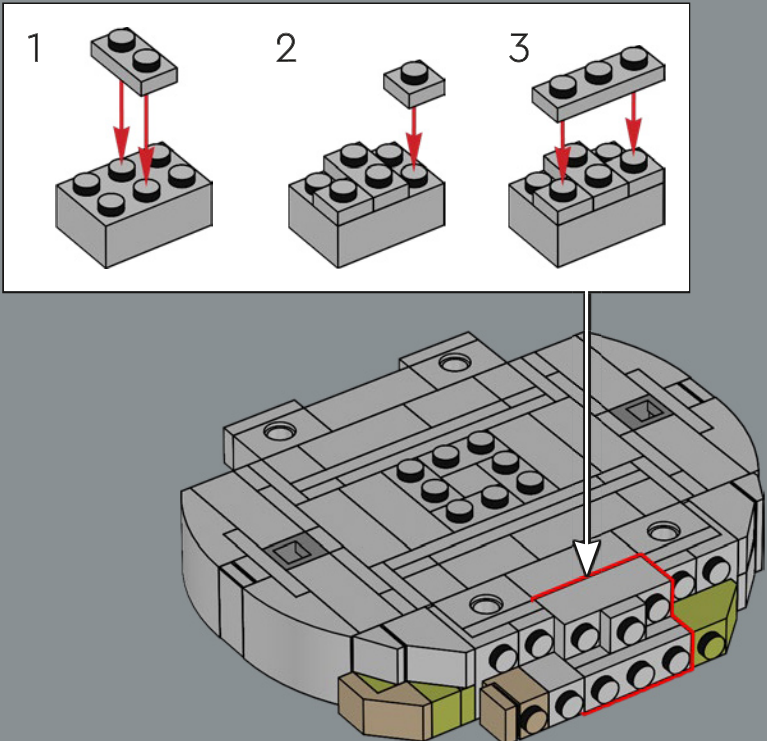

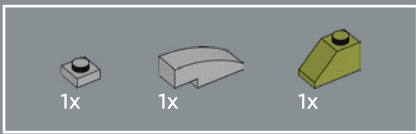

223

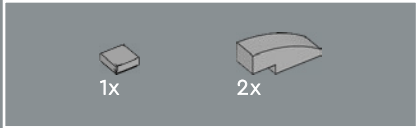
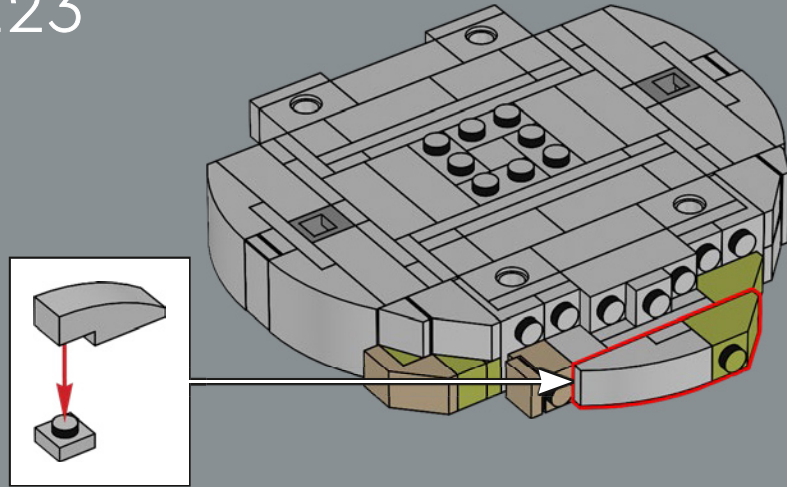

224

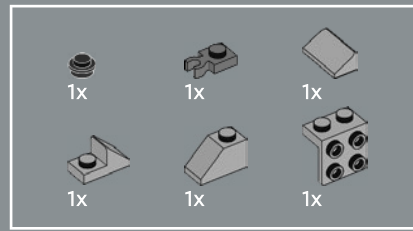
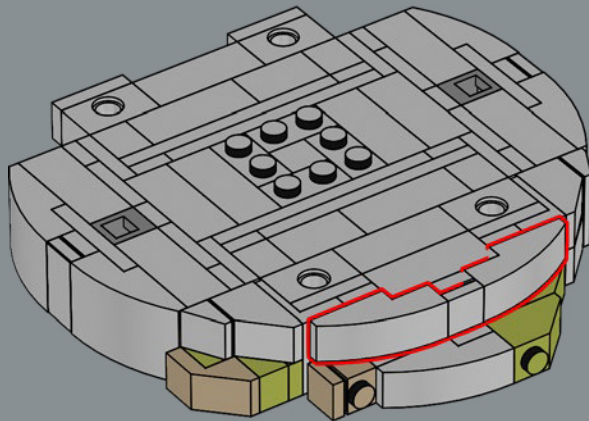

225

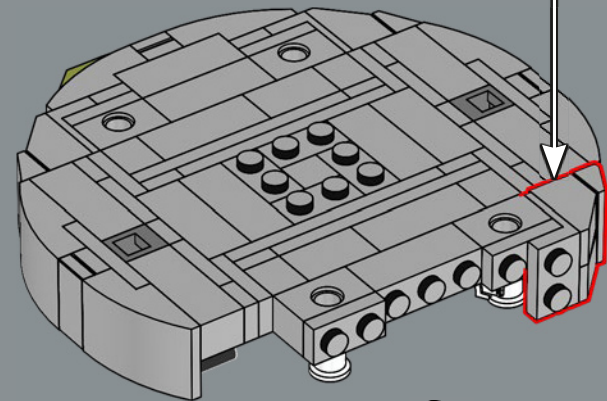
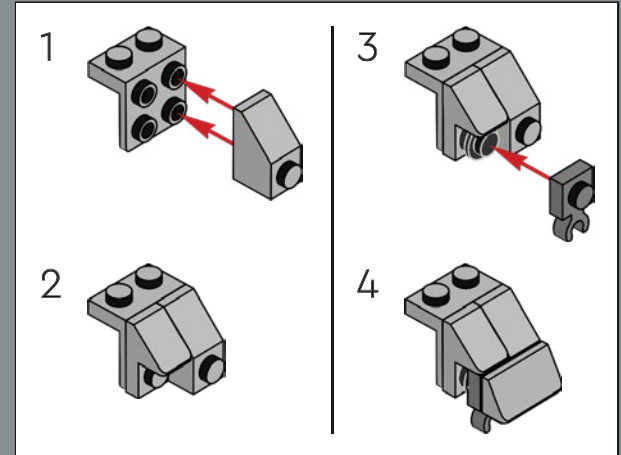

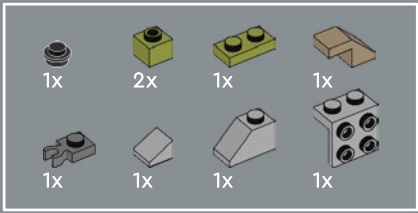

226

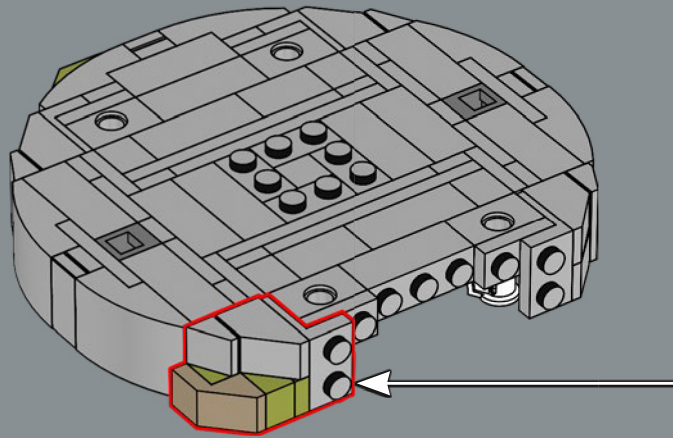
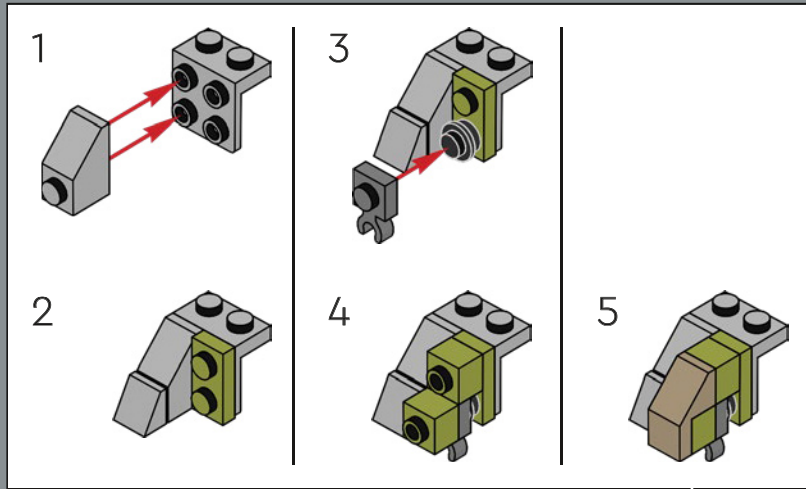

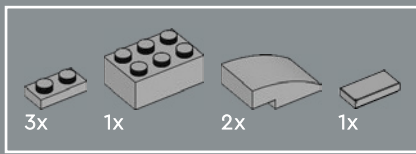

227

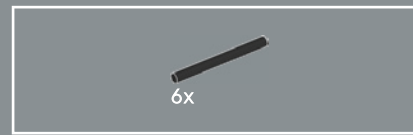
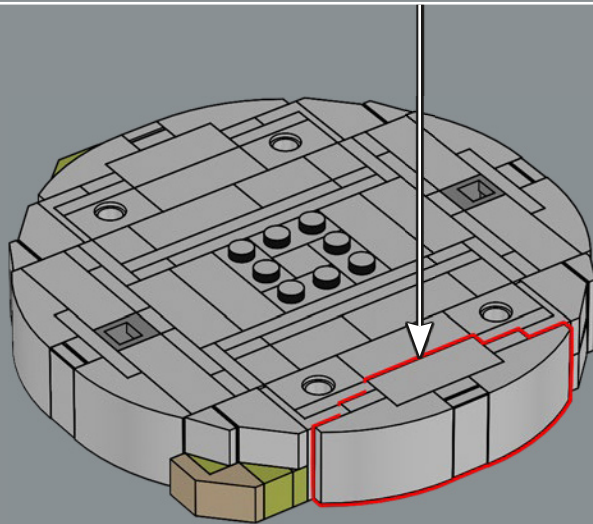
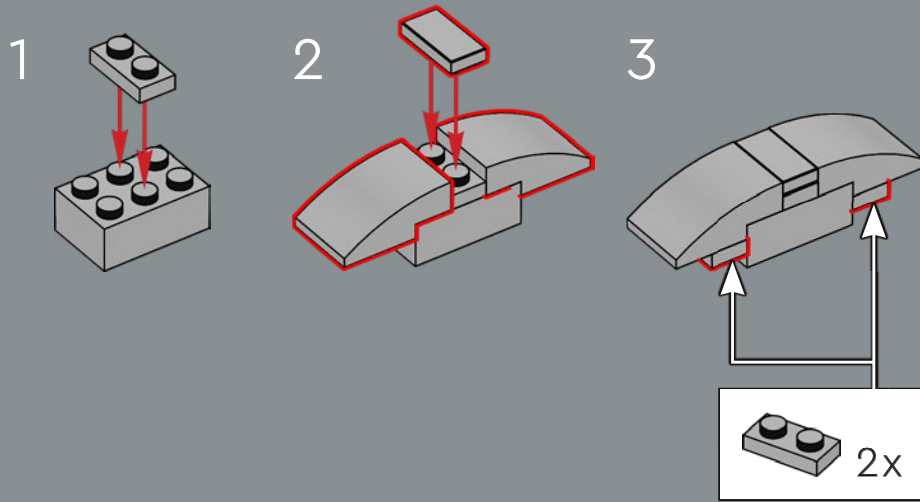

228

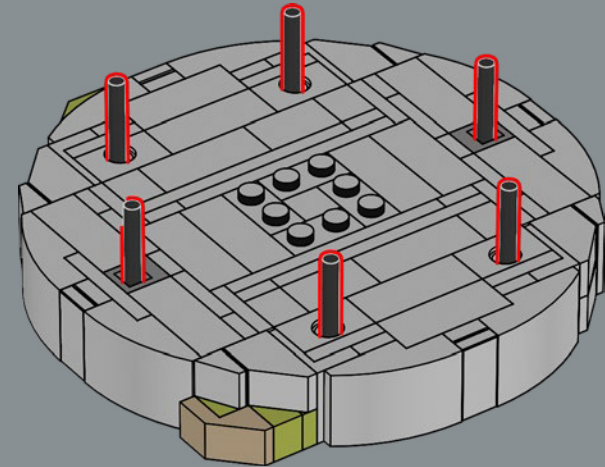



6x

229

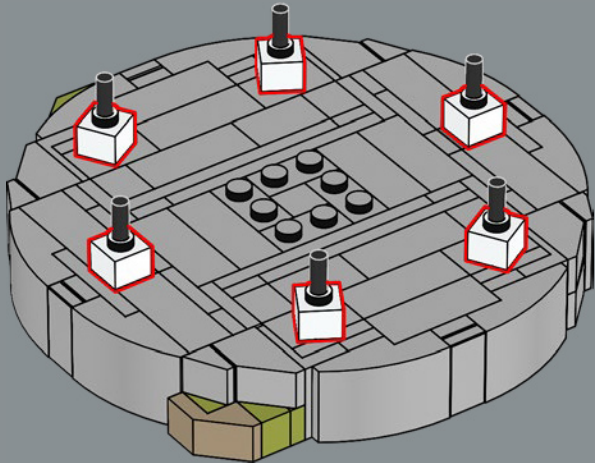

6x

230

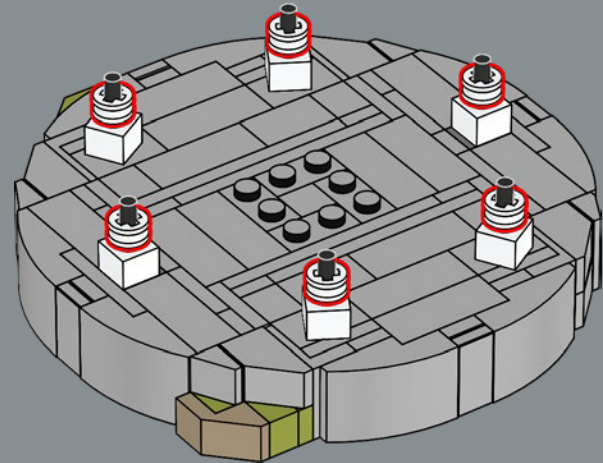

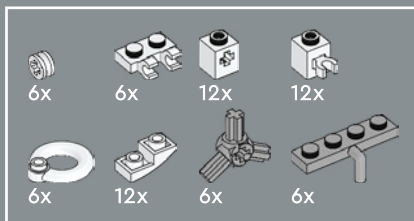
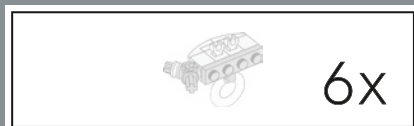
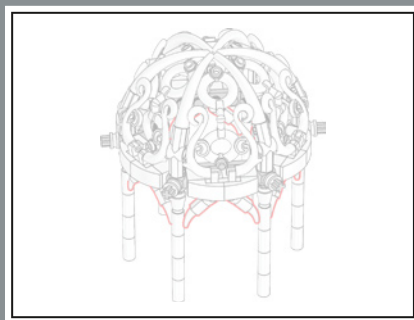

231

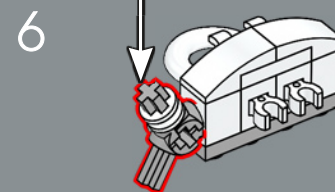
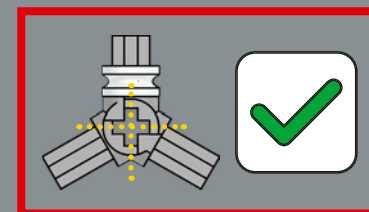
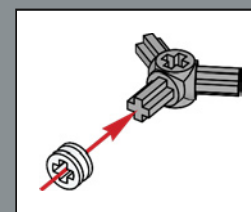
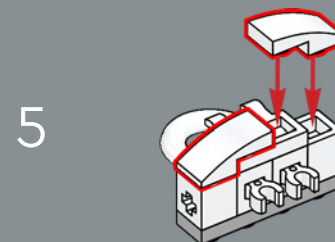
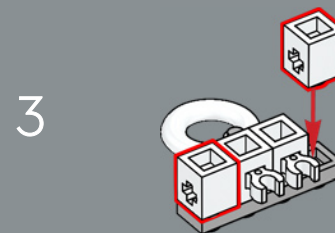
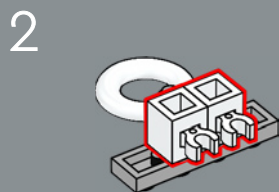
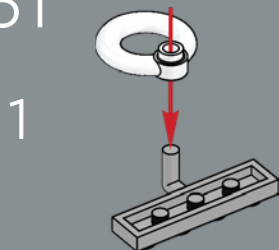

6x



用于观景亭顶部细节的圆环最初被设计为 1999 年的小人仔救生圈。



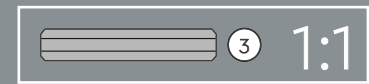
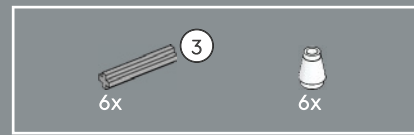
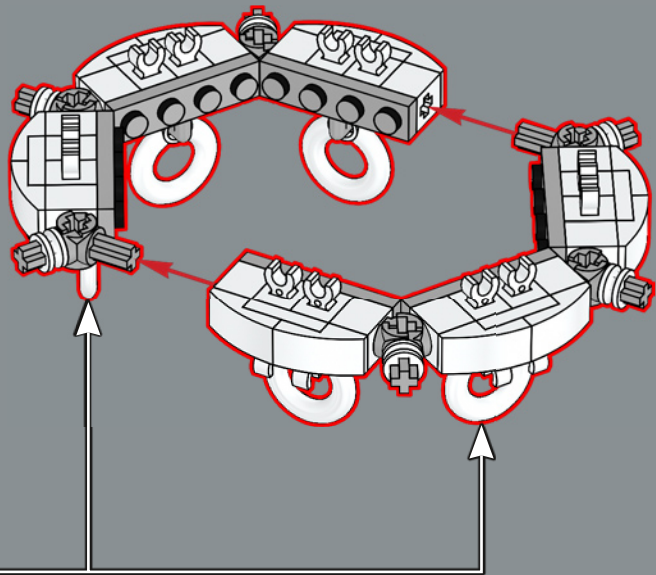

232

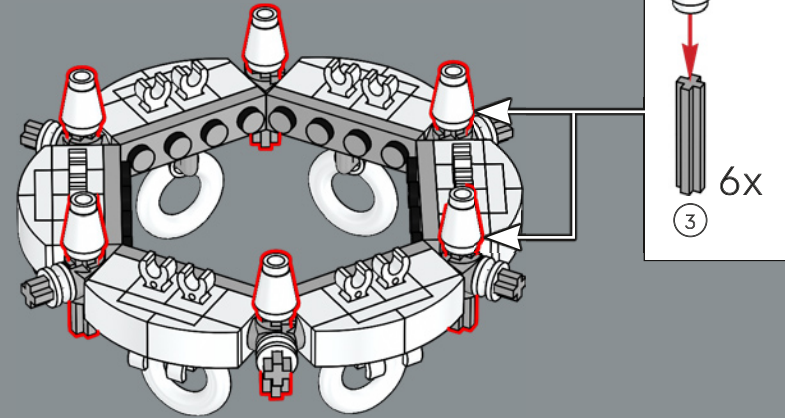

233

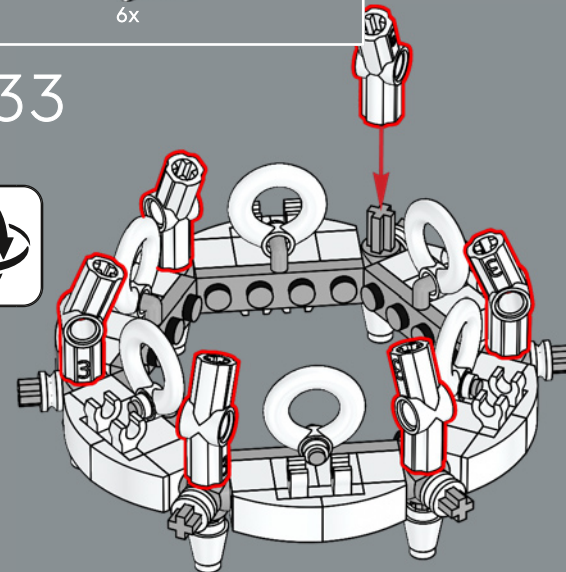

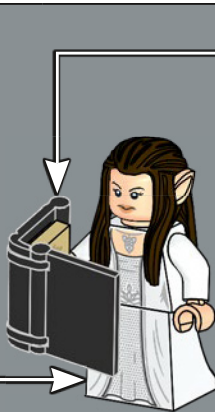
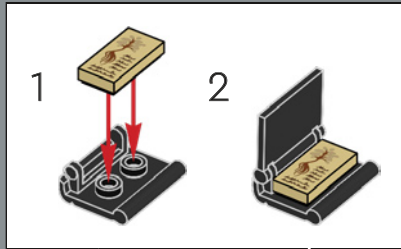
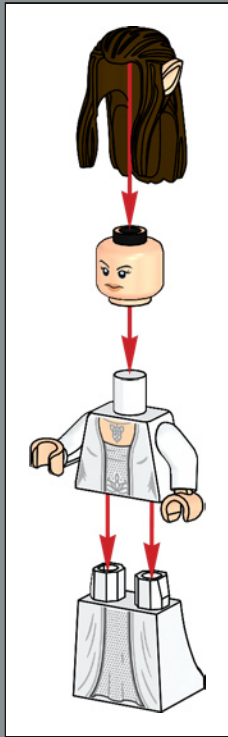

234

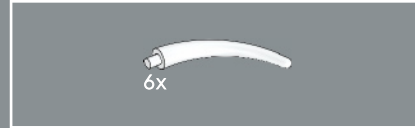
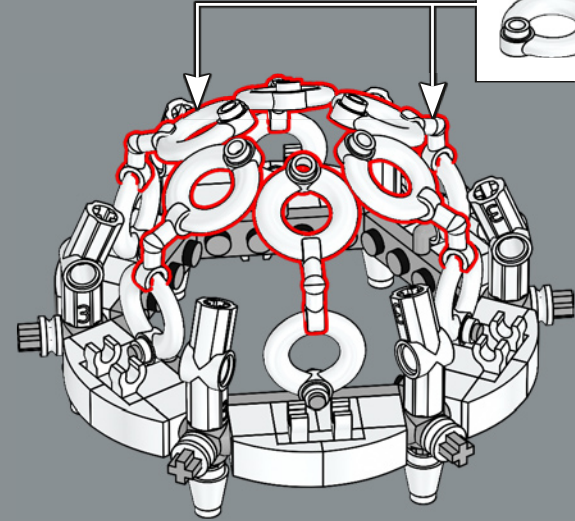
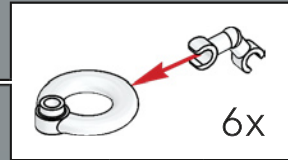

235

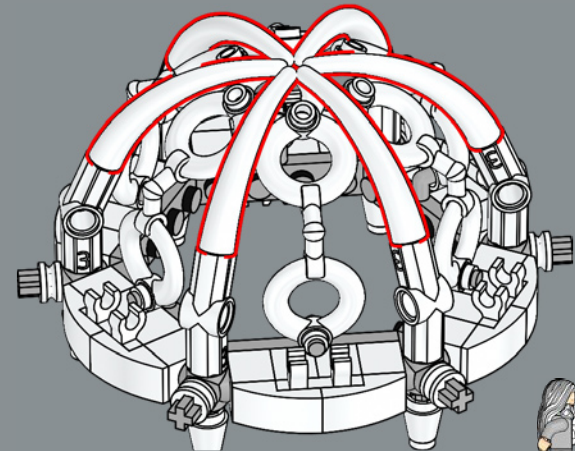



12x

236

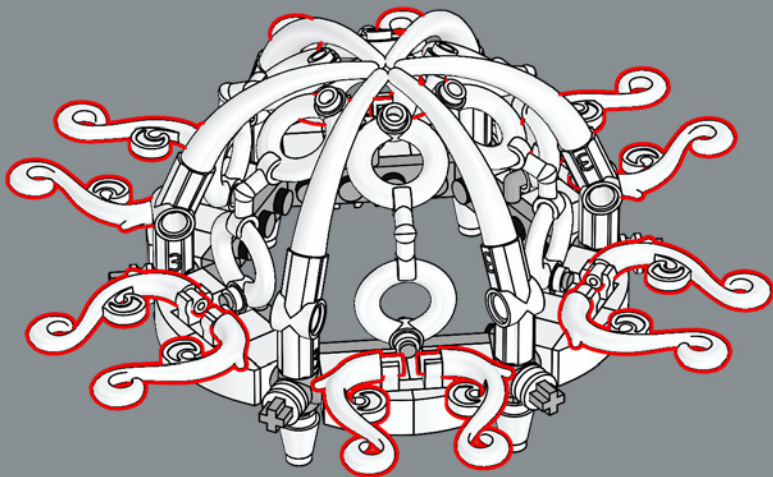

237

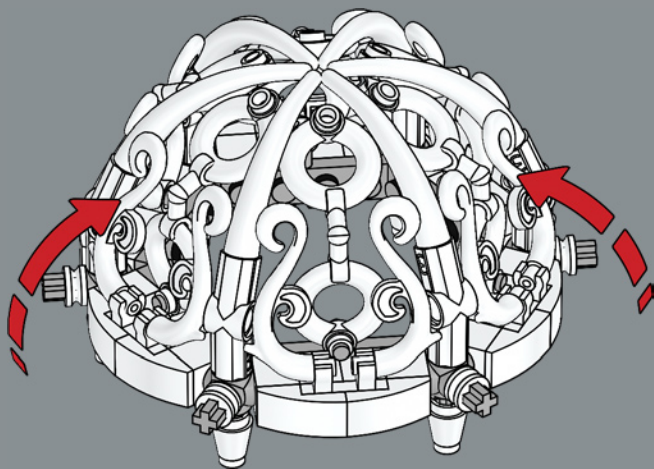

24x

238

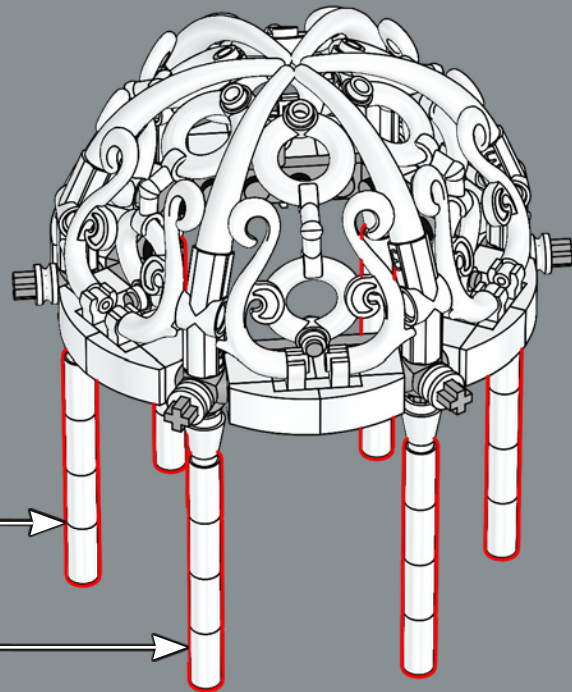

6x



这些白色组件最初专为蜡烛而开发，此模型使用了 91 块白色组件。不过，其中只有 4 块被用作蜡烛。



239

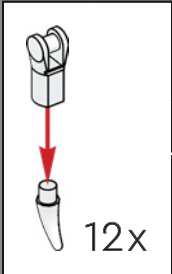
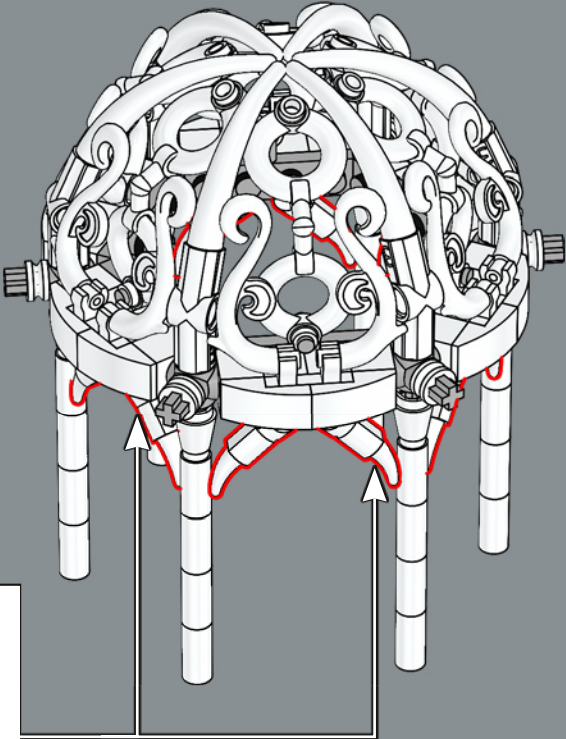

240

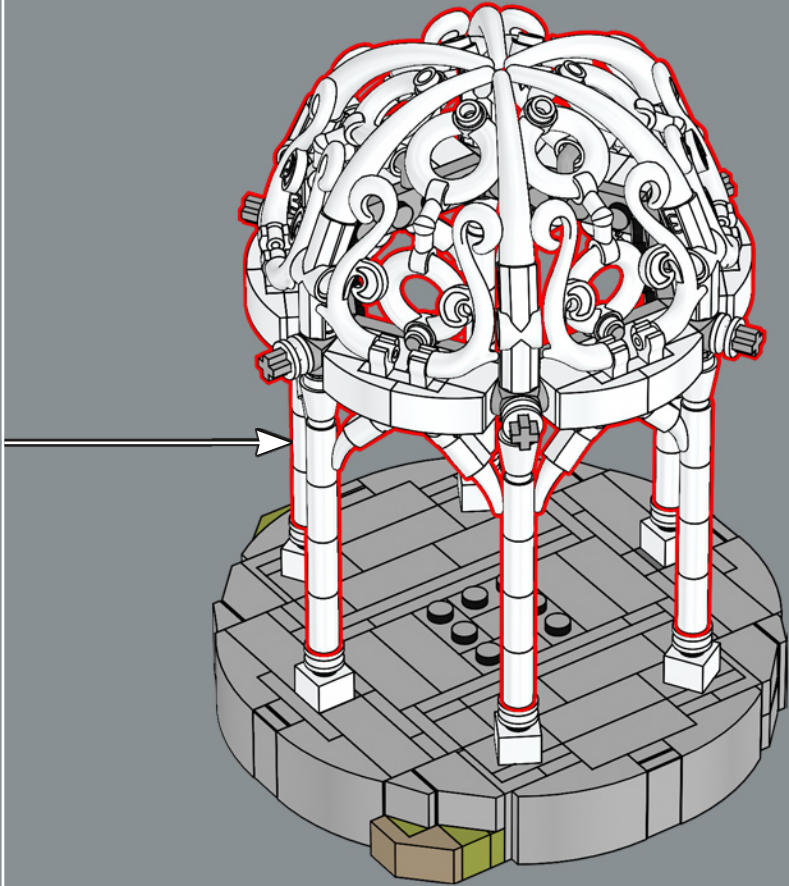

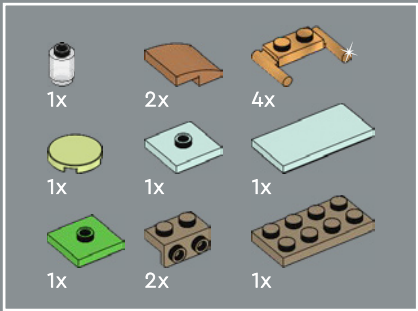

241

1



2

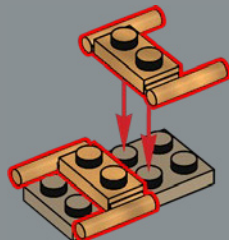

3

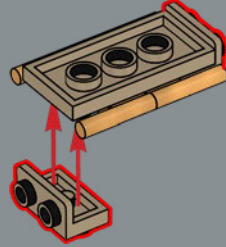

4

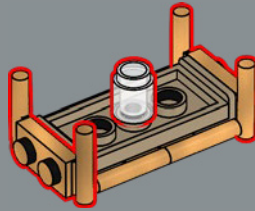

5

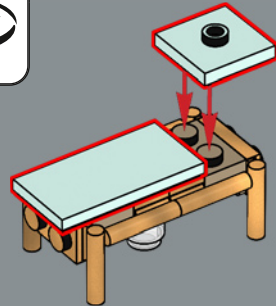

6

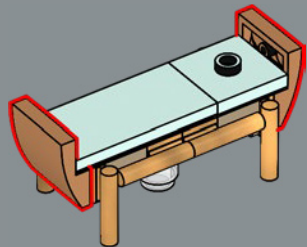

7

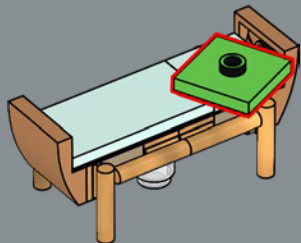

8

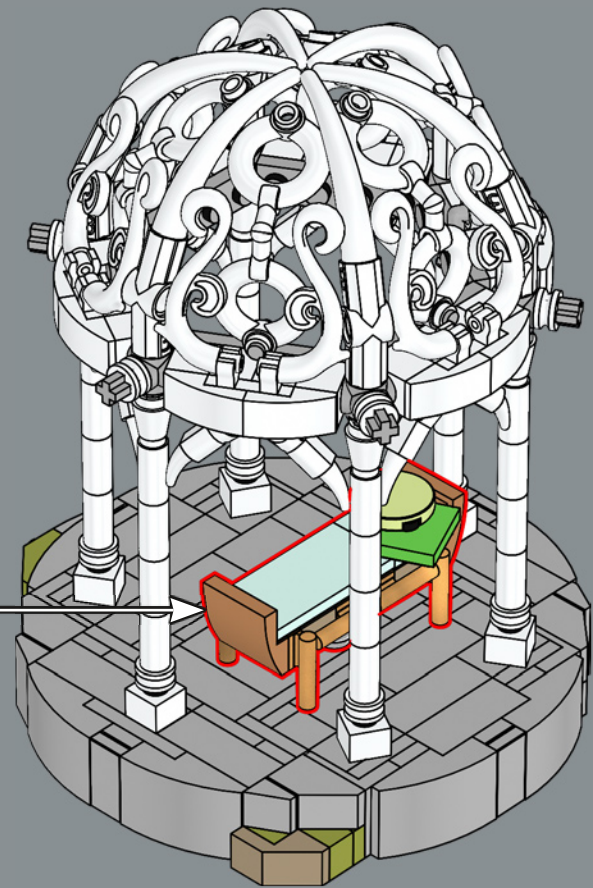
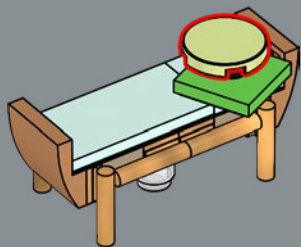

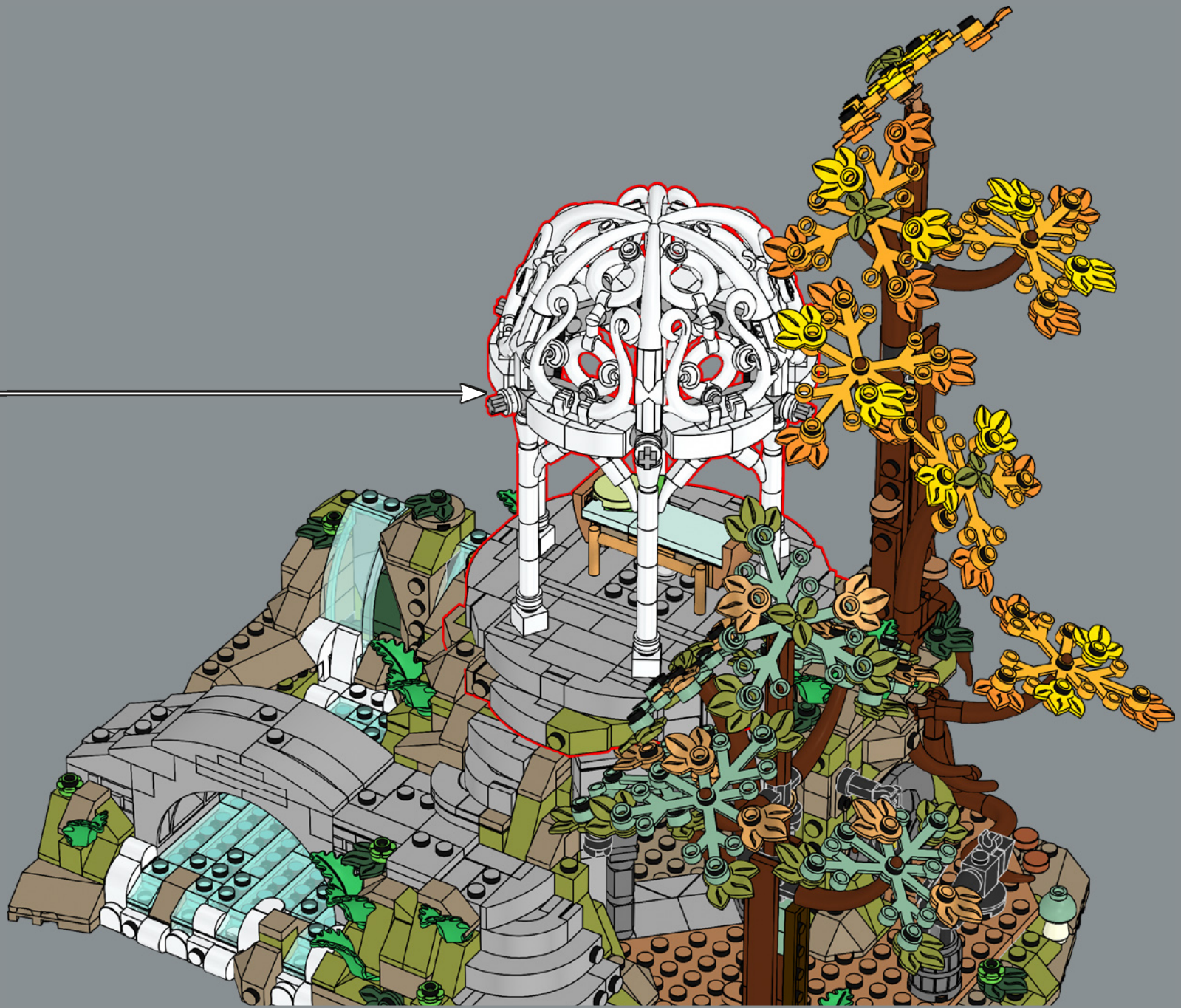

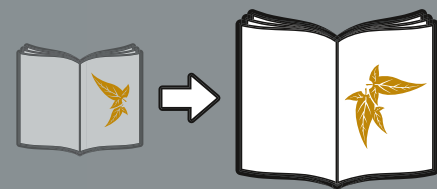



LEGO and the LEGO logo are trademarks of the LEGO Group. ©2023 The LEGO Group.

© 2023 New Line Productions, Inc. All rights reserved. The Lord of the Rings: The Fellowship of the Ring, The Lord of the Rings: The Two Towers, The Lord of the Rings: The Return of the King and the names of the characters, items, events and places therein are trademarks of The Saul Zaentz Company d/b/a Middle-earth Enterprises under license to New Line Productions, Inc. (s23)