





THE RIVER, FORGE AND ARMORY

Bilbo and Frodo reunite in the gazebo. As council invitees arrive, they store their battle gear in the armory by the forge. Arwen and Aragorn meet secretly before the Fellowship departs on its treacherous journey.



EL RÍO, LA FORJA Y LA ARMERÍA

Bilbo y Frodo se reúnen en el kiosco. A medida que llegan los invitados a participar en el Concilio, dejan sus implementos de batalla en la armería, que está al lado de la forja. Arwen y Aragorn se reúnen en secreto antes de que la Comunidad emprenda su peligroso viaje.



LA RIVIÈRE, LA FORGE ET L'ARMURERIE

Bilbon et Frodon se retrouvent dans le pavillon. Lorsque les invités du conseil arrivent, ils rangent leur équipement de combat dans l'armurerie près de la forge. Arwen et Aragorn se rencontrent secrètement avant que la Communauté ne parte pour son voyage périlleux.



Arwen appears in her Elvish gown, complete with the Evenstar pendant she gifts to Aragorn in The Fellowship of The Ring.

Arwen apparaît dans sa robe elfique avec le pendentif Evenstar qu'elle offre à Aragorn dans La Communauté de l'Anneau.

Arwen aparece vestida con su túnica élfica, e incluso lleva puesto el colgante de la Estrella de la Tarde que le entrega a Aragorn en La Comunidad del Anillo.

ARWEN



Gimli wears his decorated battle helmet while wielding his brand-new axes. Gimli has been designed so he is taller than a Hobbit but shorter than an Elf.

Gimli porte son casque de combat décoré et brandit ses haches toutes neuves. Gimli a été conçu pour être plus grand qu'un Hobbit, mais plus petit qu'un Elfe.

Gimli lleva puesto su casco de batalla decorado y blande sus nuevas hachas de combate. Esta minifigura fue diseñada para ser más alta que la de un hobbit, pero más baja que la de un elfo.

GIMLI







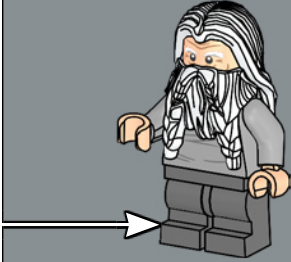
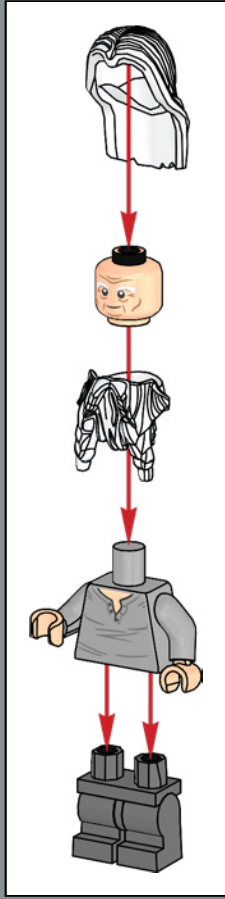
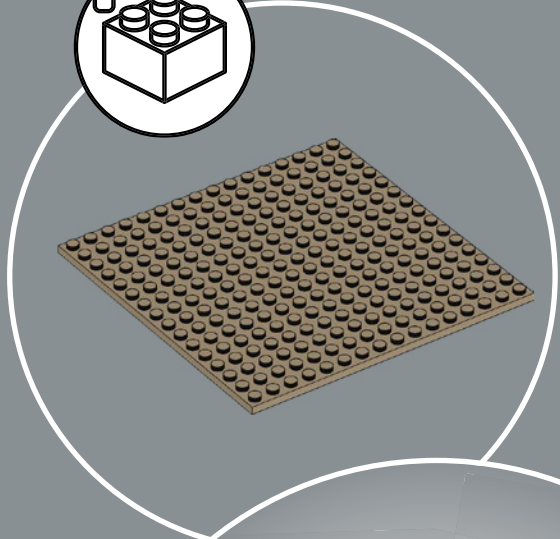
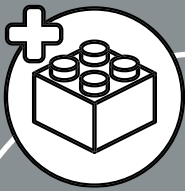

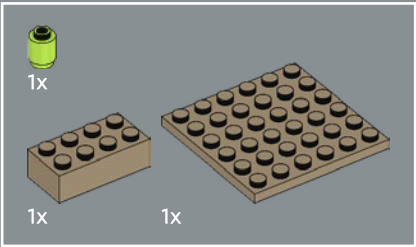

1

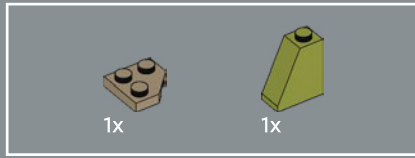
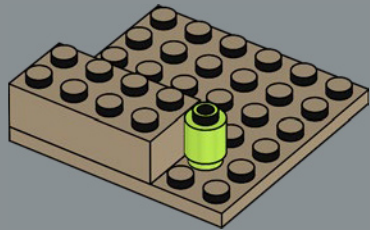

2

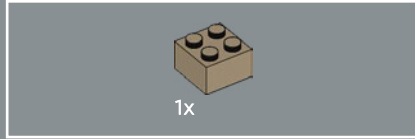
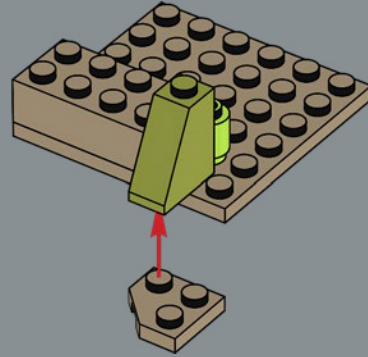

3

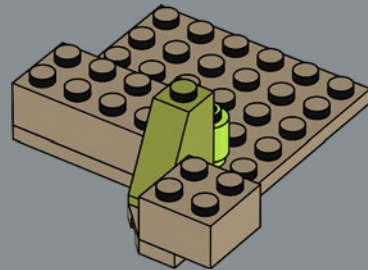

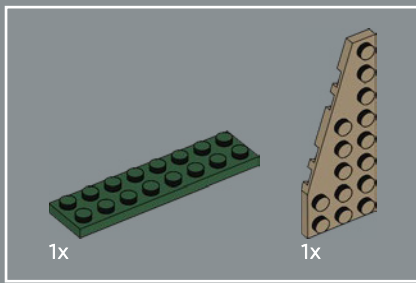

4

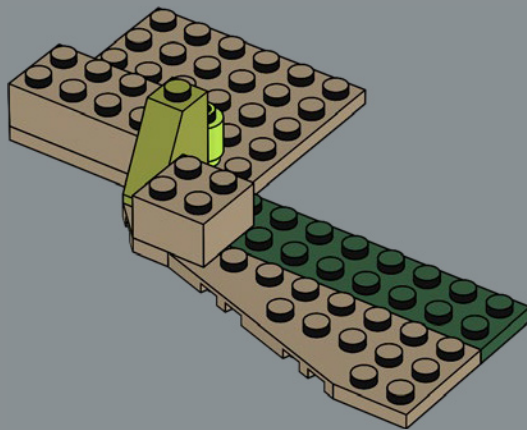

In the model, we use dozens of left and right elements to build up an organic-looking landscape. We made sure to include an equal number of each shape. See if you can find where they are all hidden!

Dans le modèle, nous utilisons des dizaines d'éléments de gauche et de droite pour construire un paysage d'apparence naturelle. Nous avons veillé à inclure un nombre égal de chaque forme. Voyez si vous pouvez trouver où ils sont tous cachés !

Usamos decenas de elementos izquierdos y derechos en el modelo para crear un paisaje con apariencia orgánica. Nos aseguramos de incluir las formas en cantidades iguales. ¡Mira si puedes descubrir dónde las ocultamos todas!

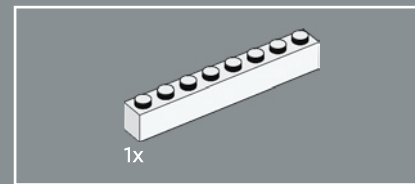

5

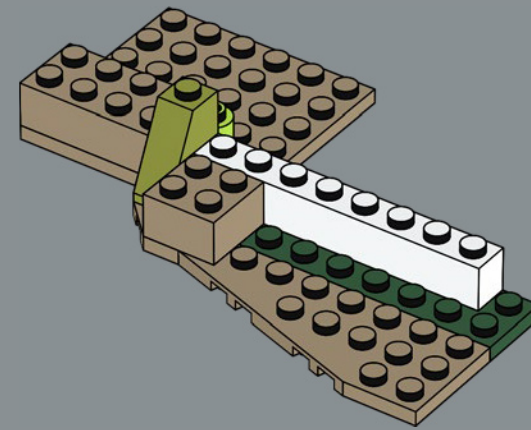

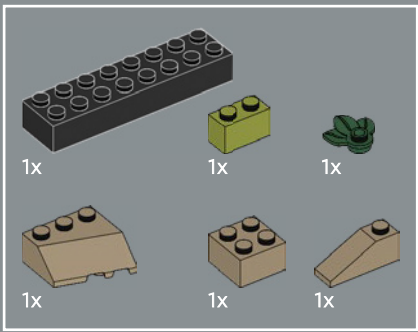

6

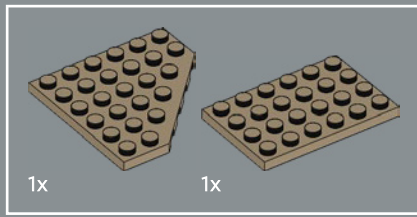
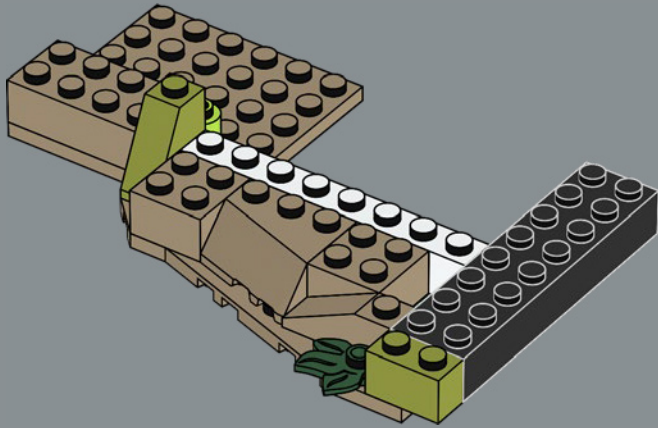

7

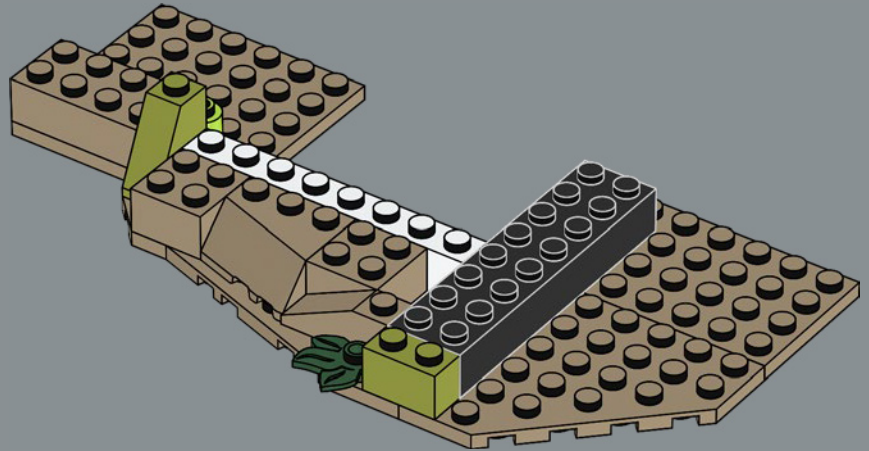

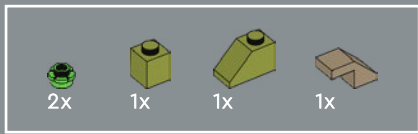

8

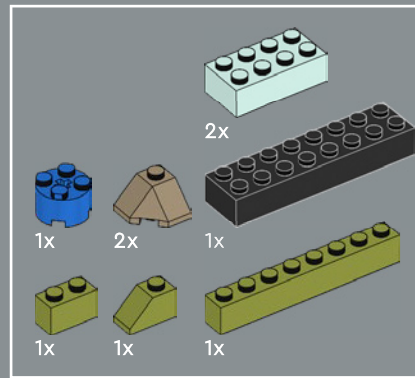
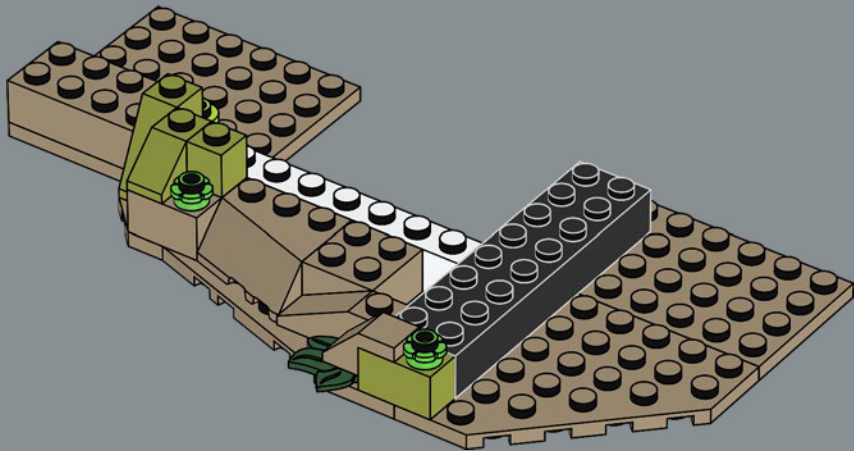

9

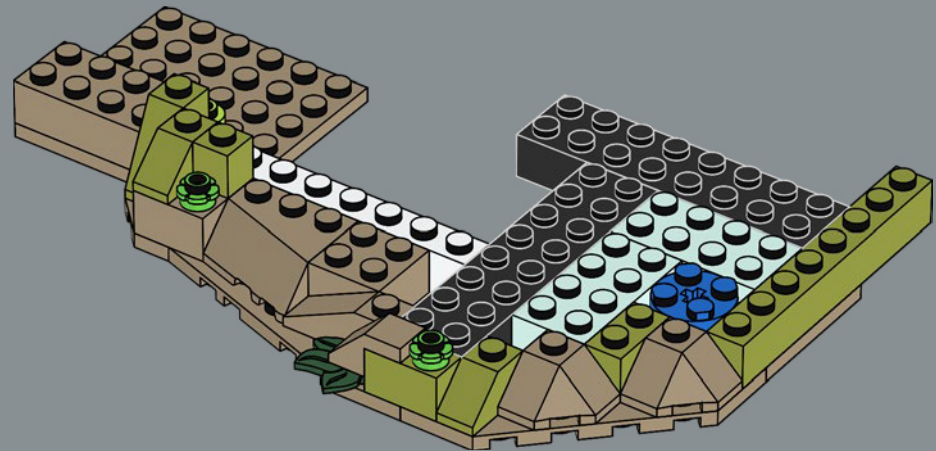

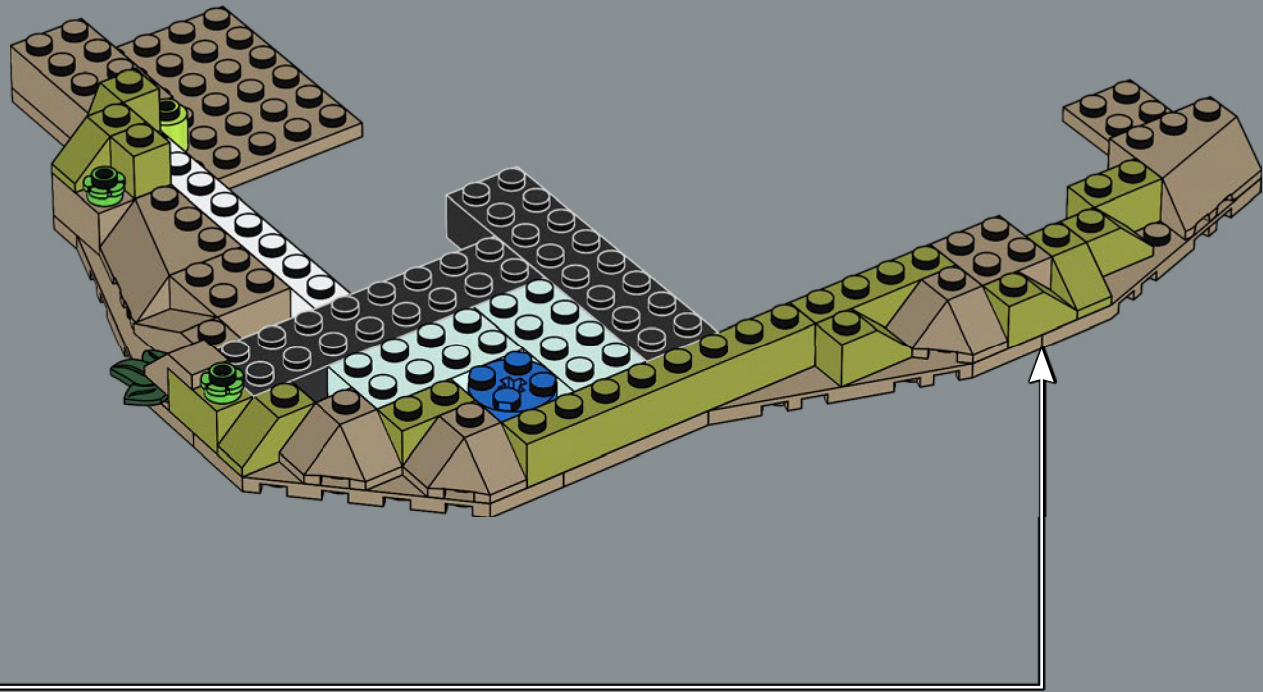



11

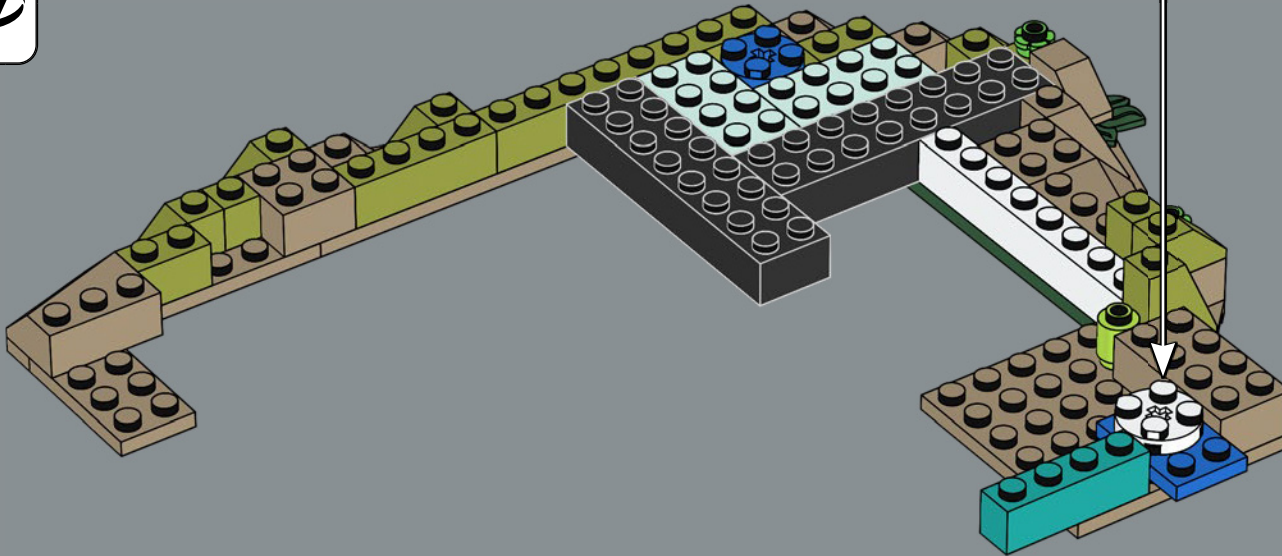
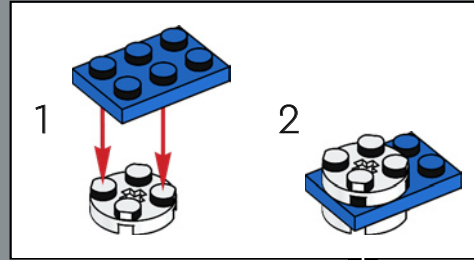

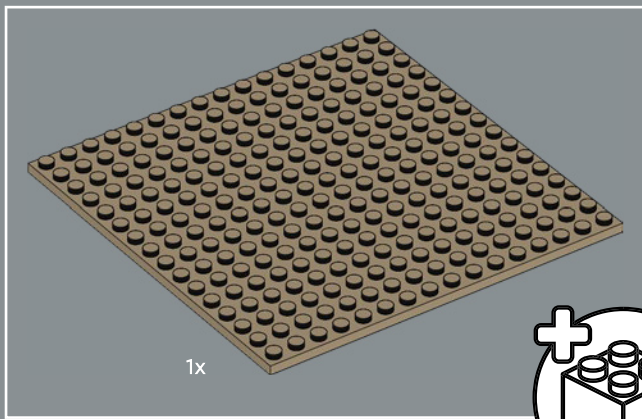

1x

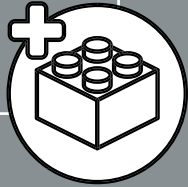

12

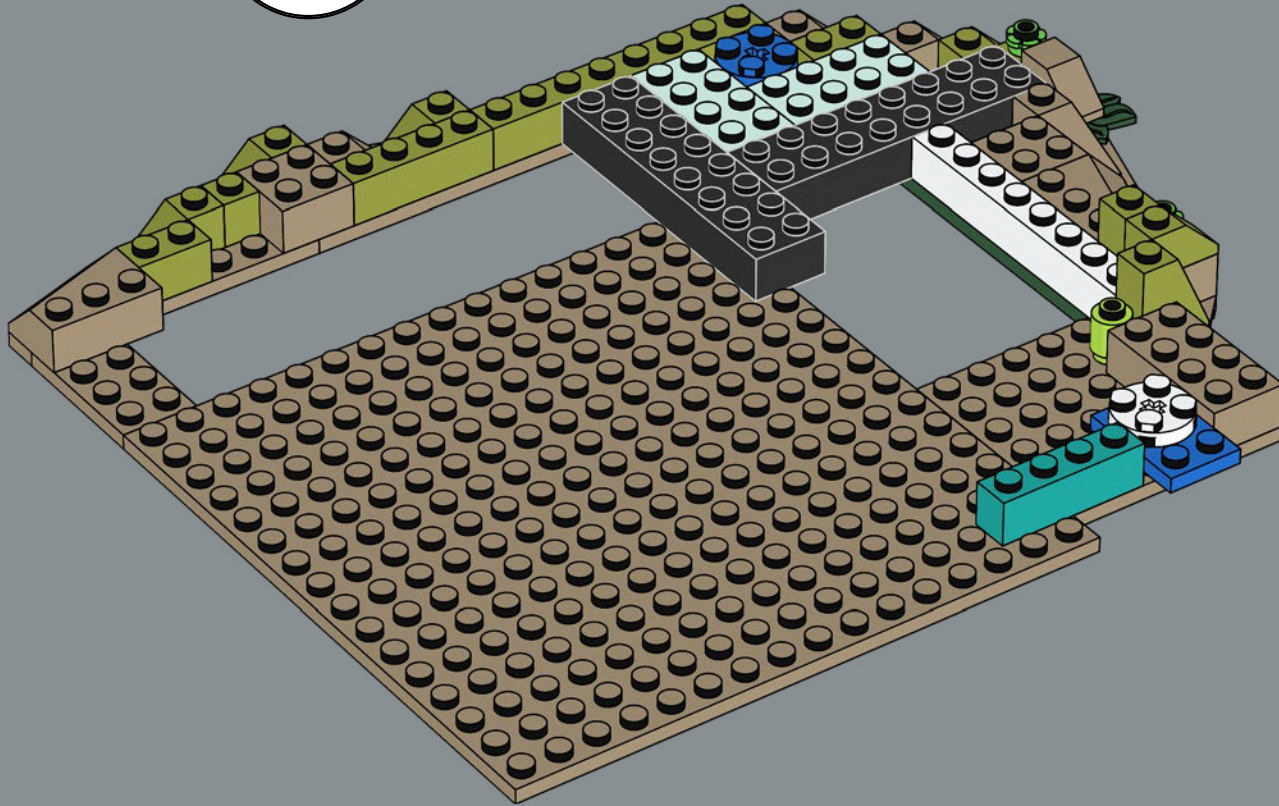

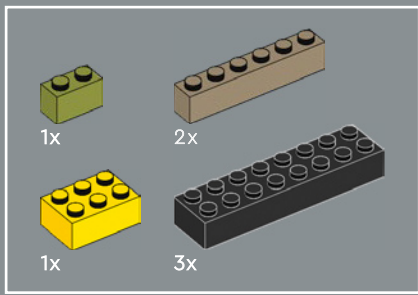

13

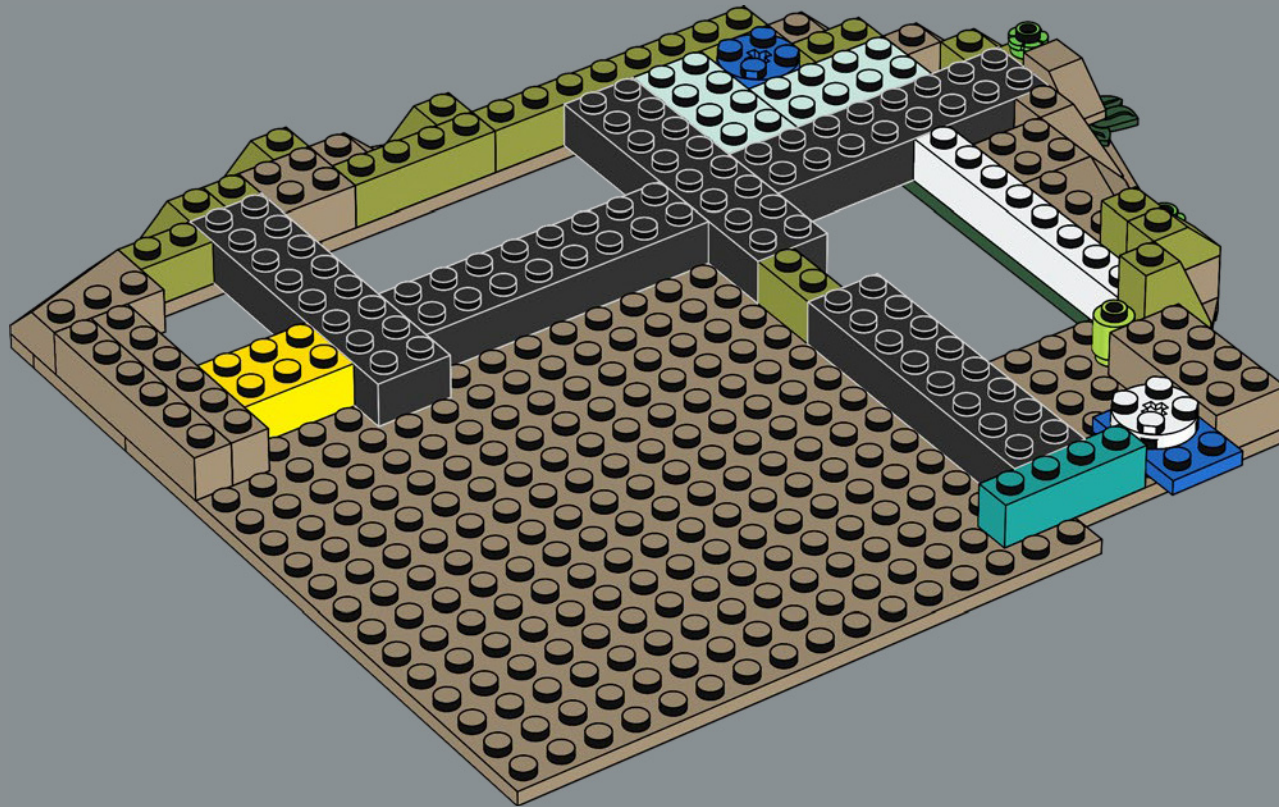

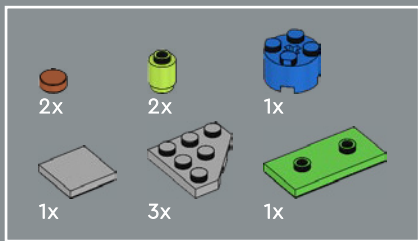

14

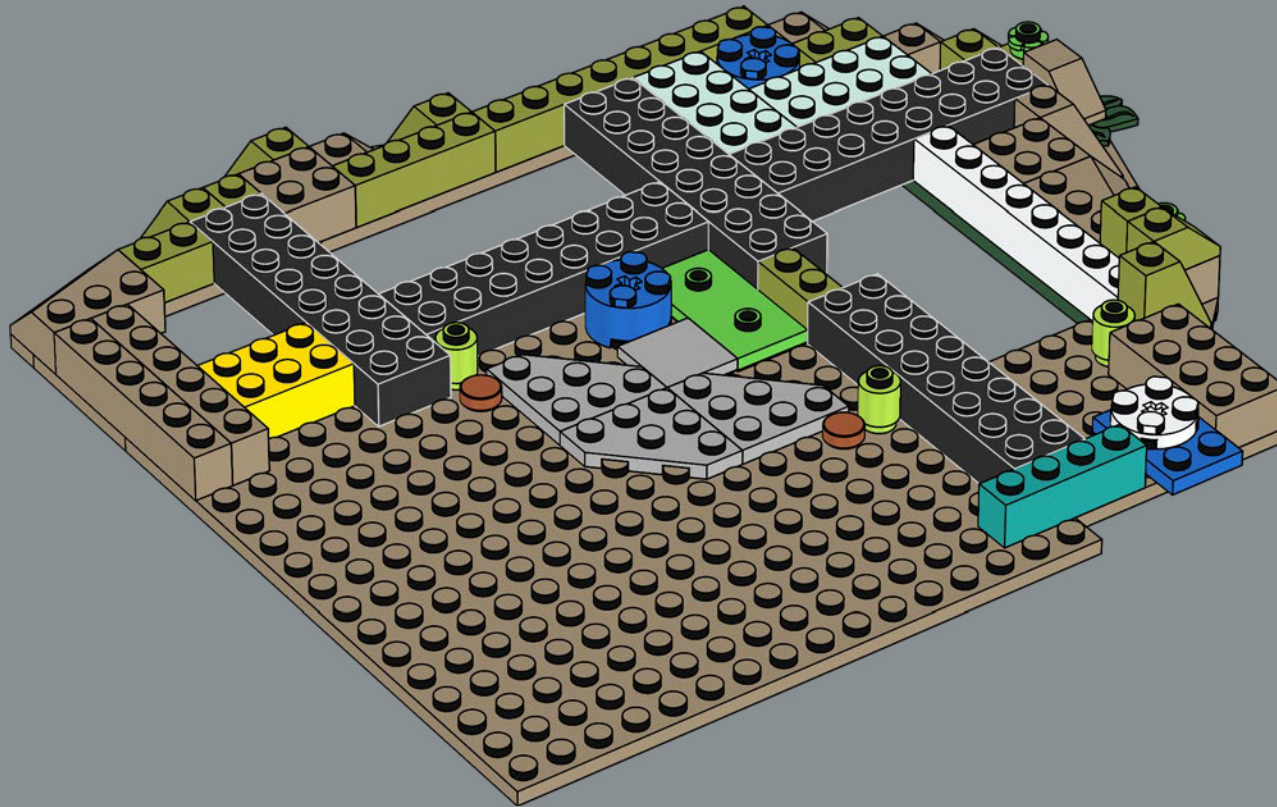

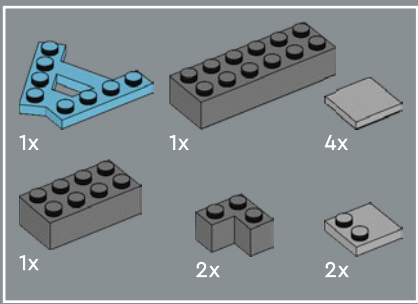

15

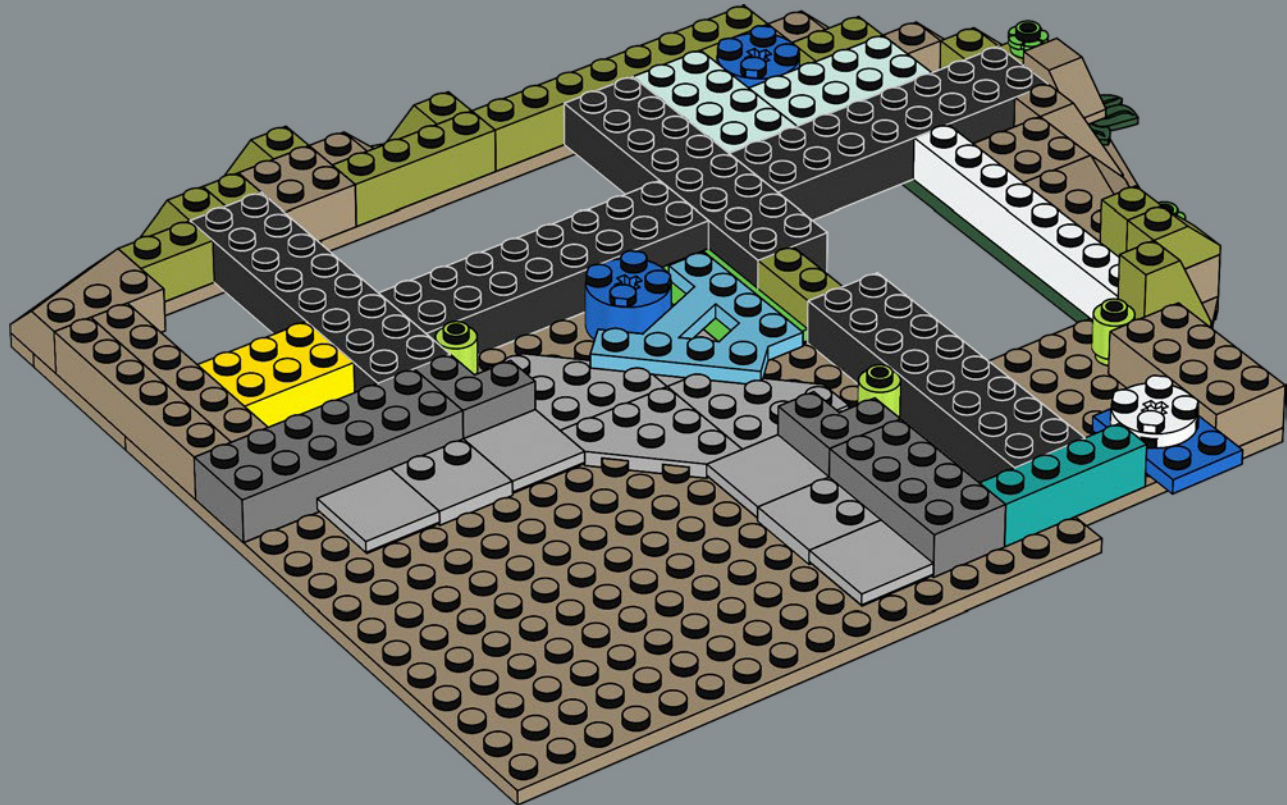

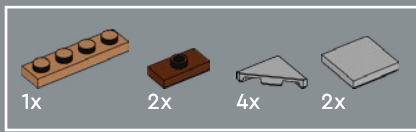

16

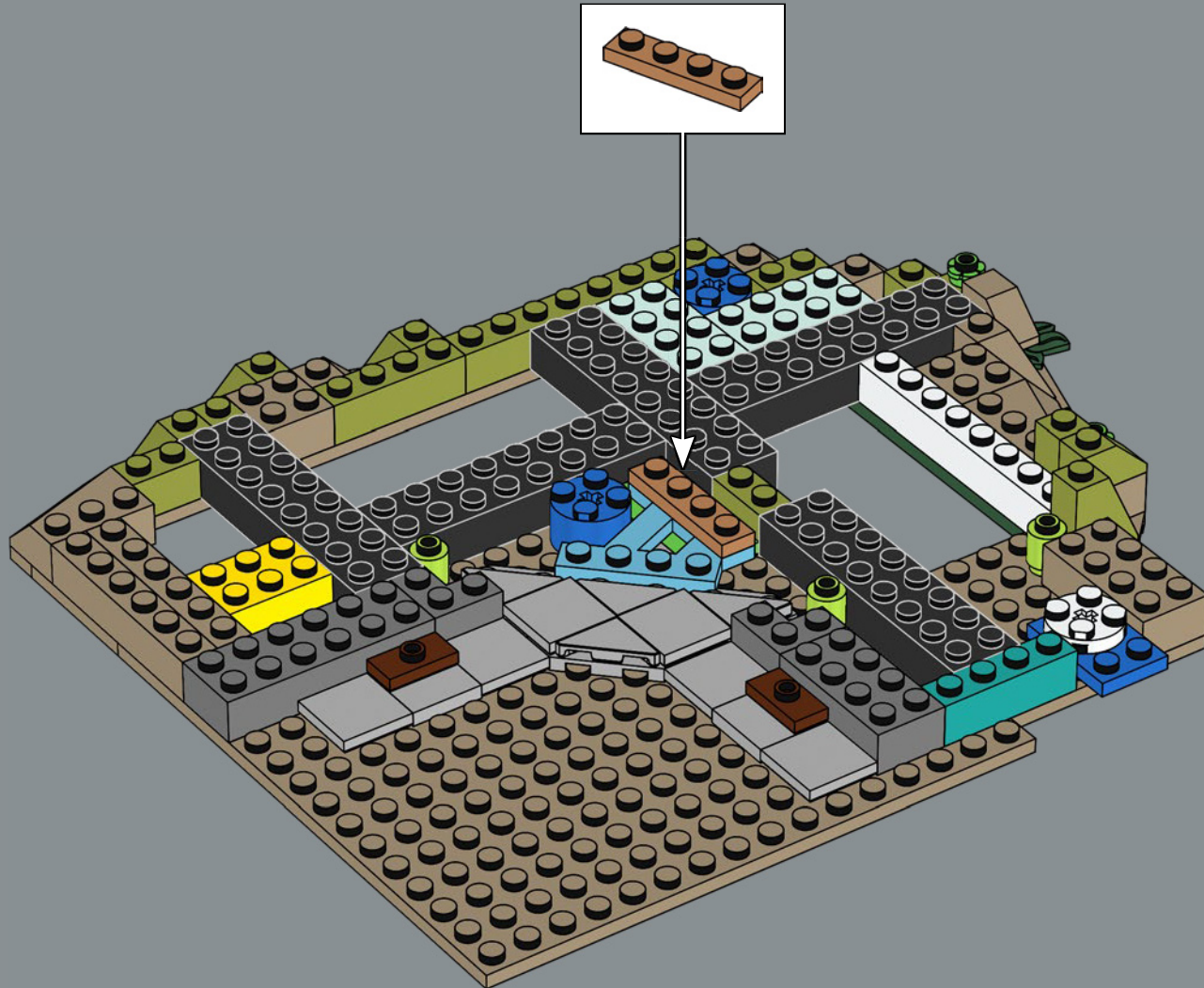

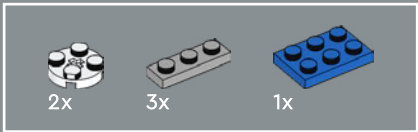

17

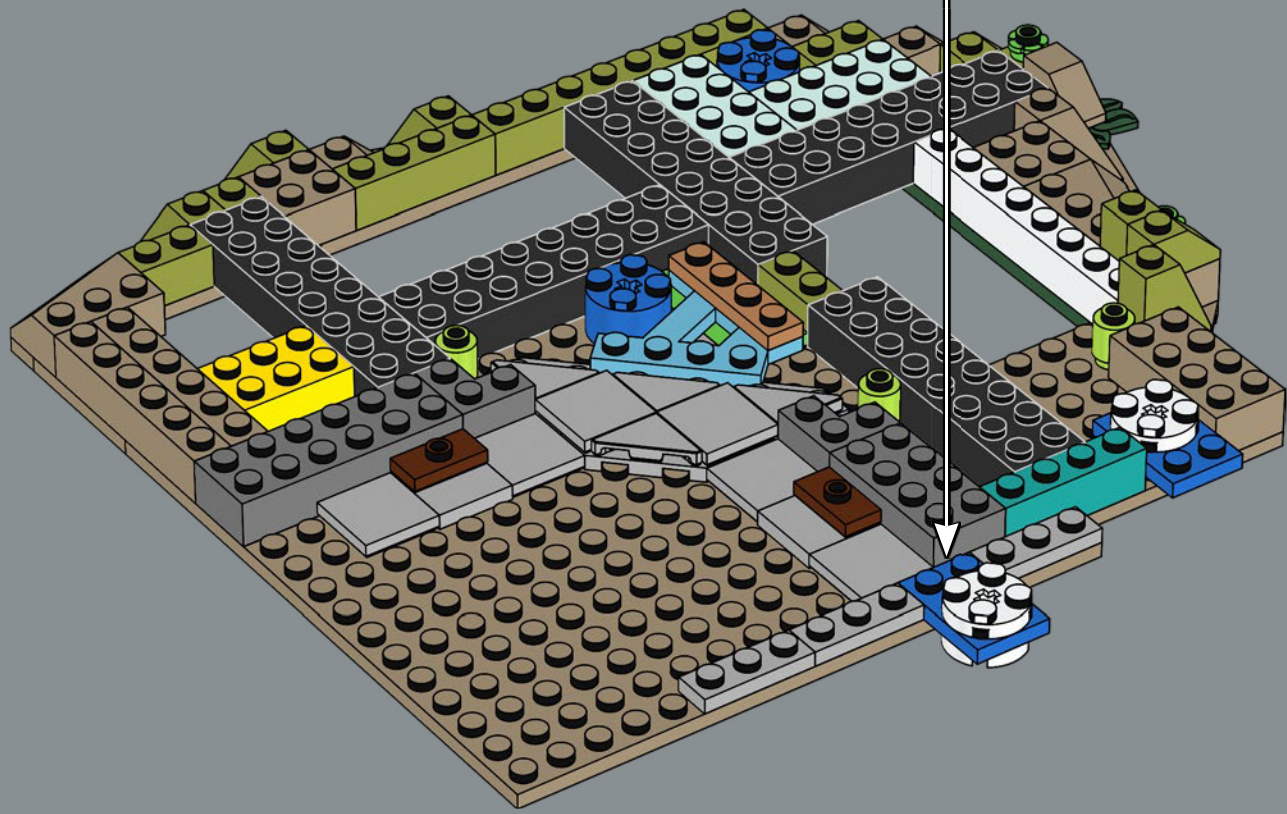
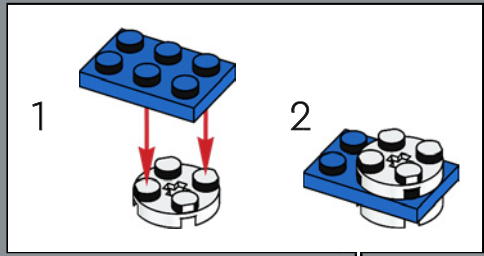

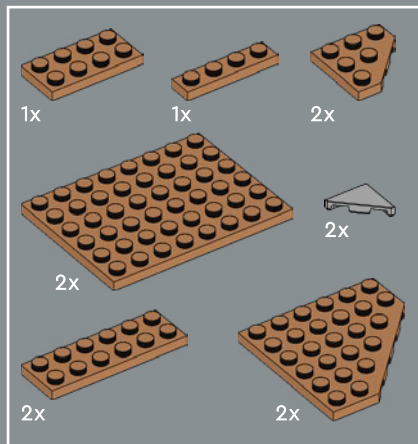

18

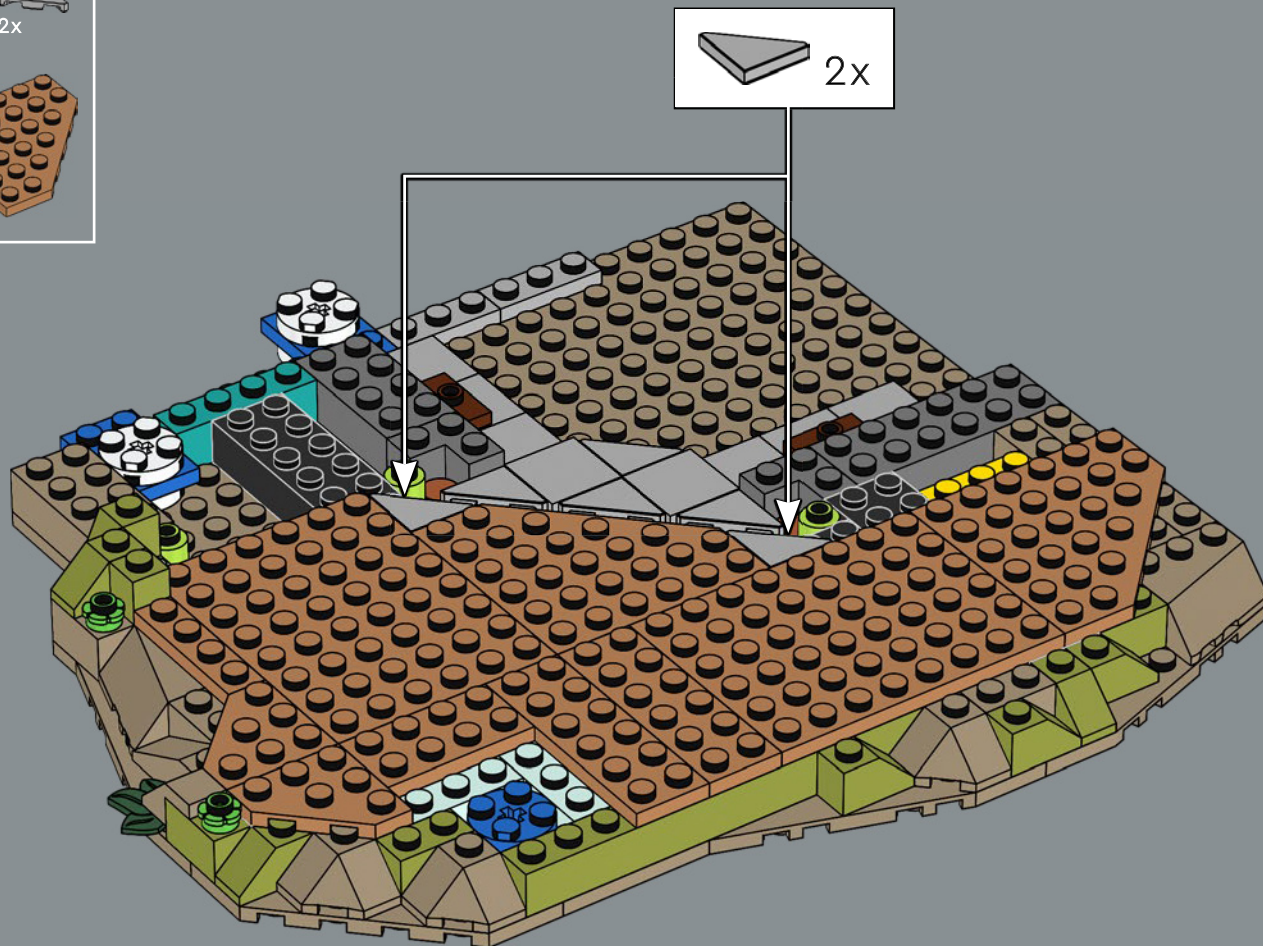

- 2x
- 1x
- 2x
- 1x
- 1x

19

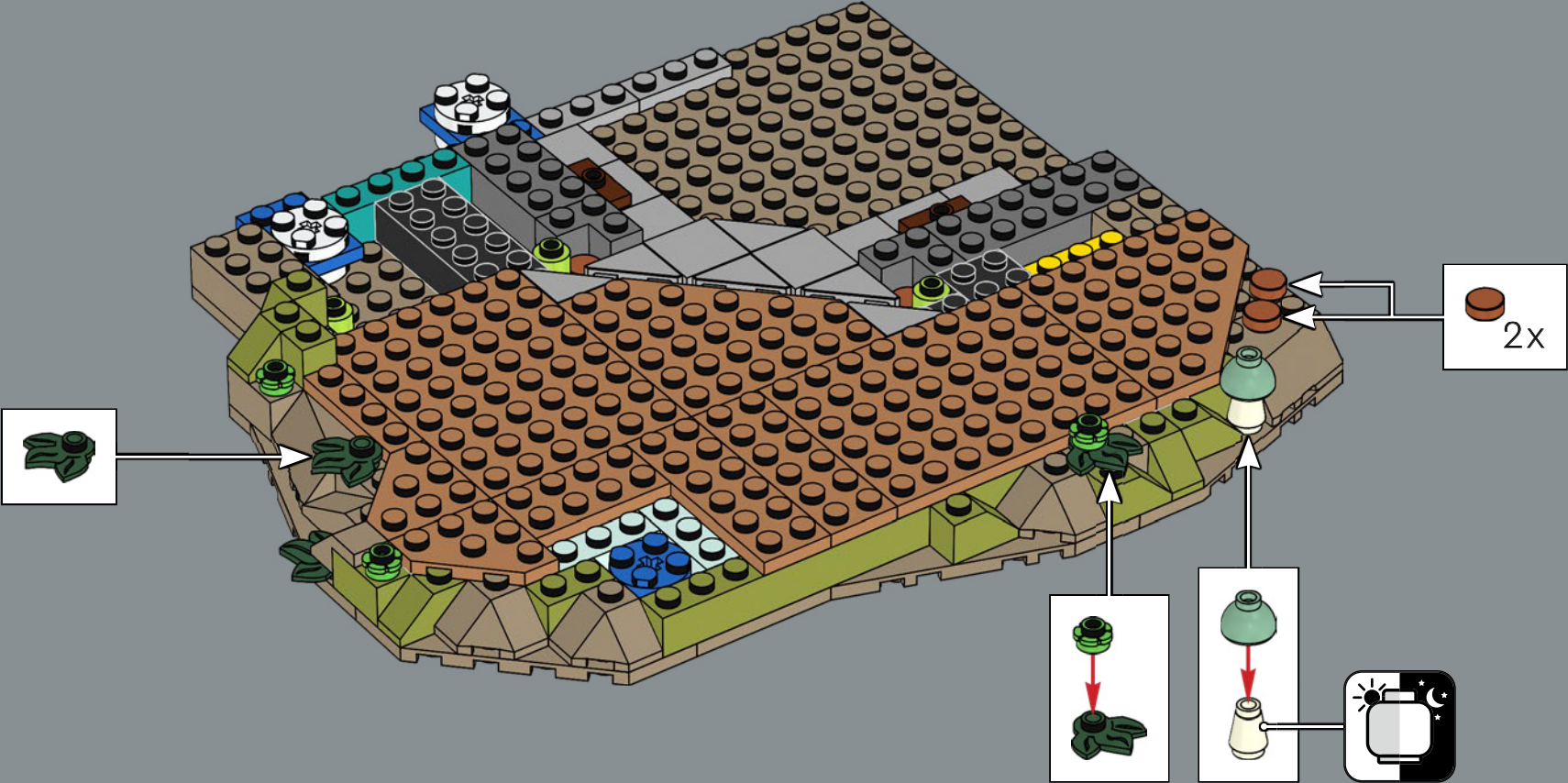

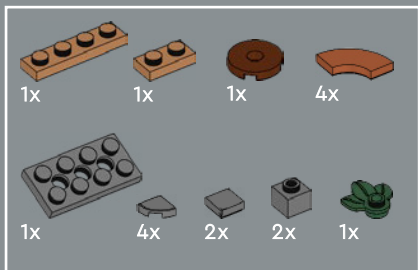

20

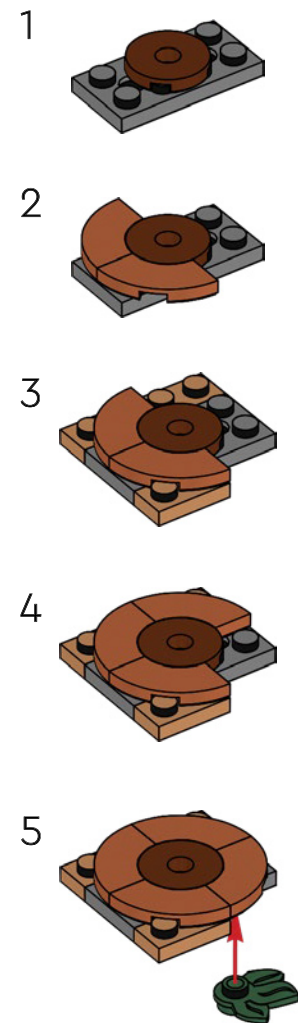
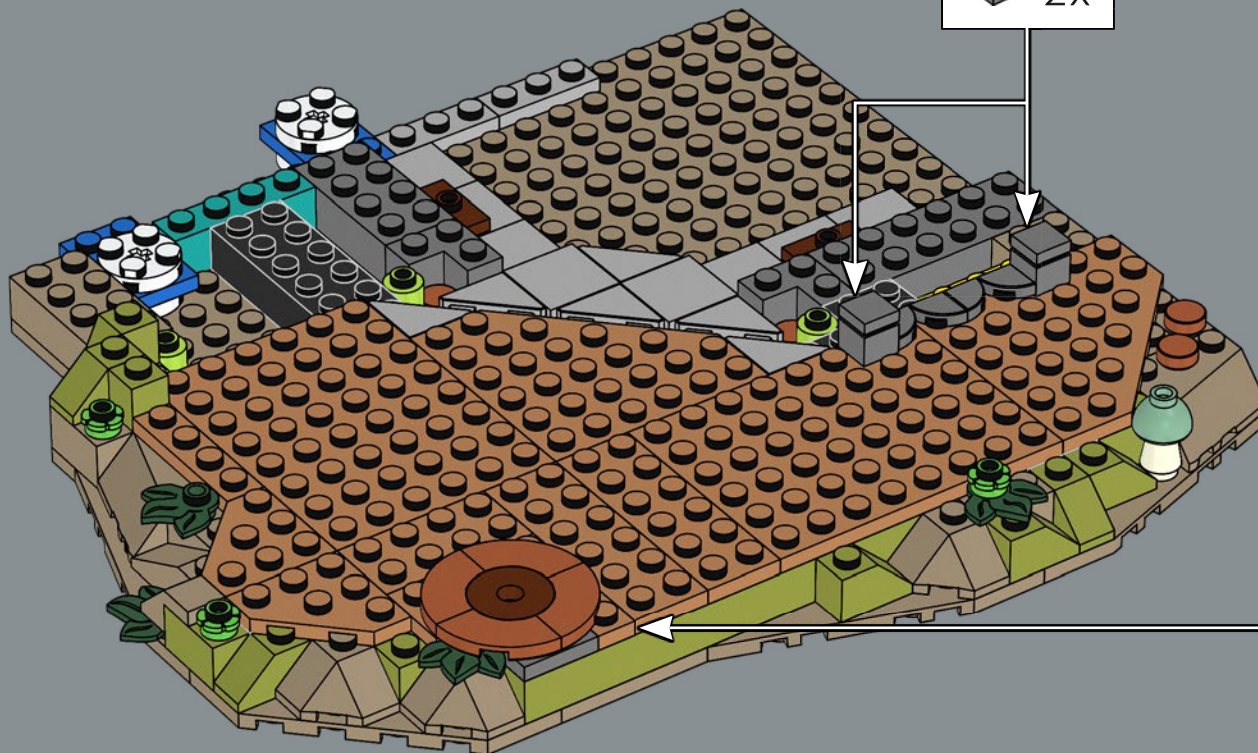
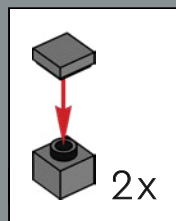

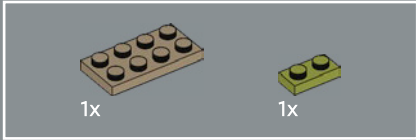
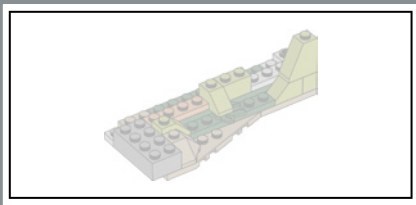

21

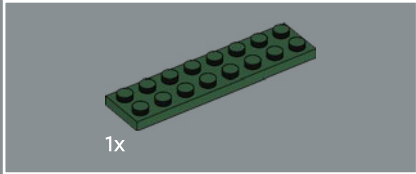
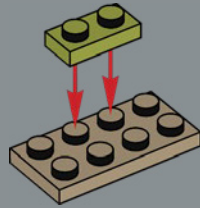

22

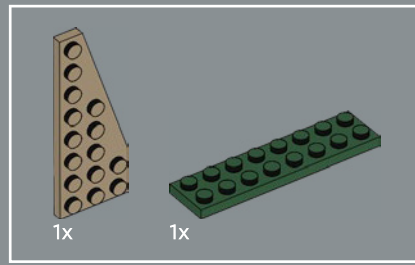
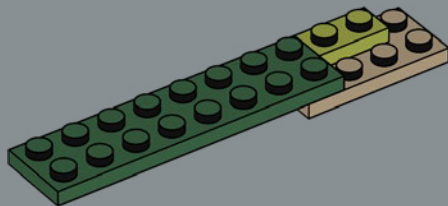

23

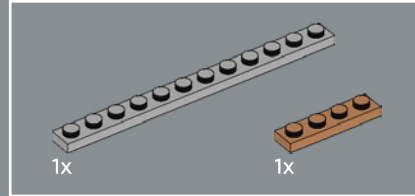
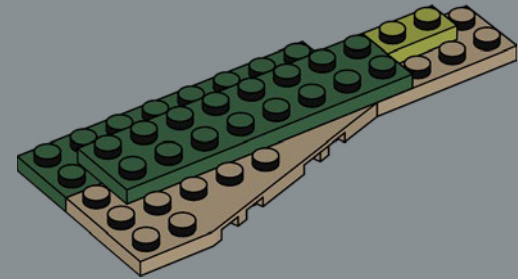

24

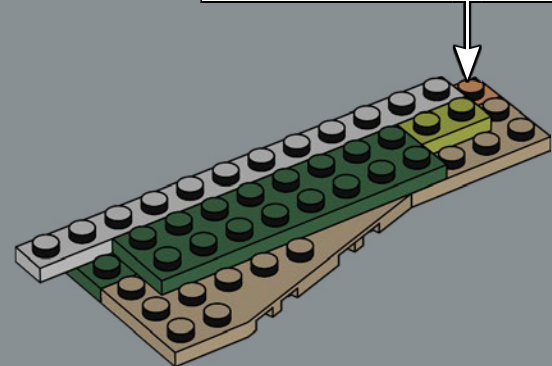
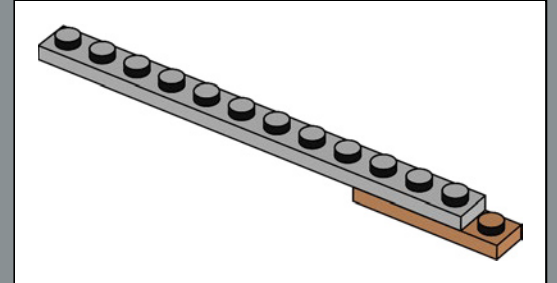

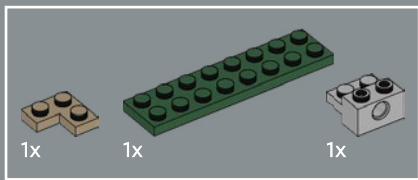

25

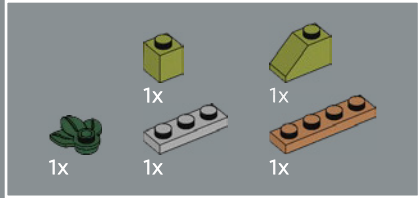
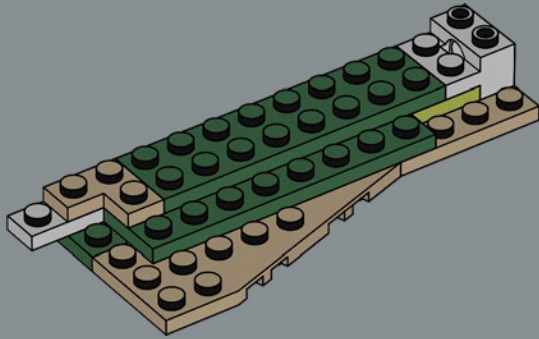

26

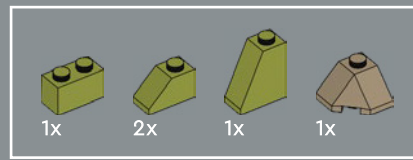
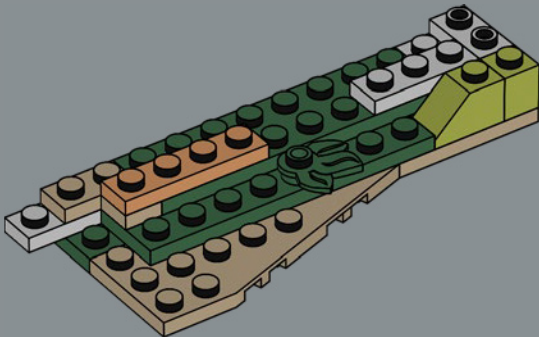

27

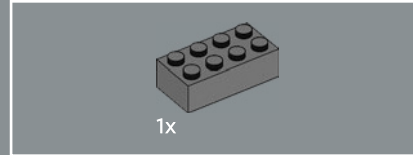
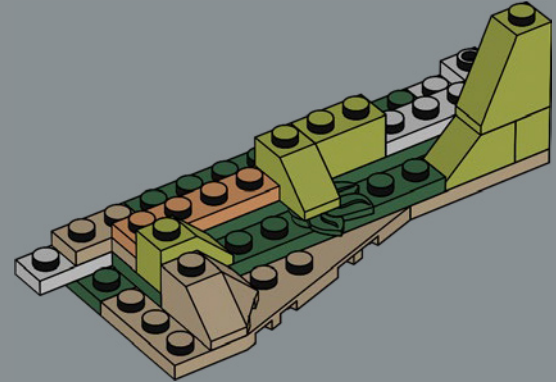

28

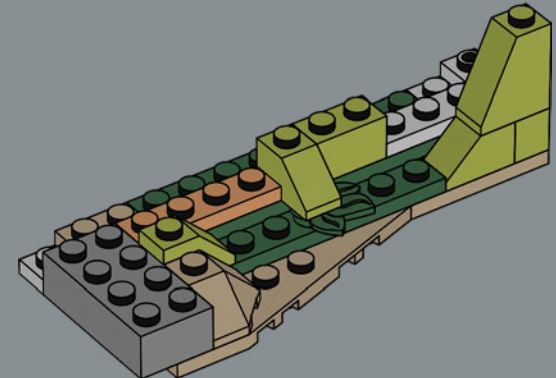

29

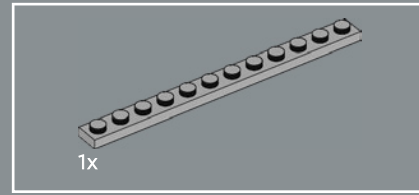
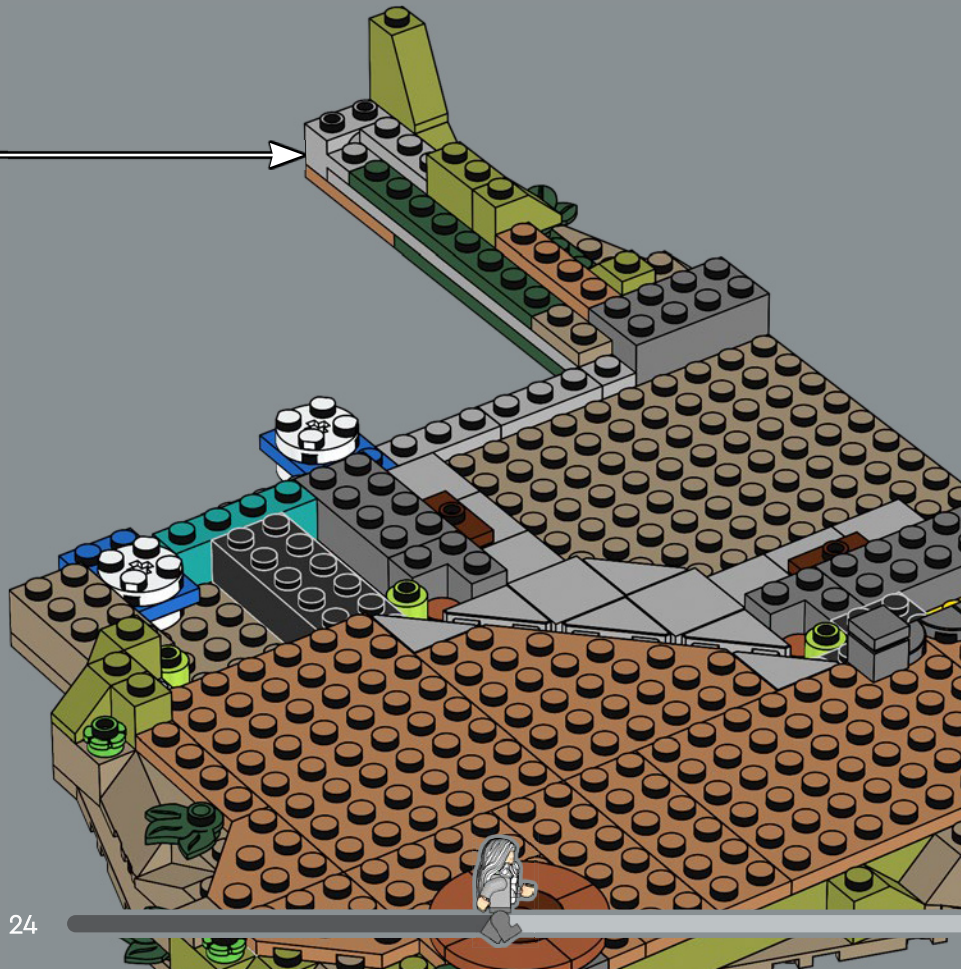

30

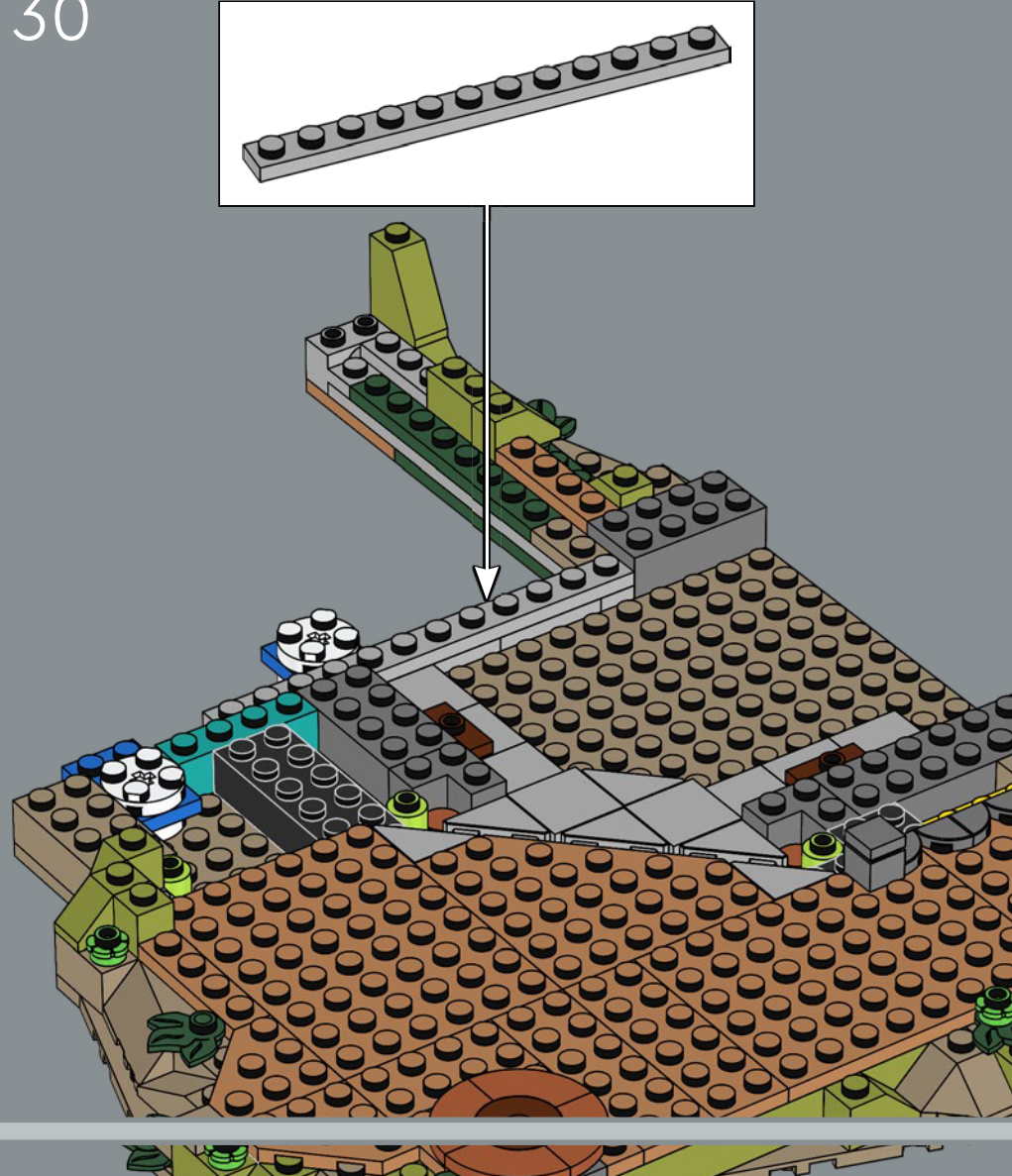

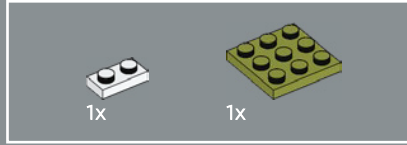
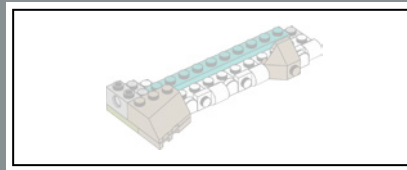
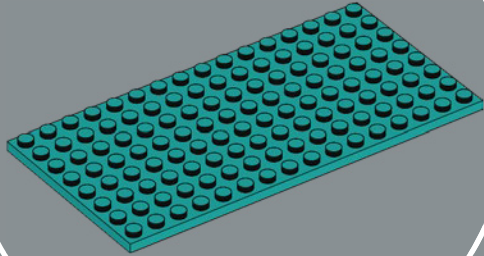
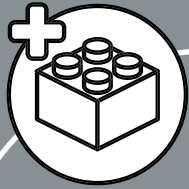

31

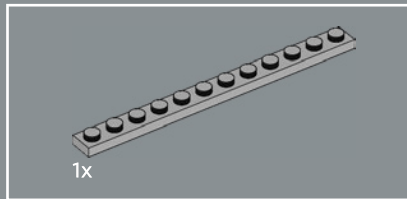
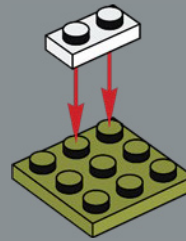

32

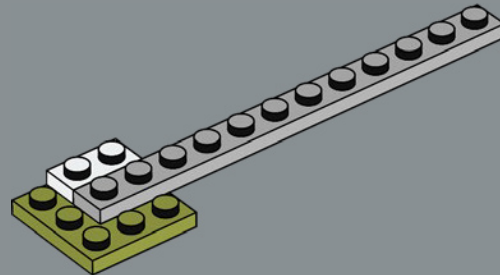

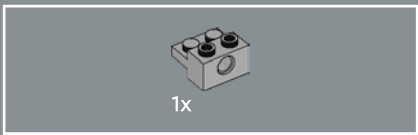

33

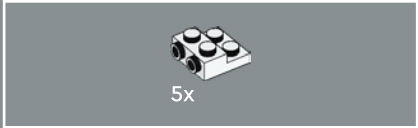
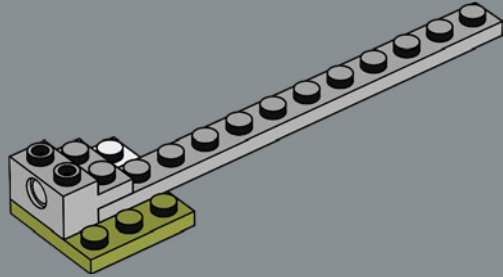

34

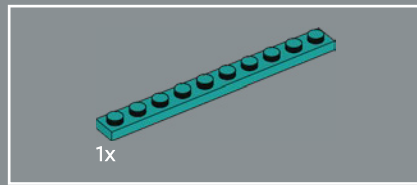
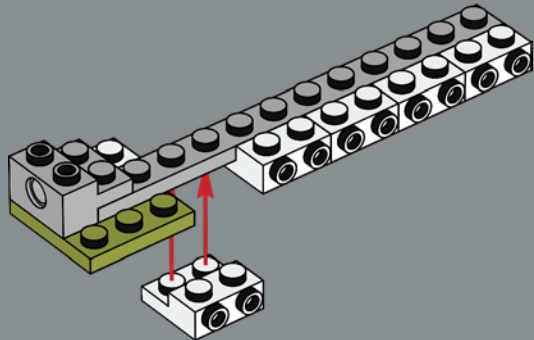

35

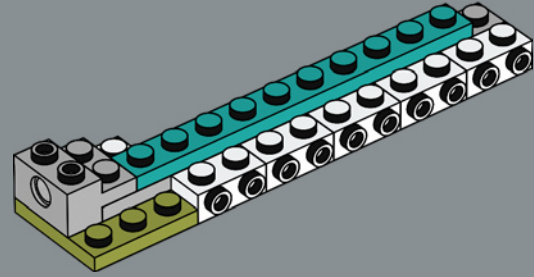

36

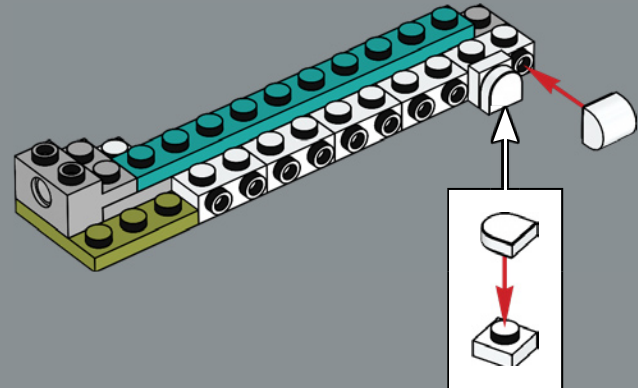



37

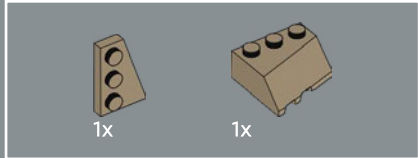
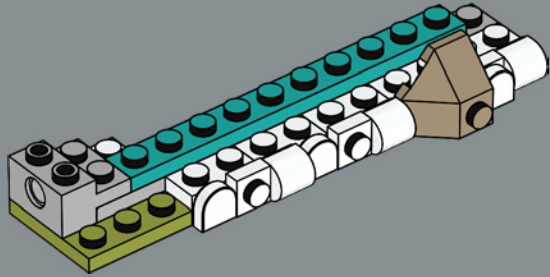

38

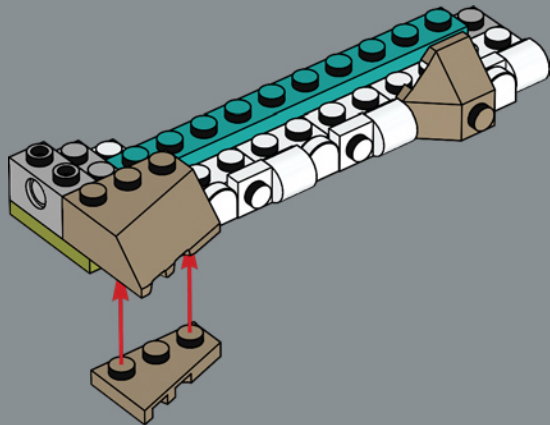

39

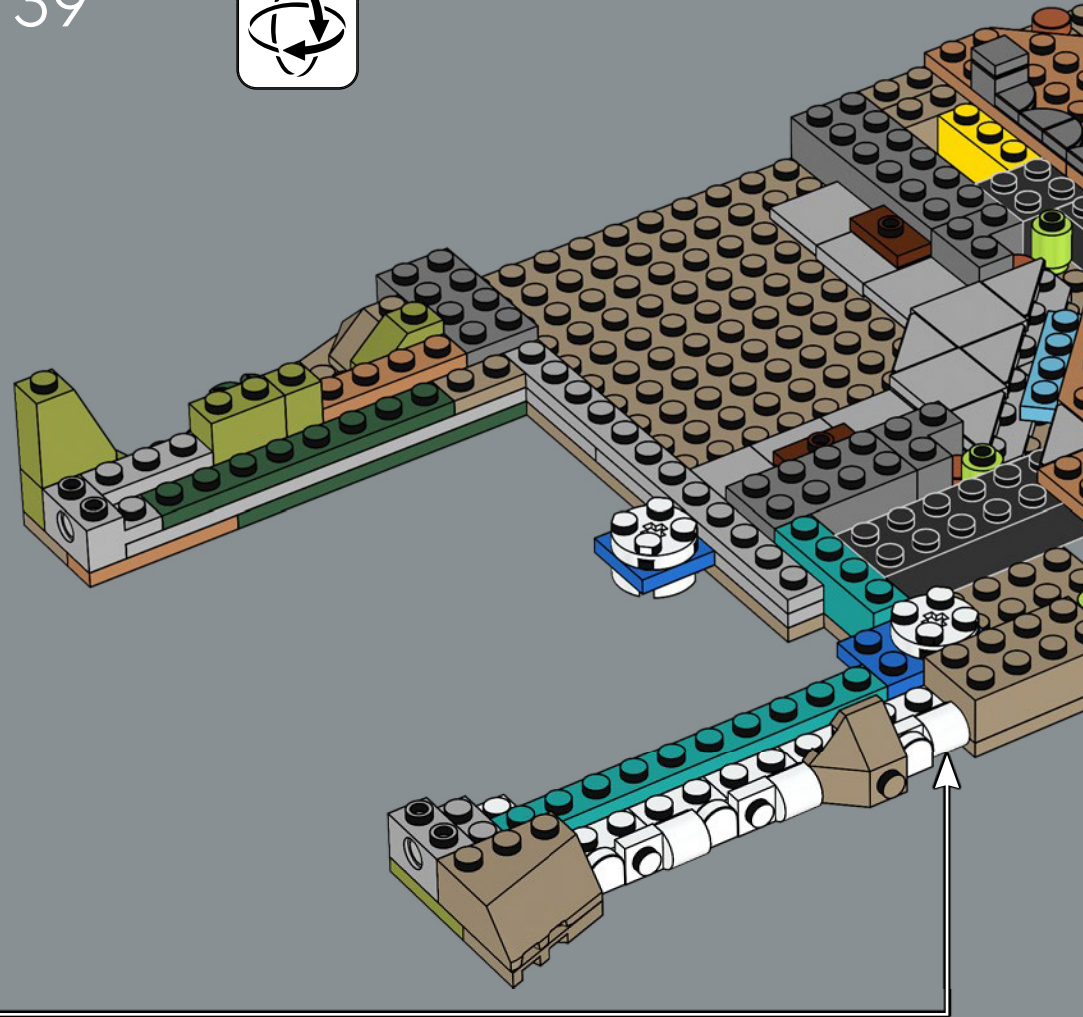

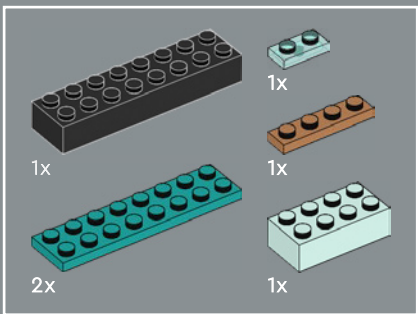

40

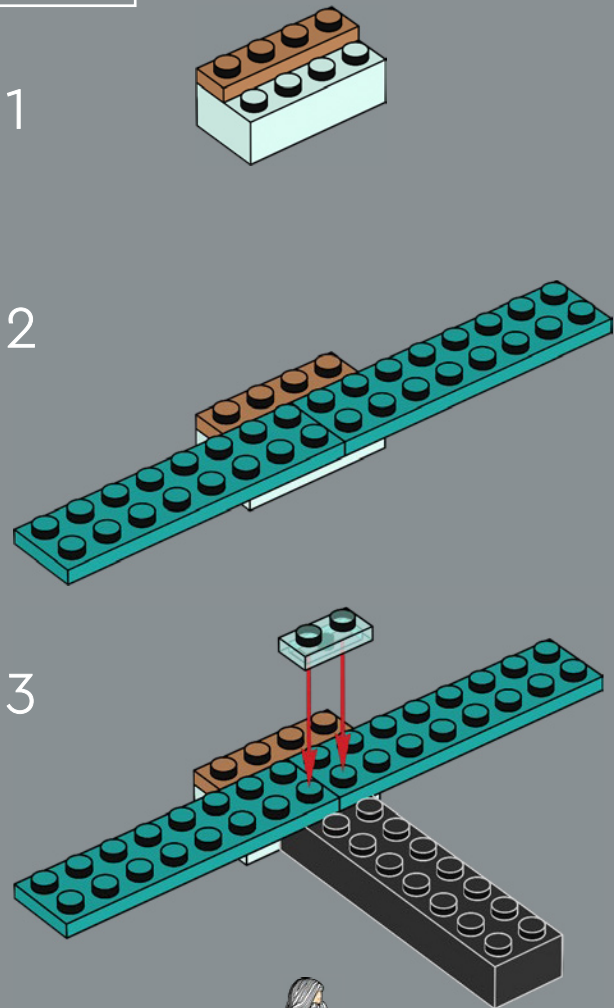

1

2

3

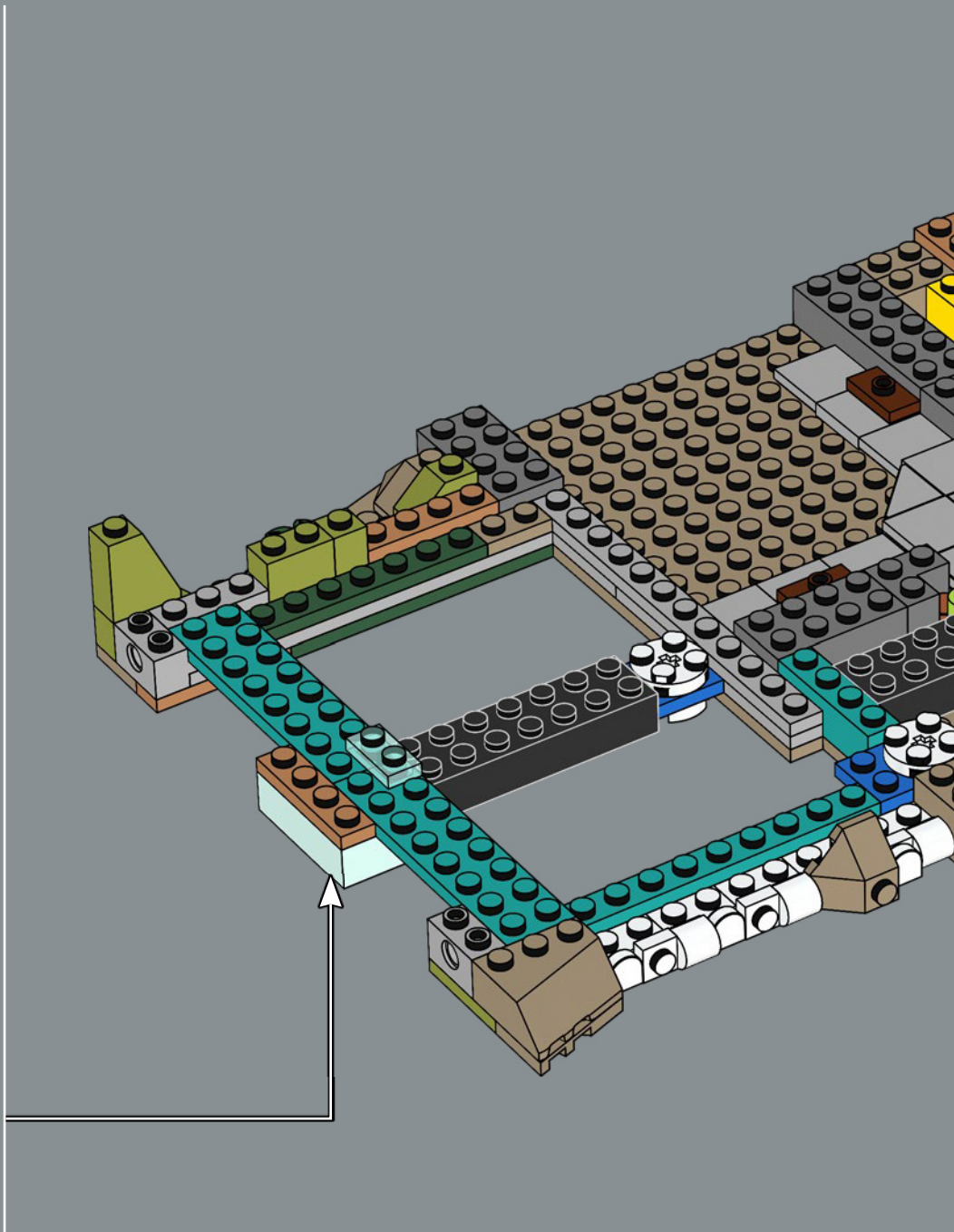

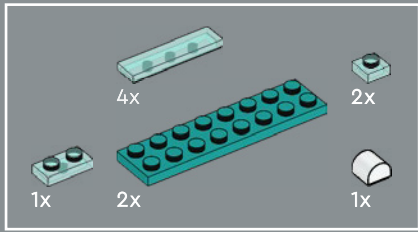

41

1

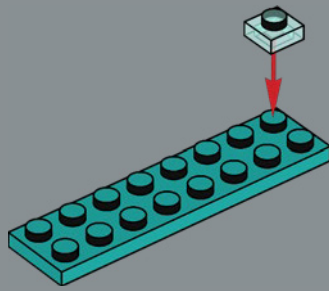

2

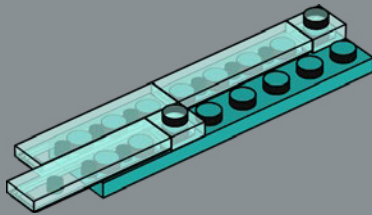

3

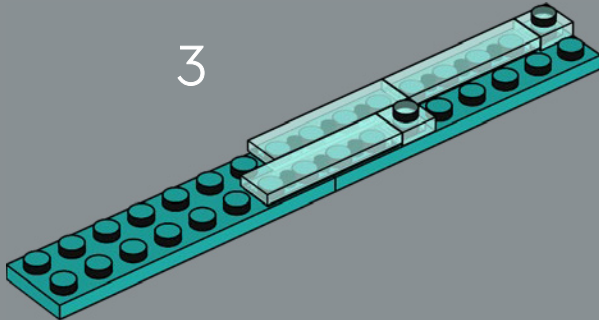

4

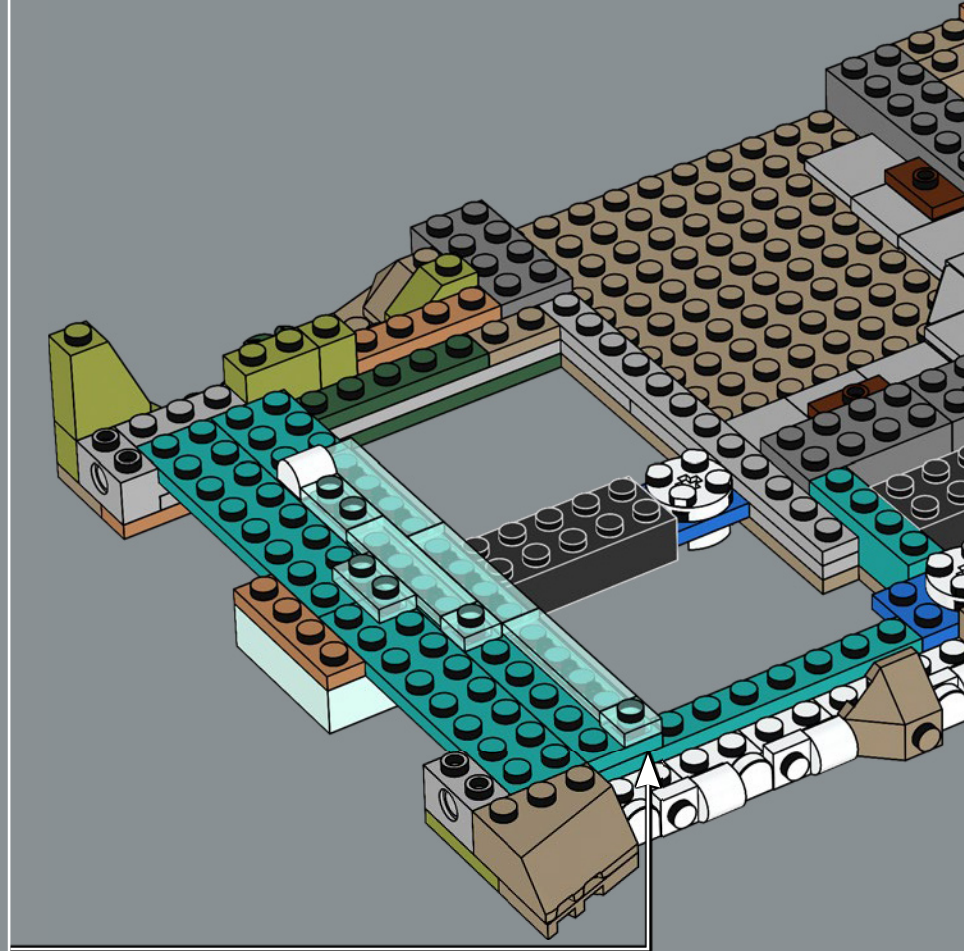
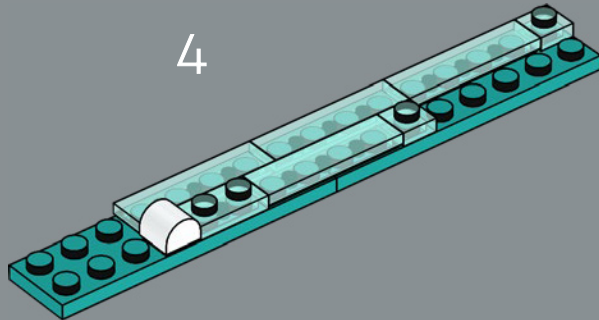

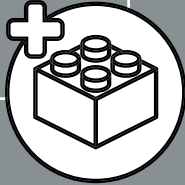
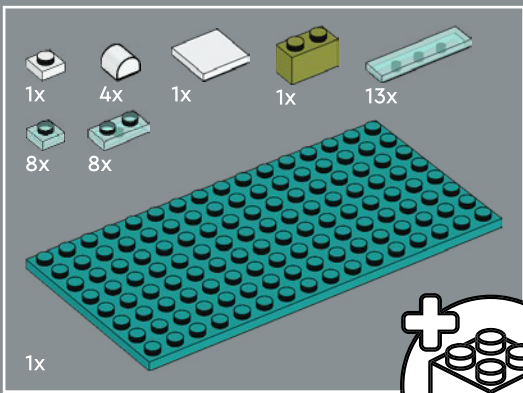

42

1

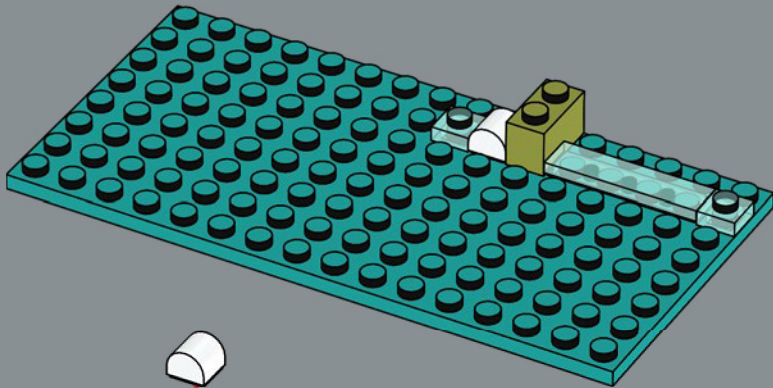

2

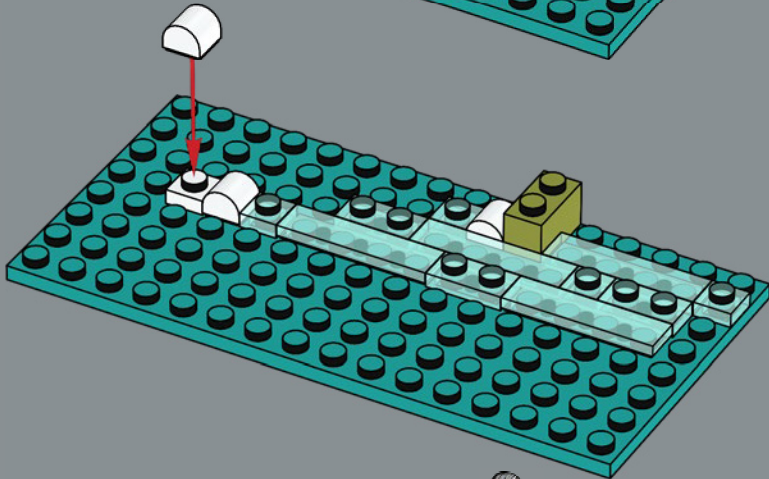

3

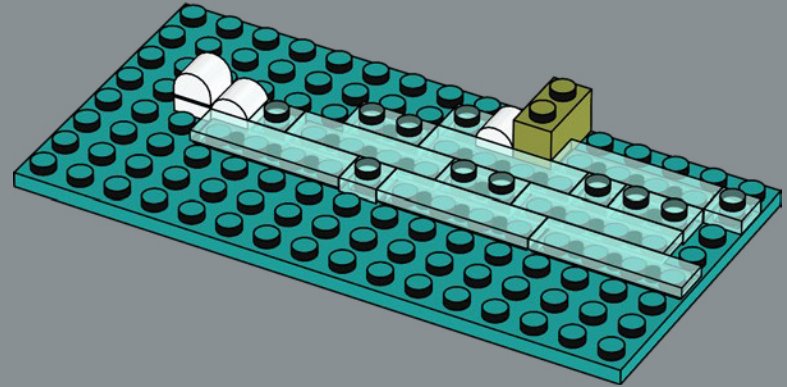

4

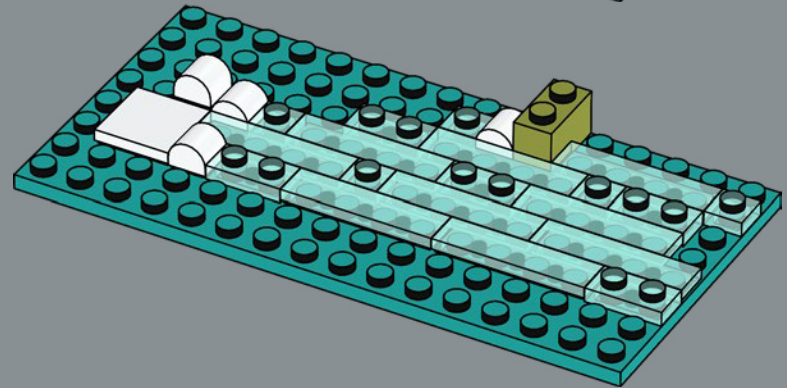

5

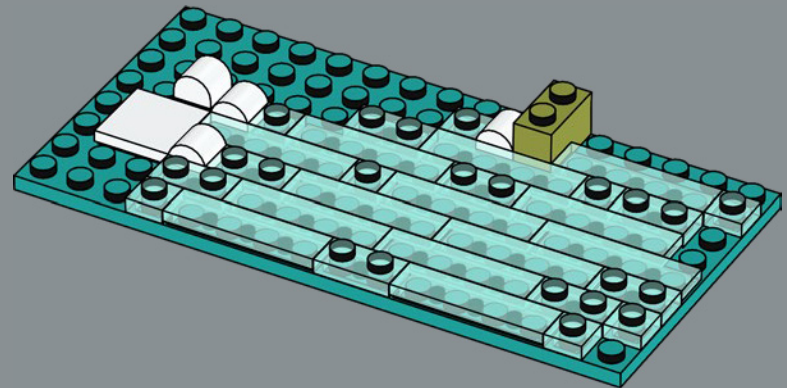

43

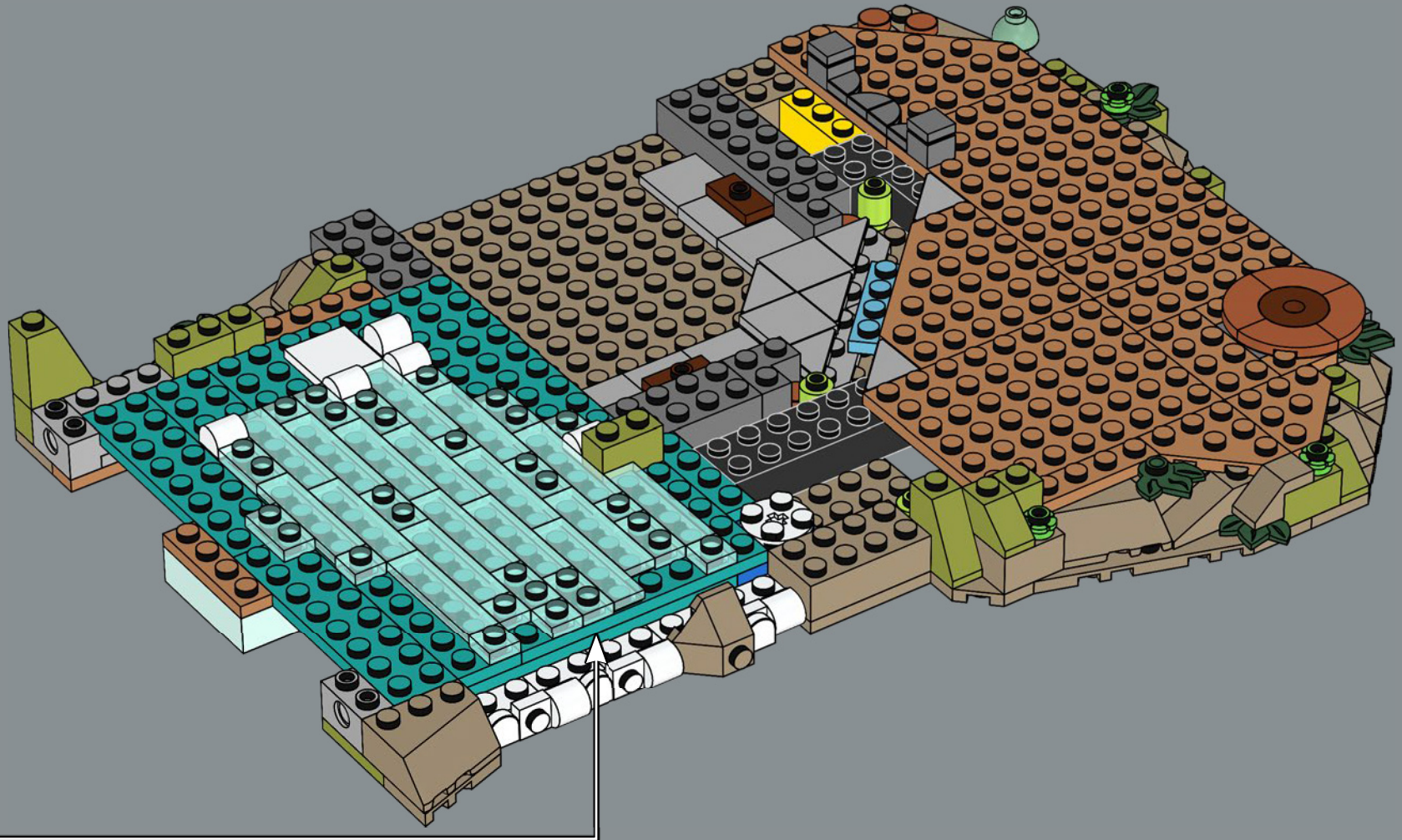

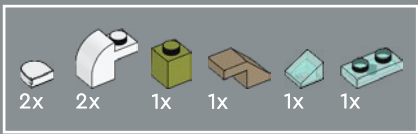

44

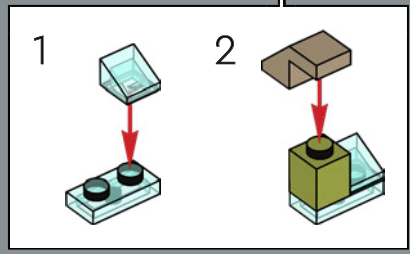
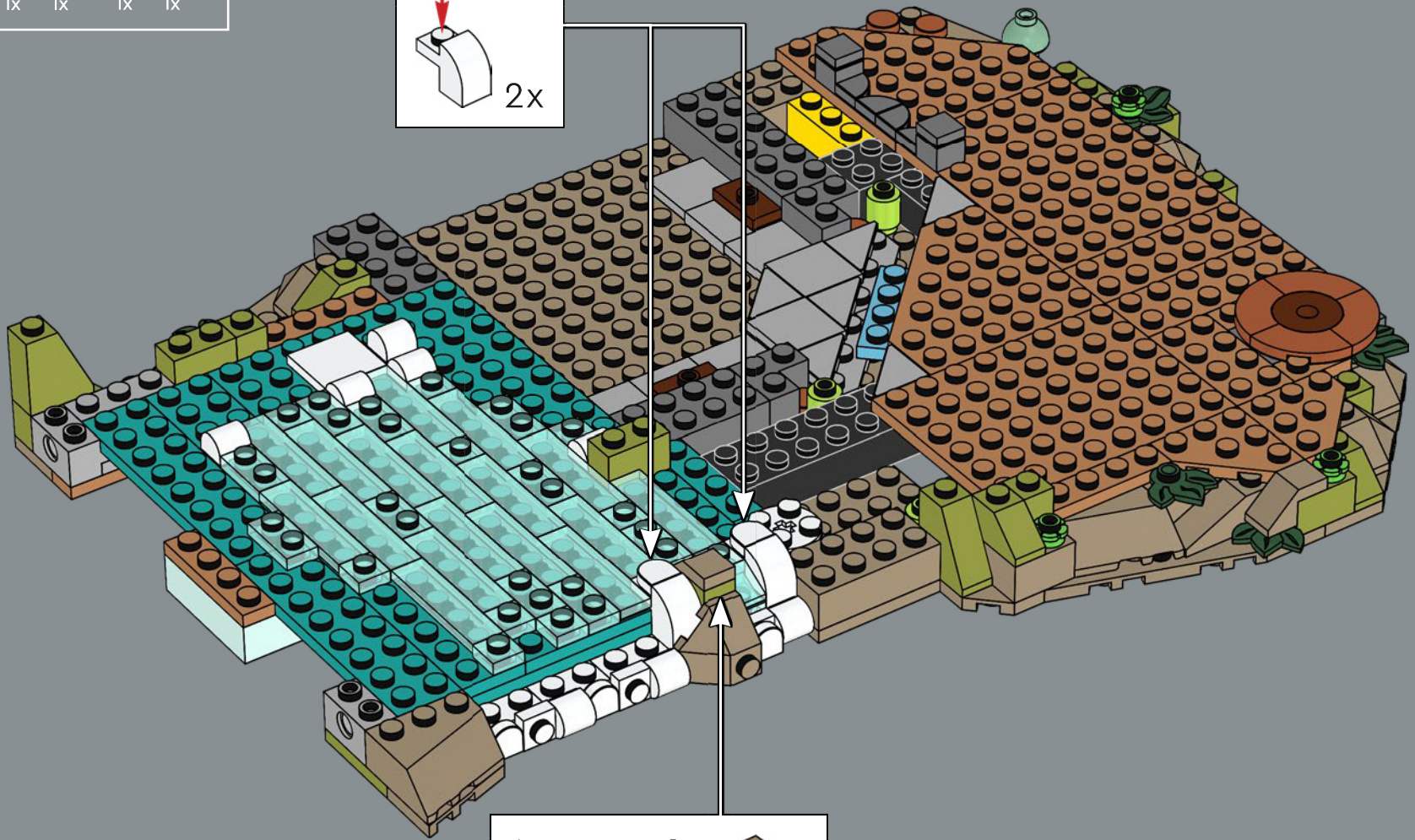
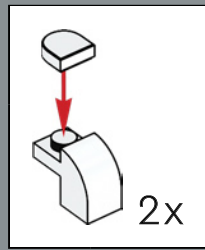

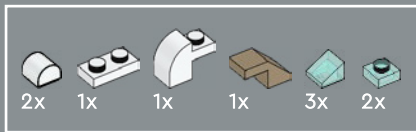

45

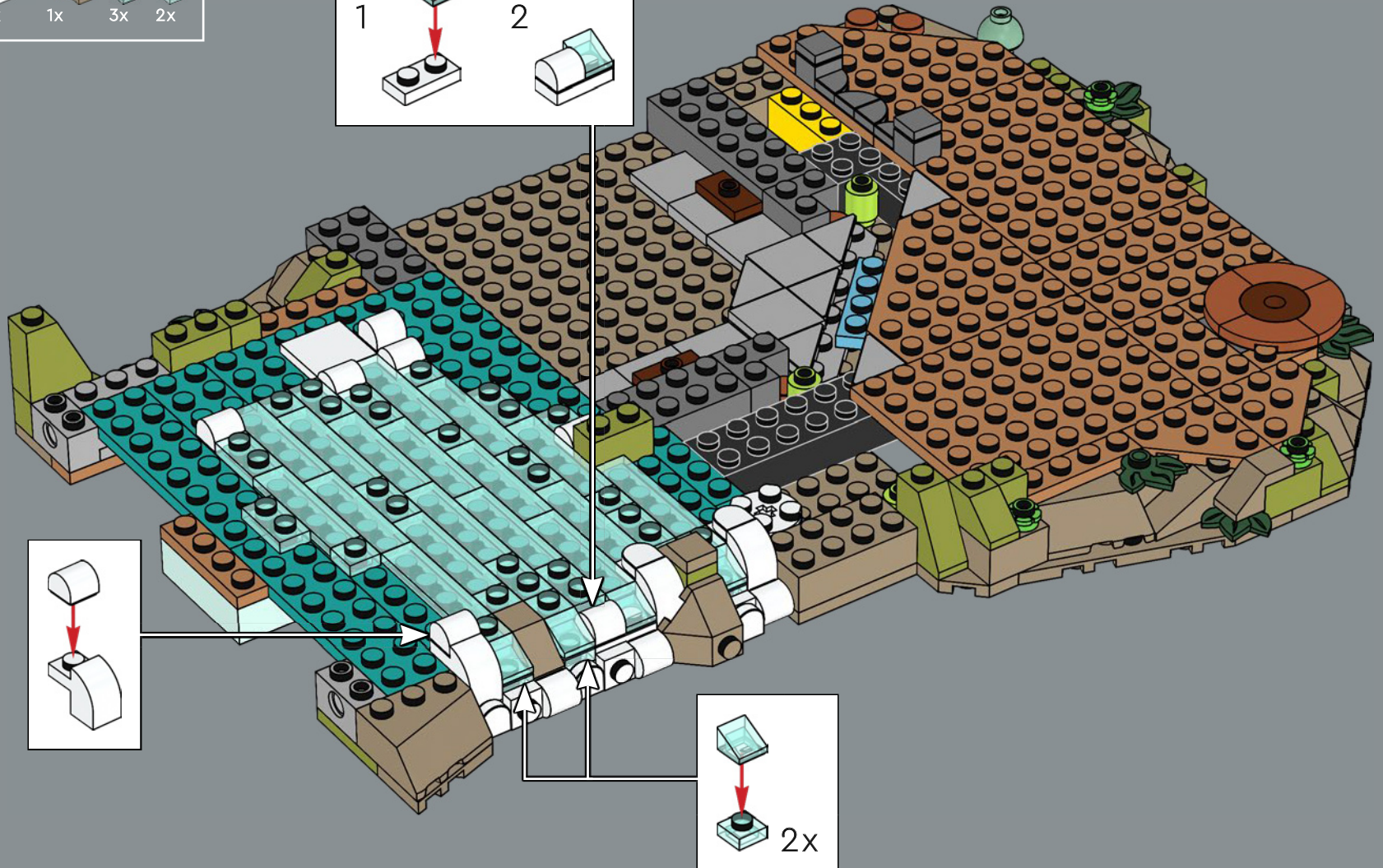
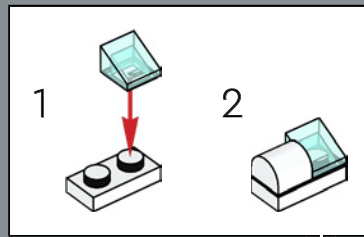



46

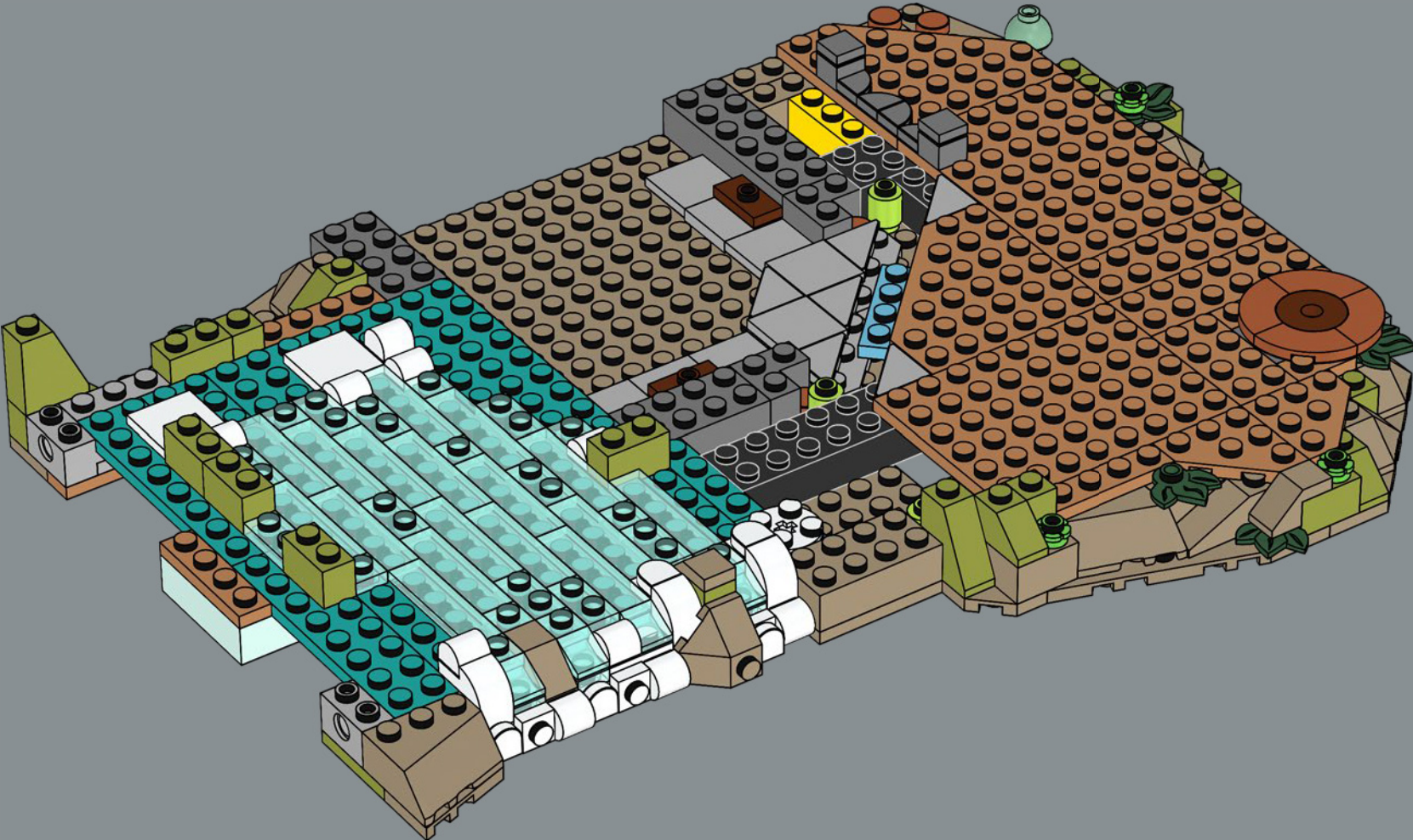

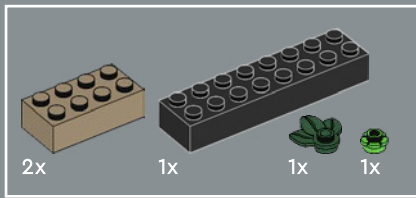

47



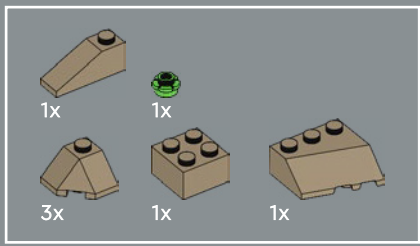

48

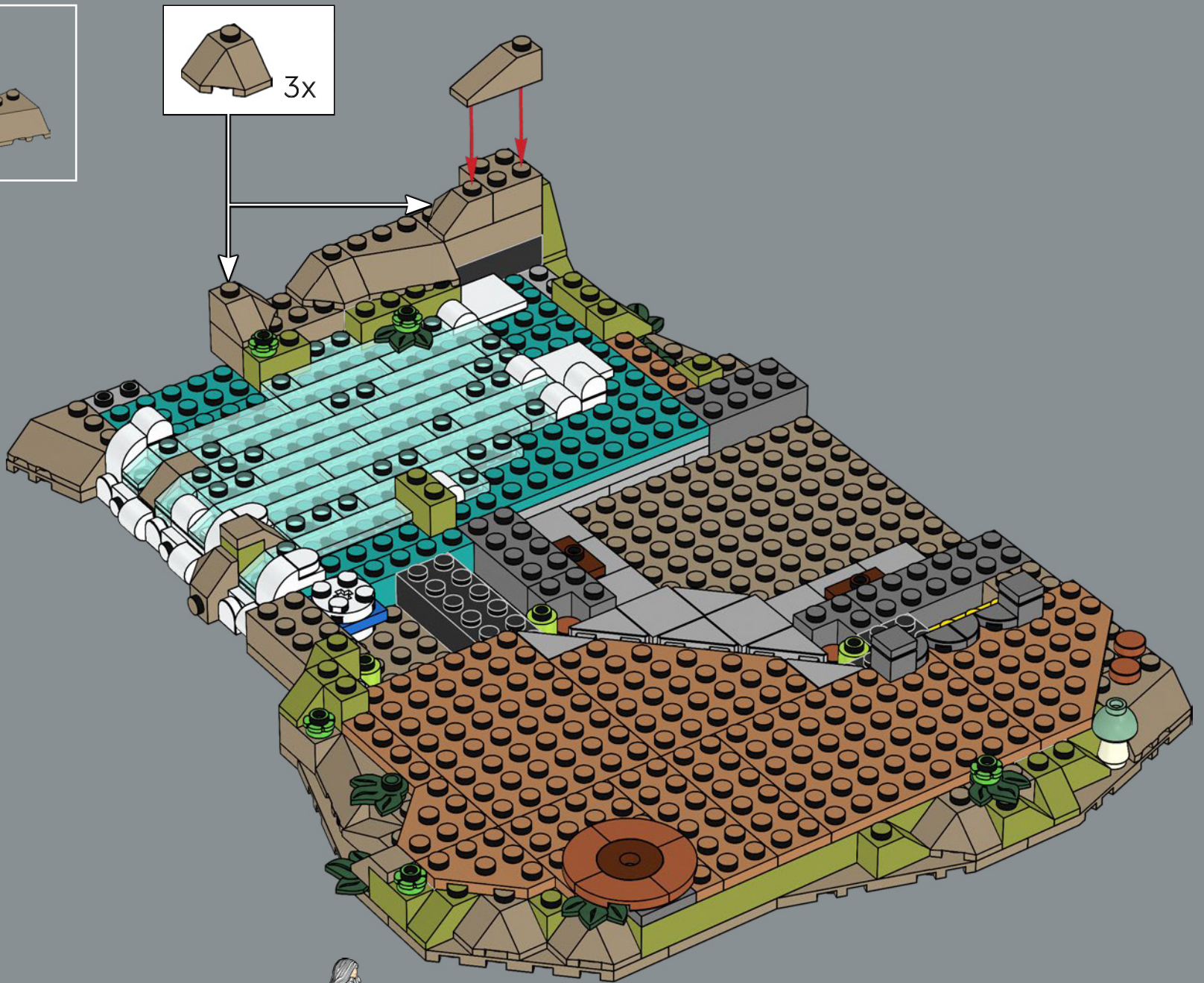

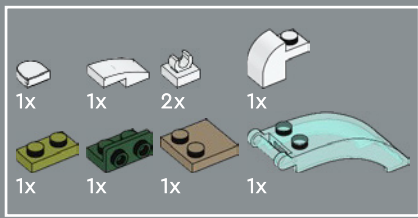

49

1

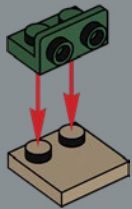

2

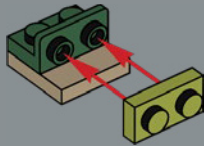

3

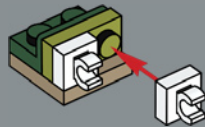

4



5



6

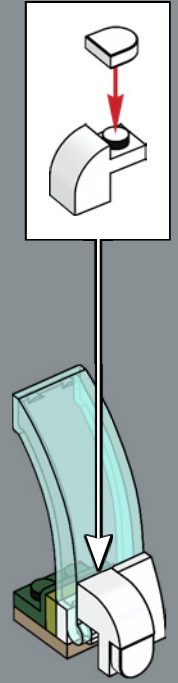

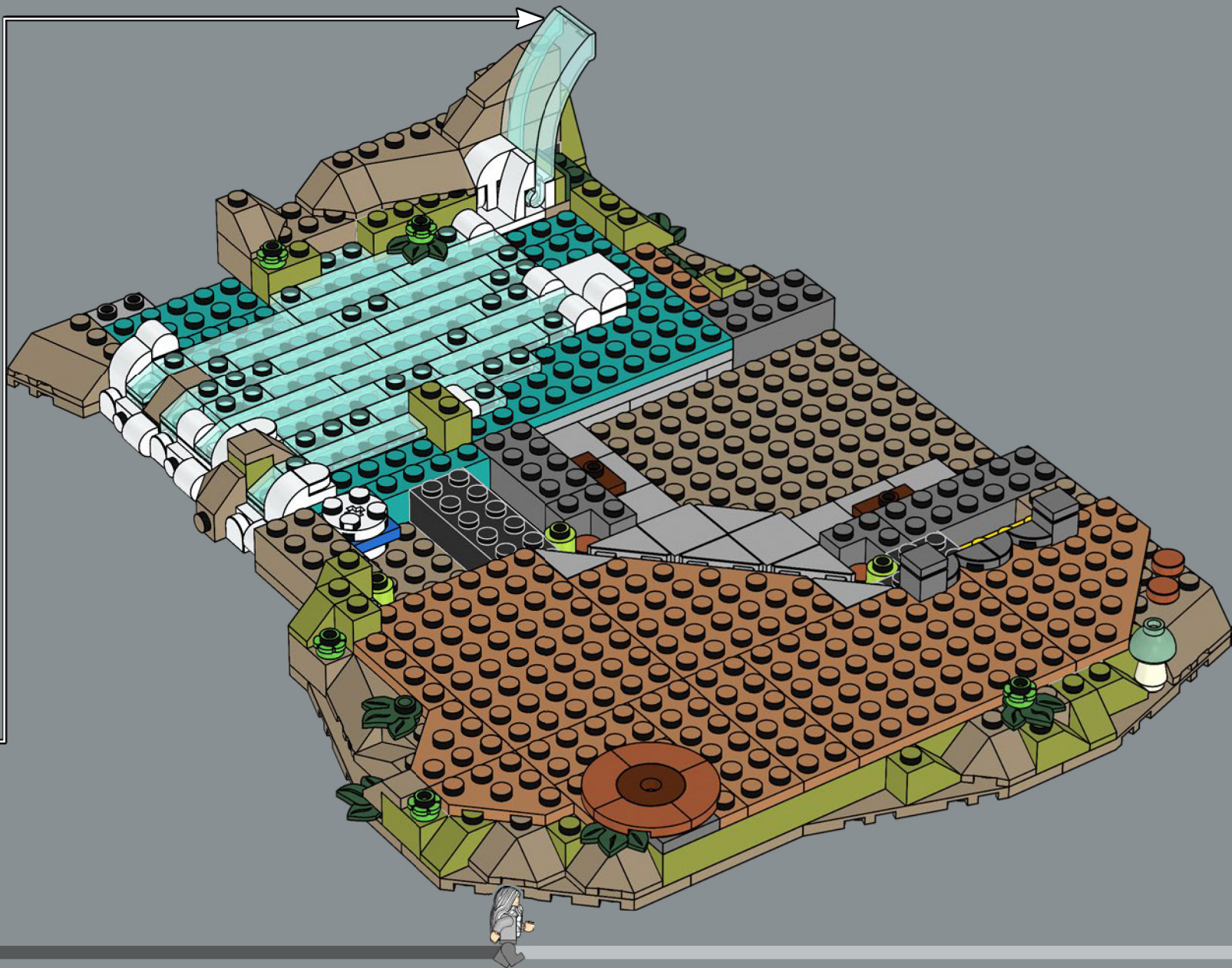

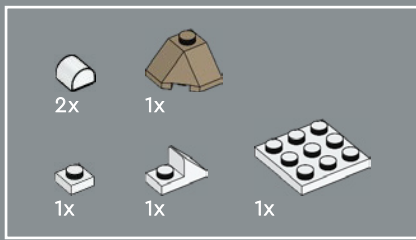

50

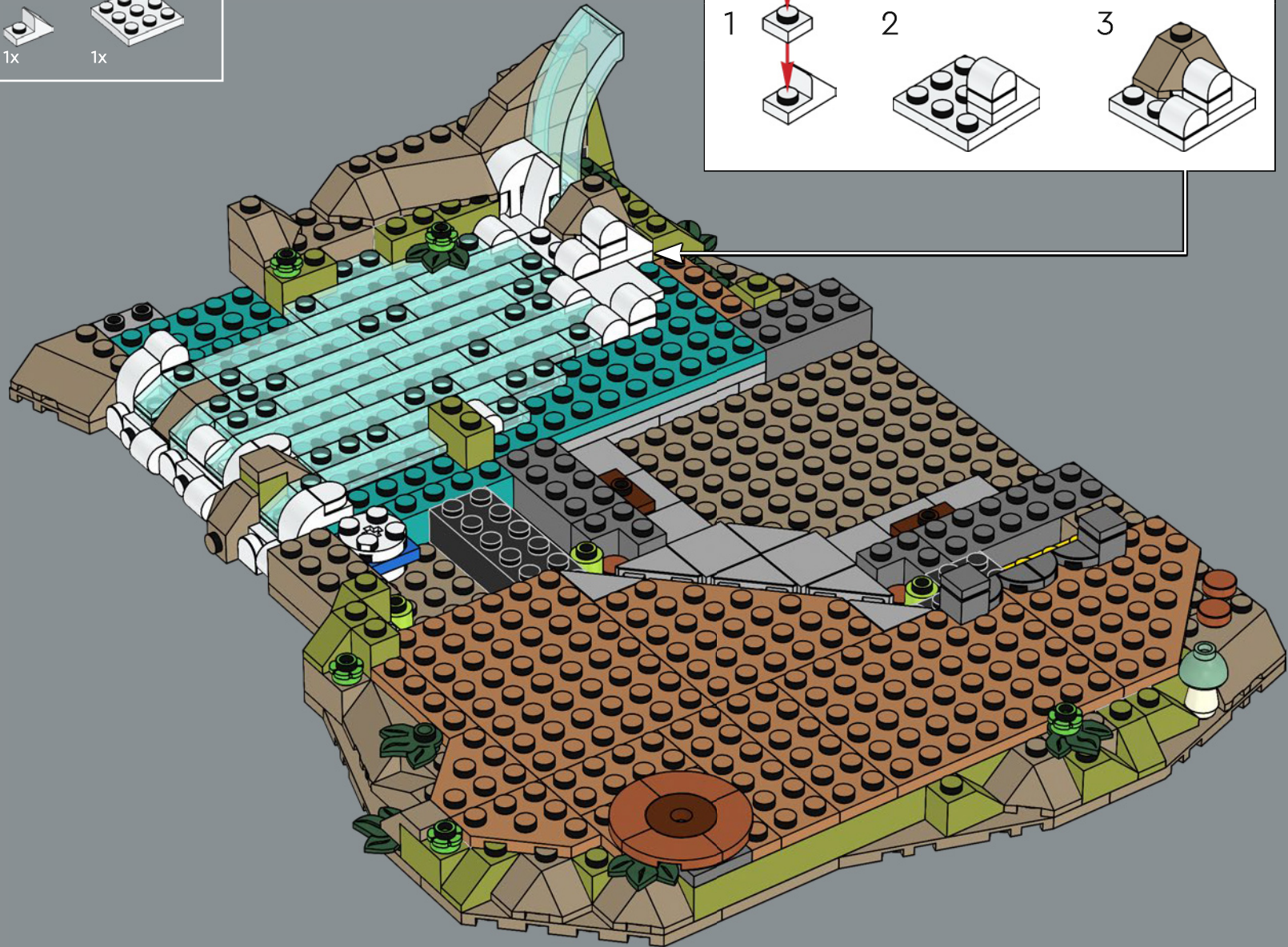
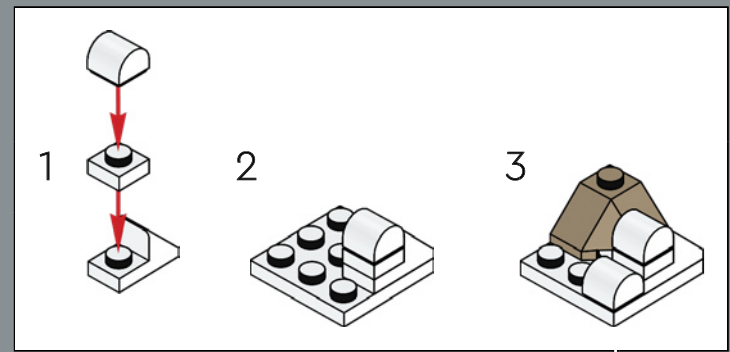

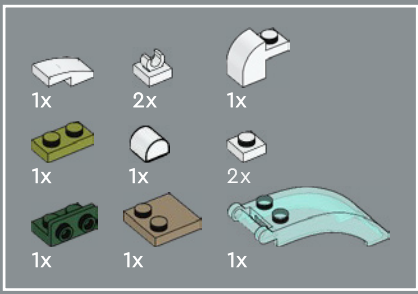

51

1

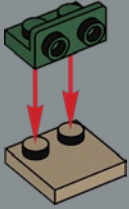

2

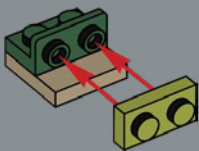

3

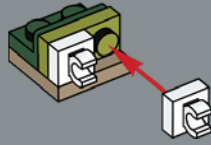

4



5

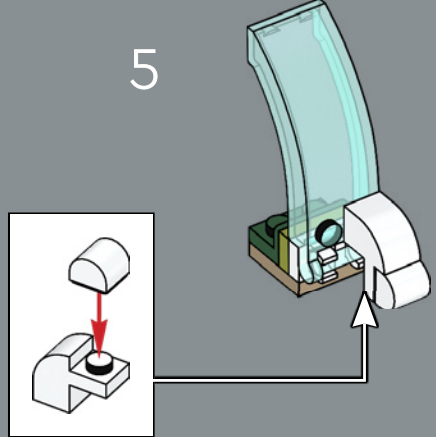

6

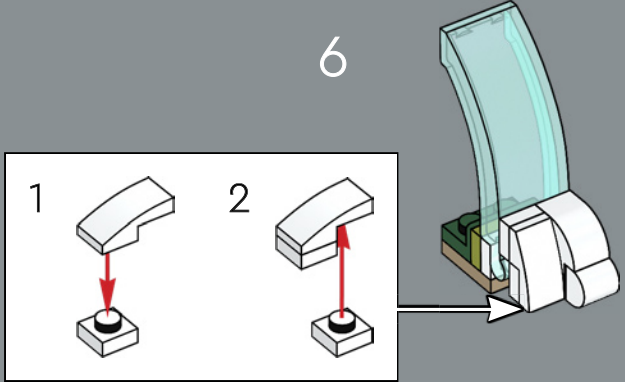

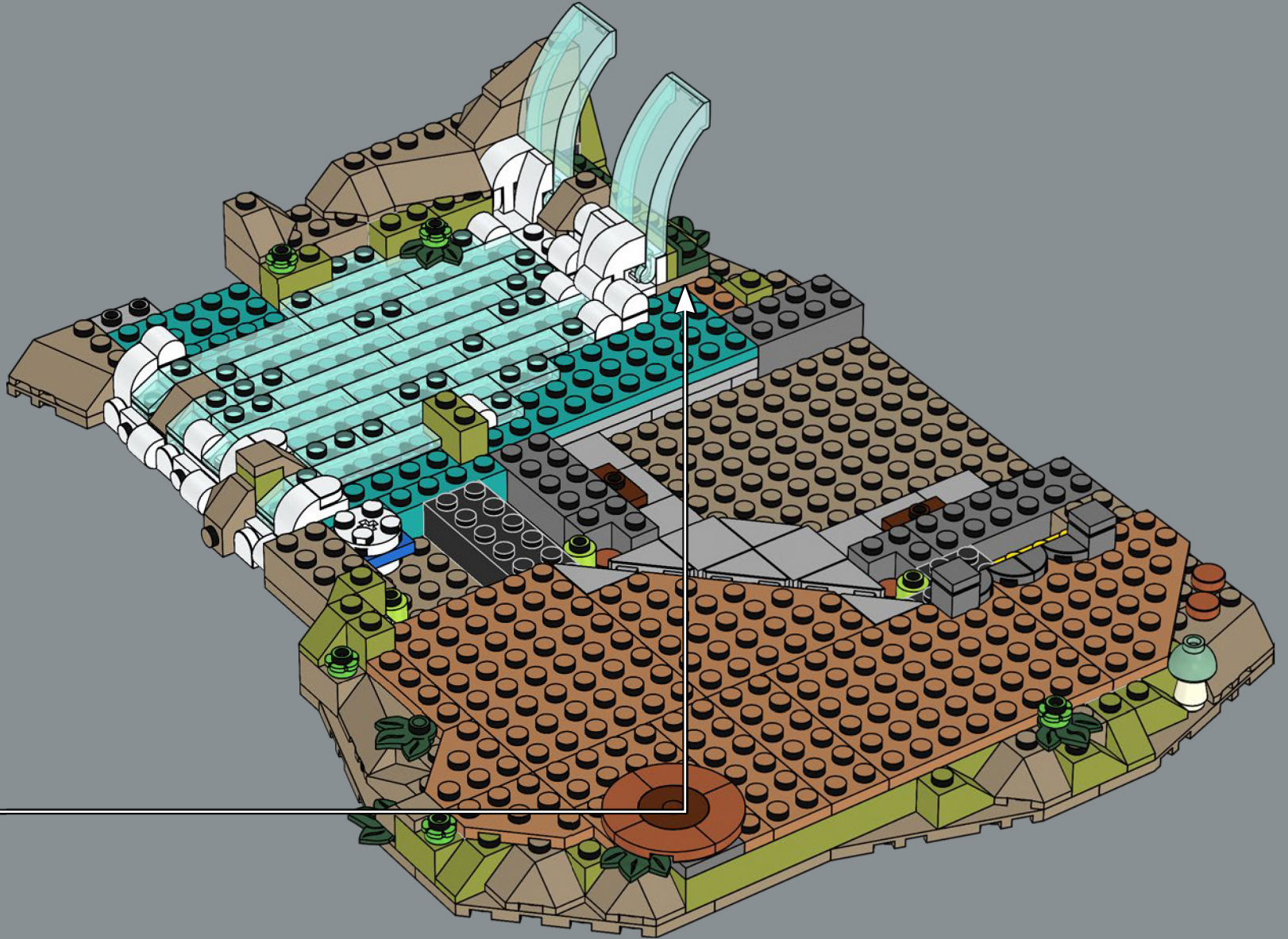

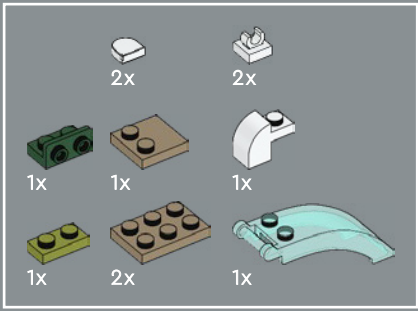

52

1

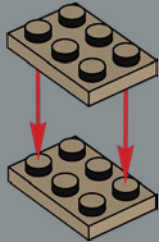

2

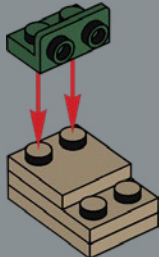

3

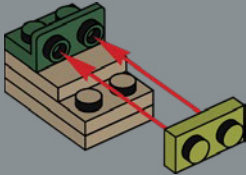

4

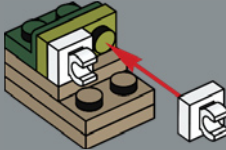

5

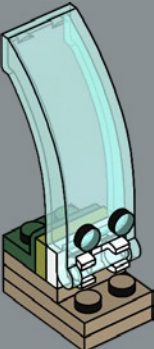

6

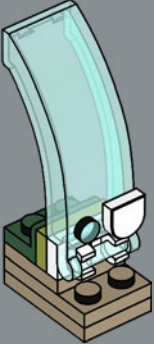

7

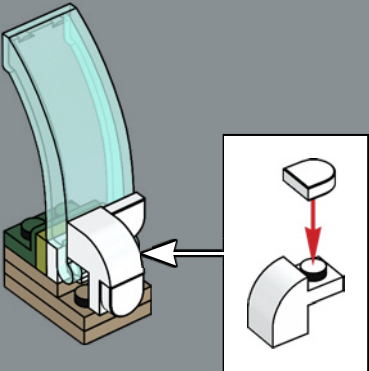

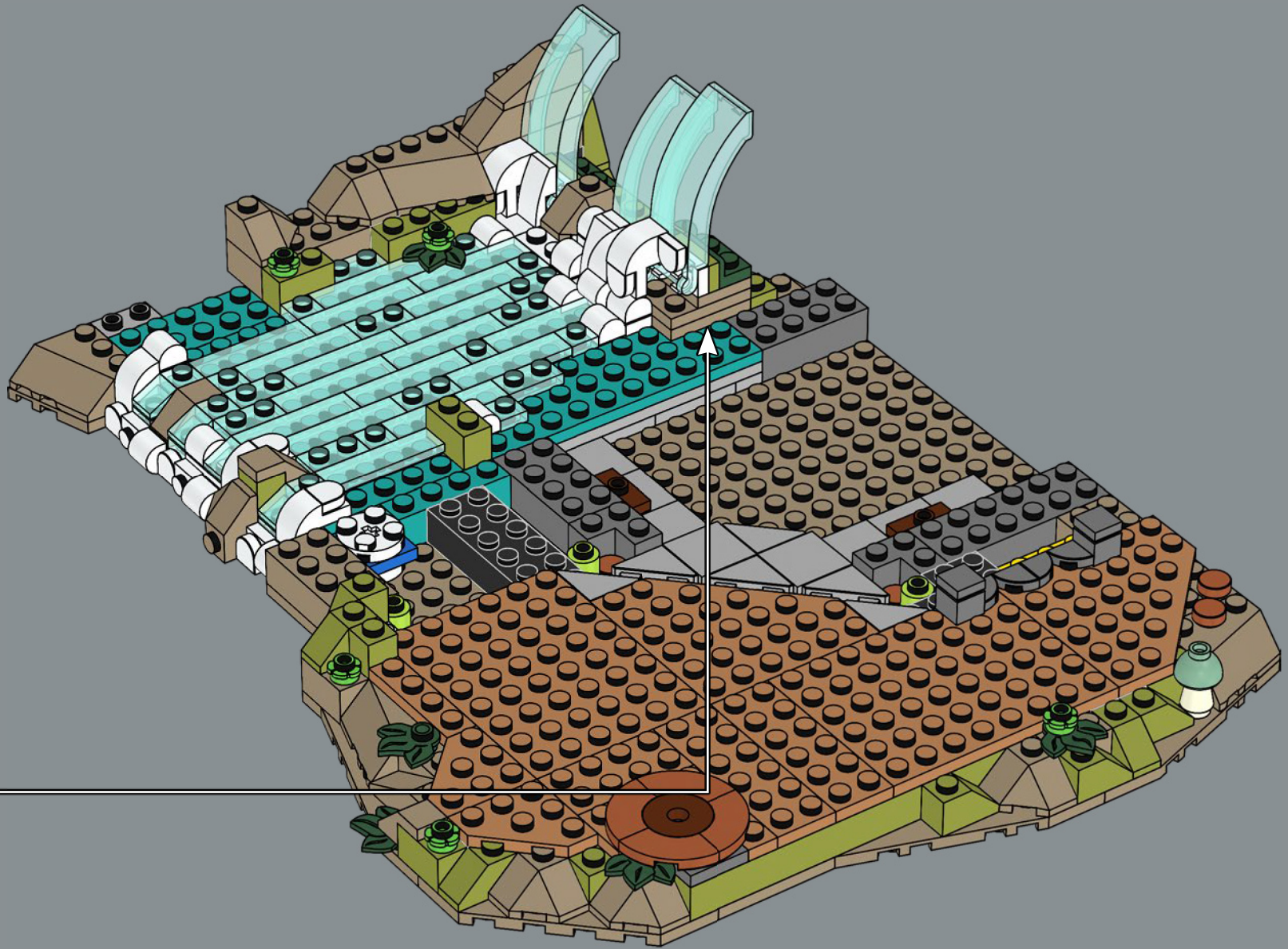

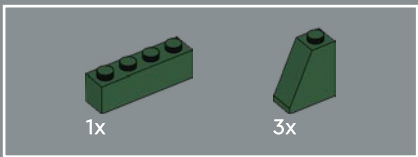

53

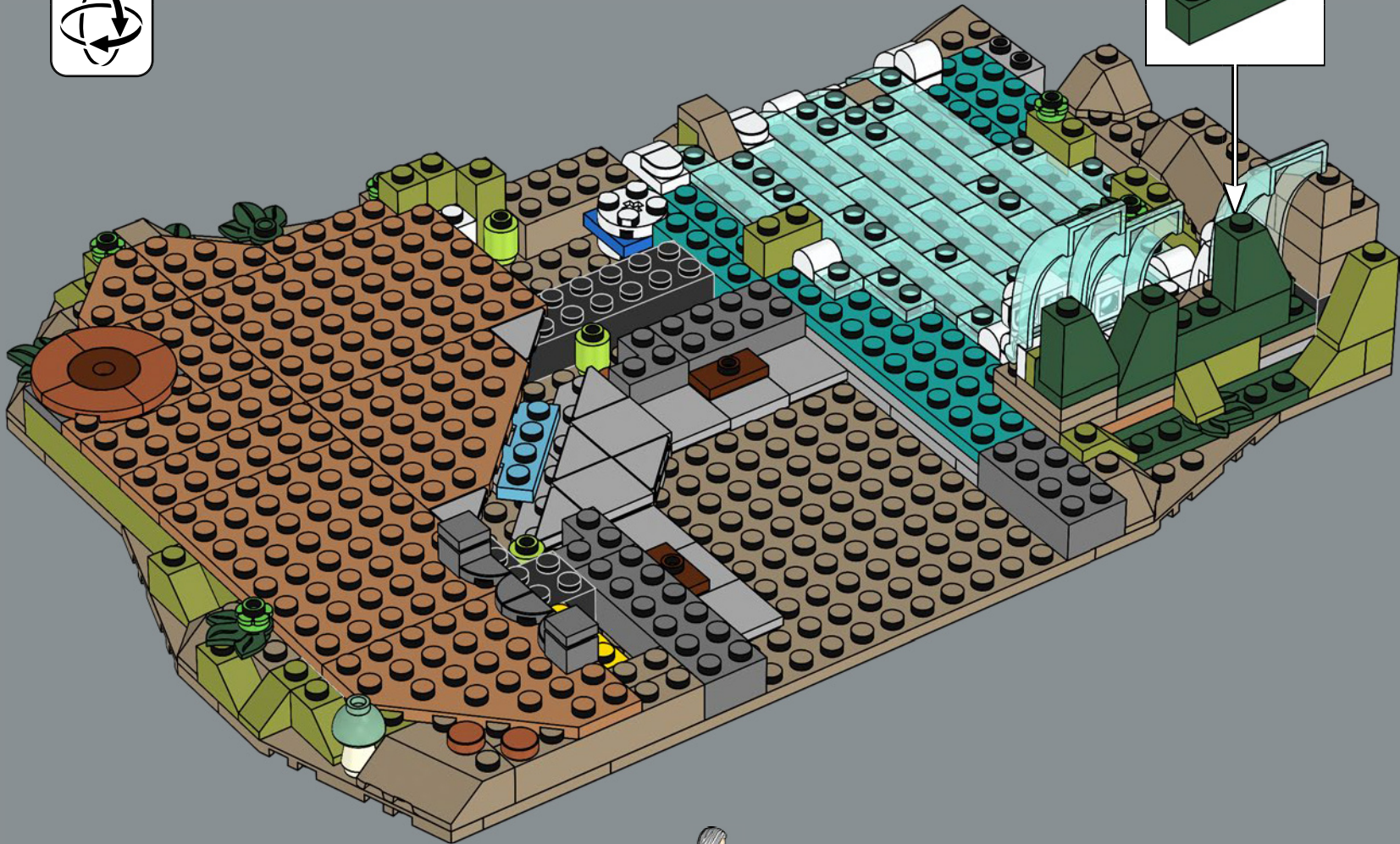
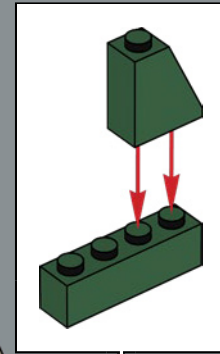



54

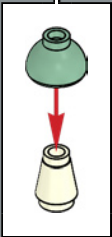
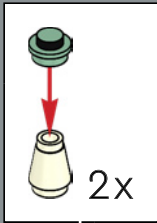
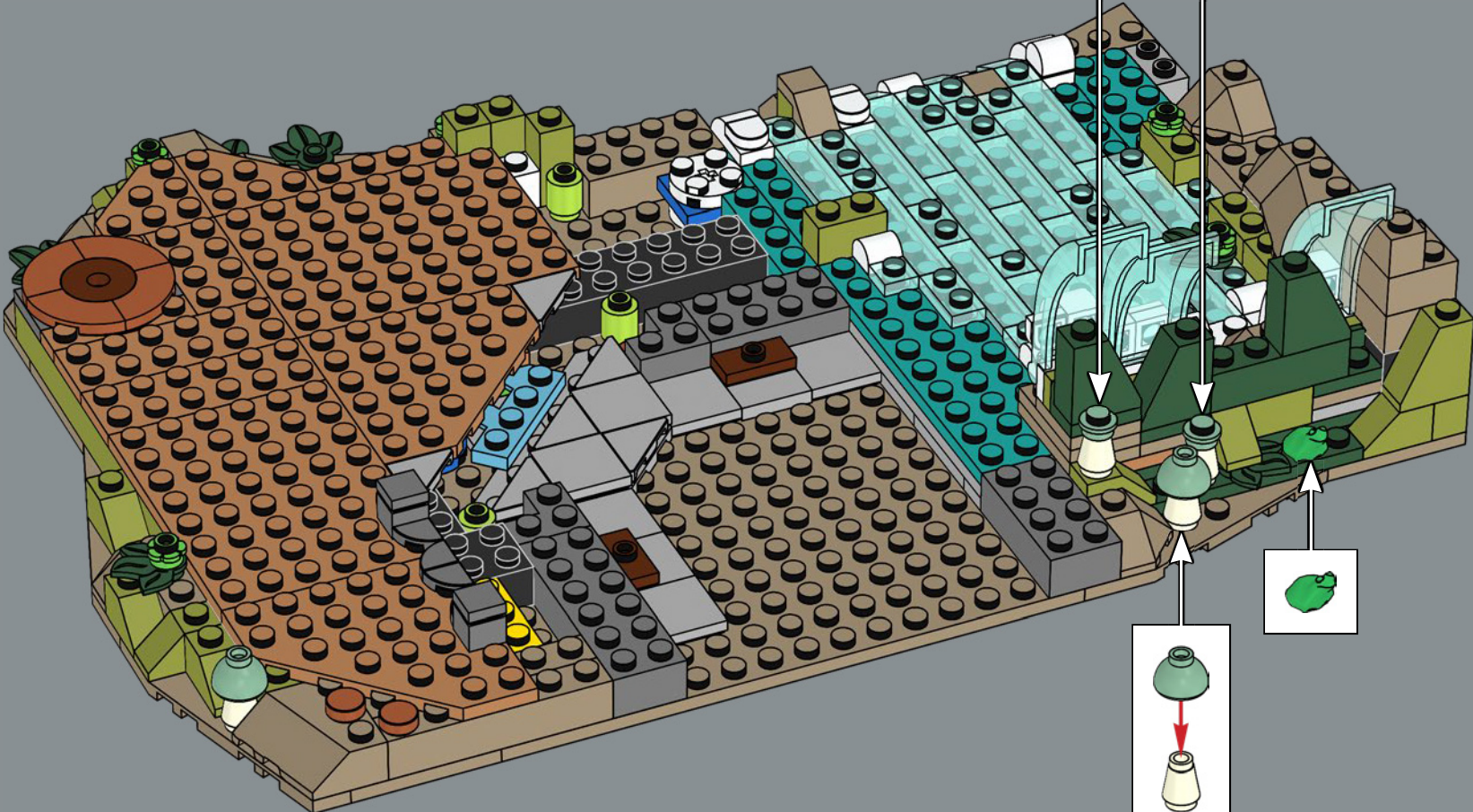

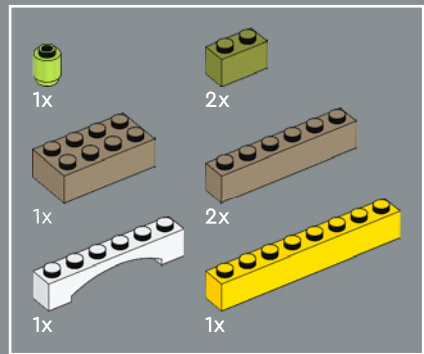

55

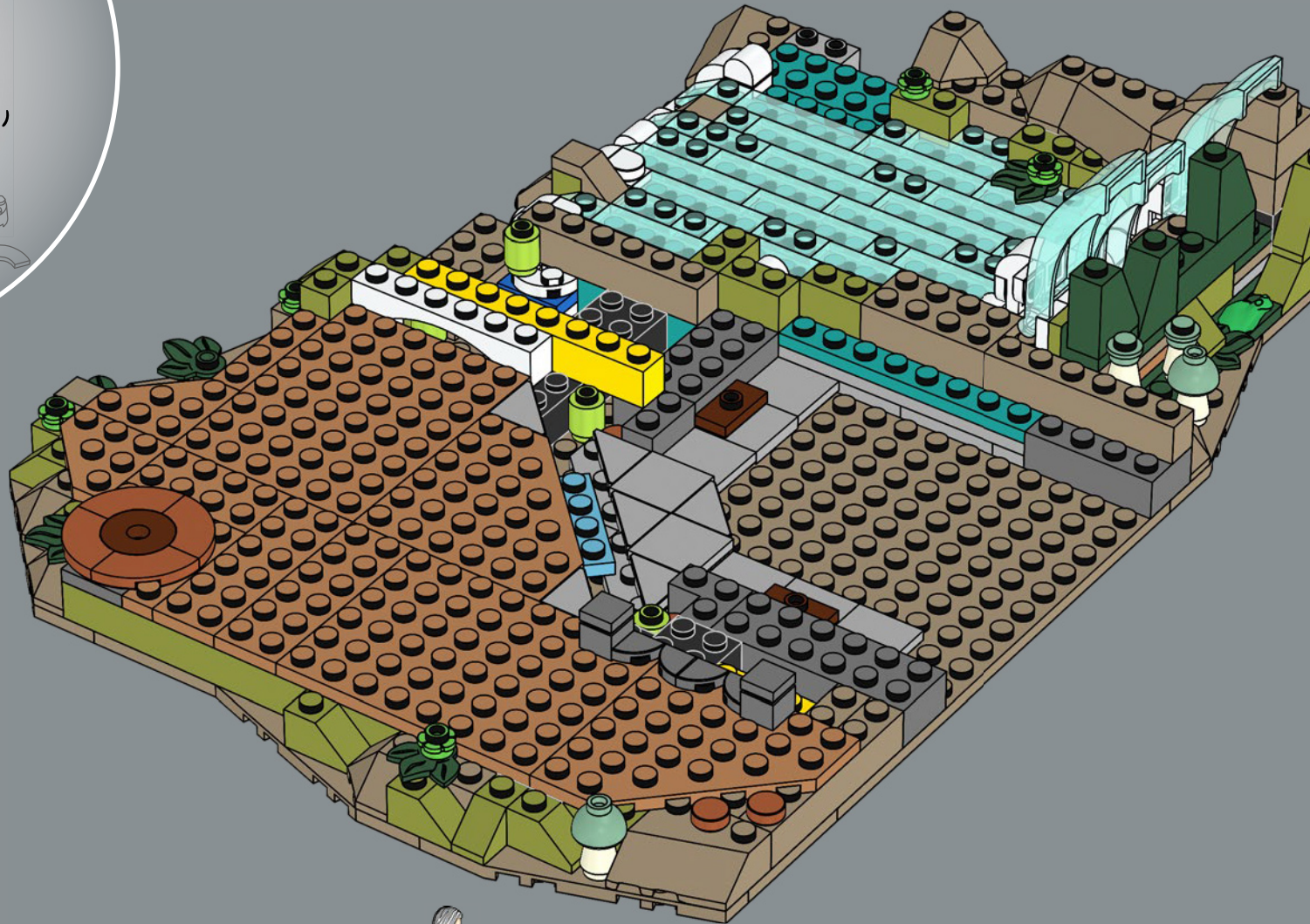

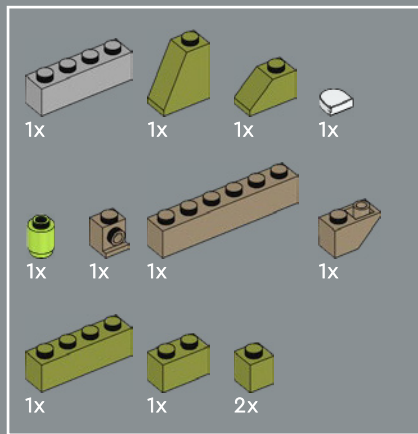

56

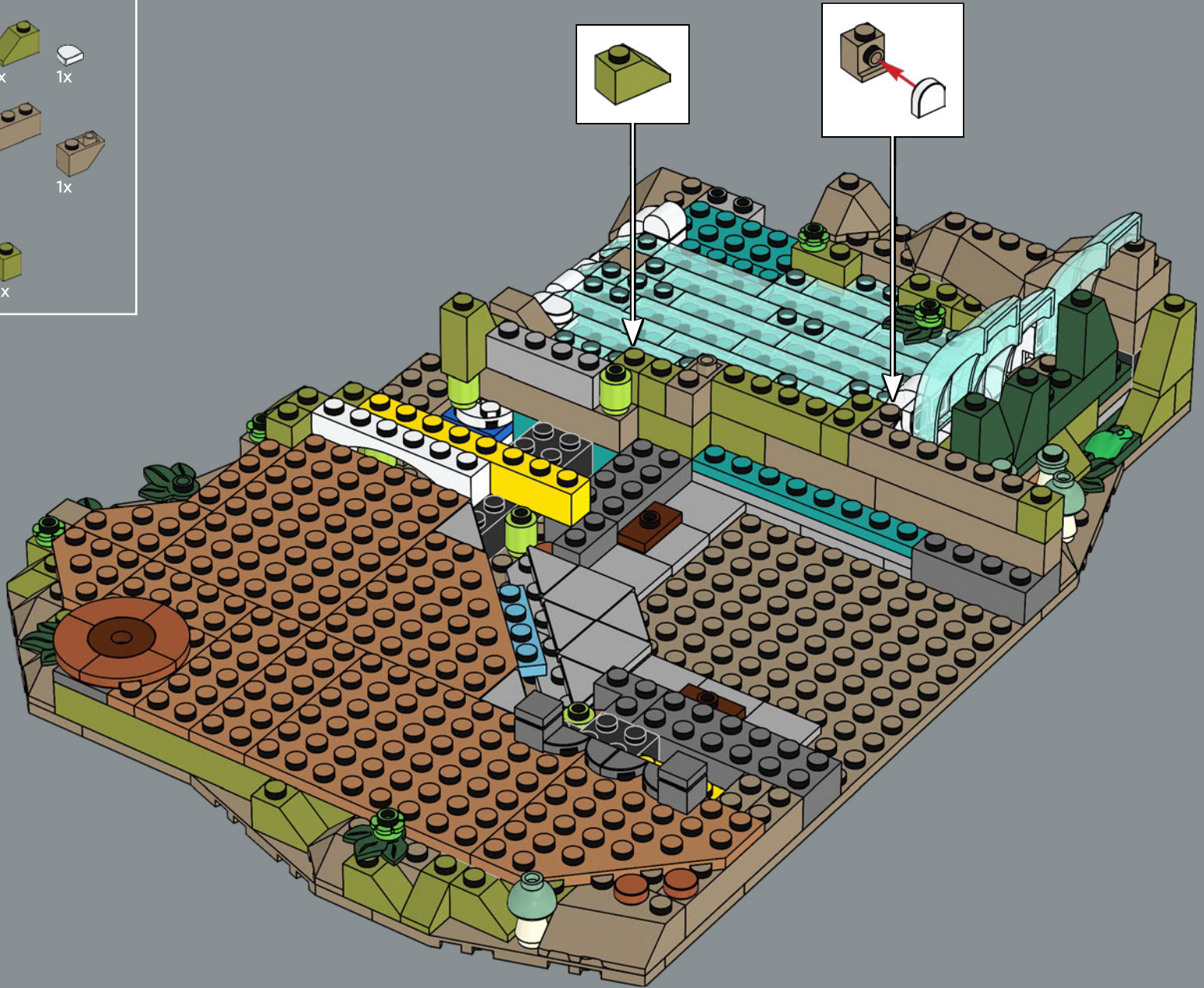

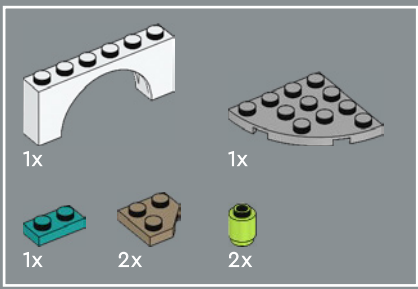

57

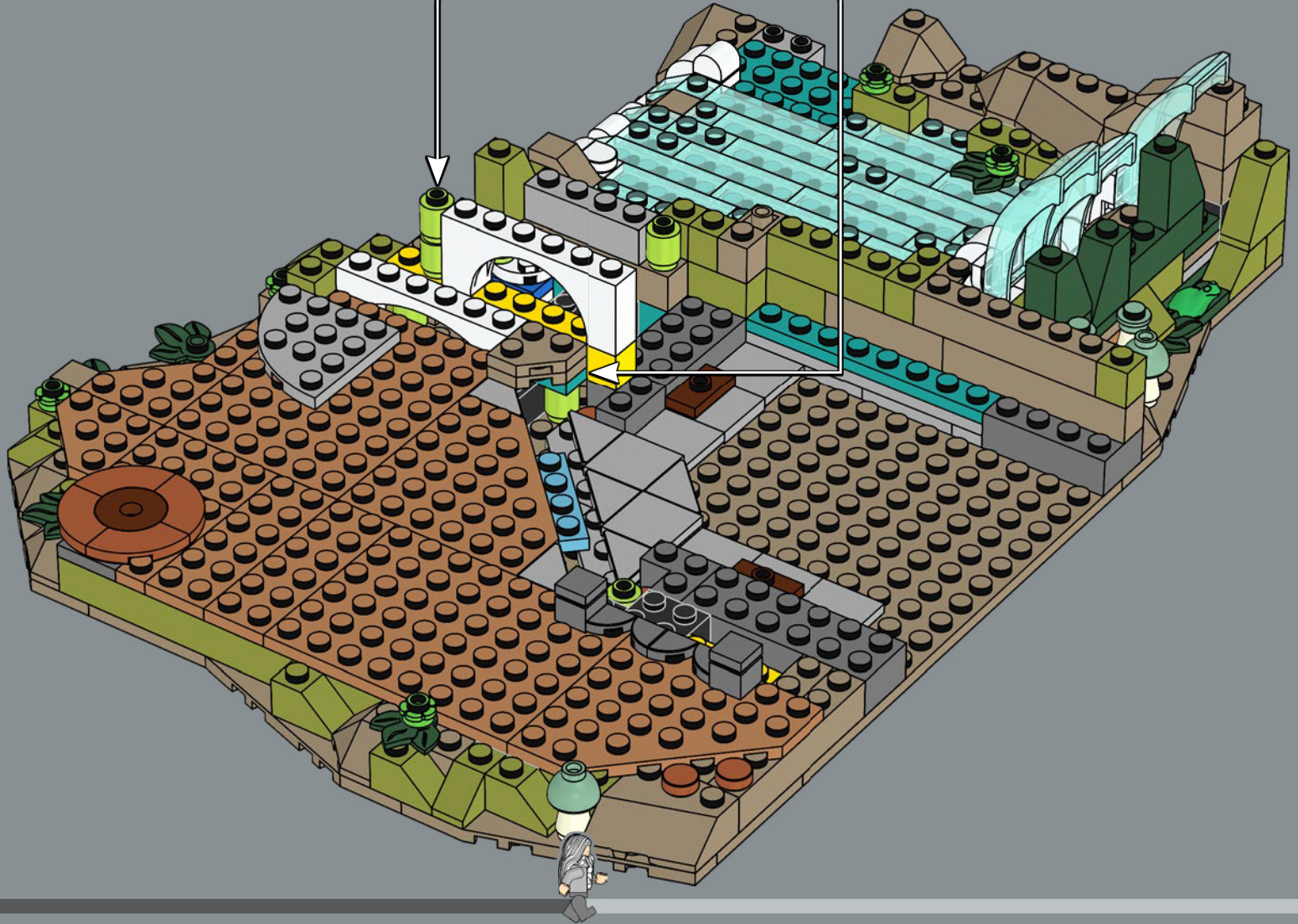
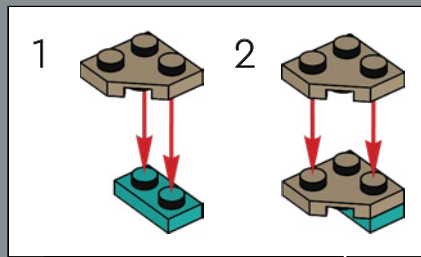
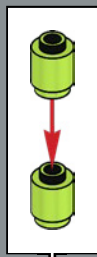

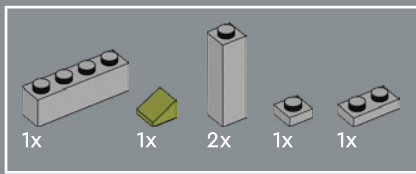

58

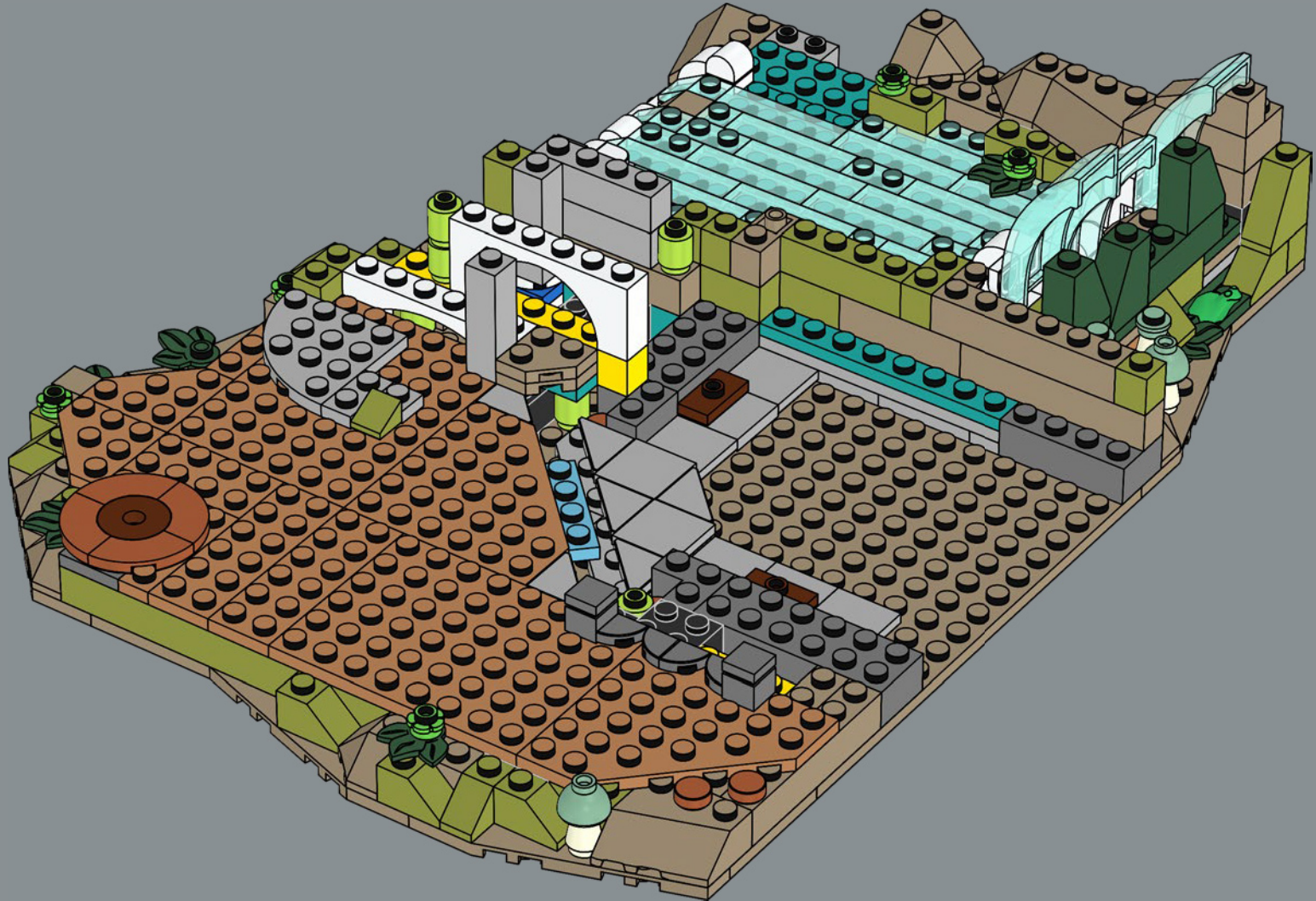

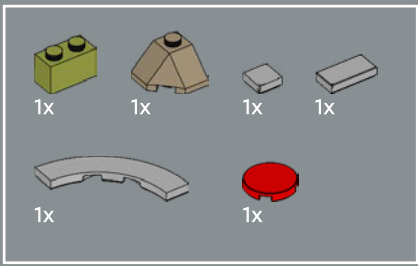

59

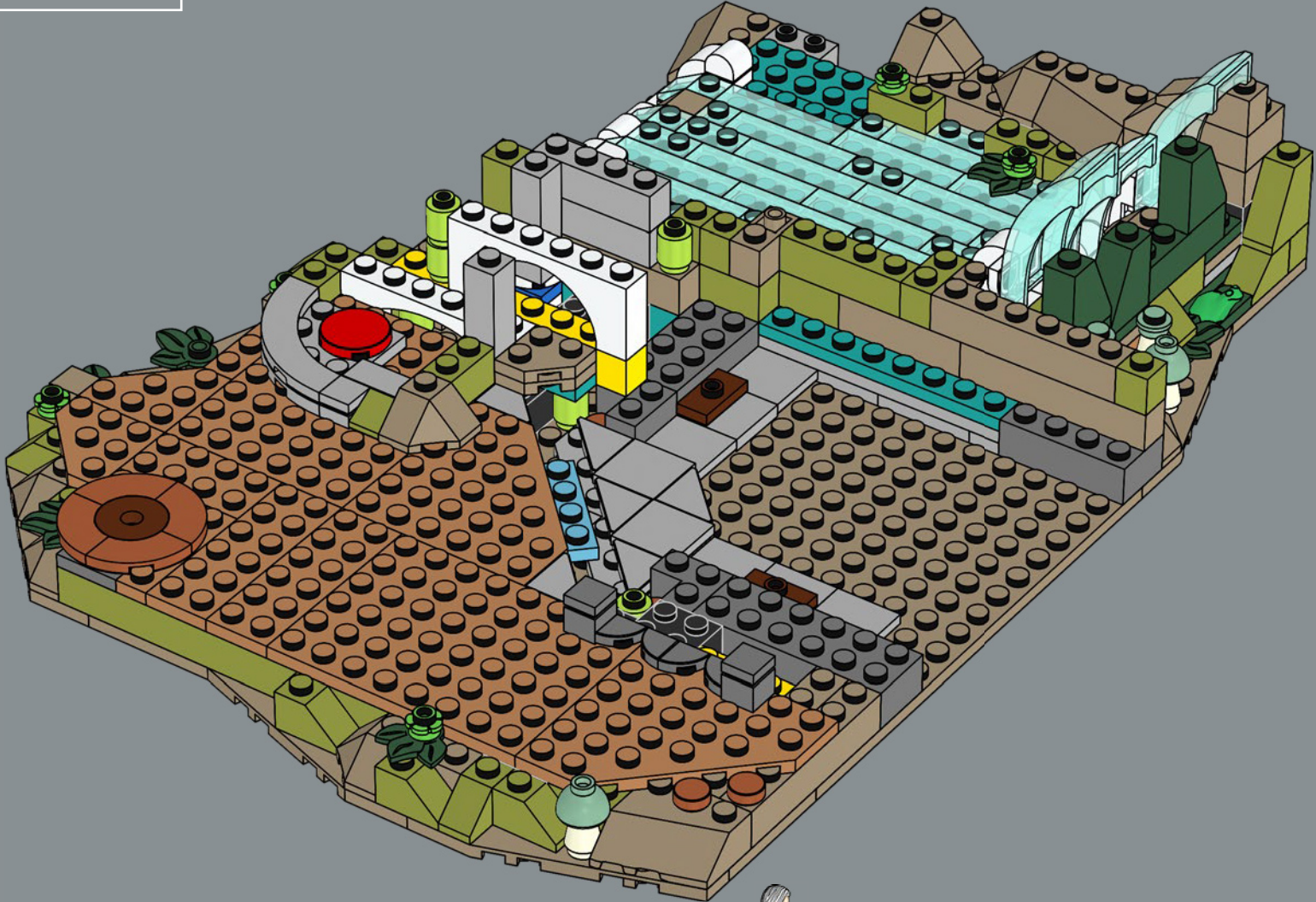

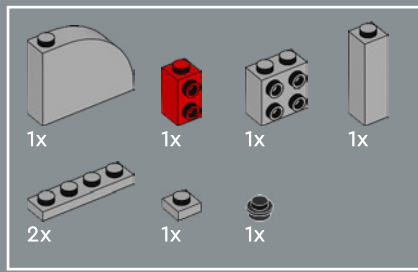

60

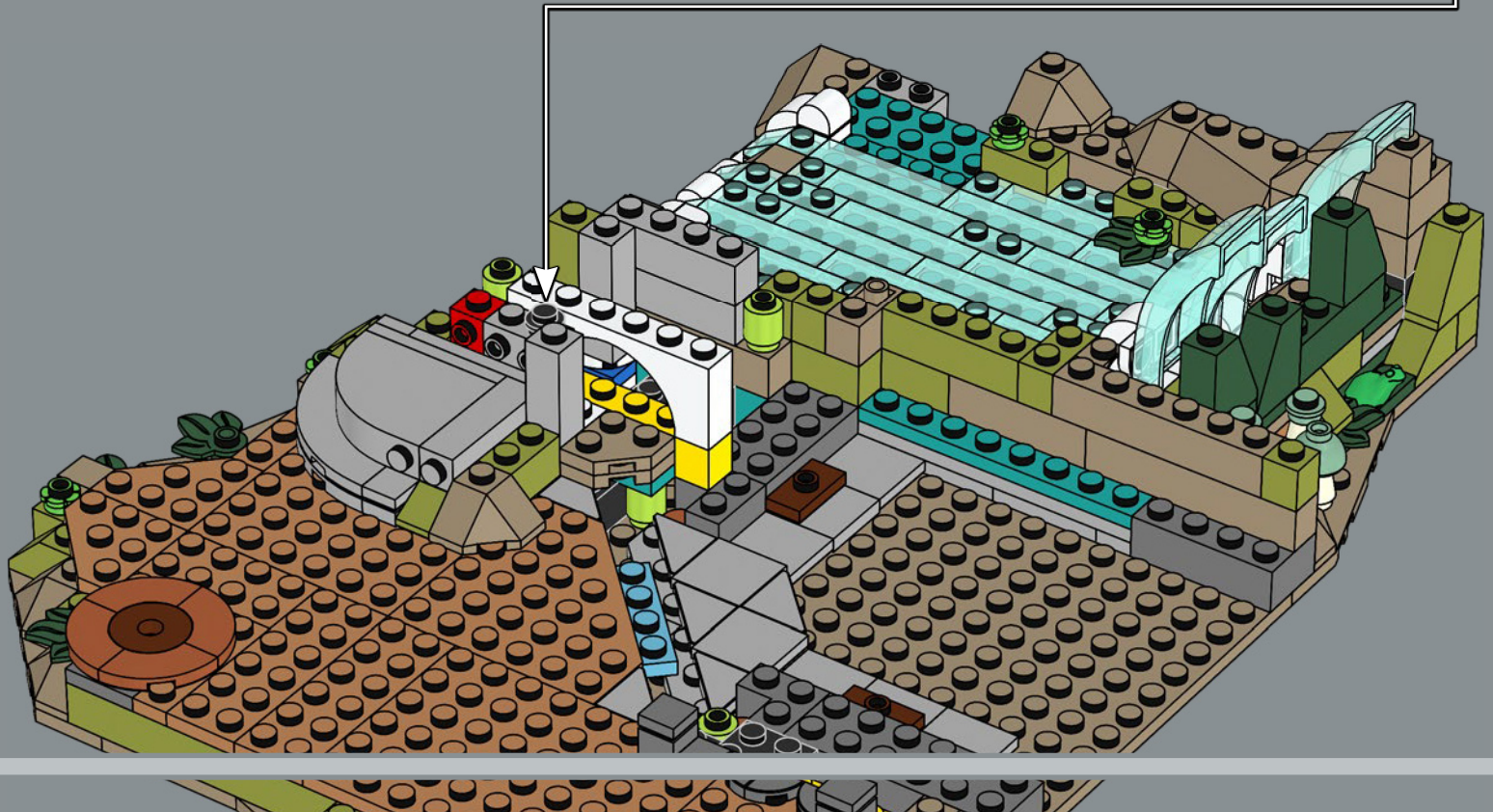
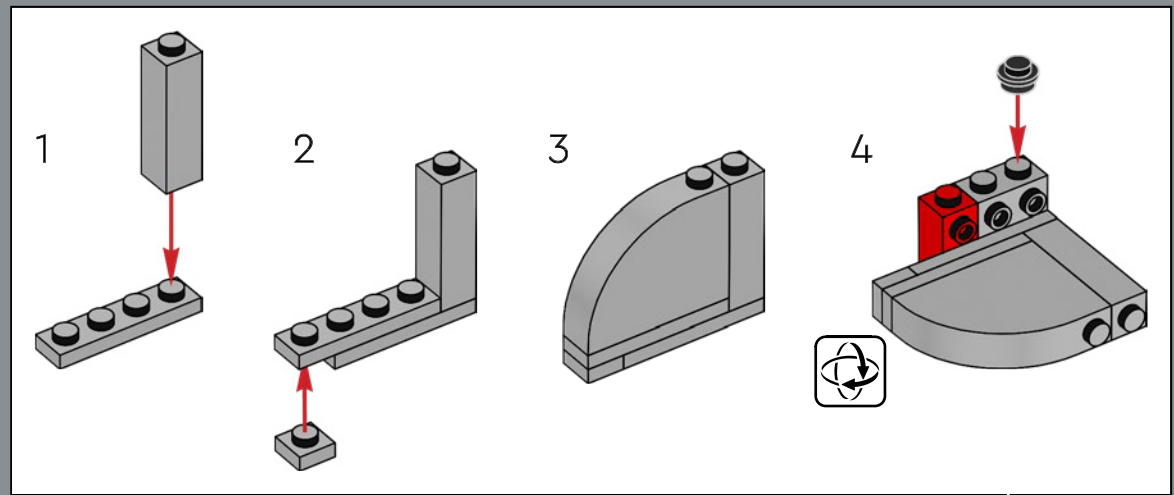

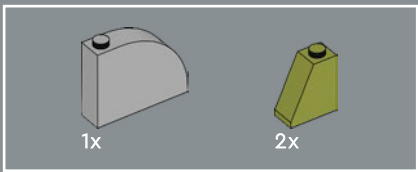

61

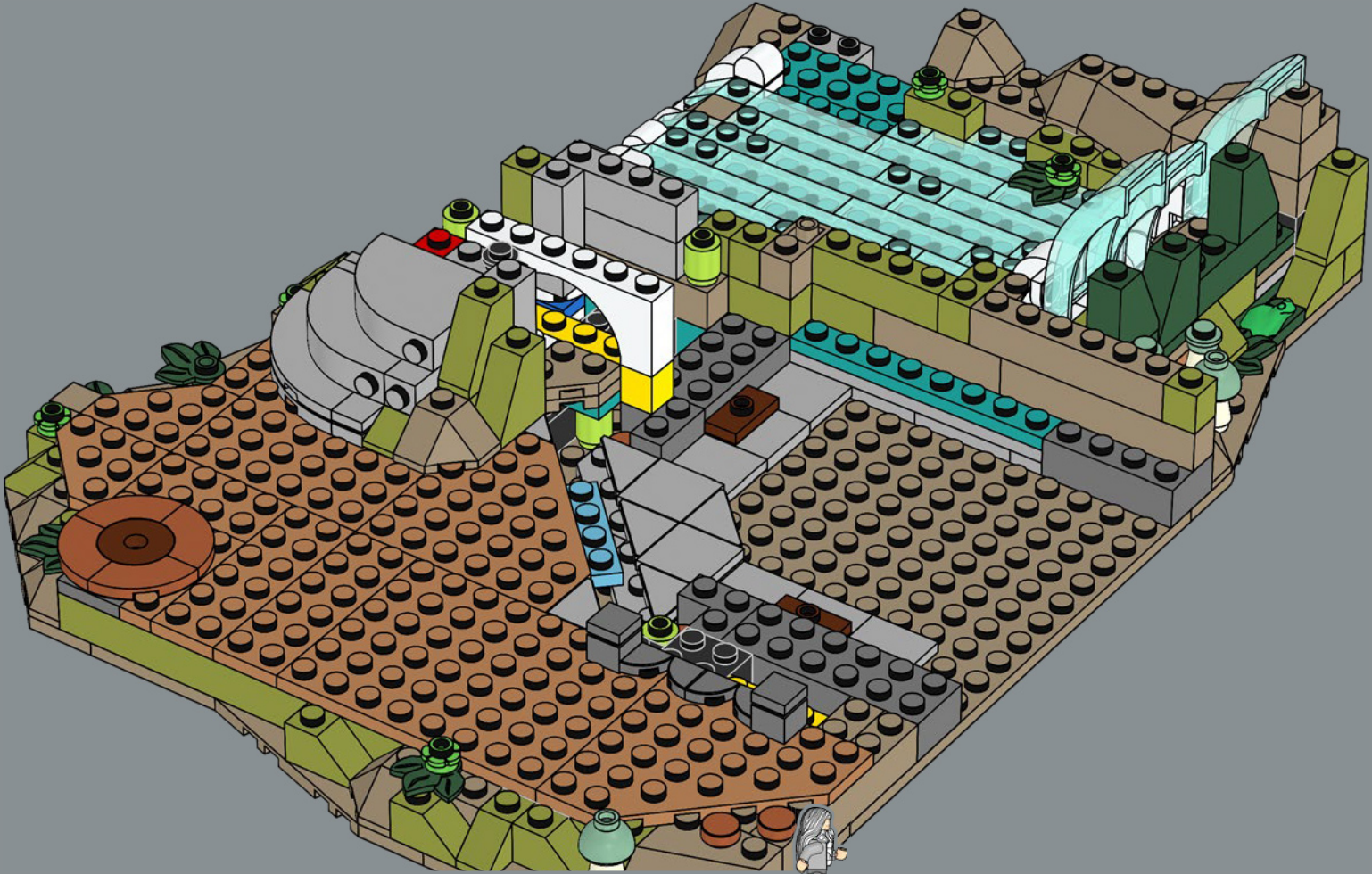

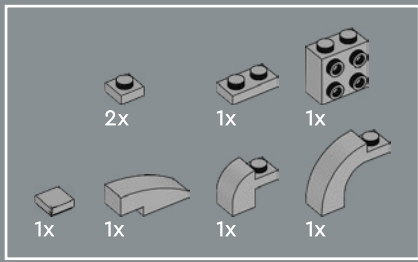

62

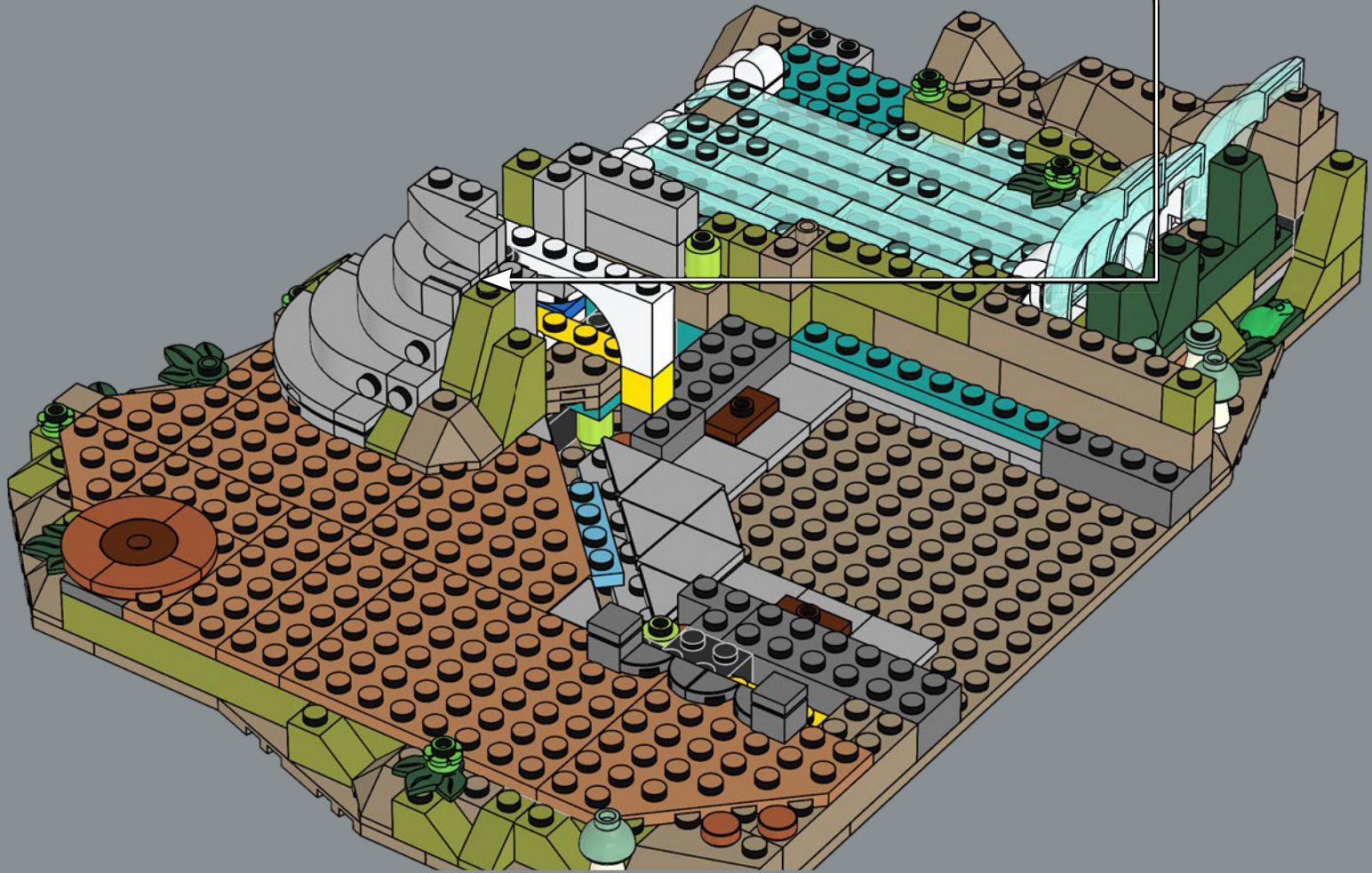
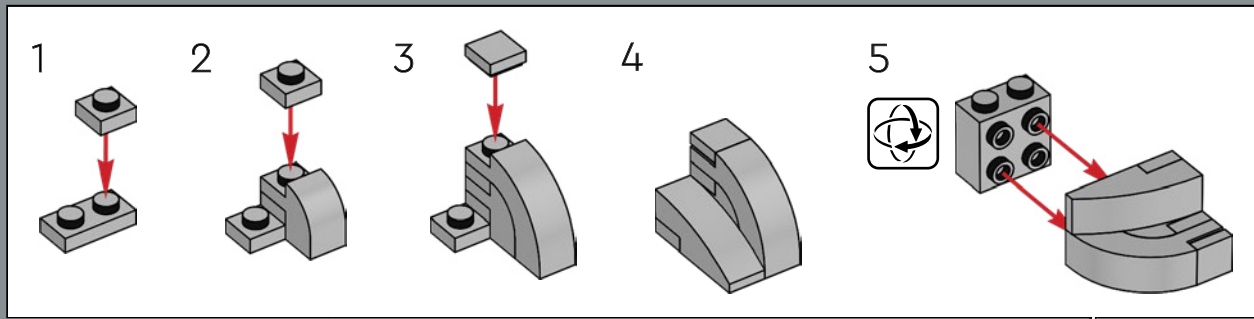

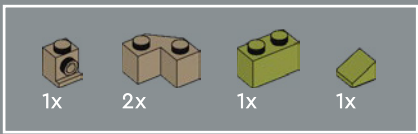

63

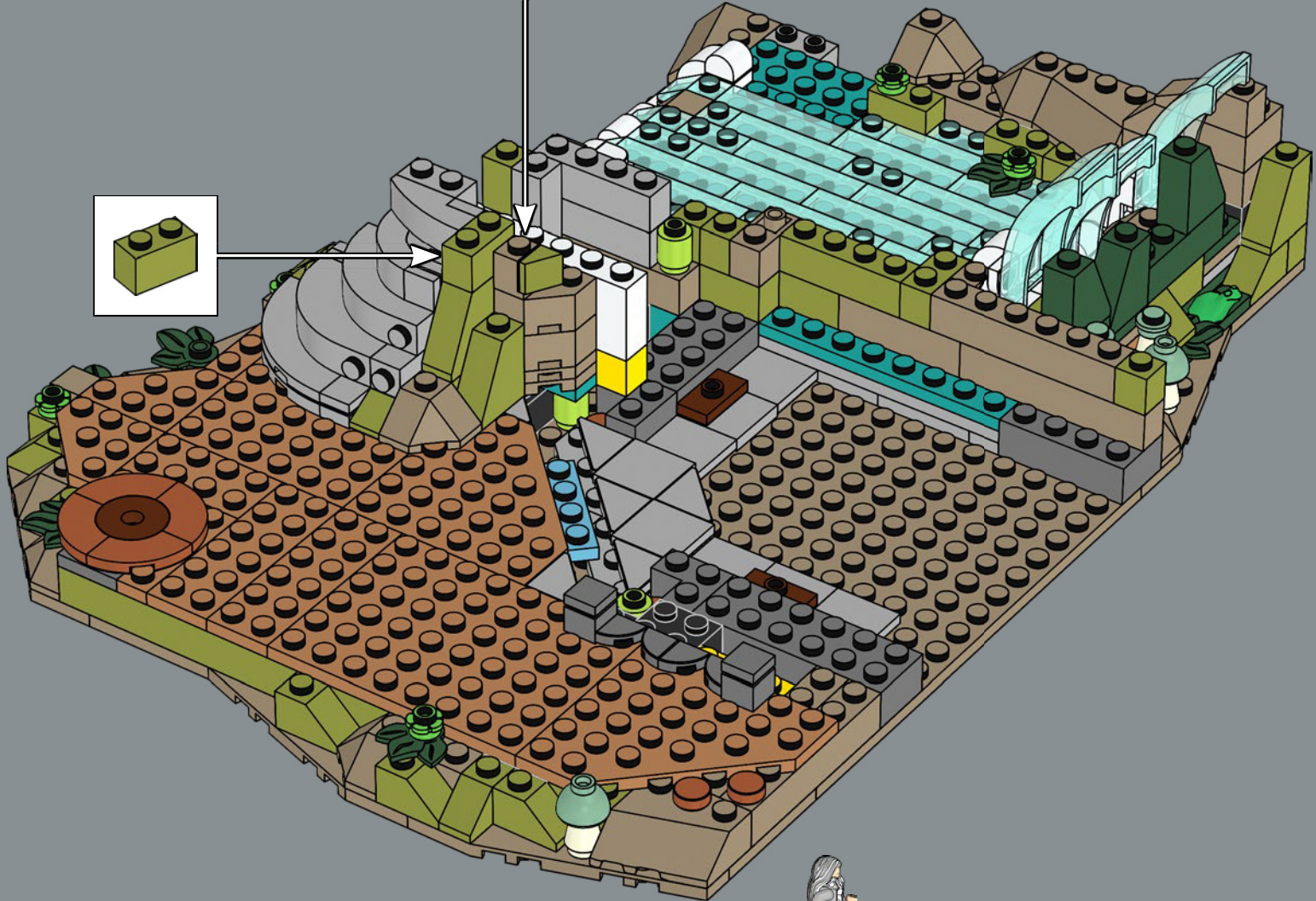
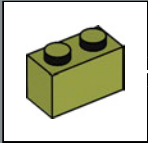
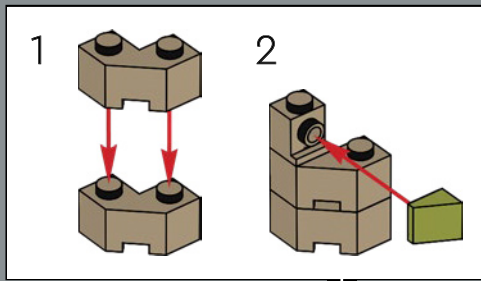

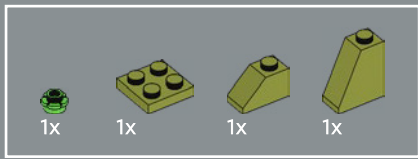

64

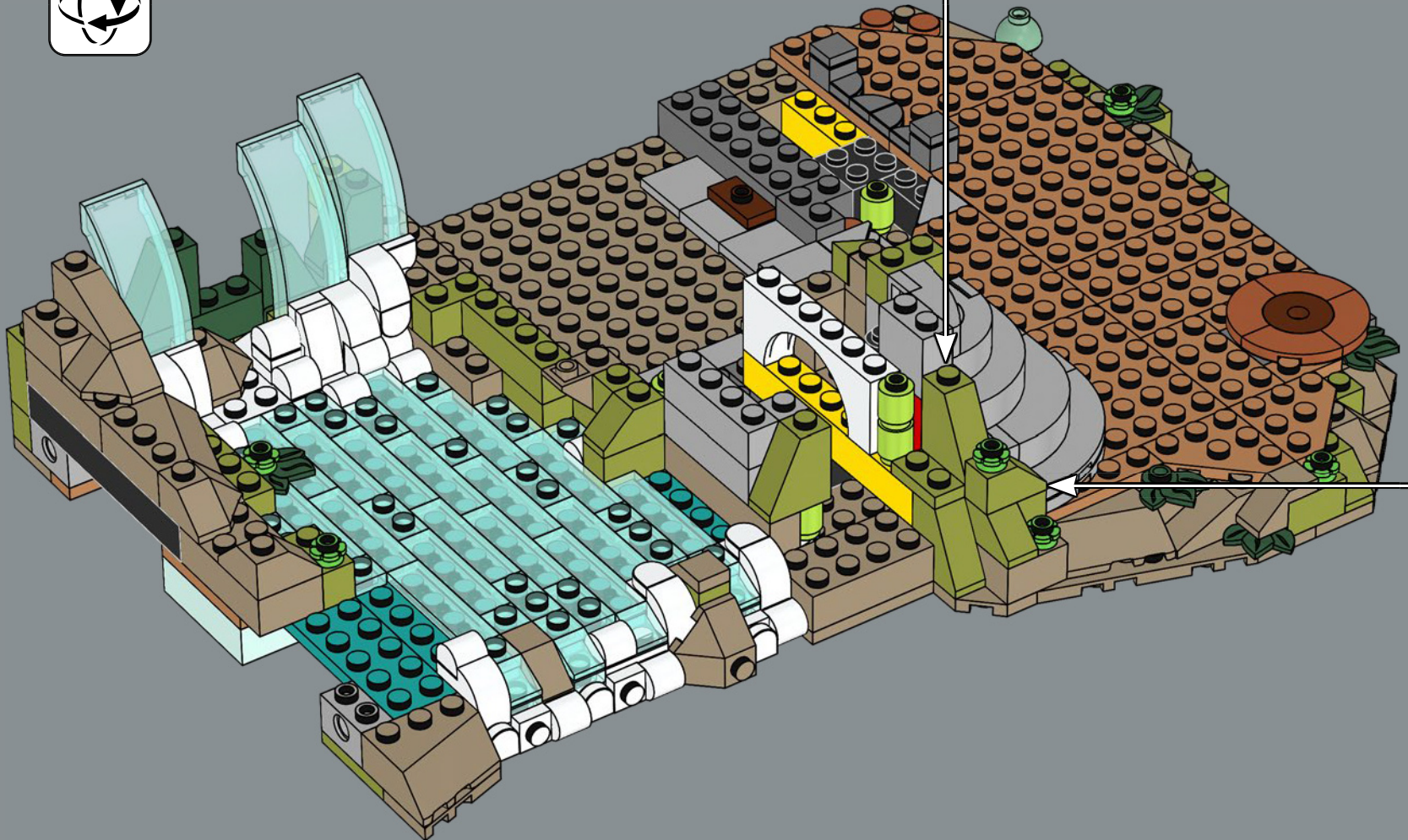
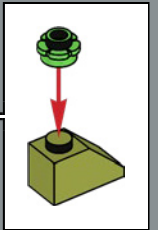
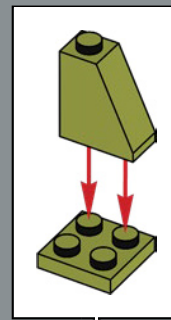

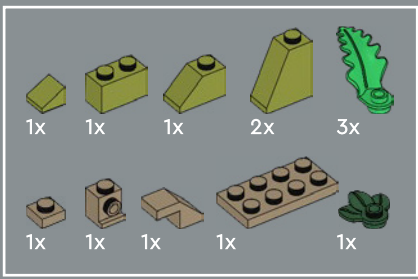

65

1

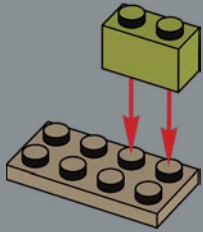

2

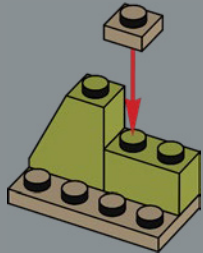

3

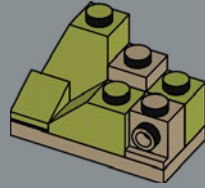

4

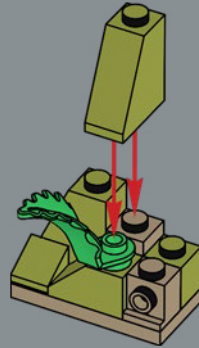

5

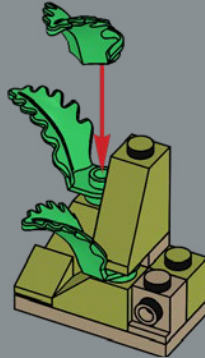

6

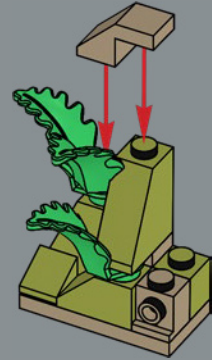

7

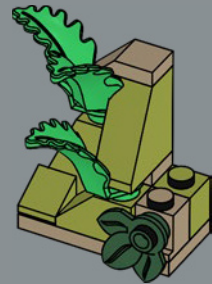

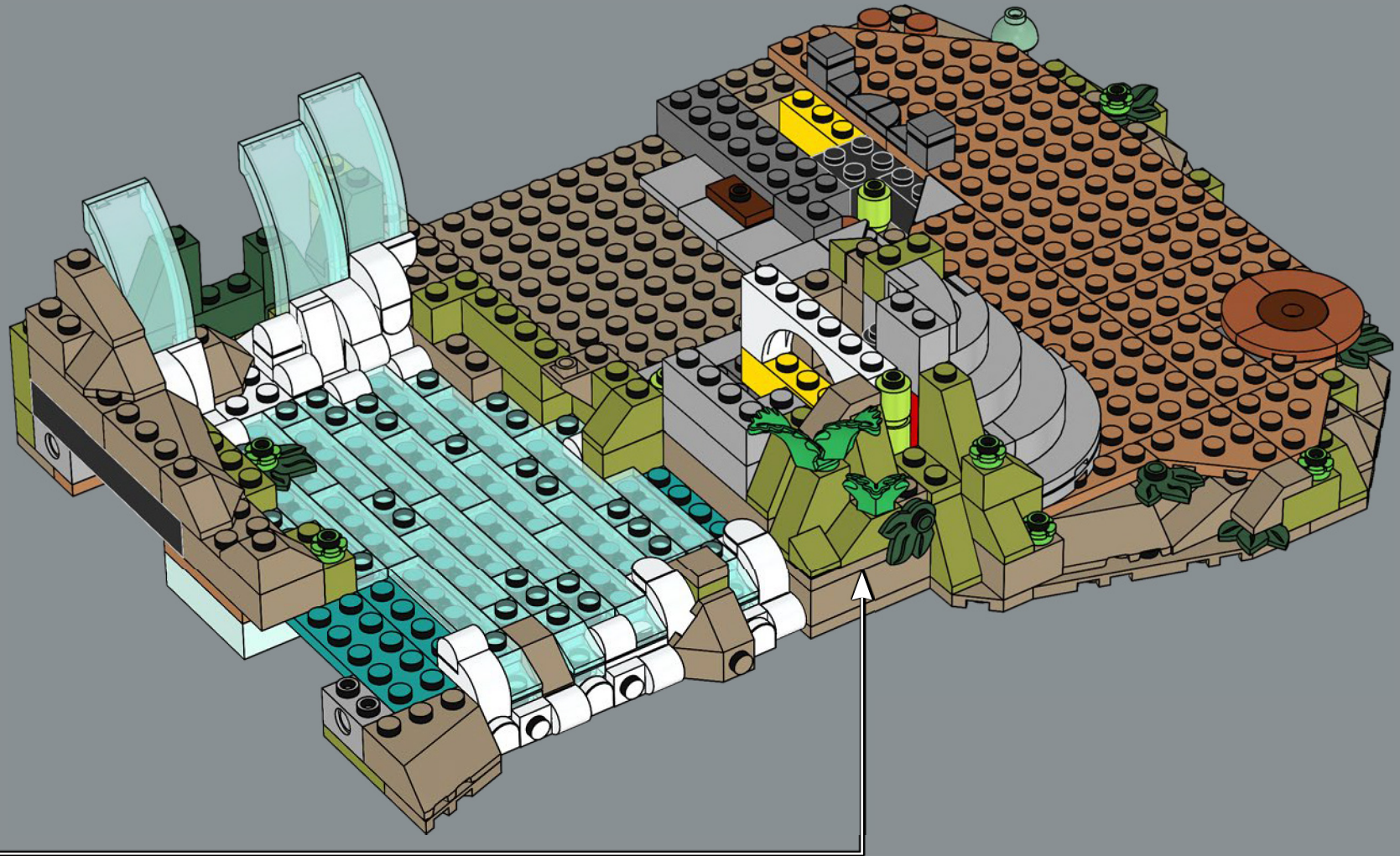

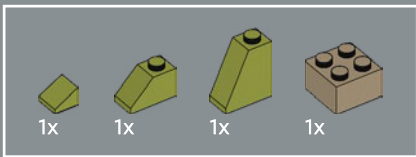

66

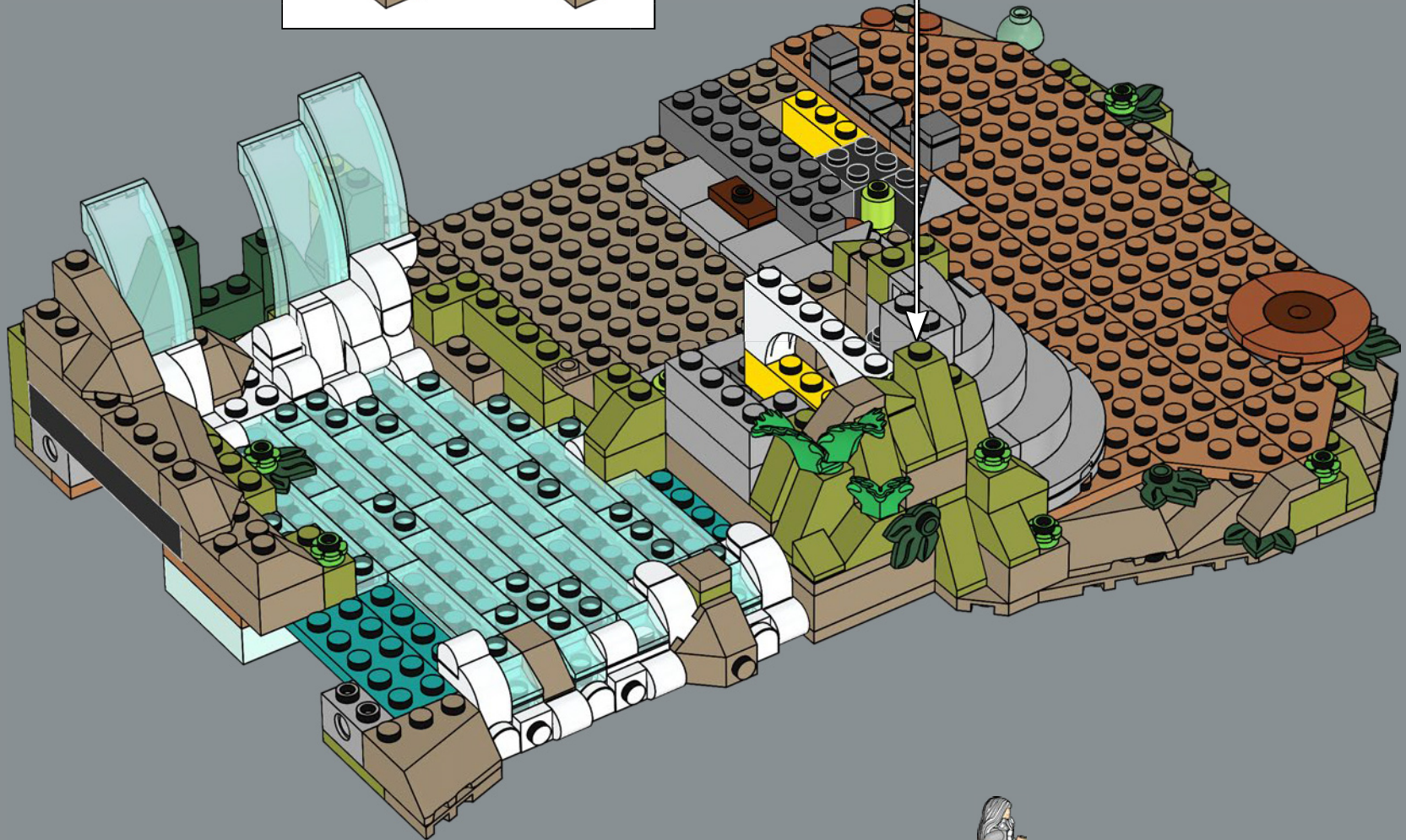
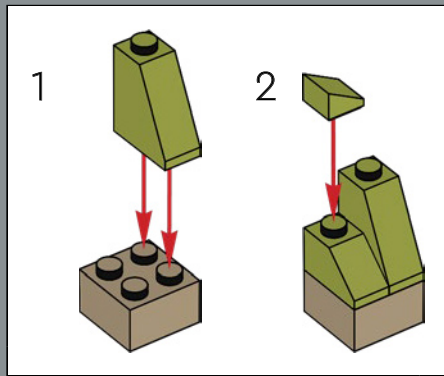

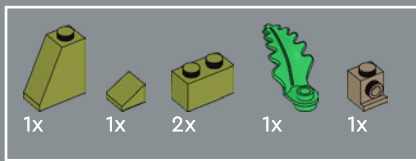

67

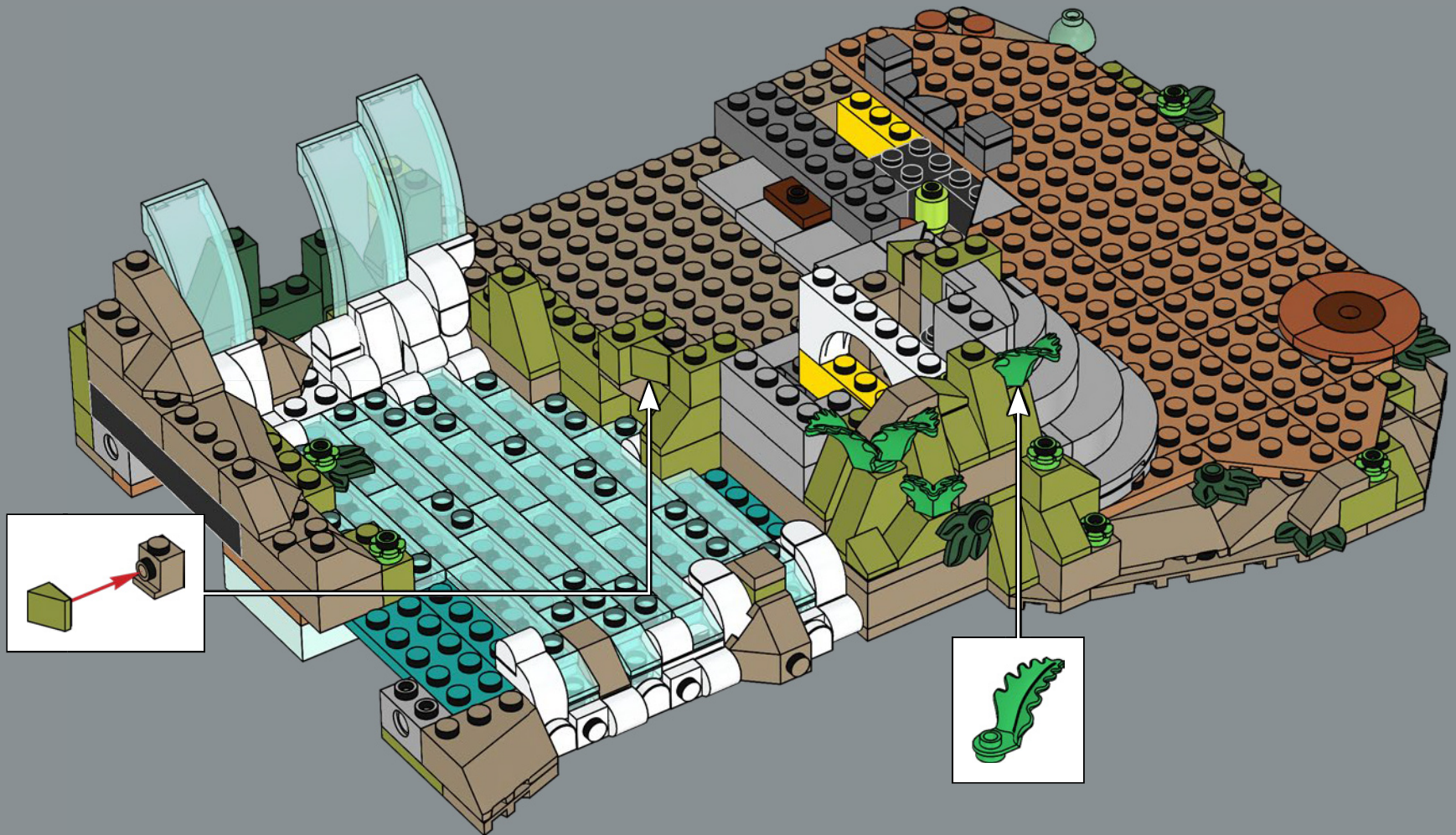

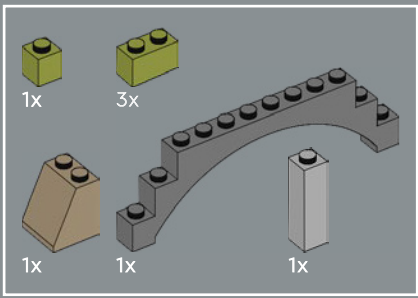

68



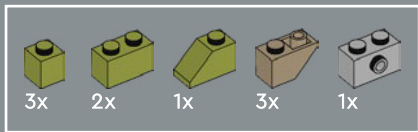

69

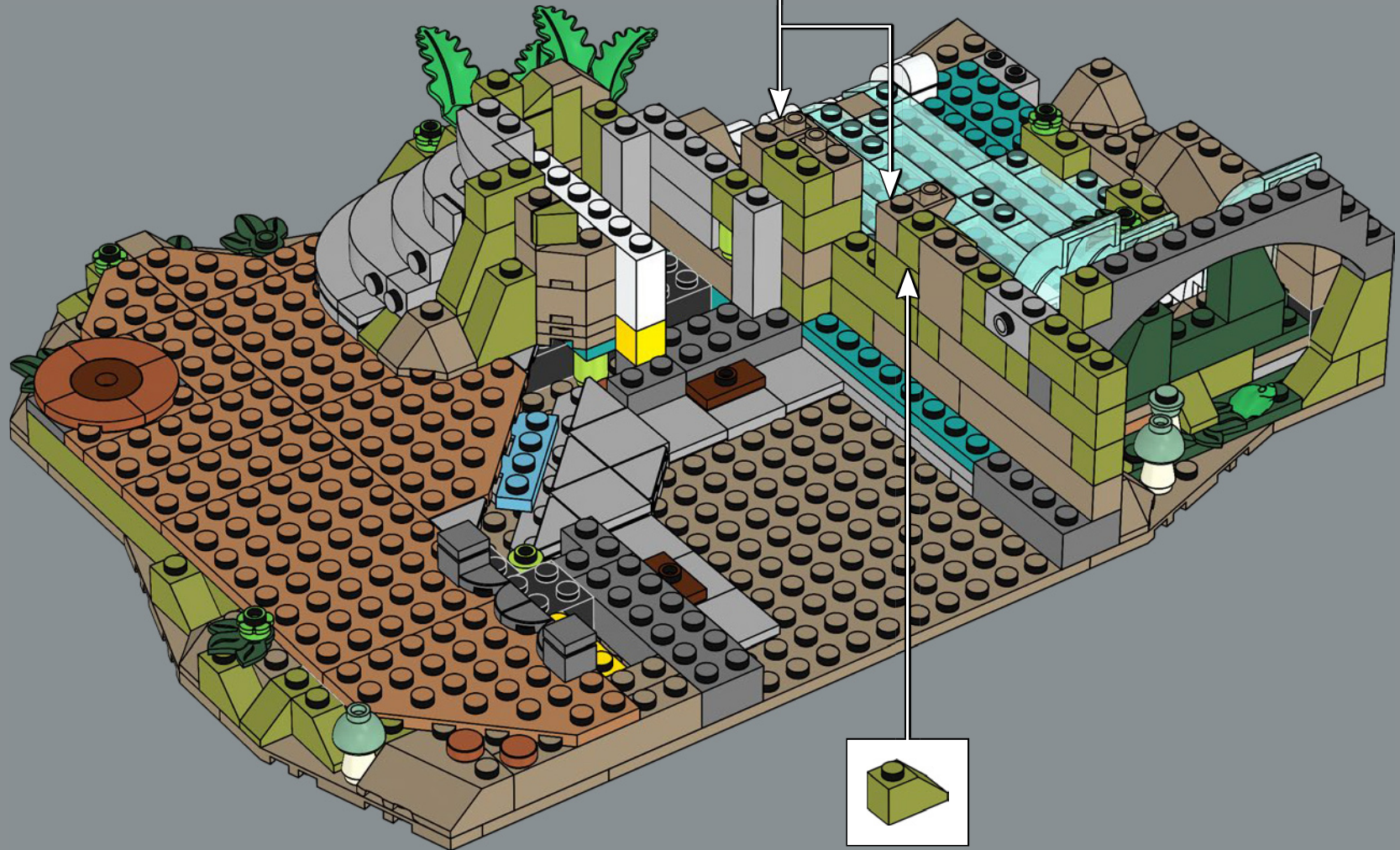
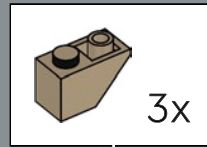

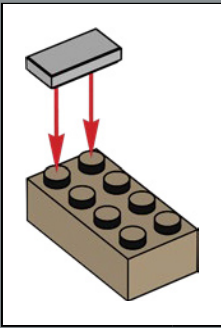
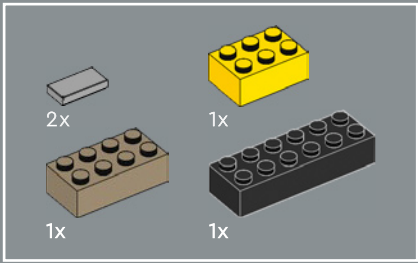

70

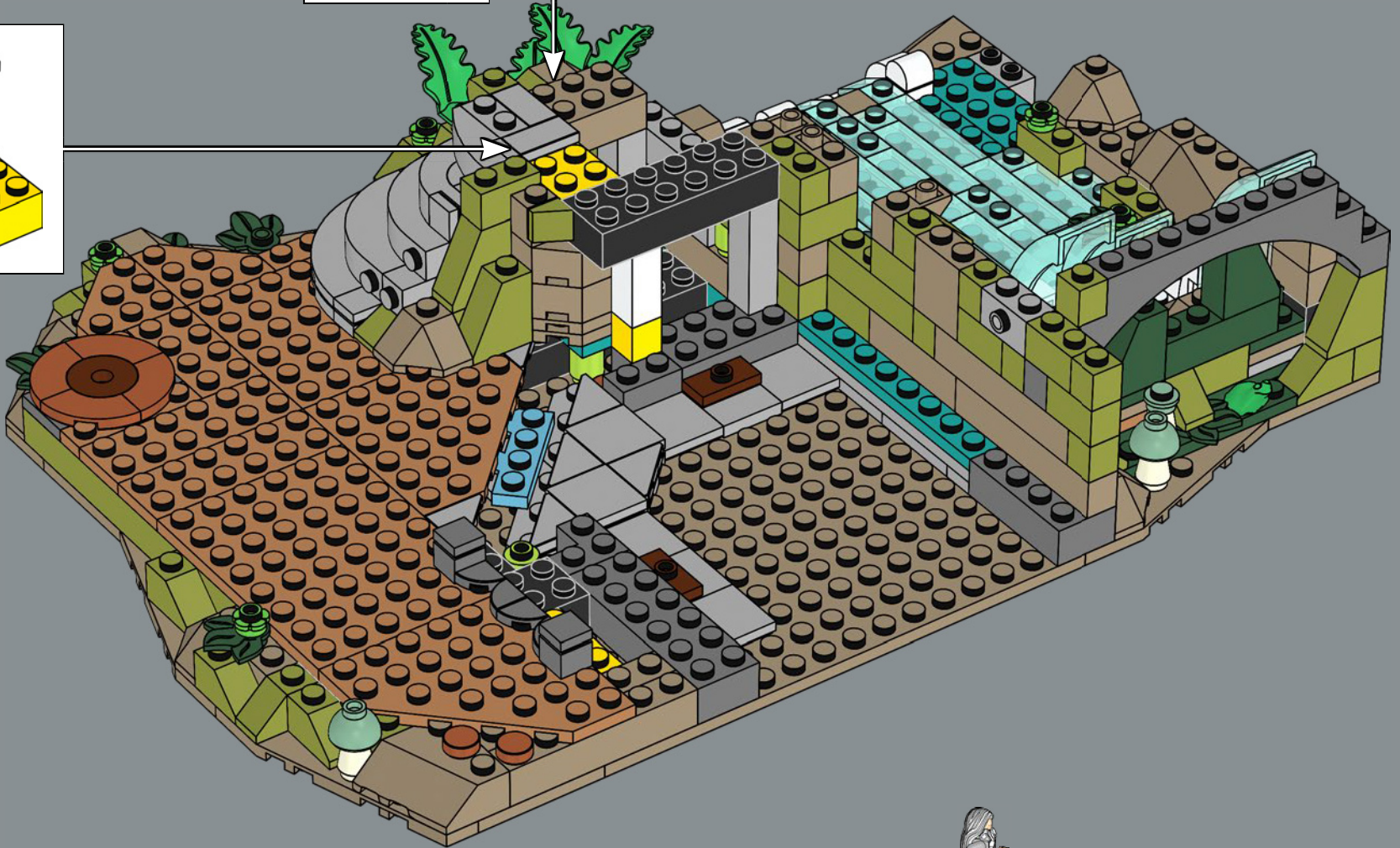
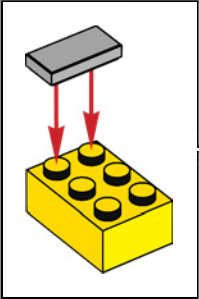

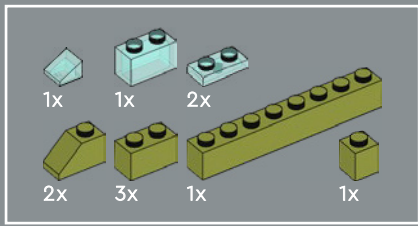

71



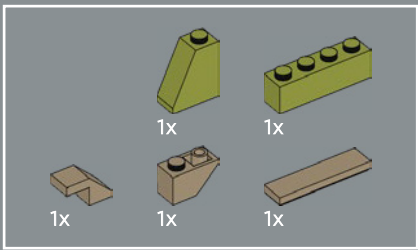

72



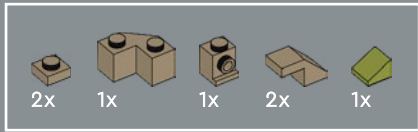

73

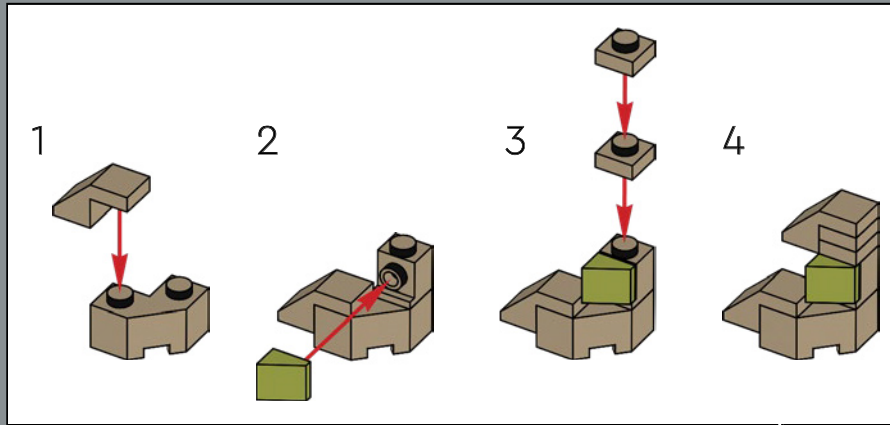

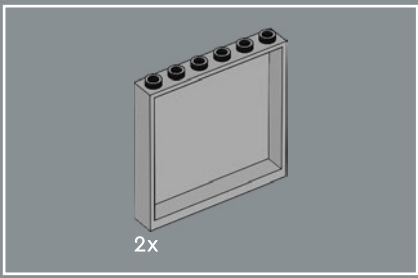

74

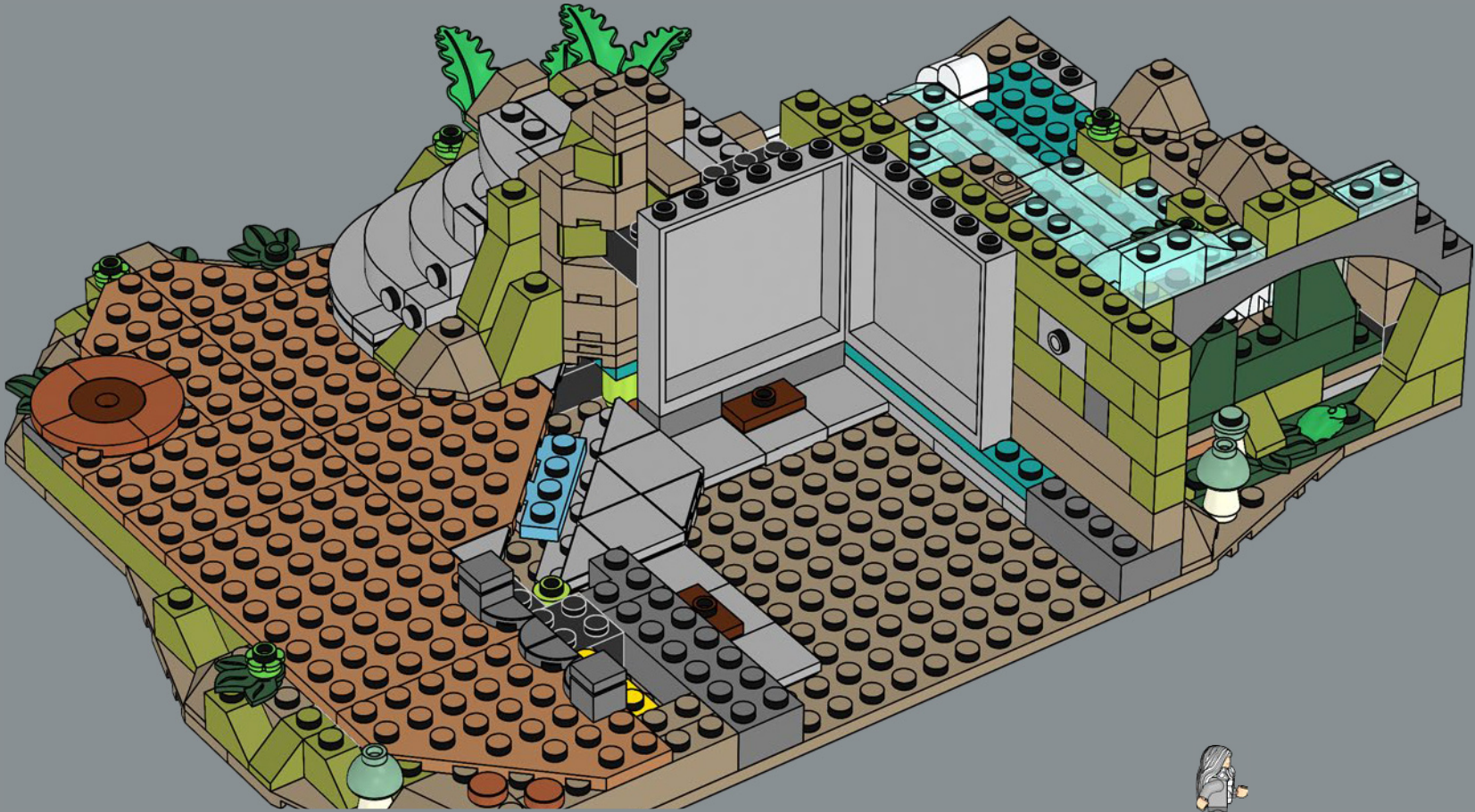

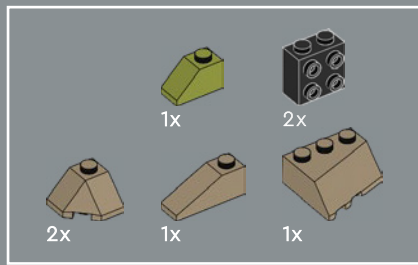

75

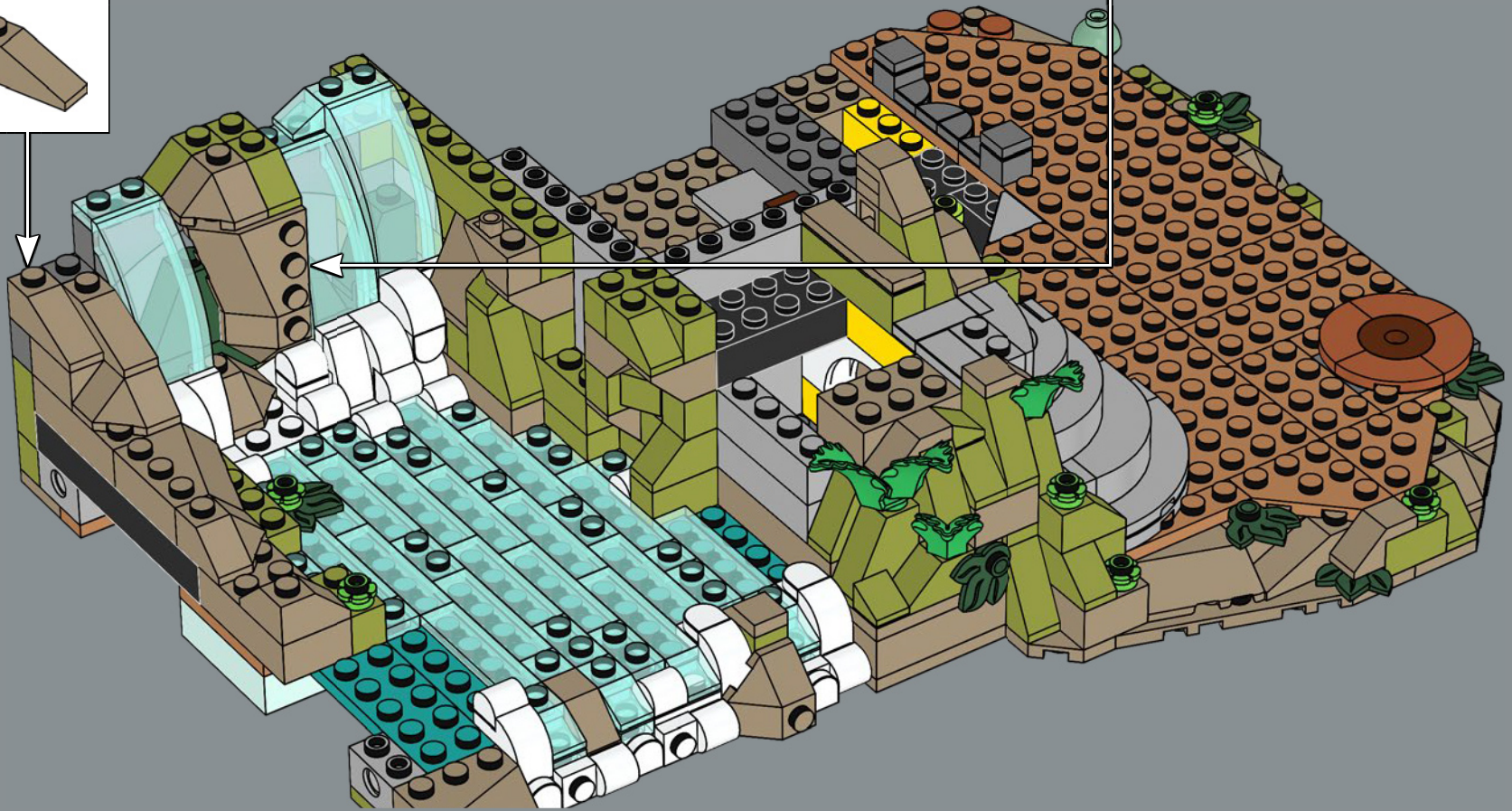
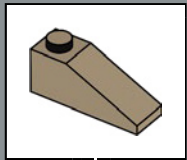
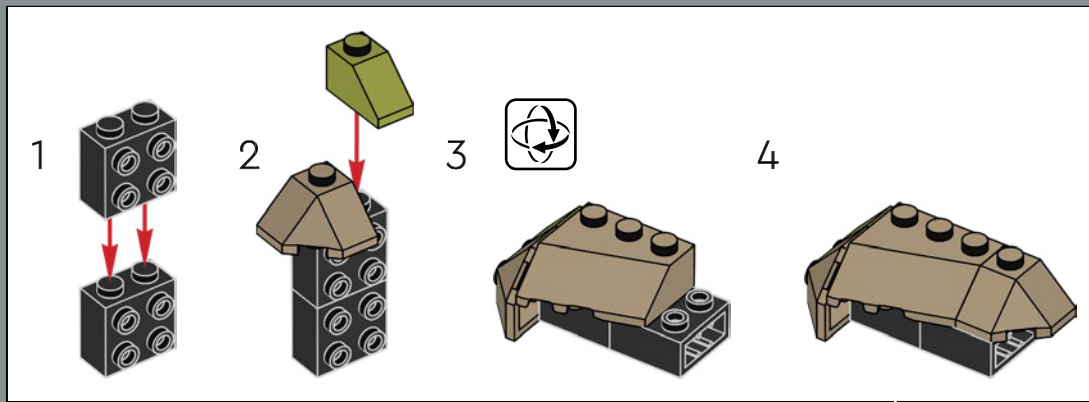

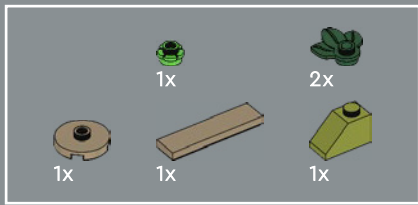

76

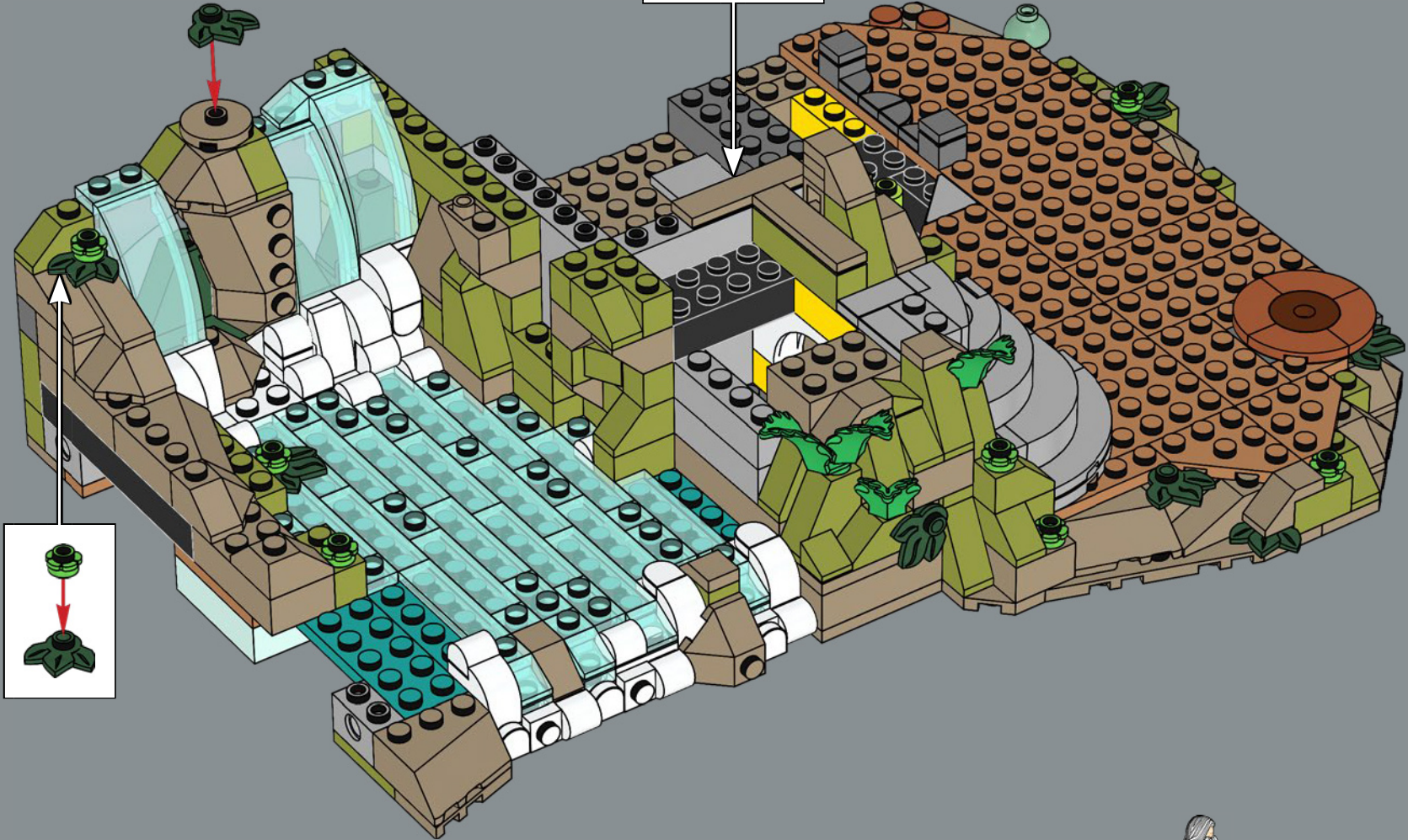
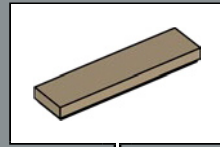

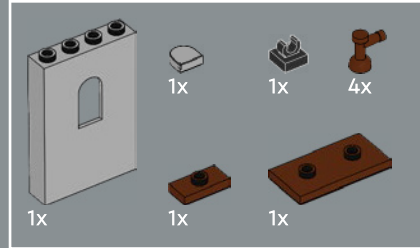
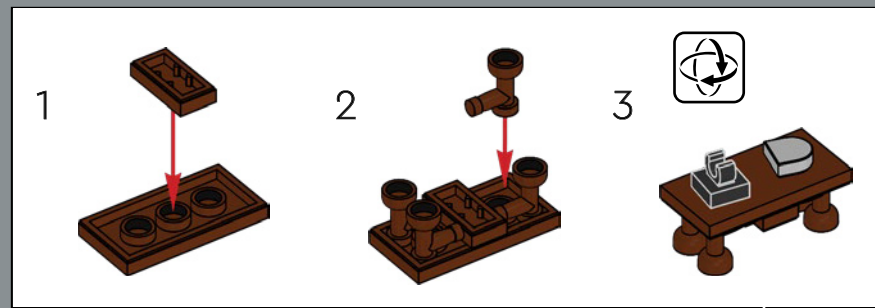

77

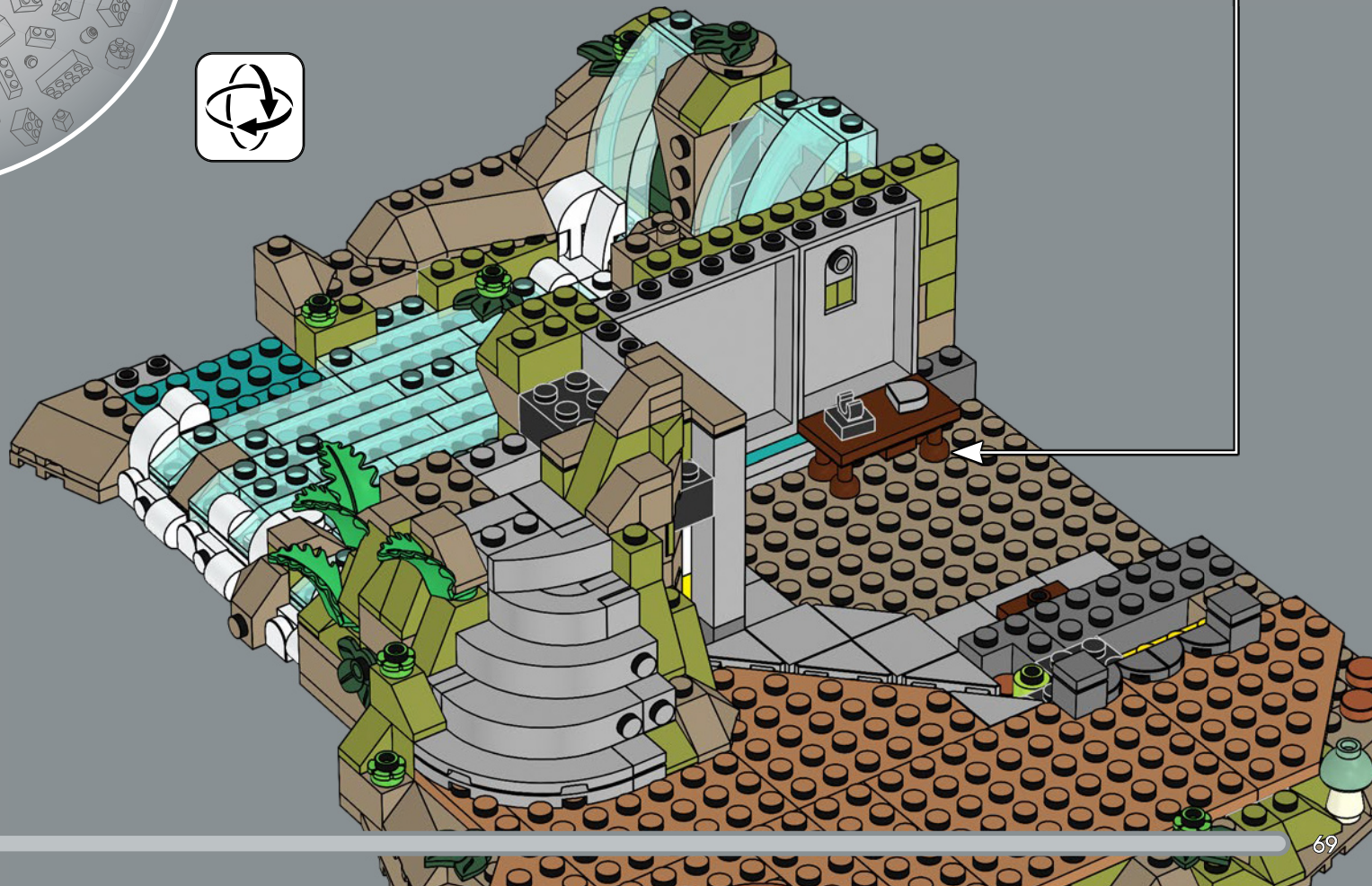

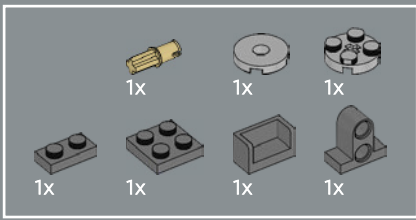

78

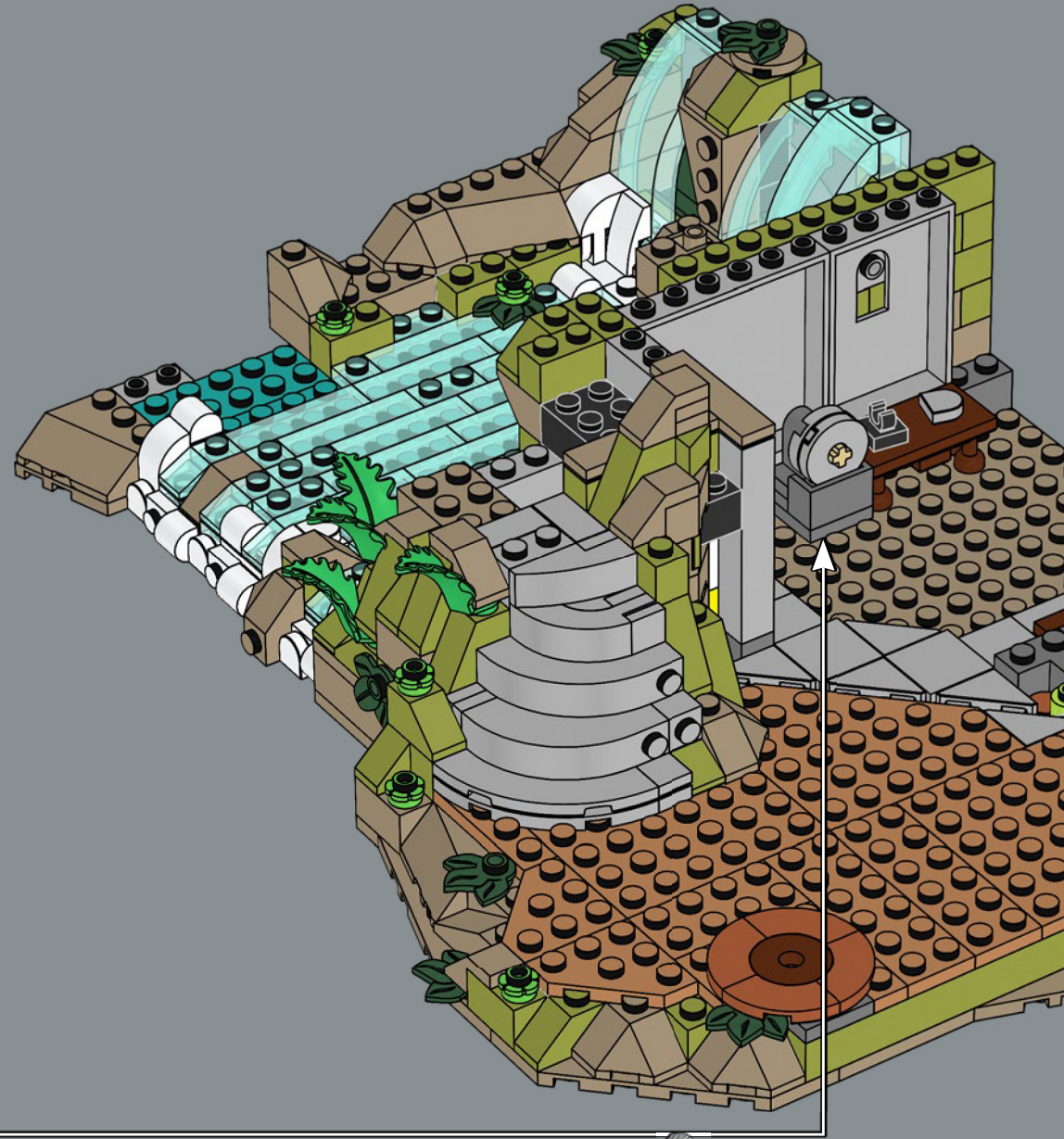
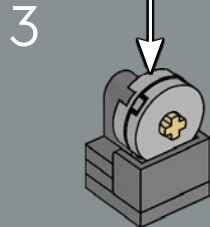
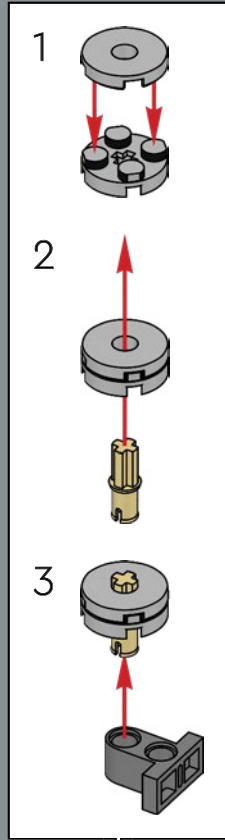
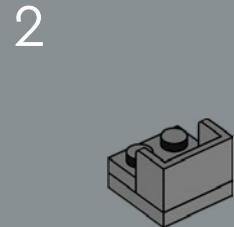
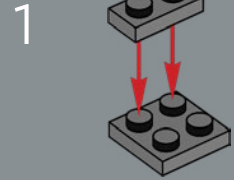



79

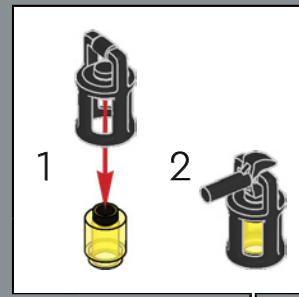

Even though it's blocked, the window in the 1x4x6 wall panel still provides light for this room.

Même si elle est bloquée, la fenêtre du panneau mural 1x4x6 apporte toujours de la lumière à cette pièce.

Aunque no puede abrirse, la ventana del panel mural 1x4x6 puede proporcionar iluminación a esta habitación.

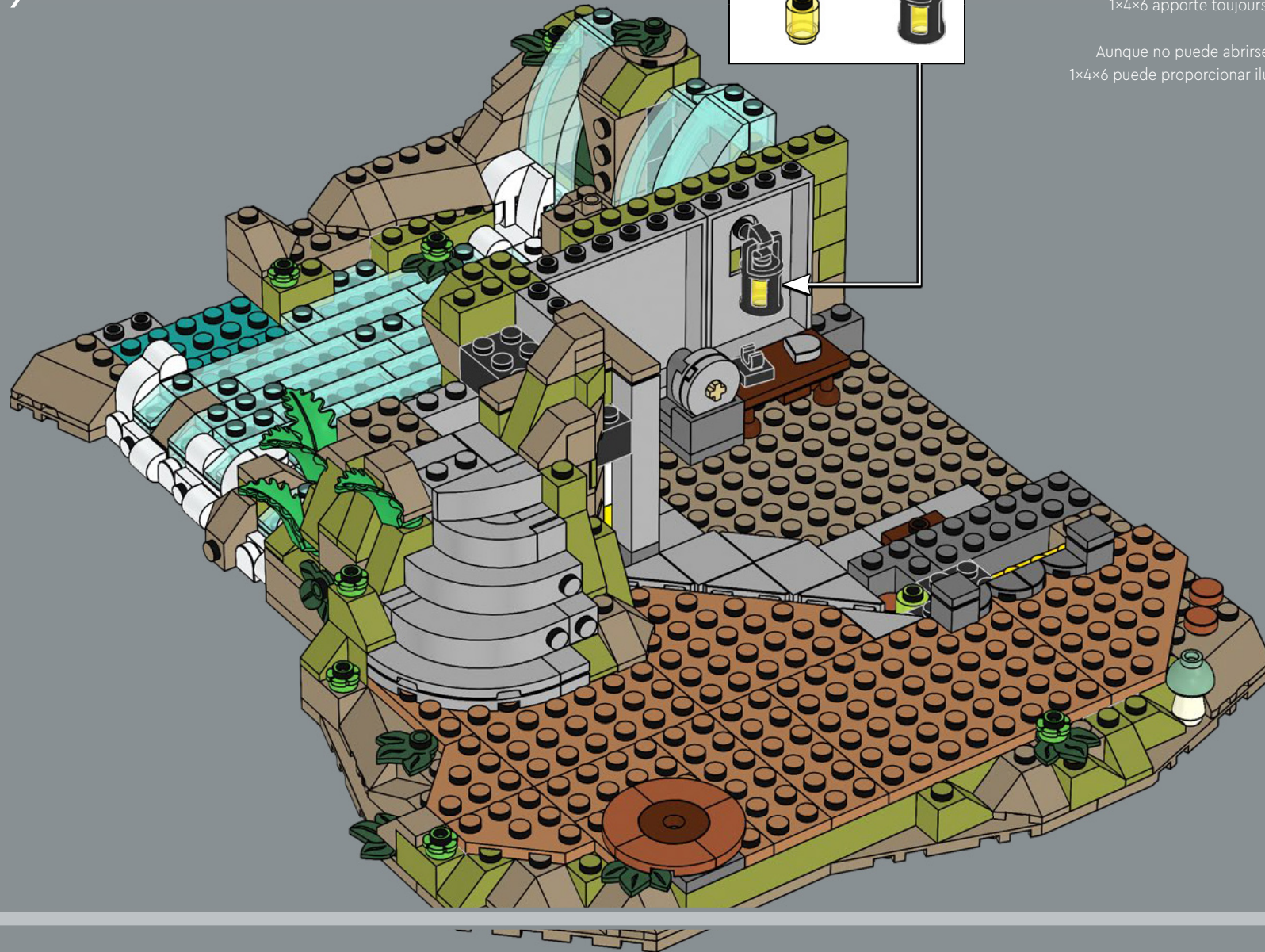

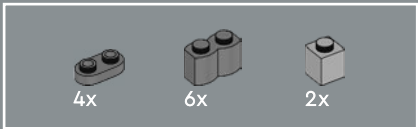



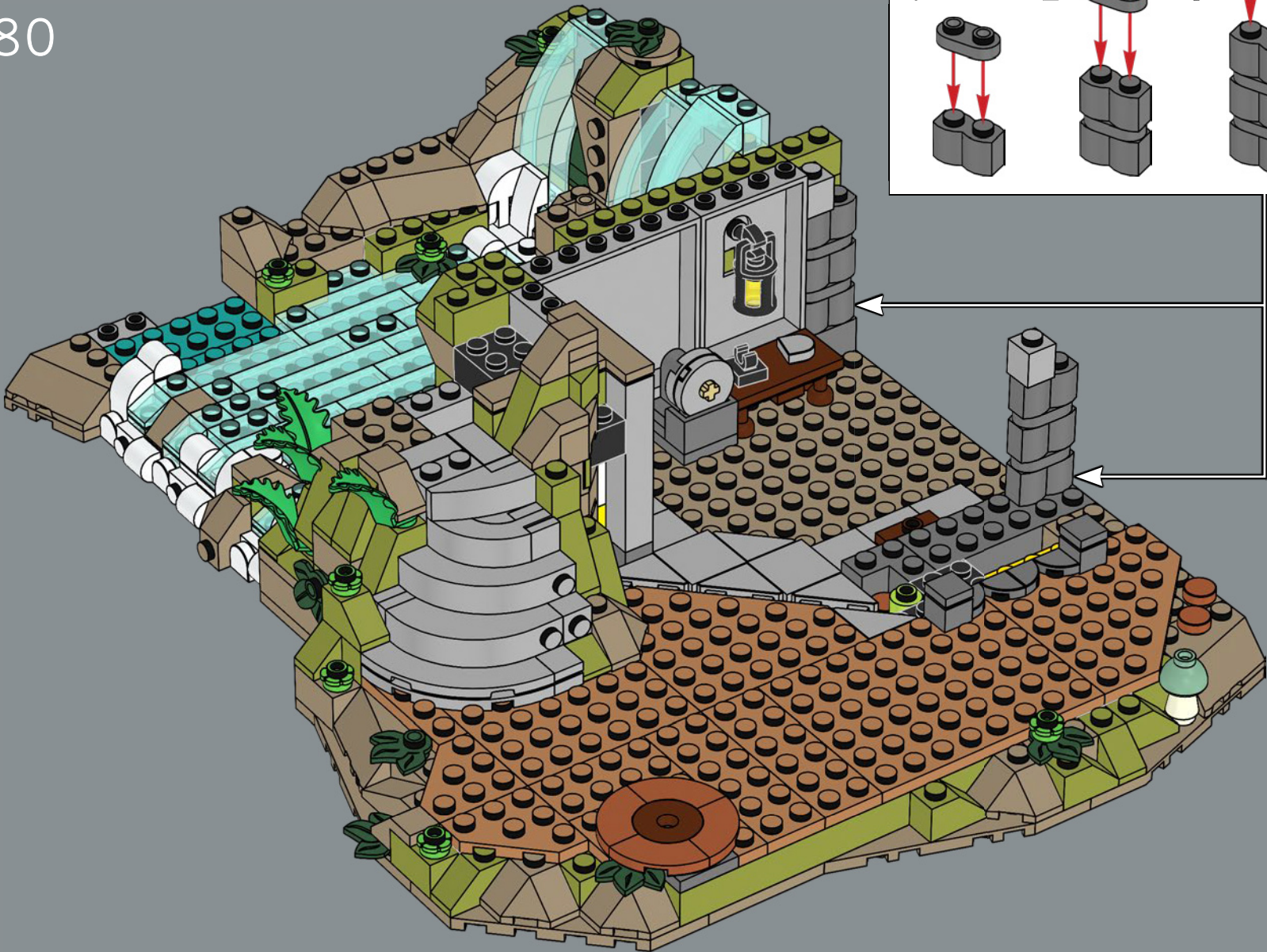
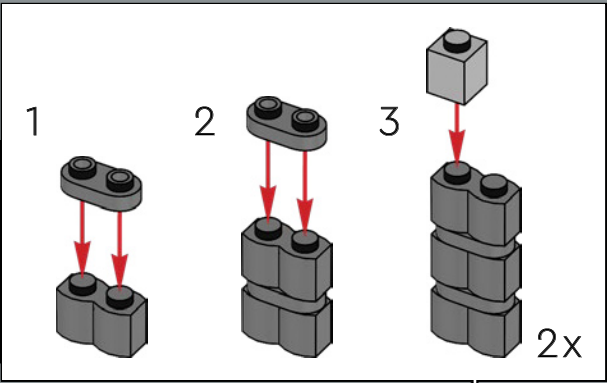

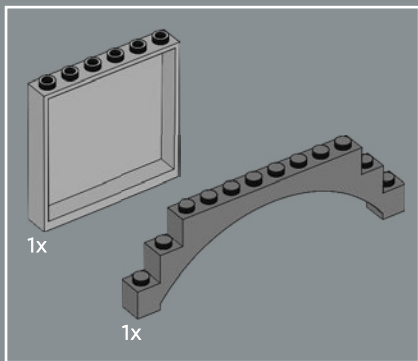
80



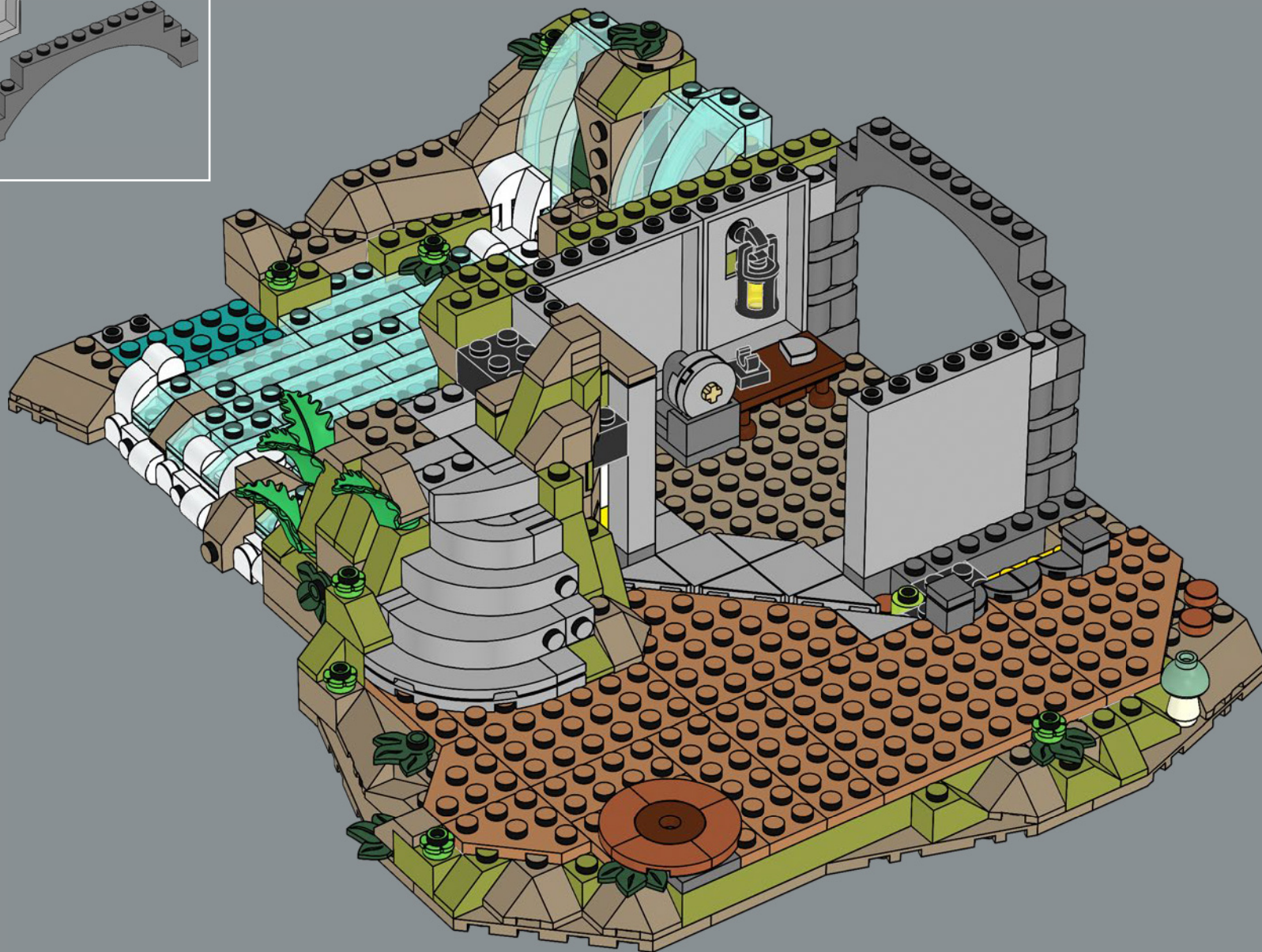

81



		
1x	2x	1x

82

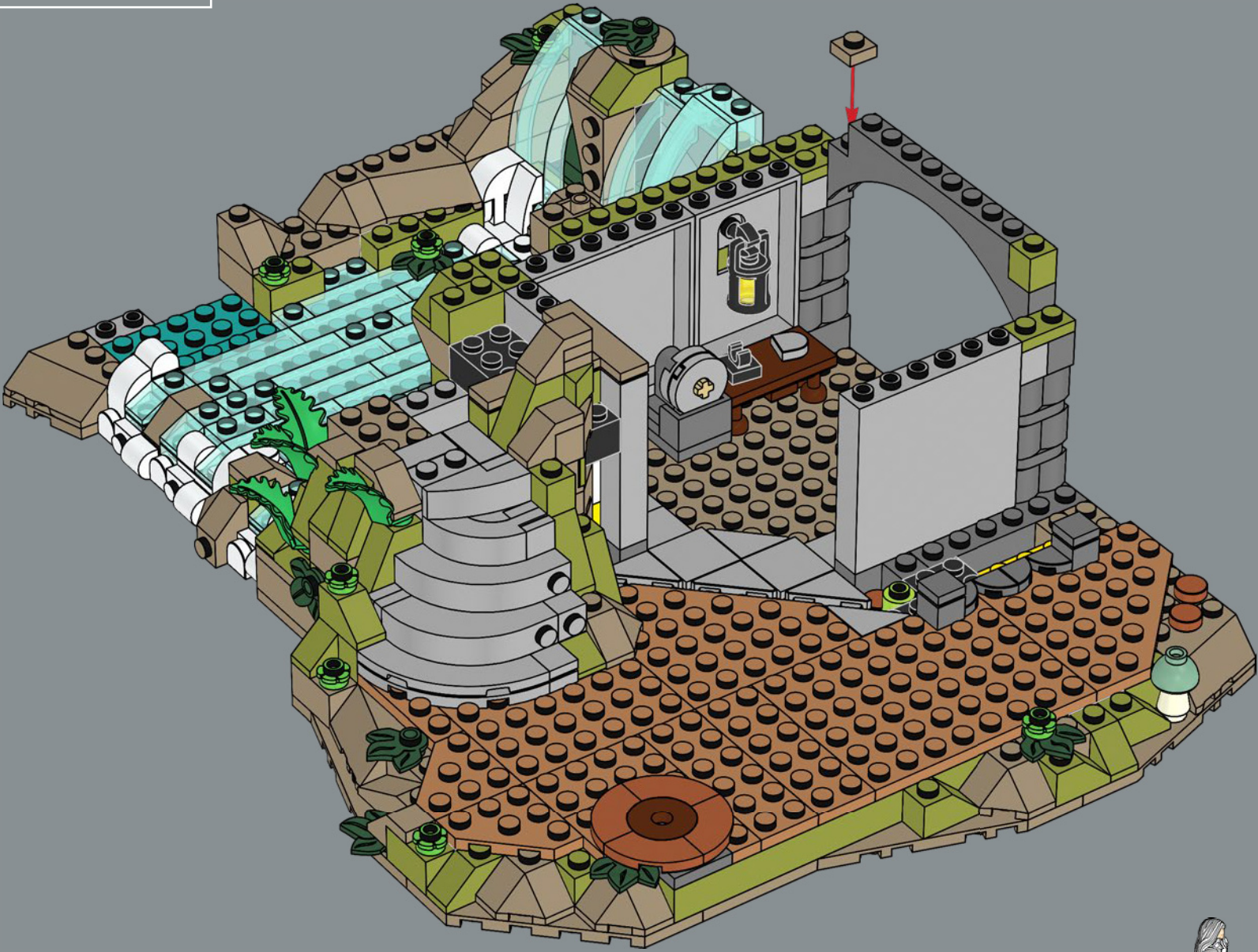

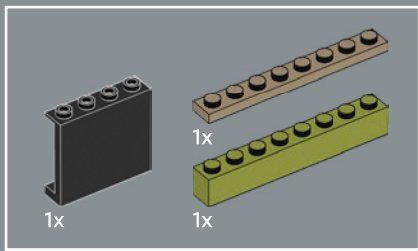

83

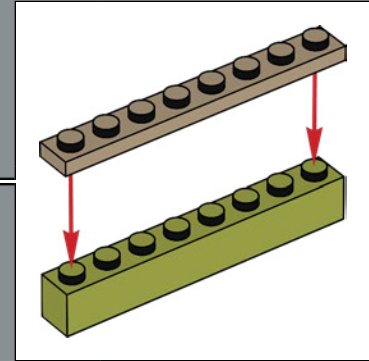
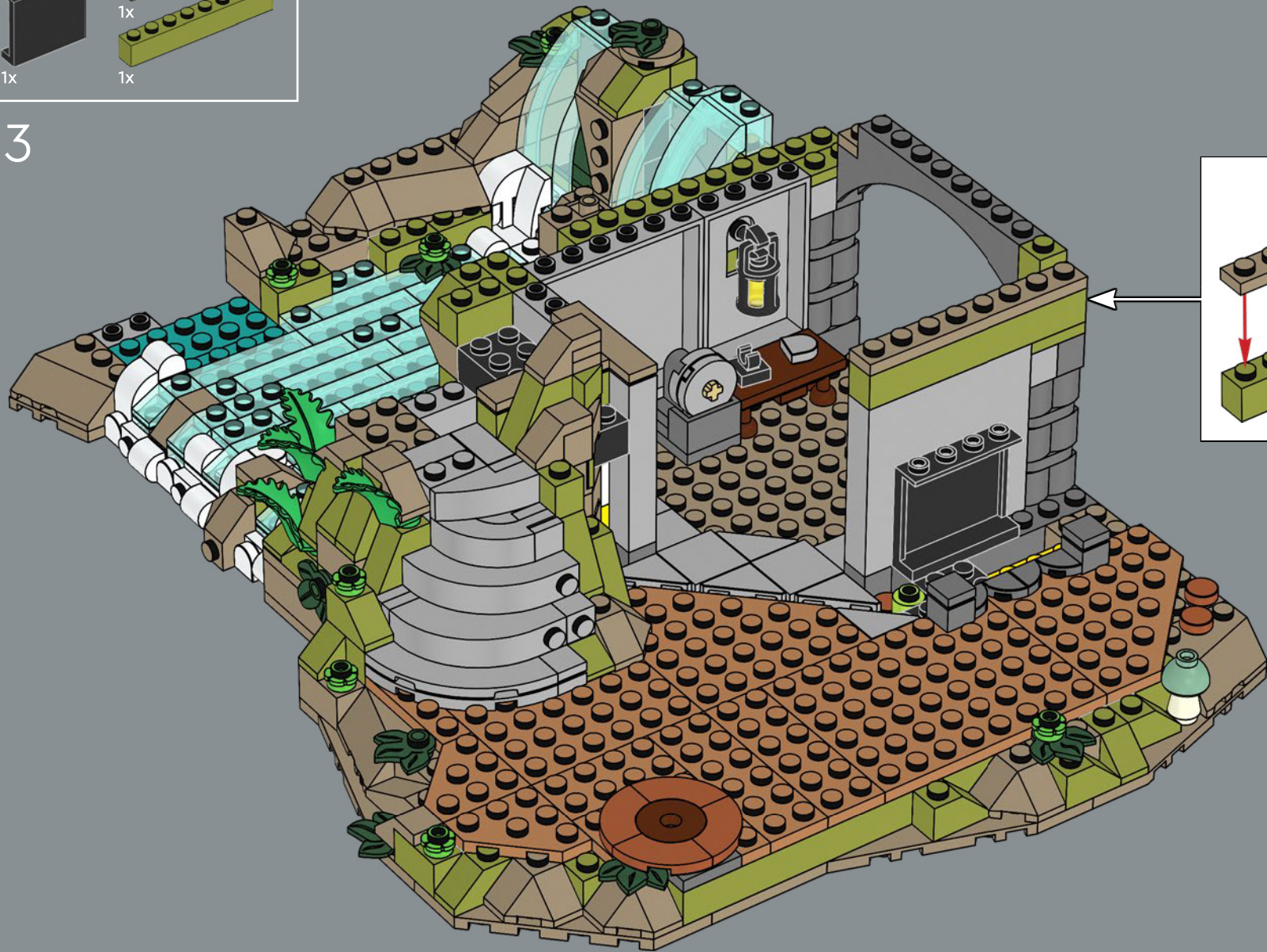

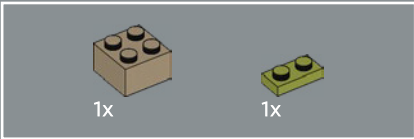
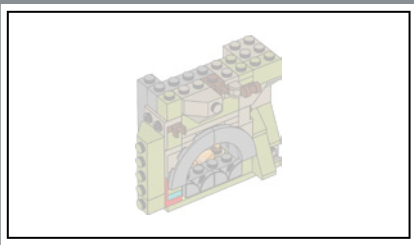

84

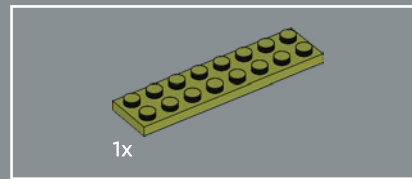
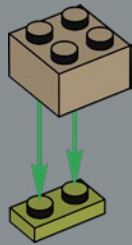

85

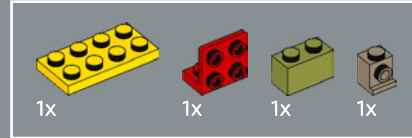
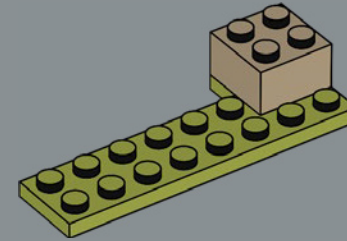

86

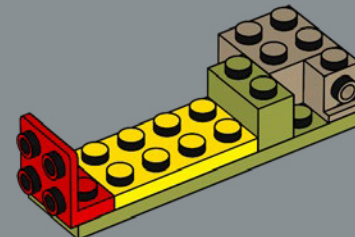



87

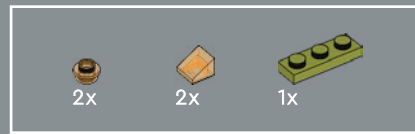
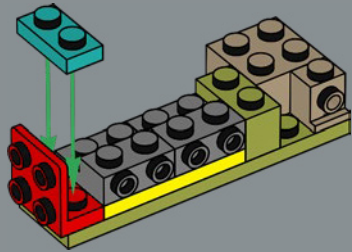

88

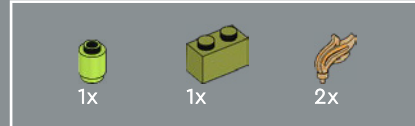
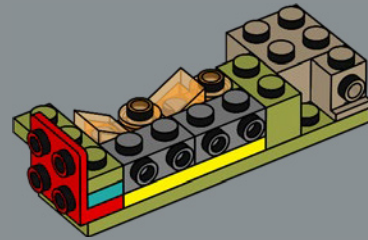

89

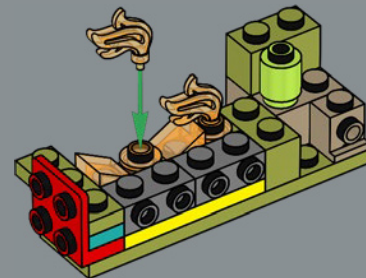

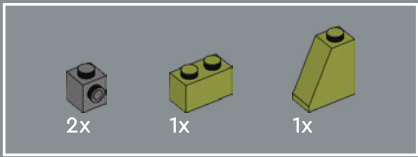

90

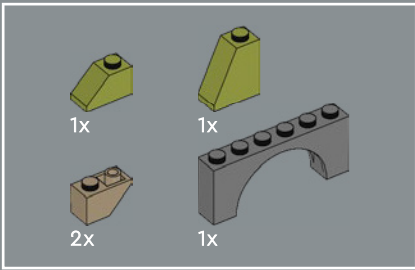
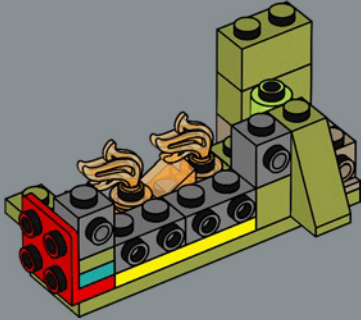

91

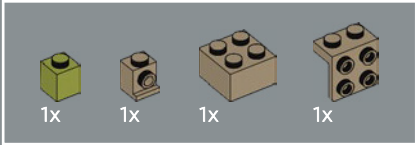
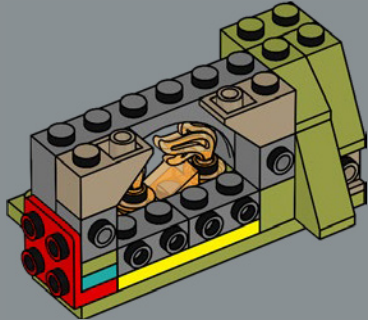

92

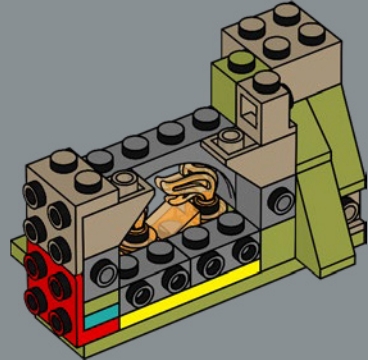

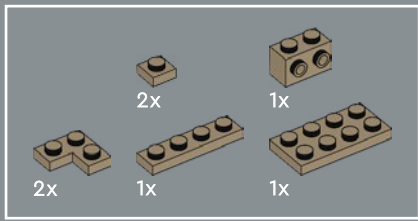

93

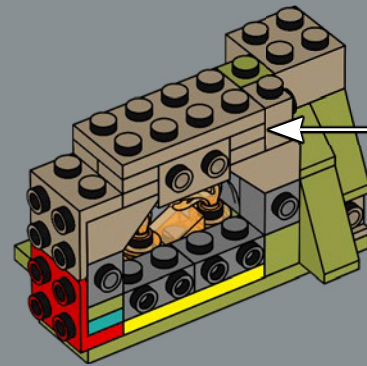
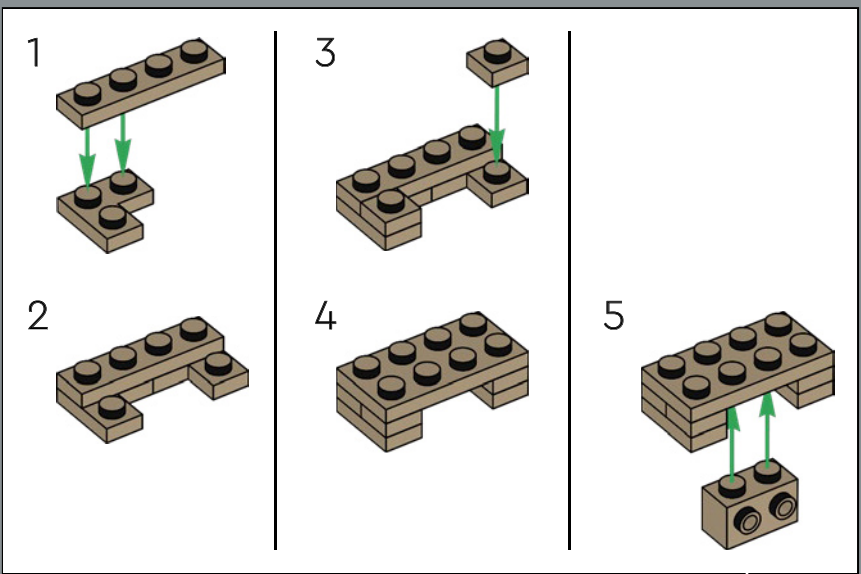

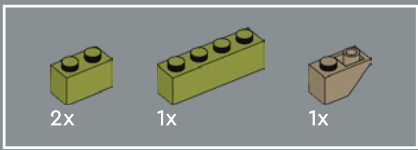

94

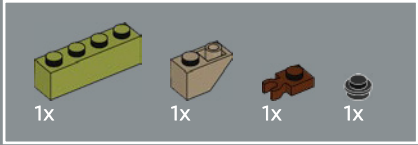
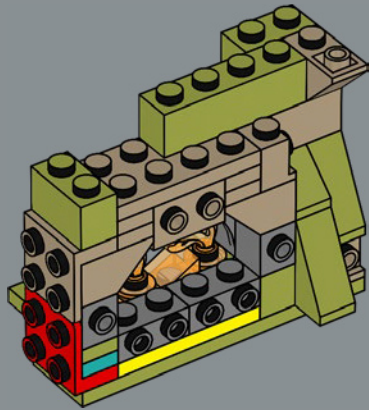

95

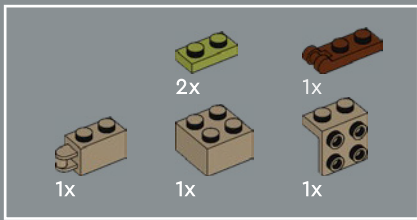
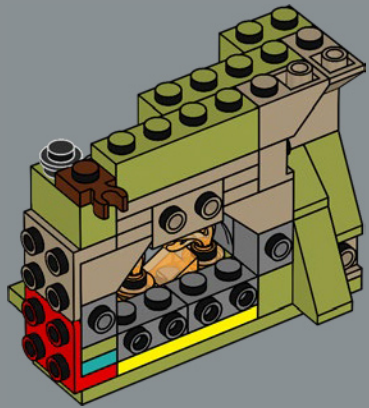

96

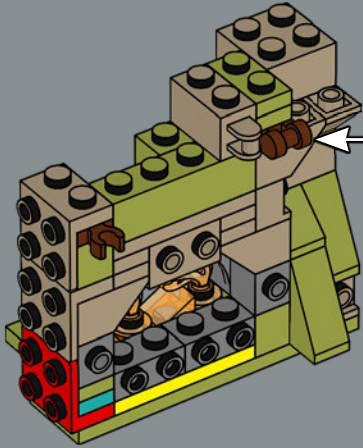
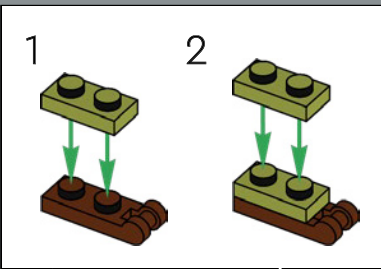

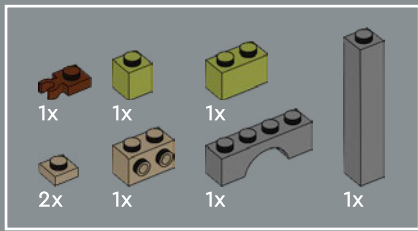

97

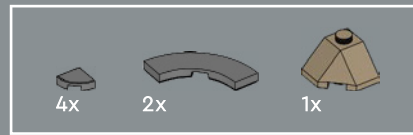
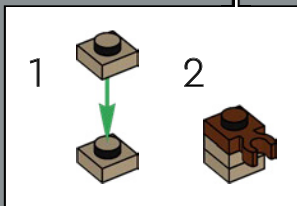
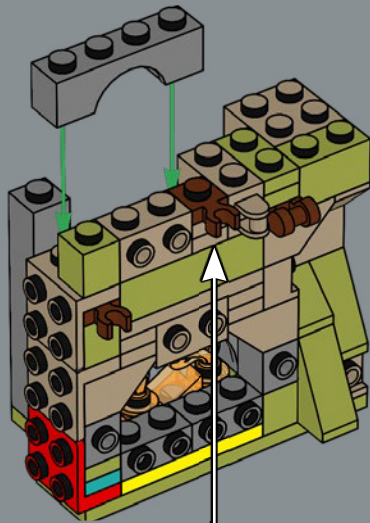

98

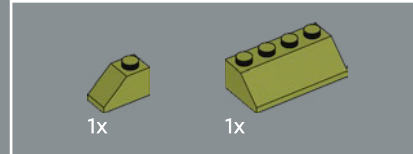
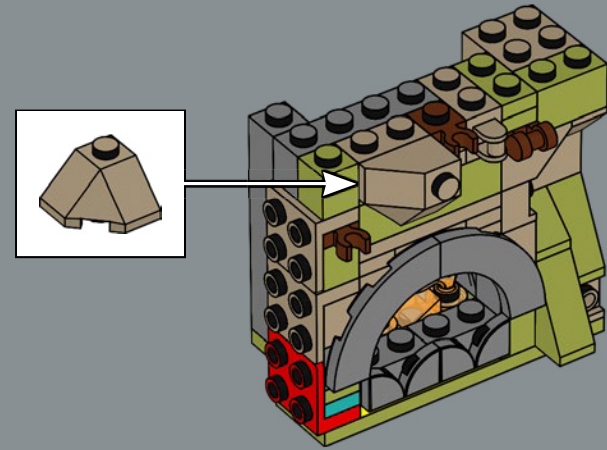

99

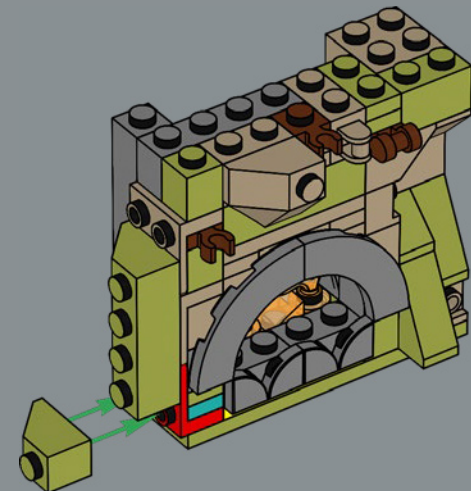

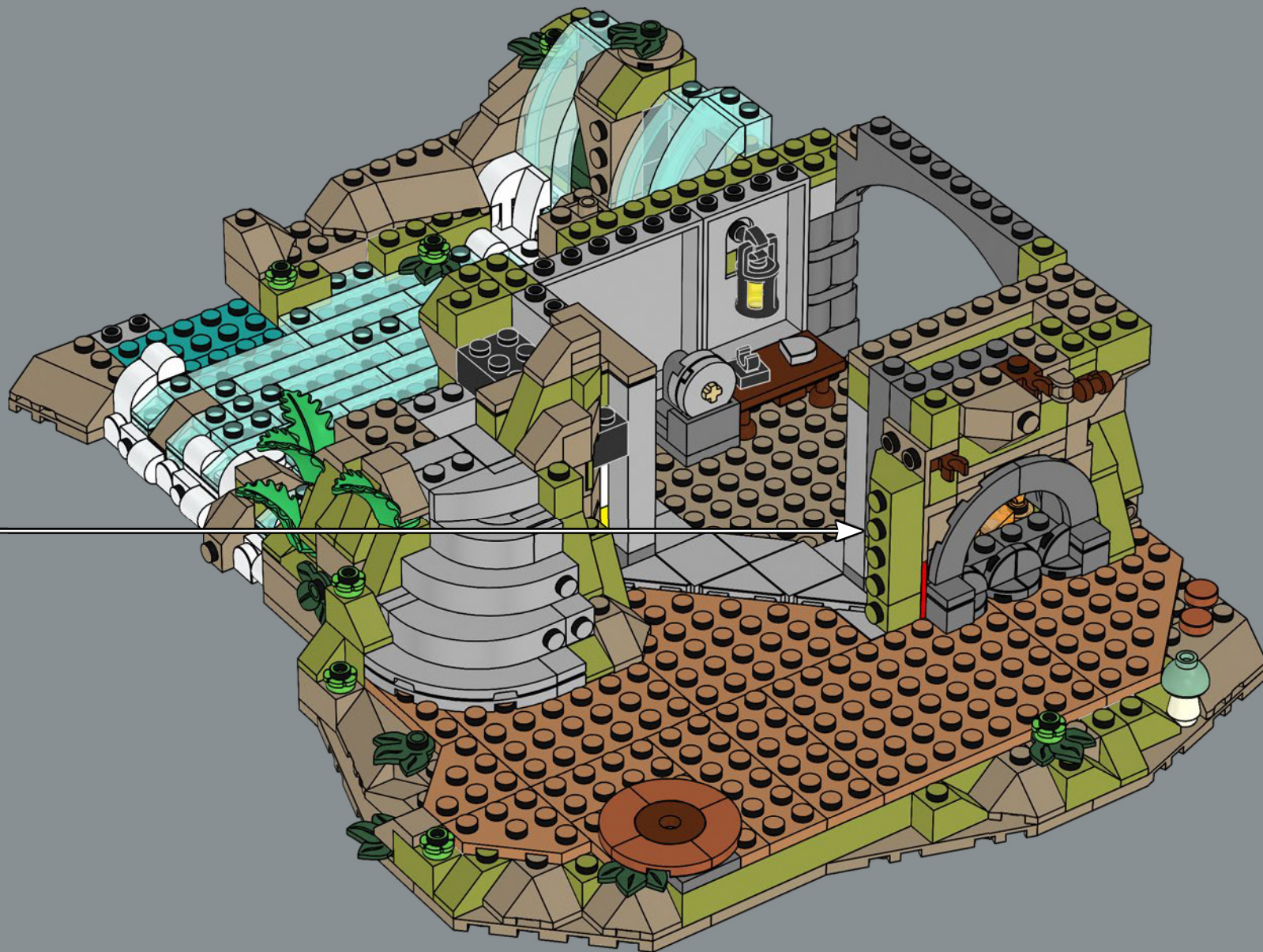

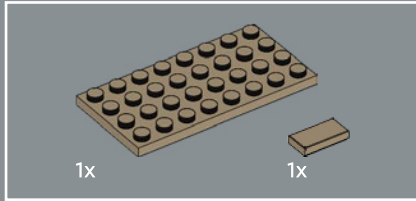
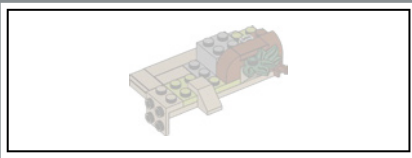

101

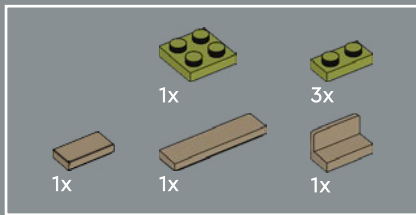
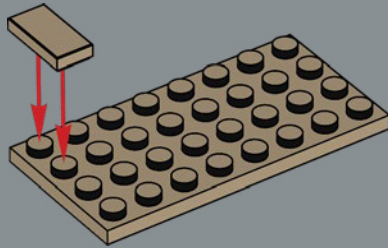

102

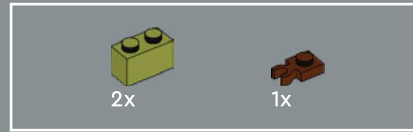
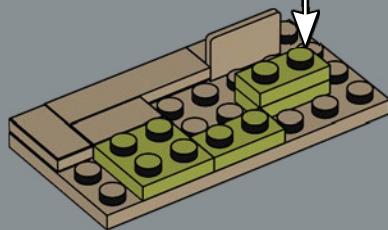
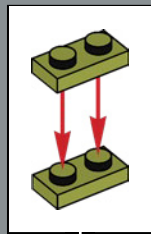

103

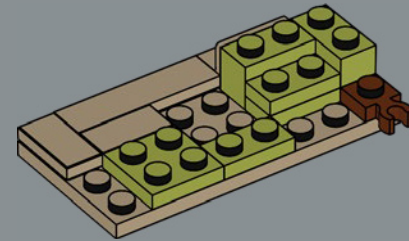

104

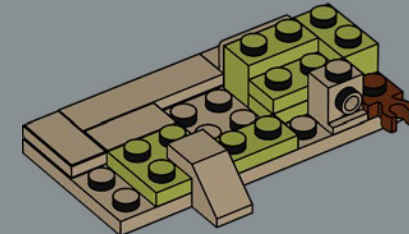

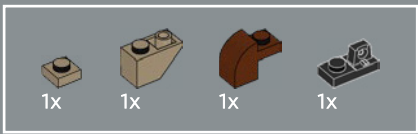

105

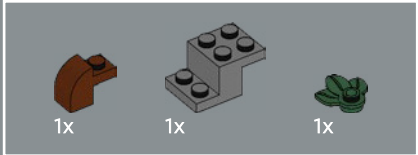
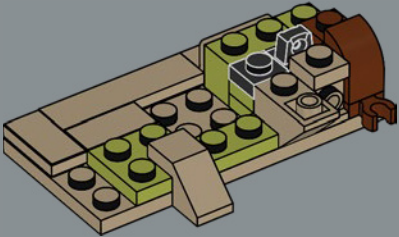

106

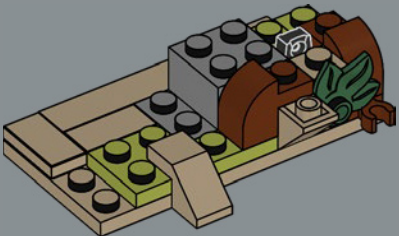

107

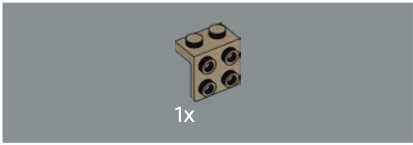
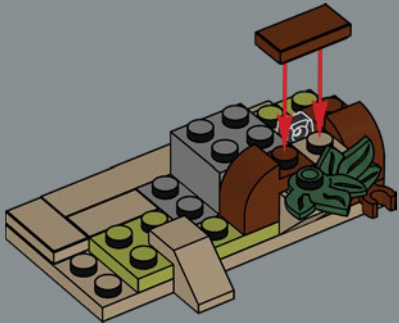

108

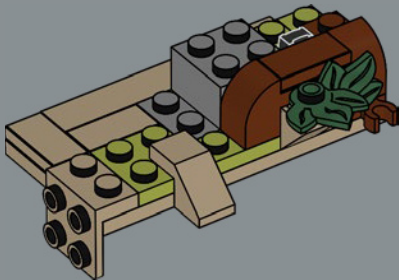

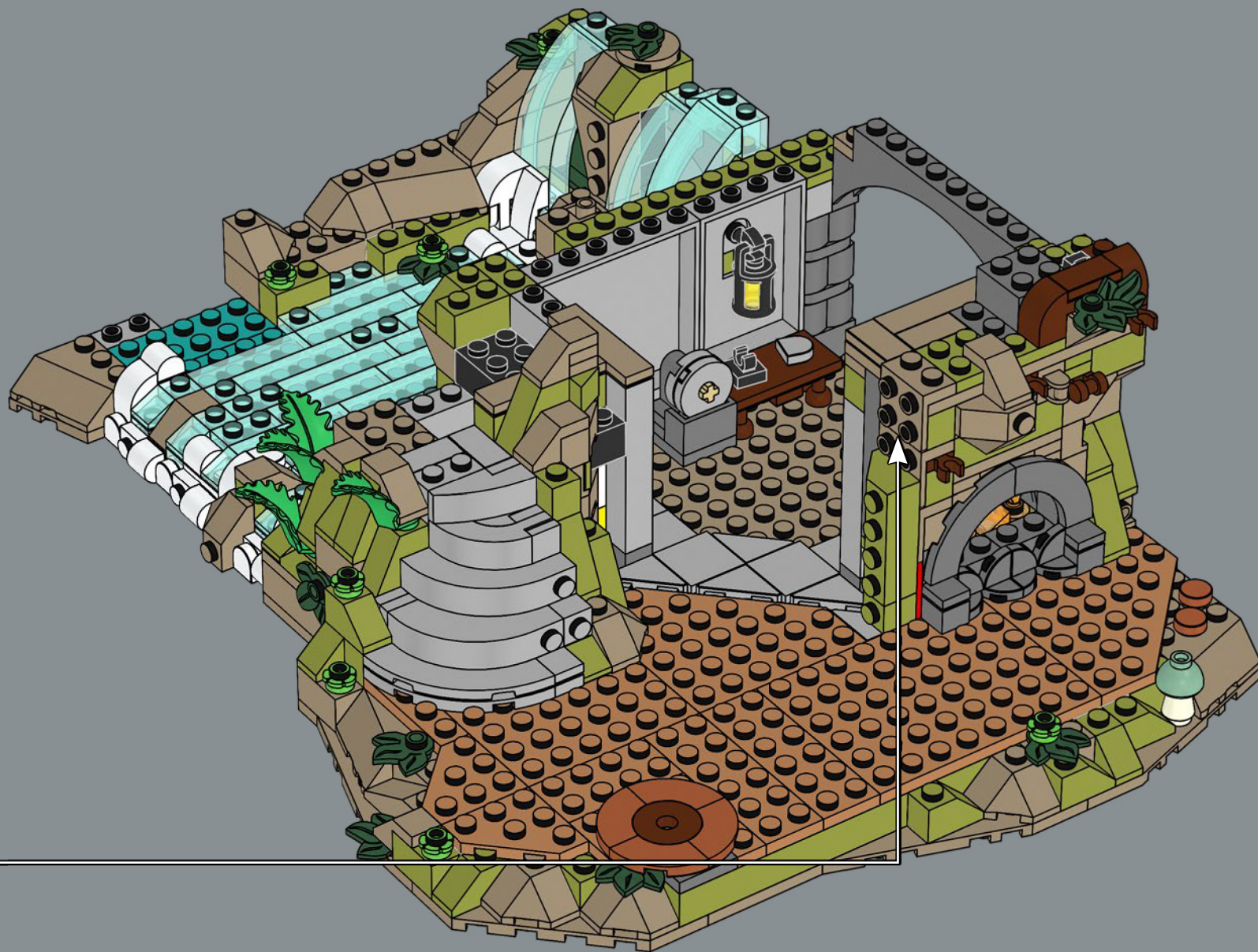

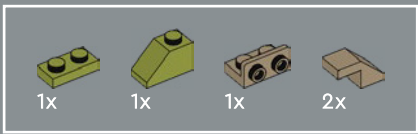

110

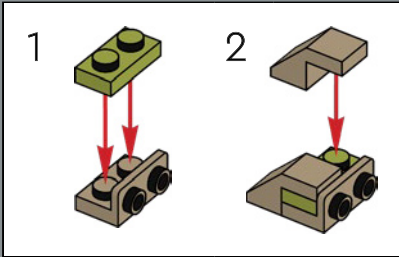
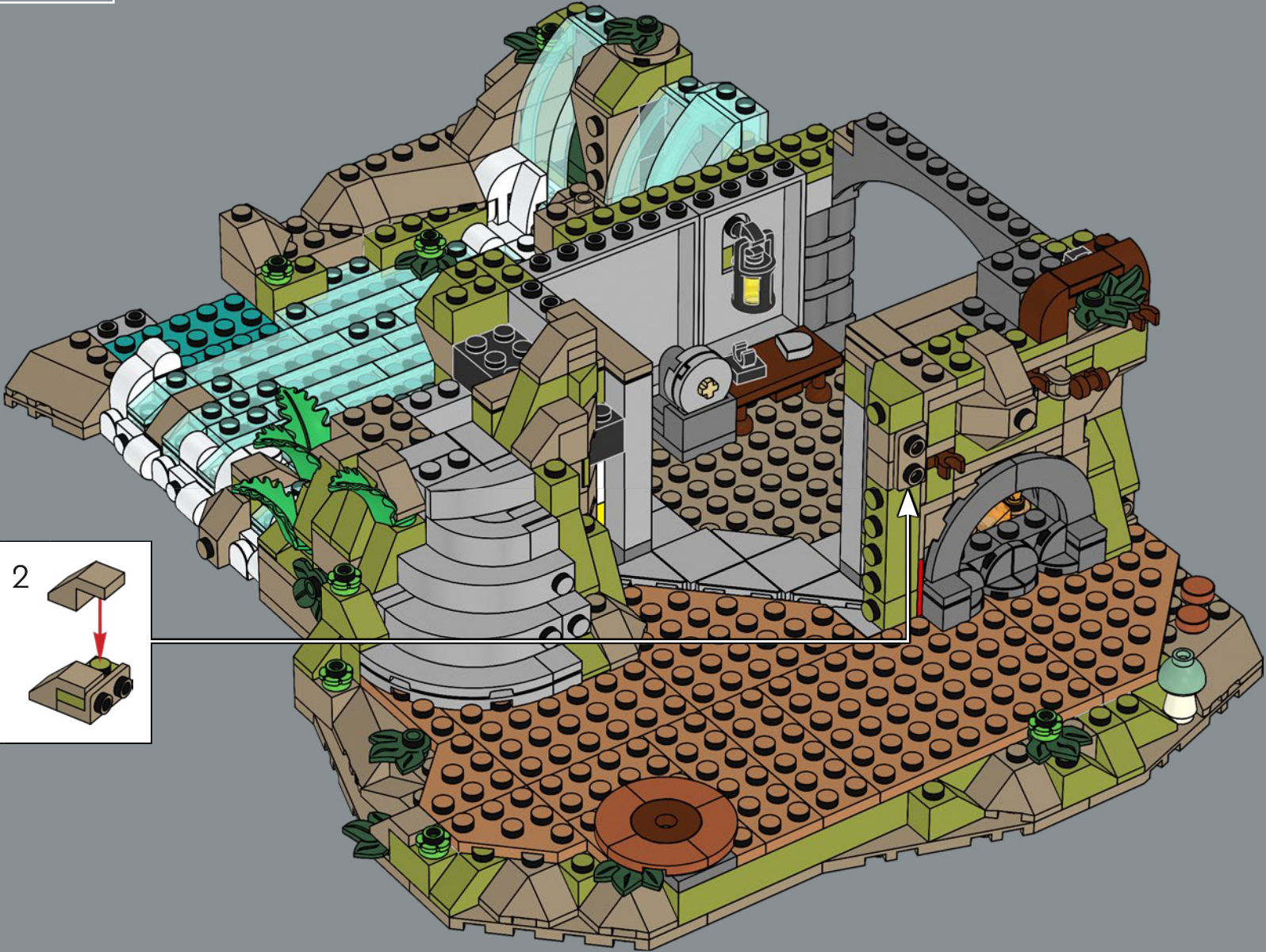

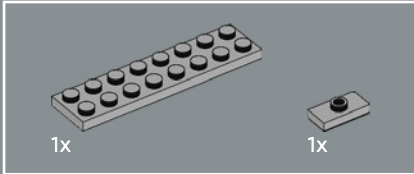
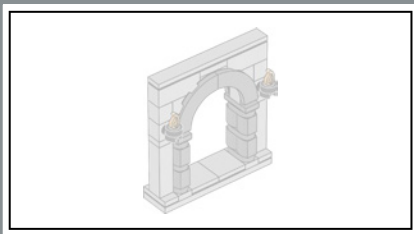

111

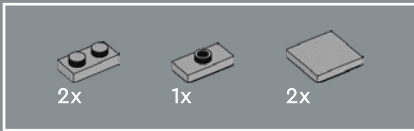
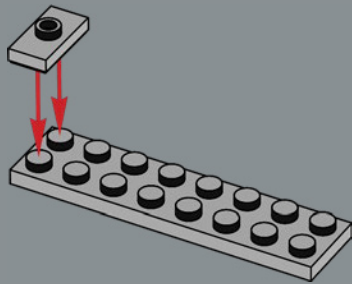

112

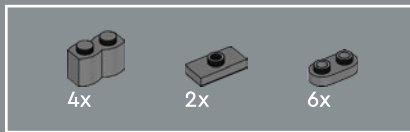
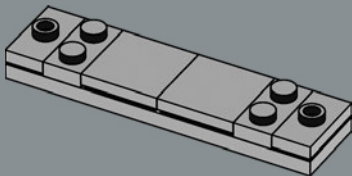

113

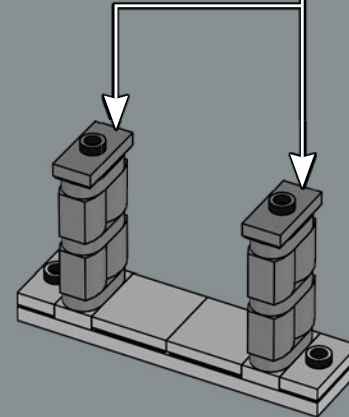
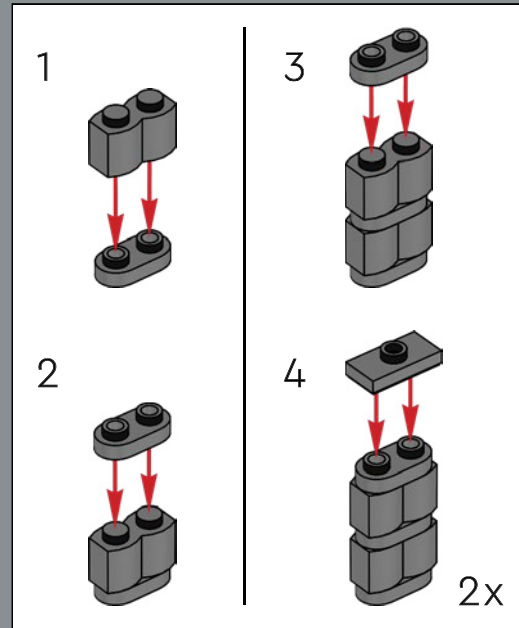

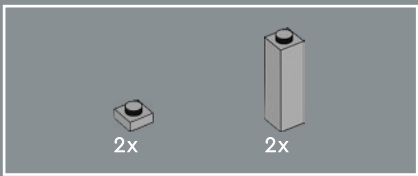

114

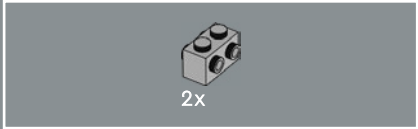
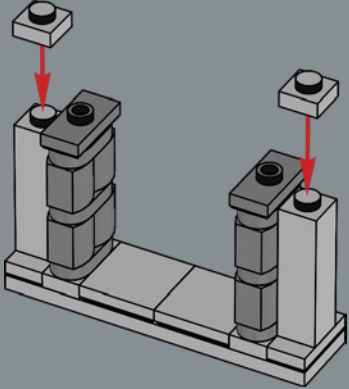

115

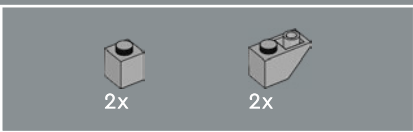
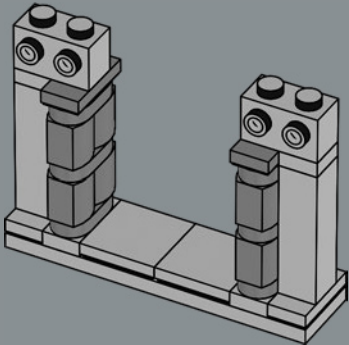

116

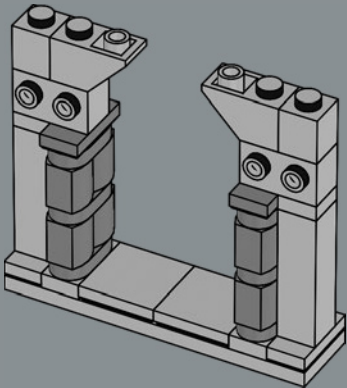

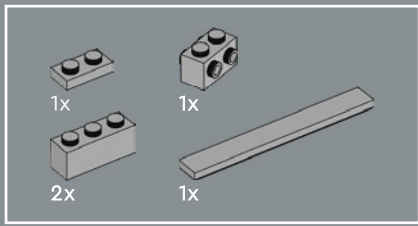

117

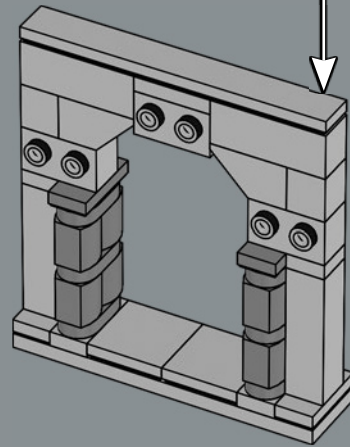
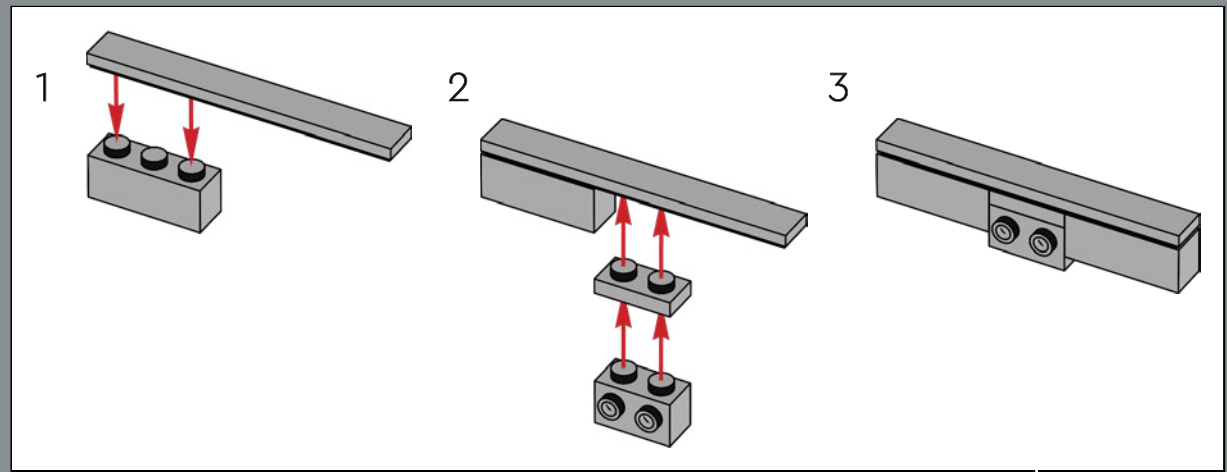

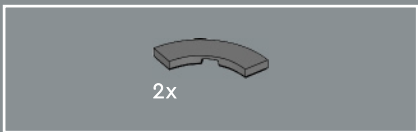

118

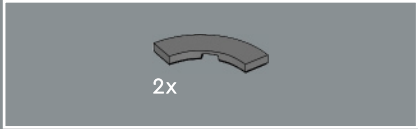
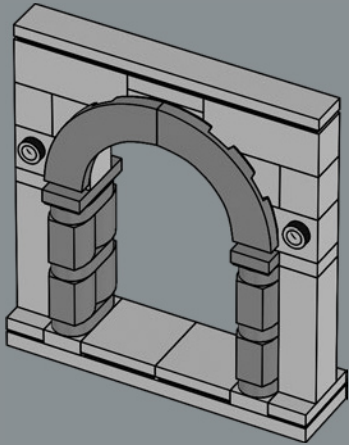

119

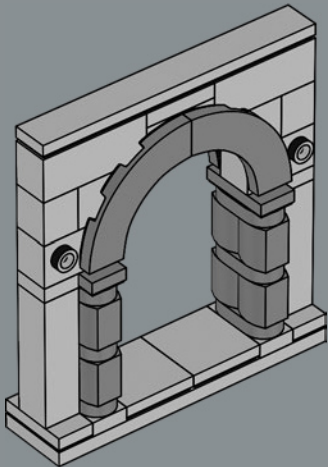

120

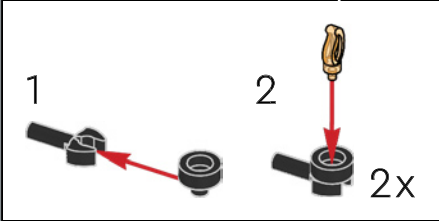
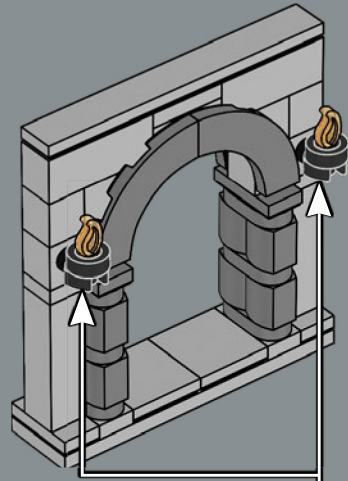

121

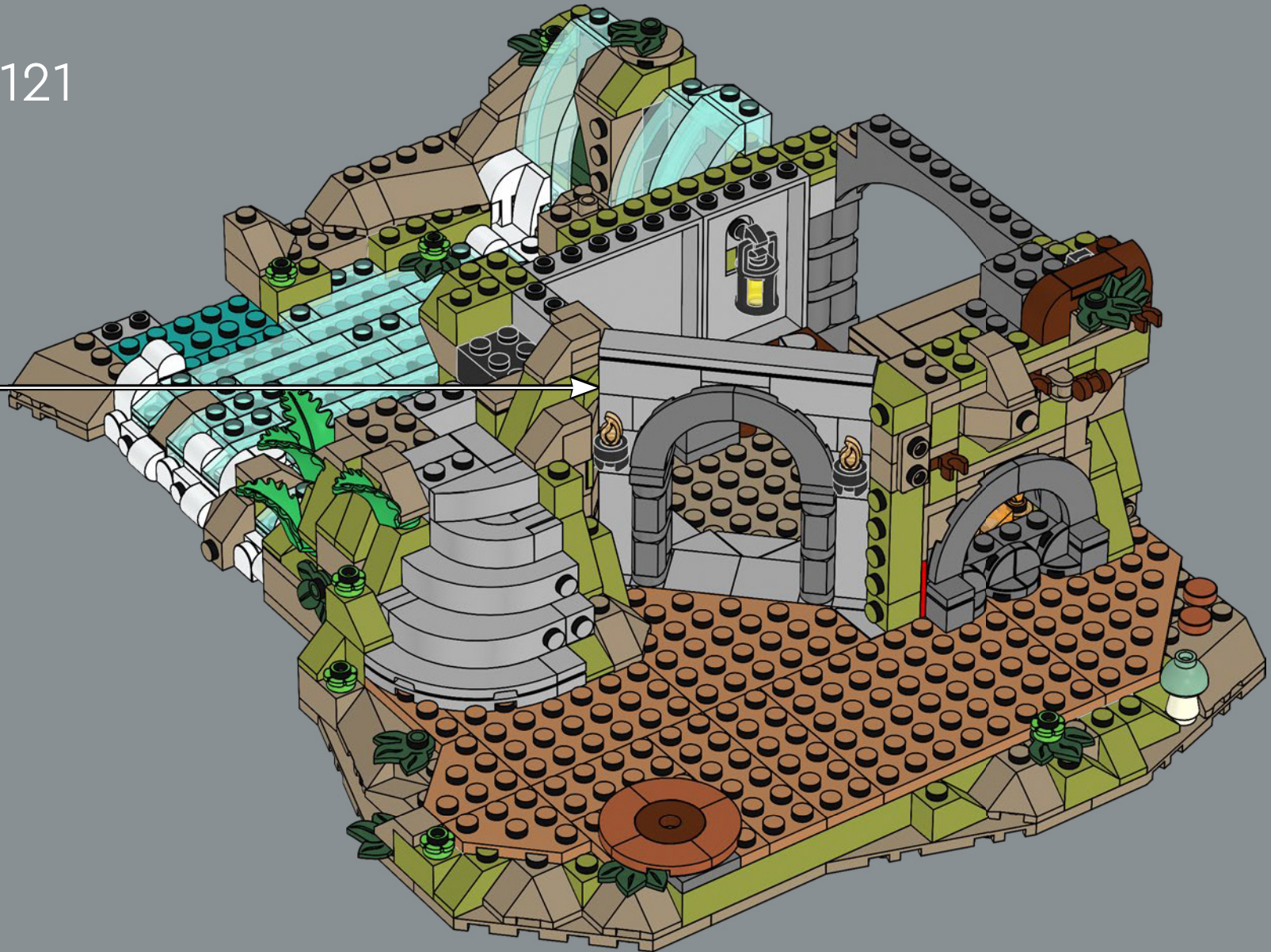

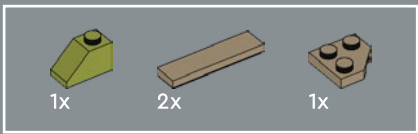

122

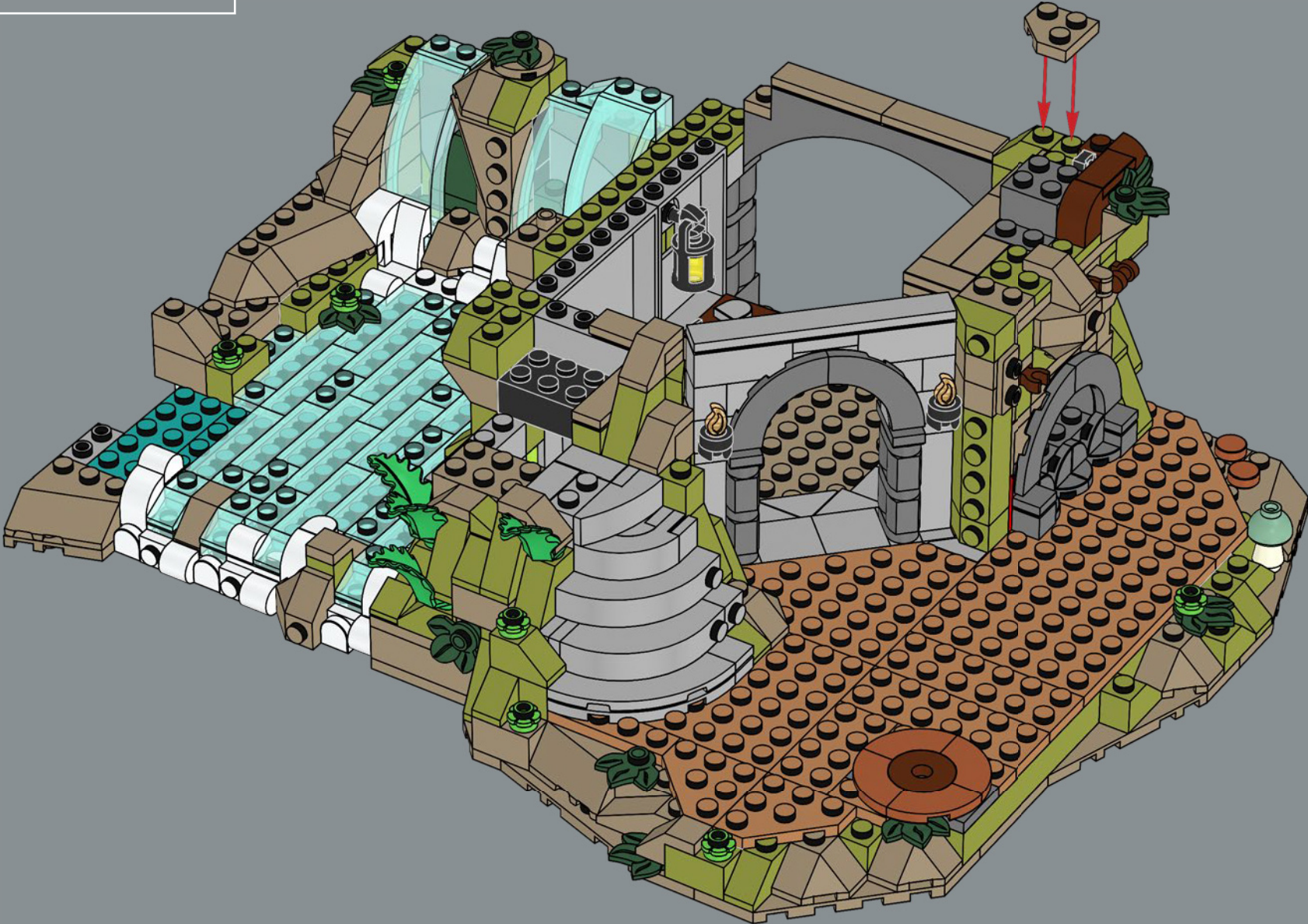

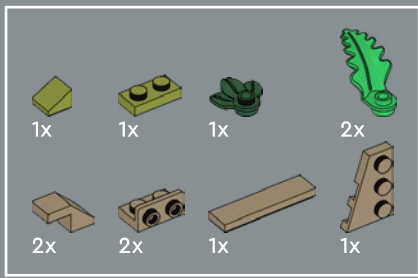

123

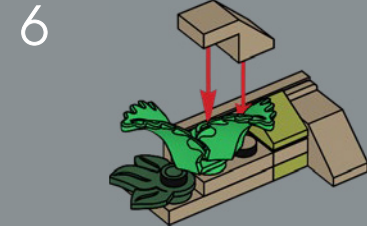
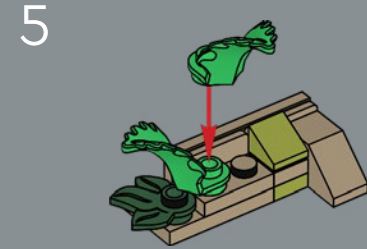
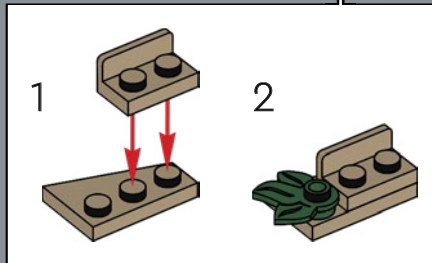
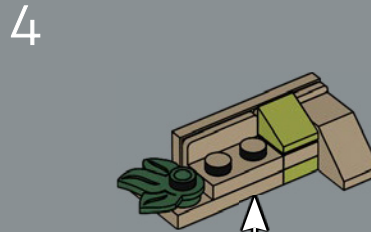
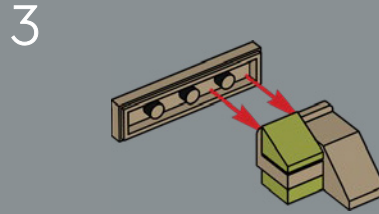
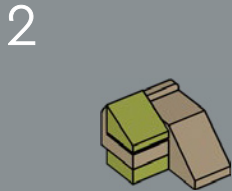
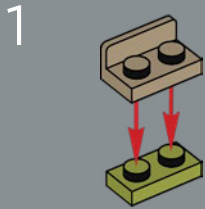

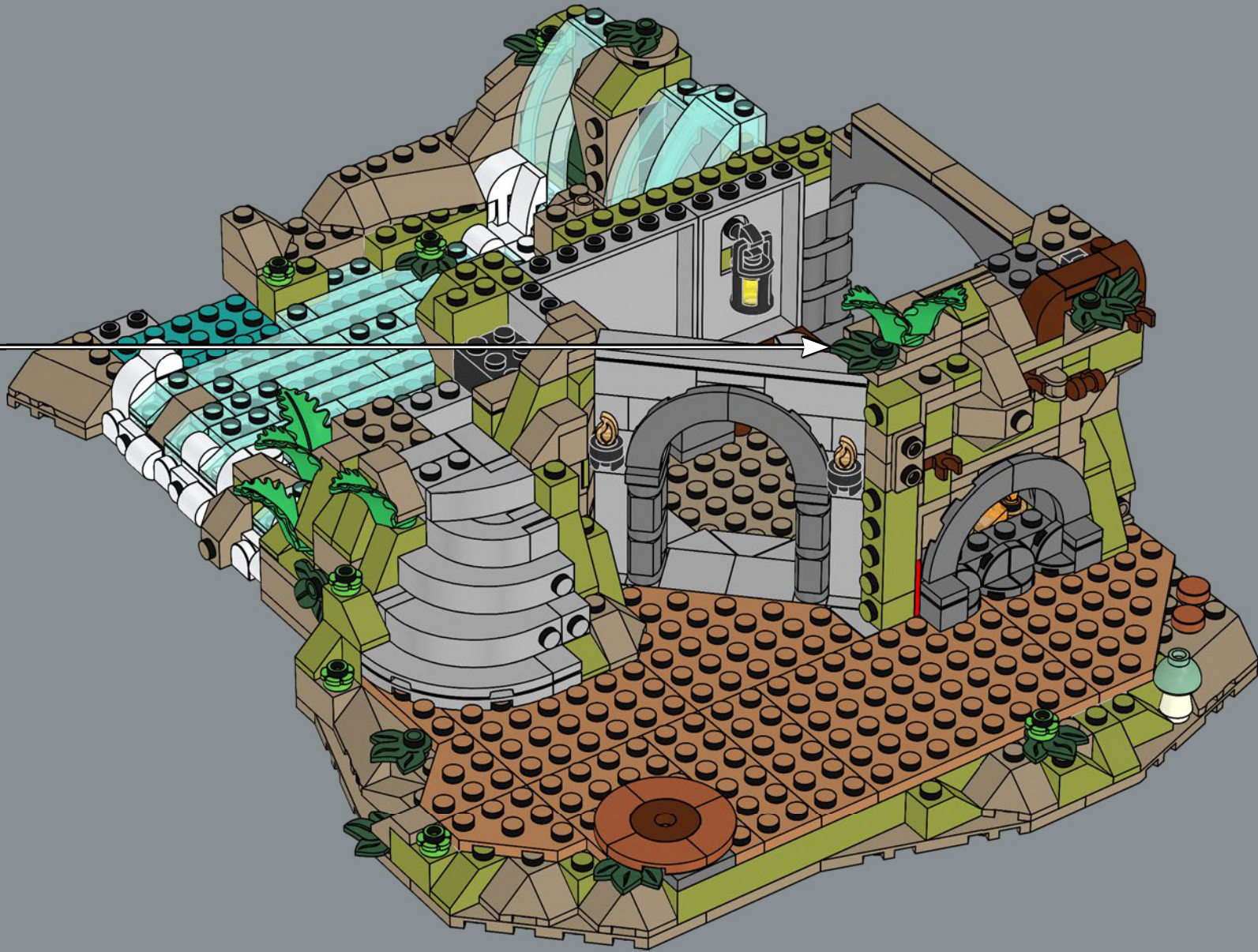

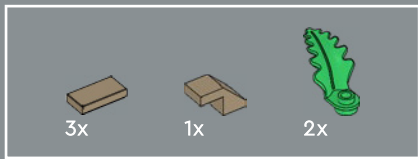

124

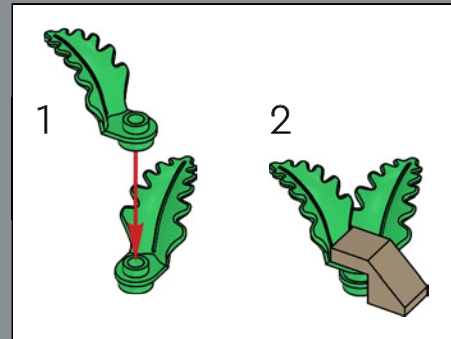

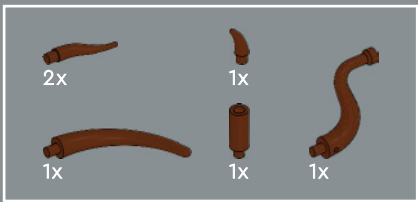

125

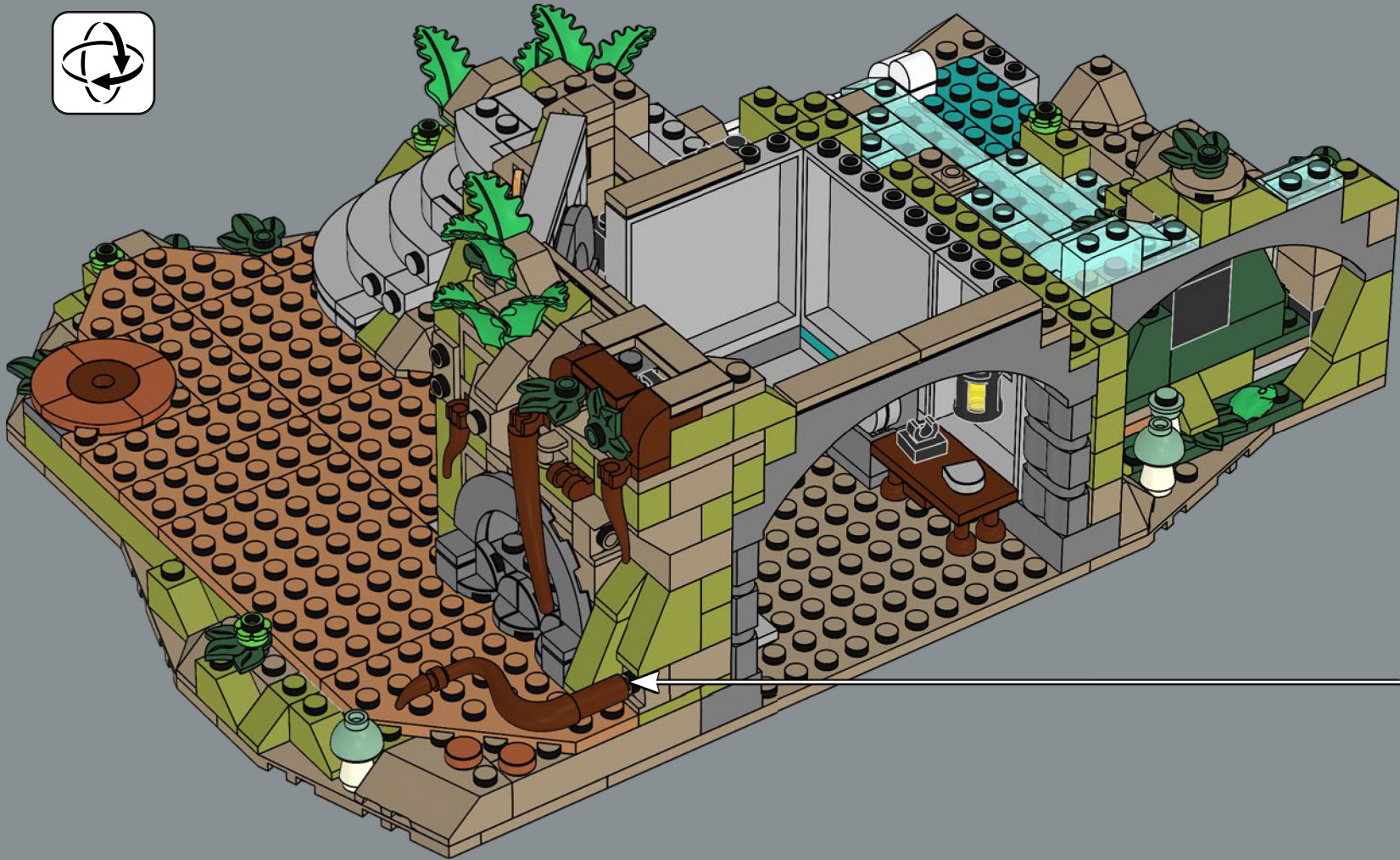
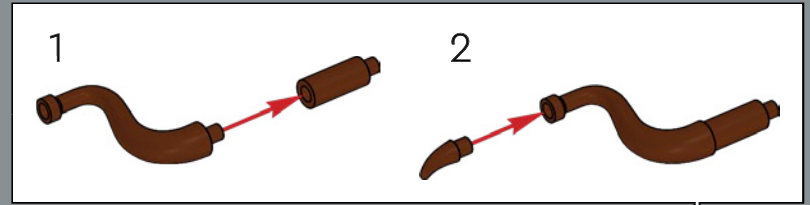

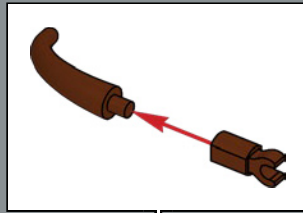
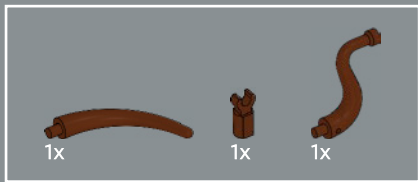

126

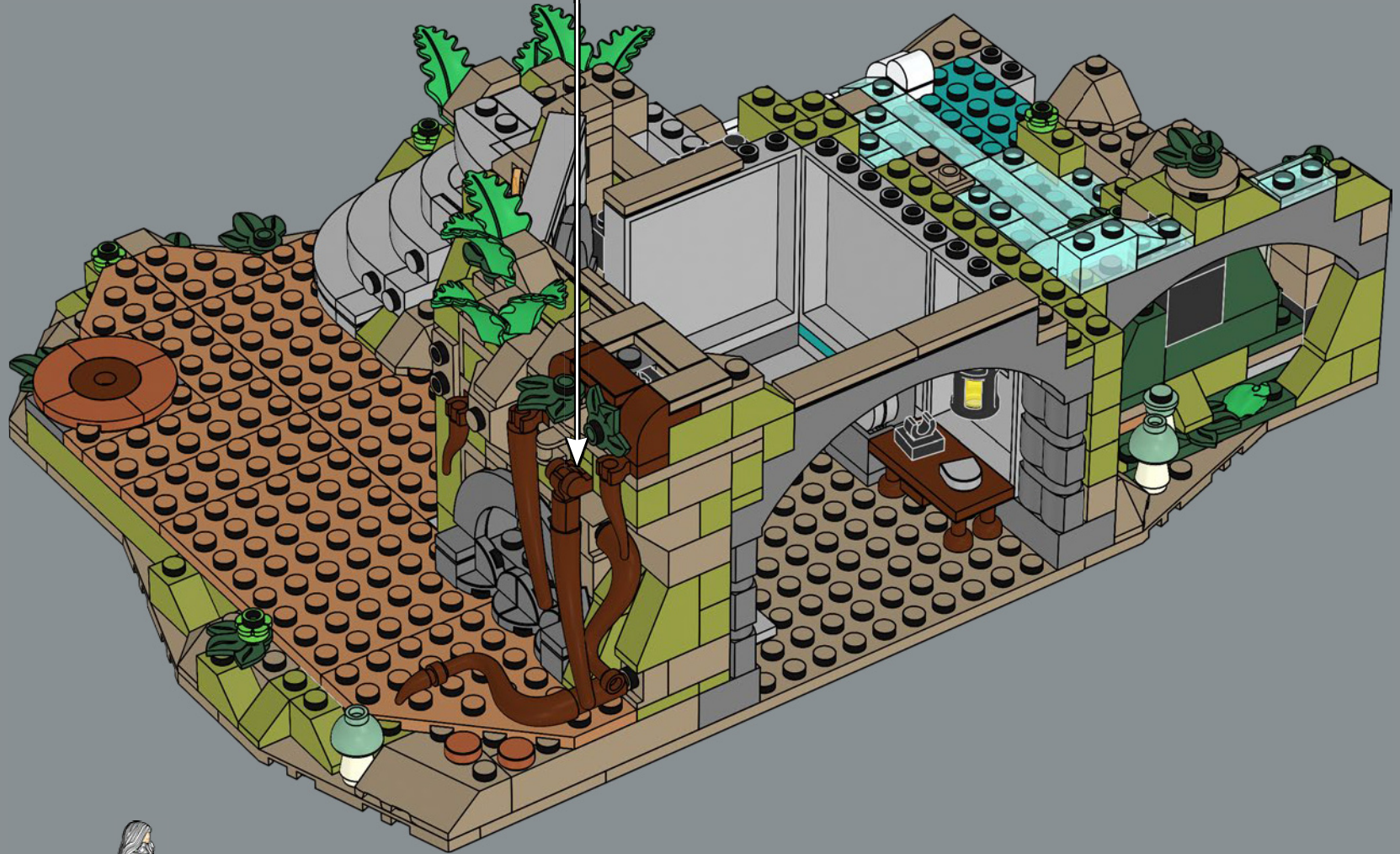

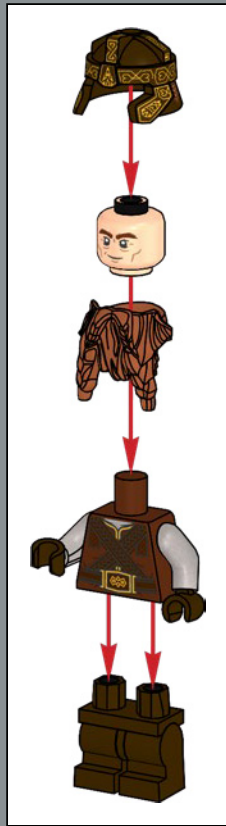
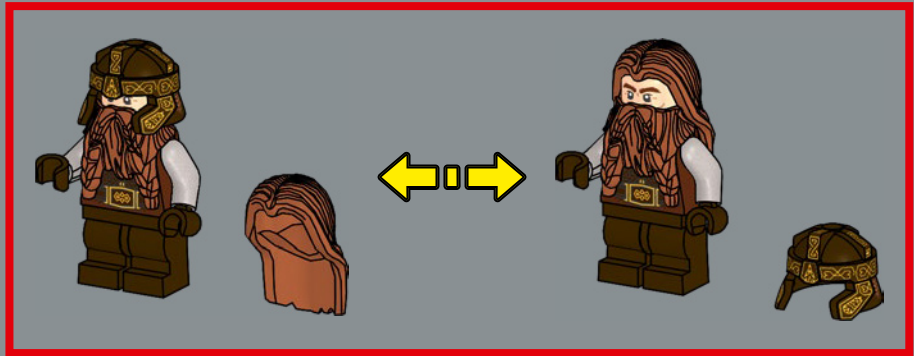

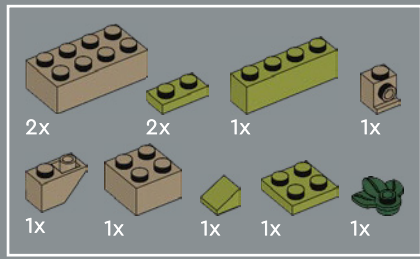

127

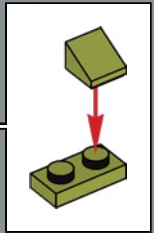
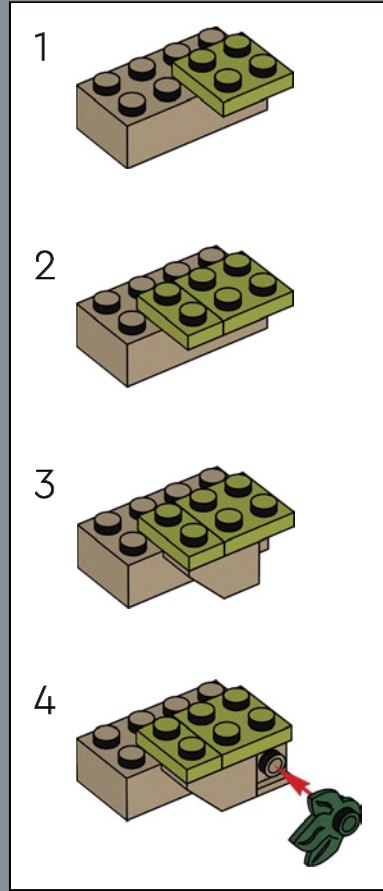

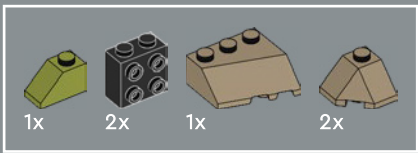

128

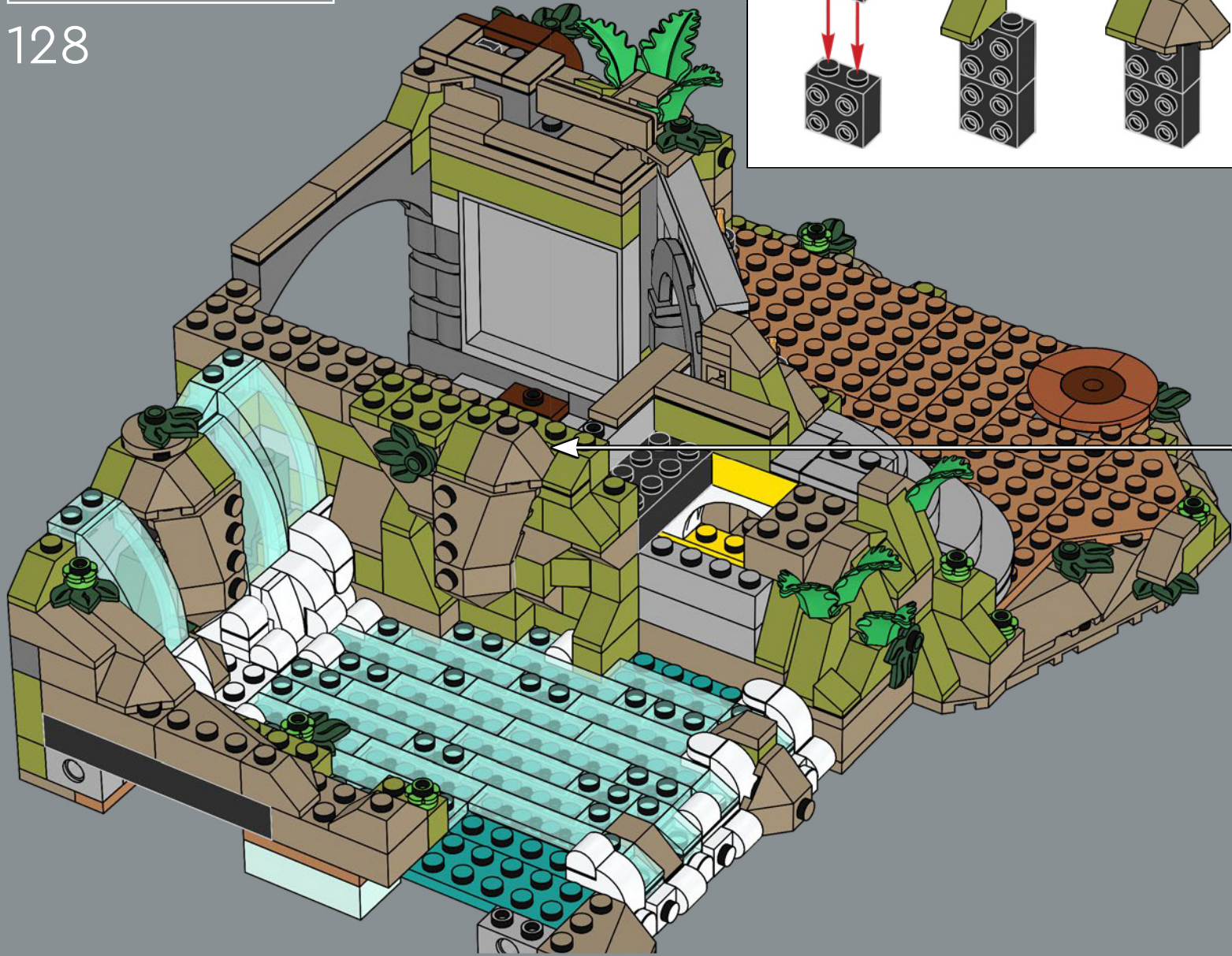
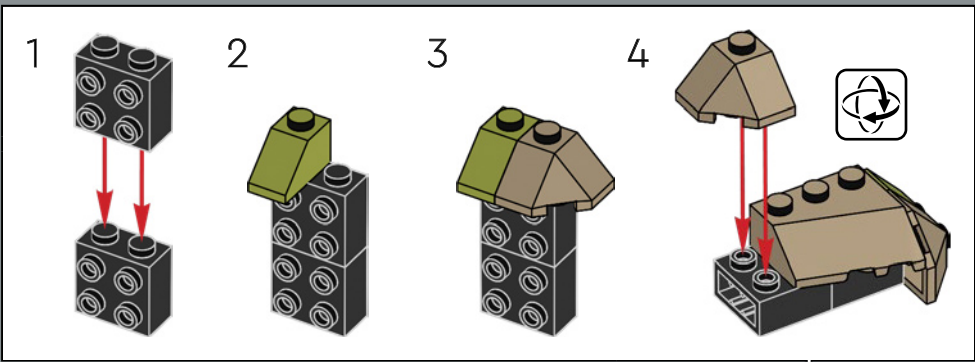

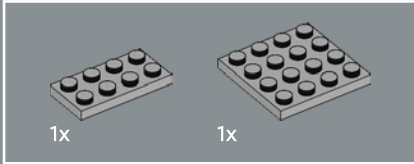
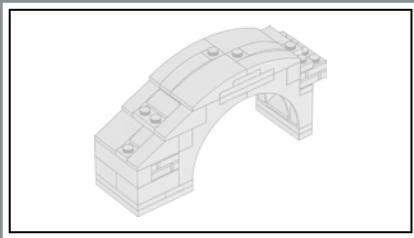

129

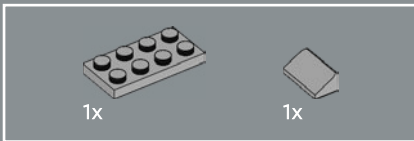
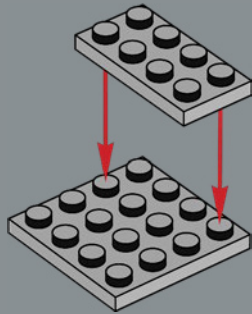

130

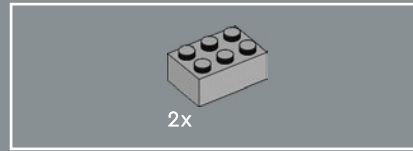
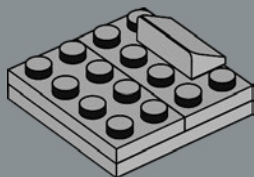

131

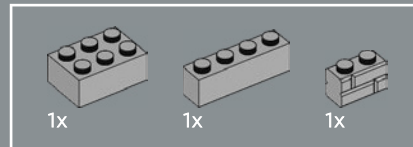
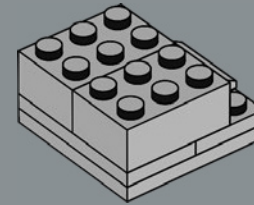

132

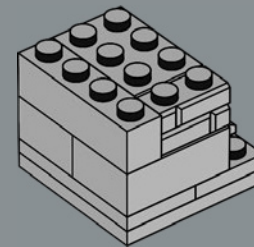

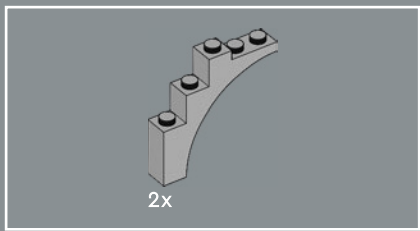

133

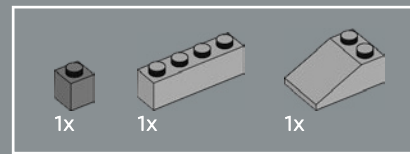
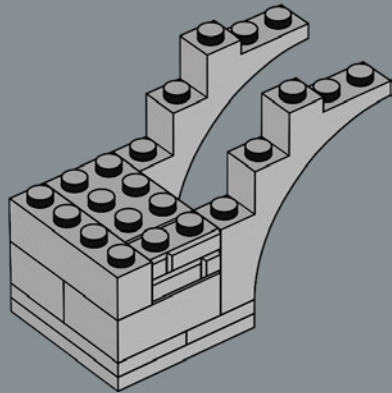

134

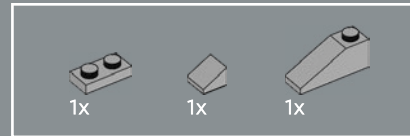
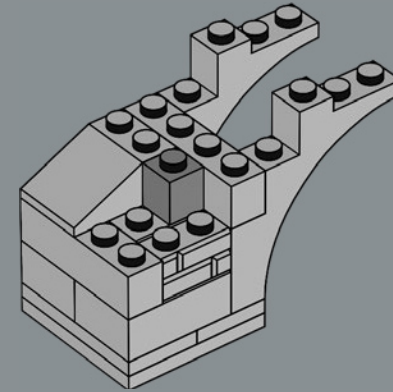

135

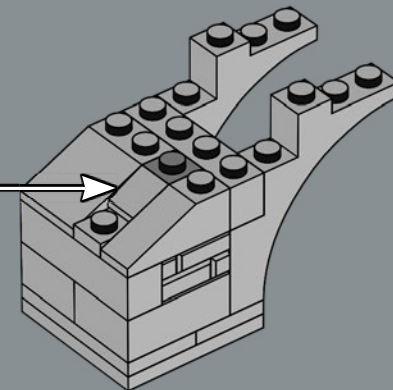
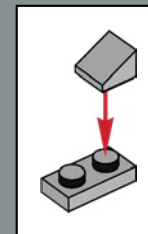

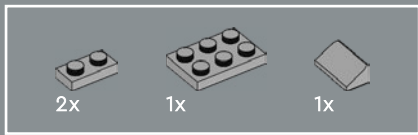

136

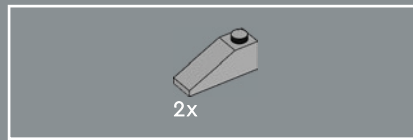
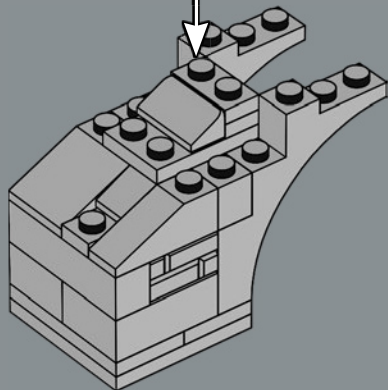
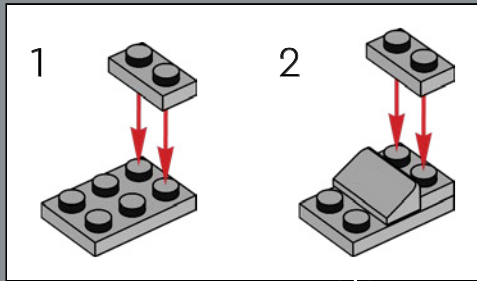

137

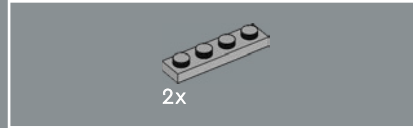
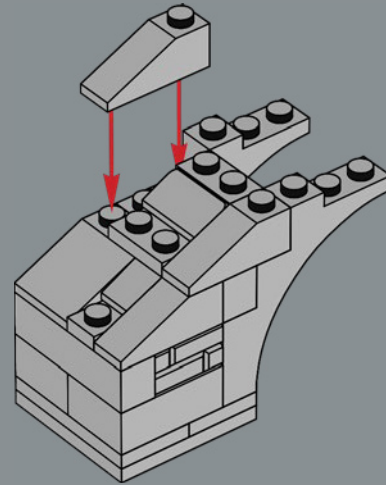

138

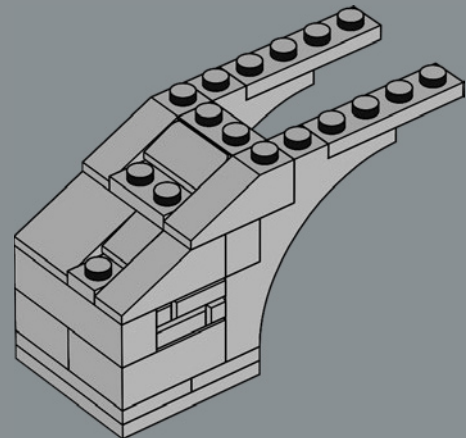

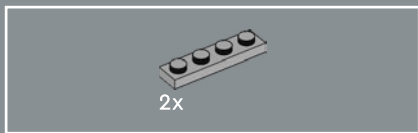

139

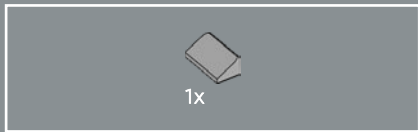
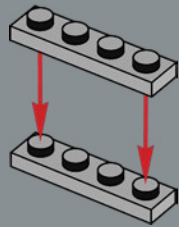

140

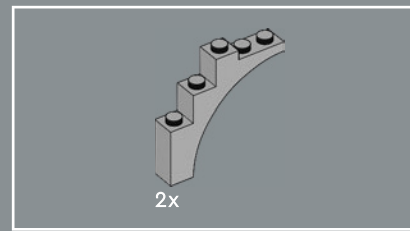
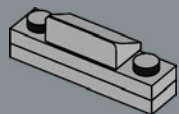

141

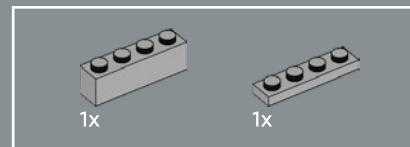
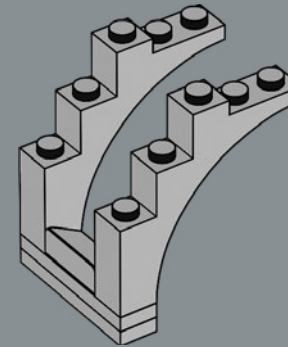

142

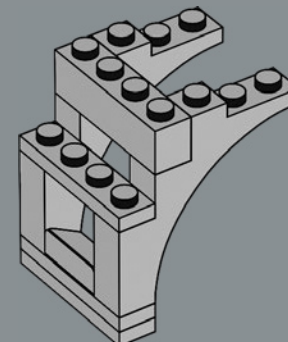

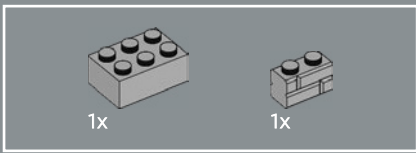

143

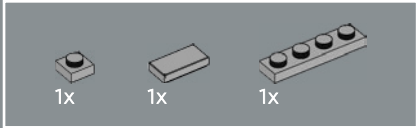
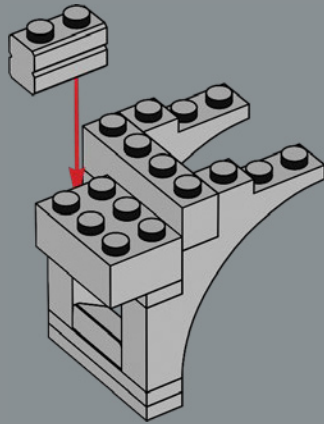

144

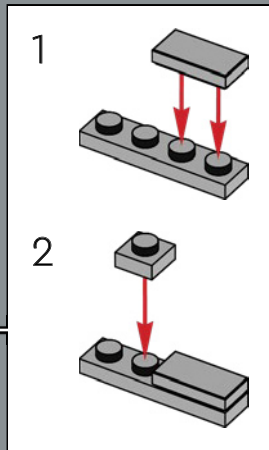
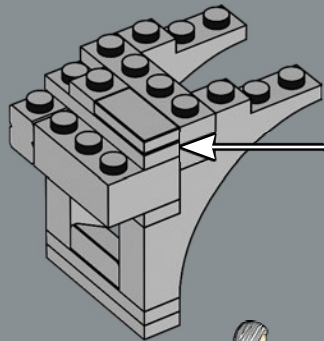

145

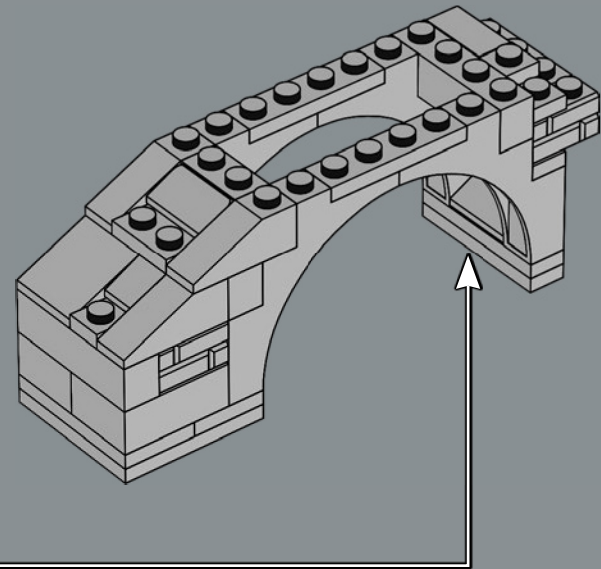

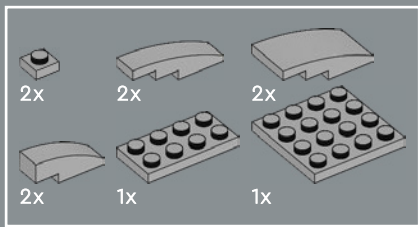

146

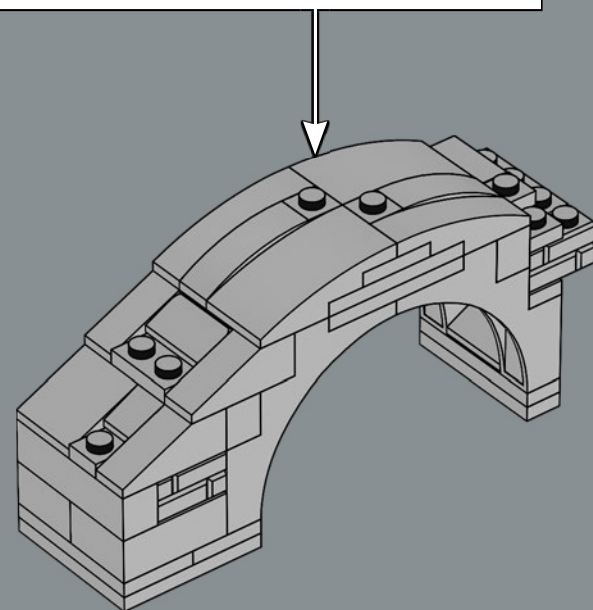
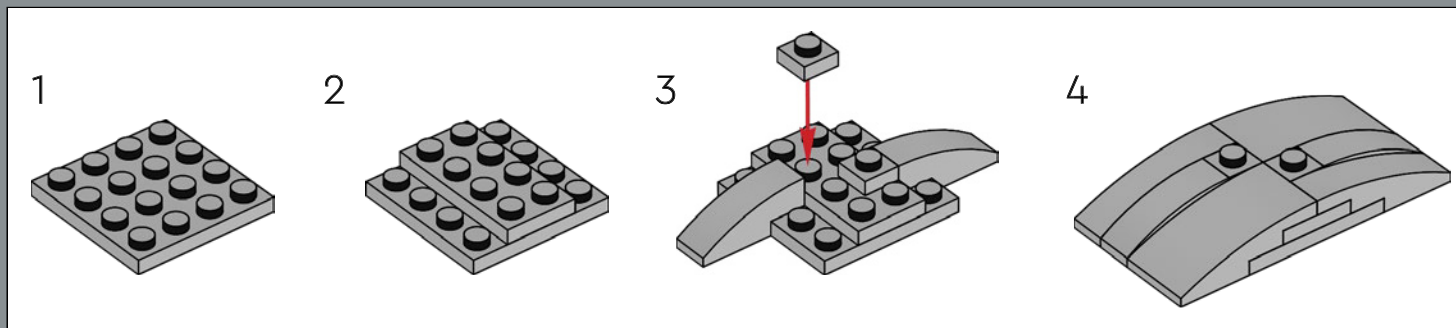

Because this bridge has no handrails, we added plenty of studs to its surface to make it safe for minifigures.

Comme ce pont n'a pas de main courante, nous avons ajouté de nombreux tenons à sa surface pour le rendre sûr pour les figurines.

Ya que este puente no cuenta con pasamanos, nos aseguramos de que su superficie tuviera montones de espigas para hacerlo más seguro para las minifiguras.

147

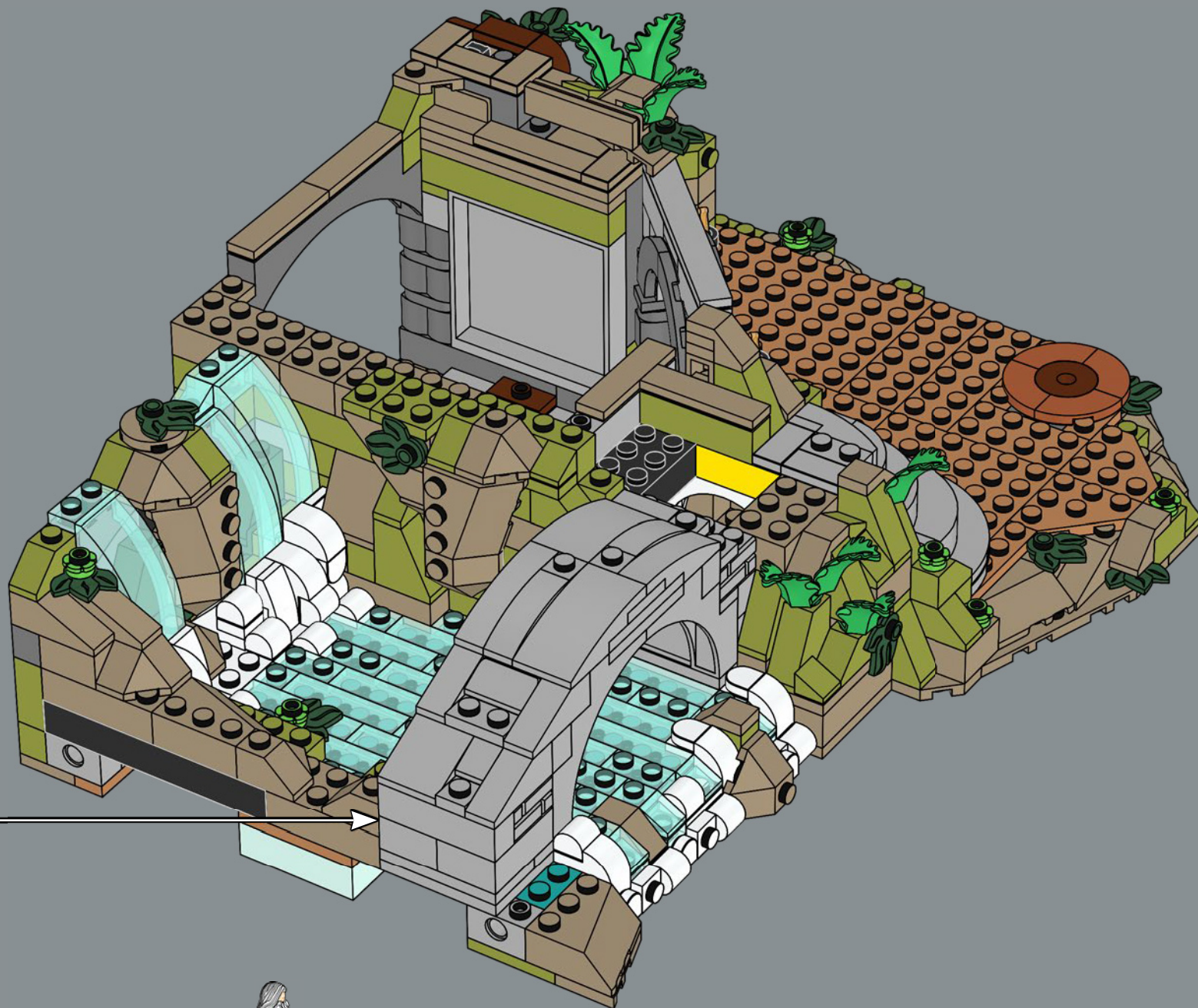

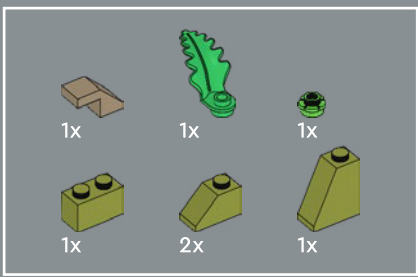

148

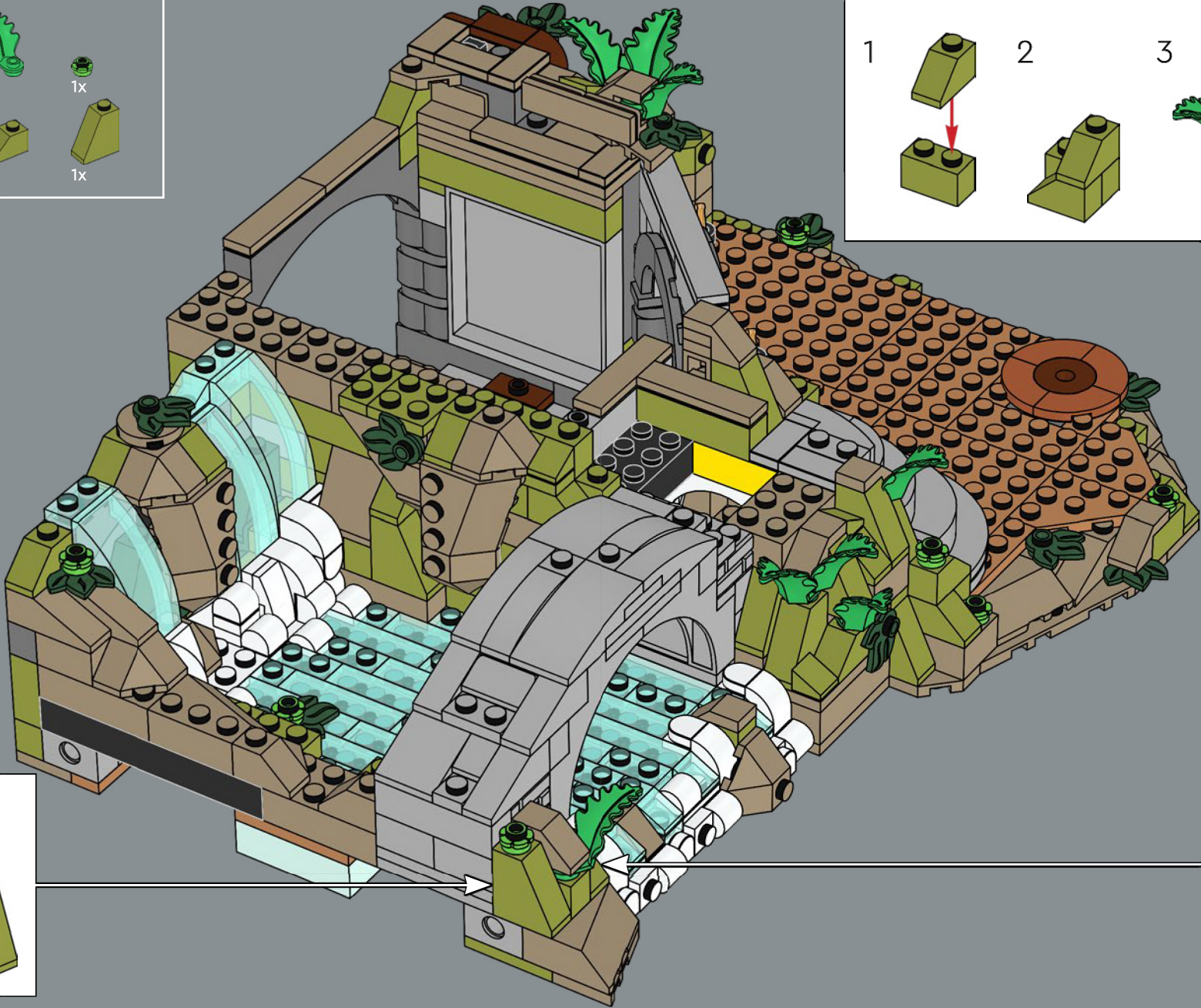
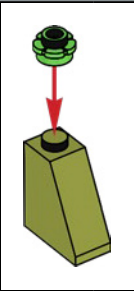
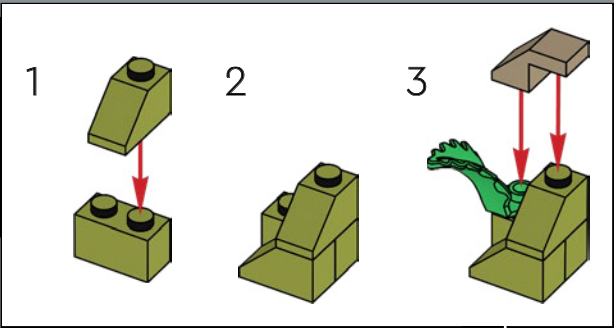

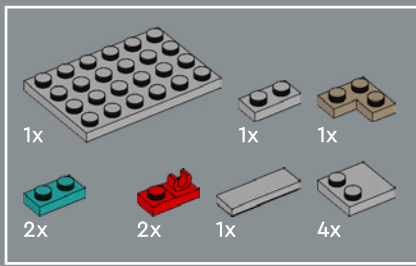

149

1

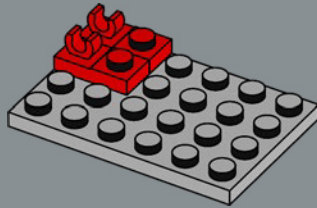

2

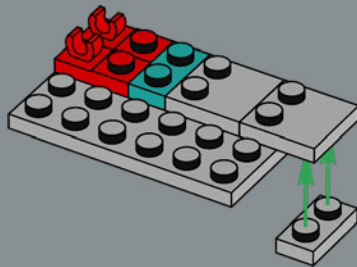

3

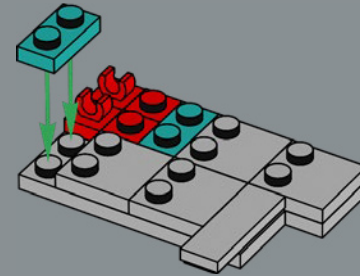

4

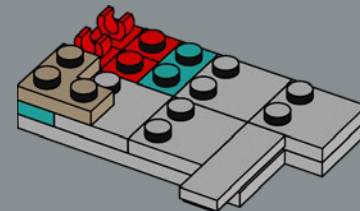

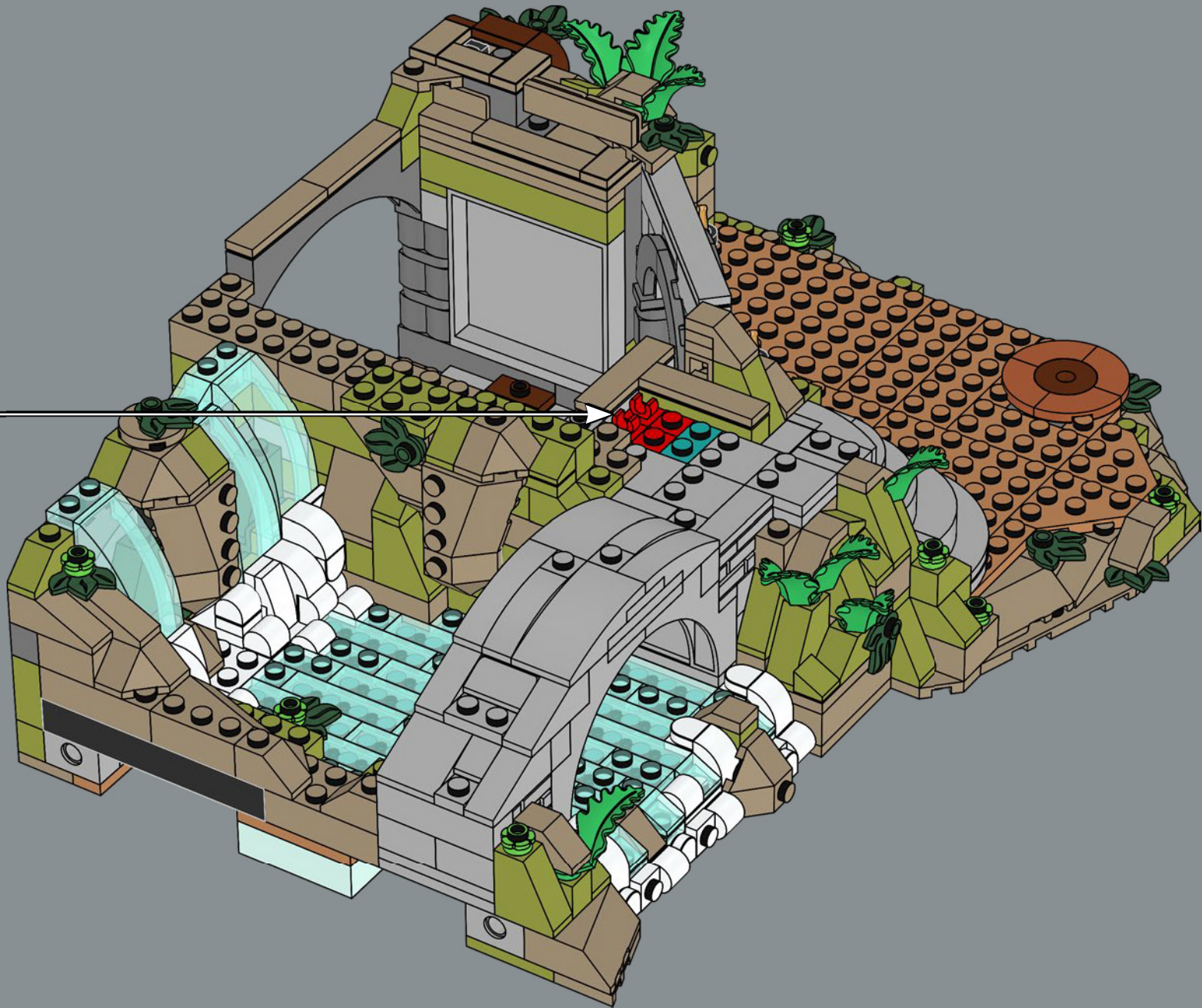



150

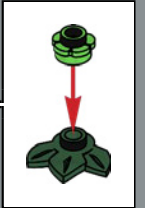
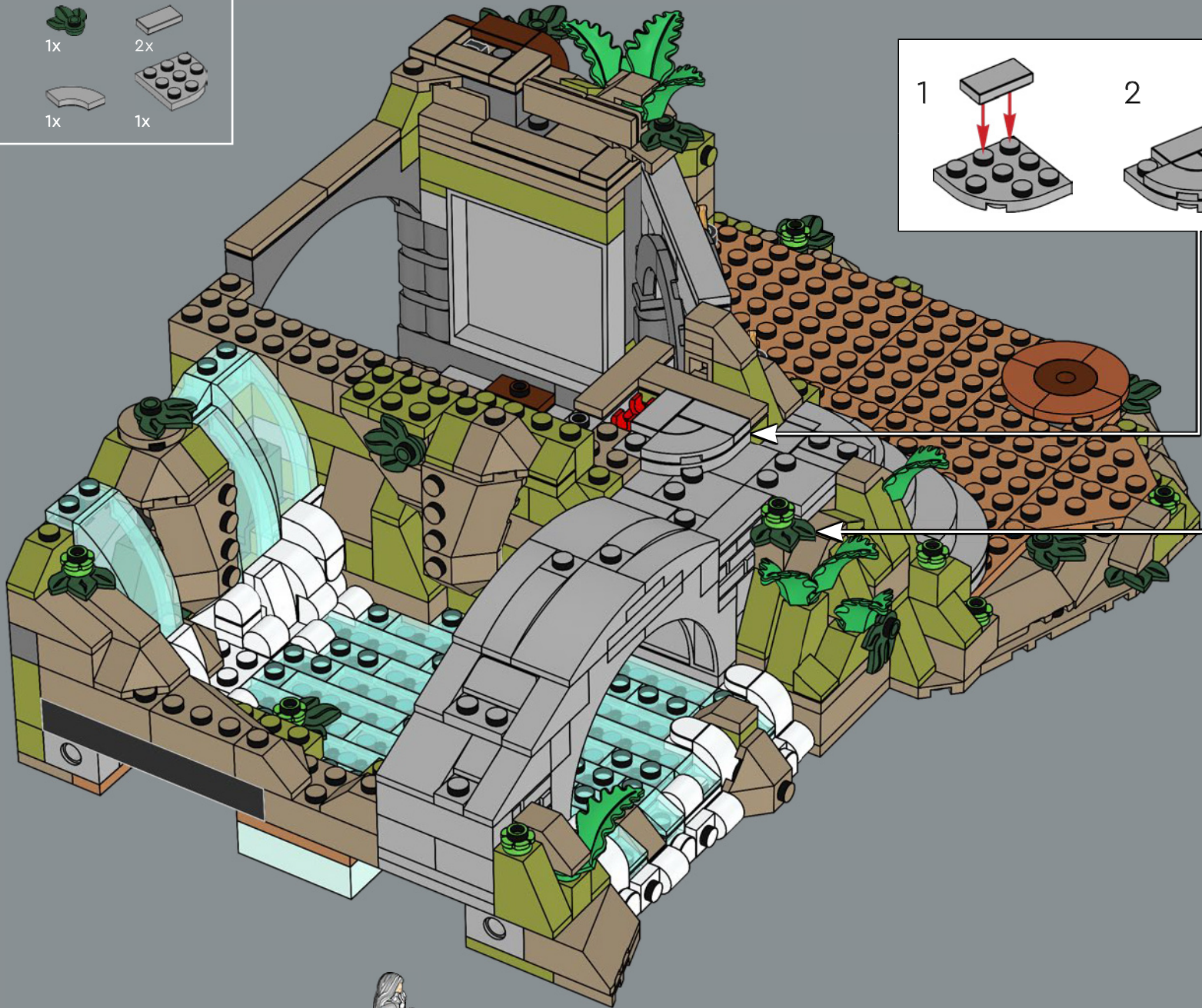
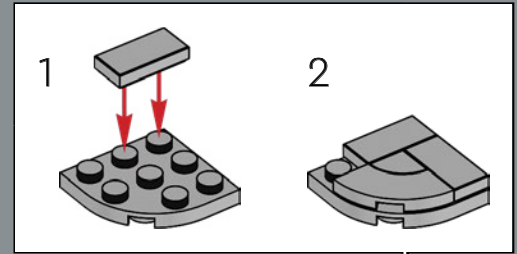

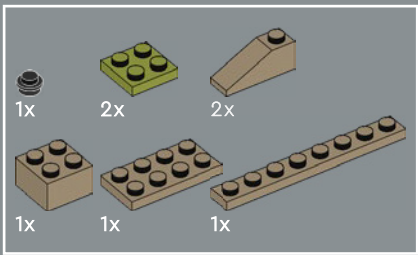

151

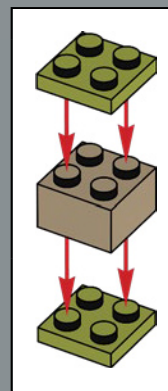
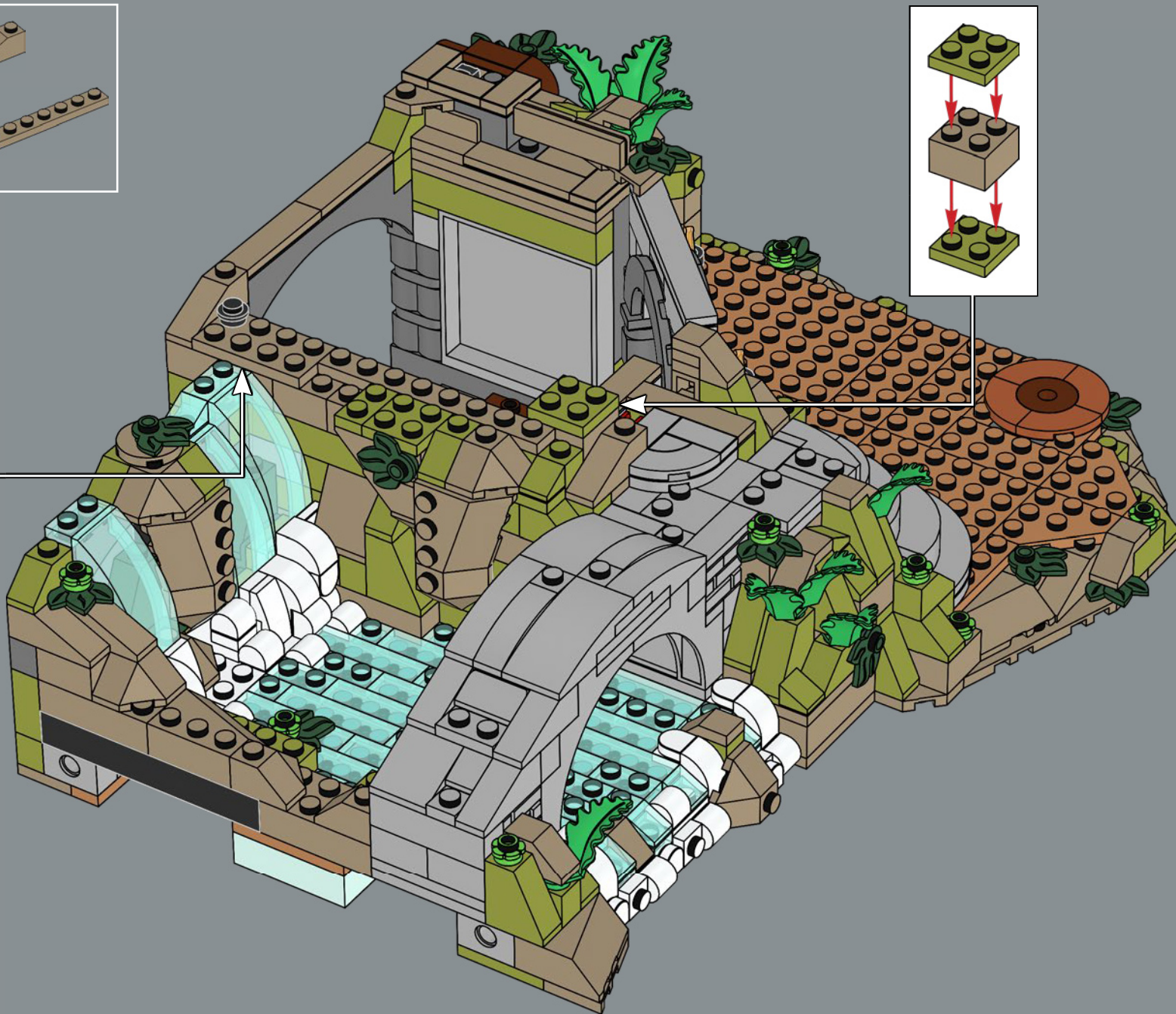
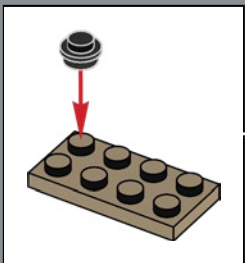

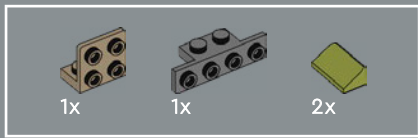

152

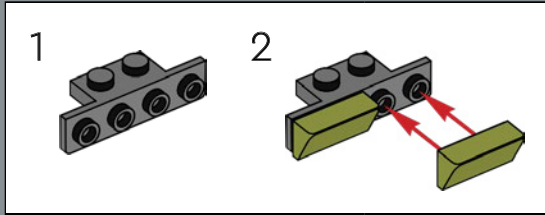

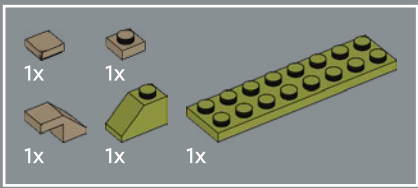

153

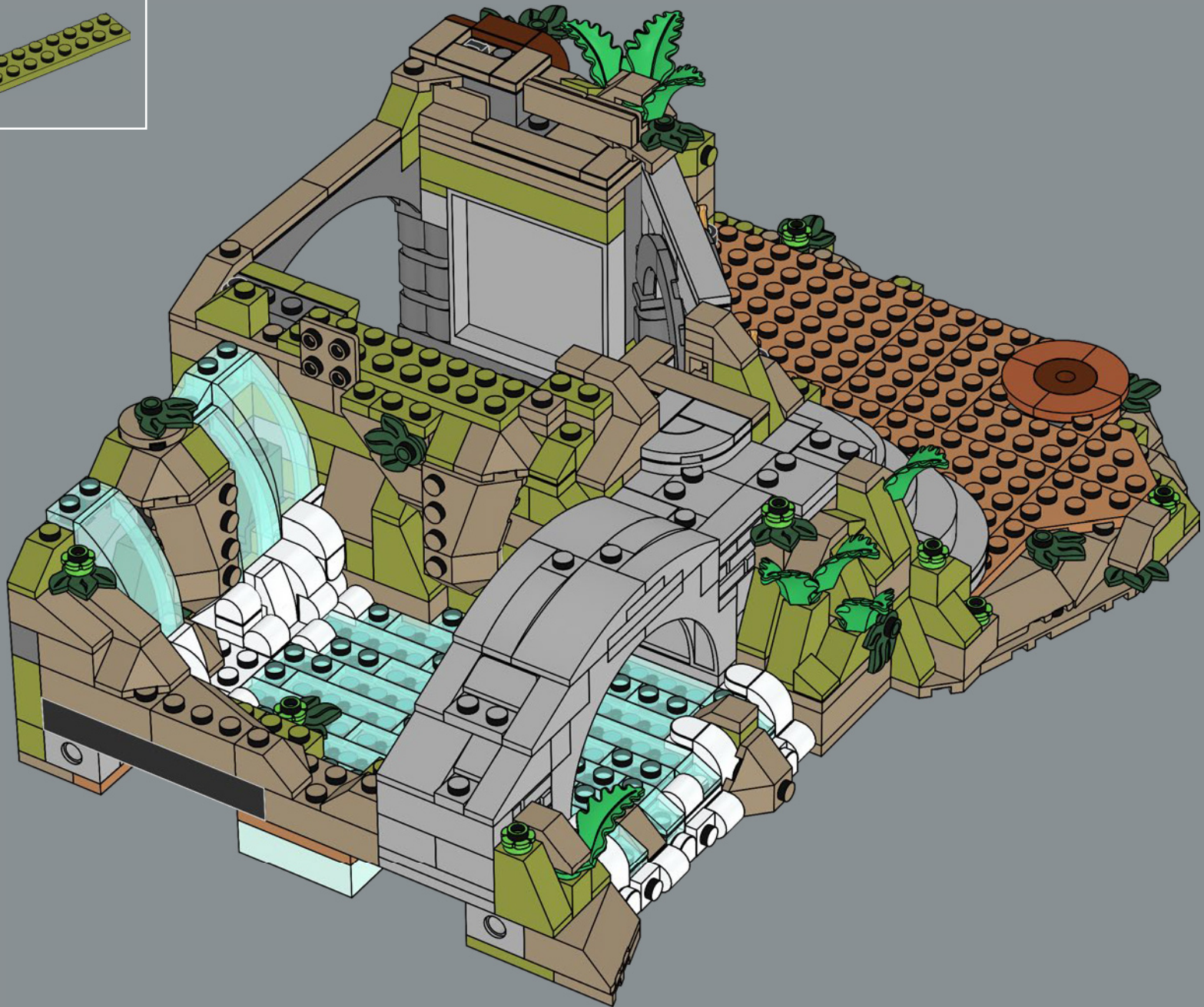

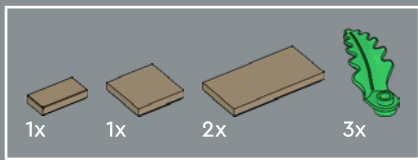

154

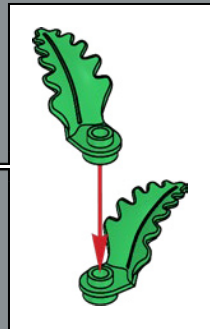
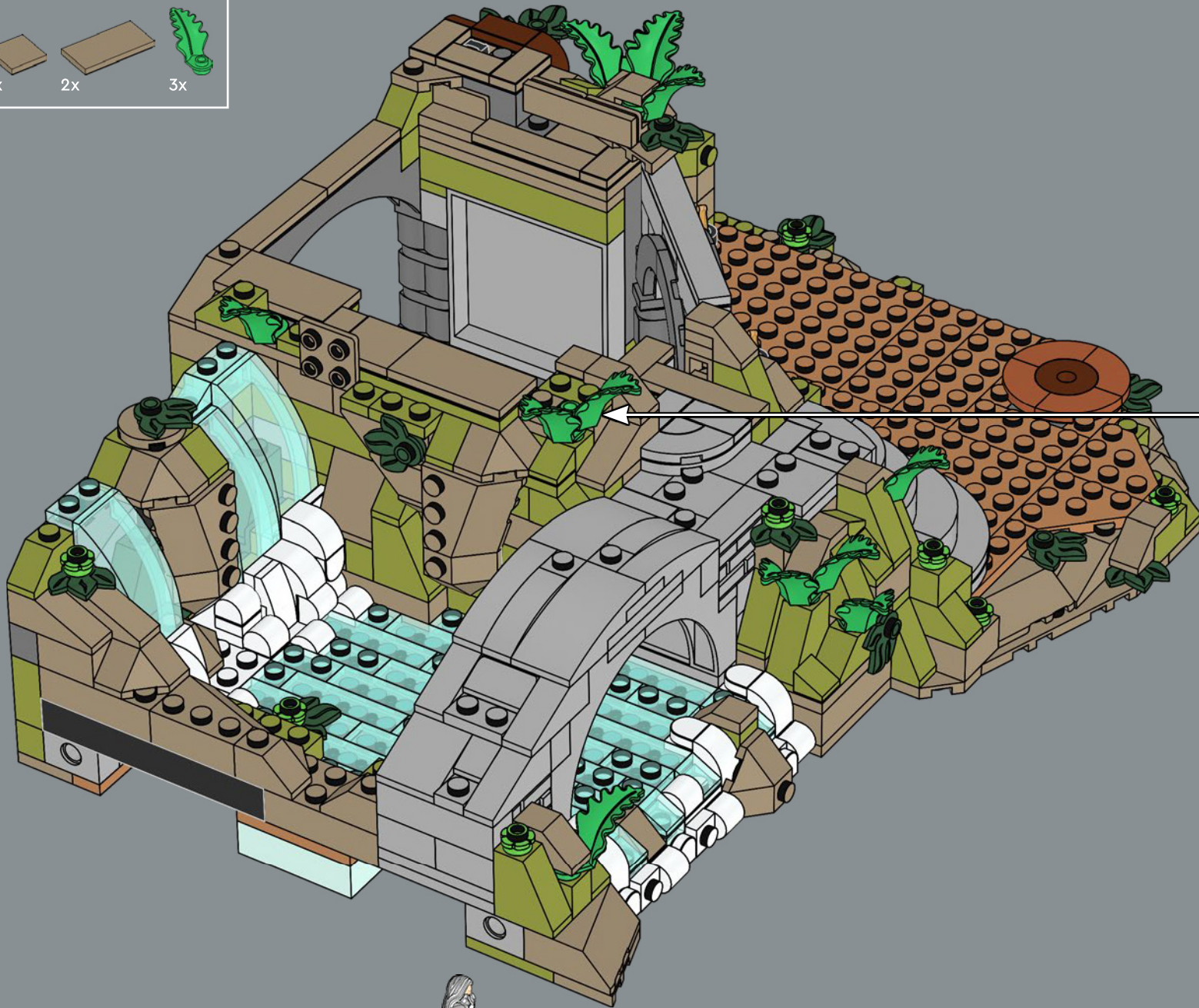

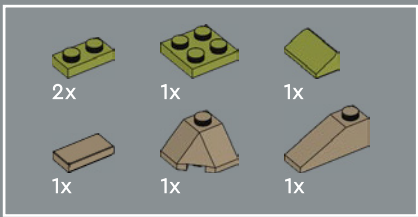

155

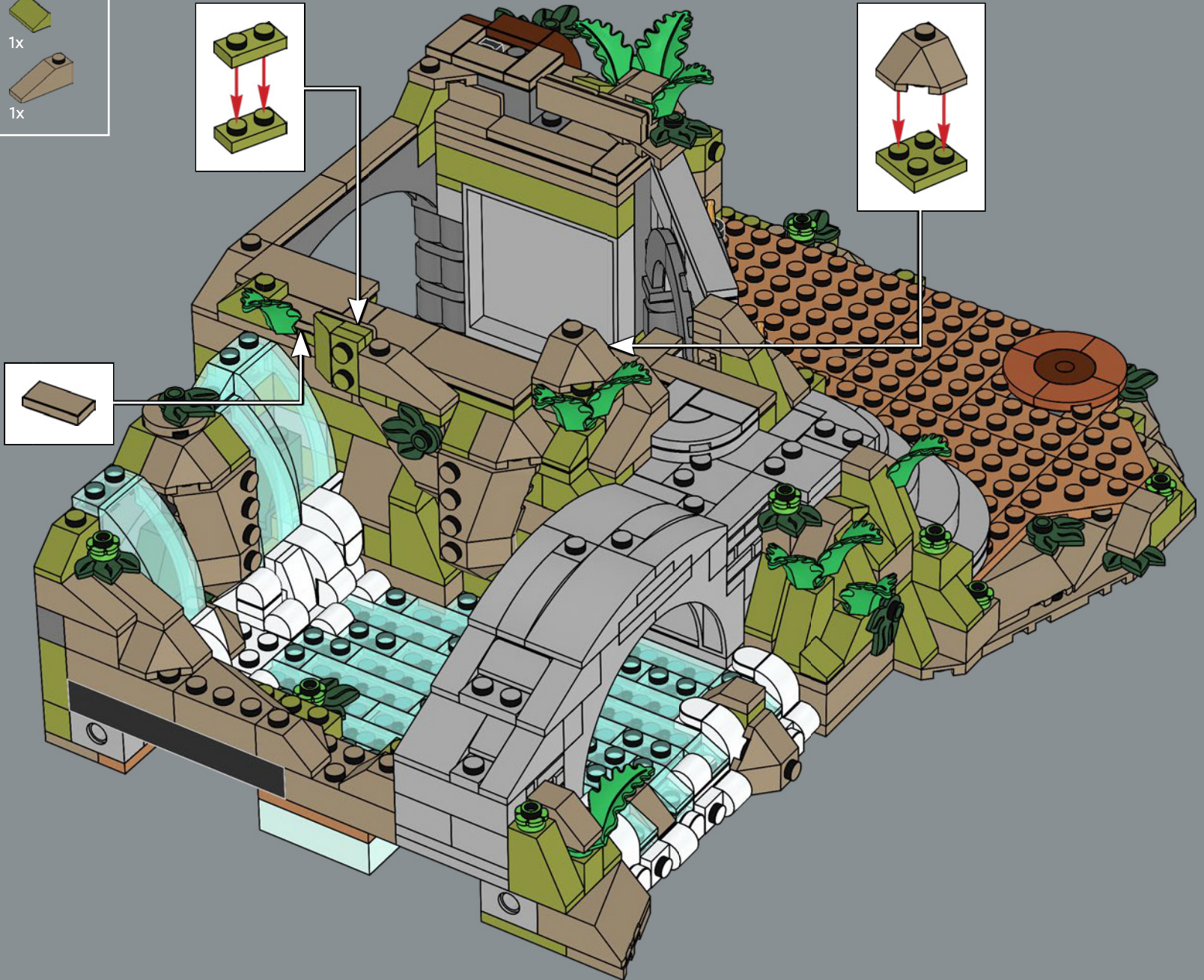
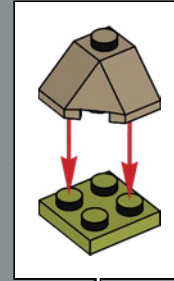
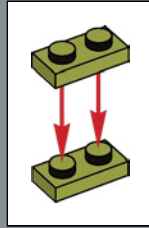

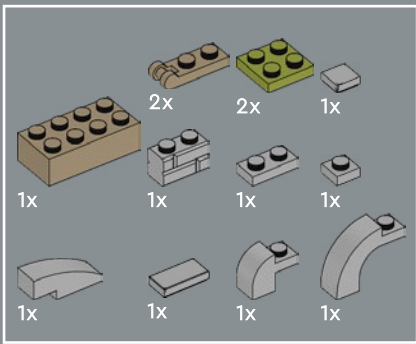

156

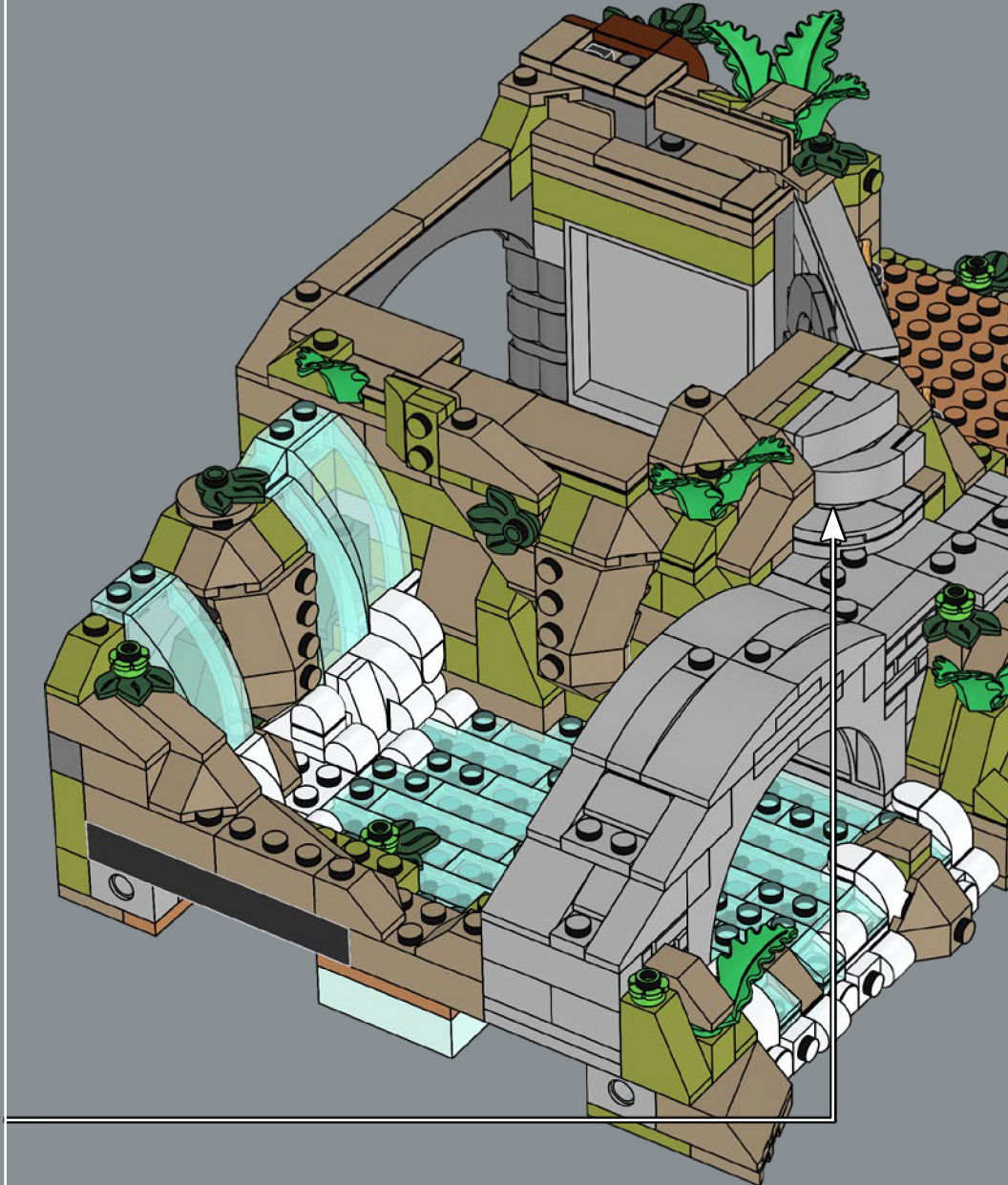
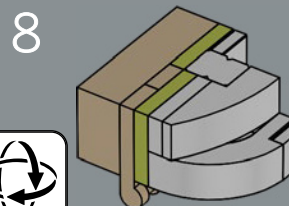
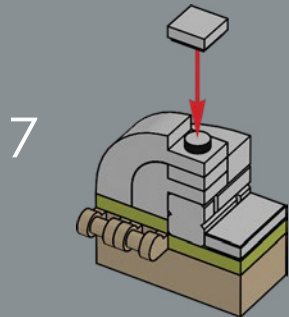
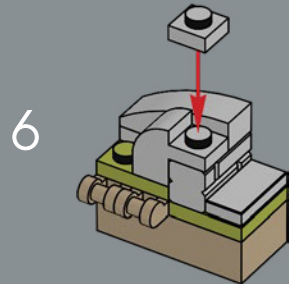
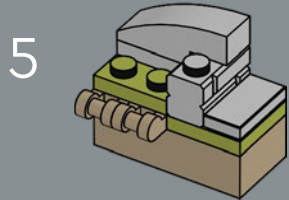
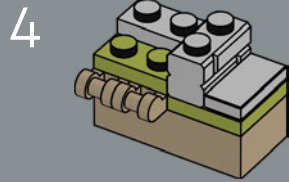
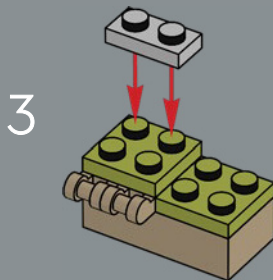
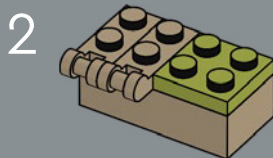
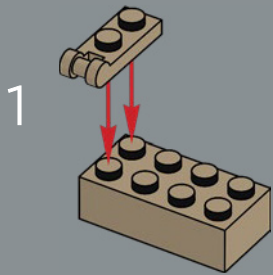



The elf wig is a brand-new element for this set, molded in two different materials to provide the color for the ears and hair separately.

La perruque de l'Elfe est un tout nouvel élément pour cet ensemble. Elle est moulée dans deux matériaux différents pour donner la couleur des oreilles et des cheveux séparément.

La peluca del elfo es un elemento nuevo, diseñado específicamente para este set. Se moldea en dos materiales diferentes para dar color a las orejas y el cabello por separado.

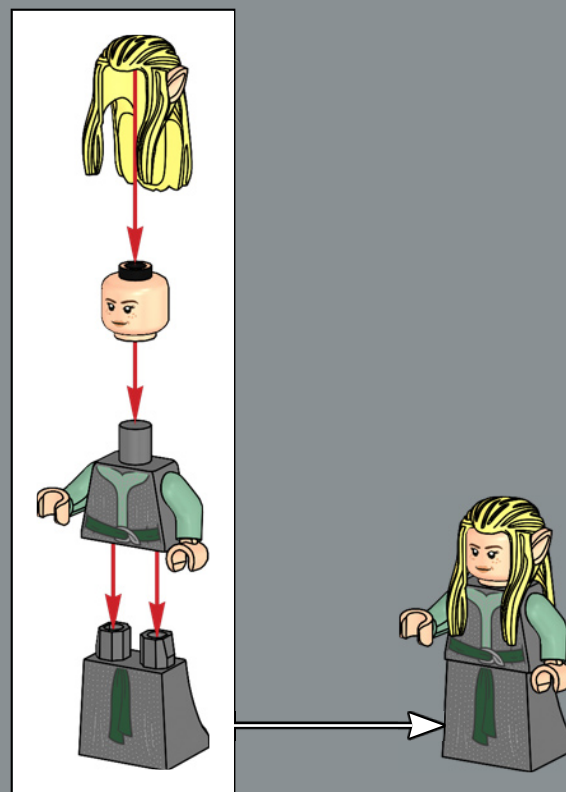

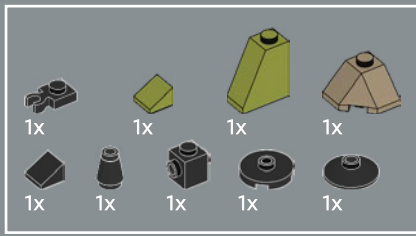

157

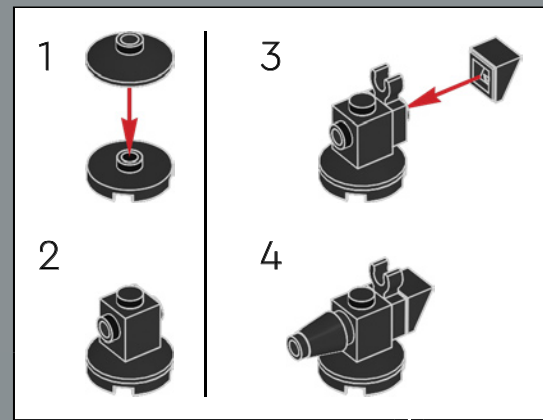

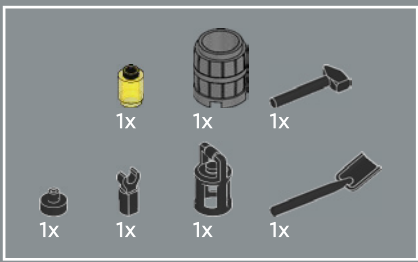

158

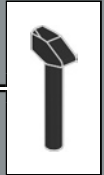
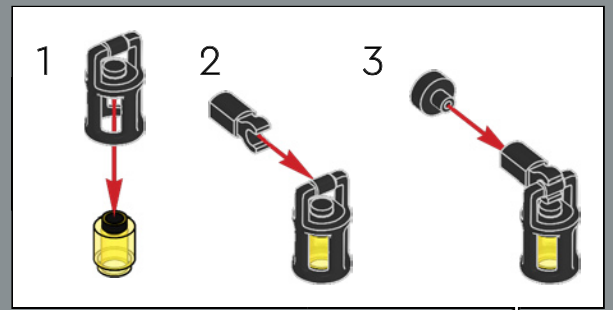

-  2x
-  2x
-  3x
-  2x
-  1x

159

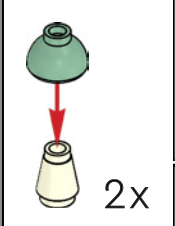
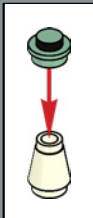
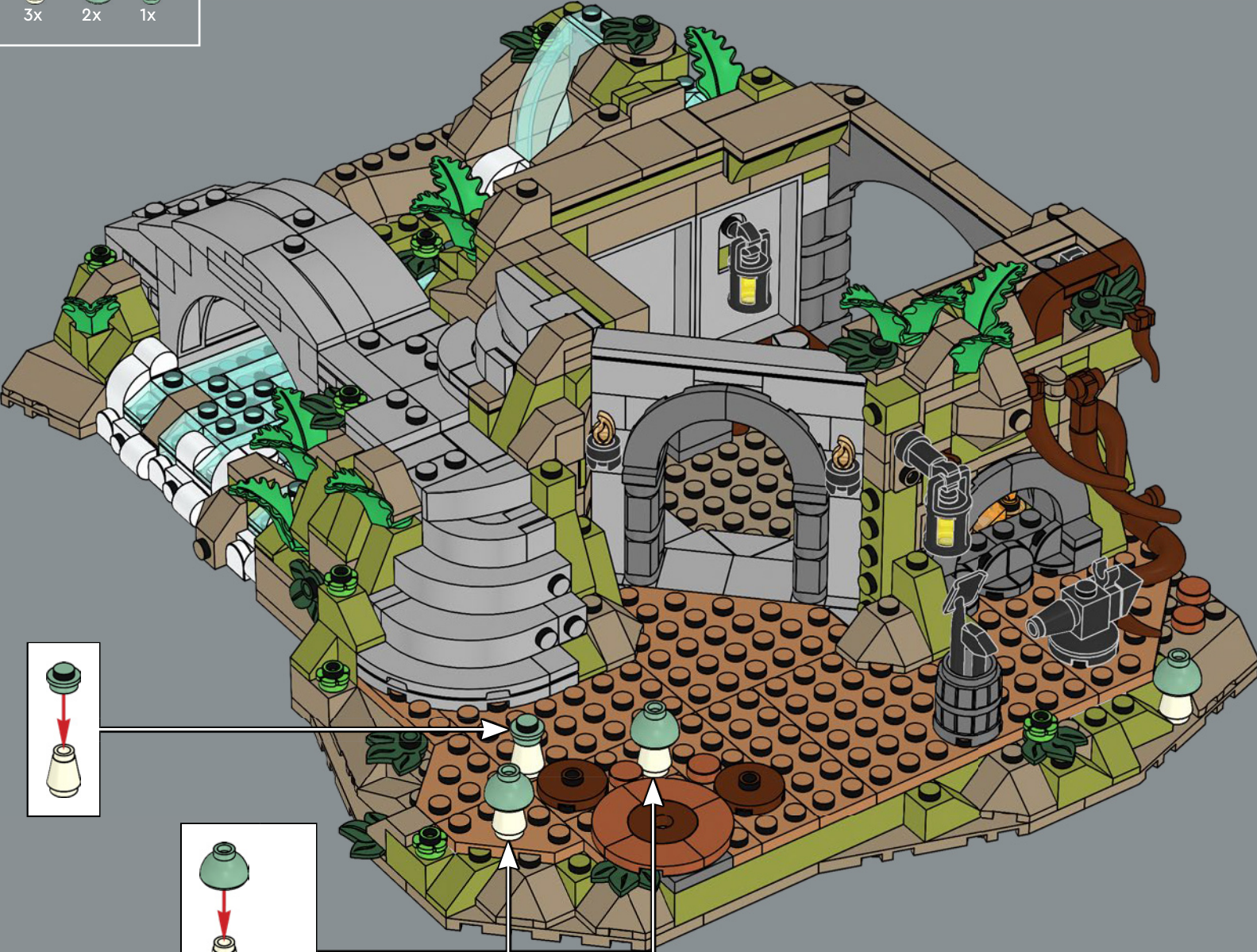

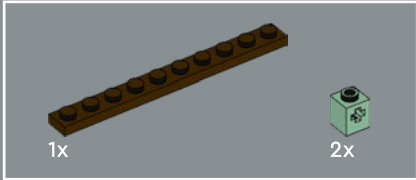
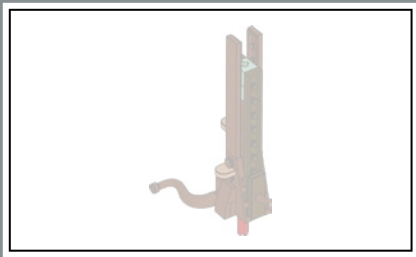

160

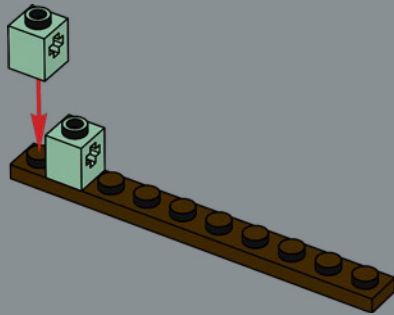

161

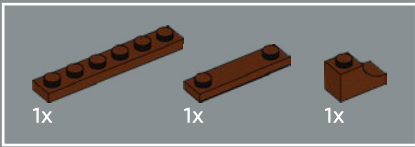
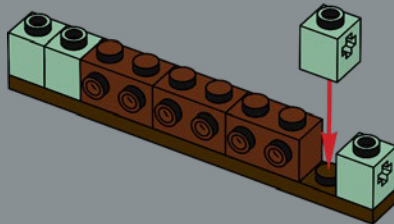

162

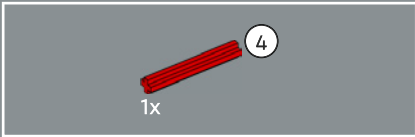
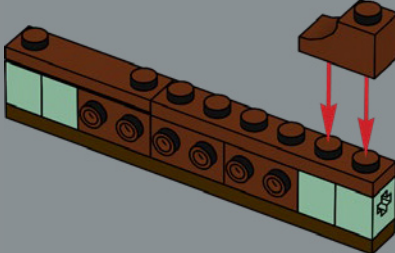

163

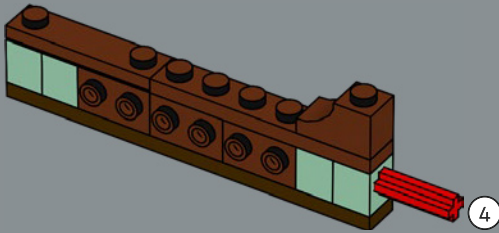

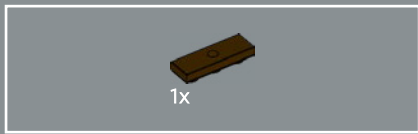

164

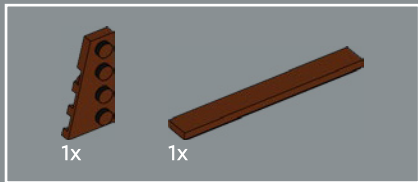
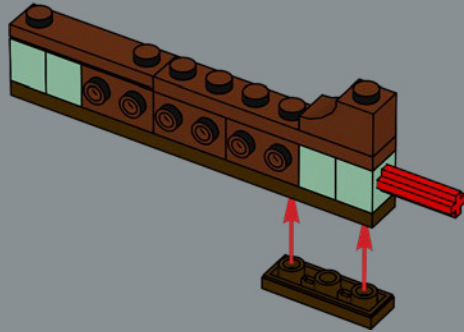

165

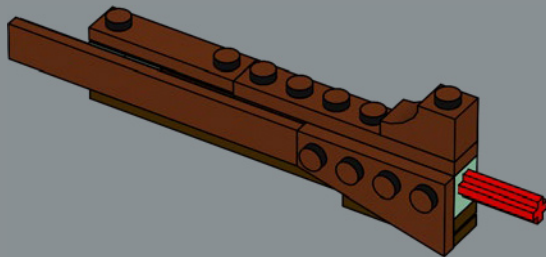

166

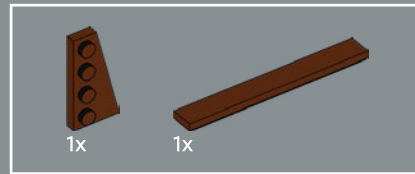
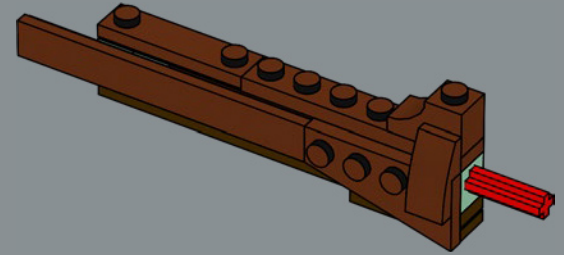

167

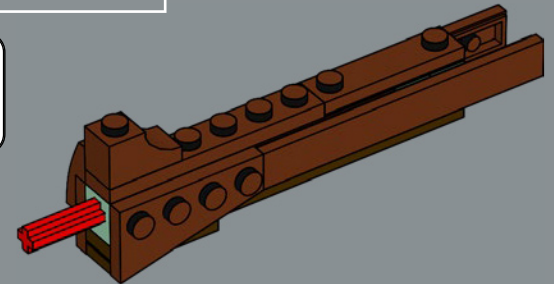



168

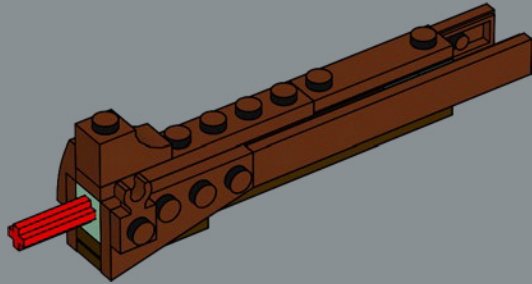

169

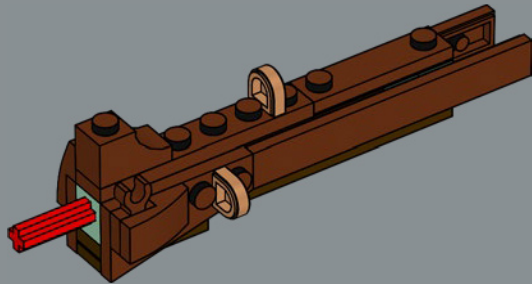

170

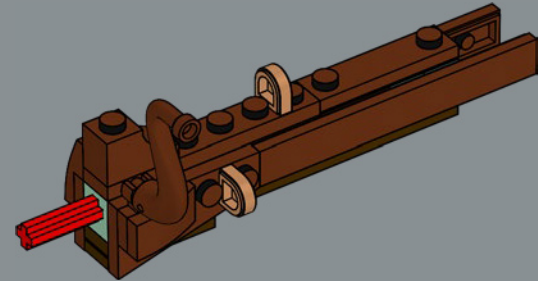

171

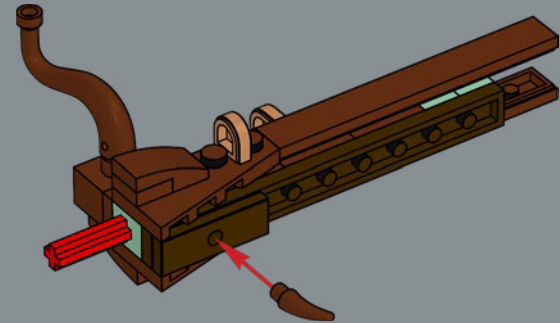



We have three different builds of fungi in the model, one of them made from just a single piece, a shortcut to mushrooms!

Nous avons trois modèles de champignons différents dans le modèle, dont l'un est composé d'une seule pièce !

El modelo incluye tres tipos distintos de hongos, uno de los cuales e compone de una sola pieza.

172

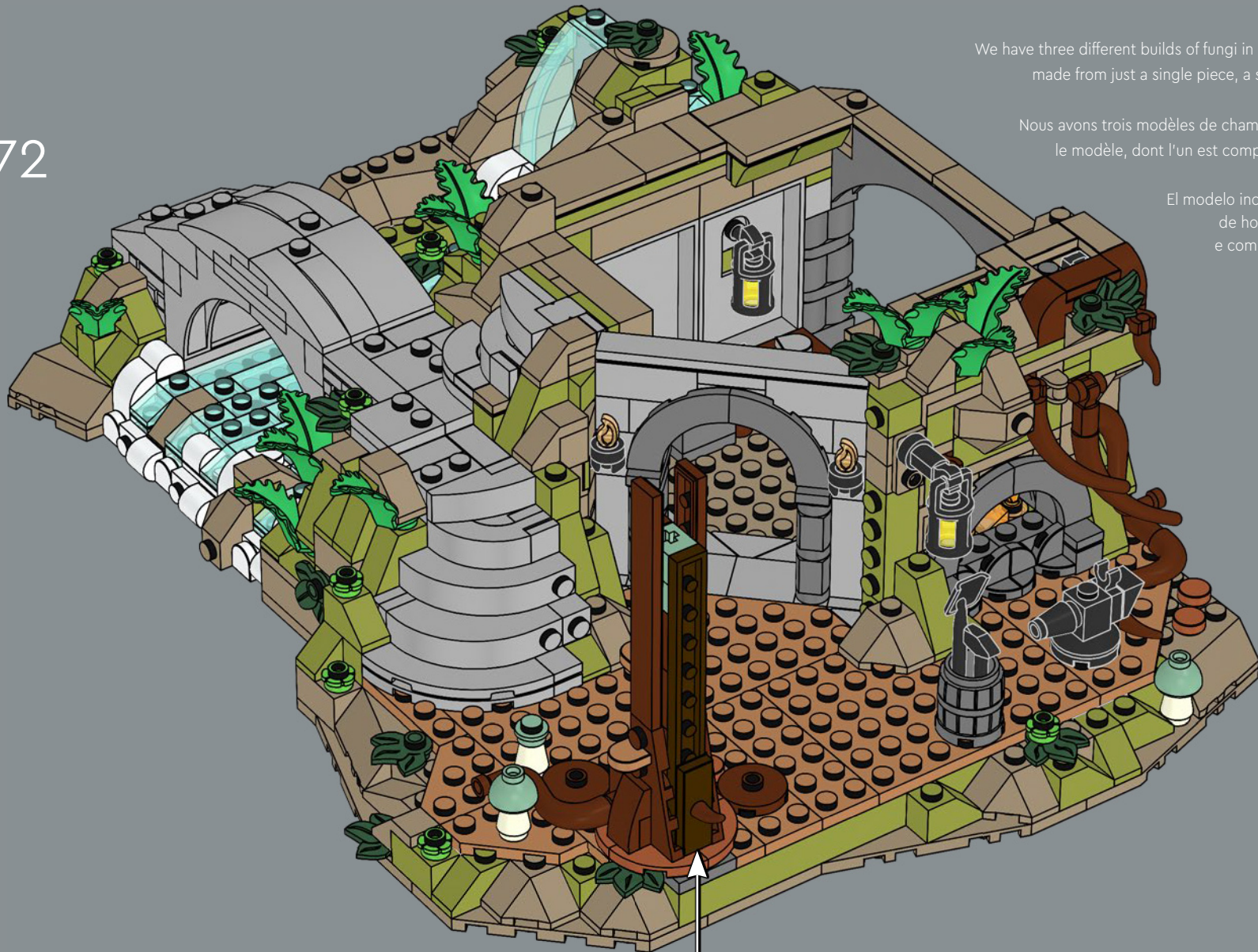



173

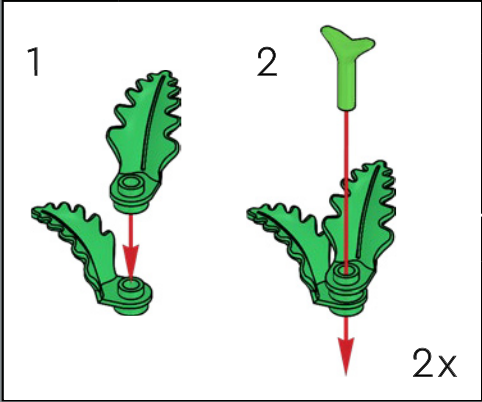
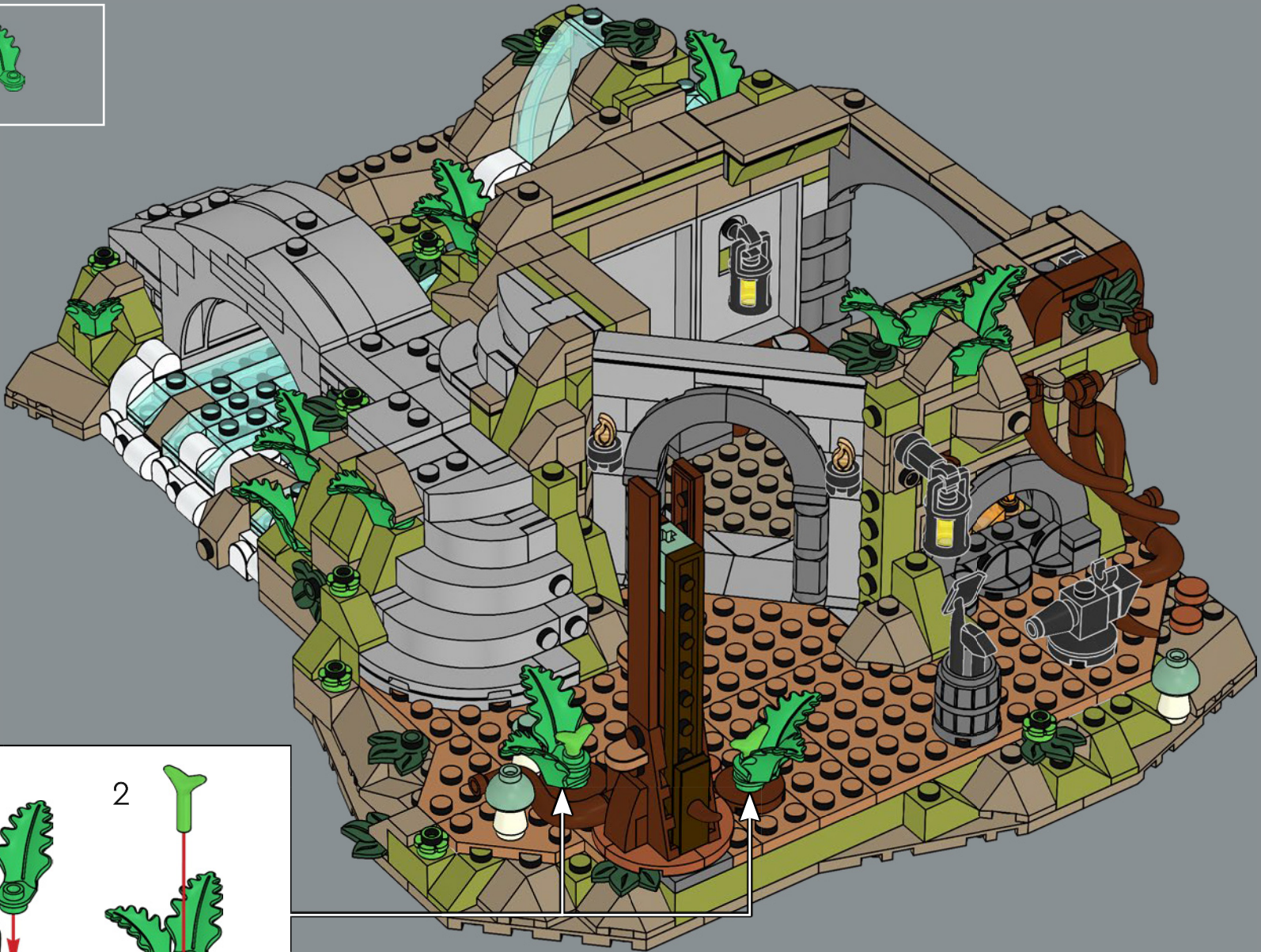

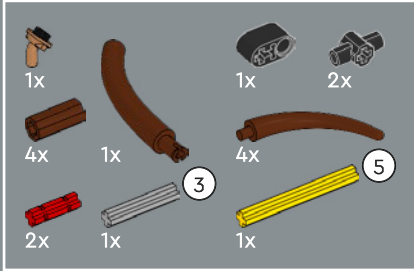
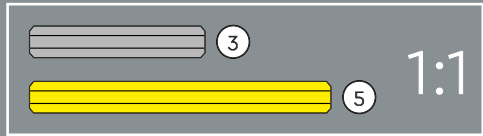
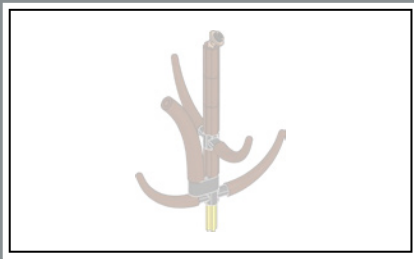

174

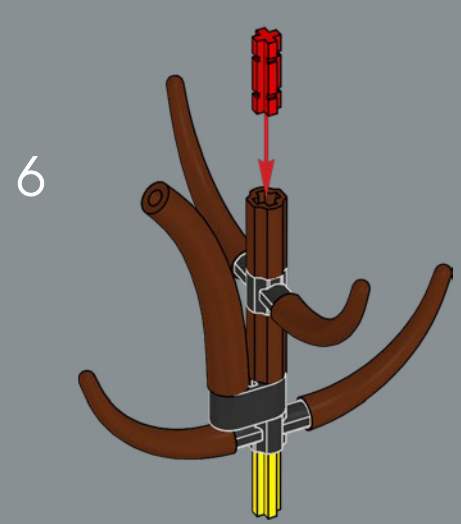
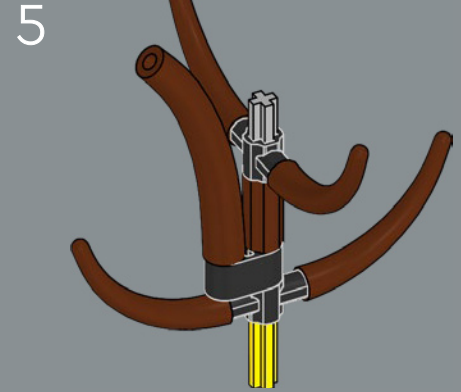
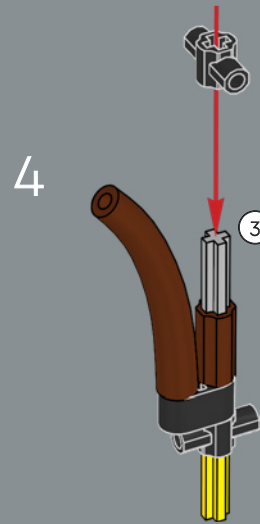
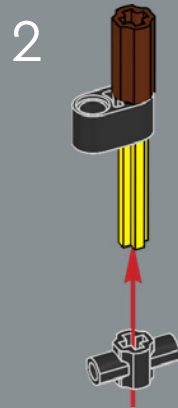
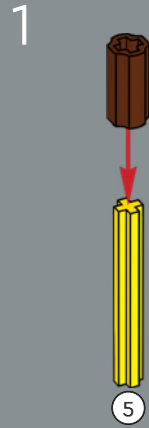

7

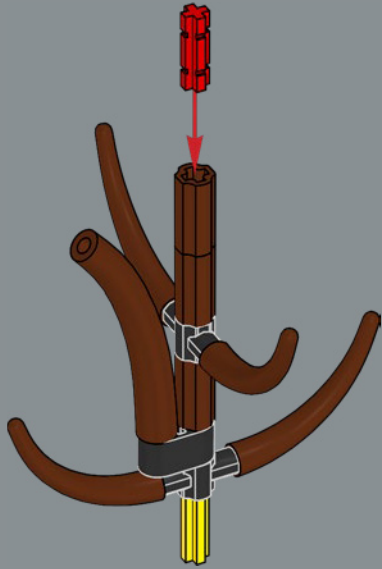

8

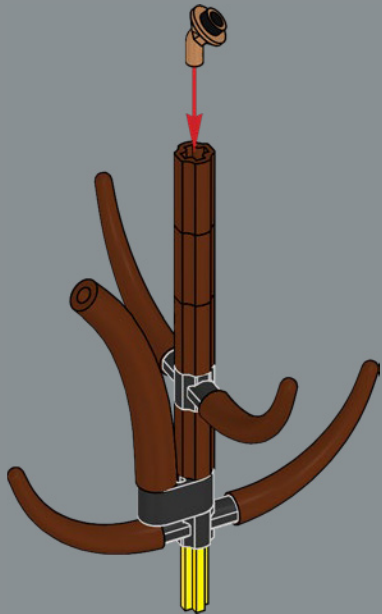

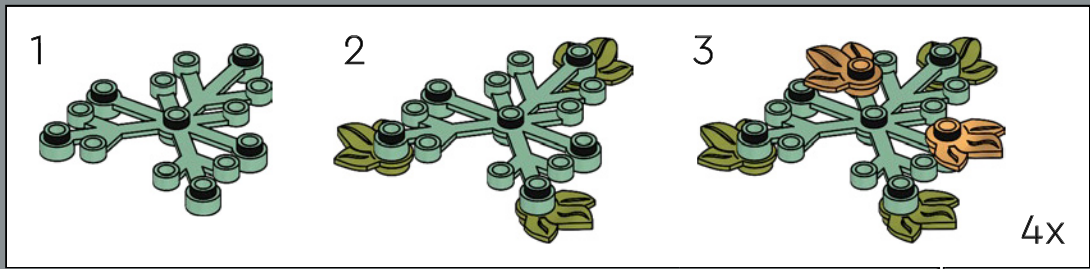

175

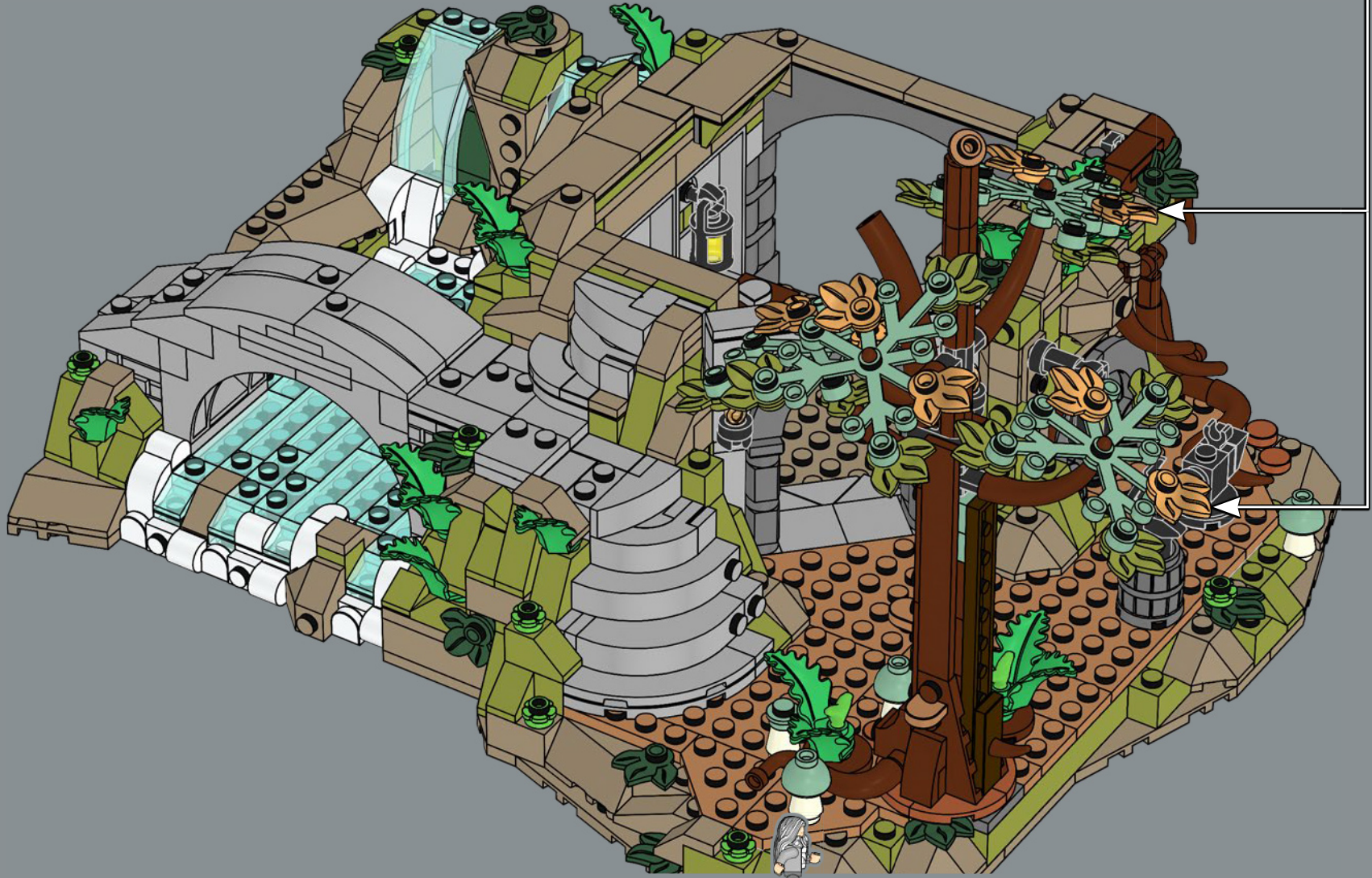

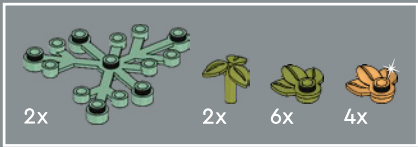

176

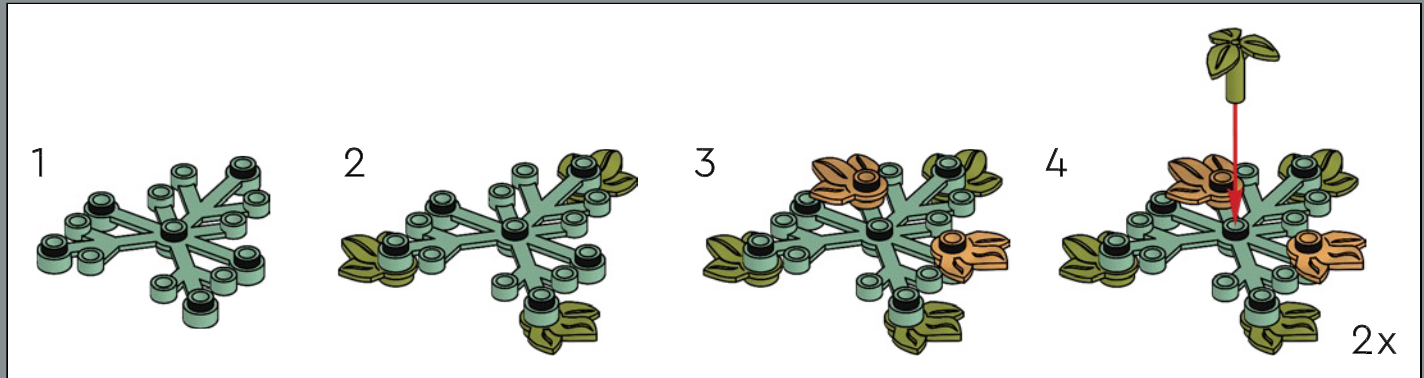

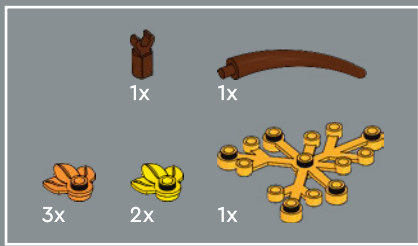

177

1

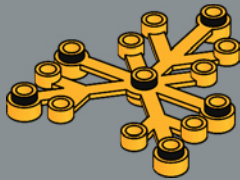

2

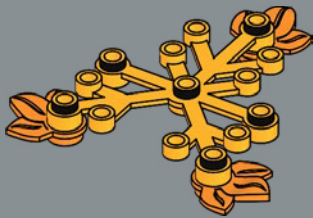

3

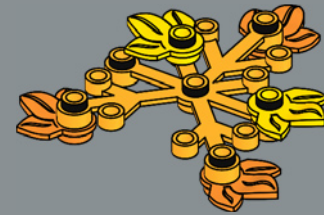

4

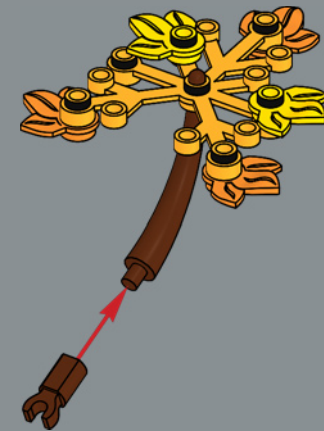

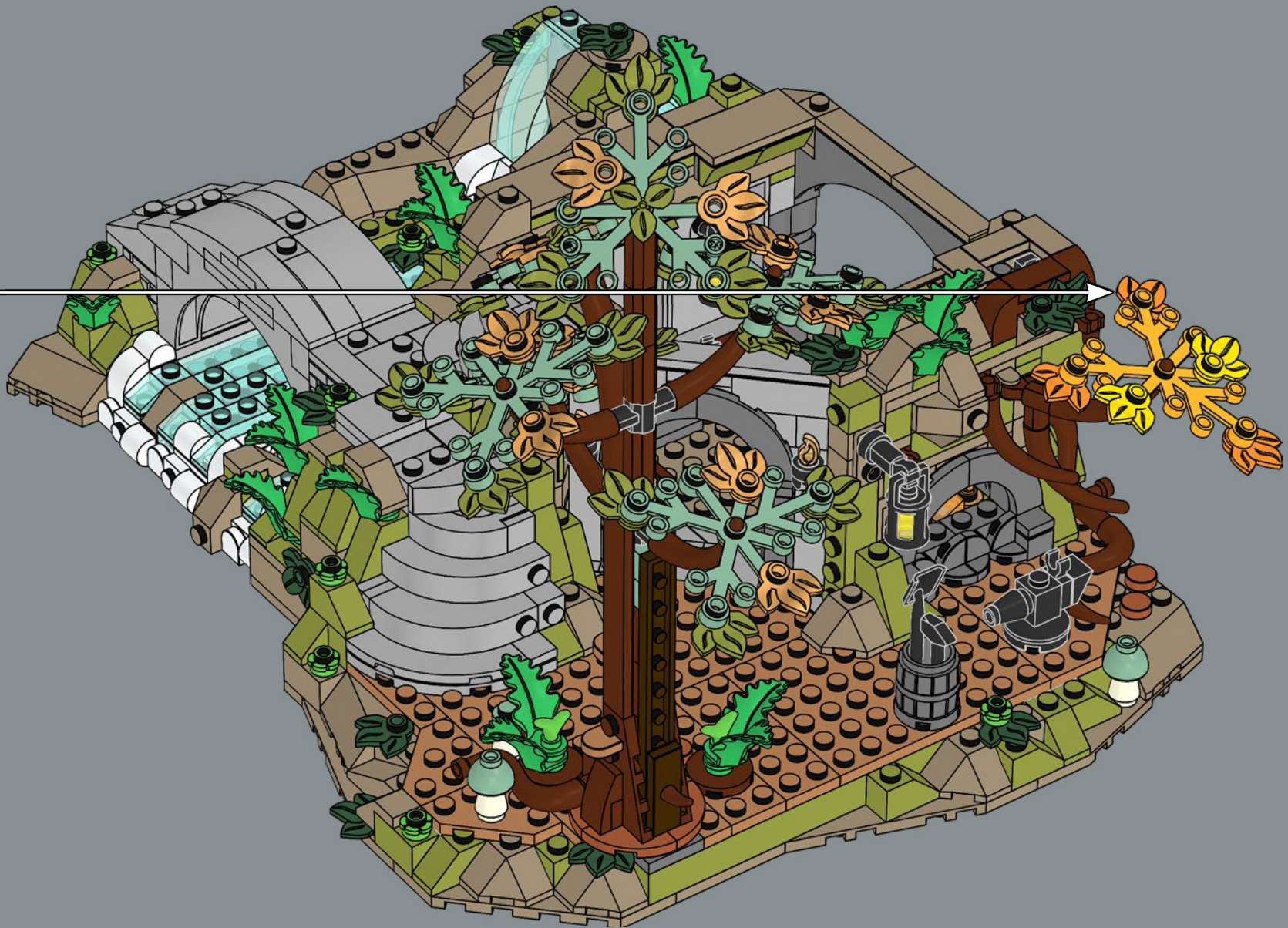

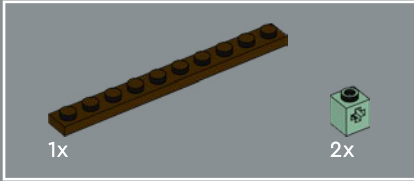
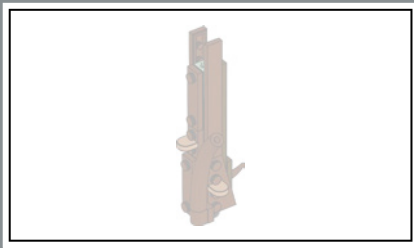

178

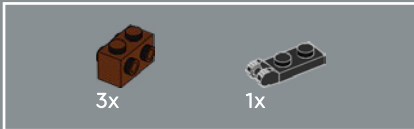
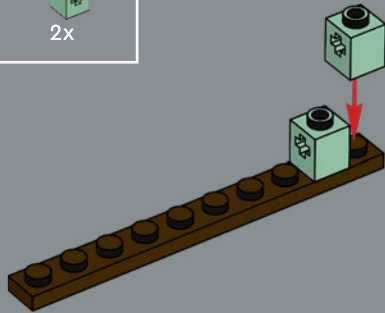

179

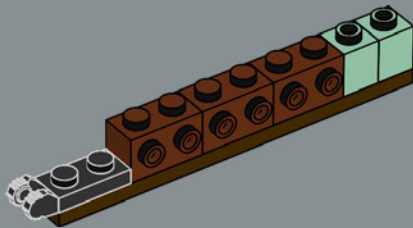

180

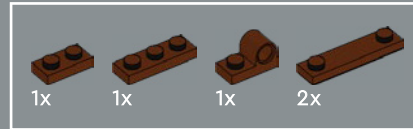
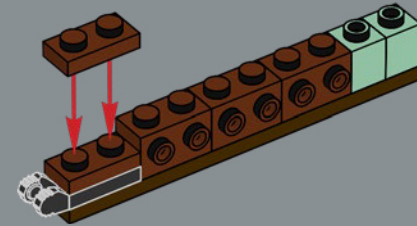

181

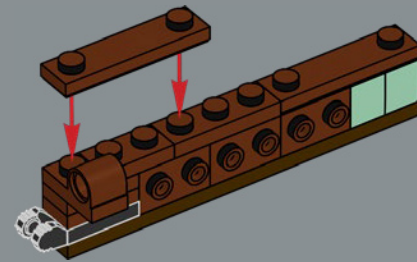

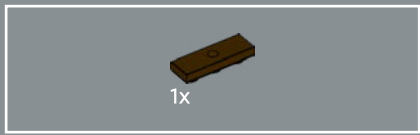

182

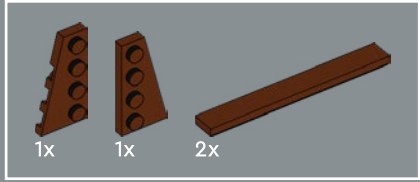
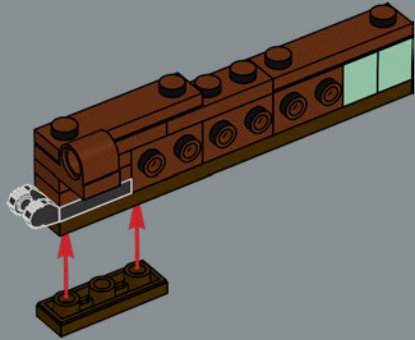

183

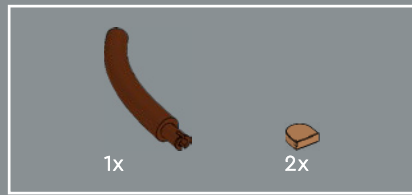
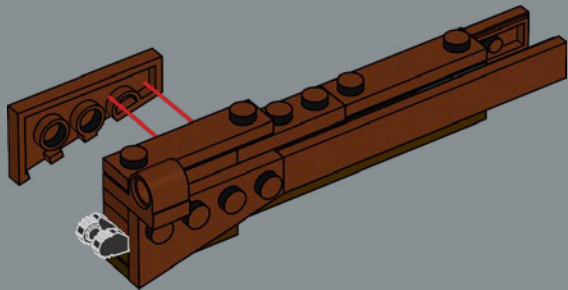

184

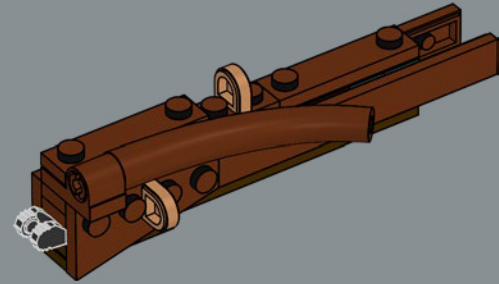

185

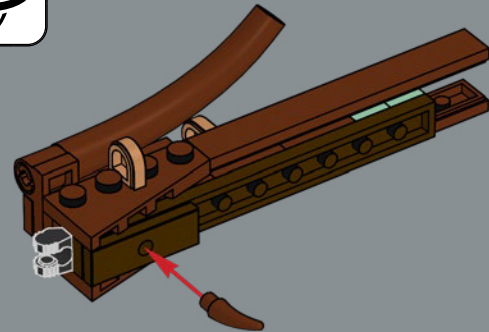



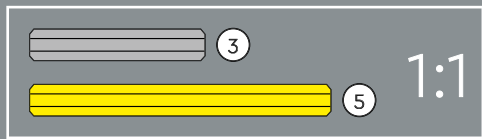
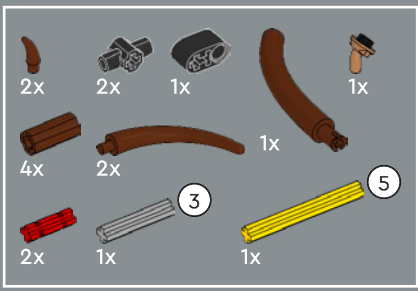

187

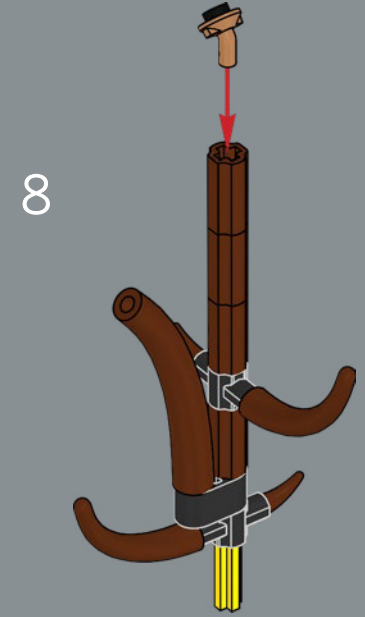
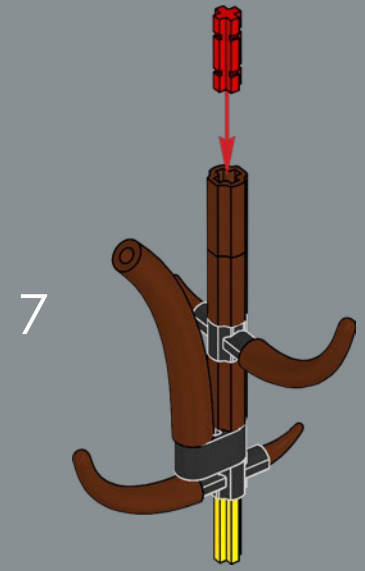
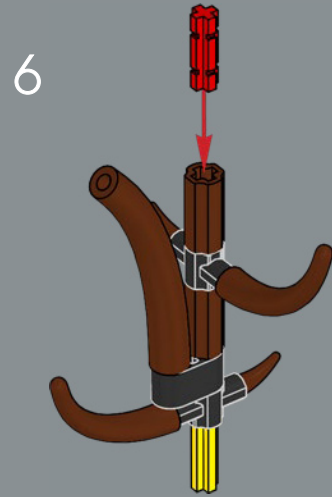
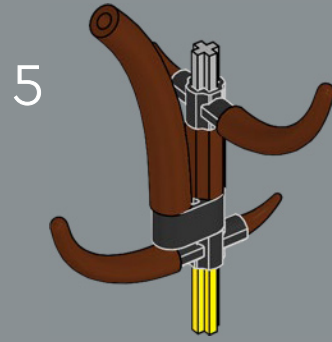
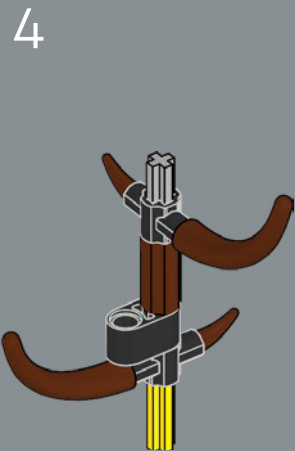
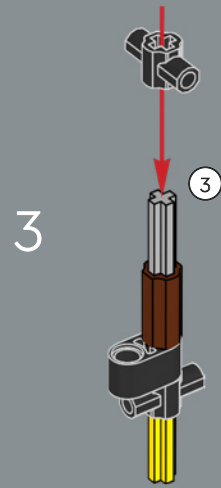
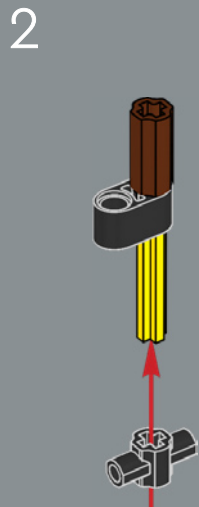
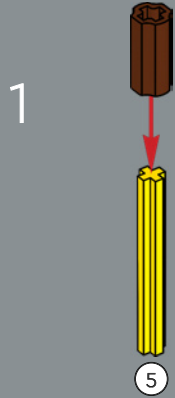





188

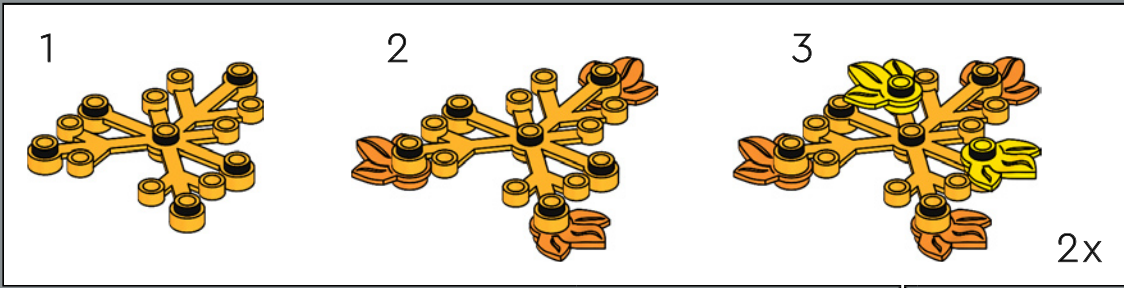



189

1

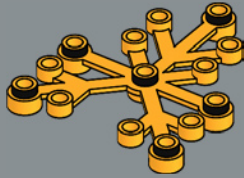

2

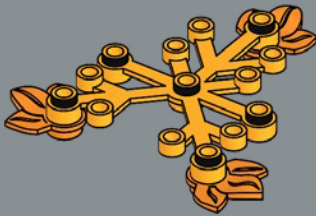

3

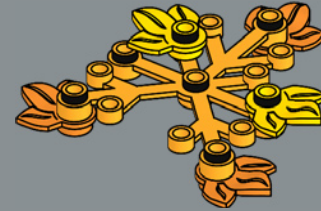

4

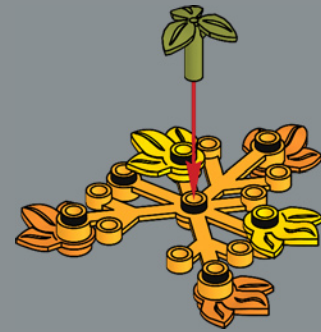

3x



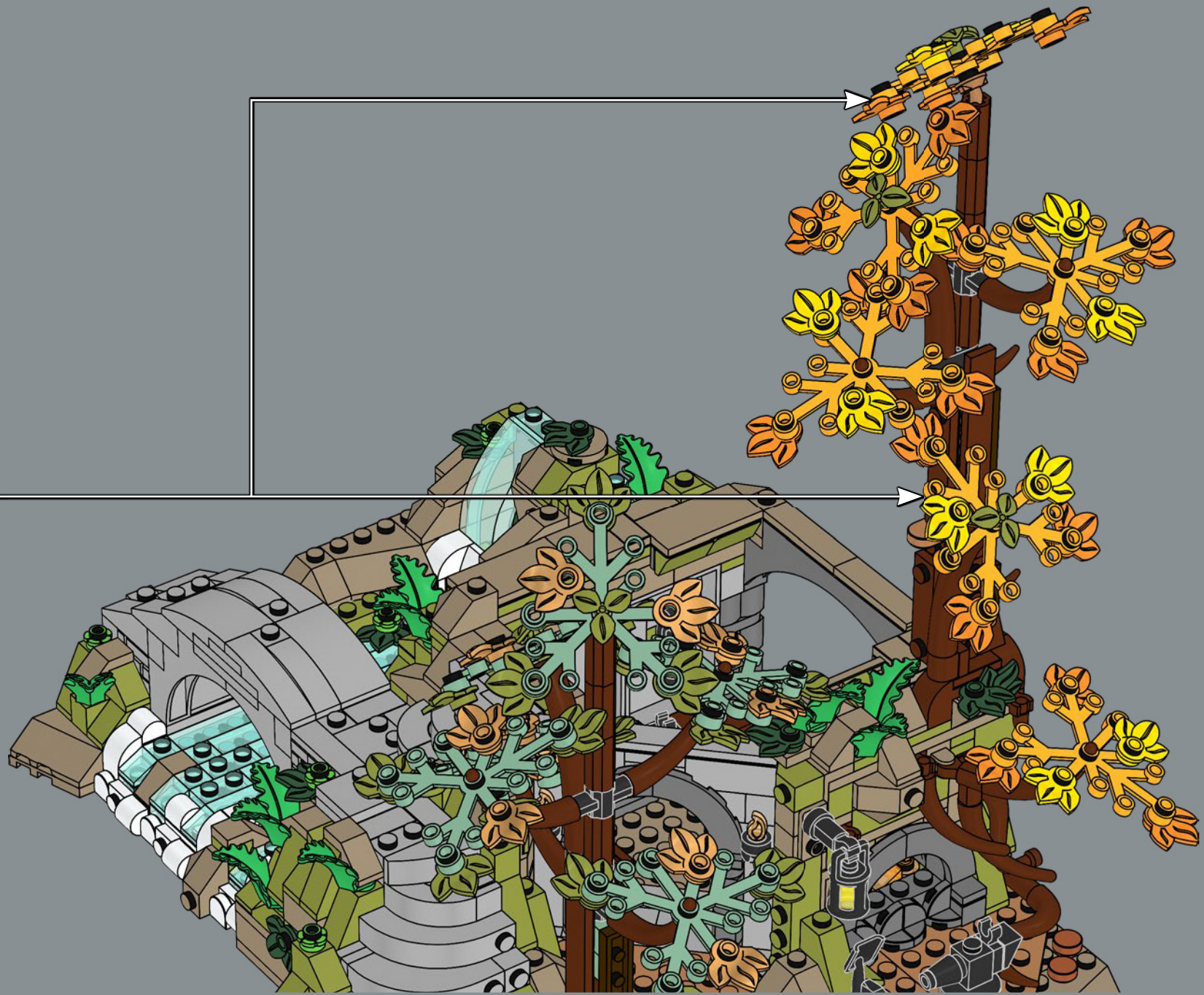

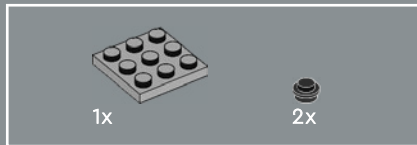
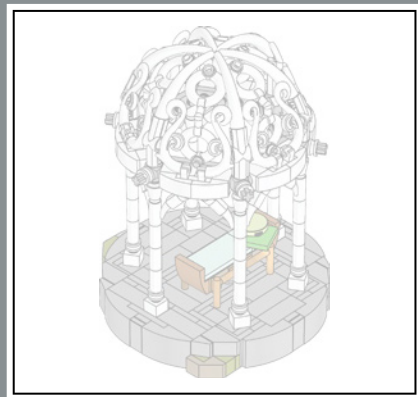

190

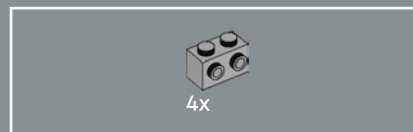
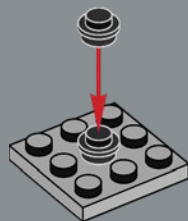

191

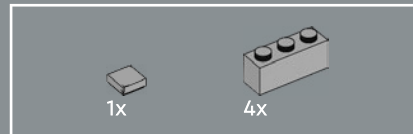
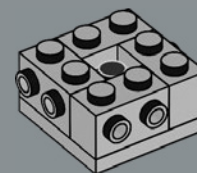

192

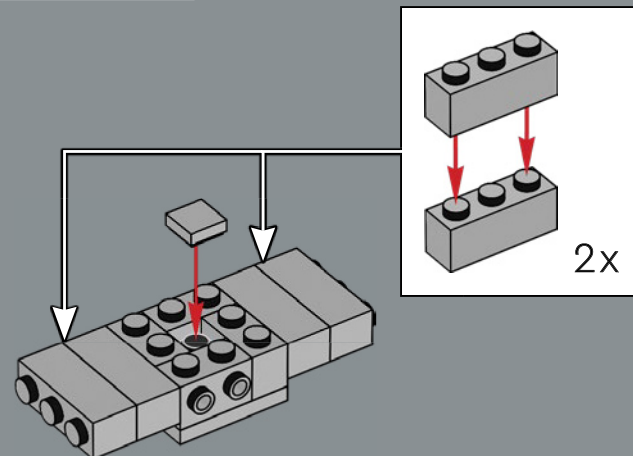

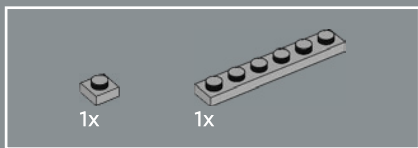
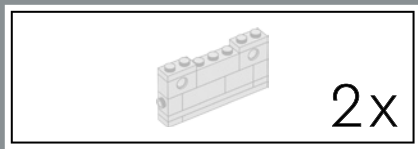

193

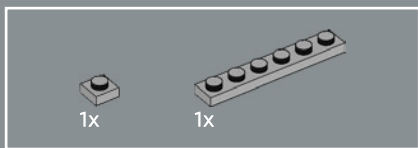
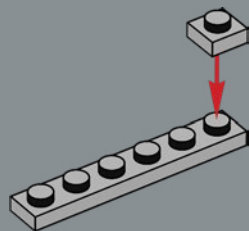

194

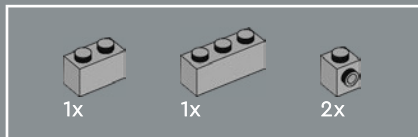
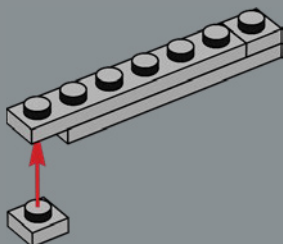

195

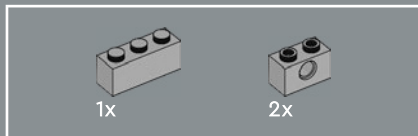
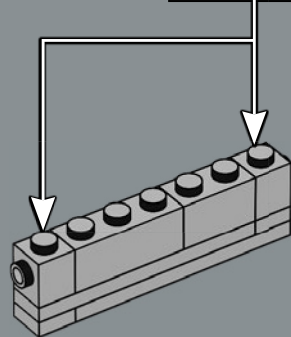
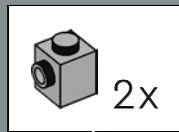

196

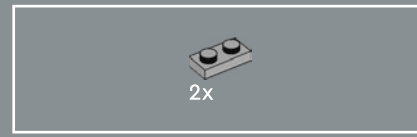
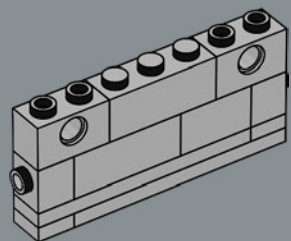

197

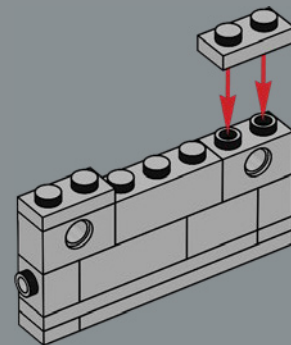

198

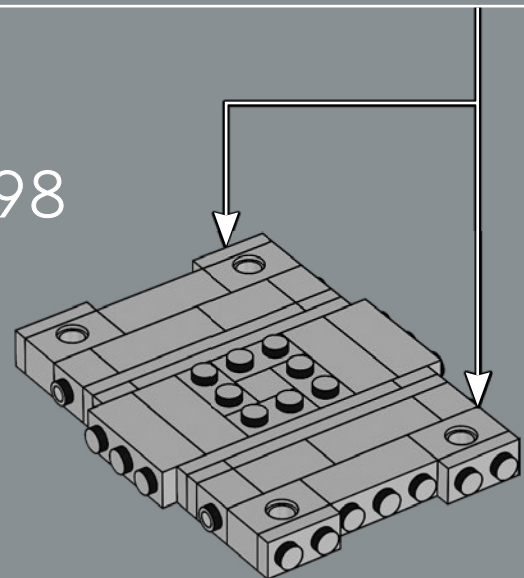

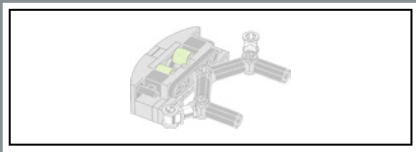

199

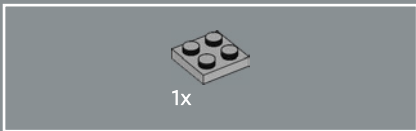
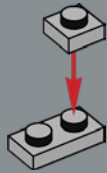

200

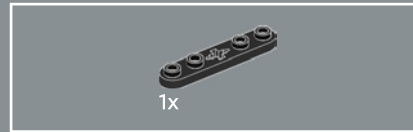

201

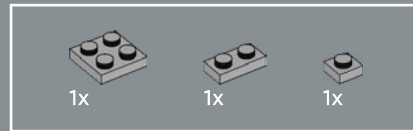
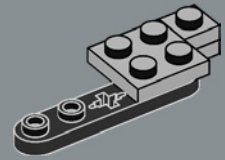

202

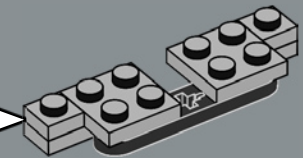
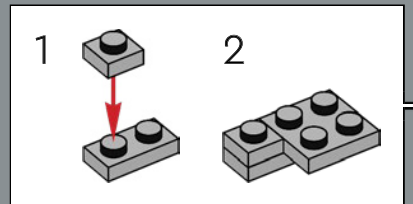

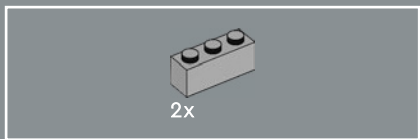

203

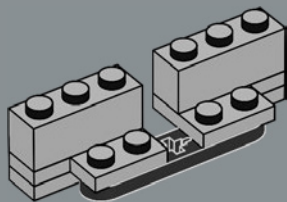

204

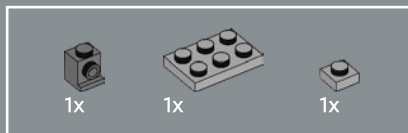
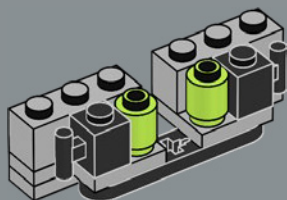

205

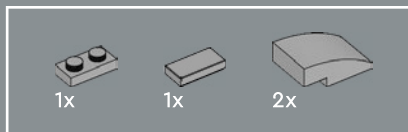
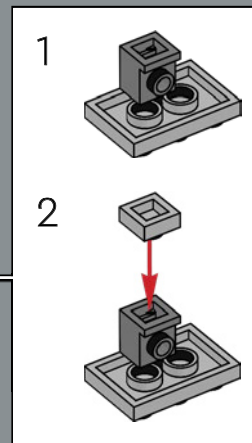
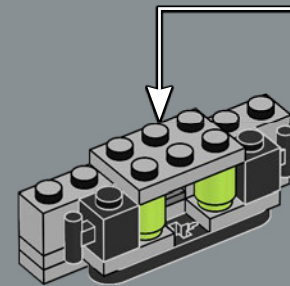

206

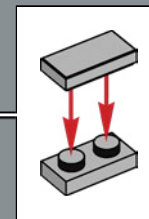
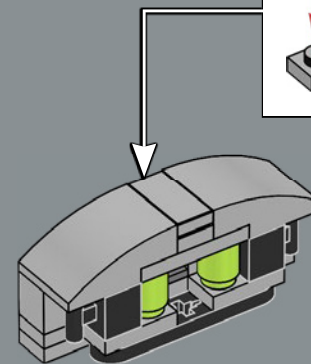



207

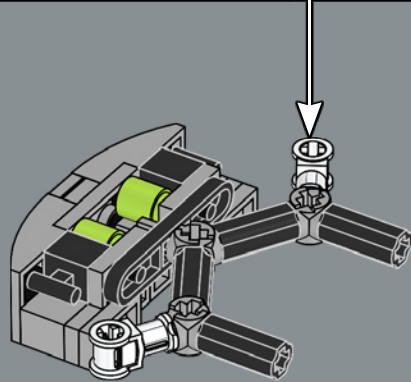
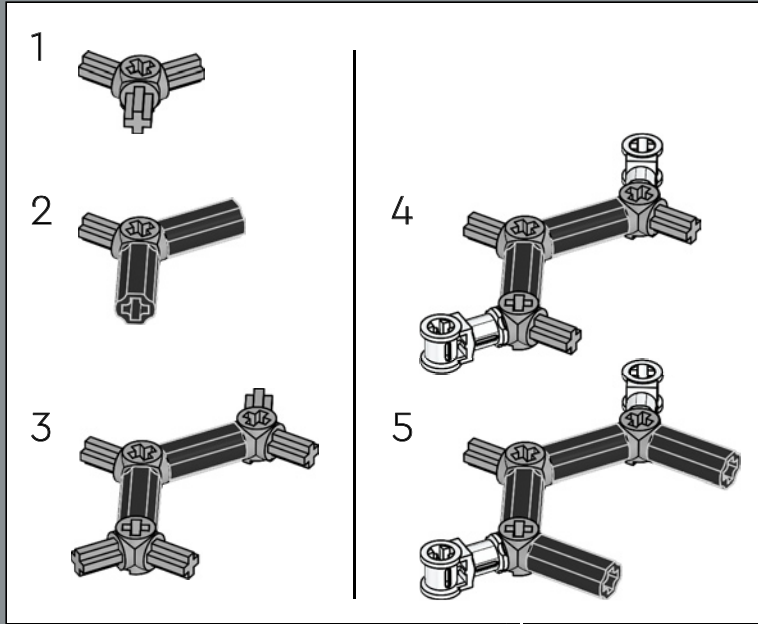

208

The base for the gazebo is one of the most challenging geometric puzzles we faced while developing this model.

La base du pavillon est l'un des plus grands défis géométriques que nous avons dû relever lors du développement de ce modèle.

La base del kiosco es uno de los desafíos geométricos más complicados que enfrentamos al desarrollar este modelo.

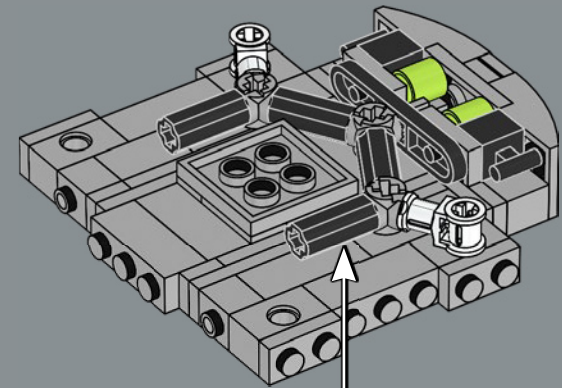

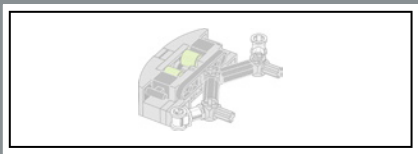

209

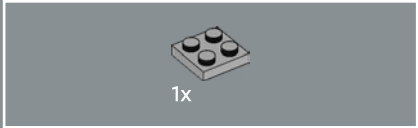
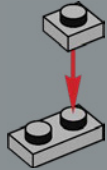

210



211

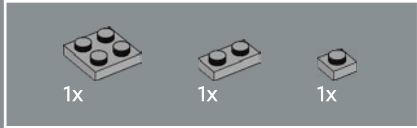
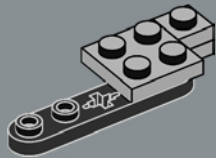

212

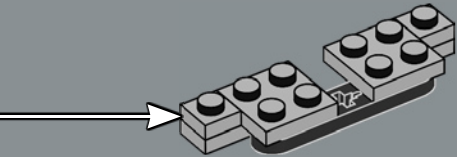
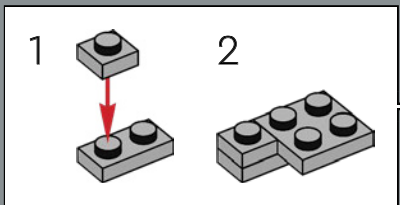

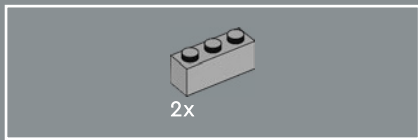

213

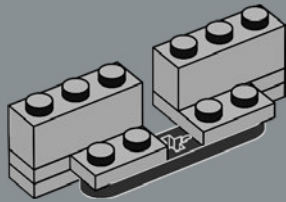

214

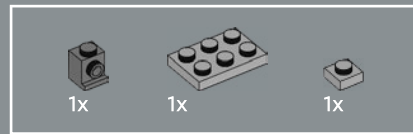
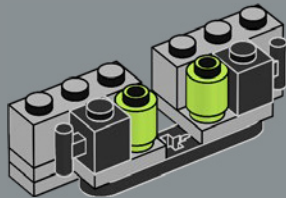

215

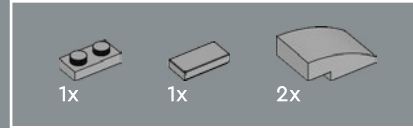
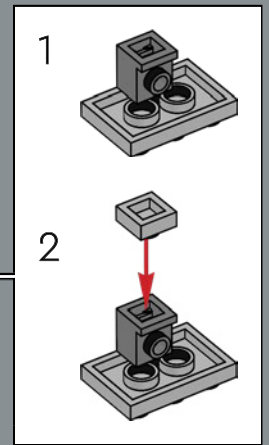
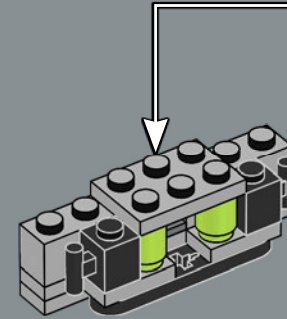

216

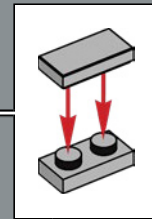
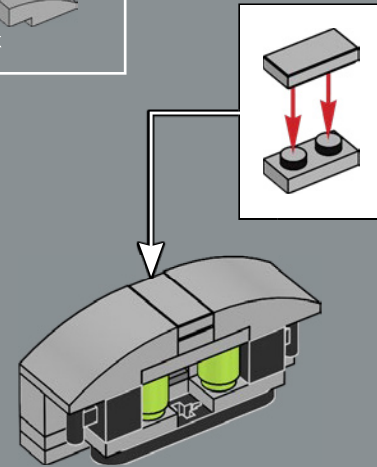



217

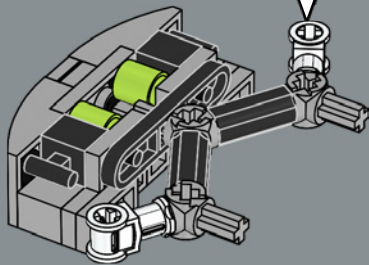
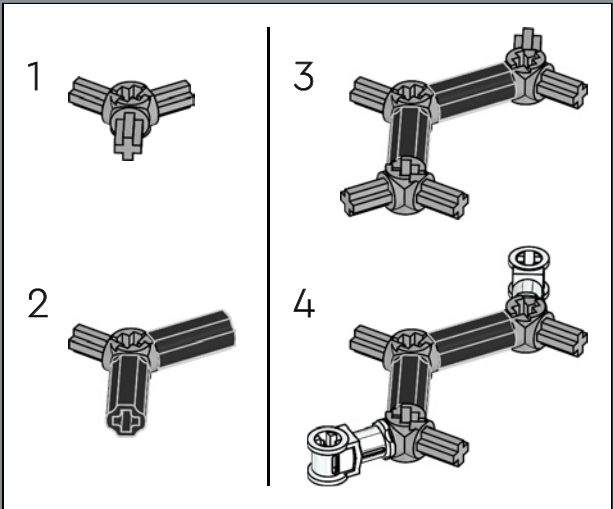

218

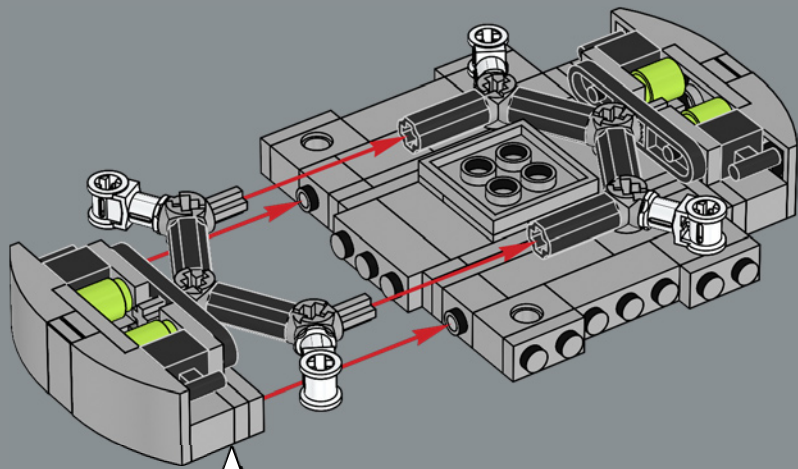

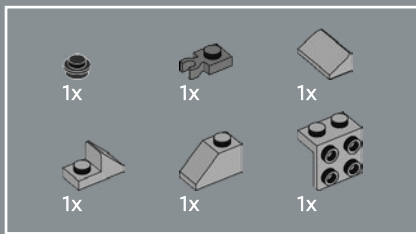

219

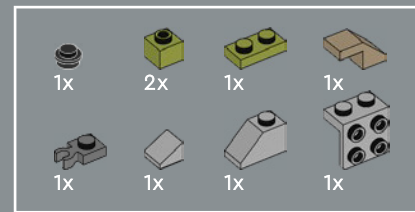
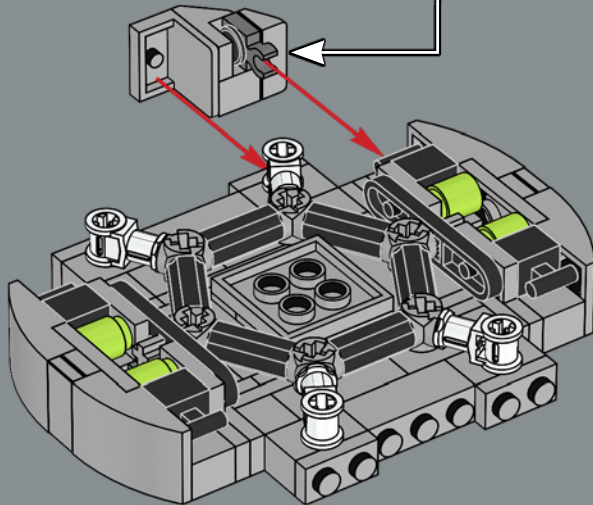
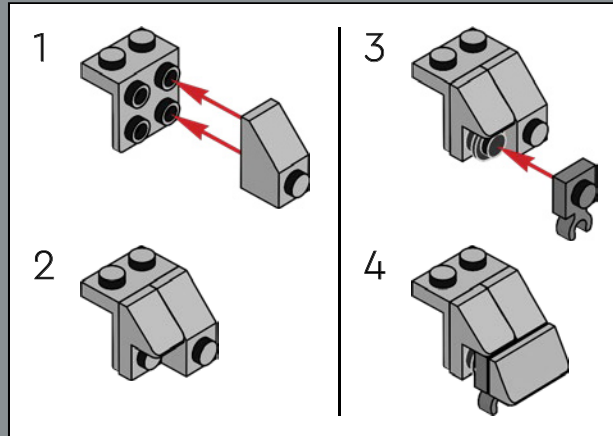

220

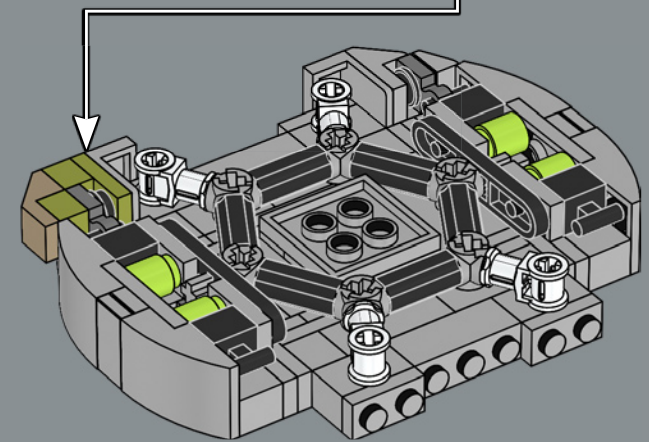
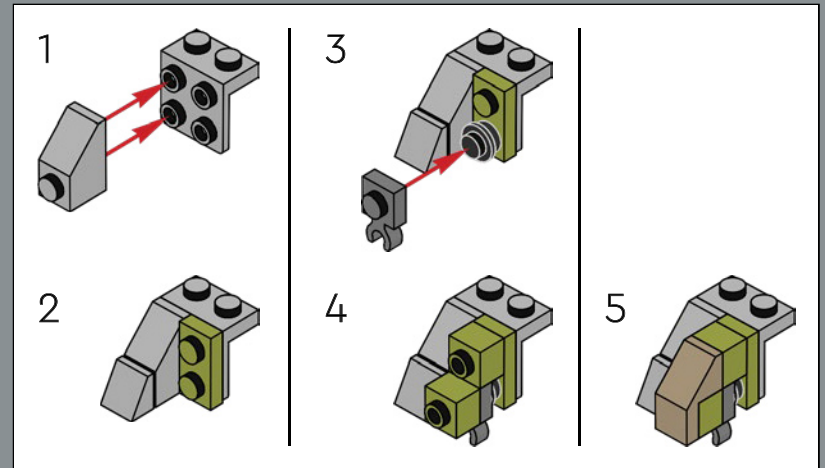



221

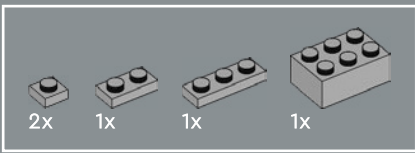
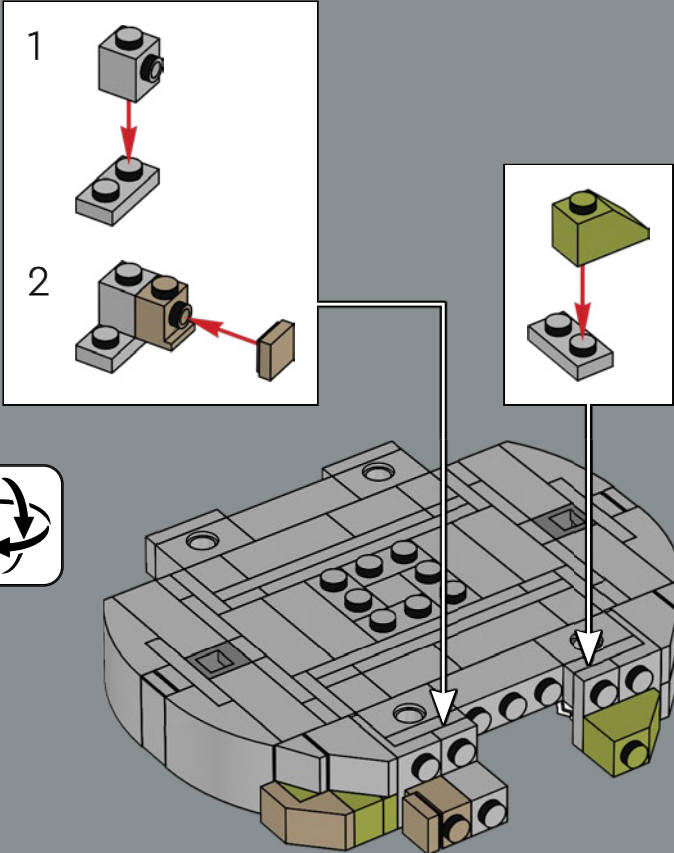

222

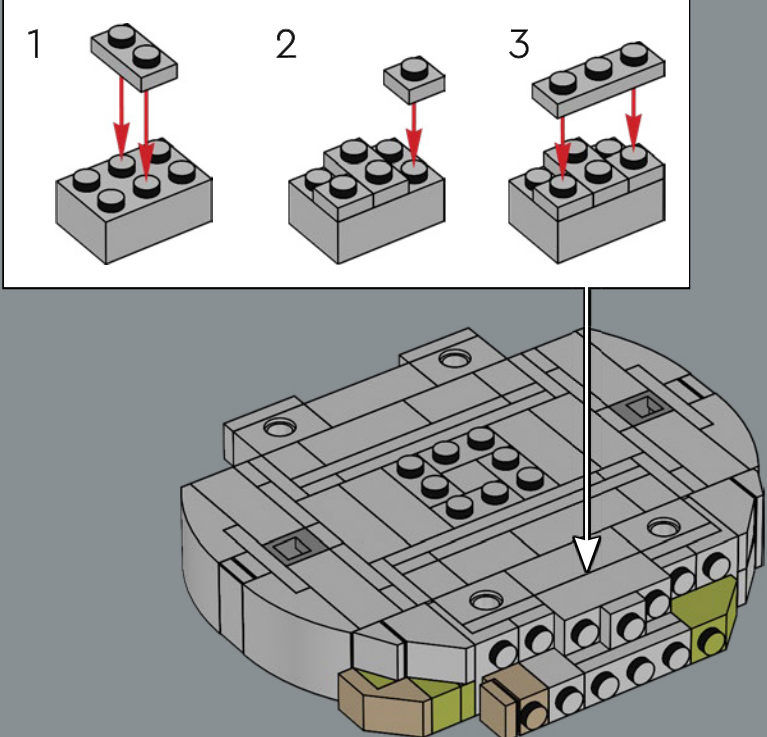

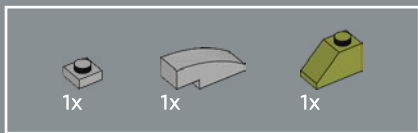

223

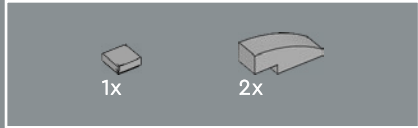
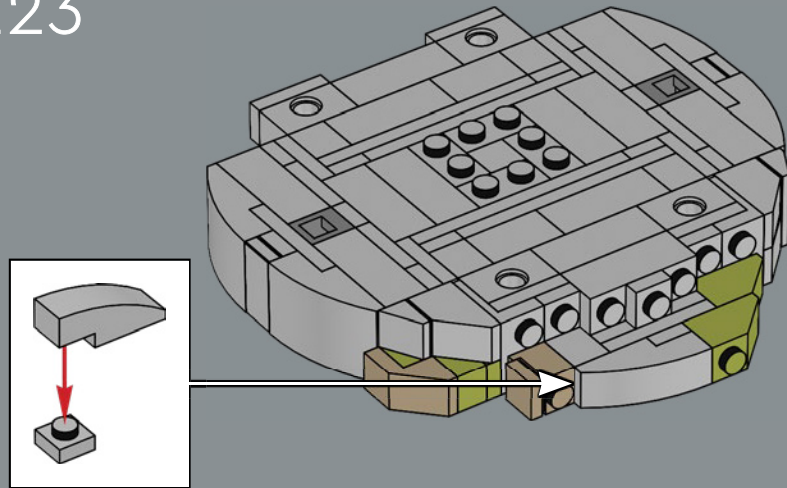

224

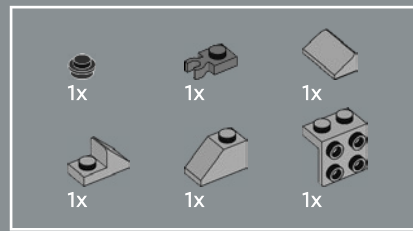
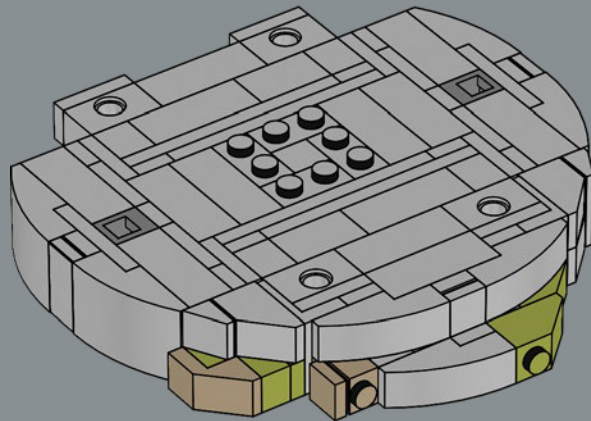

225

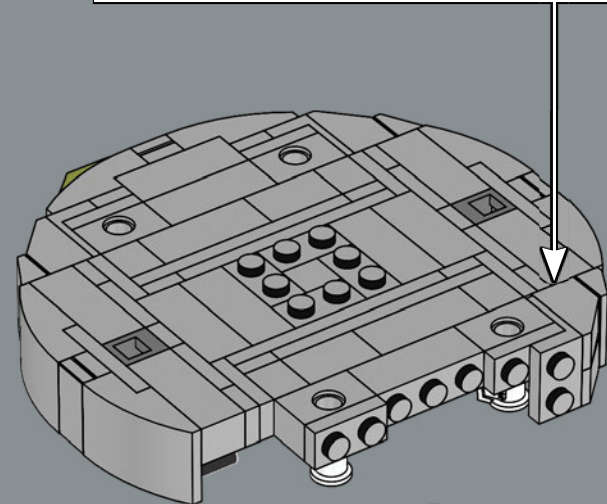
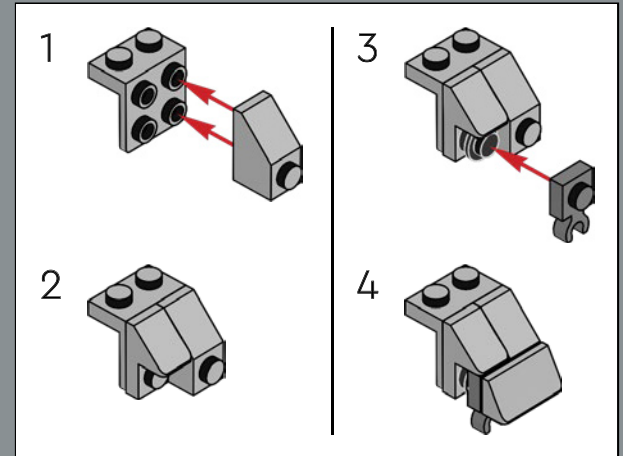

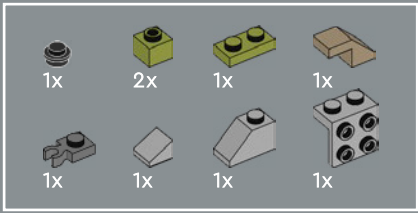

226

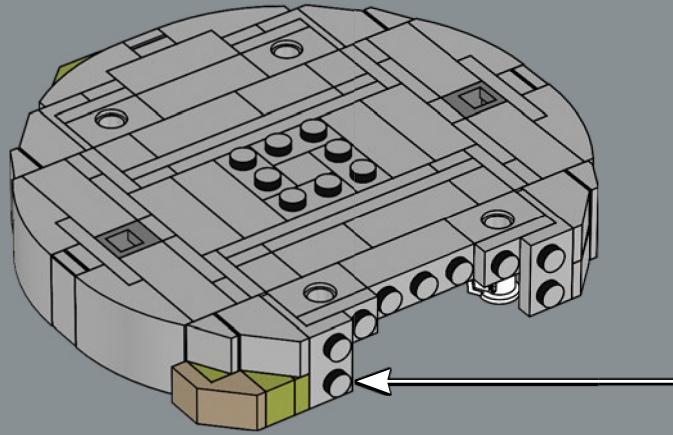
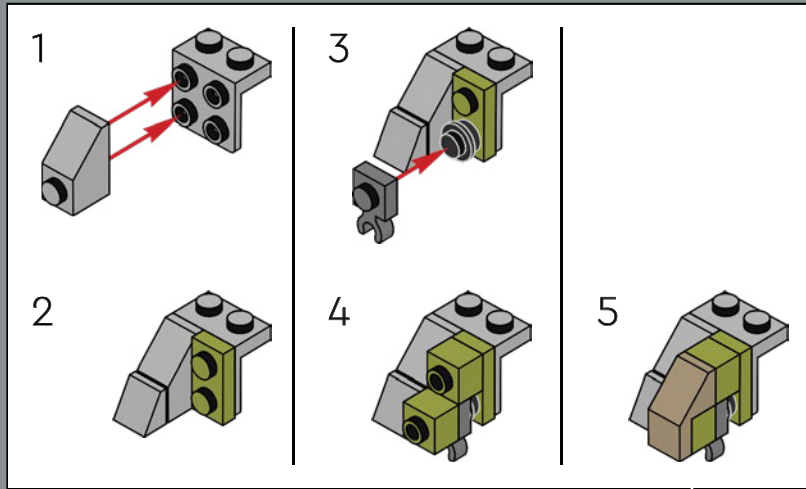

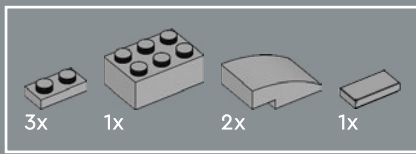

227

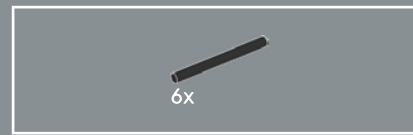
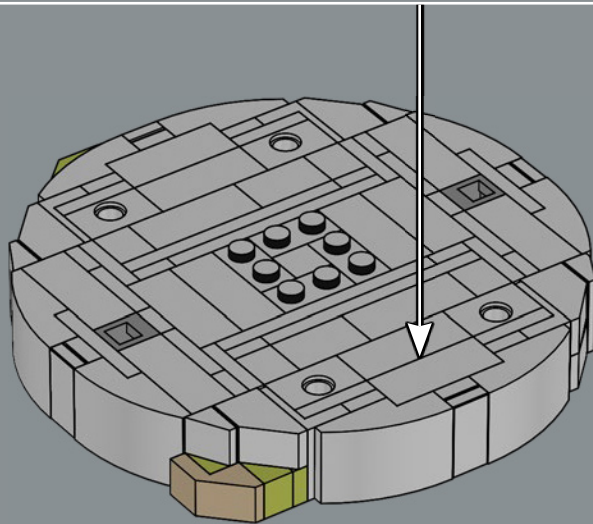
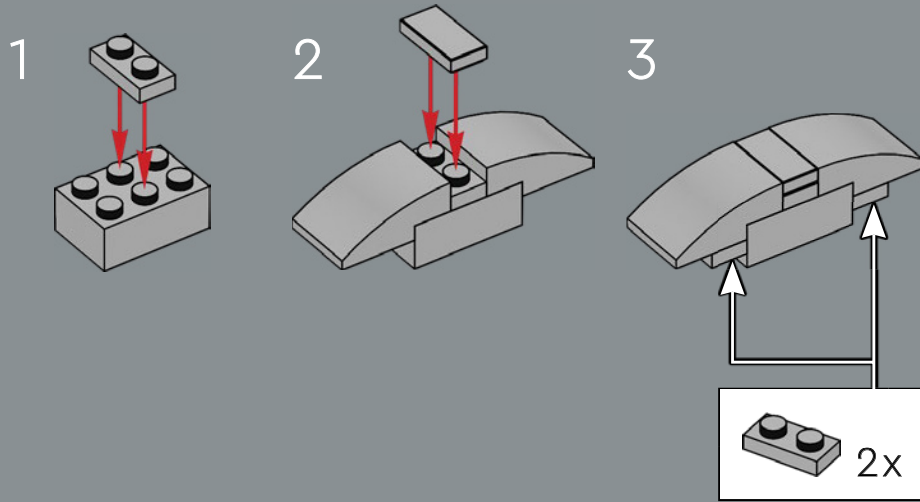

228

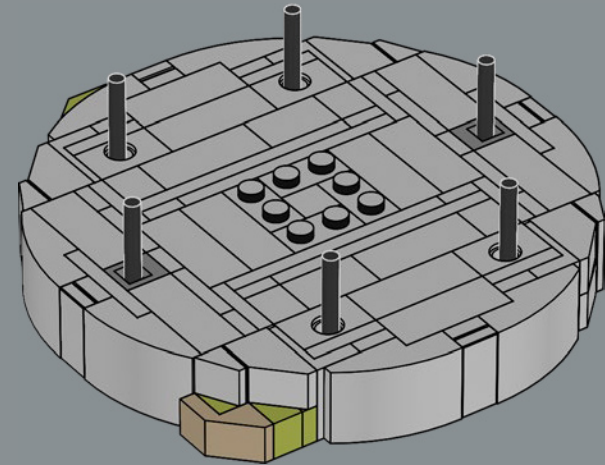



6x

229

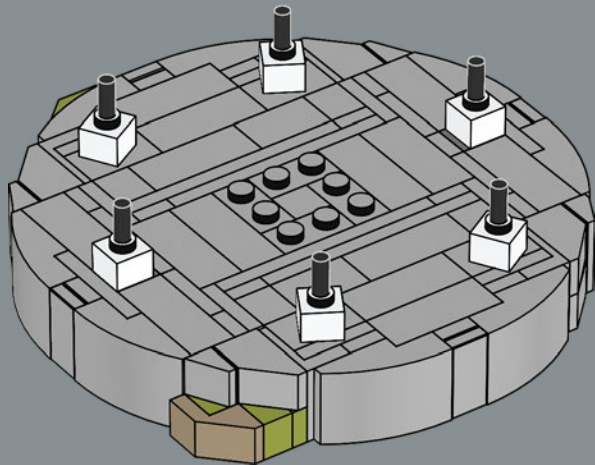

6x

230

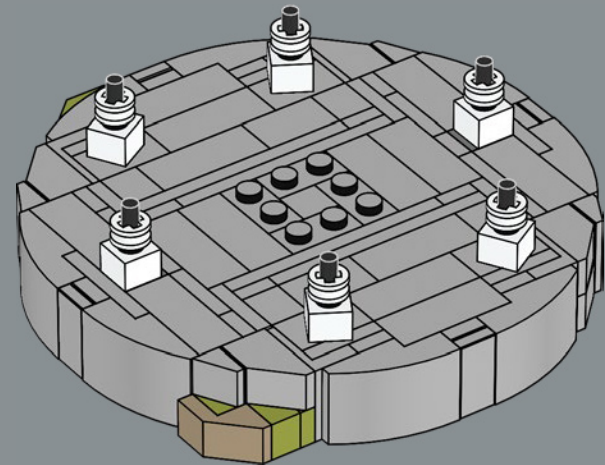

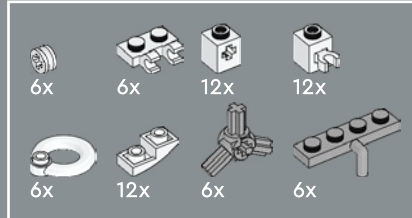
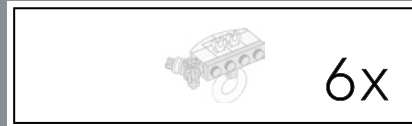
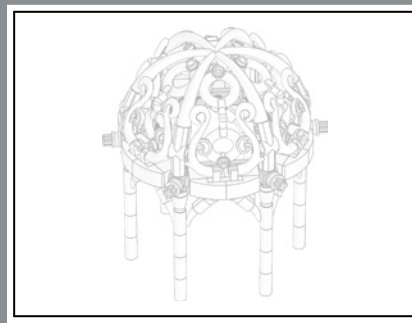

231

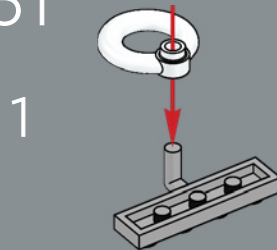

1

2

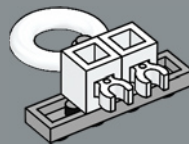

The rings to create the detail on the gazebo roof were originally designed as minifigure life preservers in 1999.

Les anneaux utilisés pour créer les détails du toit du pavillon ont été conçus à l'origine comme des bouées de sauvetage pour figurines en 1999.

Los aros que adornan el techo del kiosco se diseñaron originalmente para representar salvavidas individuales para minifiguras en 1999.

3

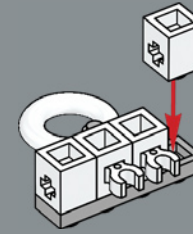

4

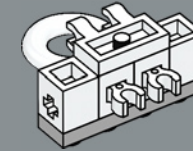

5

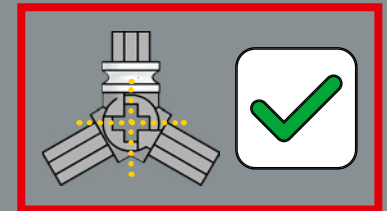
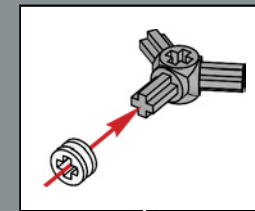
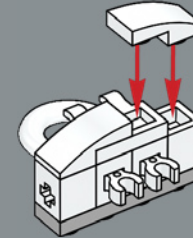

6

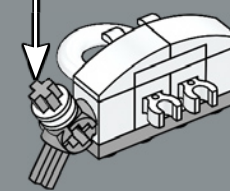

6x



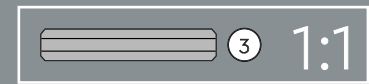
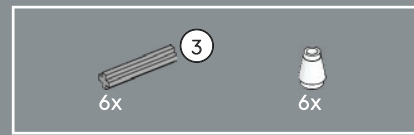
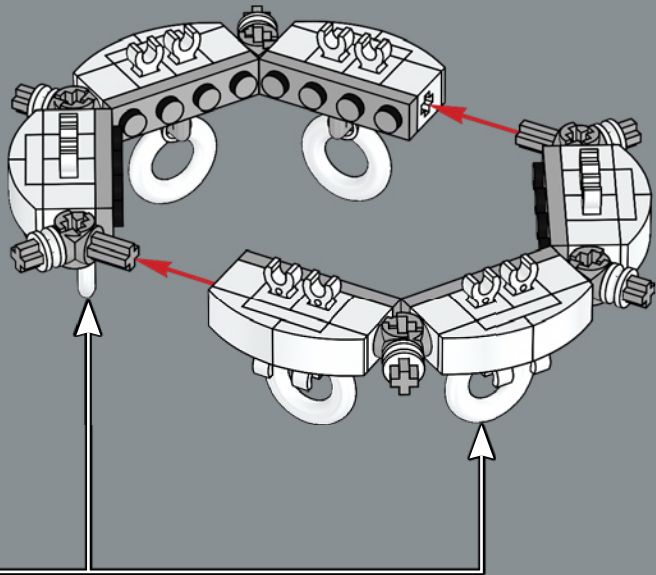

232

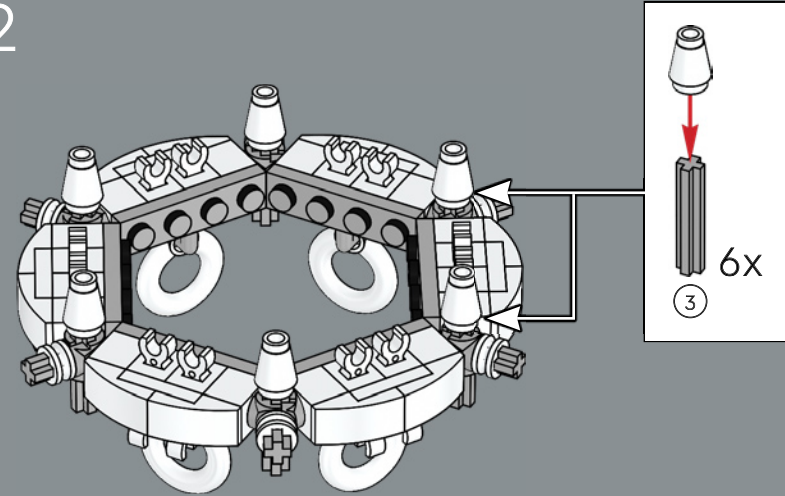

233

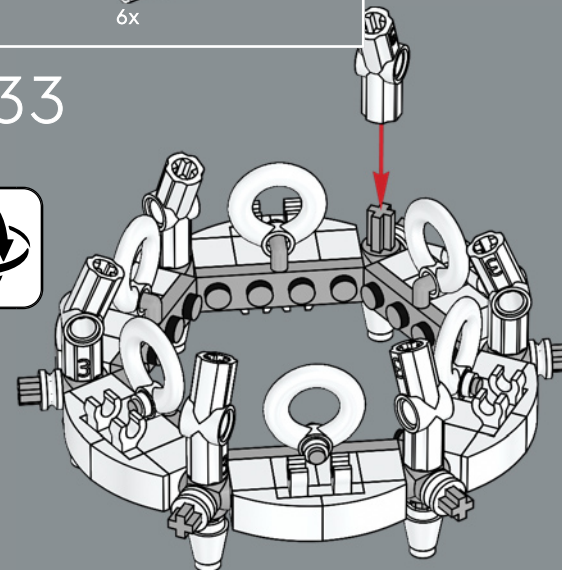

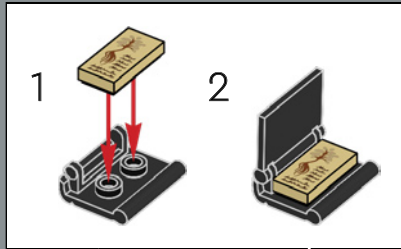
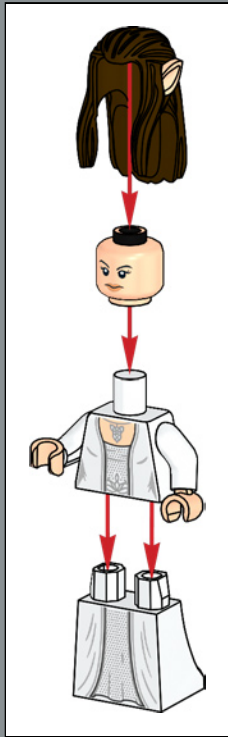

234

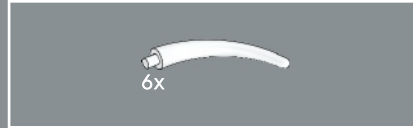
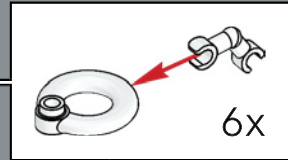
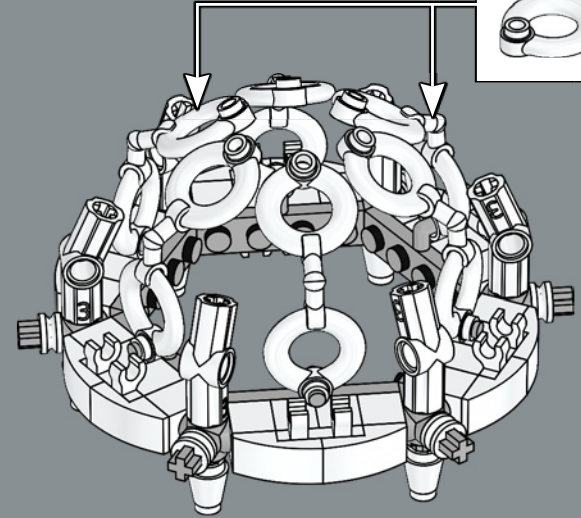

235

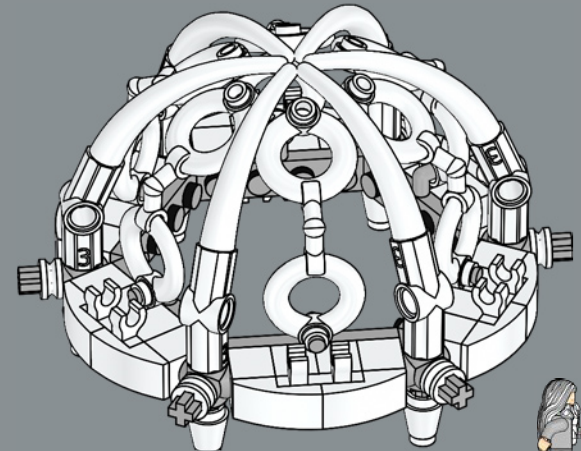



12x

236

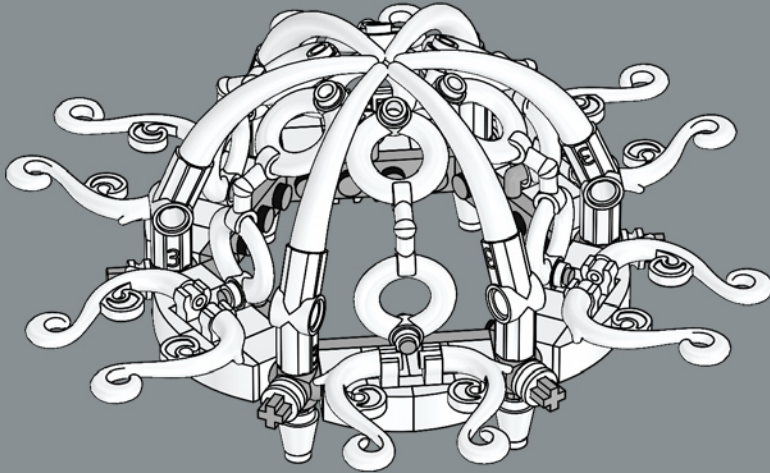

237

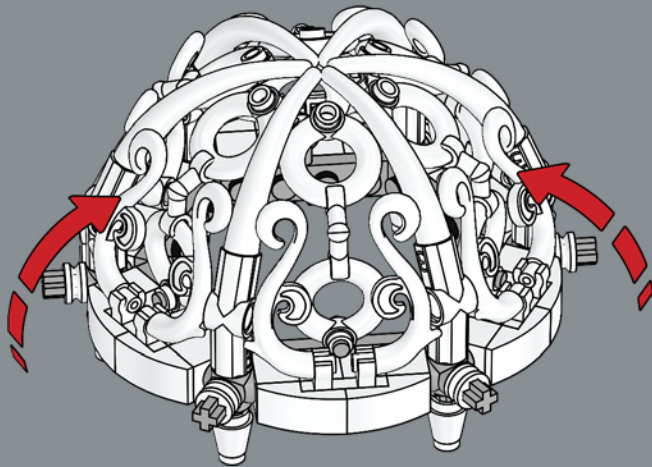

24x

238

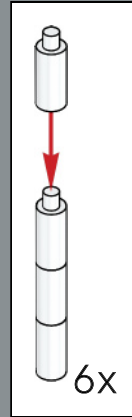
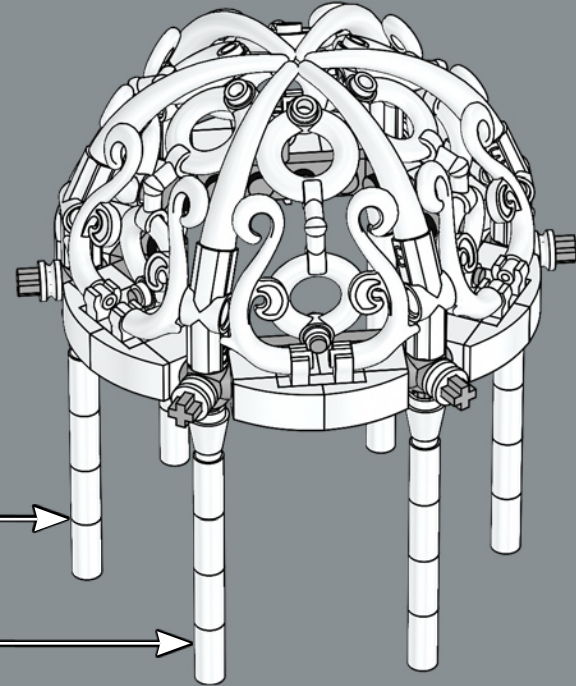

6x



Originally developed as a candle, 91 of these elements in white are used in the model. Only four of them are used as candles, though.

Développé à l'origine pour servir de bougie, cet élément en blanc est présent en 91 exemplaires dans le modèle. Toutefois, seulement quatre d'entre eux sont utilisés comme bougies.

Diseñados originalmente para representar velas, el modelo tiene 91 de estos elementos en blanco. No obstante, solo cuatro de ellos desempeñan su función original.



239

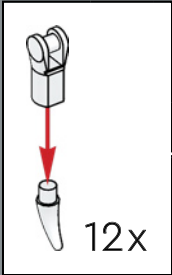
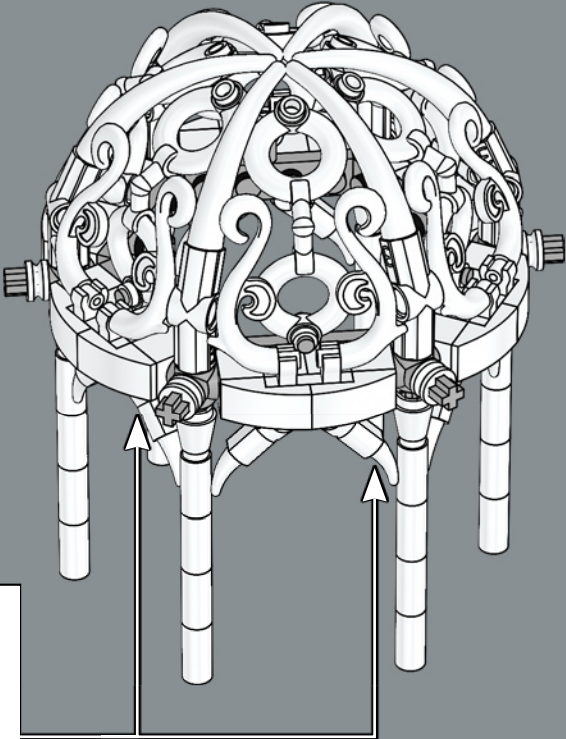

240

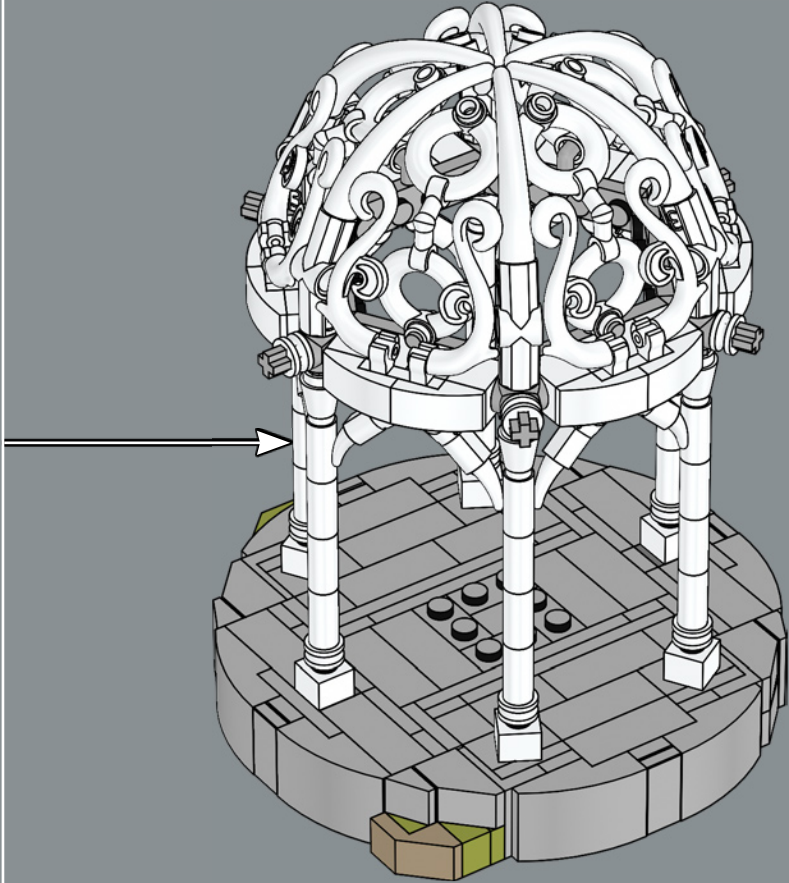

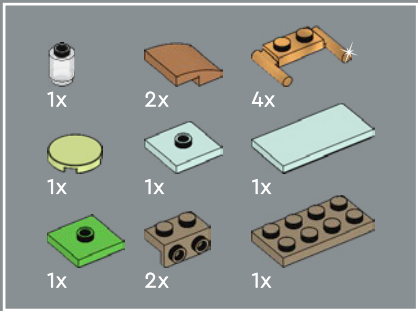

241

1

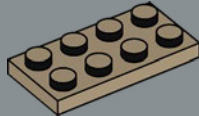

2

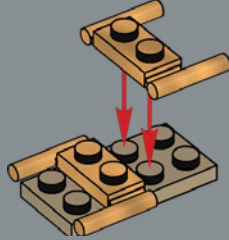

3

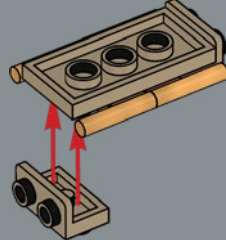

4

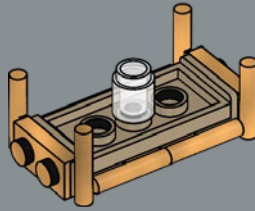

5

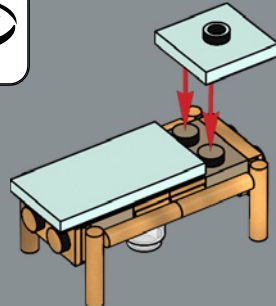

6

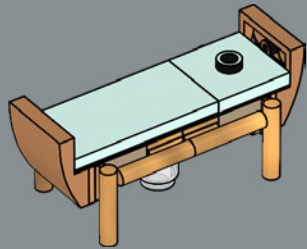

7

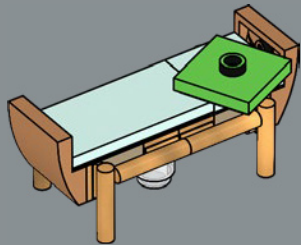

8

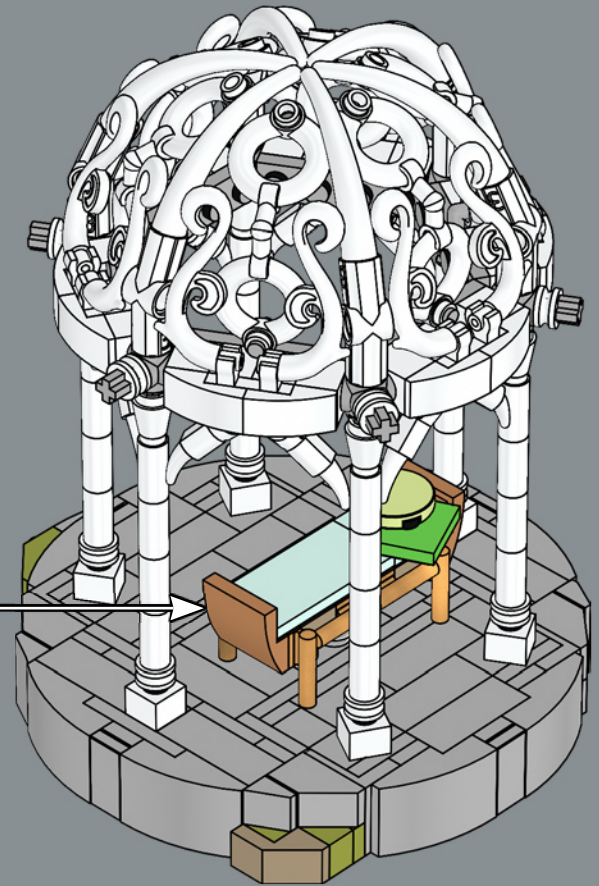
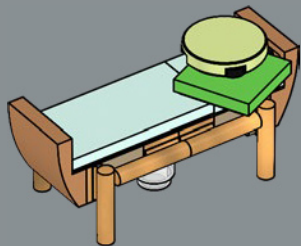



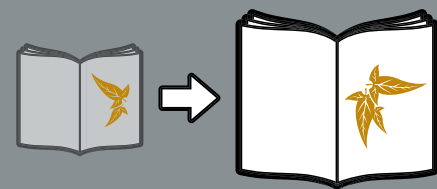

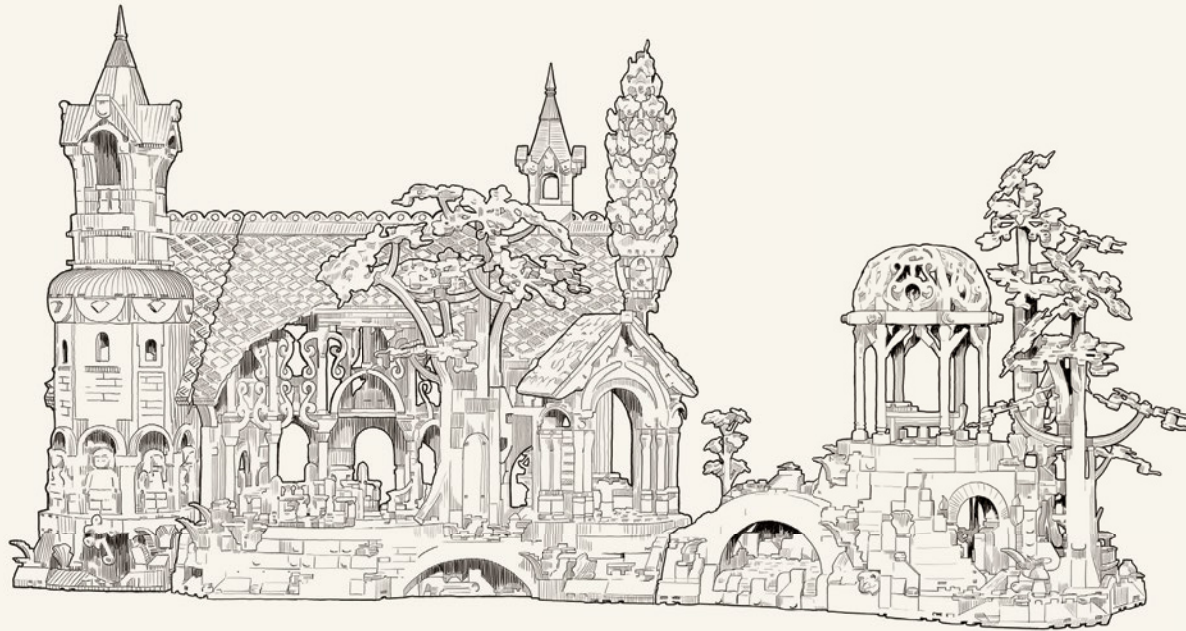

LEGO and the LEGO logo are trademarks of the/son des marques de commerce du/son marcas registradas de LEGO Group. ©2023 The LEGO Group. 6456568

© 2023 New Line Productions, Inc. All rights reserved. The Lord of the Rings: The Fellowship of the Ring, The Lord of the Rings: The Two Towers, The Lord of the Rings: The Return of the King and the names of the characters, items, events and places therein are trademarks of The Saul Zaentz Company d/b/a Middle-earth Enterprises under license to New Line Productions, Inc. (s23)