

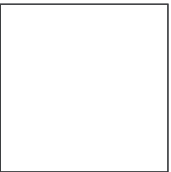

10332



Booklet available in English on  
Livret disponible en français sur  
Folleto disponible en español en





## WE'RE MAKING OUR PACKAGING MORE SUSTAINABLE

We're transitioning from single-use plastic to paper-based packaging. As we progress, you may find a mix of paper and plastic in our boxes.

## NOUS RENDONS NOS EMBALLAGES PLUS DURABLES

Nous passons des emballages en plastique à usage unique aux emballages à base de papier. Durant la transition, vous pourriez trouver un mélange de papier et de plastique dans nos boîtes.

## QUEREMOS HACER MÁS SUSTENTABLES NUESTROS MATERIALES DE EMBALAJE

Estamos cambiando las bolsas de plástico desechables por bolsas con base de papel. Conforme avanzamos en este propósito, puedes encontrar una mezcla de papel y de plástico en nuestras cajas.

[LEGO.com/sustainable-packaging](https://LEGO.com/sustainable-packaging)



# BUILDER



Apple and the Apple logo are trademarks of Apple Inc., registered in the U.S. and other countries and regions. App Store is a service mark of Apple Inc. Google Play and the Google Play logo are trademarks of Google LLC. Tencent and the Tencent logo are trademarks of Tencent Inc.

LEGO.com/devicecheck



LEGO® Builder



## *Un retour à l'époque médiévale* *Un viaje por un sendero medieval*

Have you ever imagined what life outside the classic LEGO® Castle walls might have looked like? This set invites you to travel back in time and visit a bustling medieval market square situated not too far from the Castle. Get to know the talented craftspeople who bring this town to life, and take part in the local leisure, pleasures and treasures hidden in every nook and cranny.

Avez-vous déjà imaginé à quoi pouvait ressembler la vie à l'extérieur des murs du château LEGO® classique ? Cet ensemble vous invite à voyager dans le temps et à visiter une place de marché médiévale animée située non loin du château. Faites connaissance avec les artisans talentueux qui donnent vie à la ville et découvrez les loisirs, les plaisirs et les trésors cachés dans tous les recoins.

¿Has imaginado cómo sería la vida fuera de las murallas de un clásico castillo LEGO®? Este set te invita a viajar en el tiempo para visitar un bullicioso mercado medieval ubicado a pocas leguas del gran edificio. Conoce a los talentosos artesanos que dan vida a este poblado y experimenta de primera mano las actividades recreativas, los placeres y los tesoros ocultos en cada uno de sus rincones.



*The marketplace is home to The Broken Axe Inn, a Watchtower, a Cheesemaker's shop, a Carpenter's workshop and a Farmhouse. Open the houses to peek at the activities inside!*

*La place du marché abrite l'auberge de la Hache brisée, une tour de guet, une fromagerie, un atelier de menuiserie et une maison de ferme. Ouvrez les maisons pour observer les activités qui se déroulent à l'intérieur !*

*El mercado alberga la Posada del Hacha Rota, una torre de vigilancia, una quesería, un taller de carpintería y una granja. ¡Abre las casas para dar un vistazo a las actividades que se desarrollan en su interior!*



*The craftspeople and villagers trade goods, favors and perhaps the occasional gossip around the old tree in the square. Feel free to join in the conversation as you build and explore the place.*

*Les artisans et les villageois échangent des marchandises, des faveurs et même quelques ragots autour du vieil arbre de la place. N'hésitez pas à vous joindre à la conversation pendant que vous construisez et explorez l'endroit.*

*Los artesanos y aldeanos intercambian bienes, favores y quizá algún rumor ocasional alrededor del viejo árbol de la plaza. No dudes en unirte a la conversación mientras construyes y exploras el lugar.*



## *A tour of the village of Felsa* *Une visite du village de Felsa* *Un recorrido por la aldea de Felsa*

👉 The village attracts a colorful clientele of creative craftspeople. From livestock and hay to homemade cheeses and ornate chairs, they provide the village and the Castle with delightful food, entertainment, building supplies and interior accessories. A Lion Knights' Guard oversees the safety of the village and Wanted posters on the tree warn of wayward wanderers and charlatans in sheep's clothing. All in all, it's a peaceful place where people get on well and help each other.

👉 Le village attire une clientèle d'artisans créatifs hauts en couleur. Du bétail au foin en passant par les fromages maison et les chaises ornées, ils fournissent au village et au château des aliments délicieux, des divertissements, des matériaux de construction et des accessoires d'intérieur. Une garde de chevaliers du lion veille à la sécurité du village et des avis de recherche placardés sur les arbres mettent les villageois en garde contre les vagabonds et les charlatans en apparence inoffensifs. Dans l'ensemble, c'est un endroit paisible où les gens s'entendent bien et s'entraident.

👉 La aldea atrae a una variada clientela de creativos artesanos. Desde ganado y paja hasta quesos caseros y sillas decoradas, proveen a la aldea y al castillo de deliciosa comida, entretenimiento, materiales de construcción y accesorios domésticos. Un guardia de los Caballeros del León mantiene el orden en la aldea, y carteles con la leyenda "Se busca" colocados en el árbol advierten a los lugareños de los forajidos y los charlatanes con piel de oveja que deambulan por la zona. En general, es un lugar tranquilo donde los pobladores se llevan bien y se ayudan mutuamente.

*A day in the life*  
*Une journée ordinaire*  
*Un día normal*

At the end of a long day's work, the hardworking villagers enjoy gathering for a well-deserved drink and some solid, hearty fare at the Broken Axe Inn. They can take turns playing the lute or challenging each other to a game of draughts. (Rumor has it that the Queen's Tax Collector is a formidable, yet perhaps not entirely fair, opponent.)

À la fin d'une longue journée de travail, les villageois laborieux aiment se retrouver à l'auberge de la Hache brisée pour boire un verre bien mérité et déguster un repas copieux. À tour de rôle, ils peuvent jouer du luth ou se défier au jeu de dames. (La rumeur veut que le percepteur de la reine soit un adversaire redoutable, mais pas forcément très honnête.)

Al final de una larga jornada de trabajo, los esforzados aldeanos se reúnen para disfrutar de una merecida bebida y una buena comida casera en la Posada del Hacha Rota. Pueden turnarse para tocar el laúd o desafiarse a una partida de damas. (Se rumora que el recaudador de impuestos de la reina es un oponente formidable, aunque quizá no siempre juegue limpio).





## *Inspired by LEGO® history*

📌 In 2009, the LEGO® Medieval Market Village (10193) was released to wide acclaim from fans everywhere. The detailed, hinged buildings, popular animal figures and charismatic minifigure gallery inspired vivid and creative storytelling in builders of all ages. This set brings these stories and the exciting building experience just a little further, with even more flexibility and action scenarios.

## *Inspiré par l'histoire LEGO®*

📌 Lancé en 2009, LEGO® Medieval Market Village (10193) a été très bien accueilli par les amateurs du monde entier. Les bâtiments détaillés et articulés, les animaux populaires et les figurines charismatiques ont inspiré des histoires vivantes et créatives aux constructeurs de tous âges. Cet ensemble permet d'enrichir les histoires et l'expérience passionnante de la construction en offrant davantage de flexibilité et de scénarios d'action.

## *Inspirado en la historia de LEGO®*

📌 En 2009 salió a la venta el set LEGO® Medieval Market Village (10193), gozando de un gran éxito entre los fans de todo el mundo. Los detallados edificios articulados, las populares figuras de animales y el carismático elenco de minifiguras inspiraron historias vívidas y creativas en constructores de todas las edades. Con aún más flexibilidad y escenarios de acción, este set lleva todas esas historias y la emocionante experiencia de construcción un poco más allá.



*From your LEGO® historian  
Un mot de votre historien LEGO®  
Notas del historiador de LEGO®*



**HENRIK RUBIN SAABY**  
LEGO® Senior Designer  
concepteur principal LEGO®  
diseñador sénior de LEGO®

“When we decided to revive this popular theme, we wanted to stay as true to the medieval period as possible and include intricate details to please the eye as well as your ‘inner story.’ We’re introducing new characters, like the Queen’s Tax Collector and the Innkeeper, and for the first time, we have three houses hinged together so you can angle and display your model however it fits your shelf or imagination.”

« Lorsque nous avons décidé de revisiter ce thème populaire, nous voulions rester aussi fidèles que possible à la période médiévale et inclure des détails complexes pour plaire tant à l’œil qu’à votre “histoire intérieure”. Nous présentons de nouveaux personnages, comme le perceuteur de la reine et l’aubergiste, et pour la première fois, nous proposons trois maisons reliées par des charnières, ce qui vous permet d’orienter et de présenter votre modèle en fonction de votre étagère ou de votre imagination. »

“Cuando nos decidimos a revivir este popular tema, quisimos mantenernos lo más fieles posible a la época medieval e incluir detalles elaborados para agradar tanto a la vista como a tu ‘historia interior’. Ahora presentamos nuevos personajes, como el recaudador de impuestos de la reina y la encargada de la posada y, por primera vez, tenemos tres casas con uniones articuladas para que puedas girar y exhibir tu modelo según lo que dicte tu imaginación o como mejor se adapte a tu estante”.

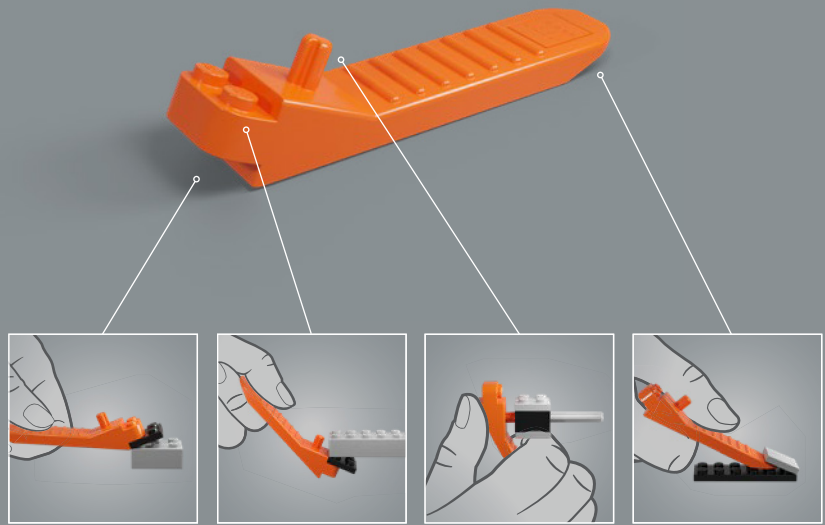

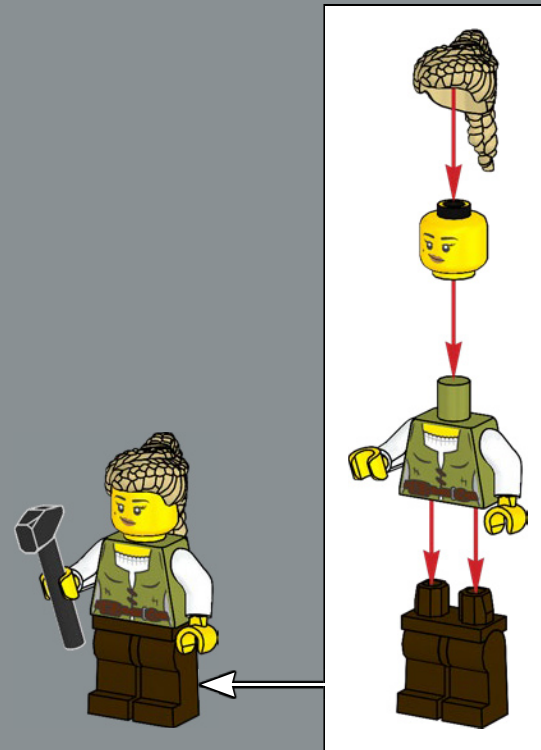

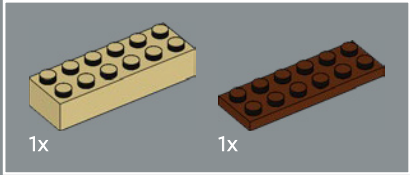
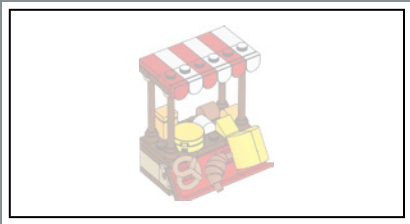

1

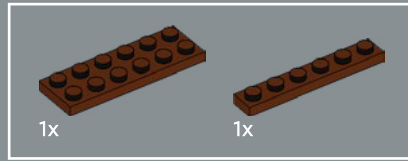
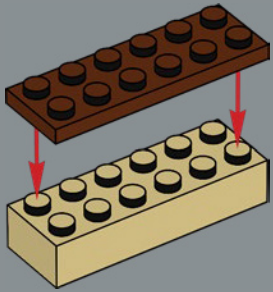

2

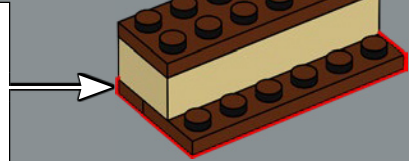
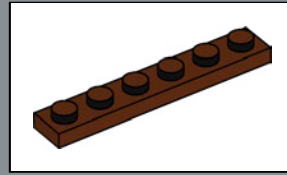

3

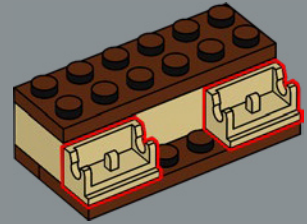

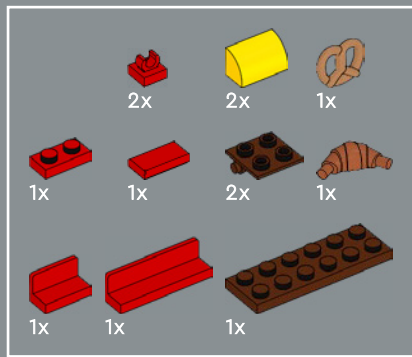

4

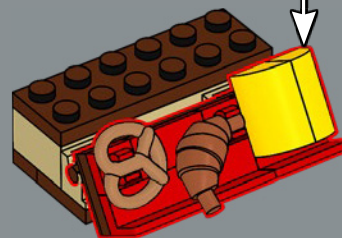
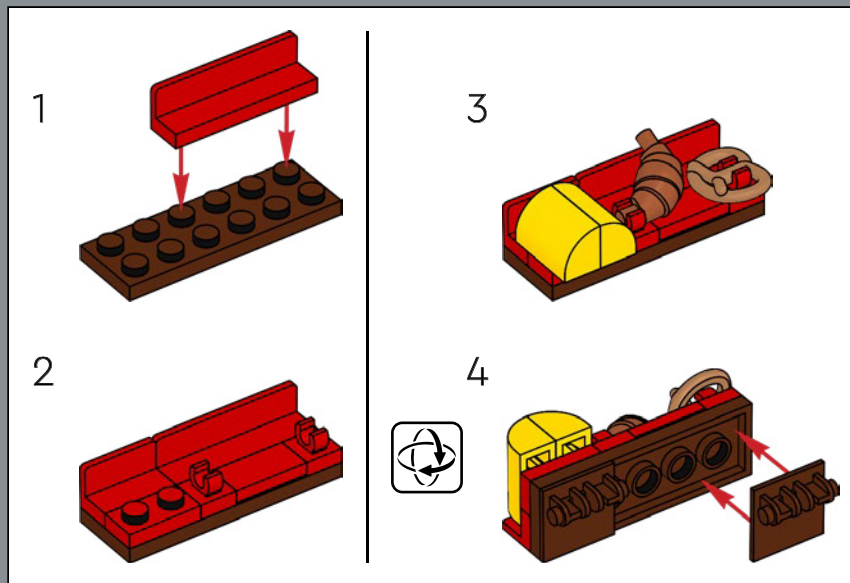



5

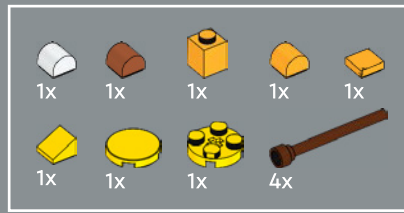
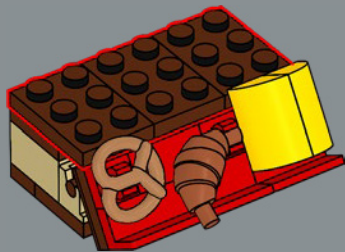

6

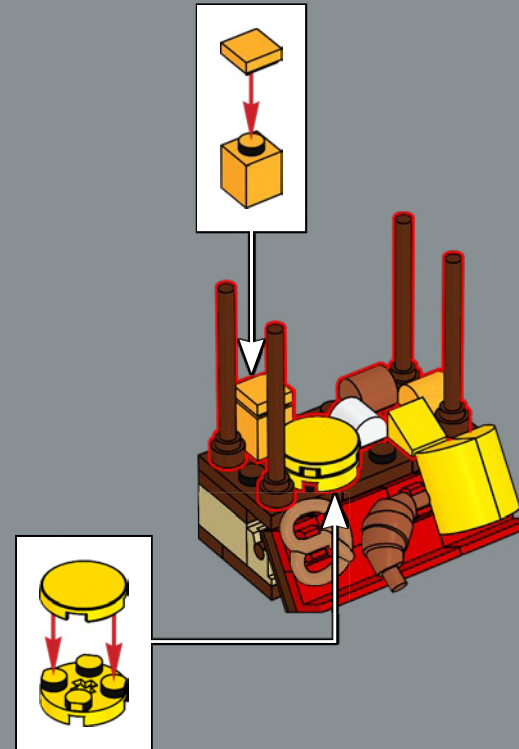

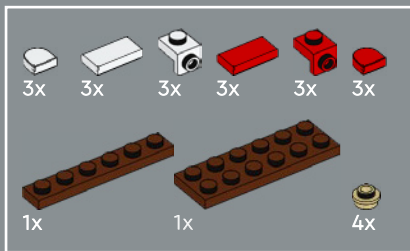

7

1



2

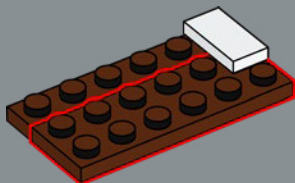

3

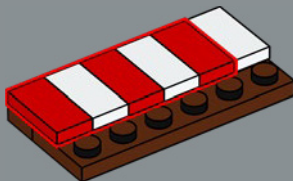

4

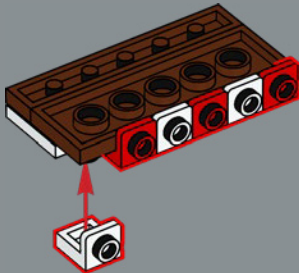

5

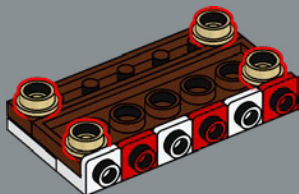

6

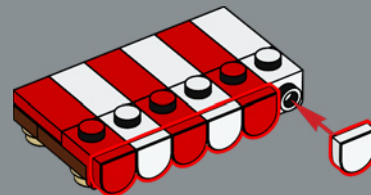

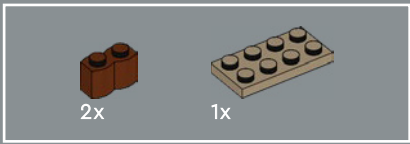
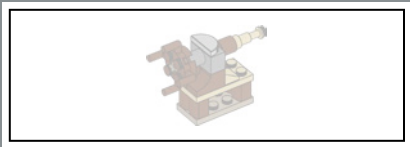

1

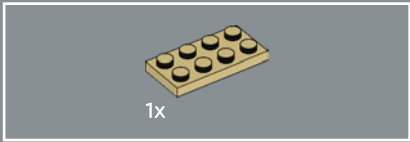
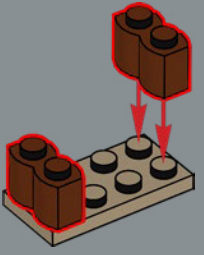

2

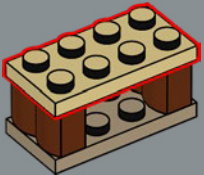

3

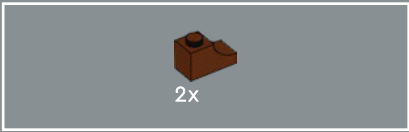
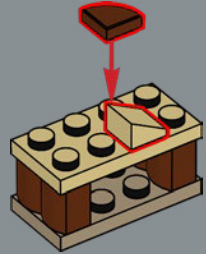

4

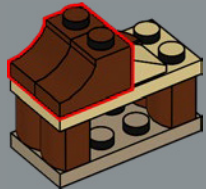



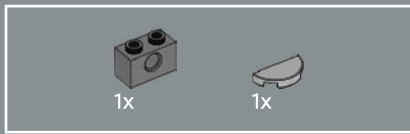

5

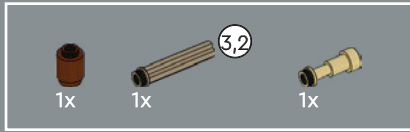
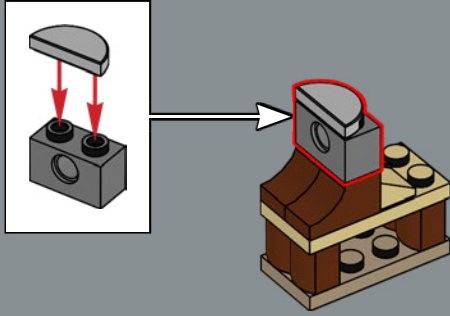

6

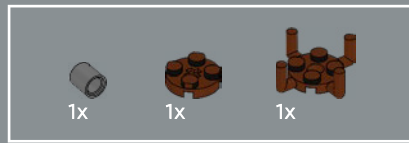
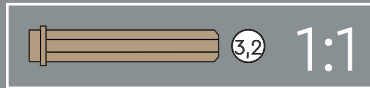
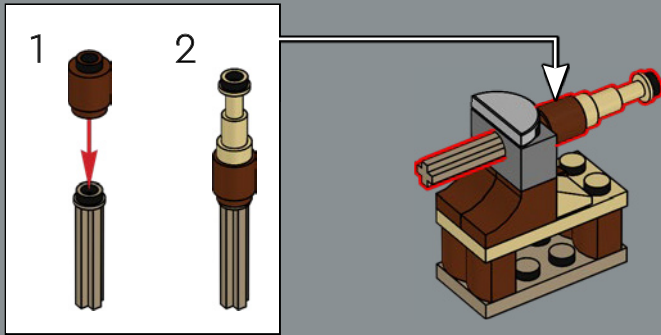

7

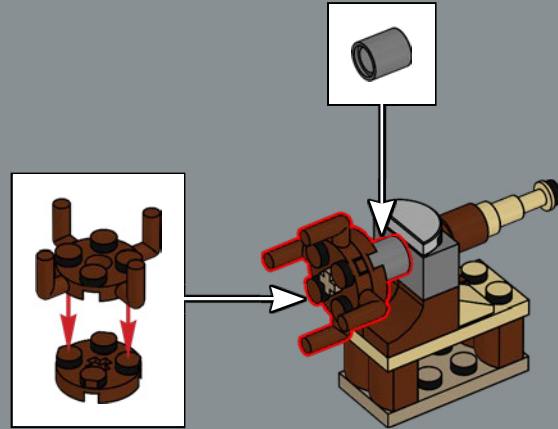



1x

2x

1

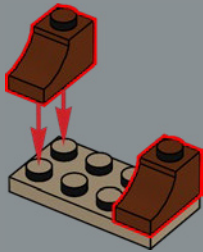

2x

2

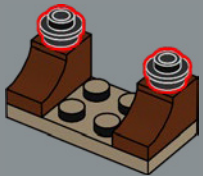

2x

1x

1x

3

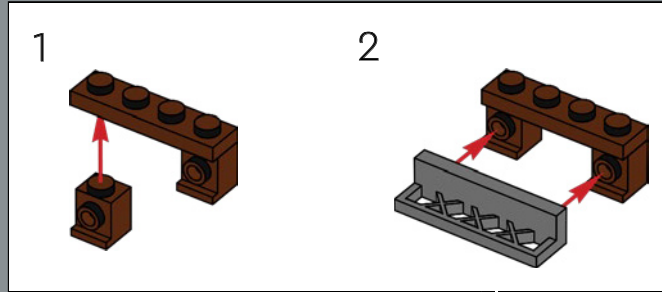

1

2

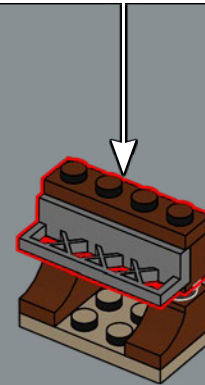

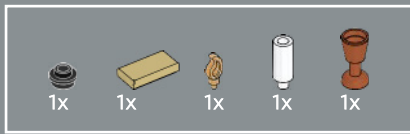

4

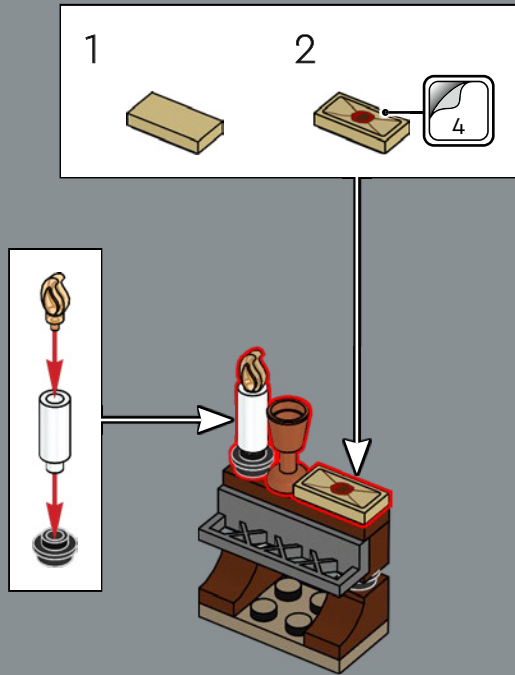

5

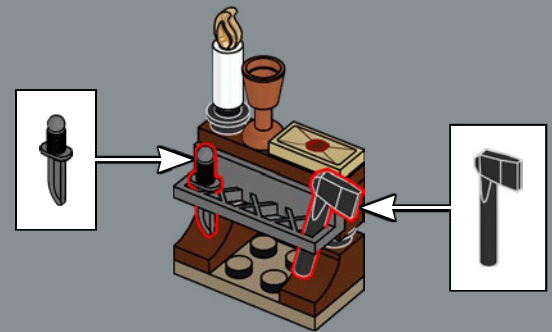

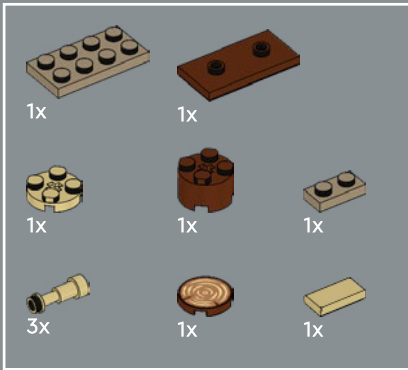

1

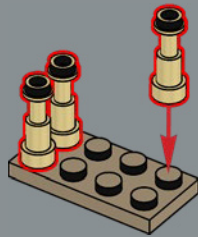

2

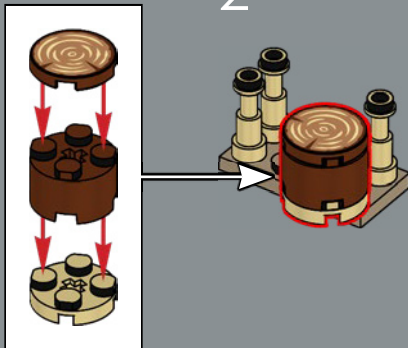

3

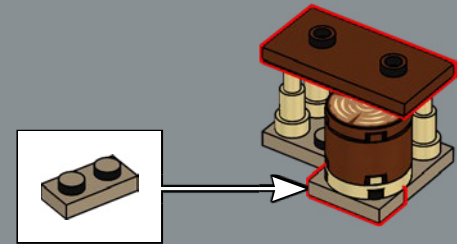

4

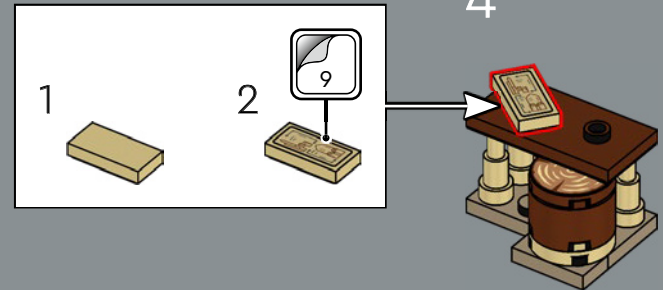

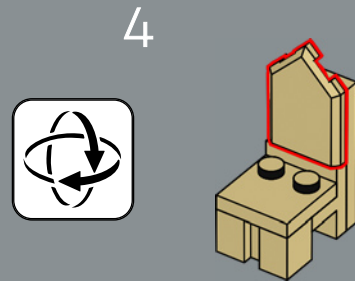
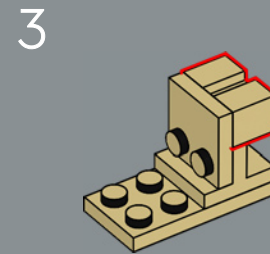
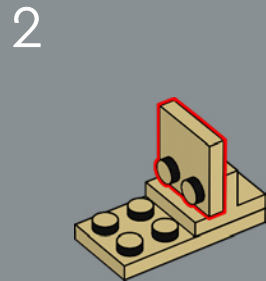
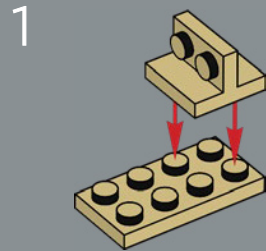
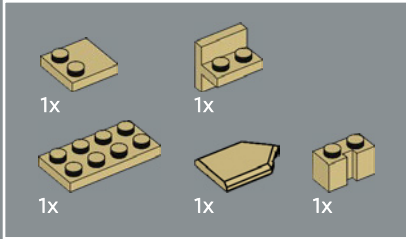
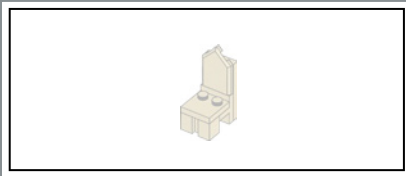

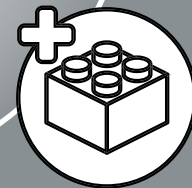
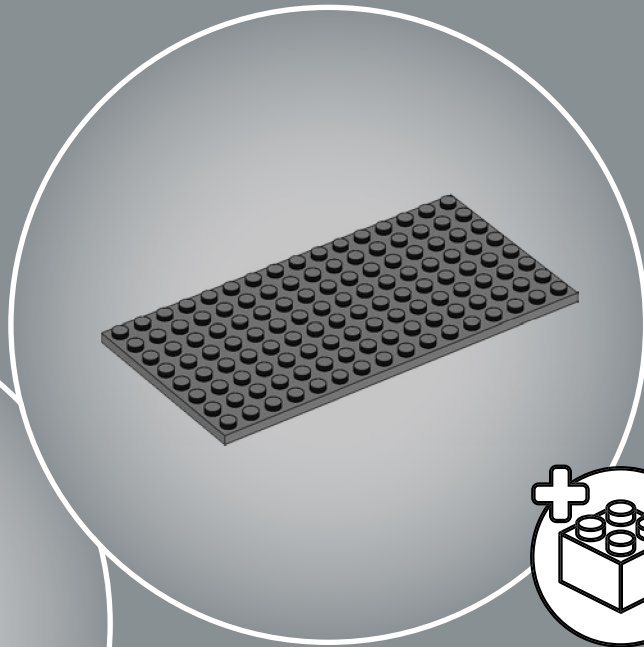



1

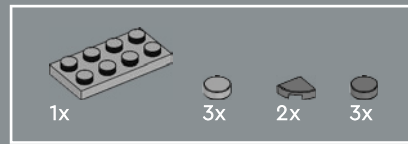
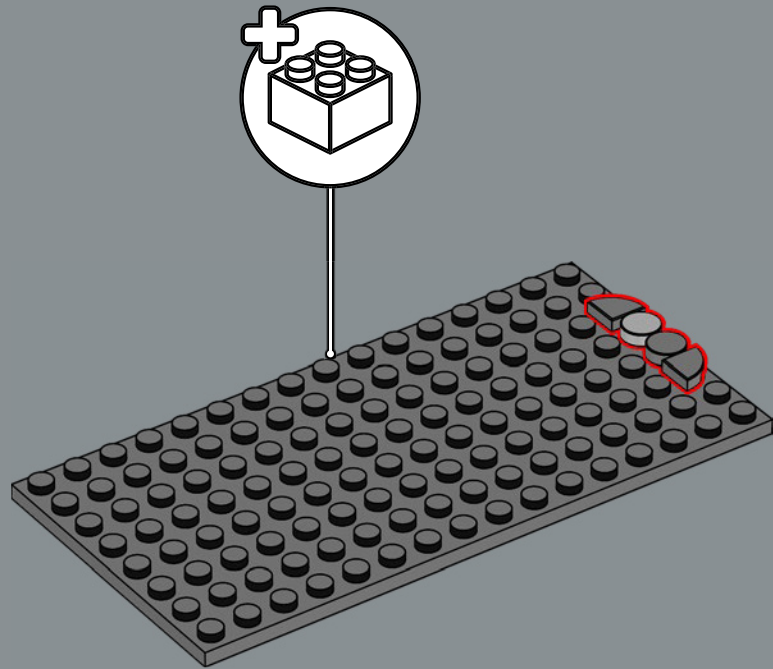

2

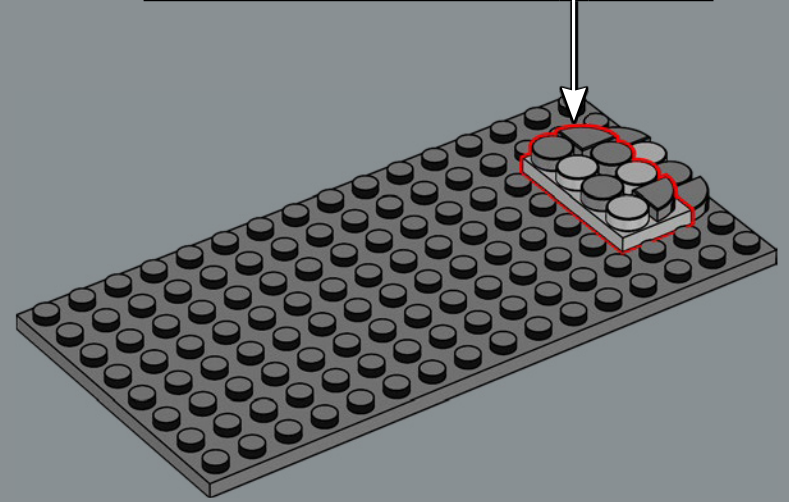
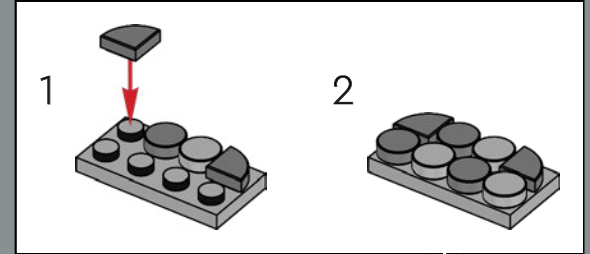

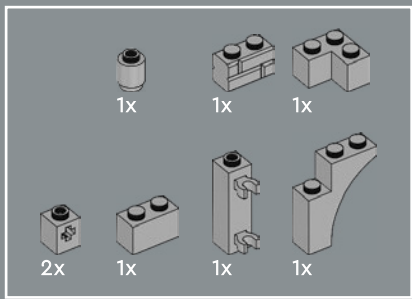

3

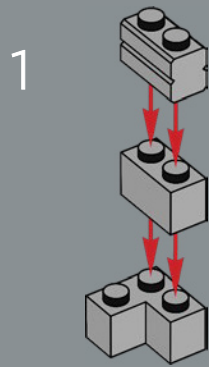

2

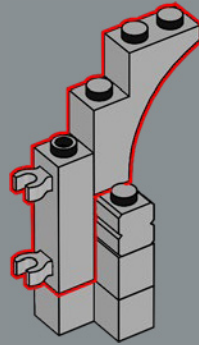

3

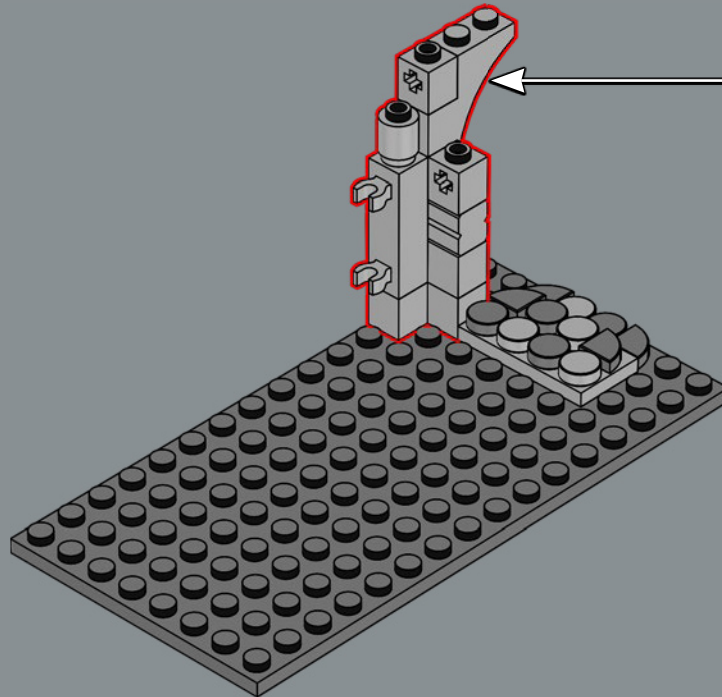
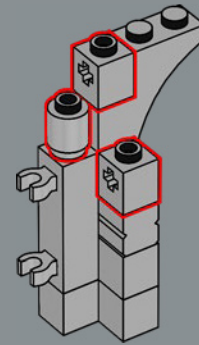



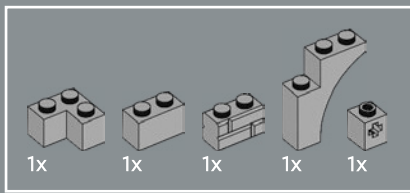

4

1

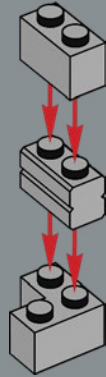

2

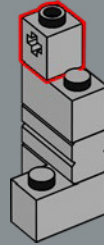

3

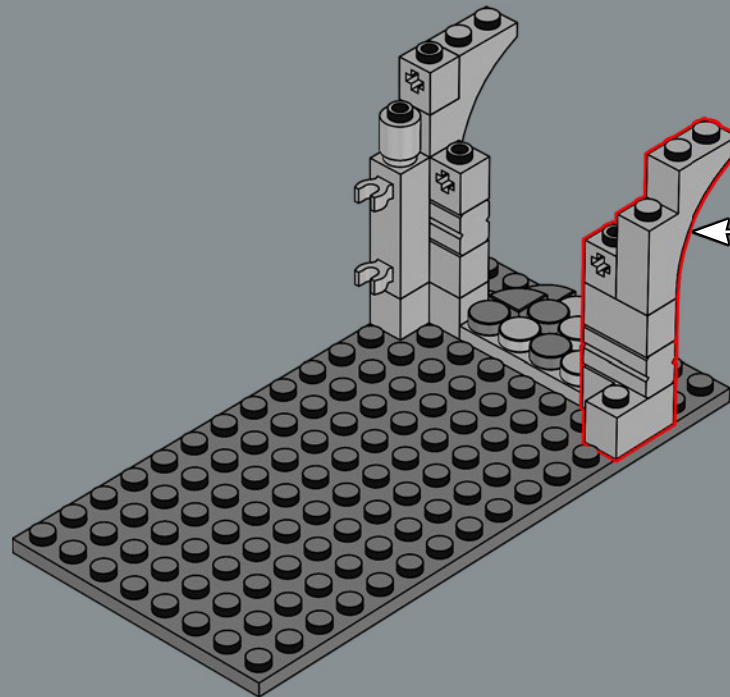
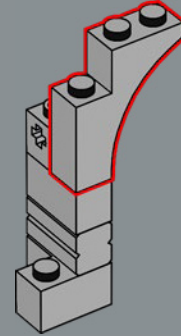

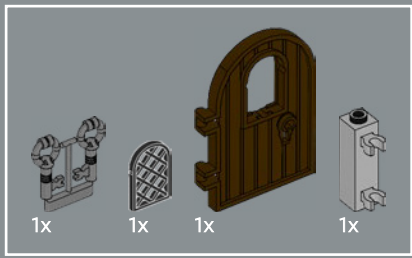

5

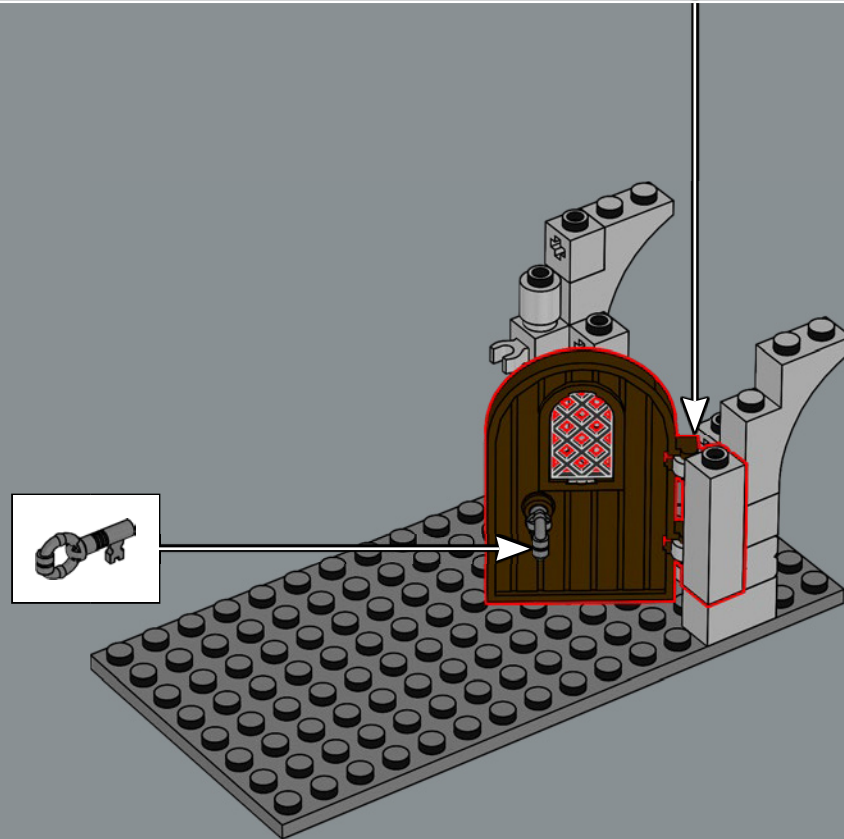
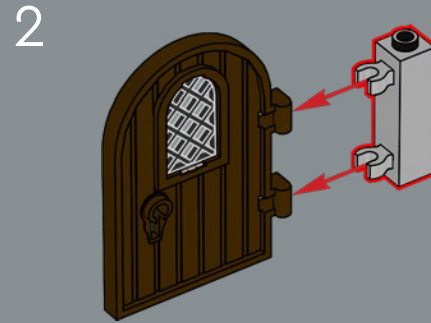
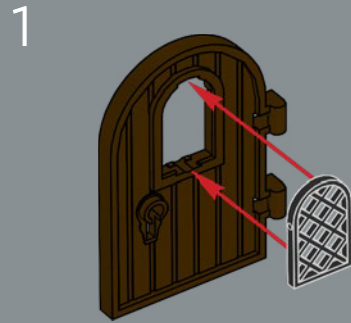

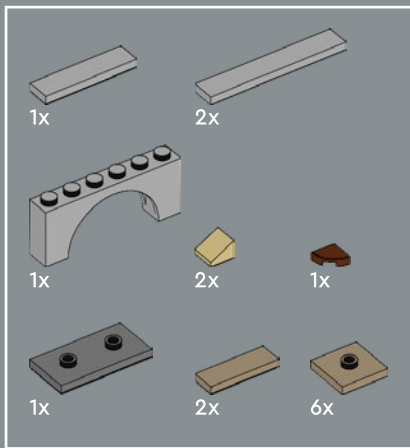

6

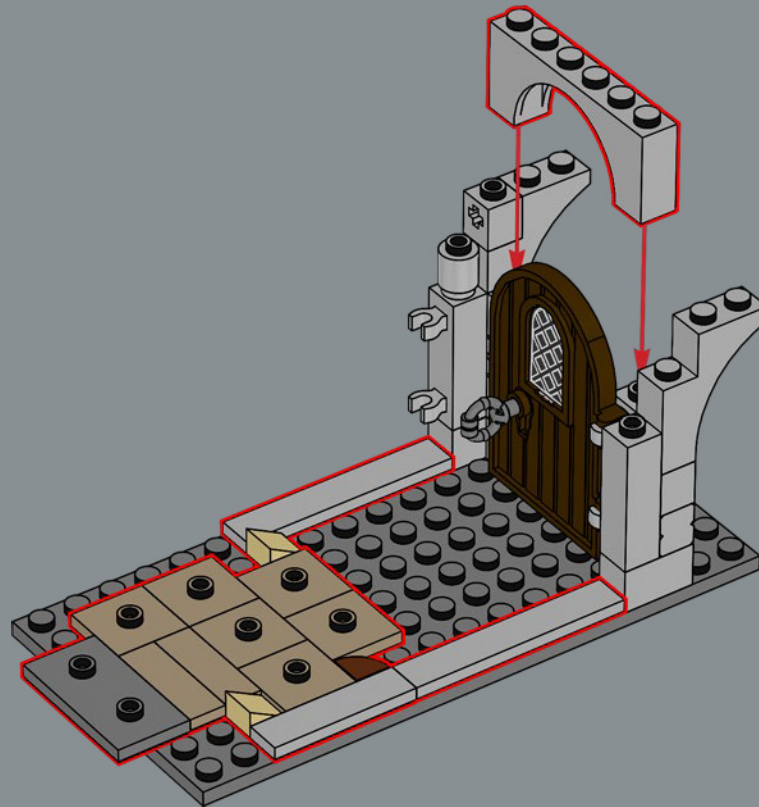

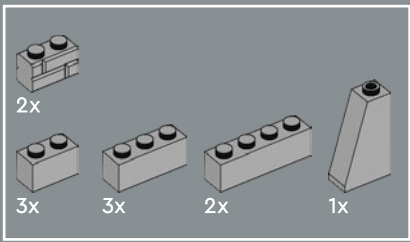

7

1

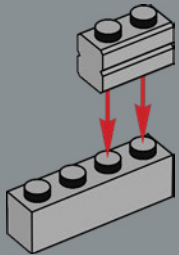

3

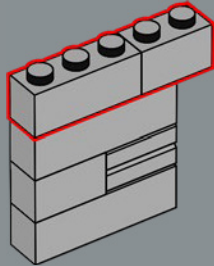

5

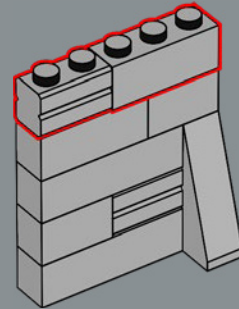

2

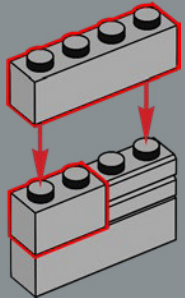

4

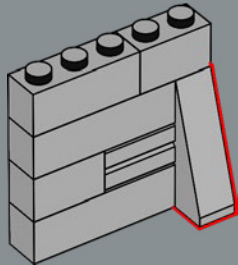

6

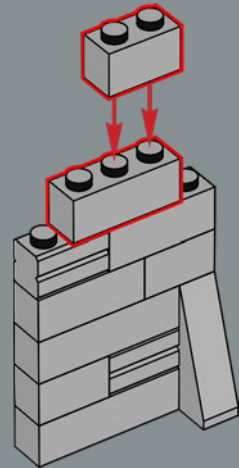

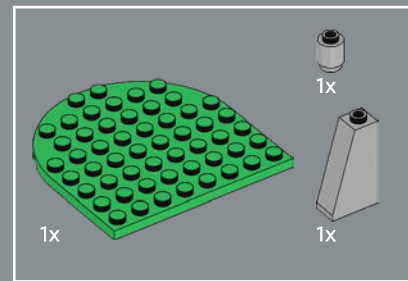
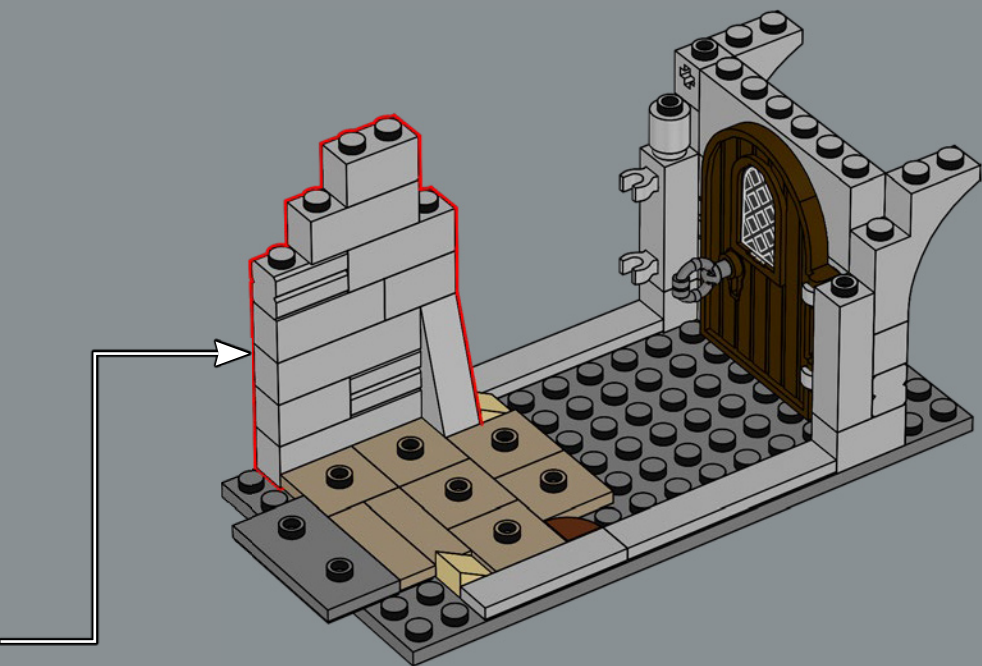

8

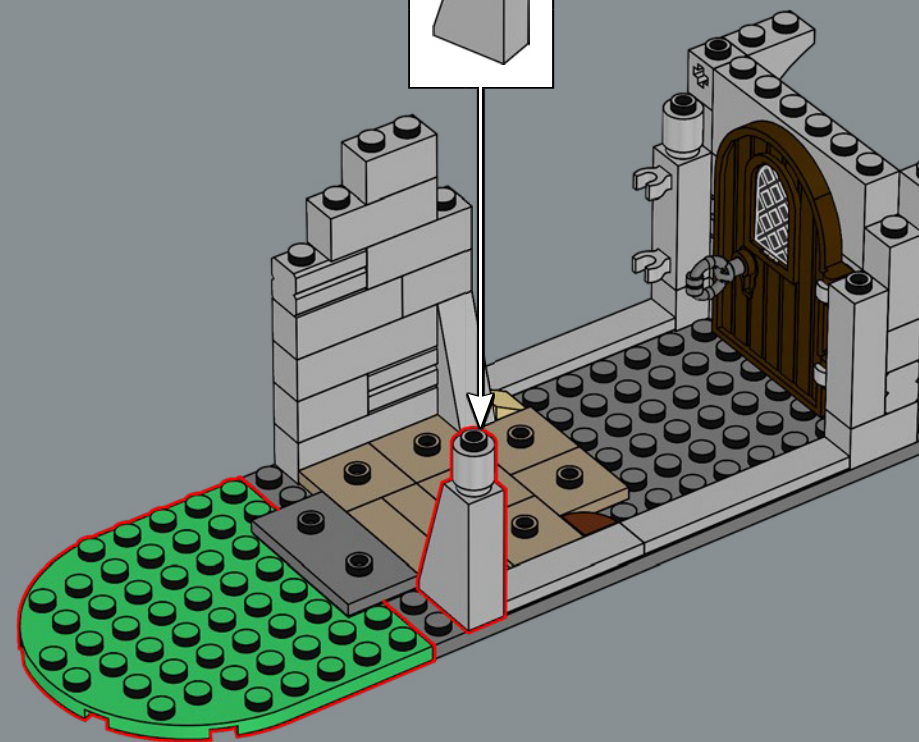
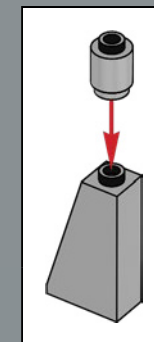

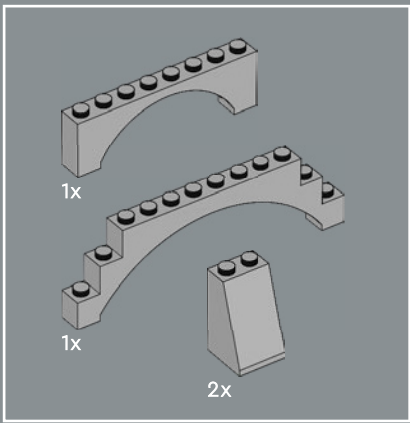

9

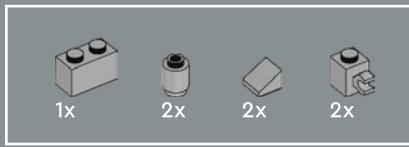
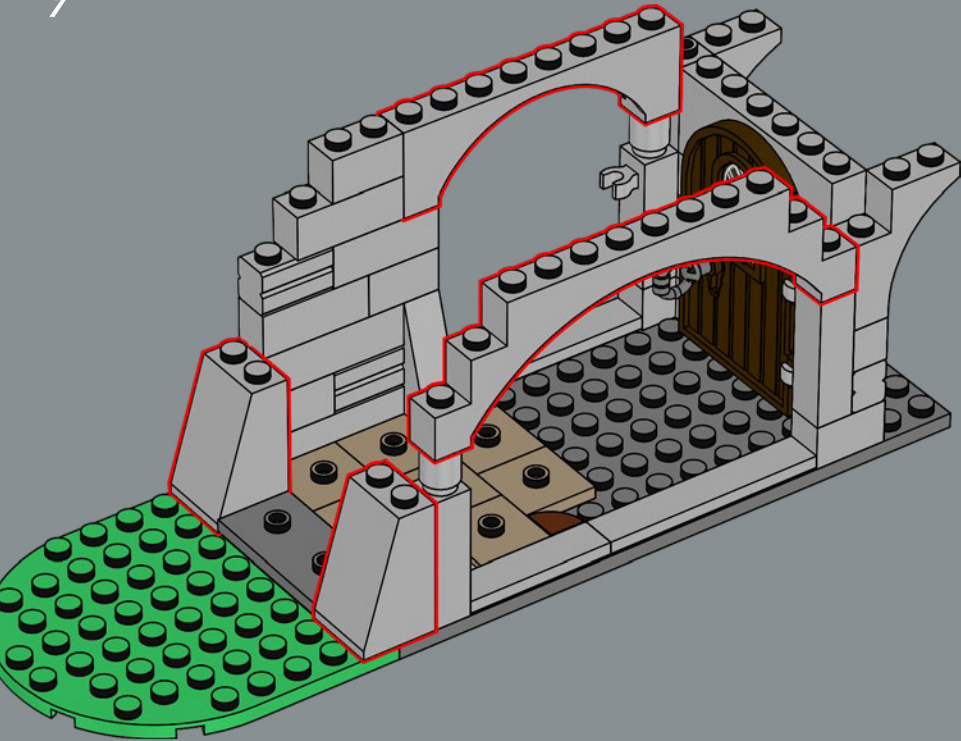

10

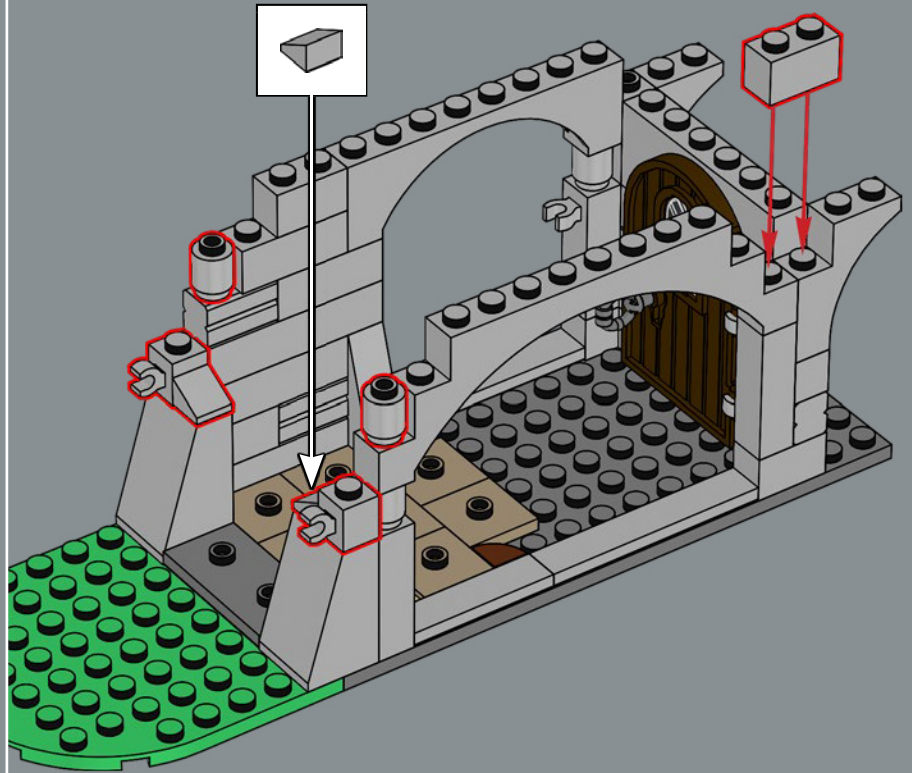

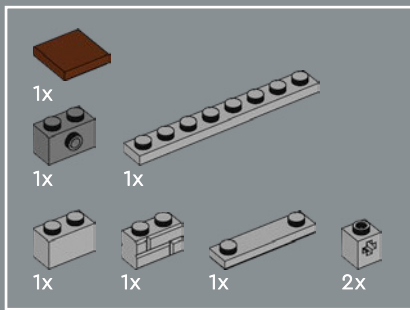

11

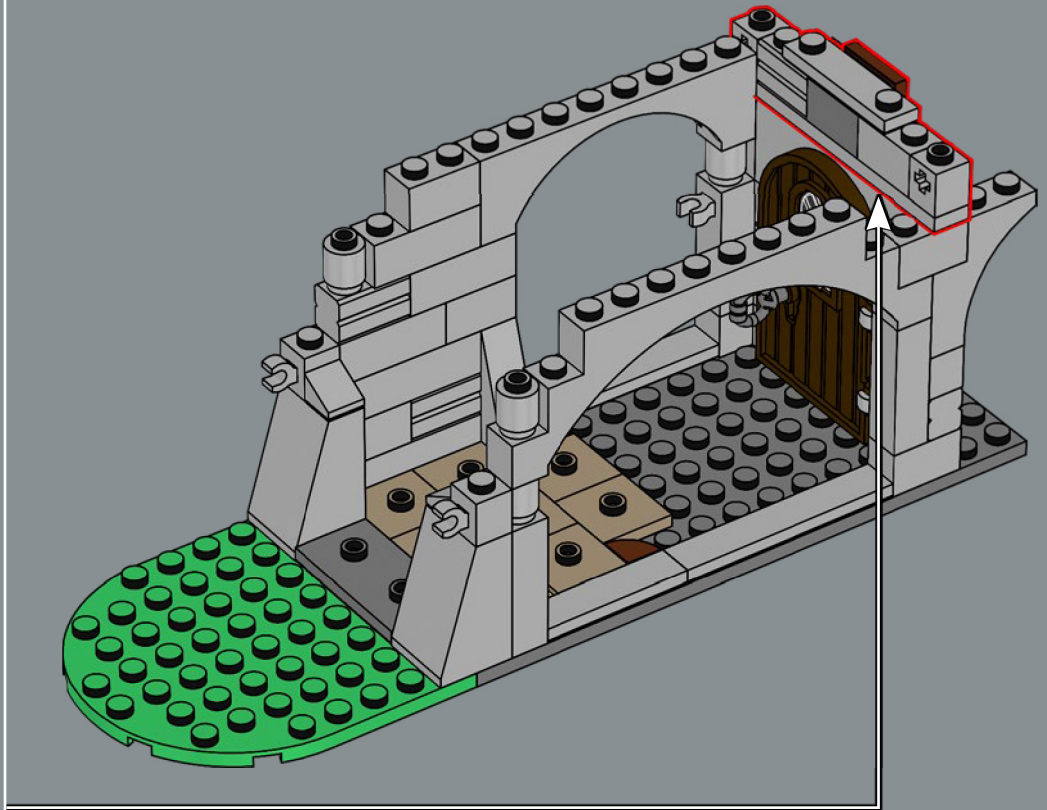
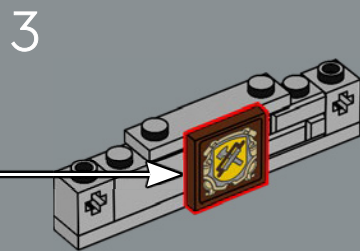
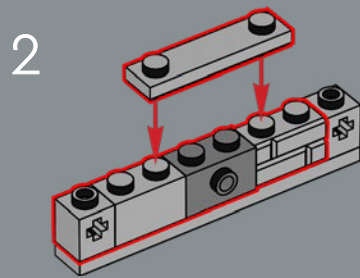
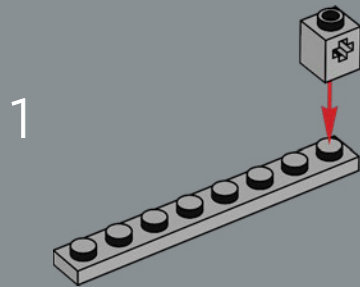

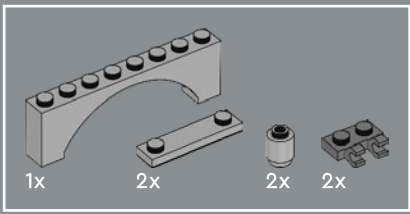

12

1

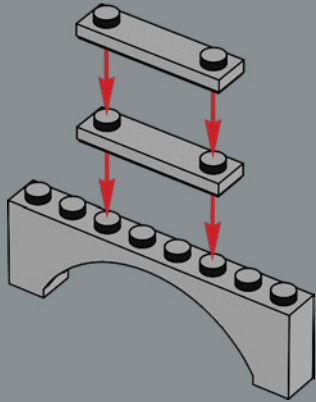

2

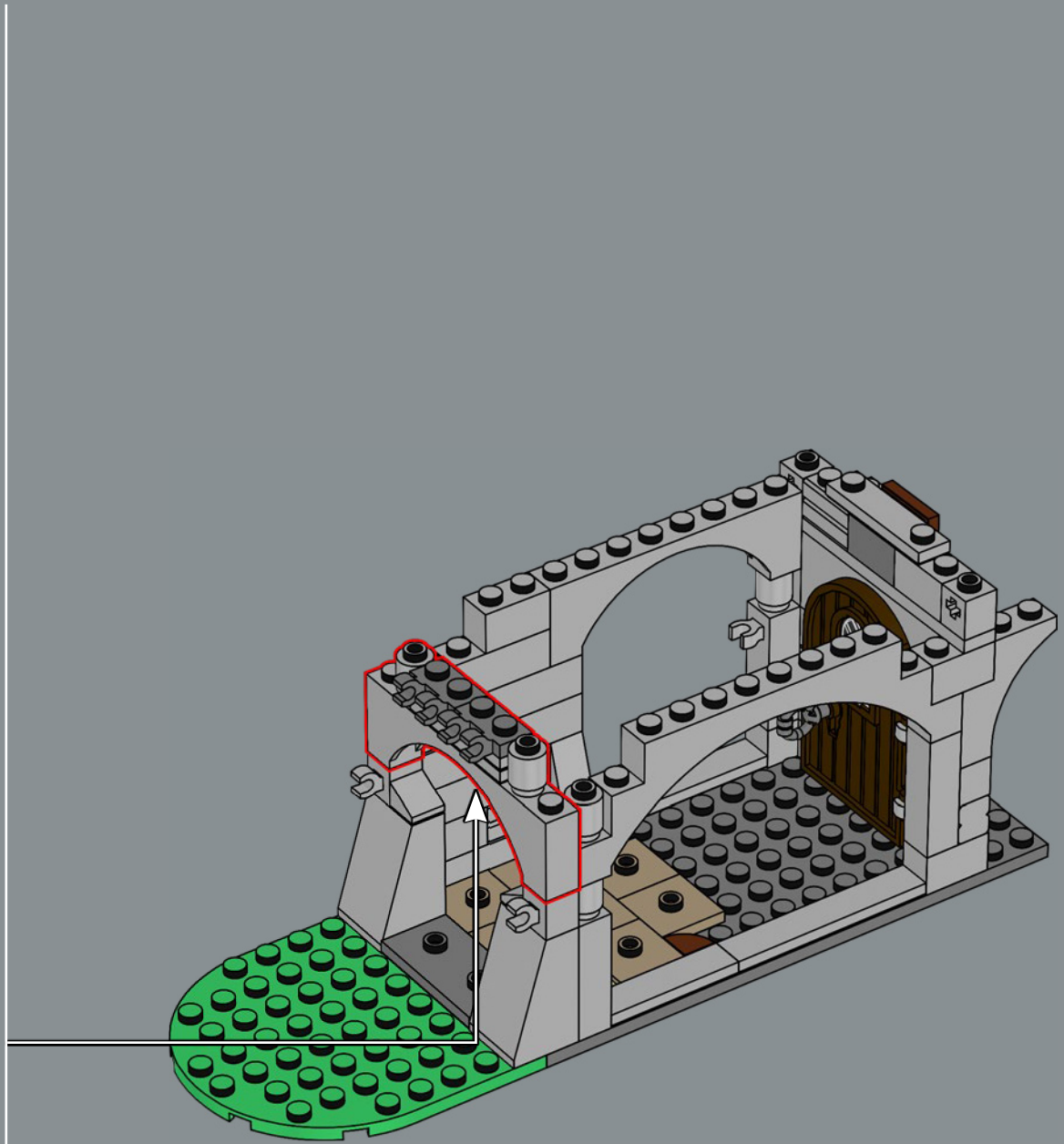
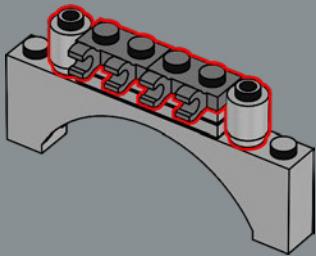



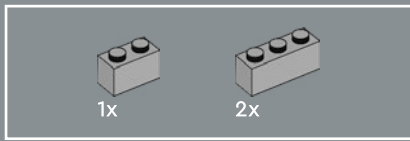

13

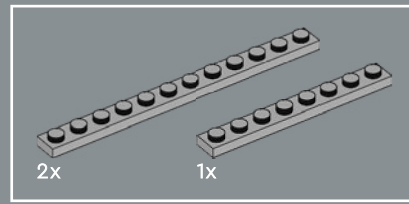
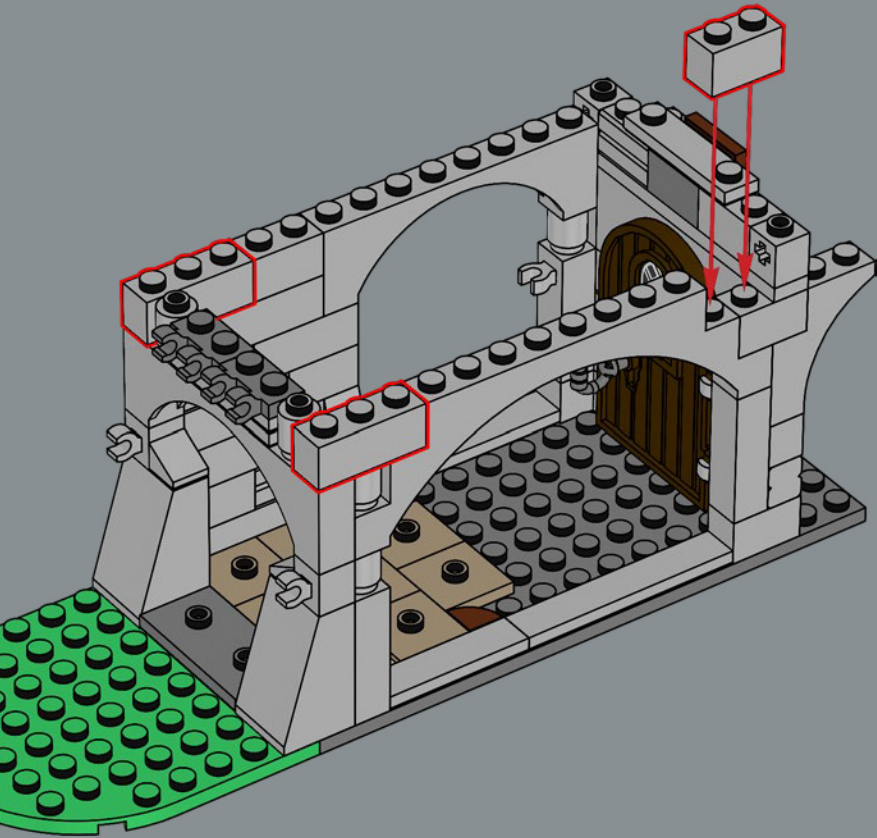

14

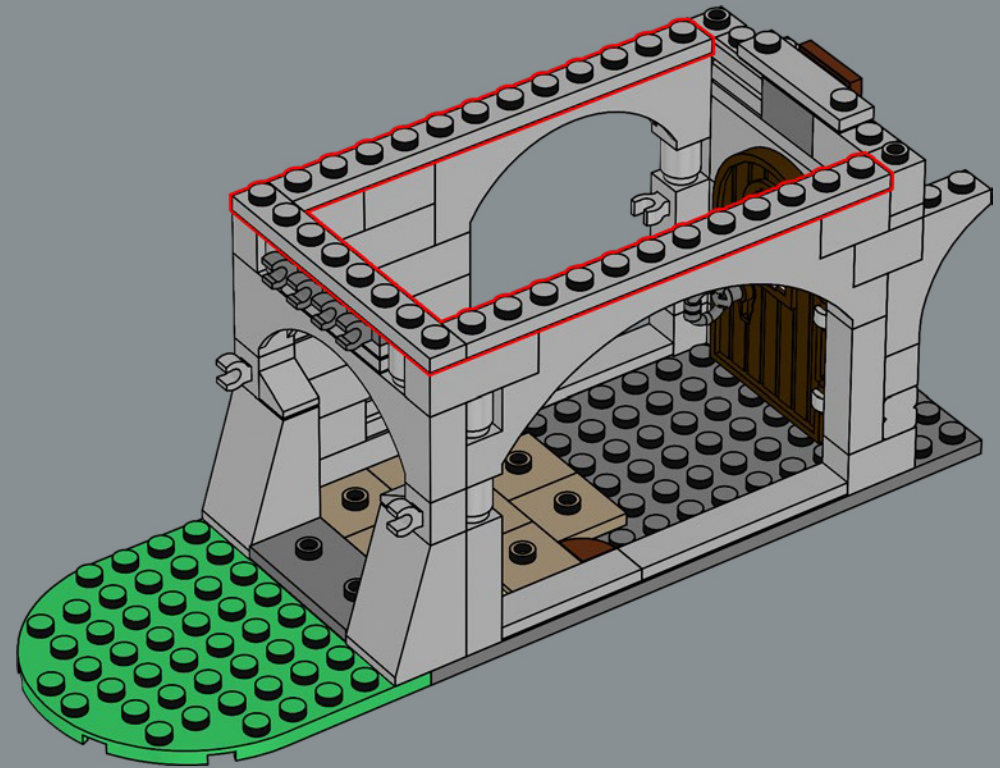

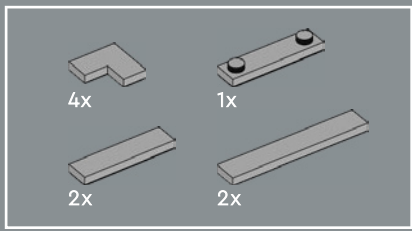

15

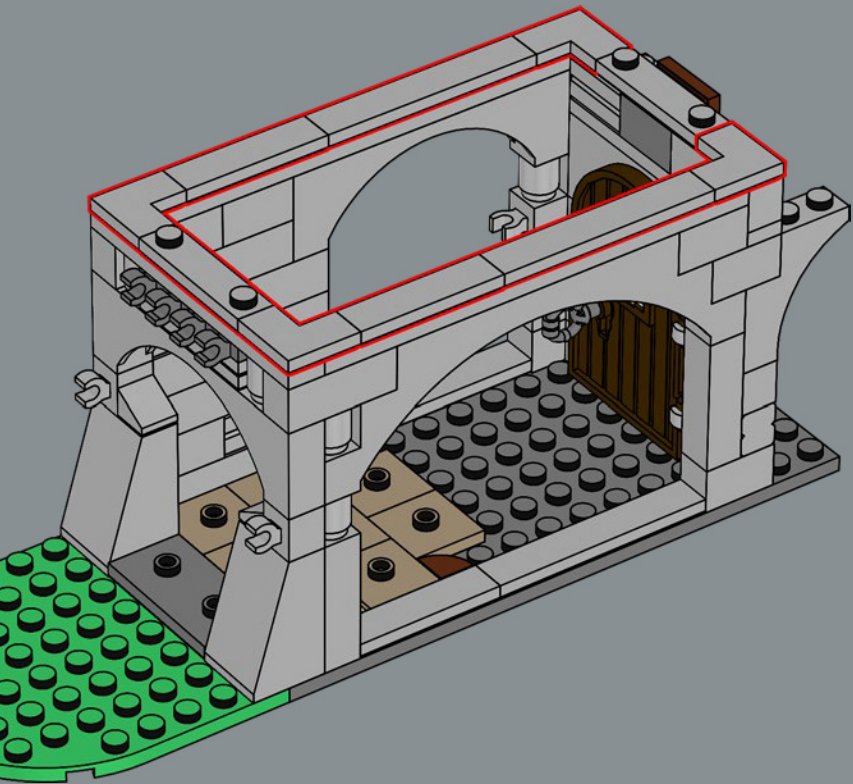

16

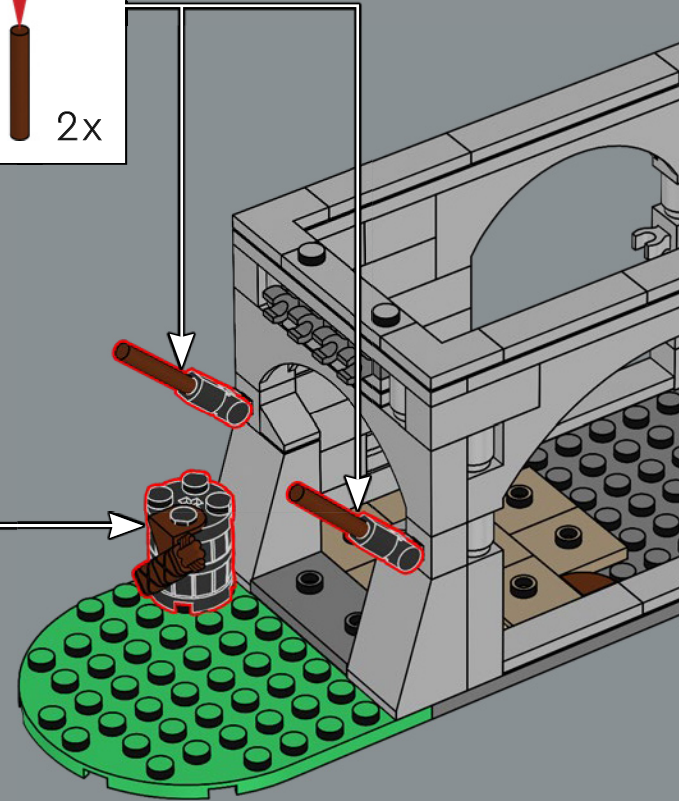
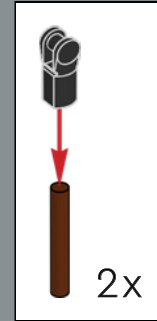



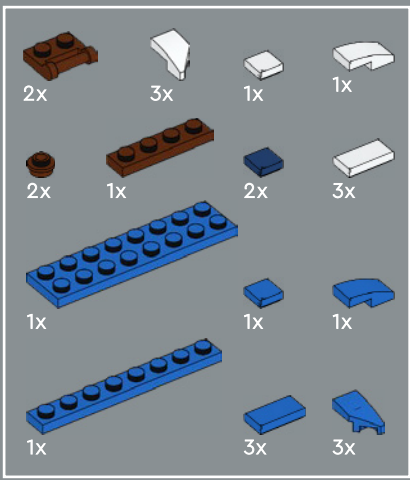

18

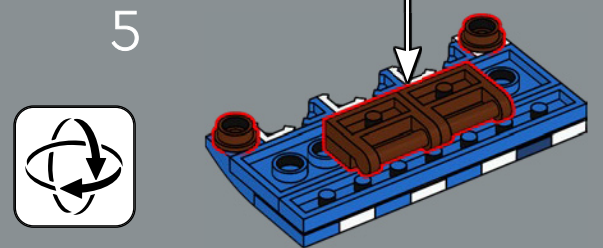
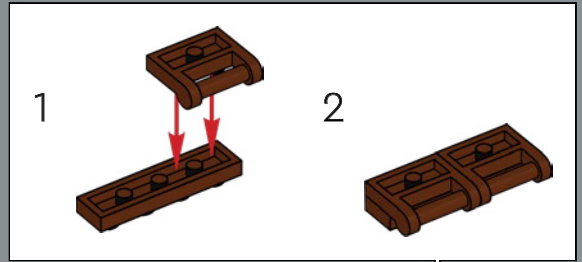
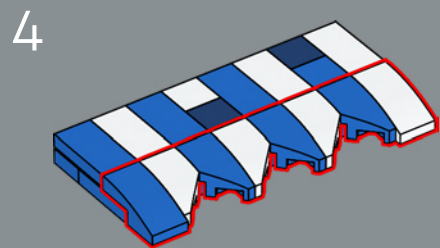
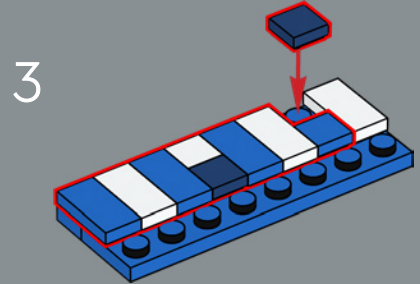
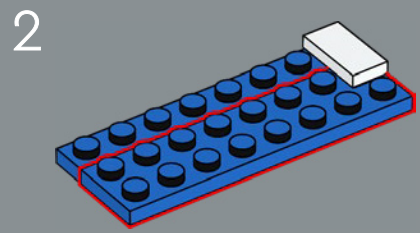
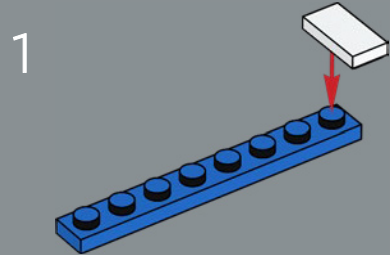

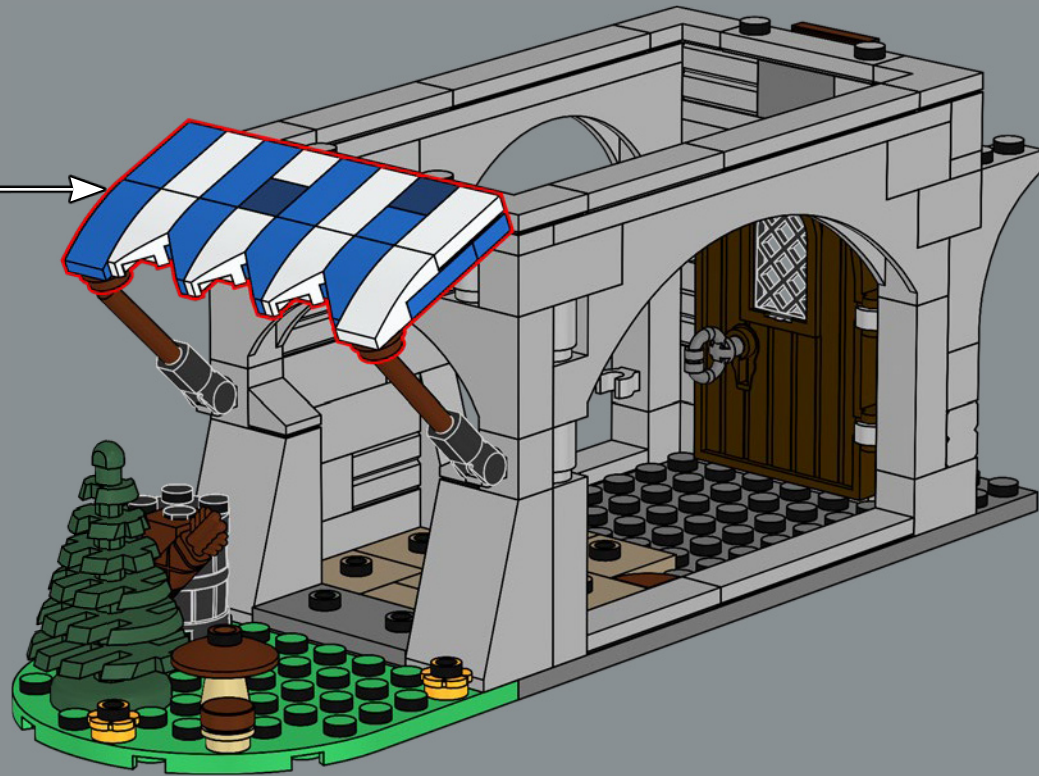



19

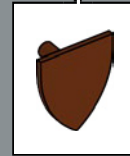
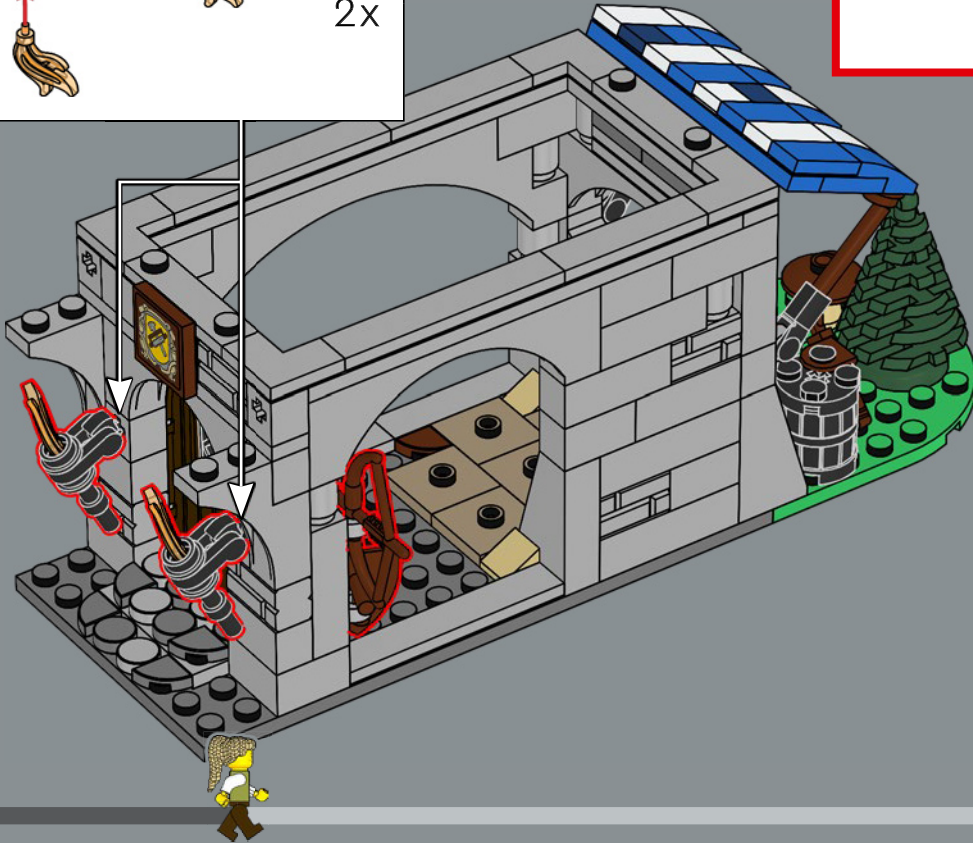
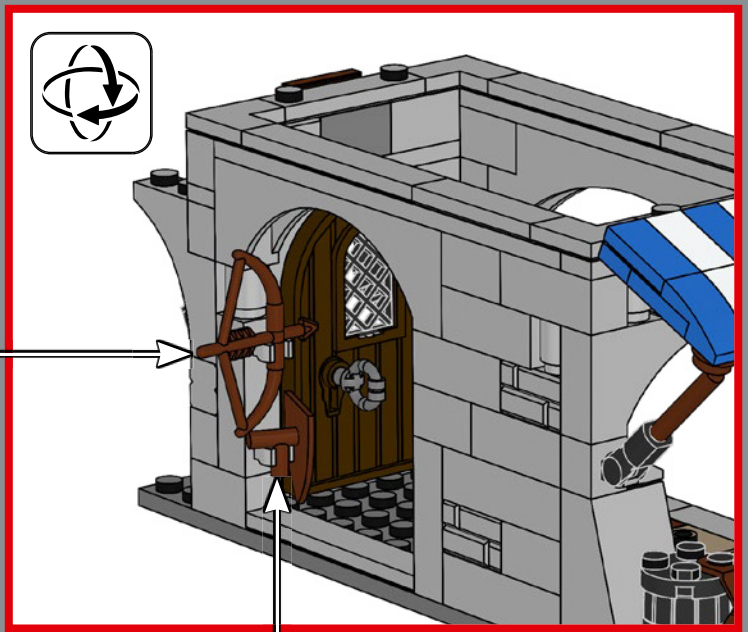
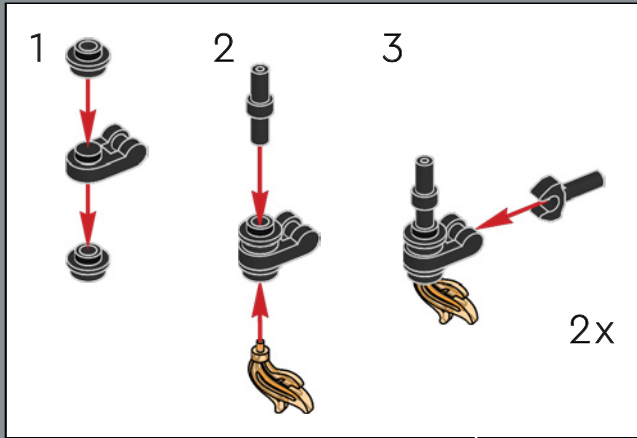



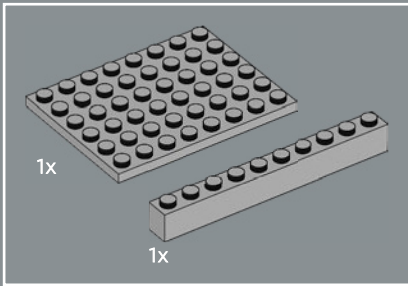
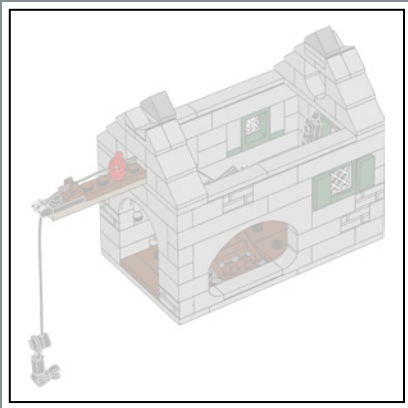

20

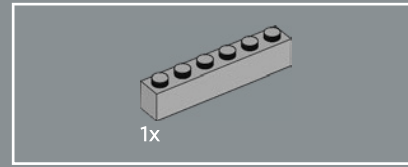
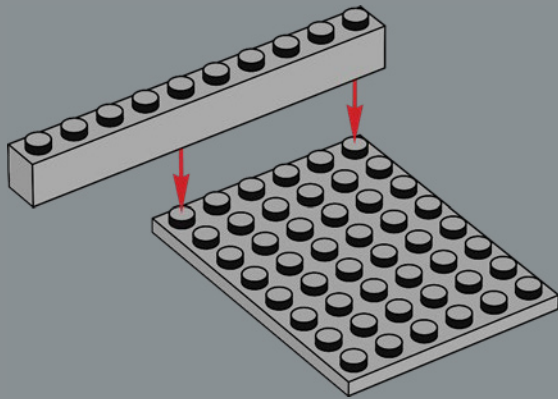

21

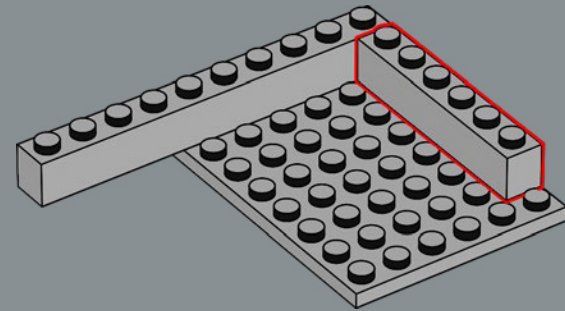



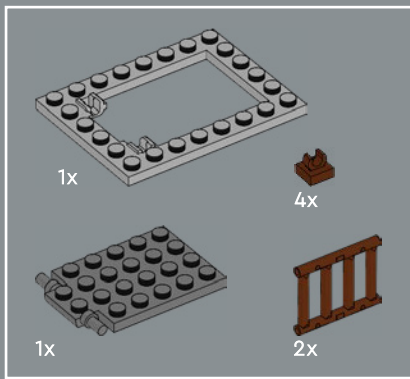

22

1

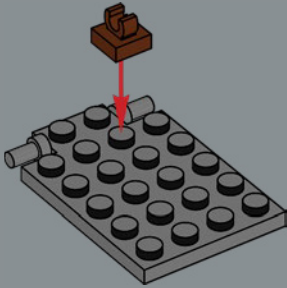

2

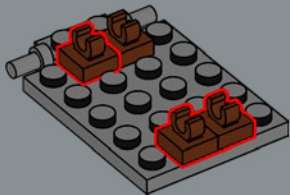

3

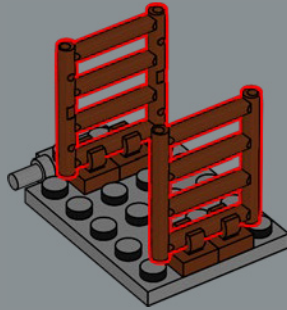

4

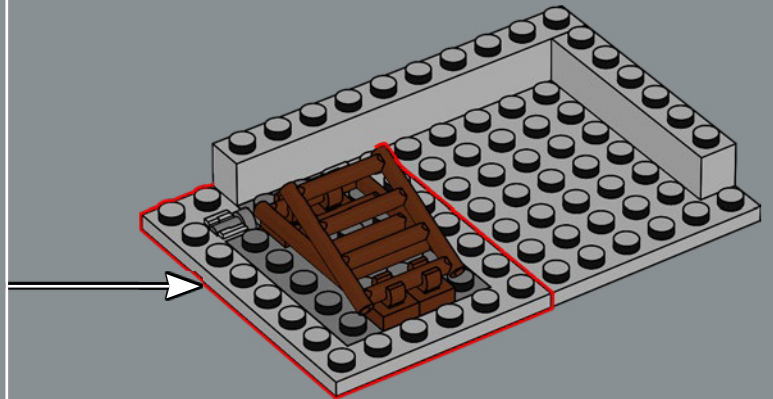
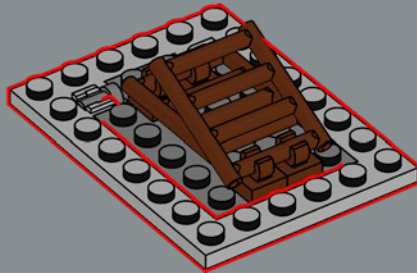

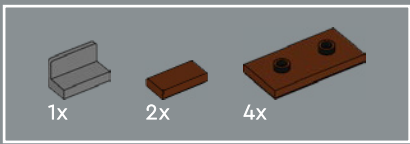

23

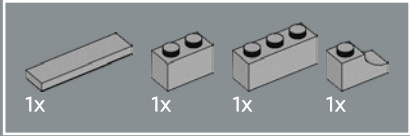
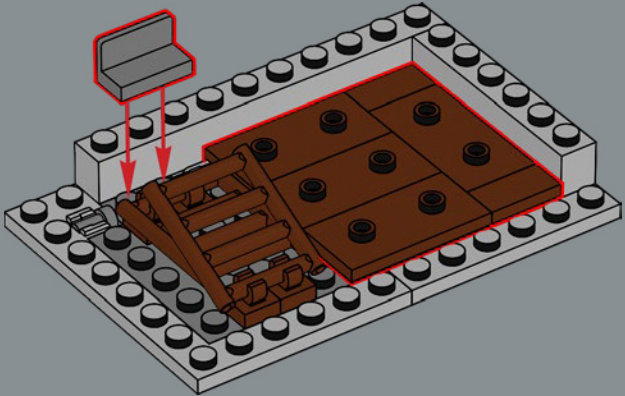

24

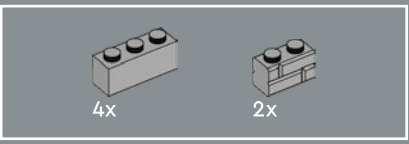
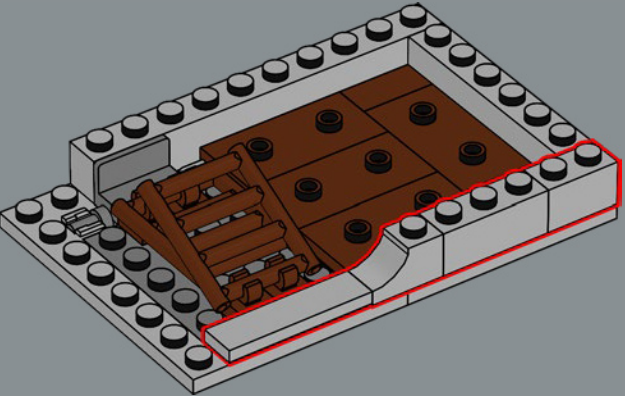

25

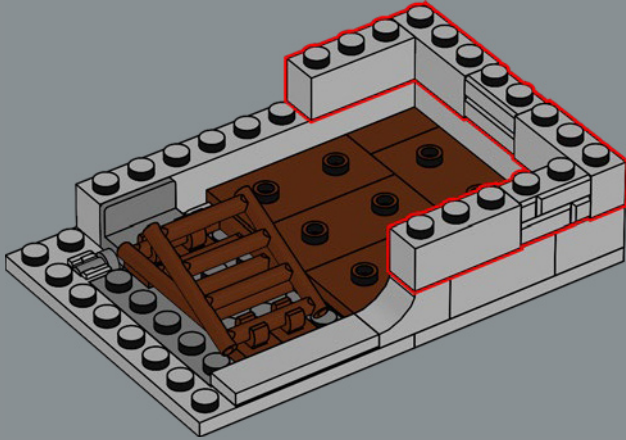

The ladder and hatch allow easy access to the Carpenter's workshop. (Use the release lever on the same side as the crane control.)

L'échelle et la trappe permettent d'accéder facilement à l'atelier de la menuisère. (Utilisez le levier de déverrouillage du même côté que la commande de la grue.)

La escalera y la portezuela facilitan el acceso al taller de la carpintera. (Utiliza la palanca de liberación ubicada por el mismo lado que el control de la grúa).



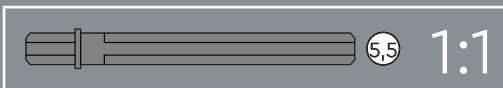
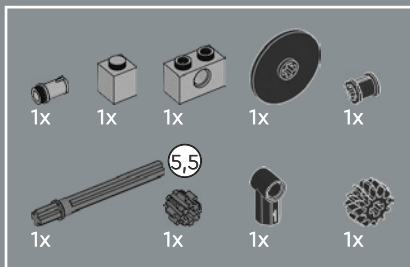

26

1

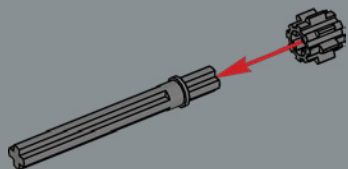

2

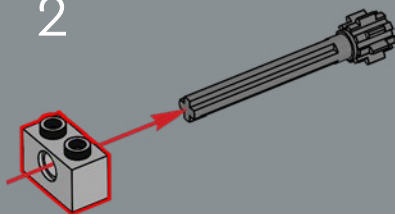

3

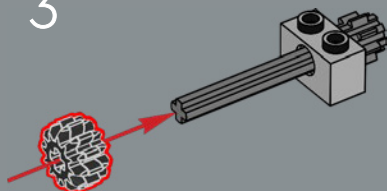

4

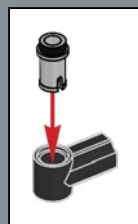
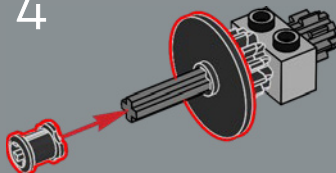

5

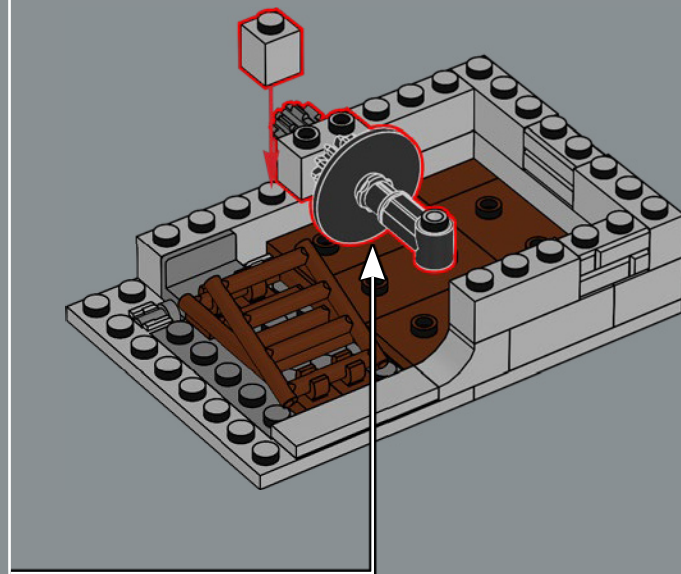
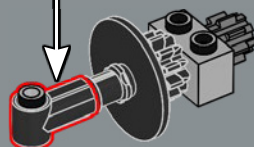

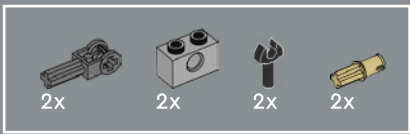

27

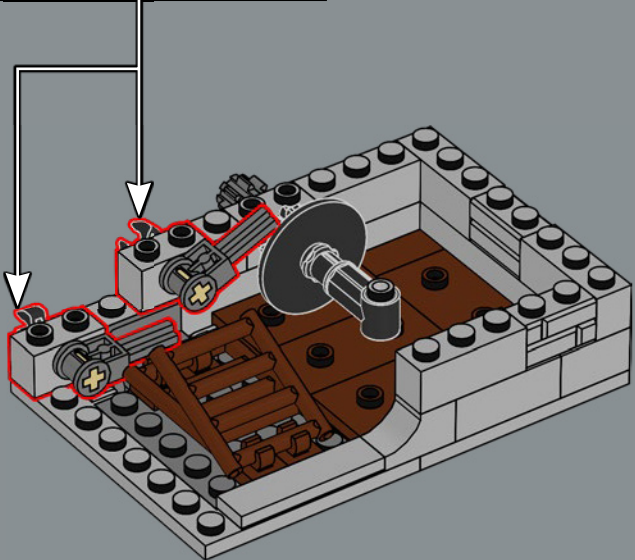
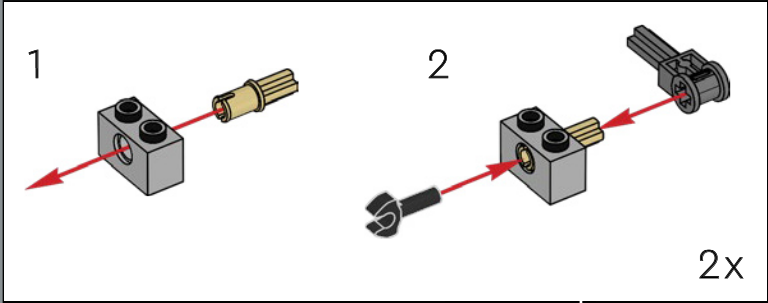

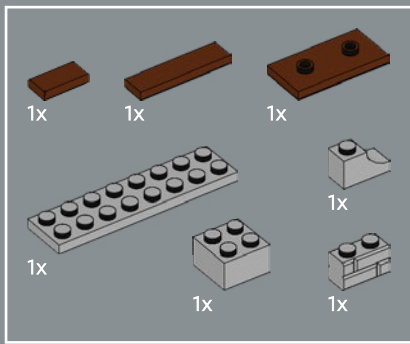

28

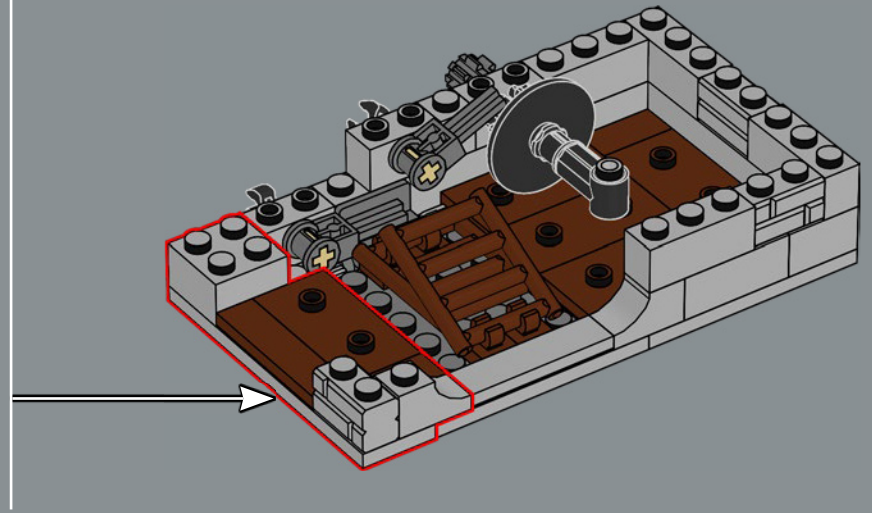
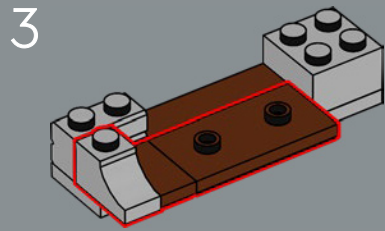
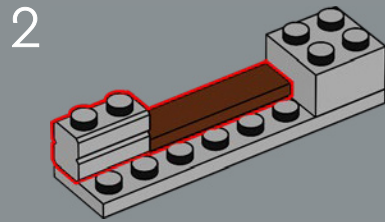
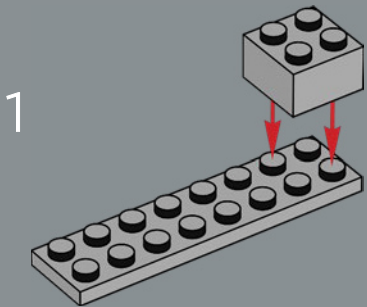

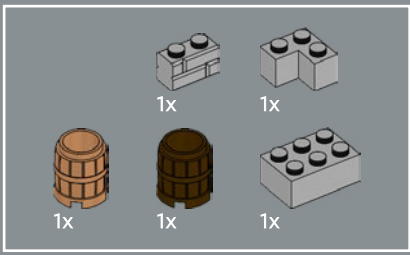

29

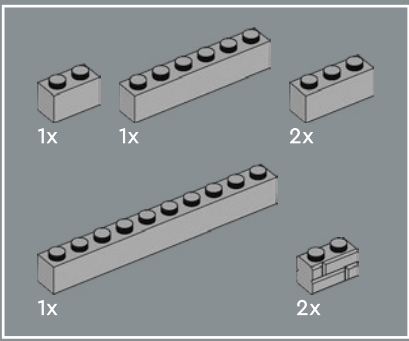
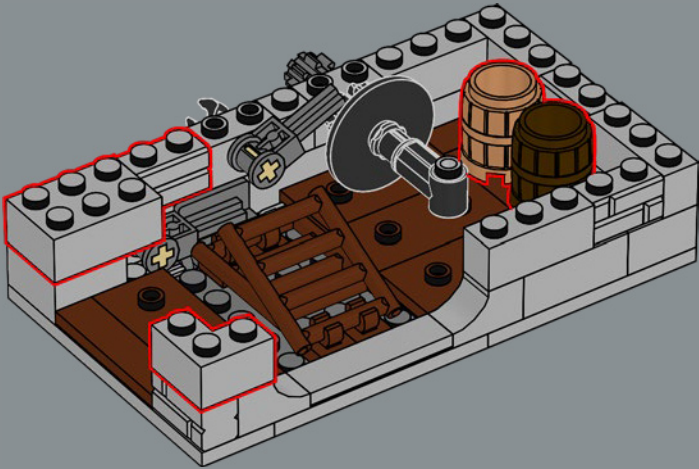

30

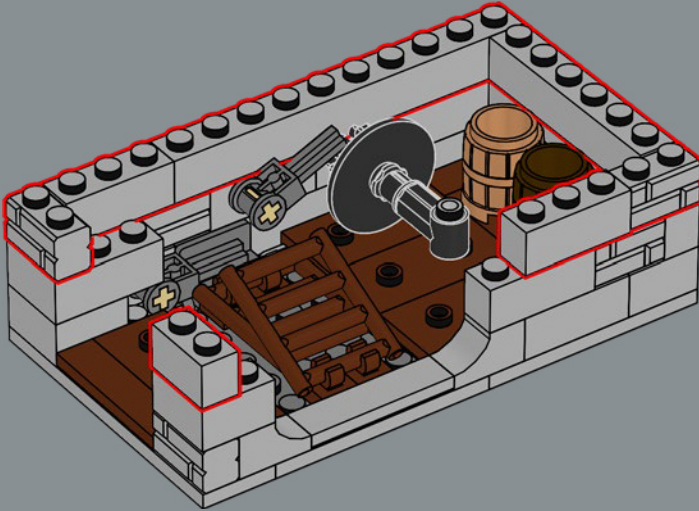

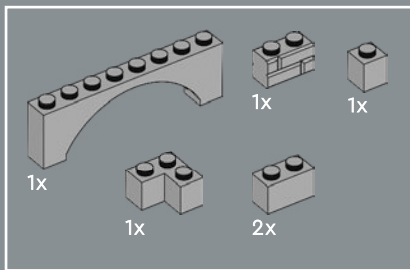

31

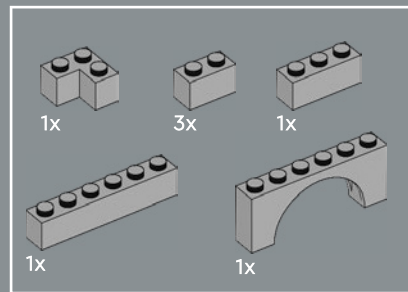
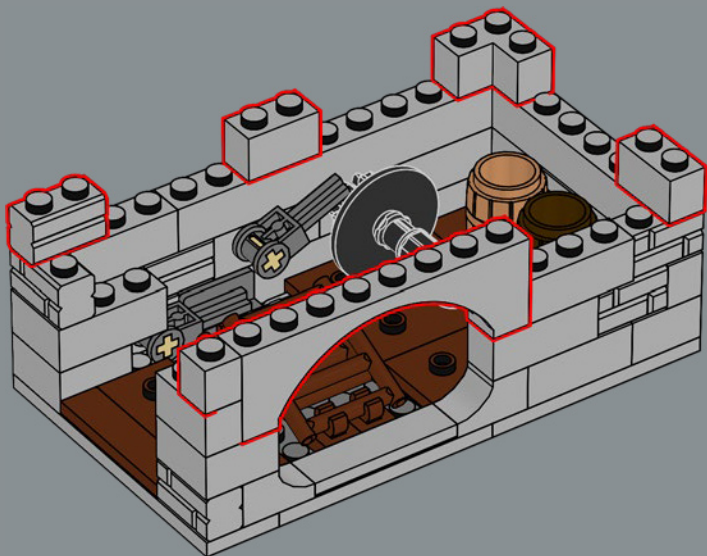

32

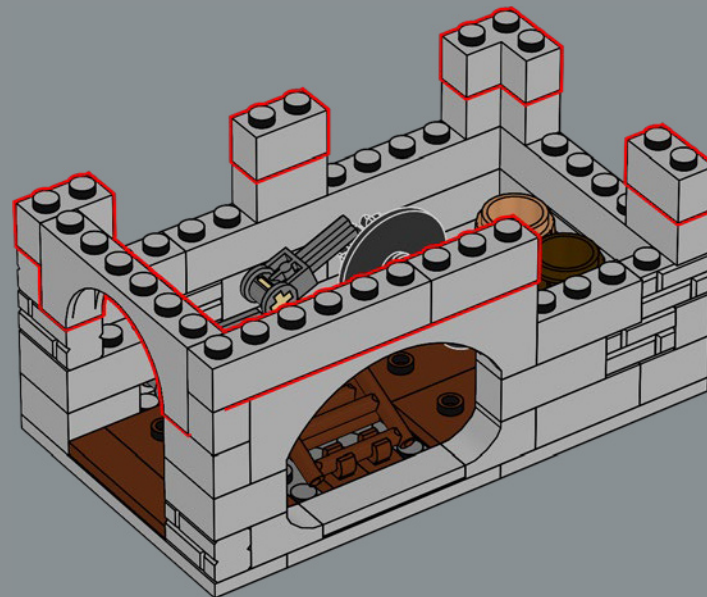

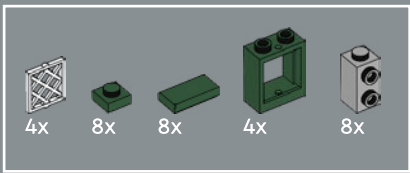

33

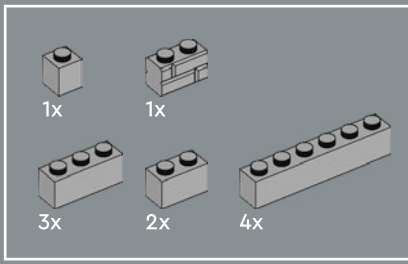
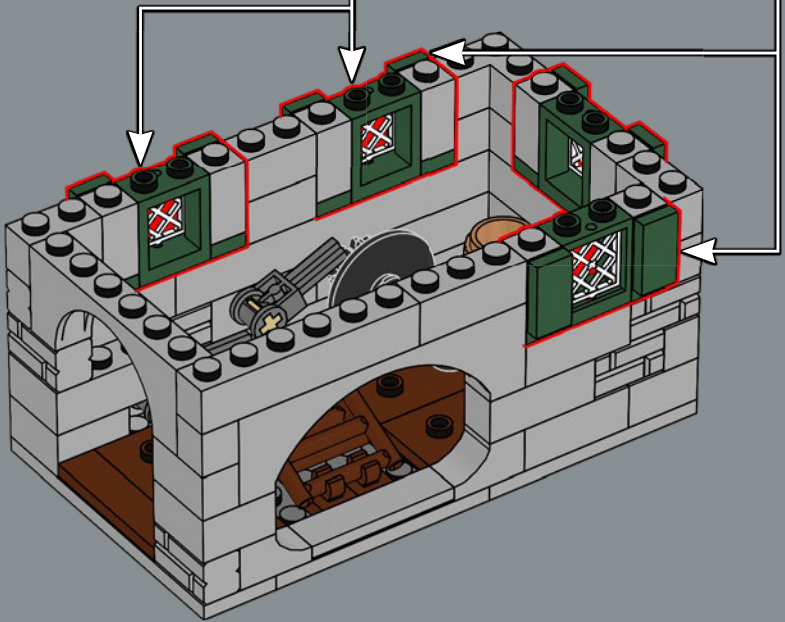
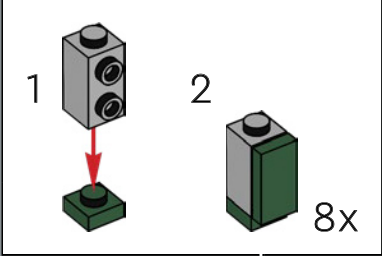
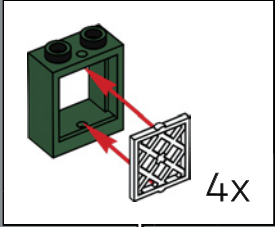

34

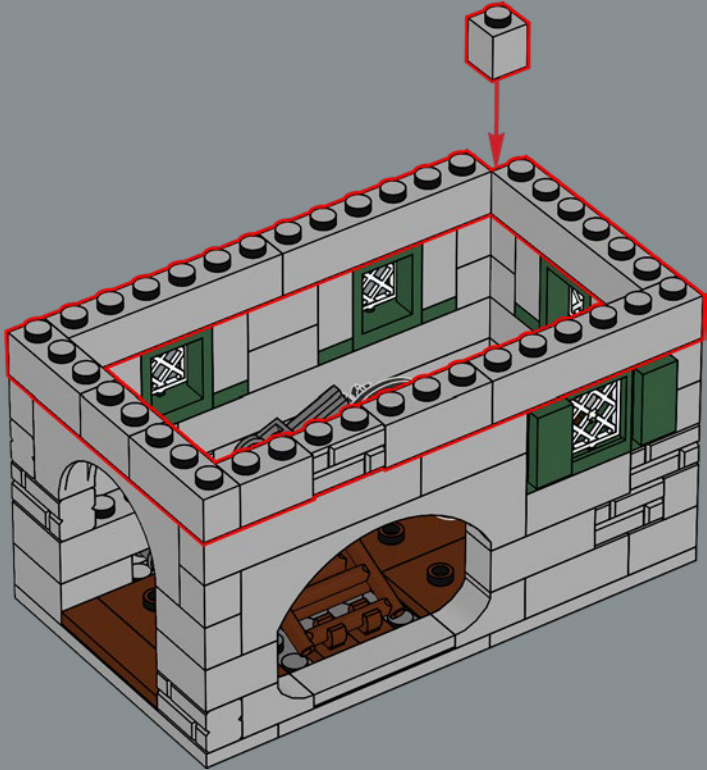



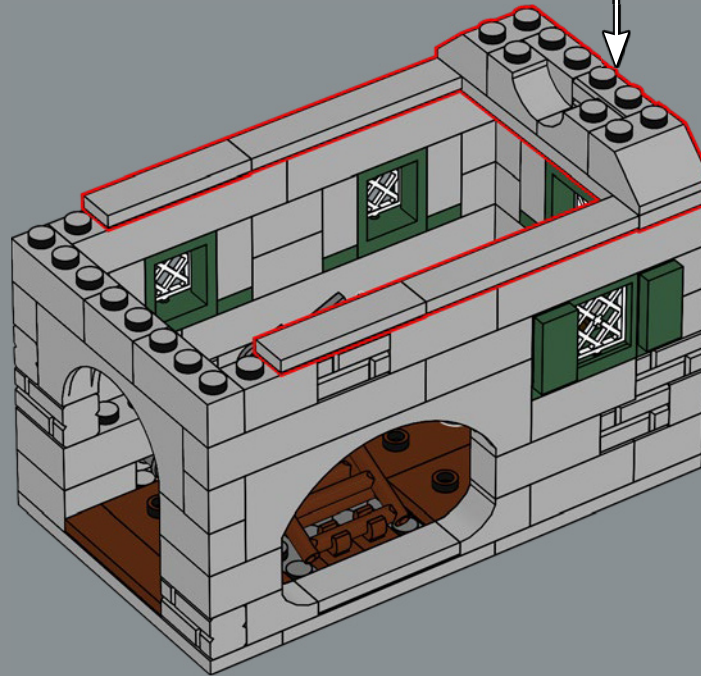
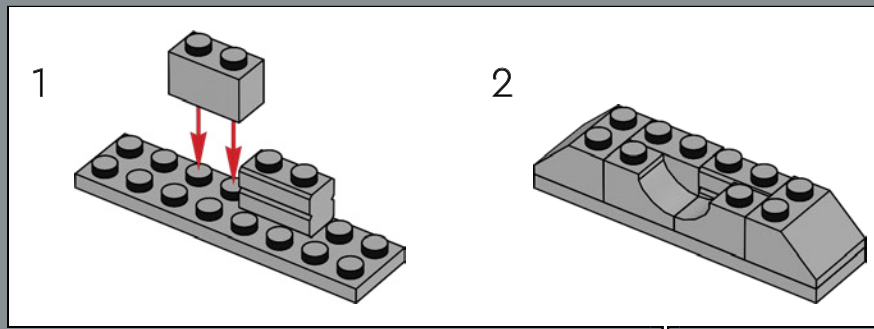
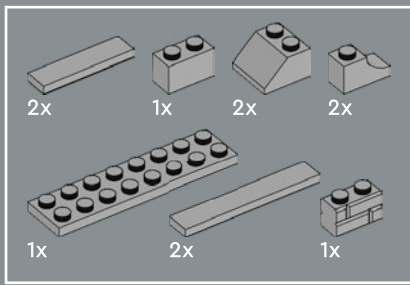

35

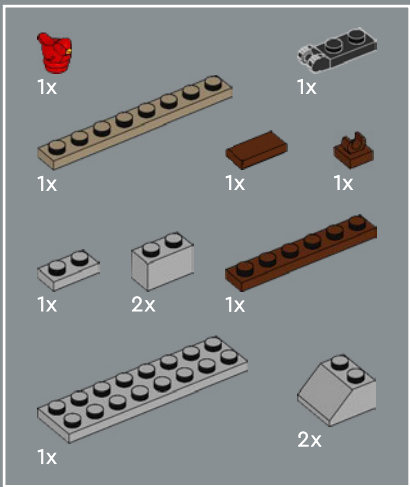

36

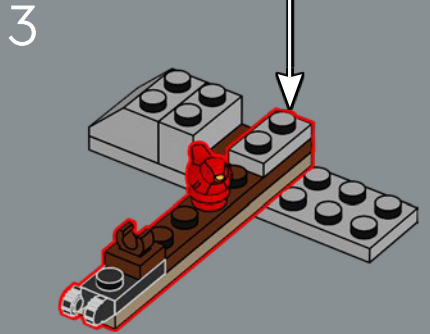
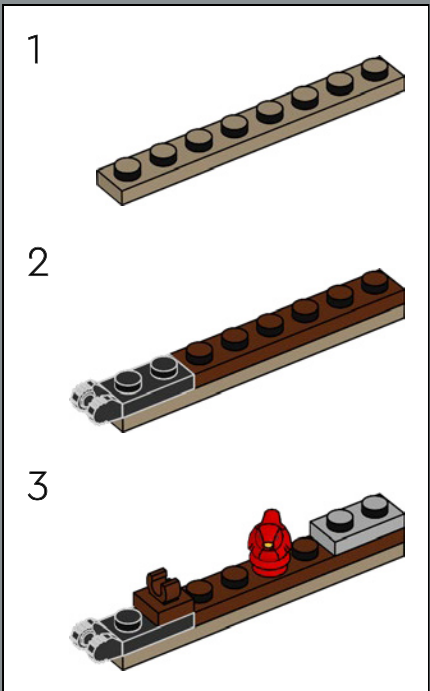
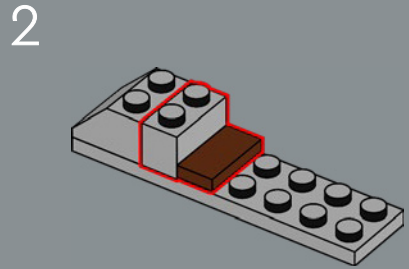
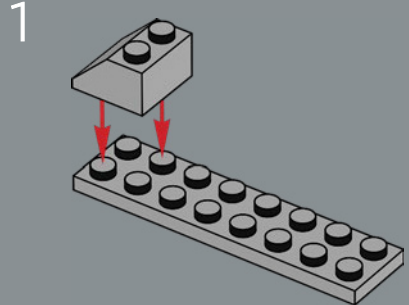

4

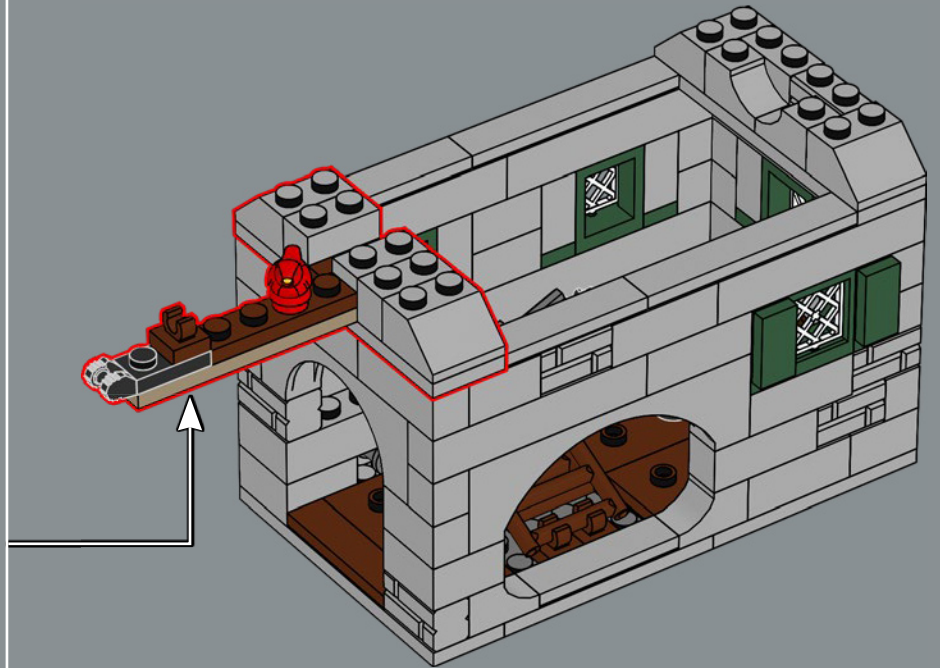
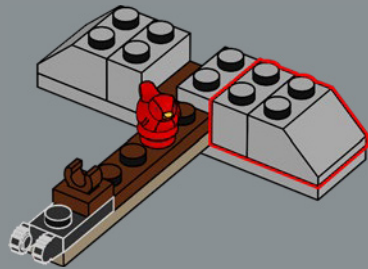



37

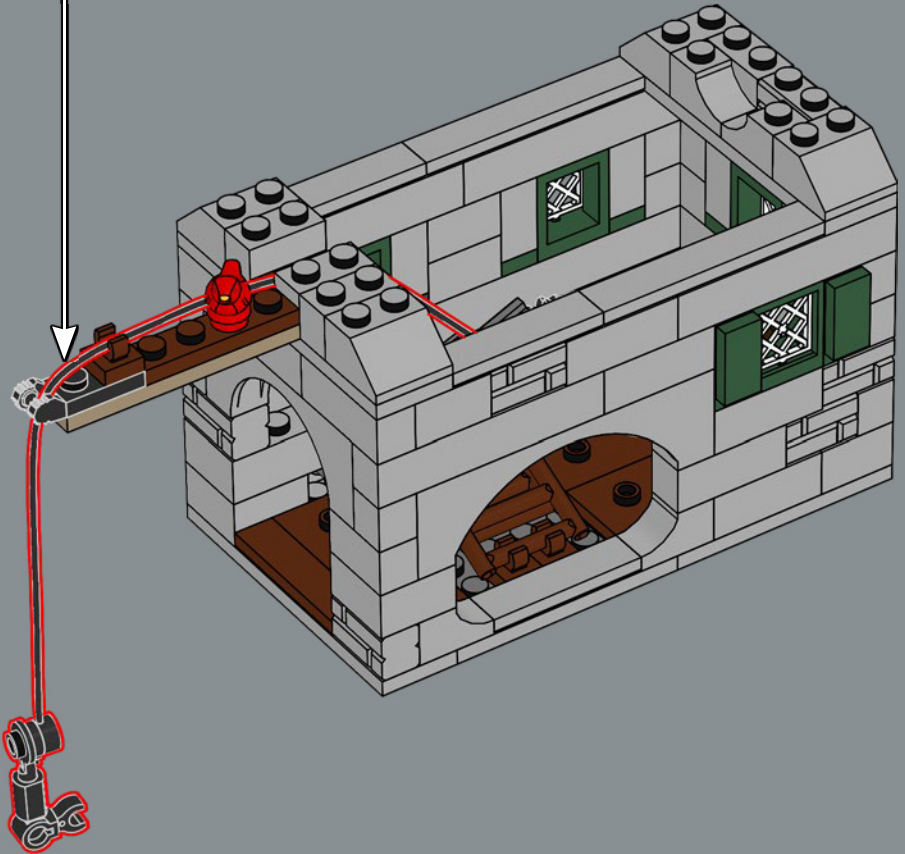
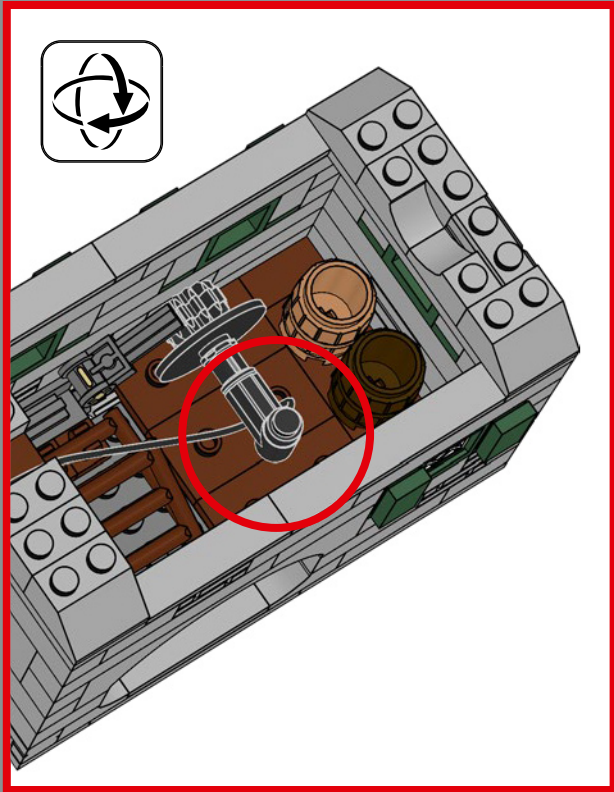
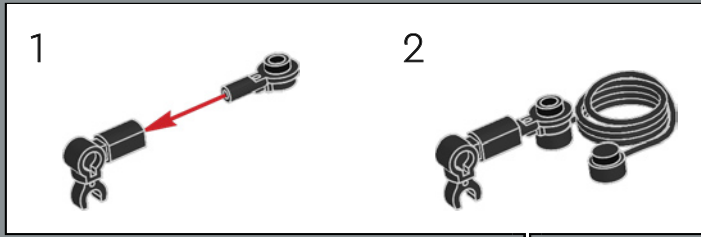

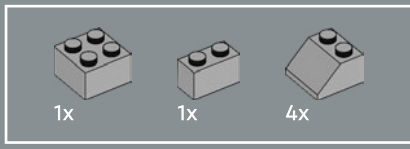

38

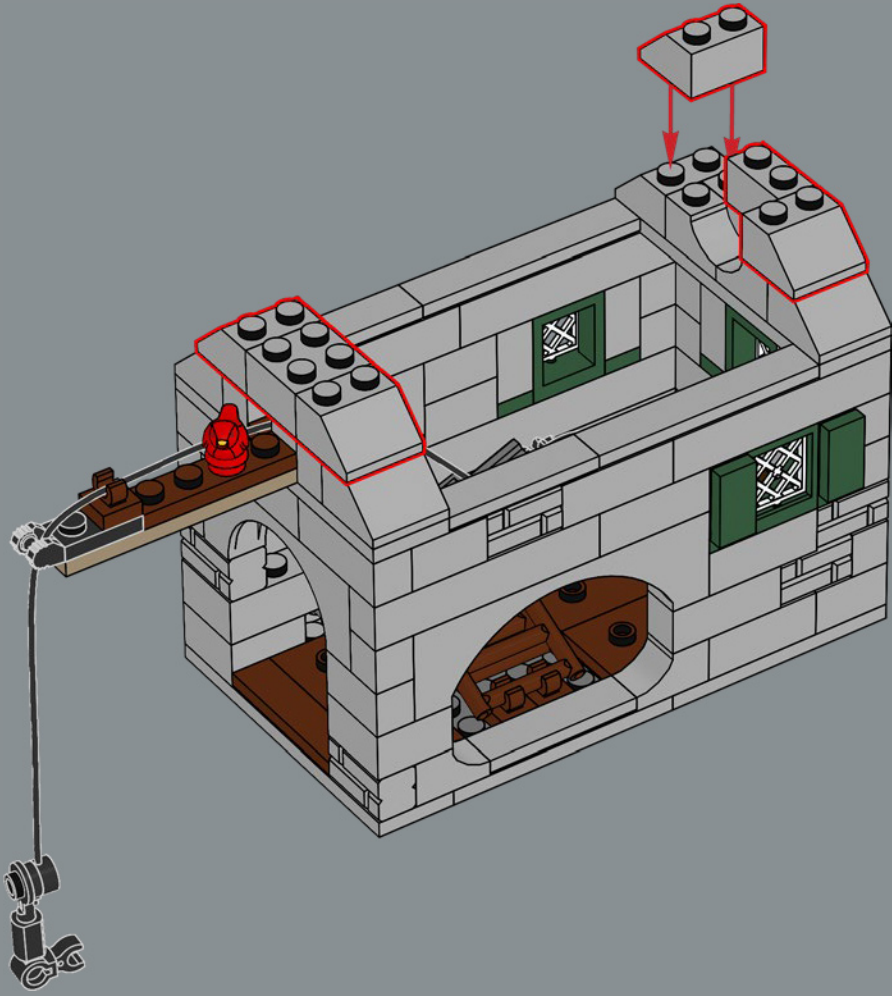

39

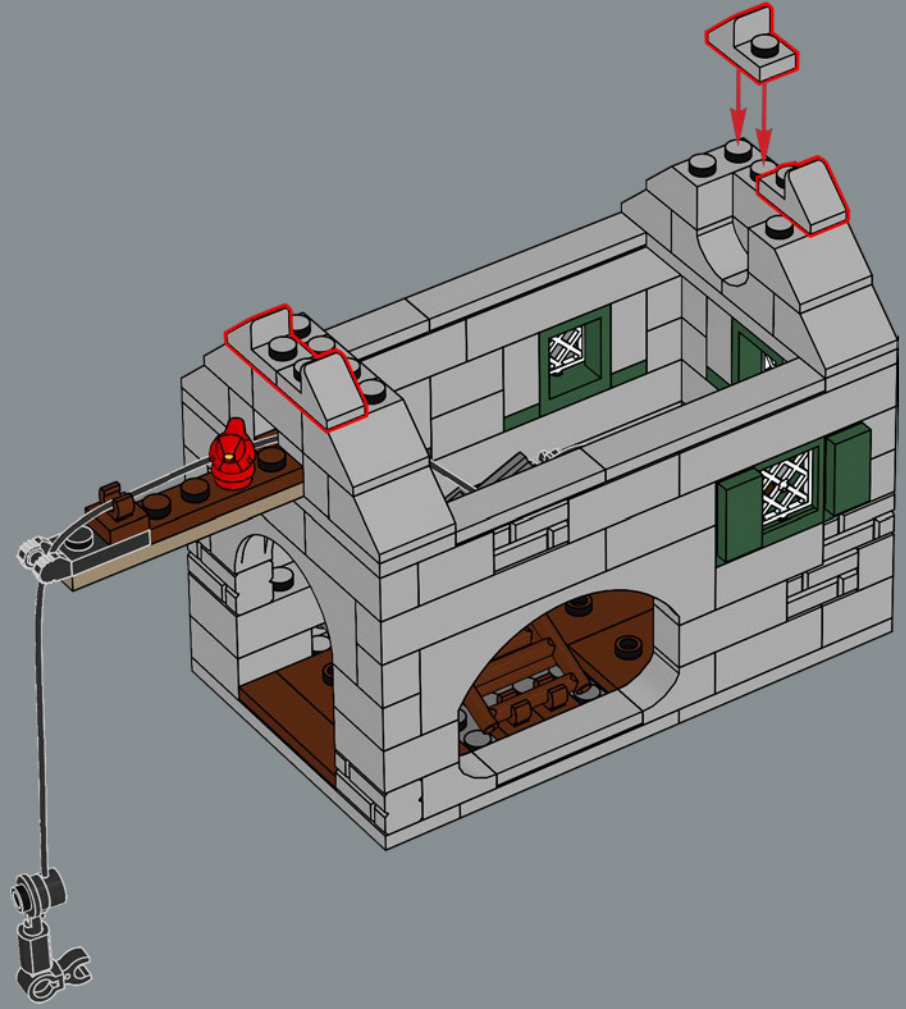



4x

40

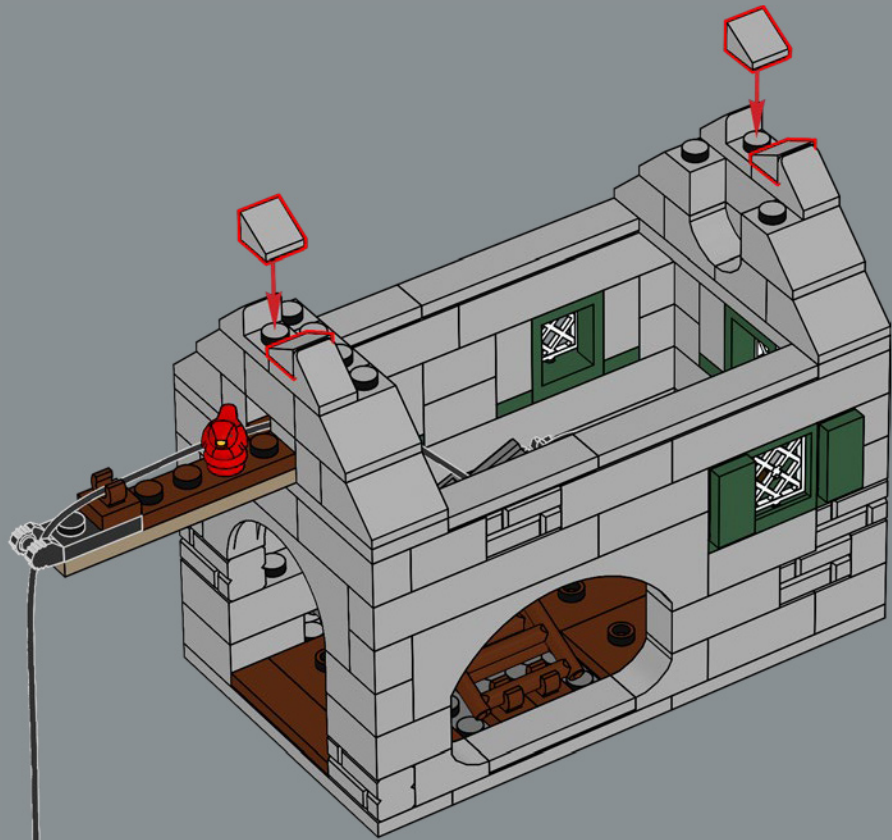

4x



4x



2x

41

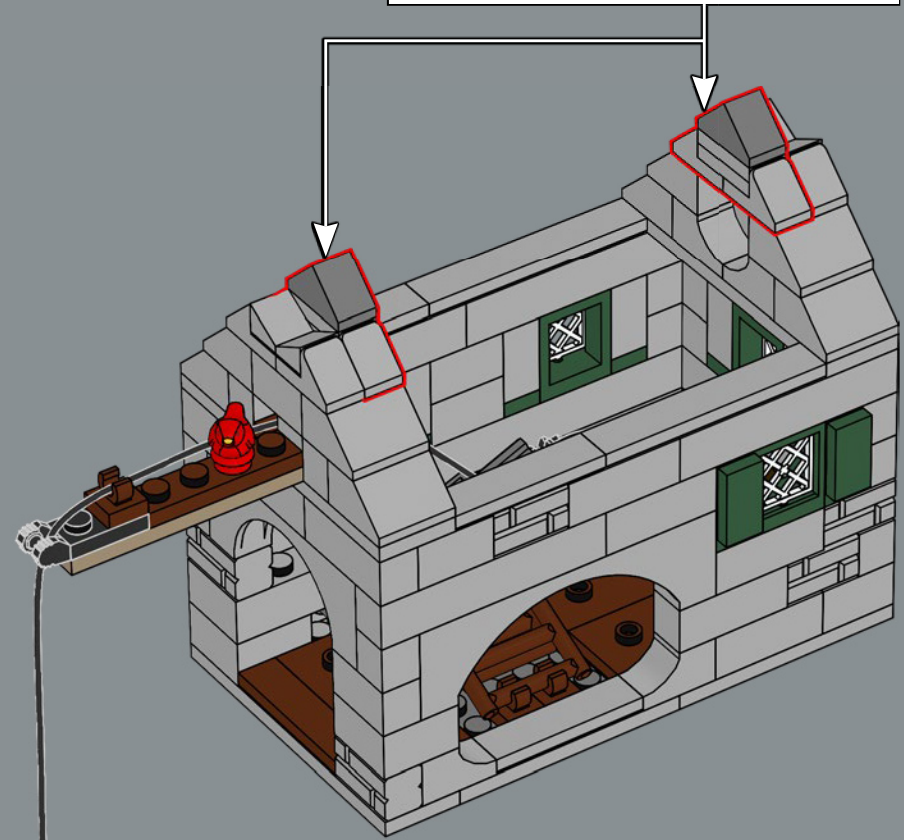
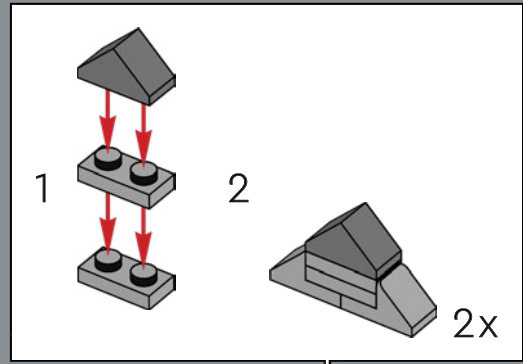



Use the crane in the Carpenter's workshop  
to hoist things into the attic.

Utilisez la grue de l'atelier de la menuisère  
pour hisser des objets dans la mansarde.

Utiliza la grúa del taller de la carpintera  
para subir cosas al ático.

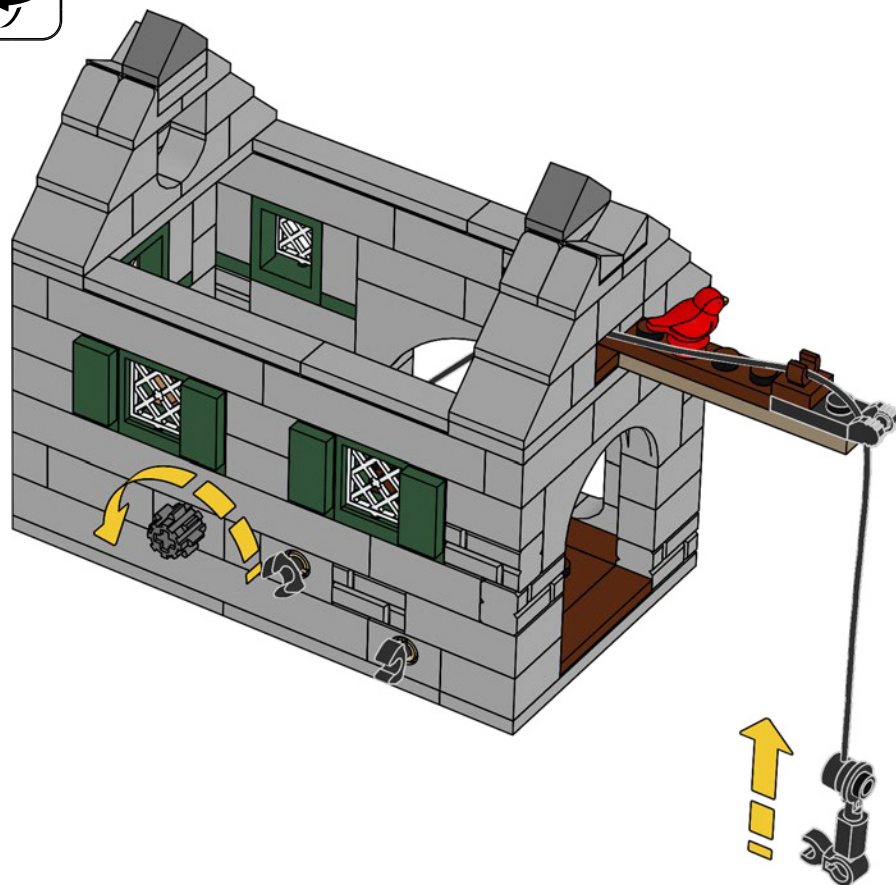

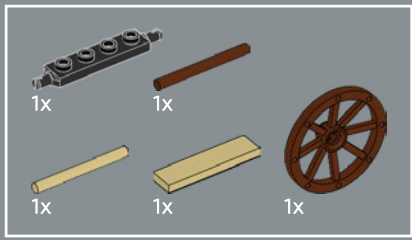

42

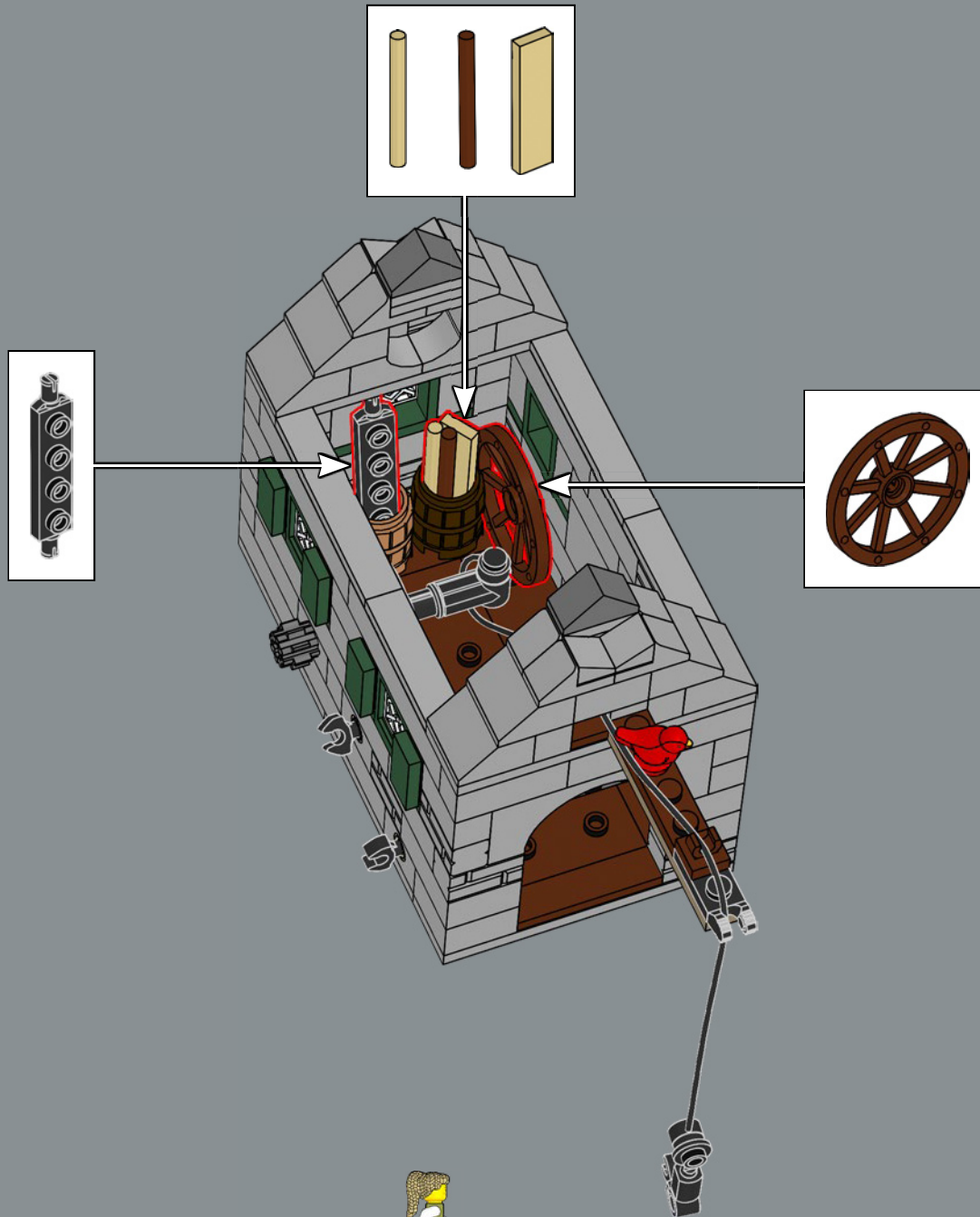



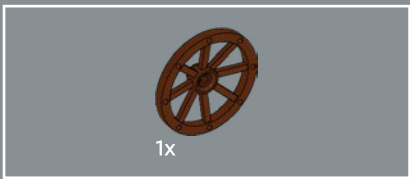

43

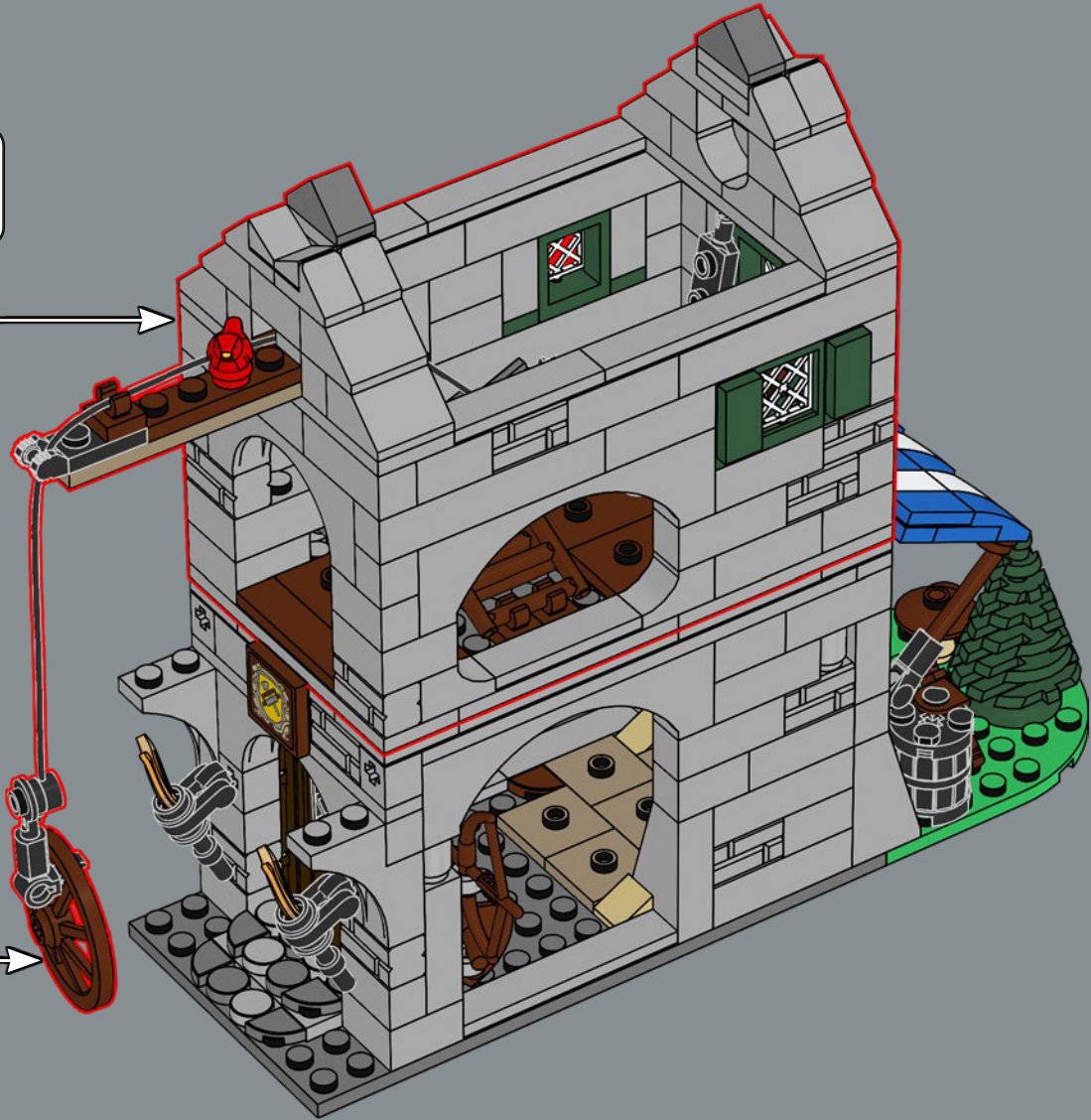

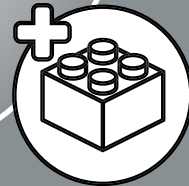
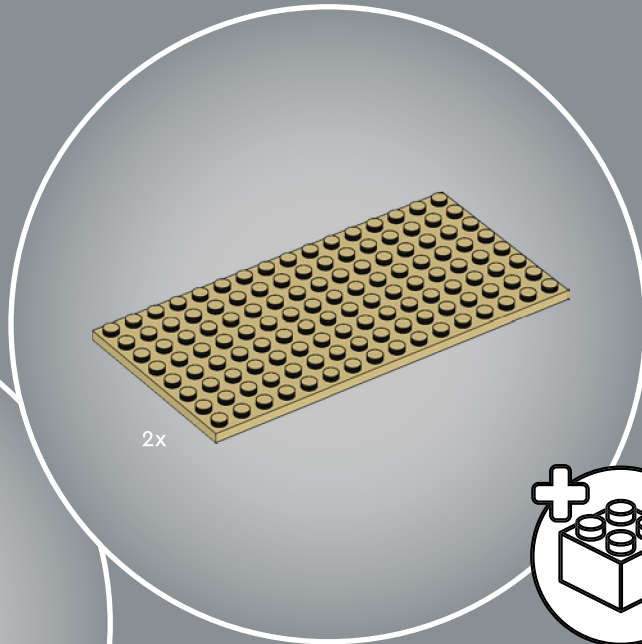

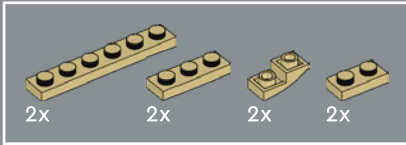
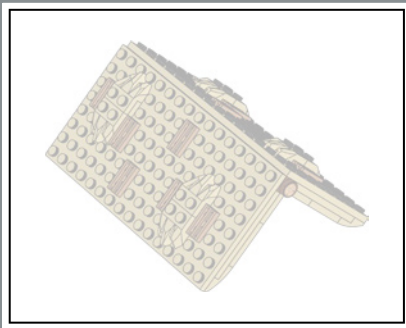

44

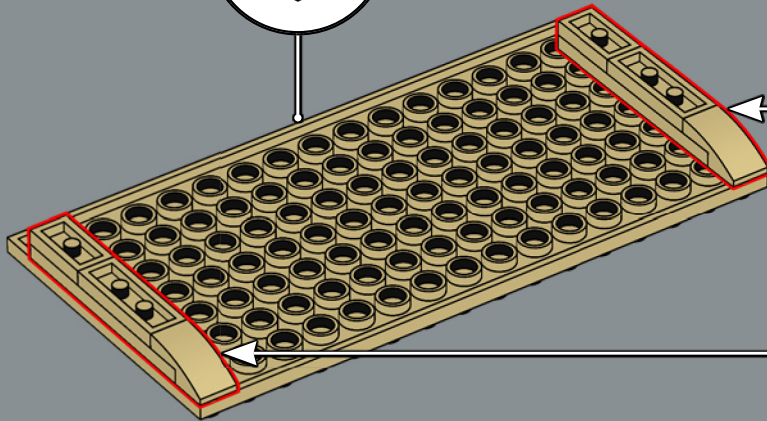
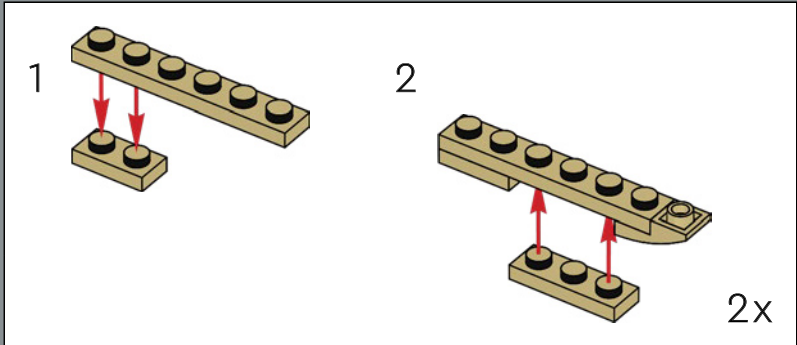
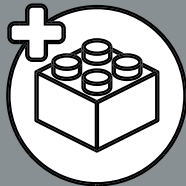



45

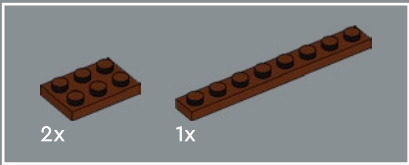
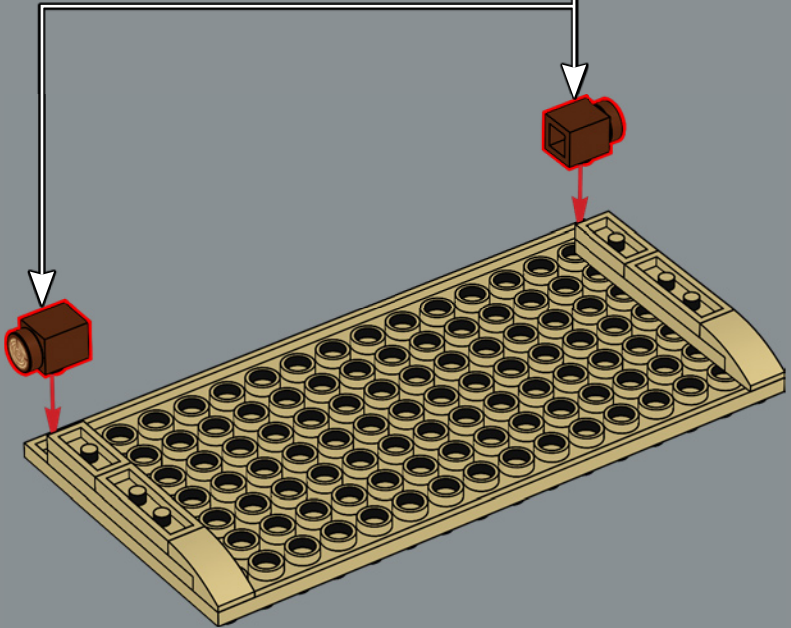
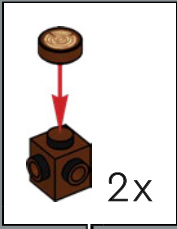

46

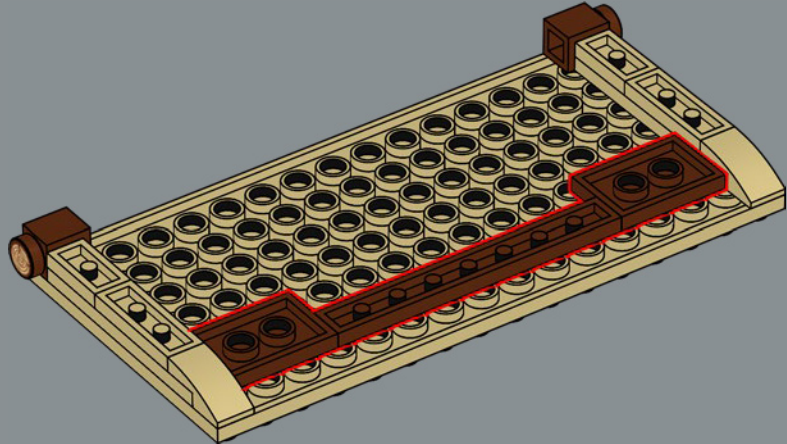

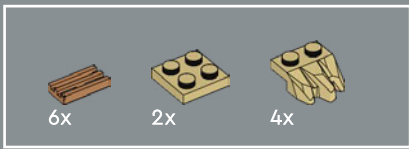

47

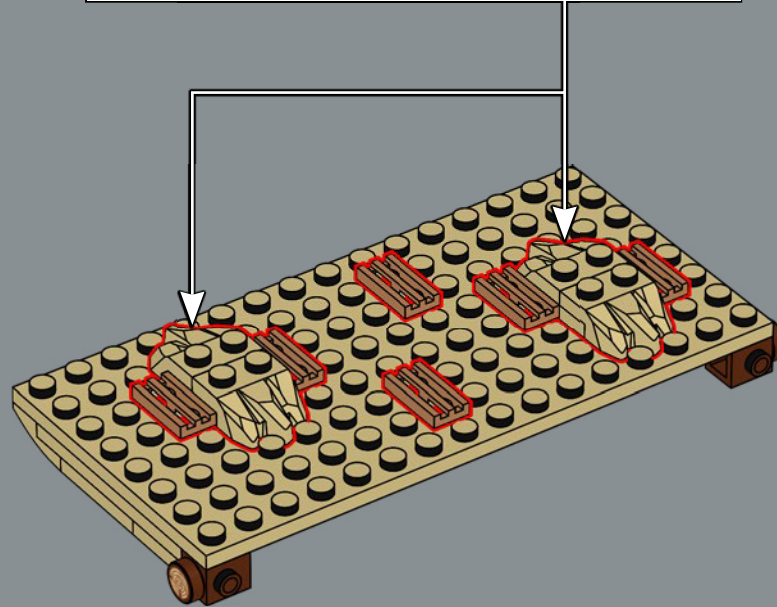
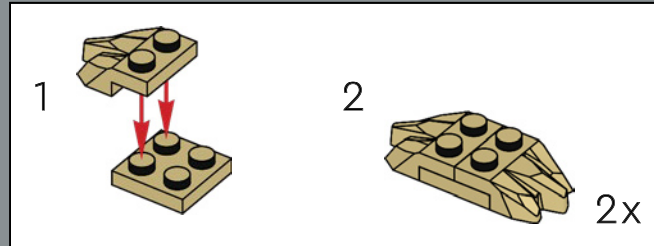

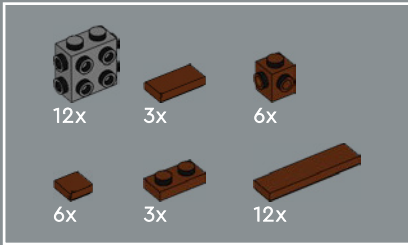
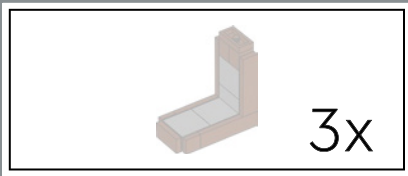

48

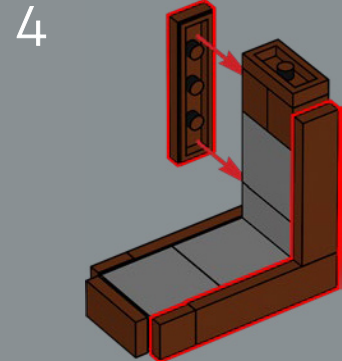
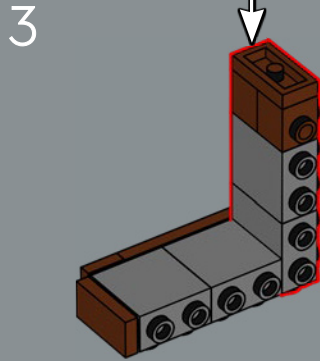
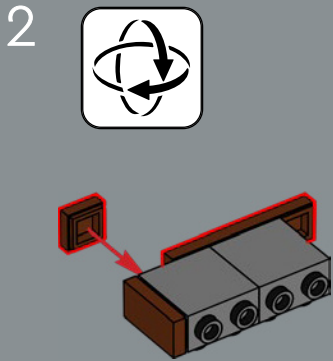
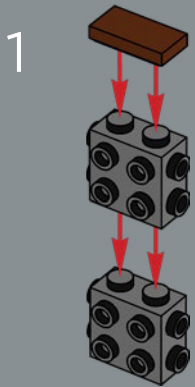
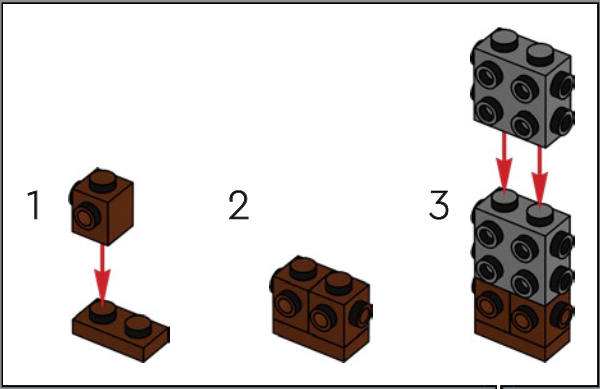

3x



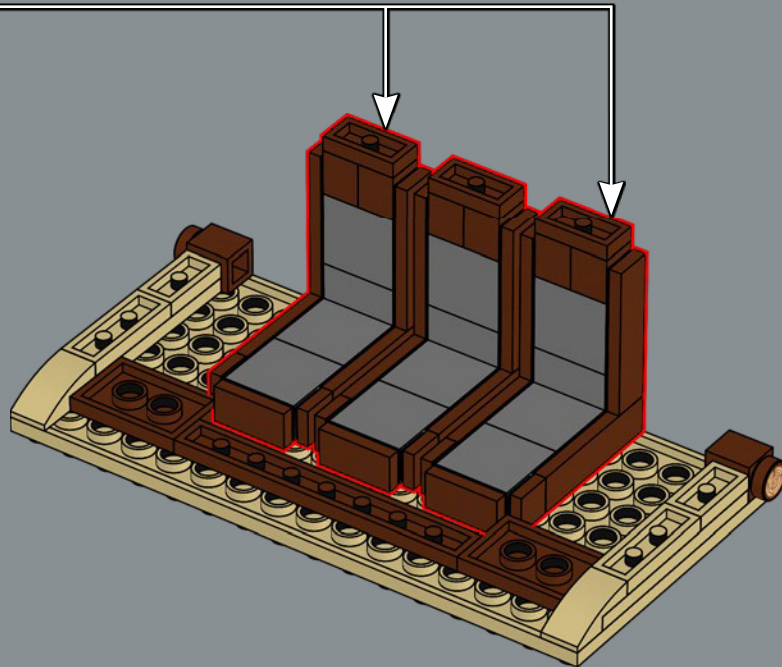
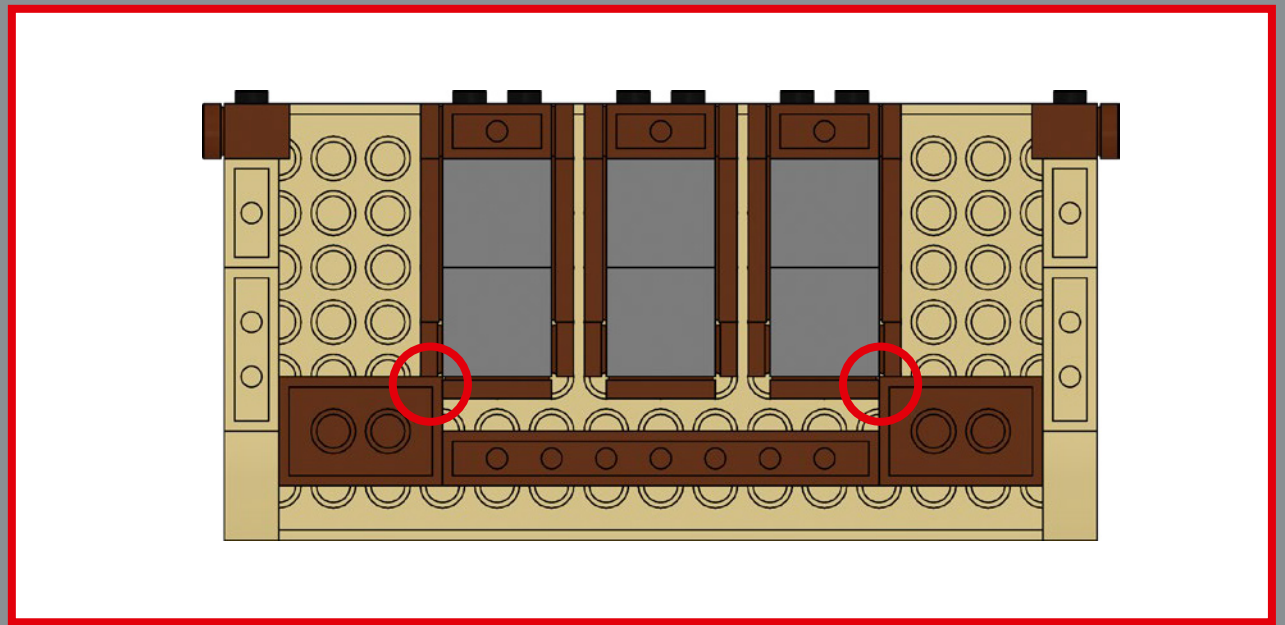

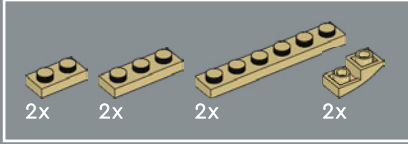
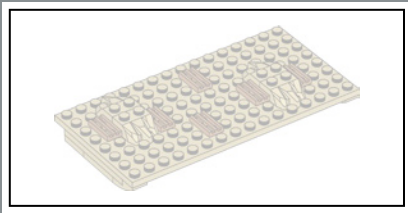

49

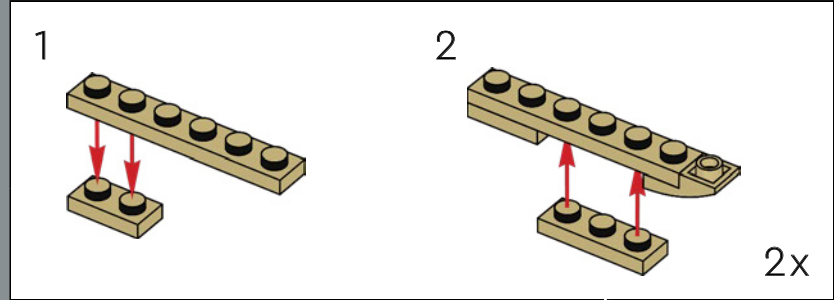
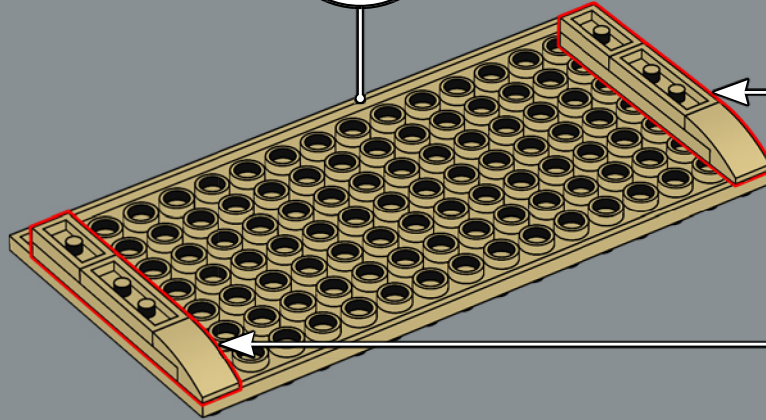
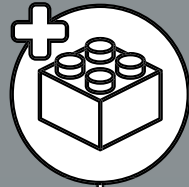



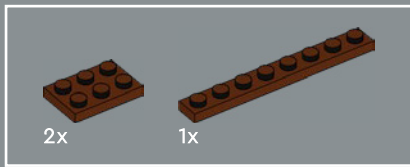

50

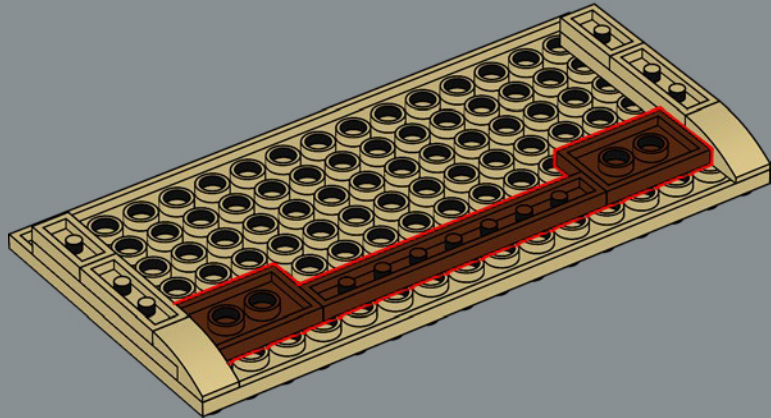

51

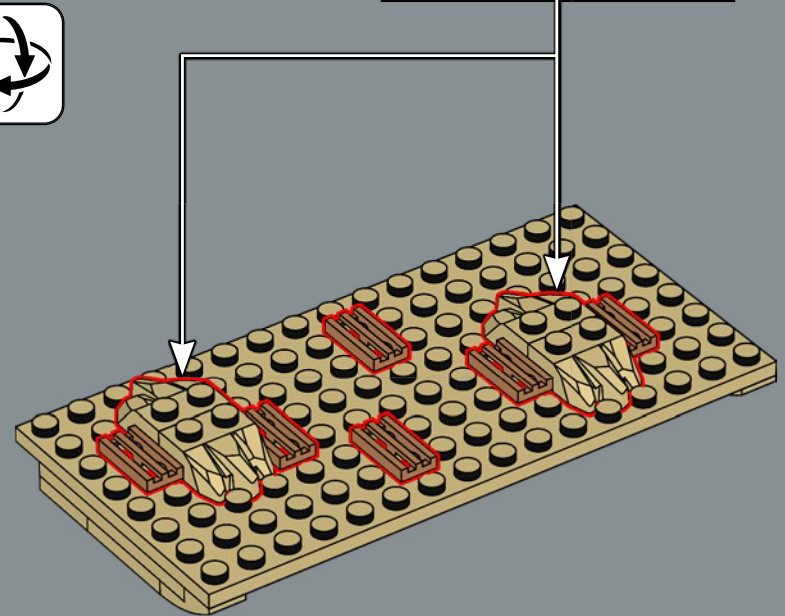
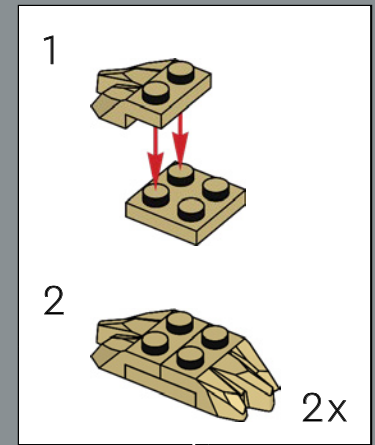

52

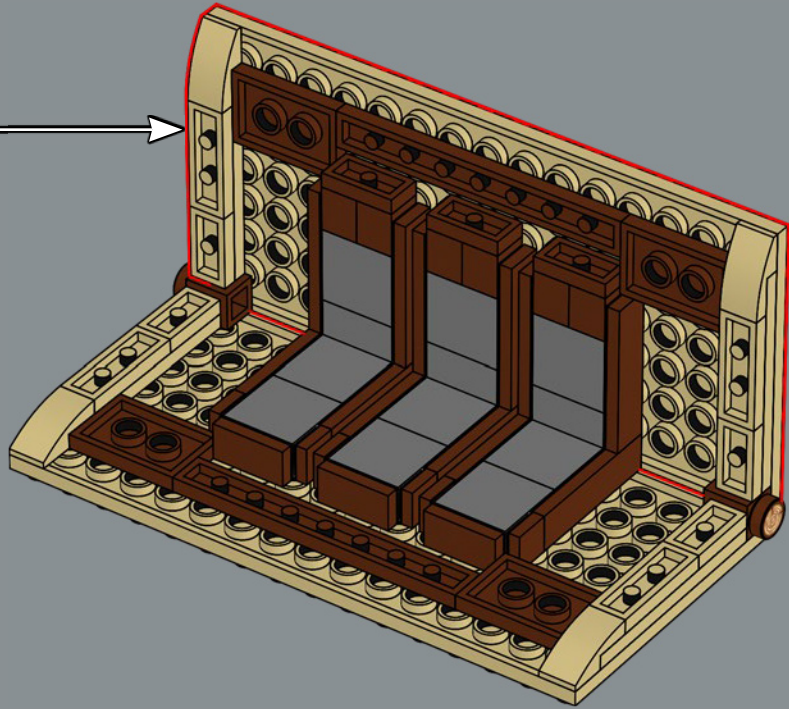

53

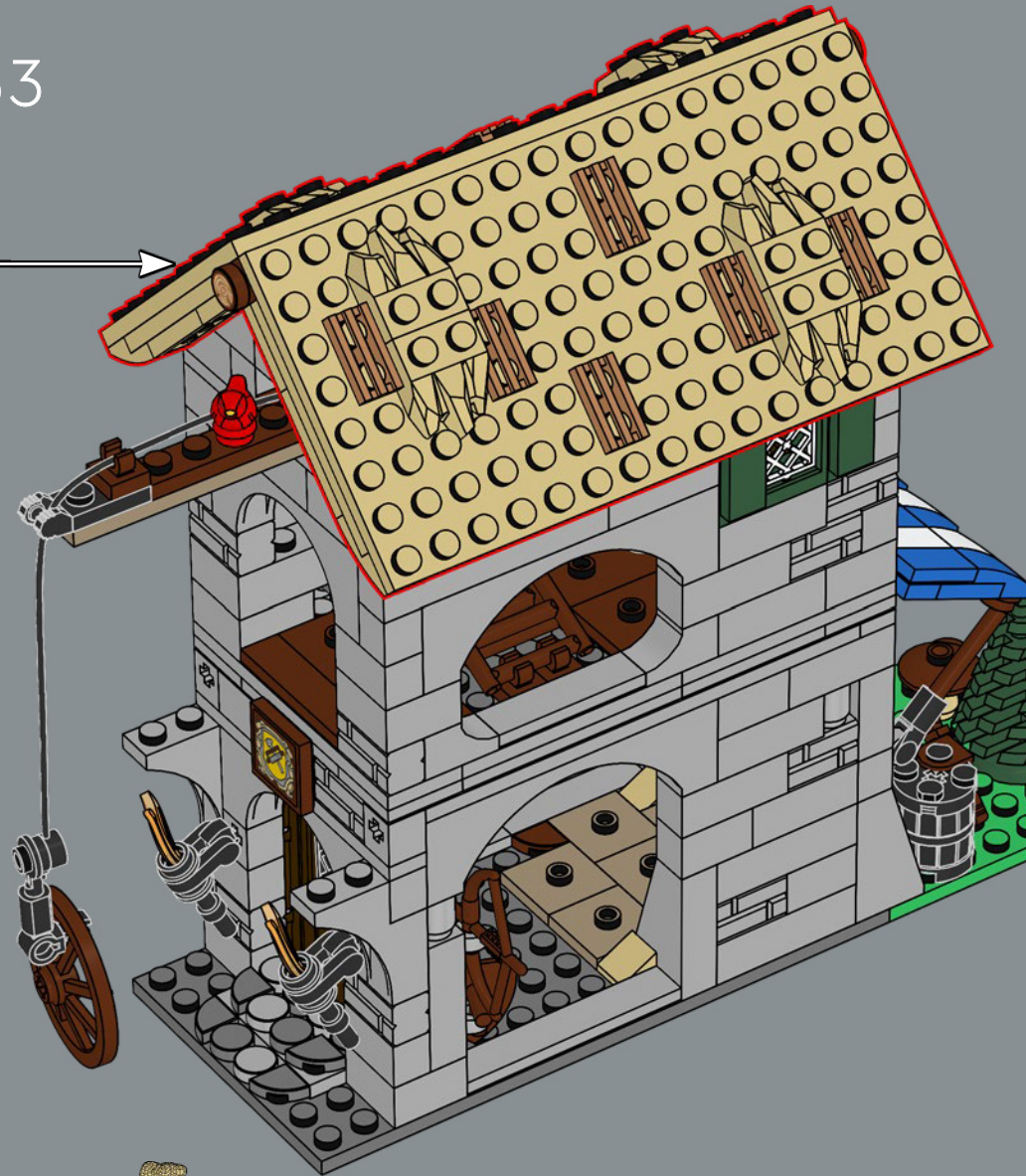

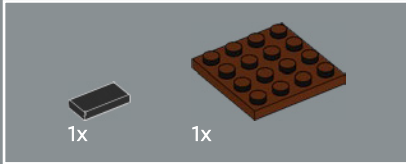
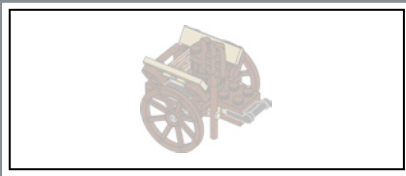

54

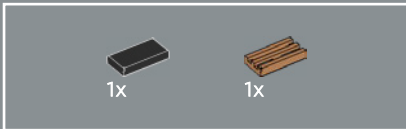
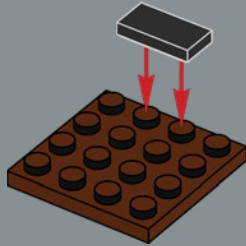

55

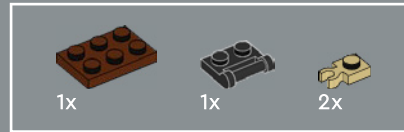
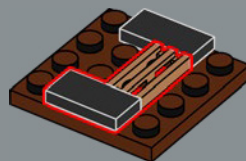

56

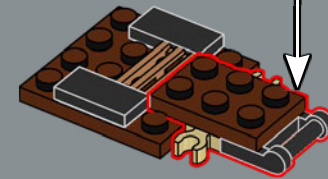
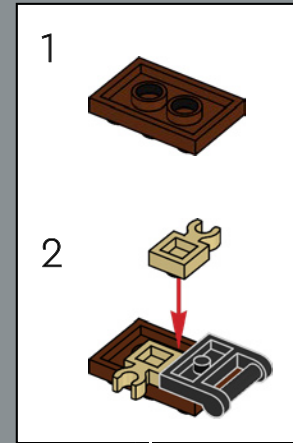

57

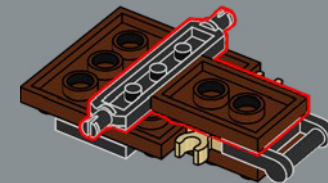



1x

58

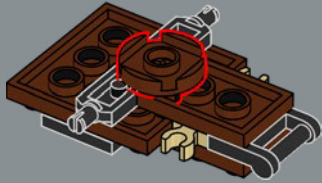

1x



4x

59

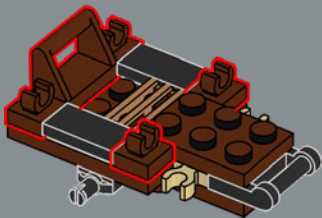

1x



1x

60

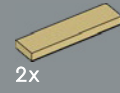
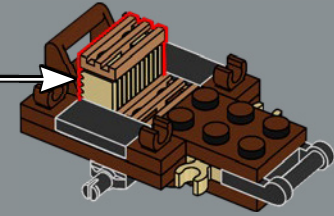
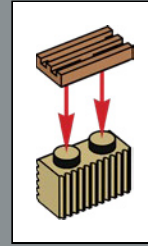

2x



4x

61

1

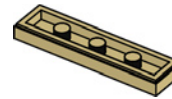

2



2x

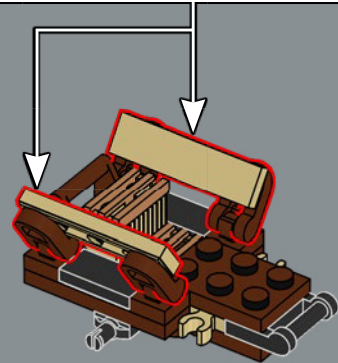



62

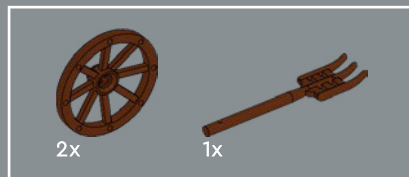
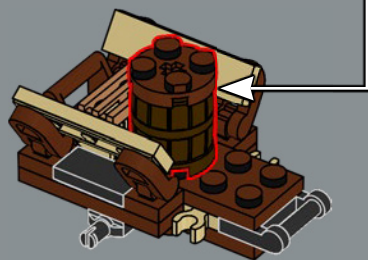
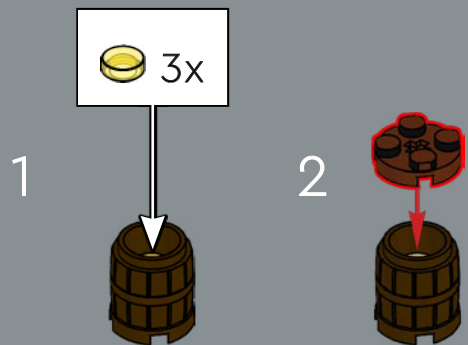

63

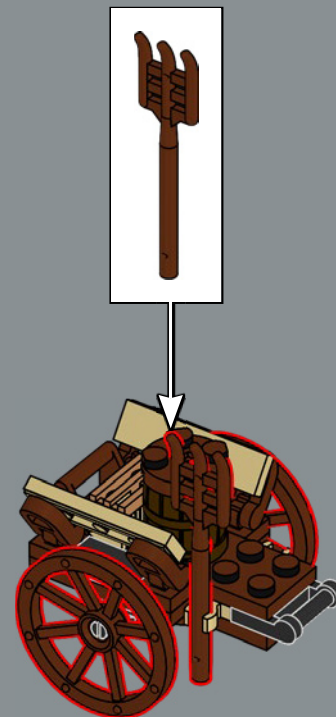

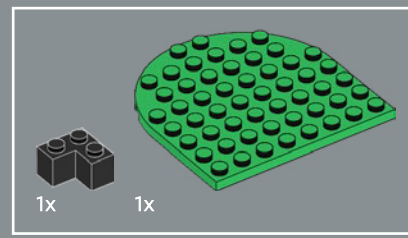

64

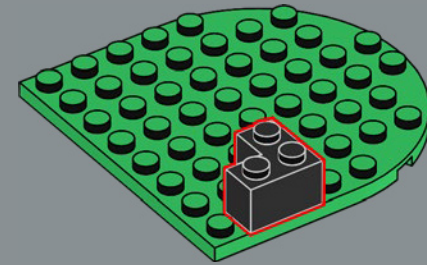

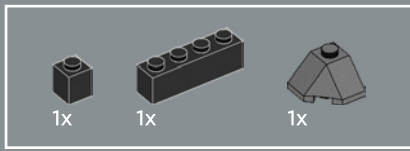

65

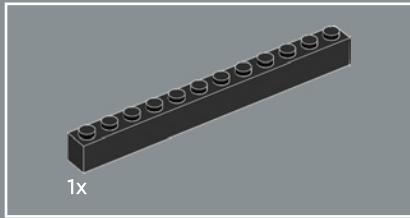
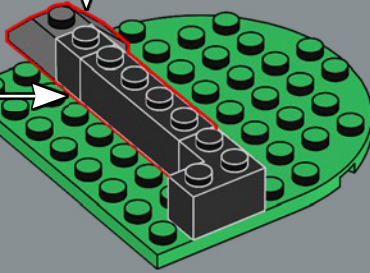
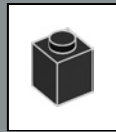

66

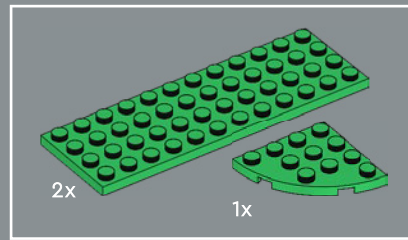
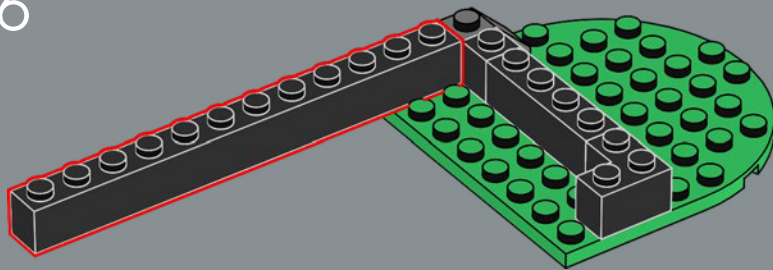

67

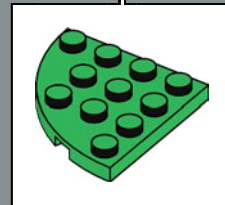
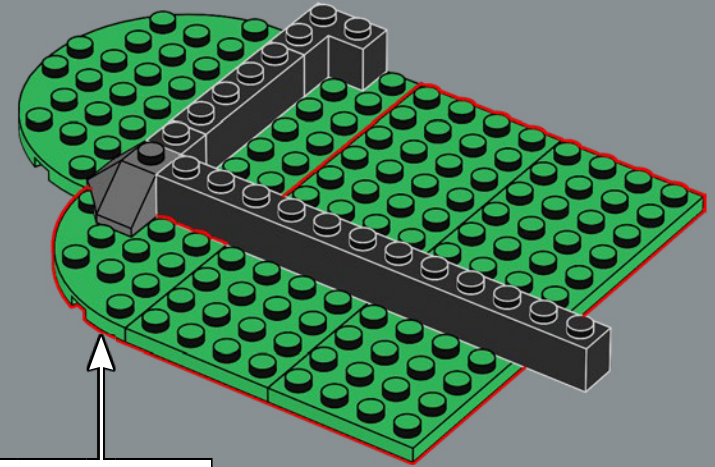



6x

68

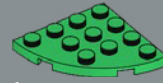
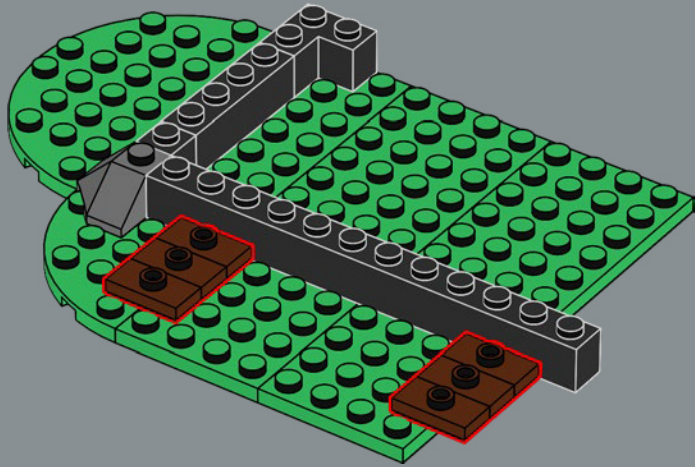

1x

69

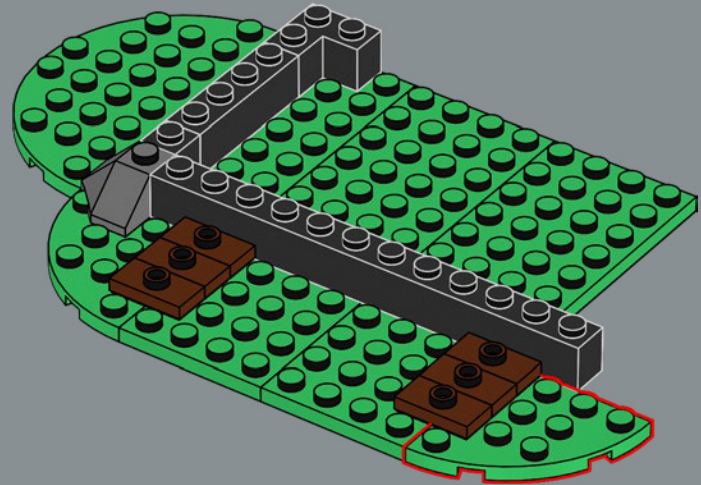



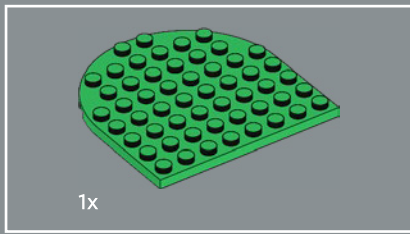

70

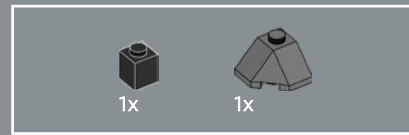
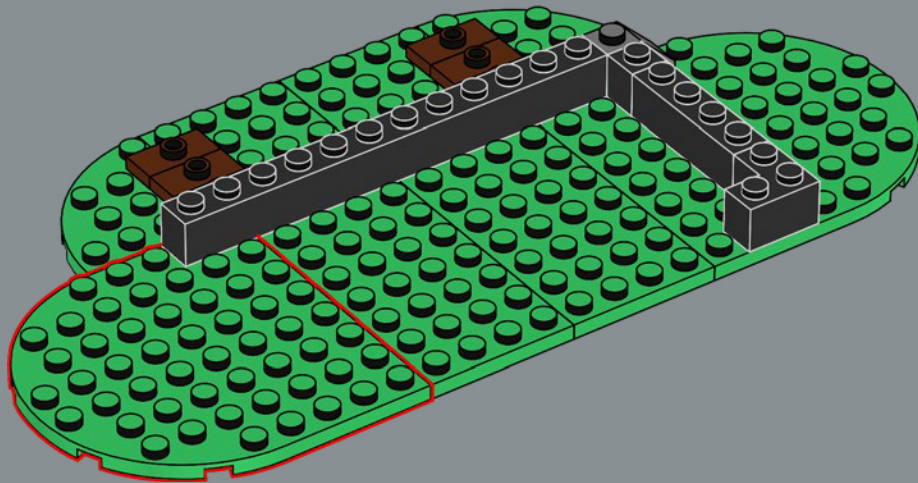

71

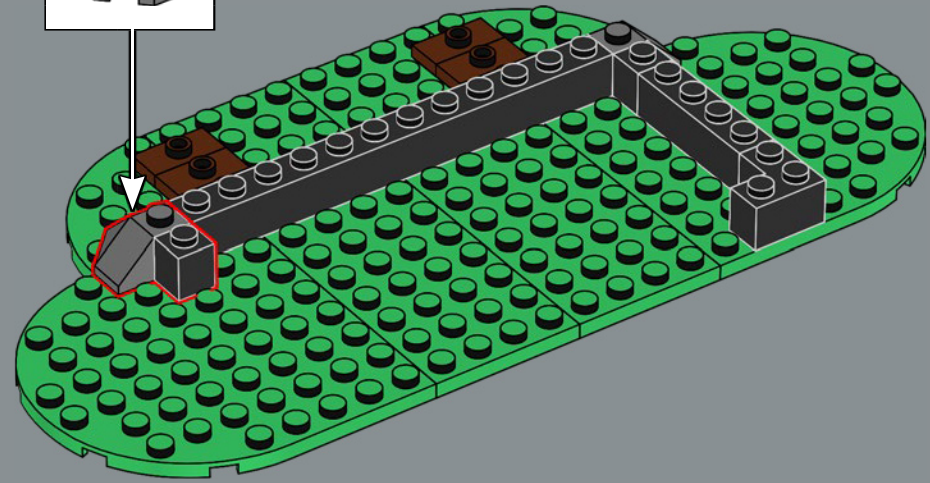

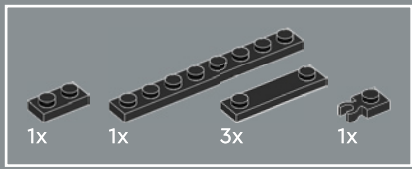

72

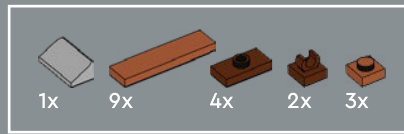
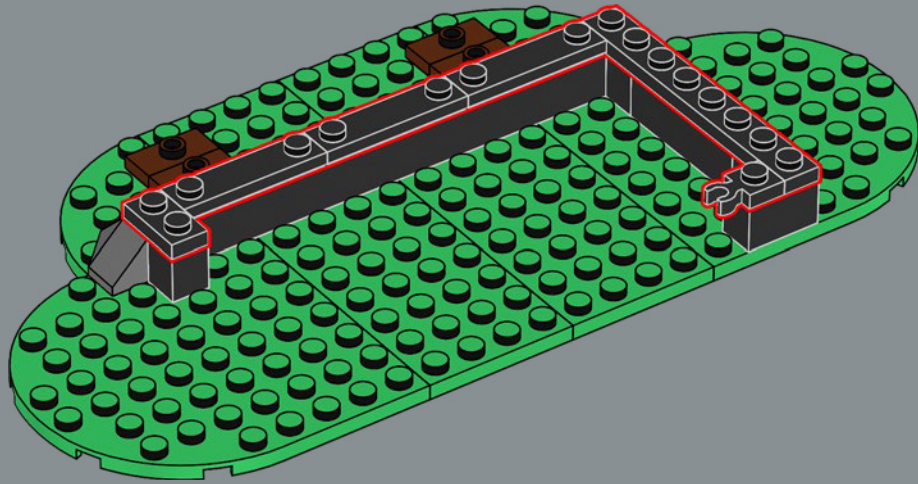

73

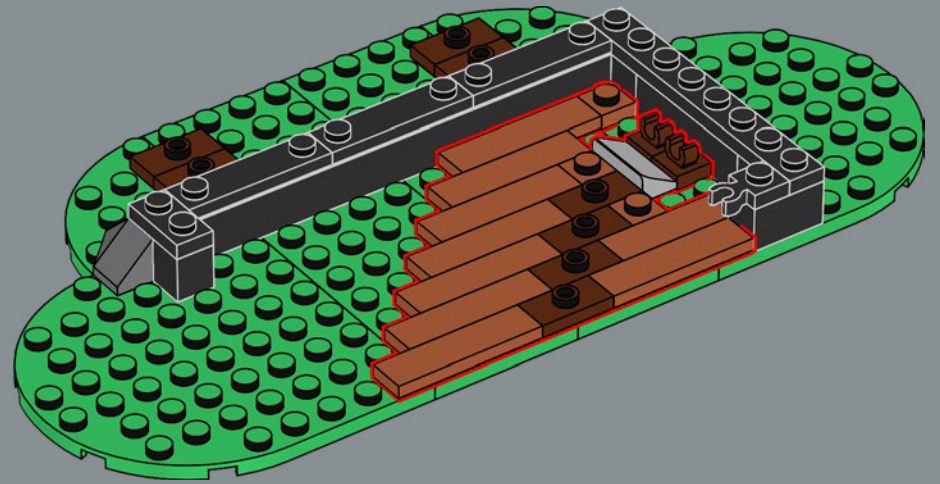

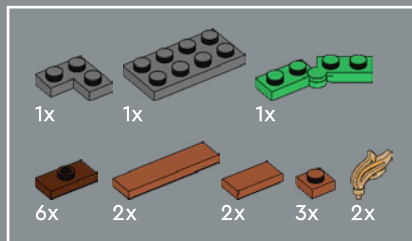

74

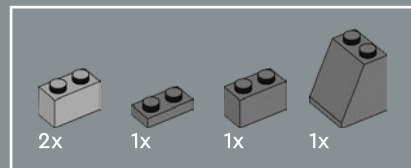
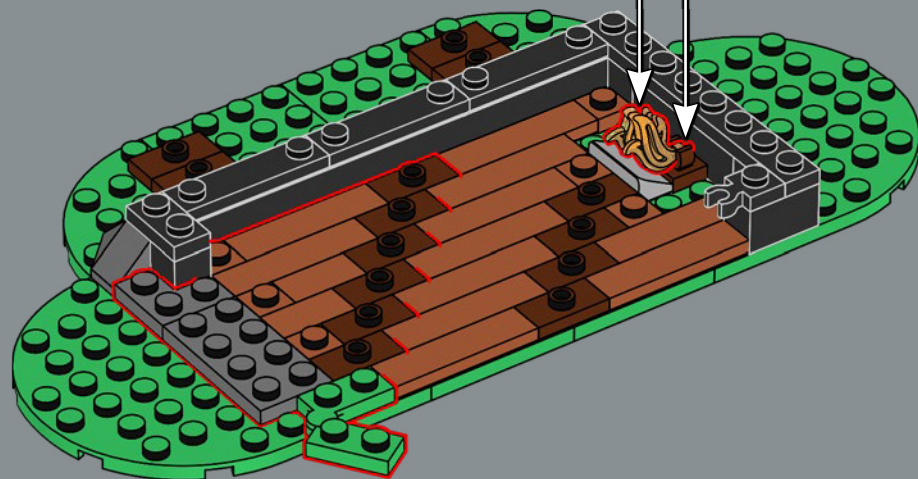
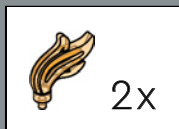

75

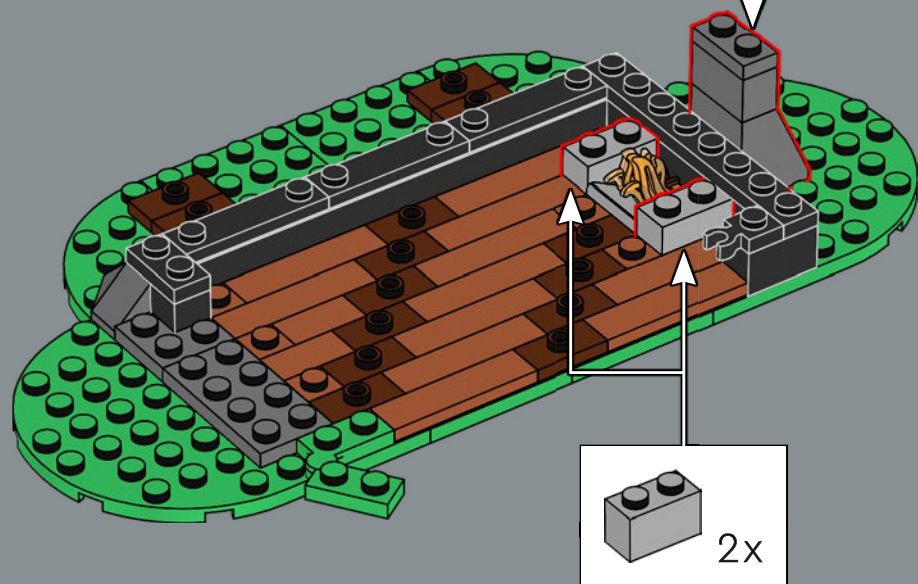
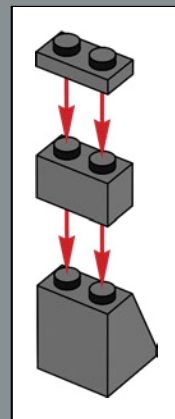

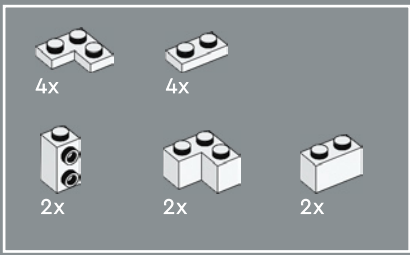

76

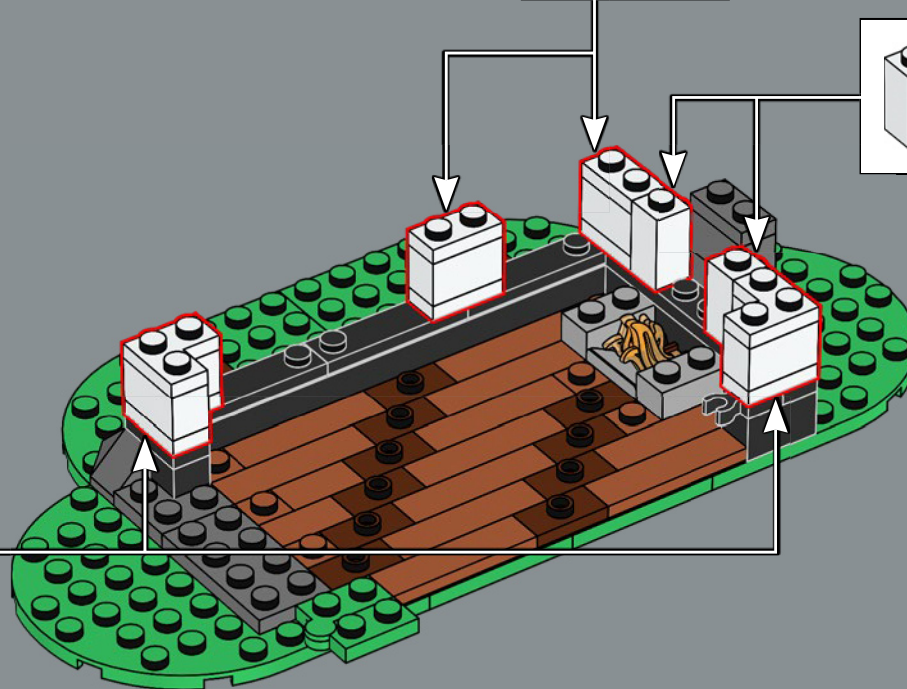
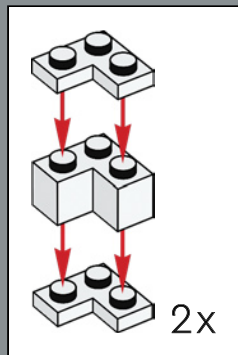
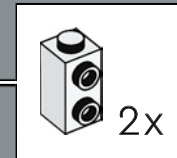
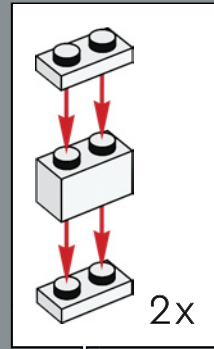

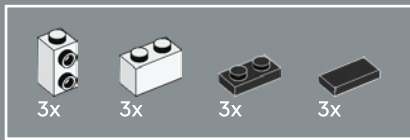

77

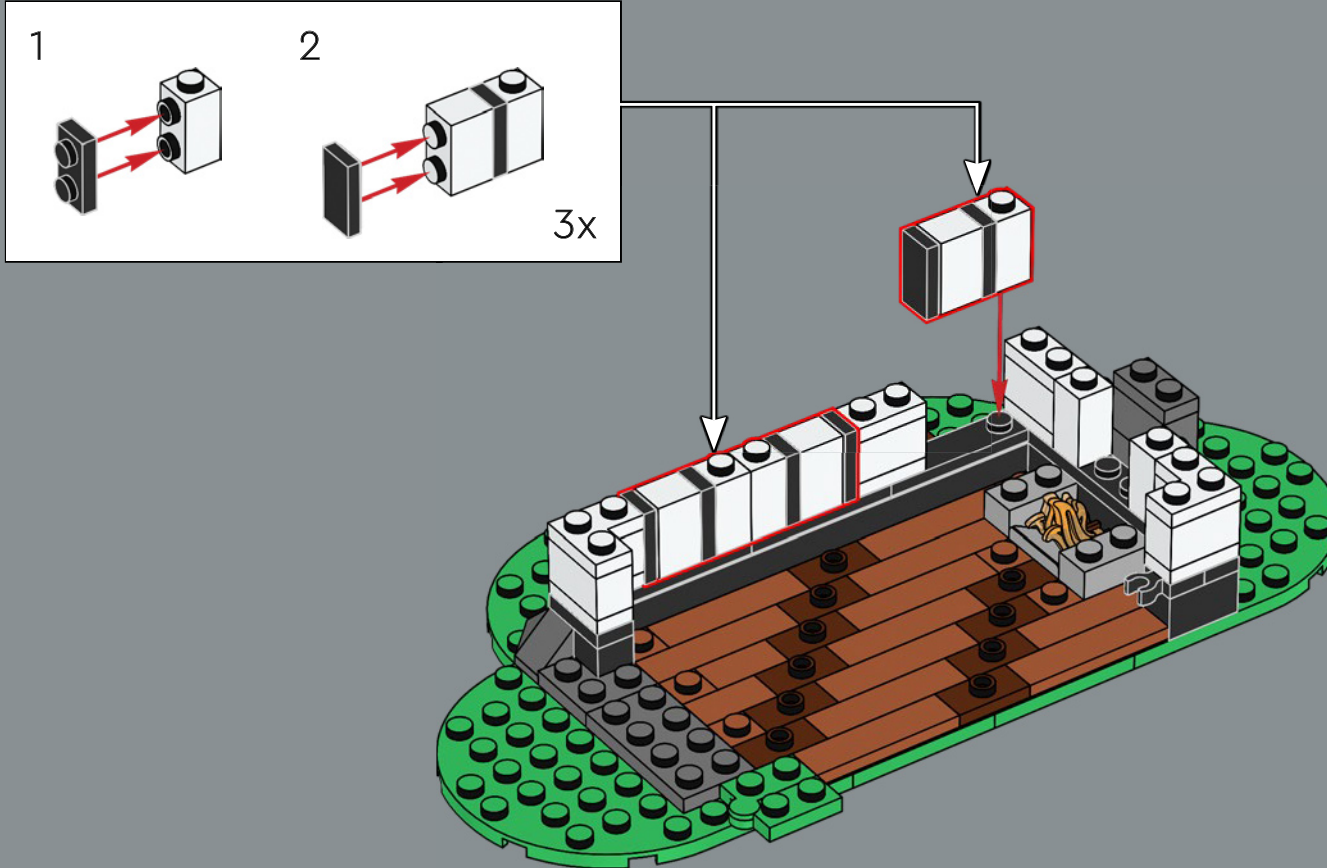

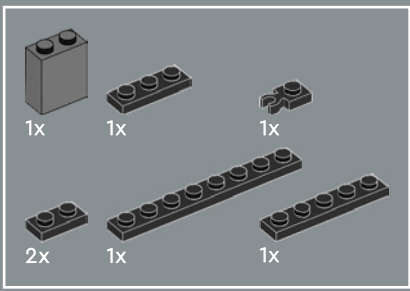

78

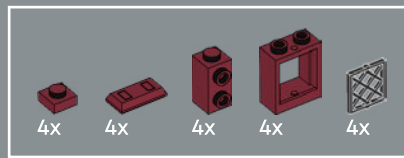
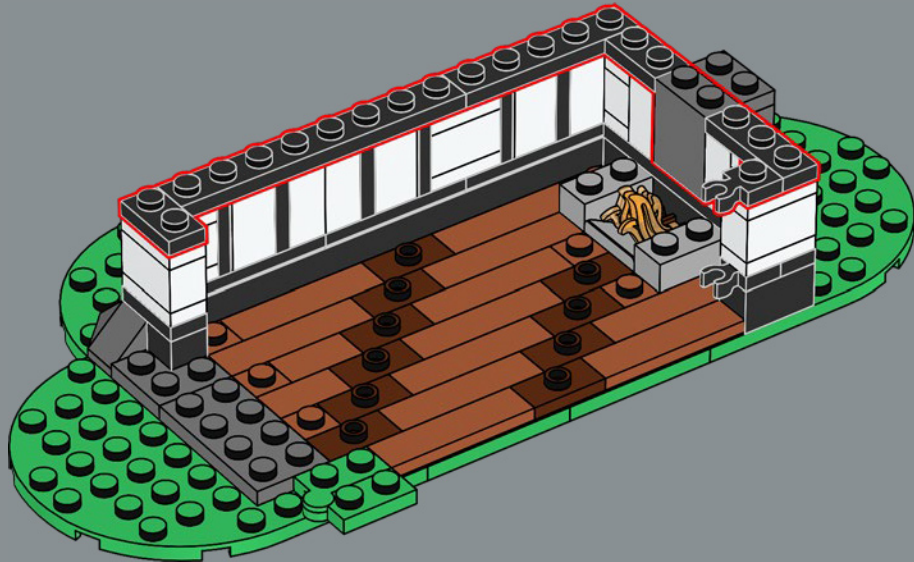

79

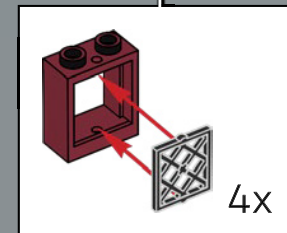
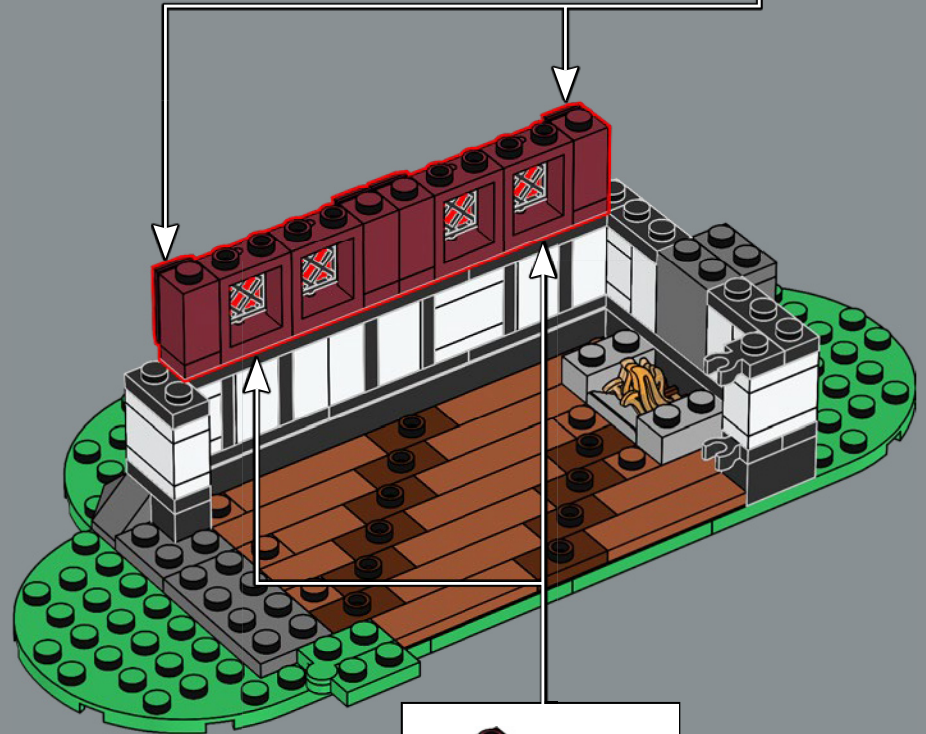
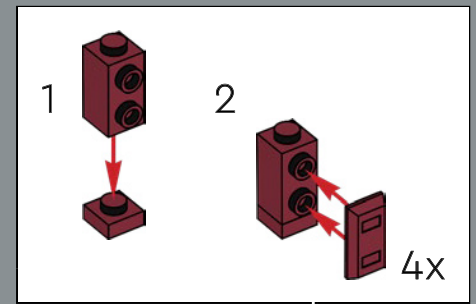

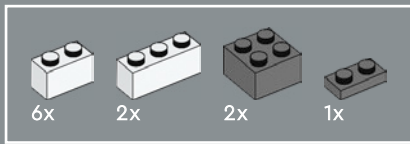

80

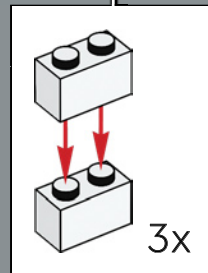
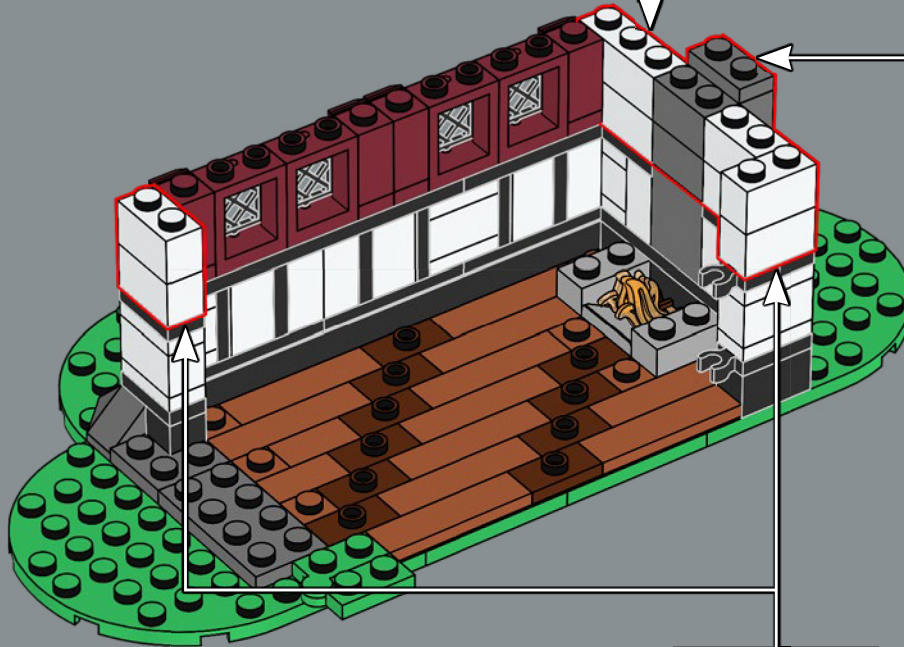
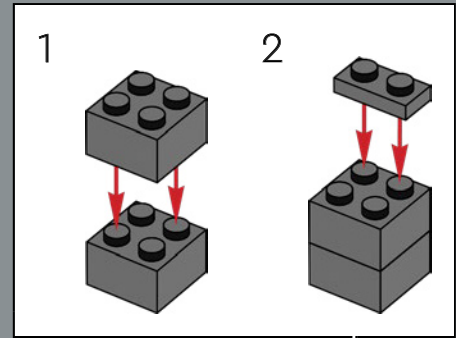
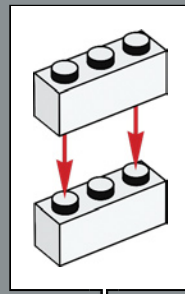

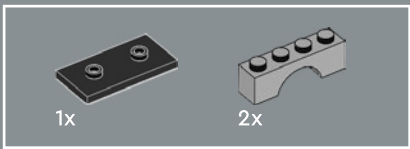

81

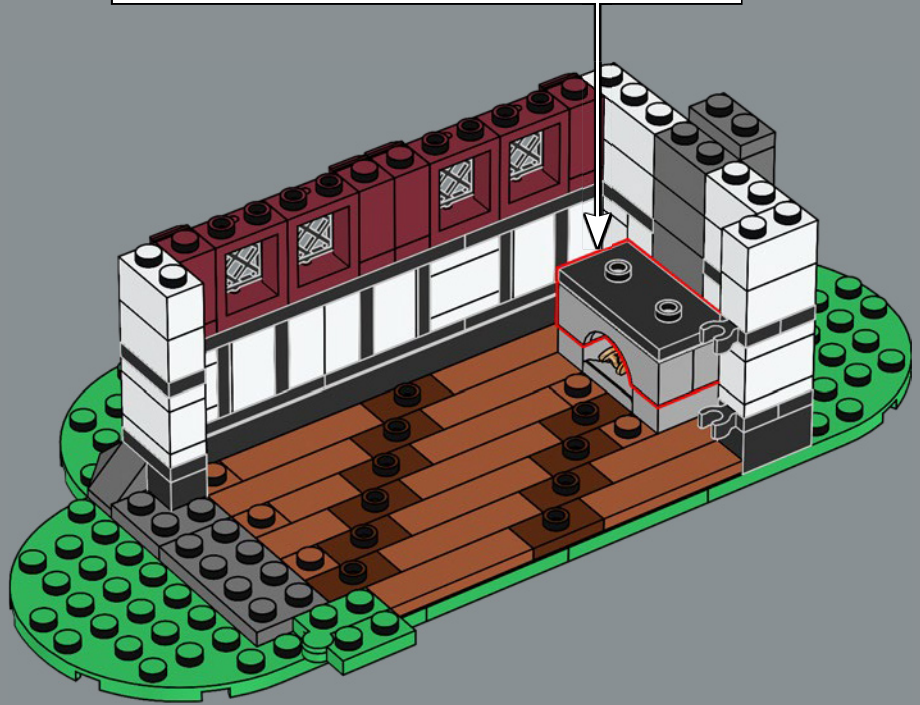
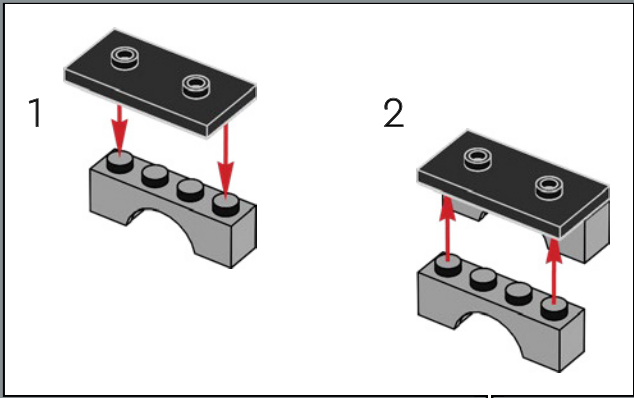

82

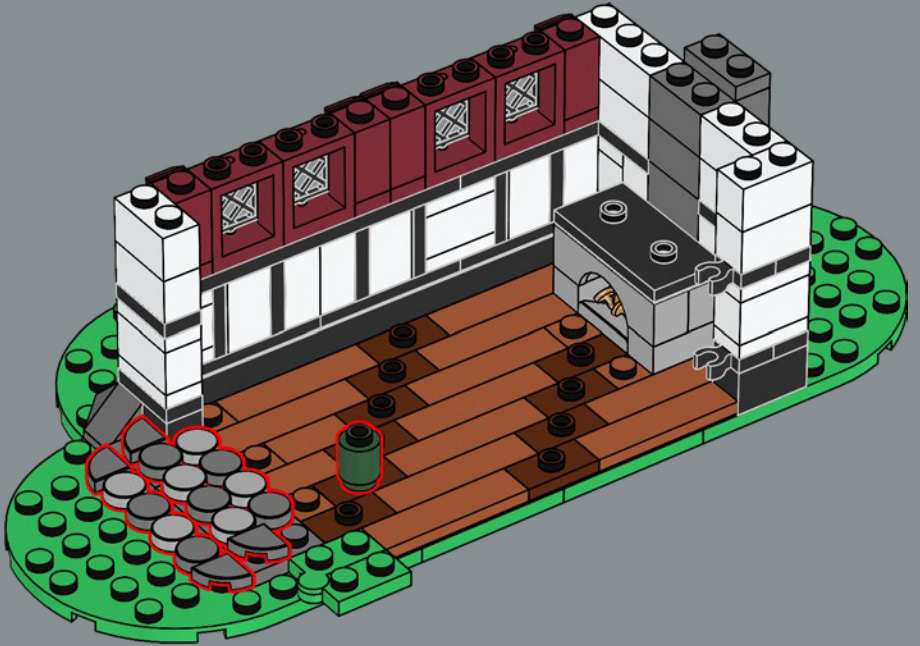



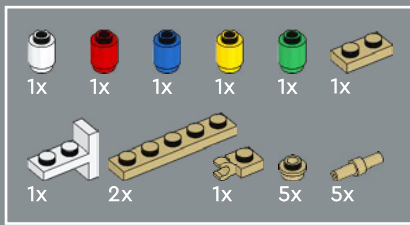

83

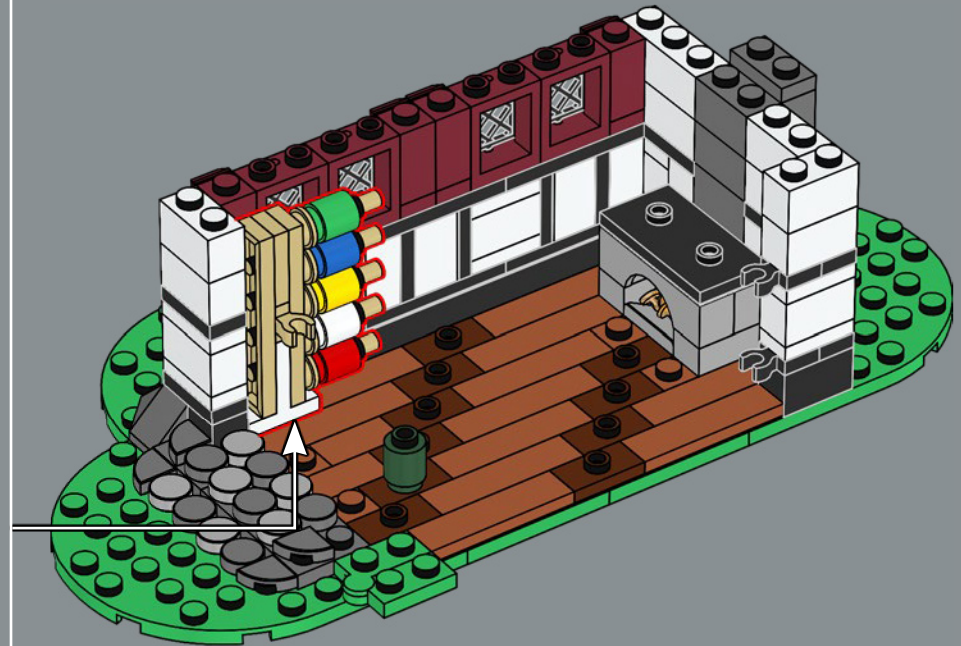
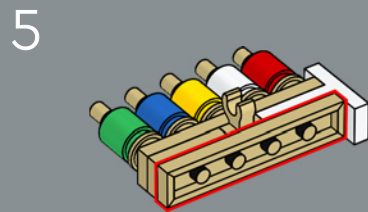
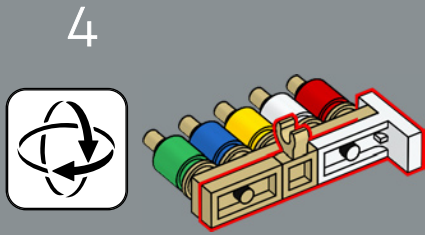
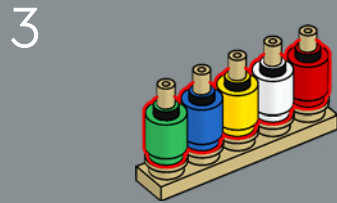
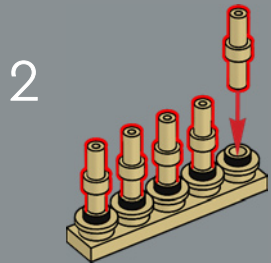
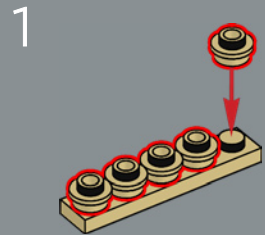

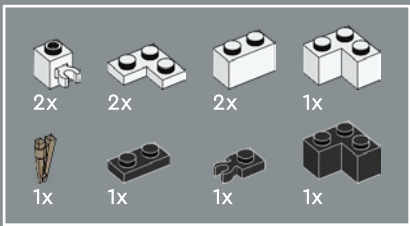

84

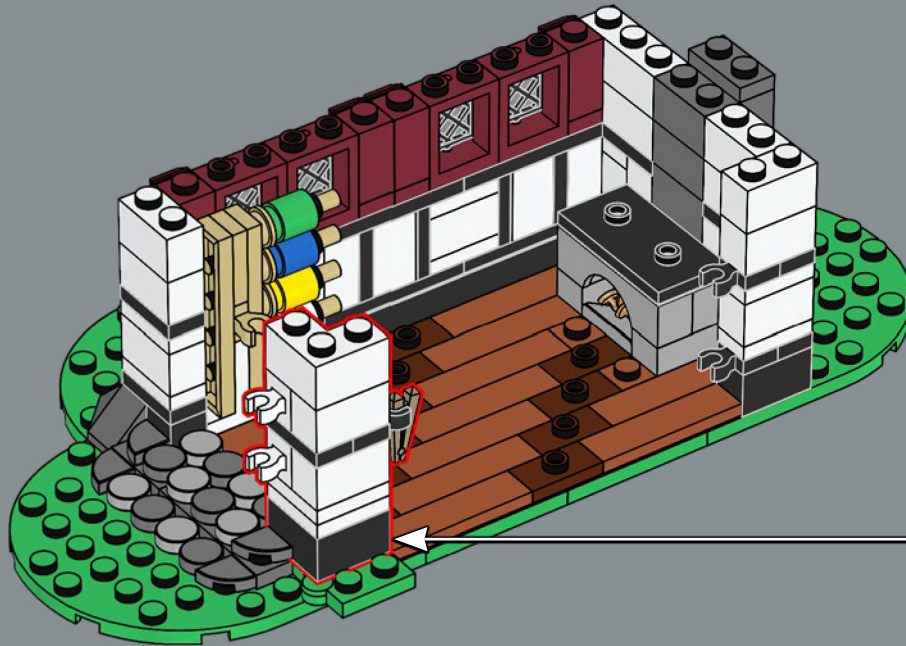
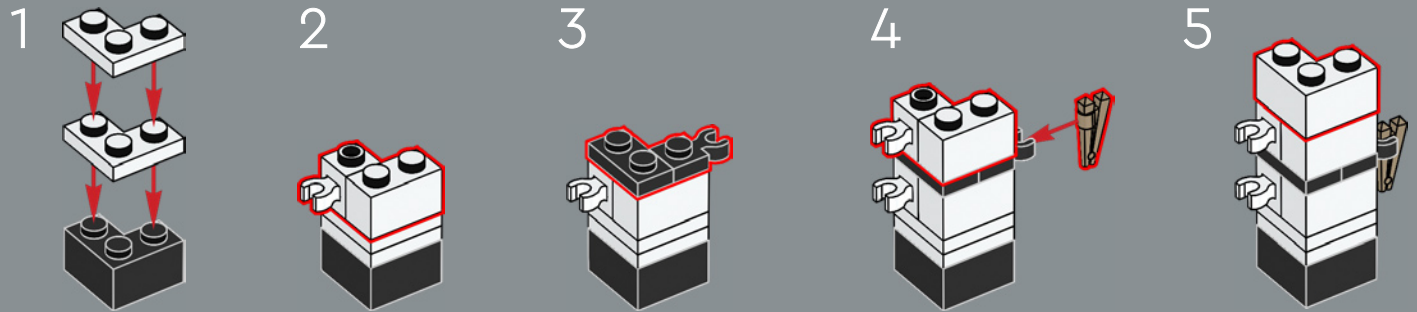

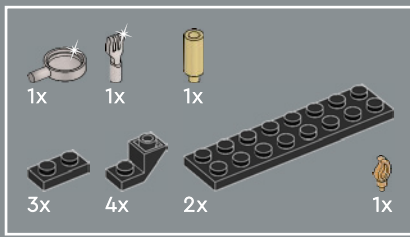

85

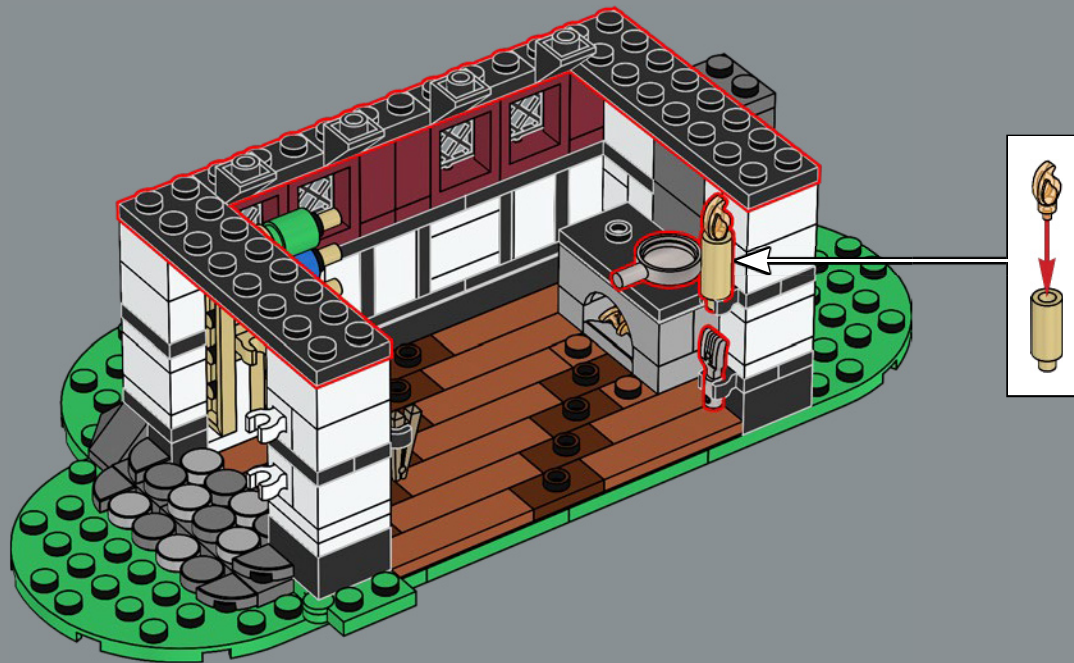

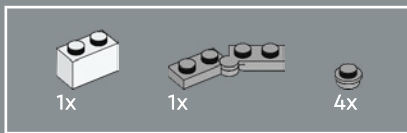

86

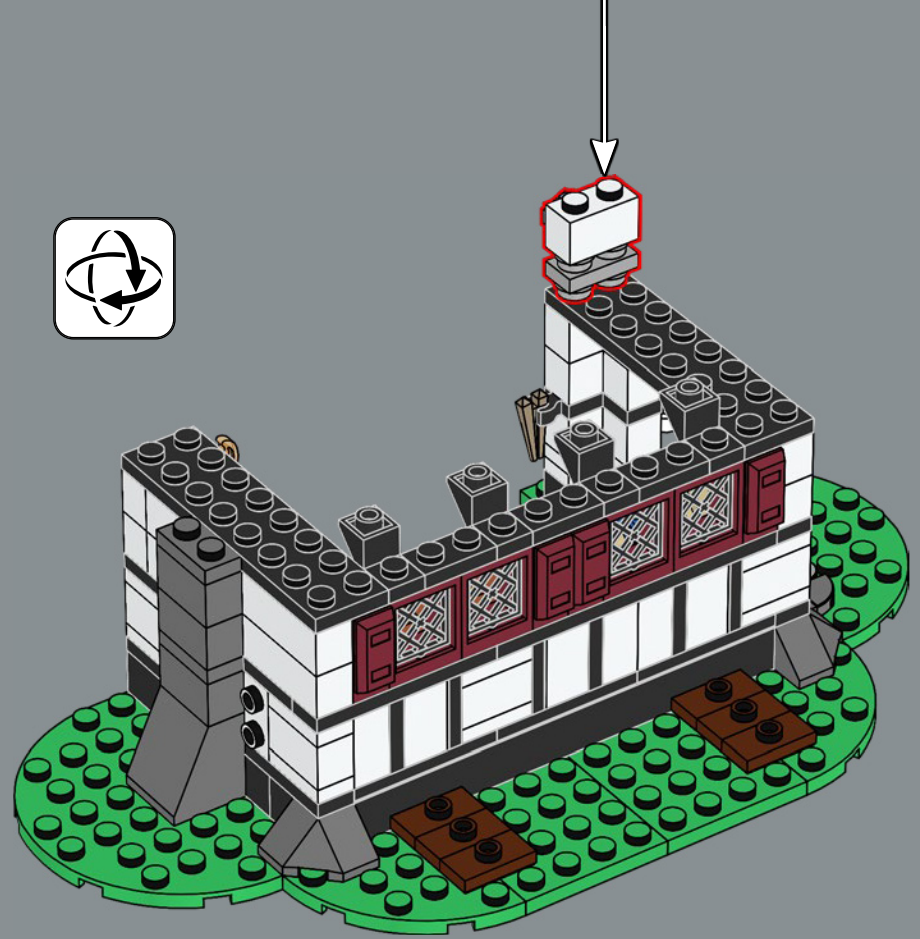
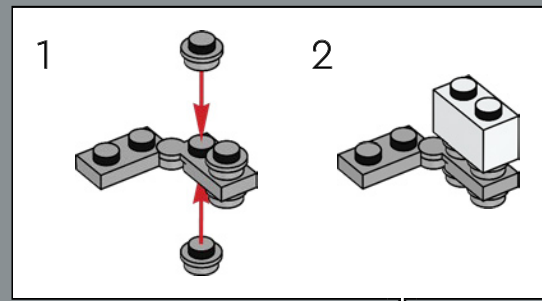

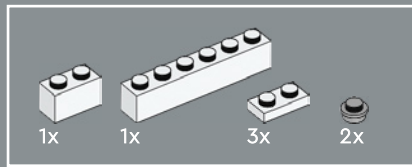

87

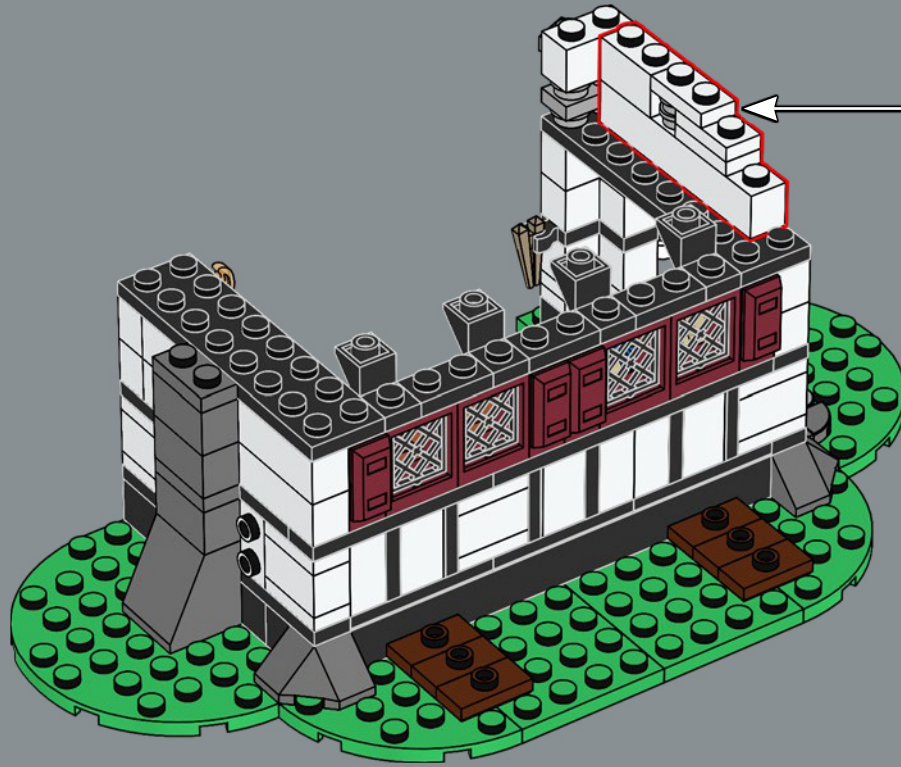
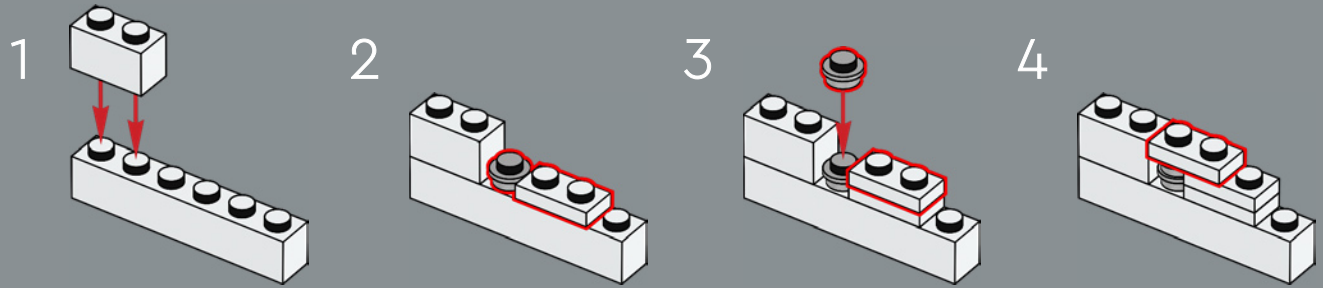

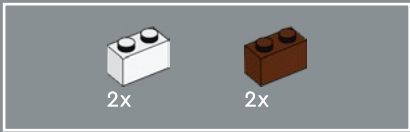

88

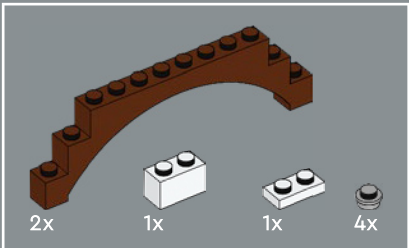
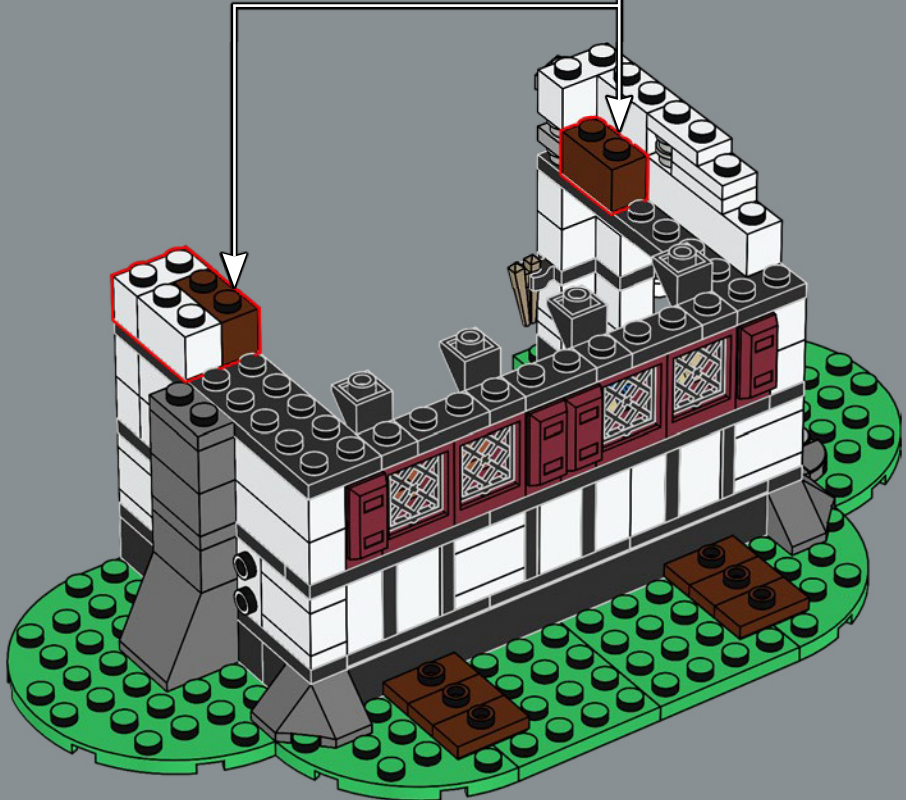
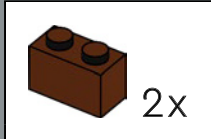

89

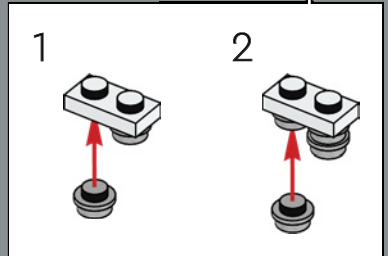
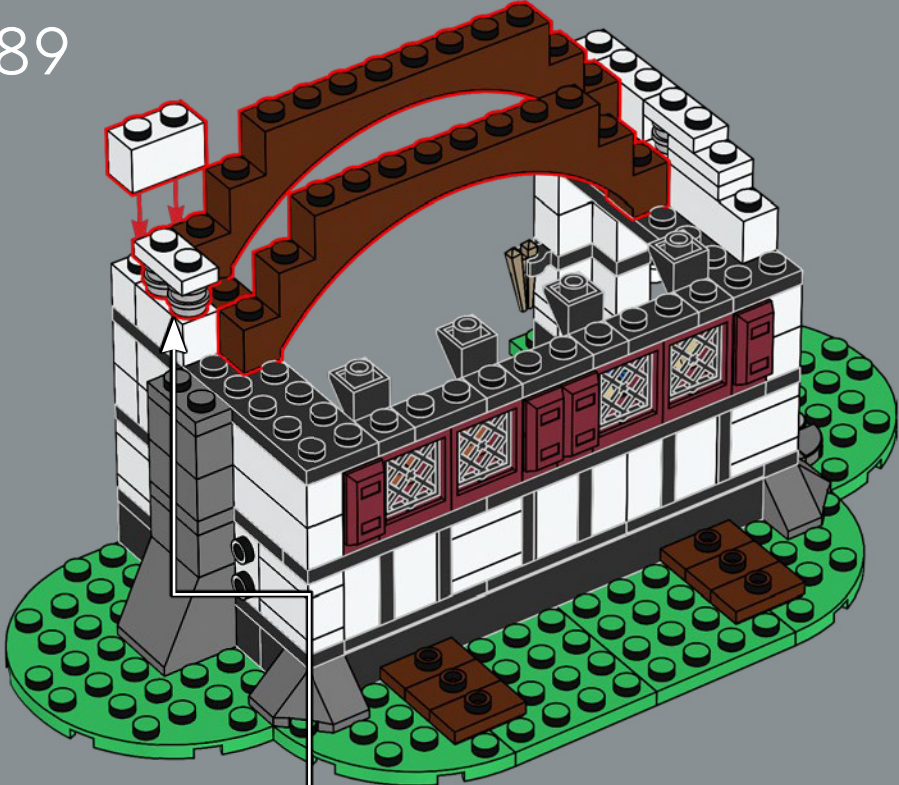

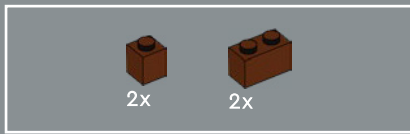

90

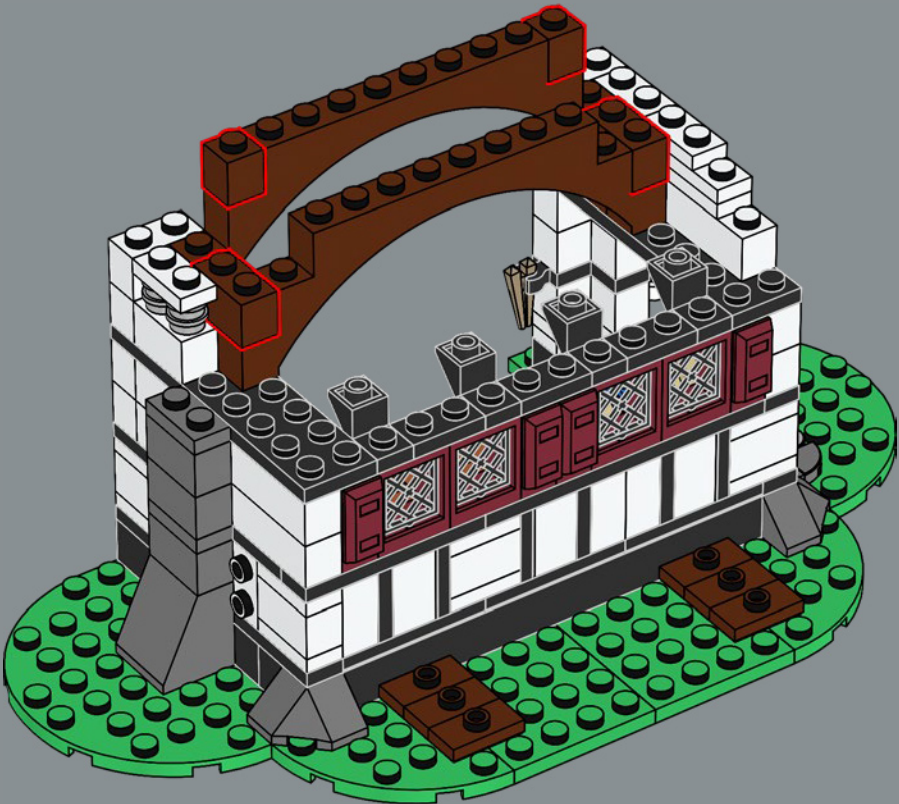

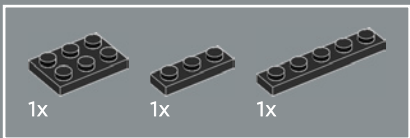

91

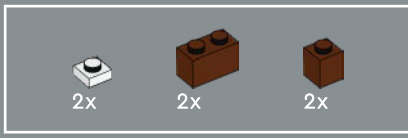
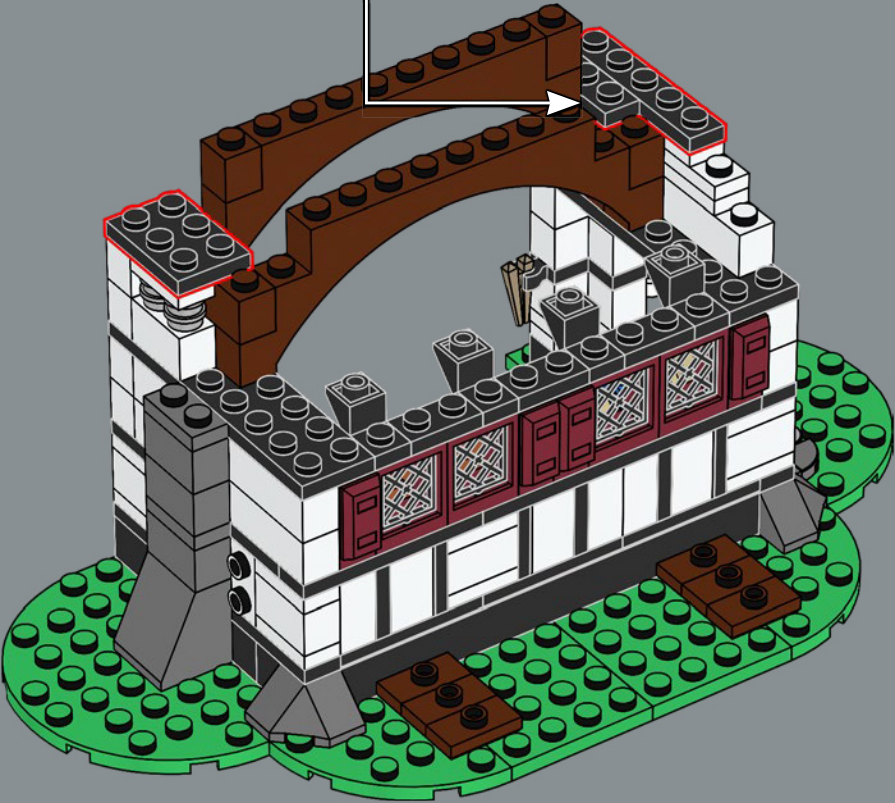
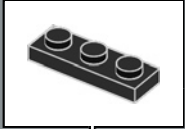

92

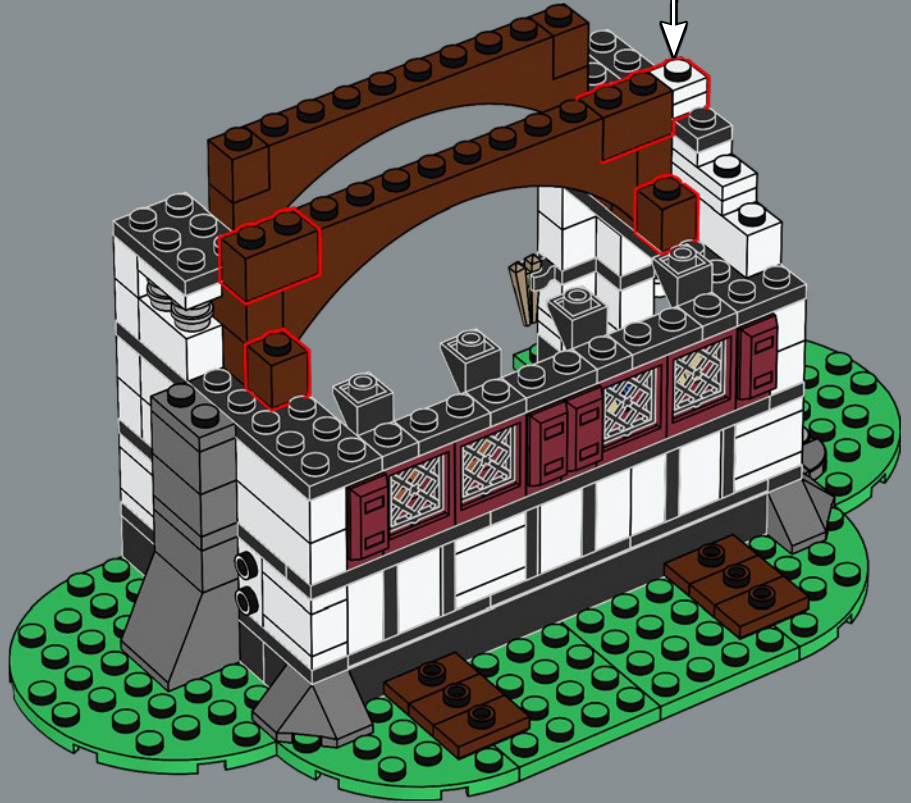
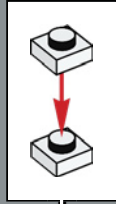



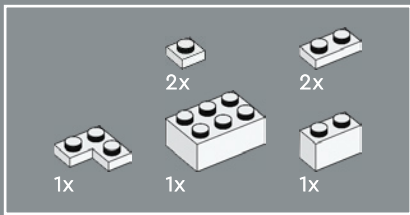

93

1

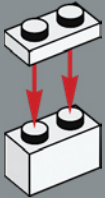

2

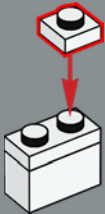

3

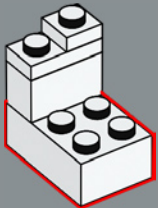

4

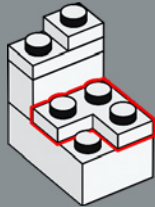

5

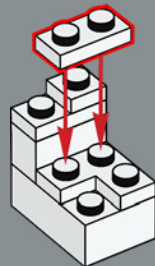

6

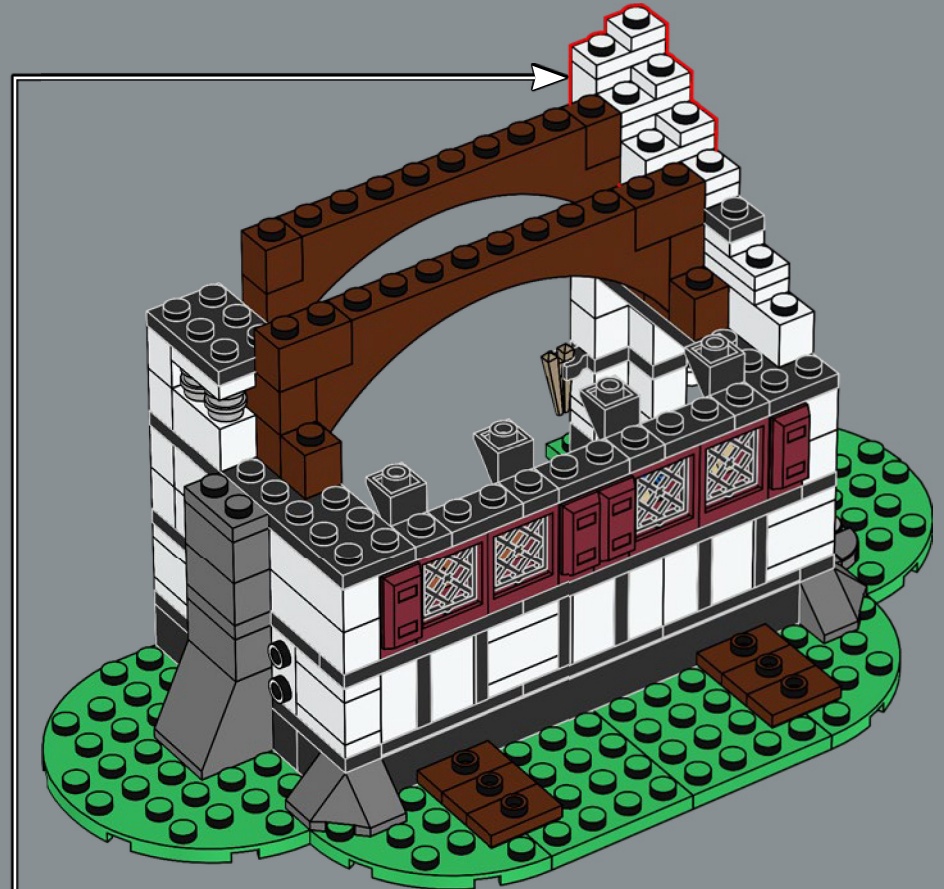
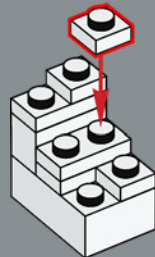

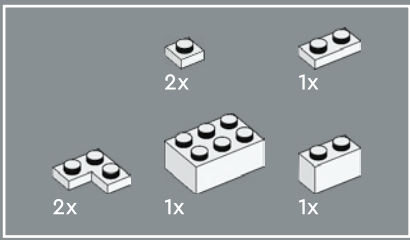

94

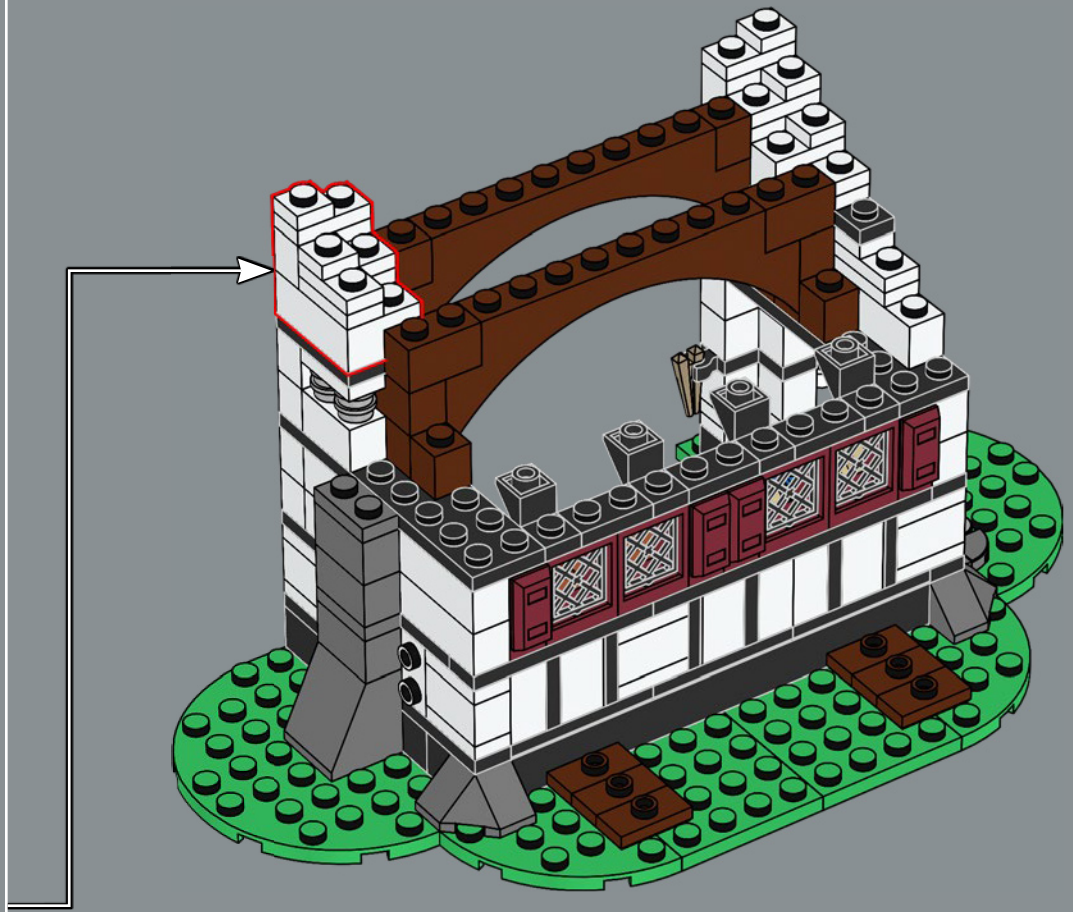
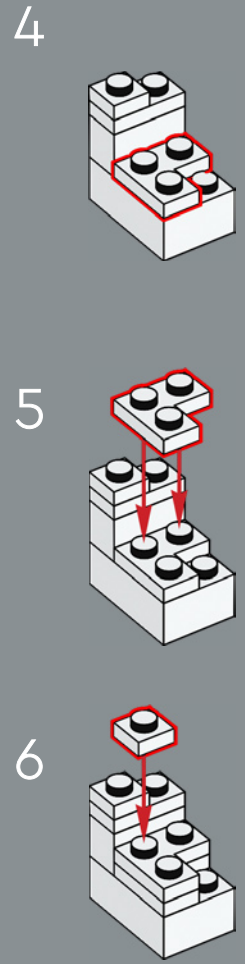
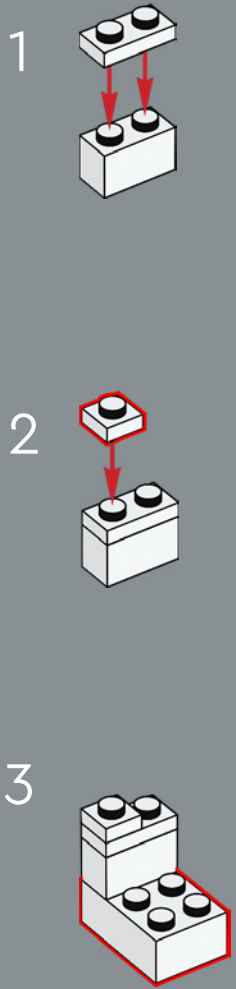

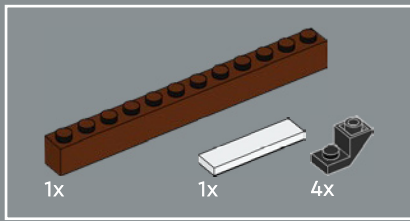

95

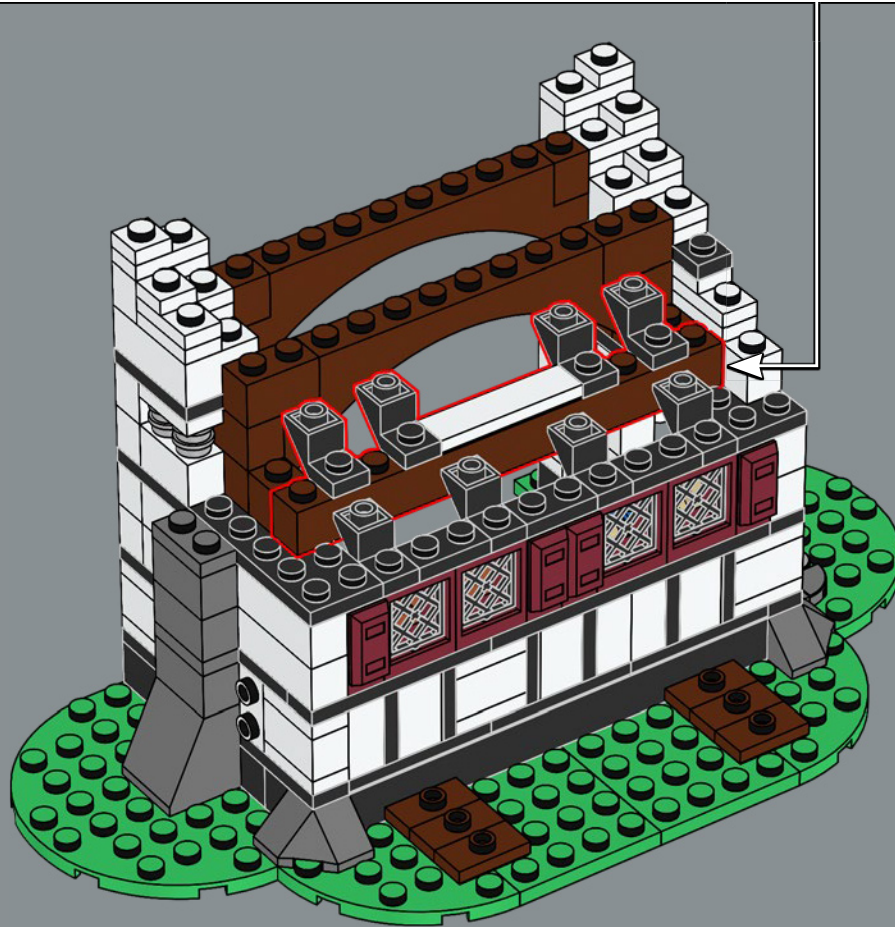
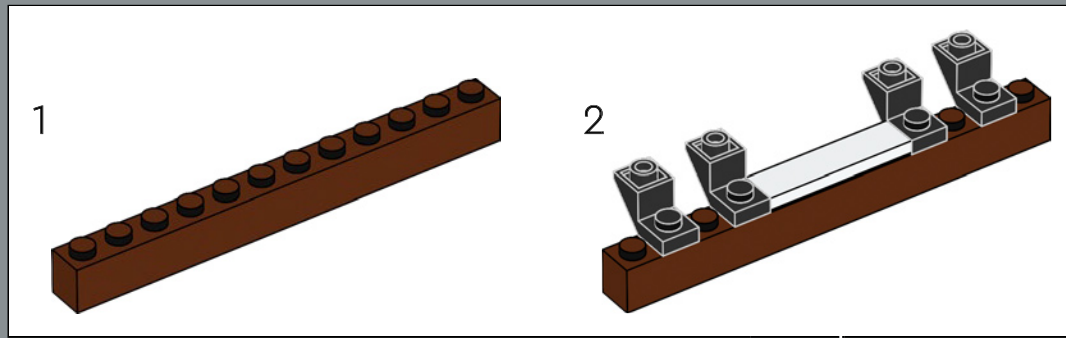

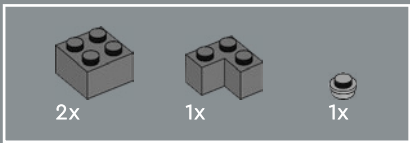

96

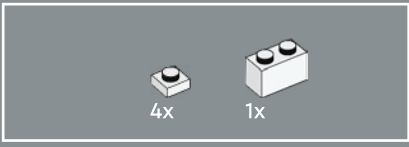
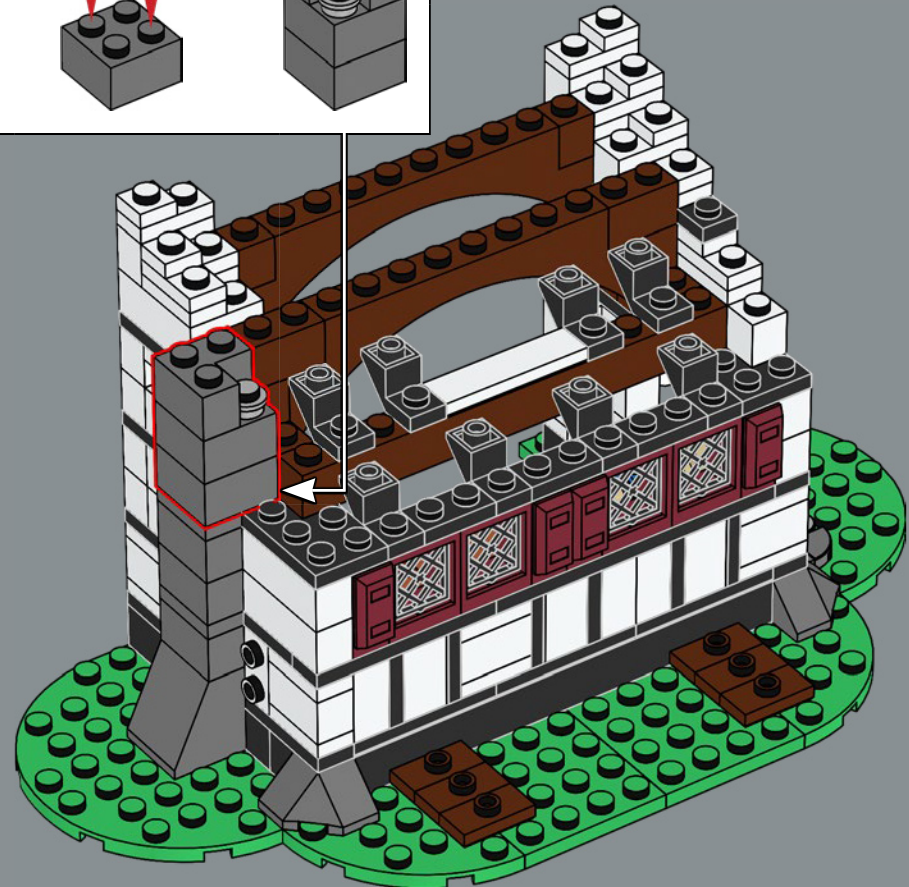
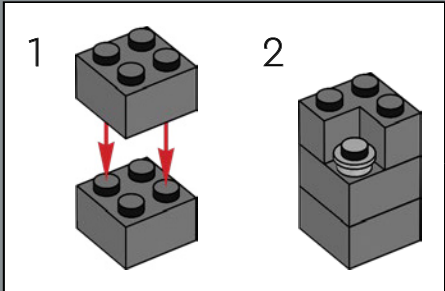

97

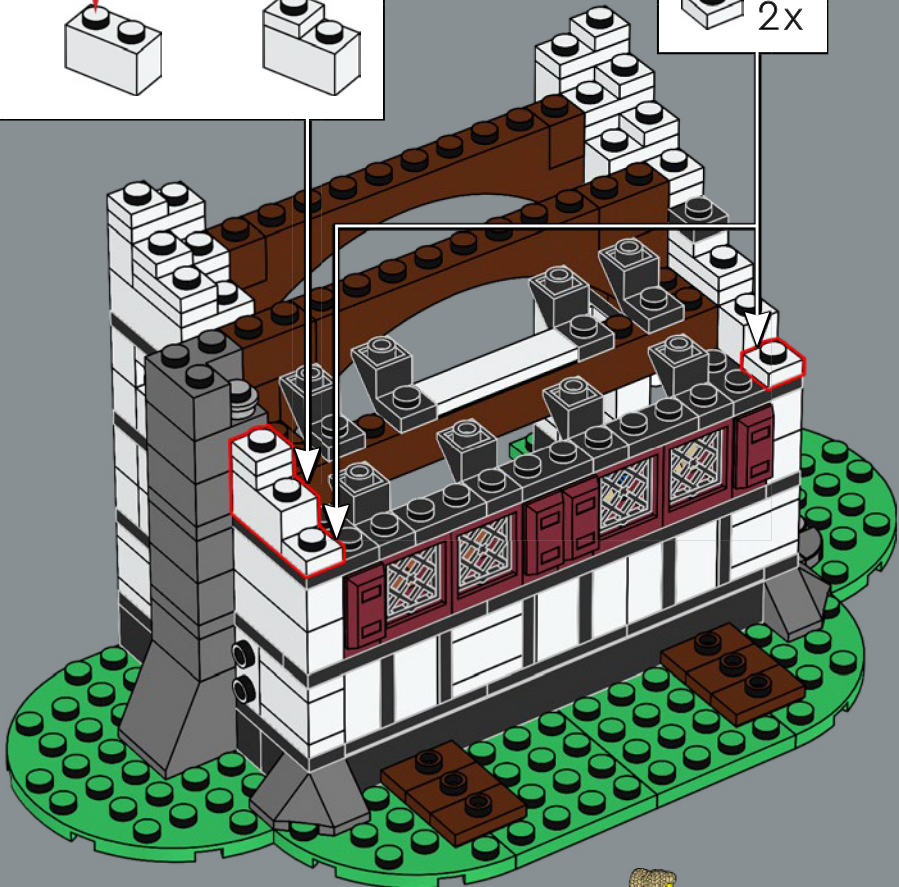
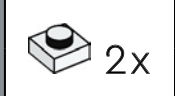
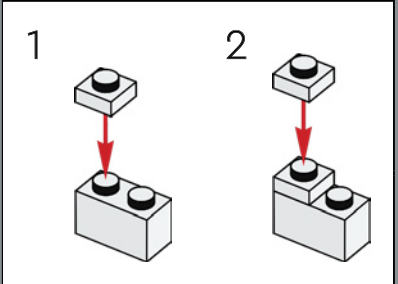

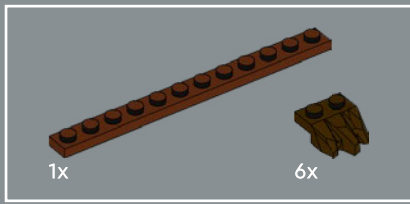

98

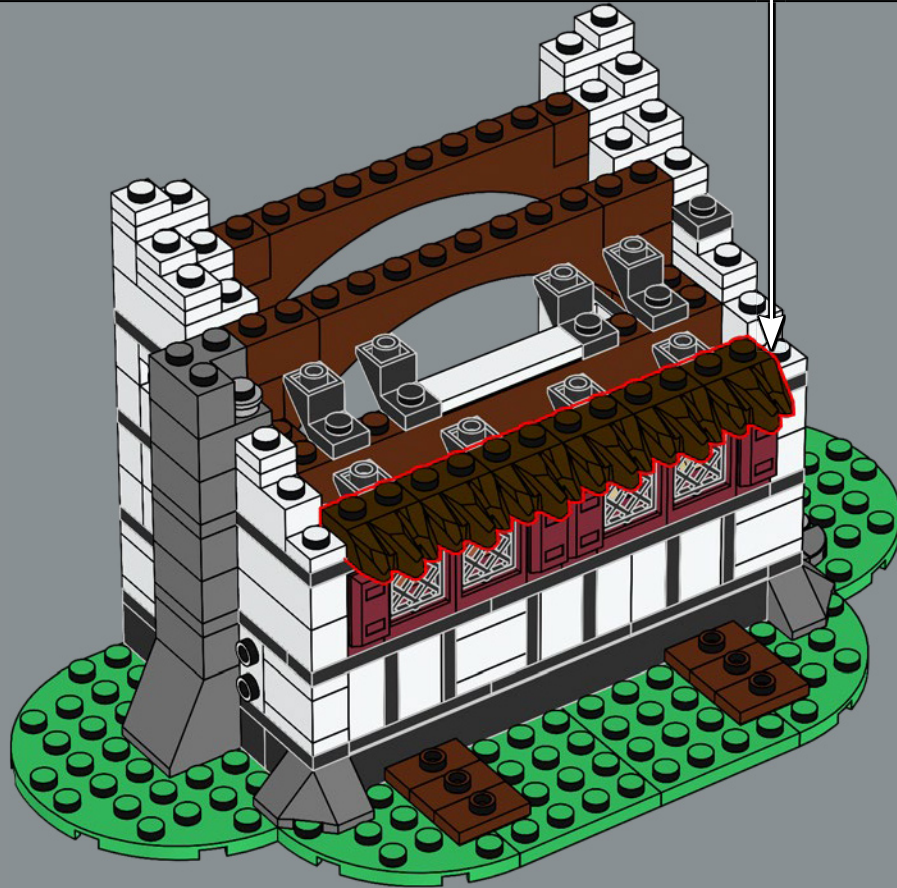
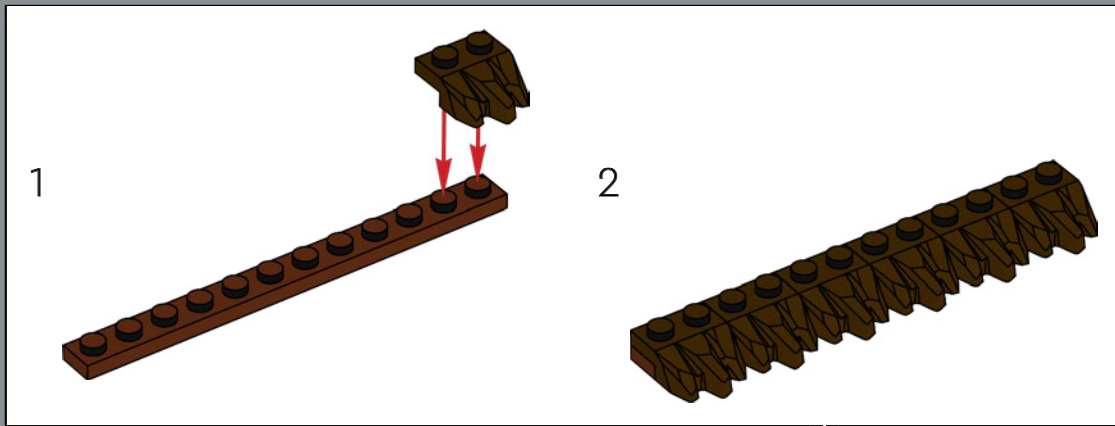

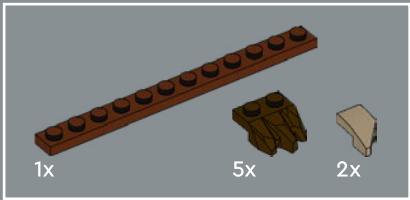

99

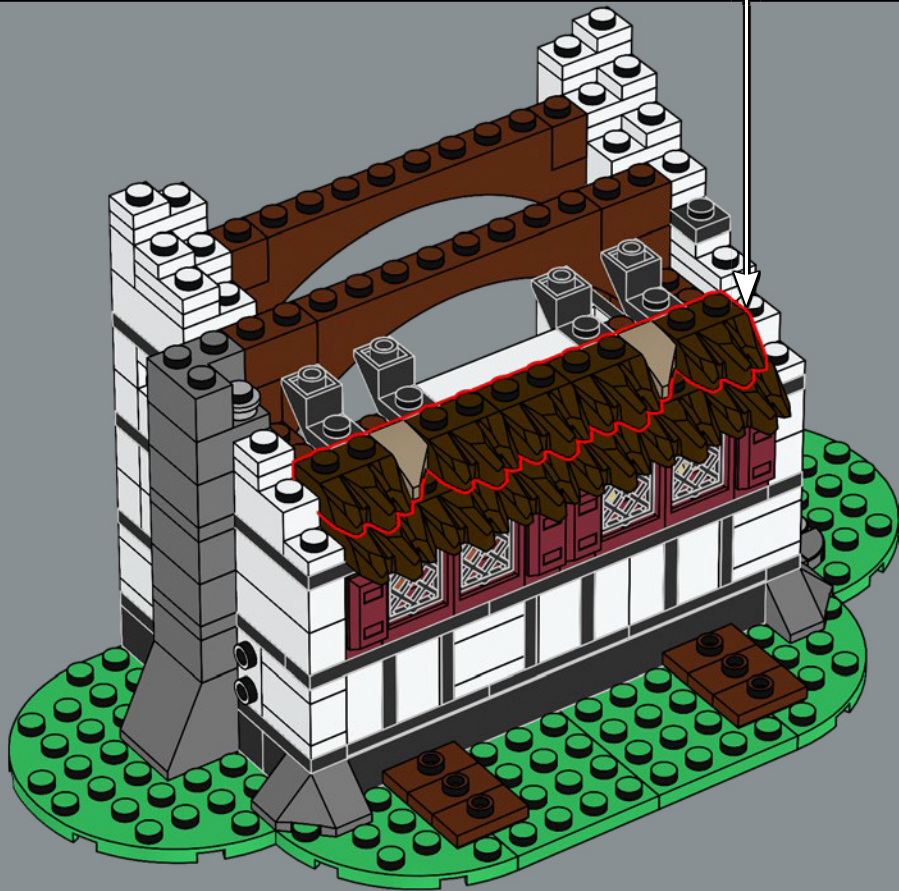
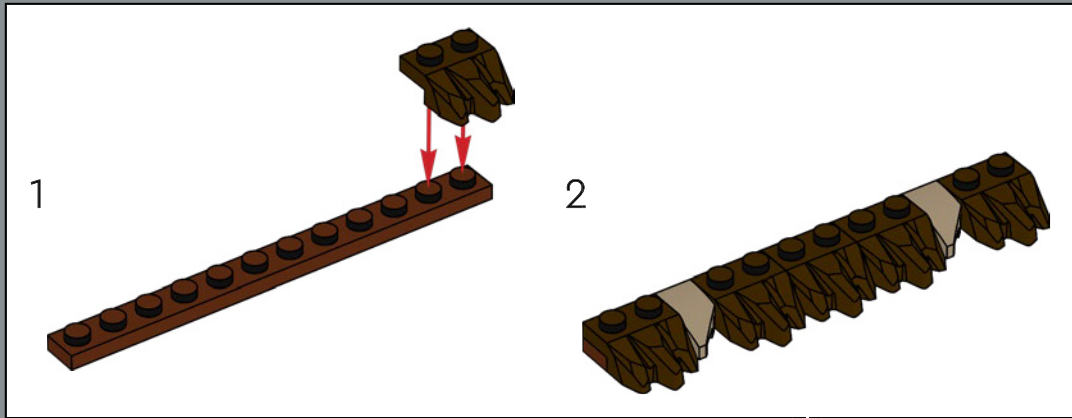



100

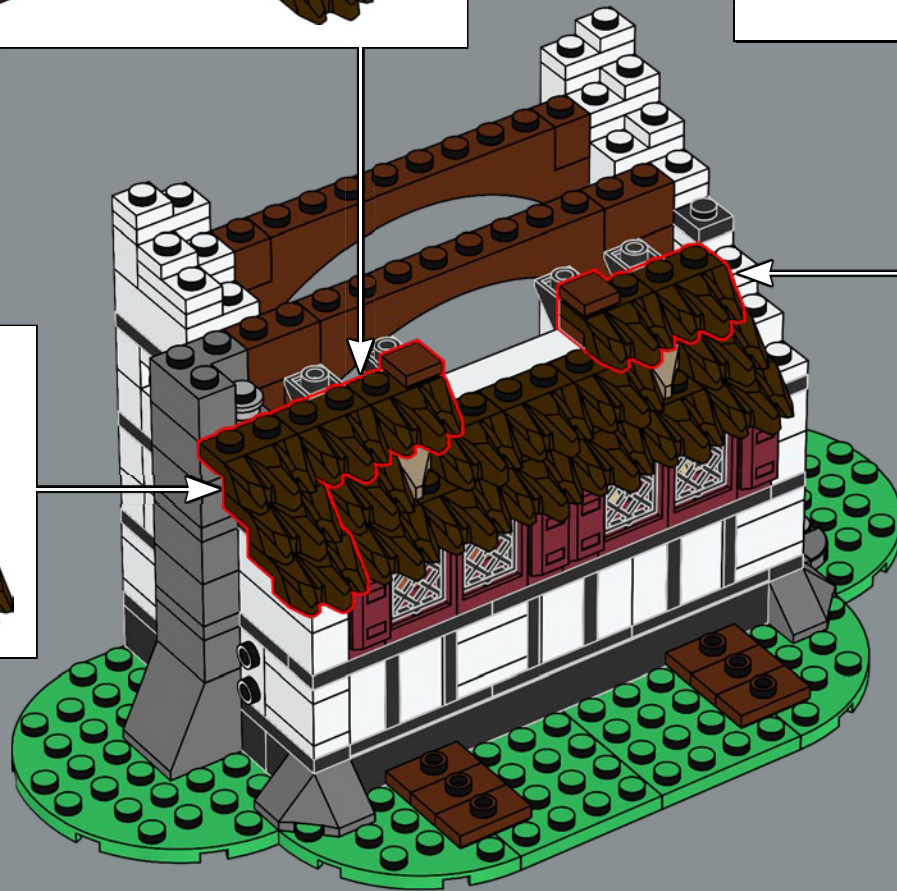
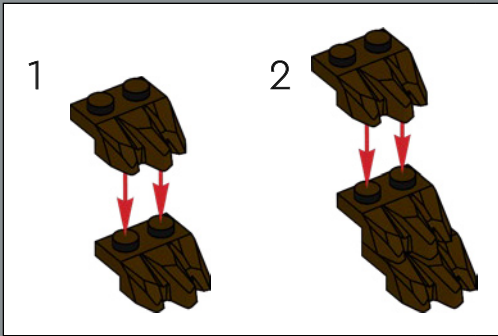
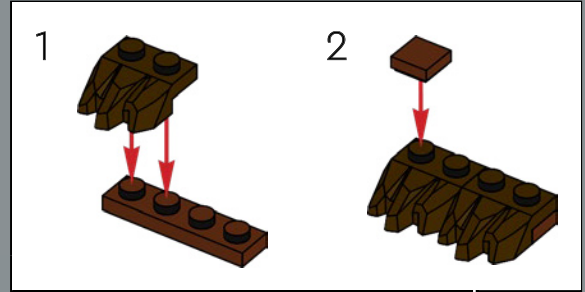
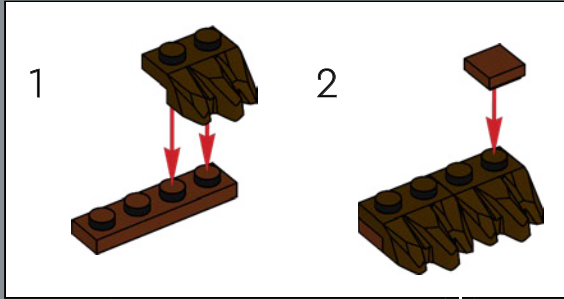

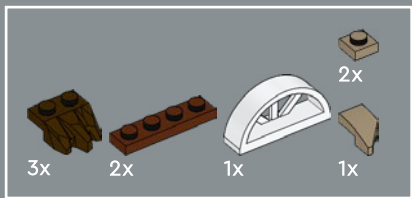

101

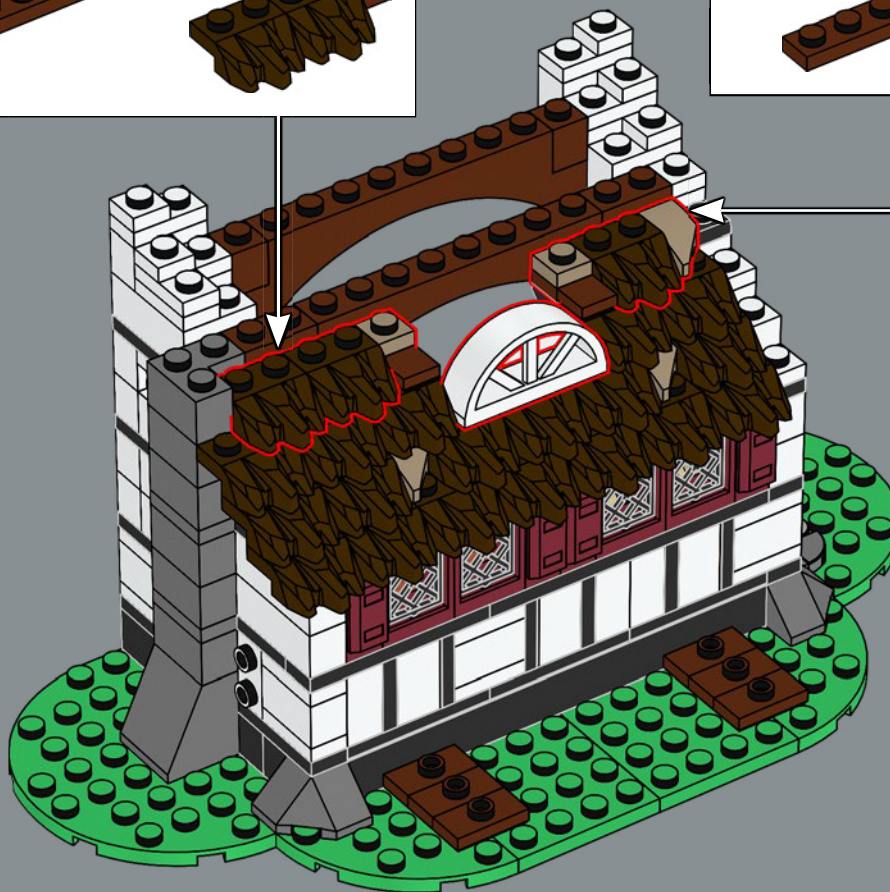
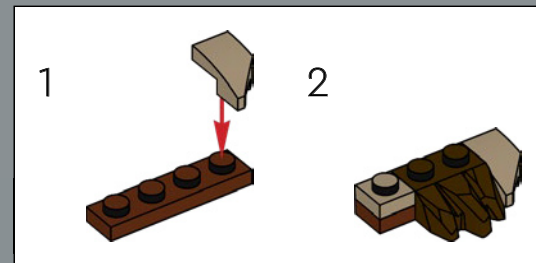
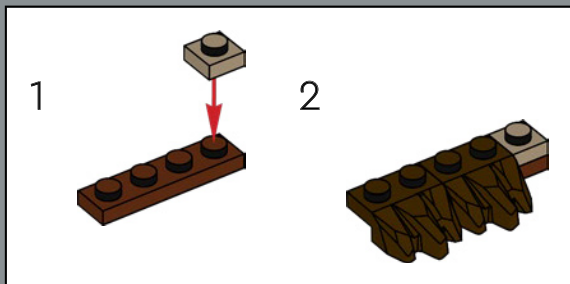





102

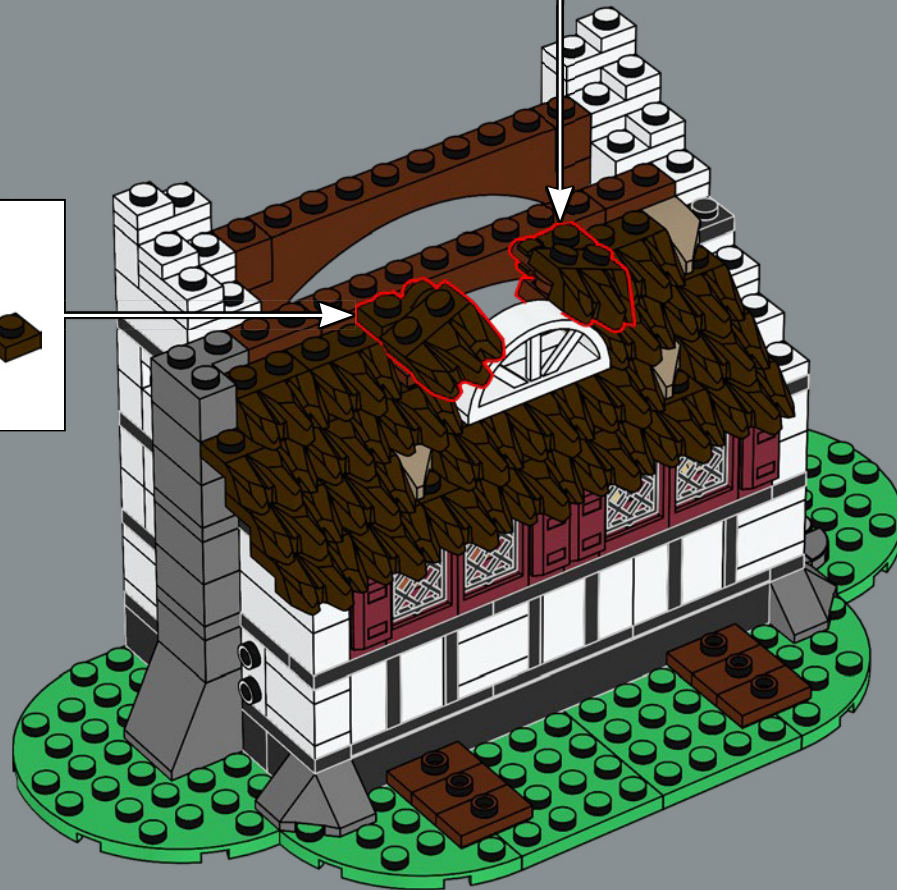
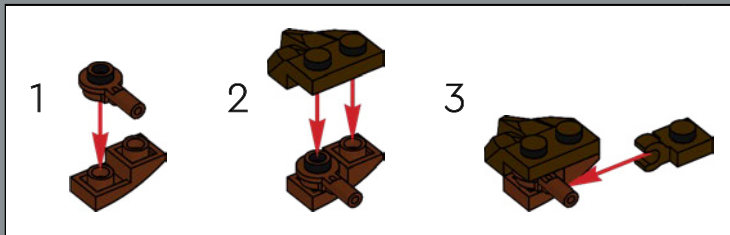
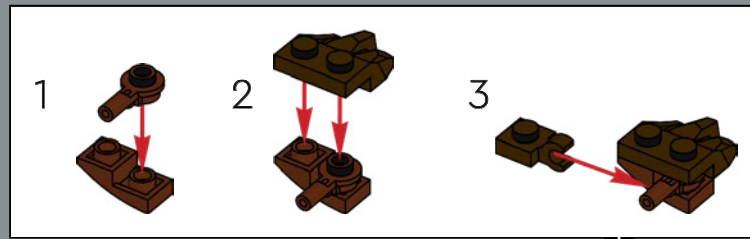

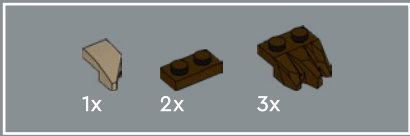

103

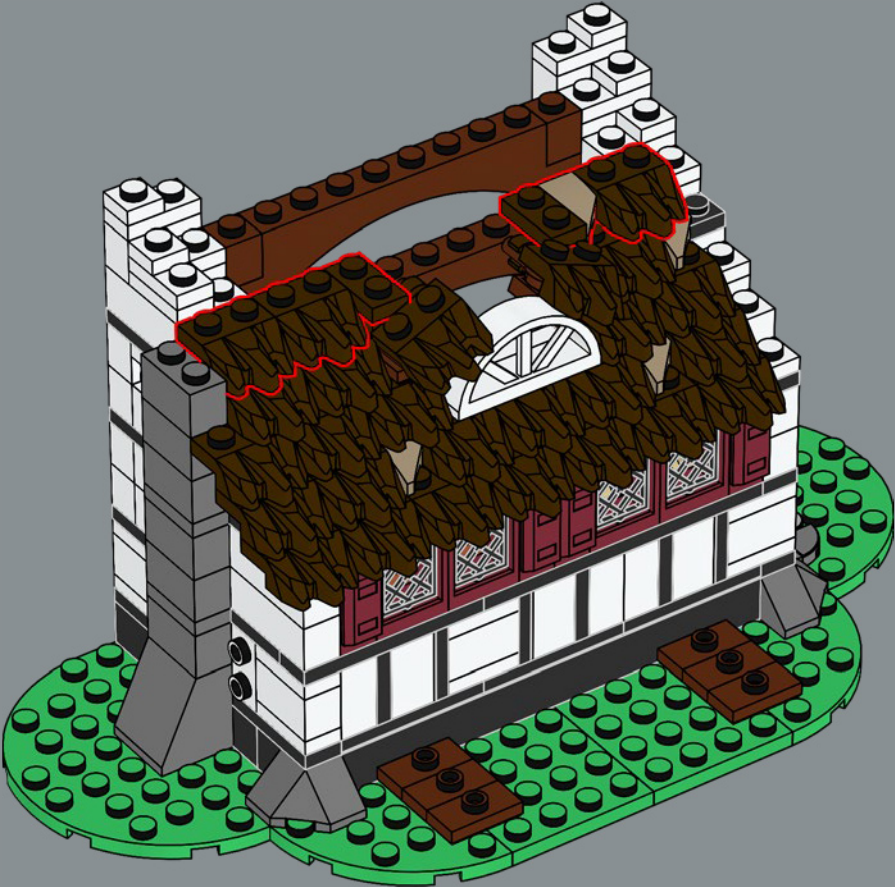

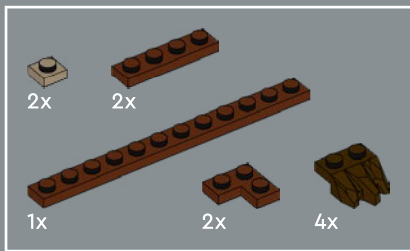

104

1

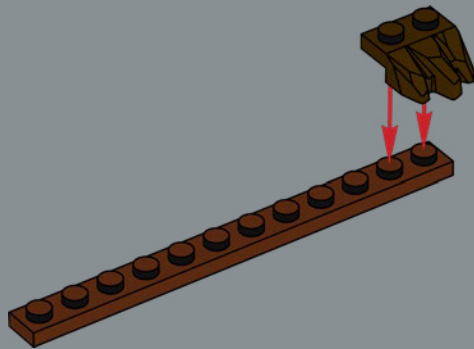

2

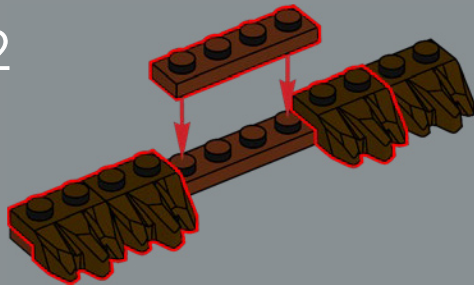

3

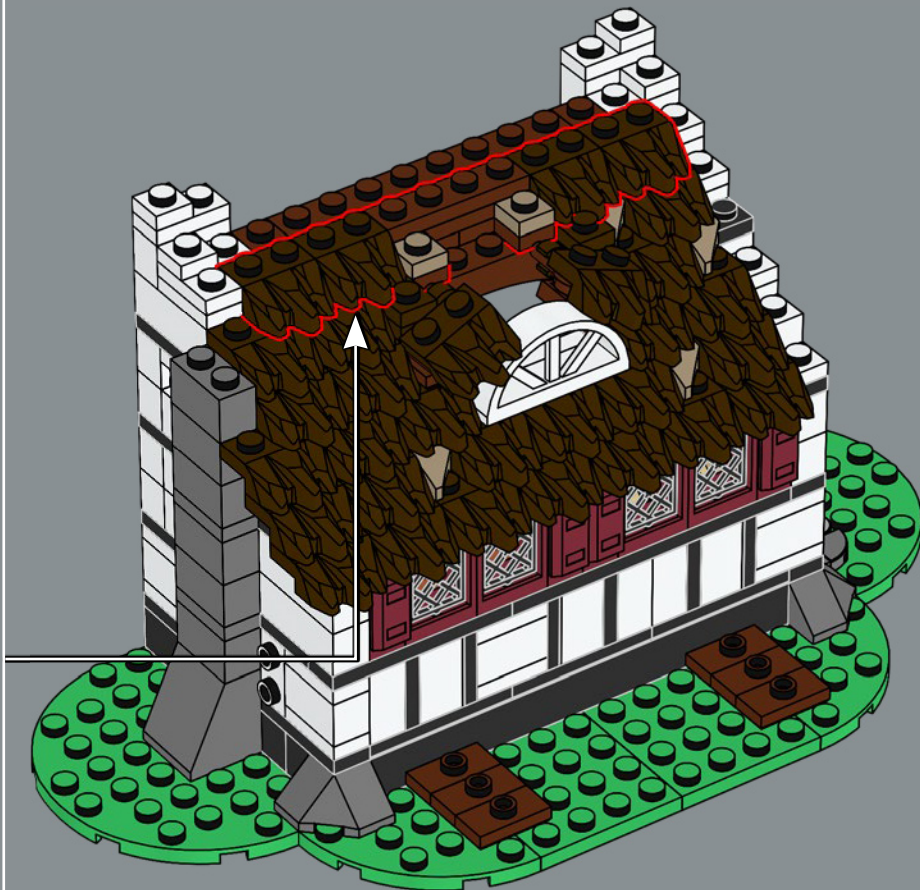
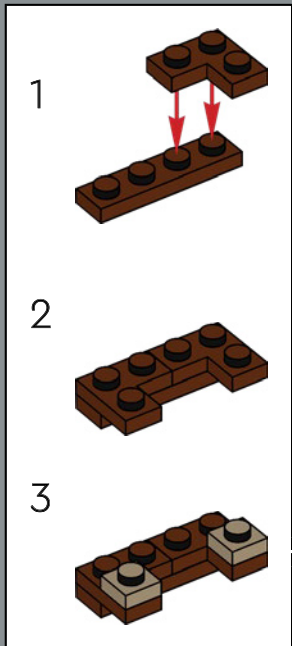
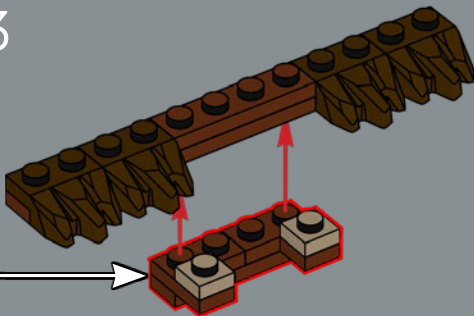



8x

105

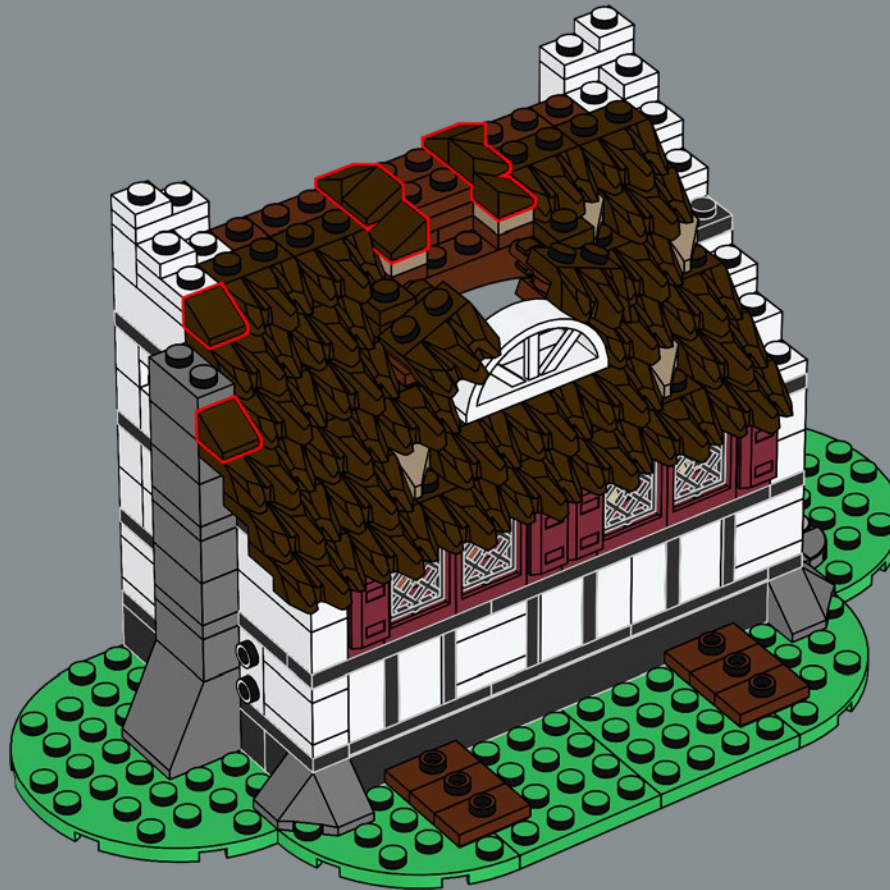

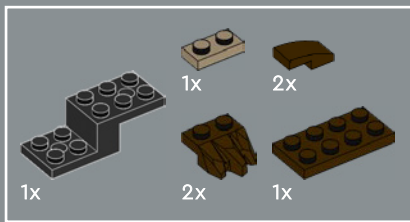

106

1

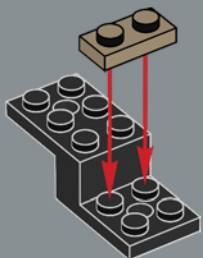

2

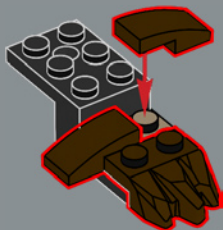

3

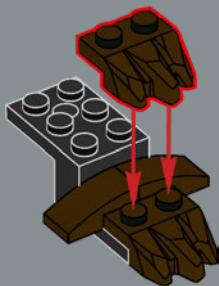

4

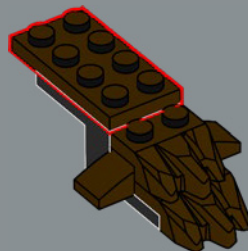

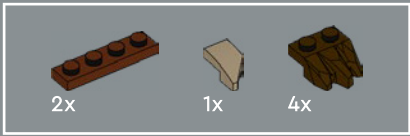

107

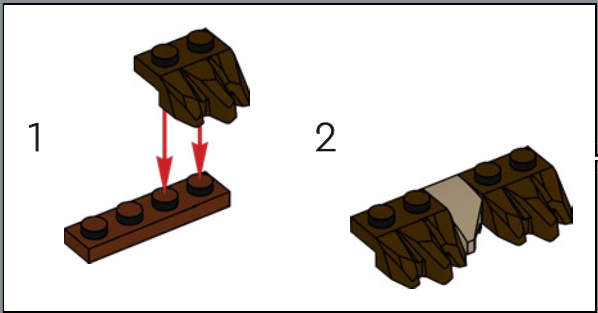
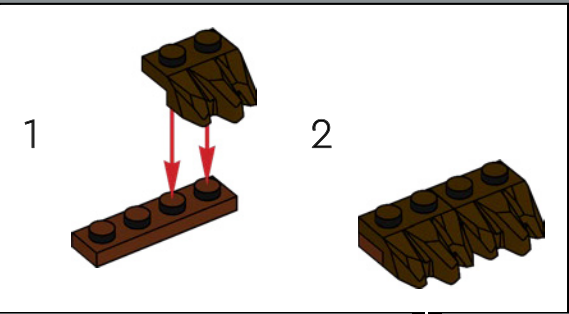

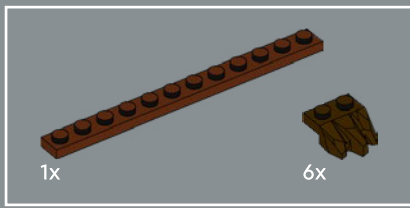

108

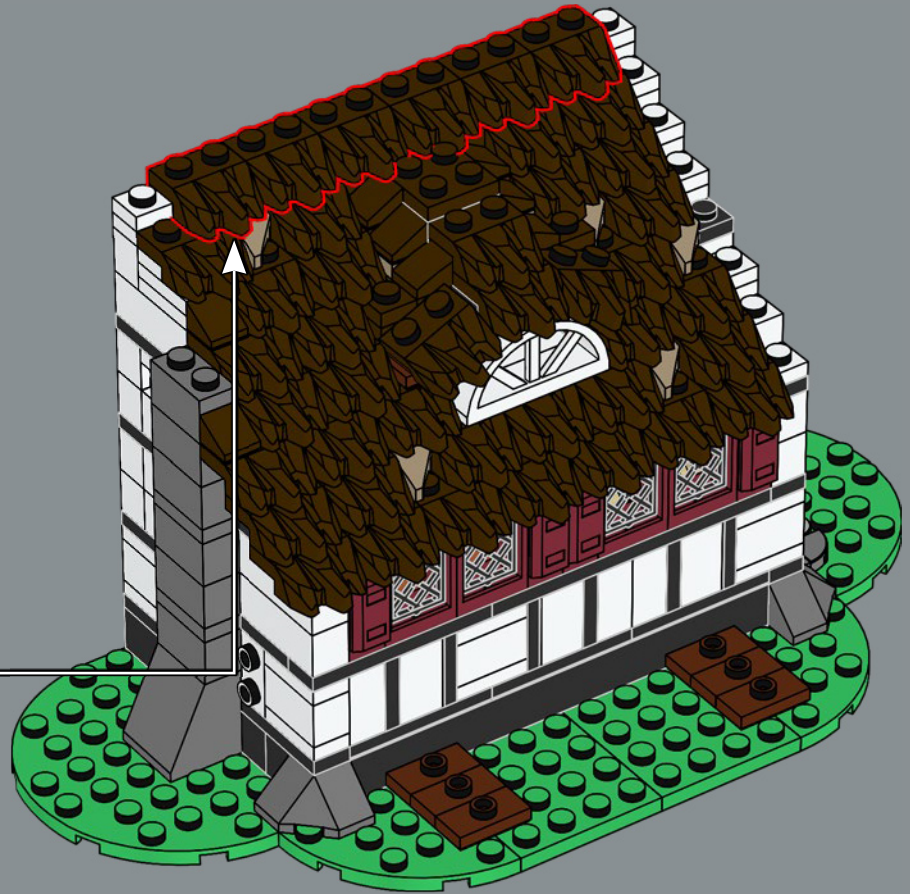
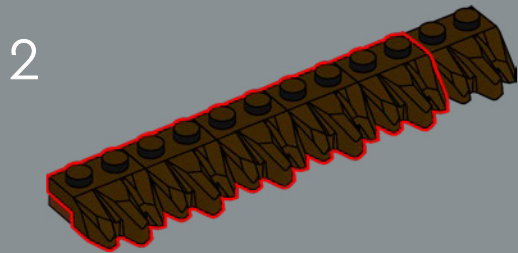
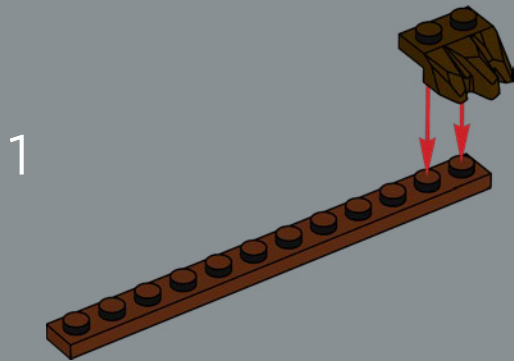



109

1

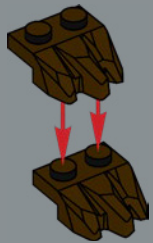

2

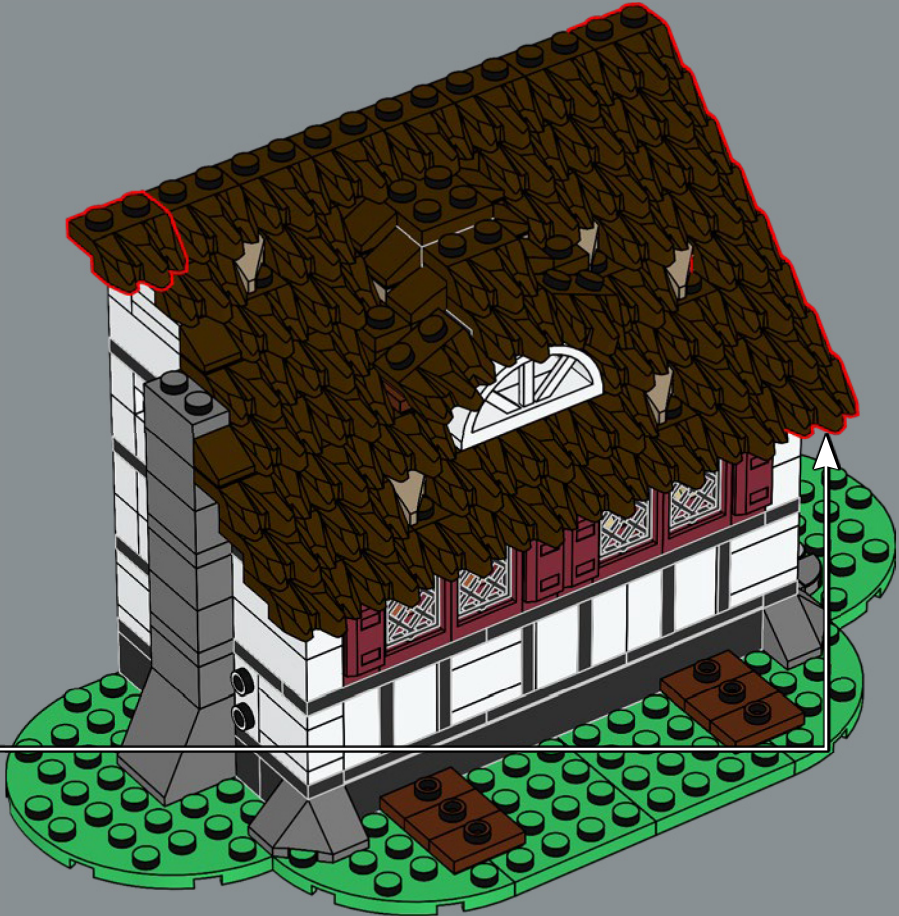
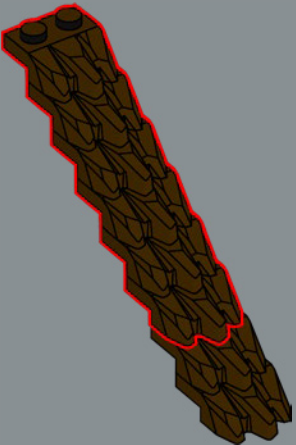



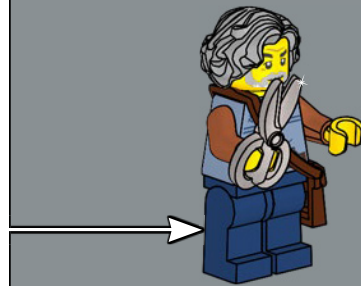
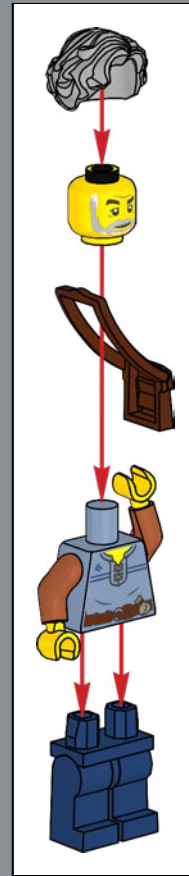



110

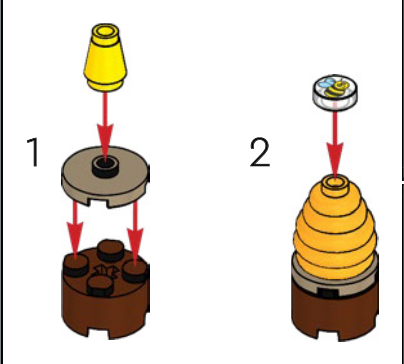
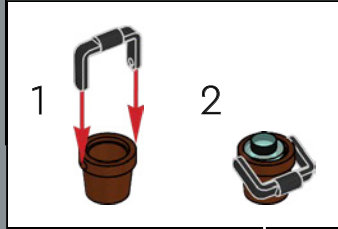
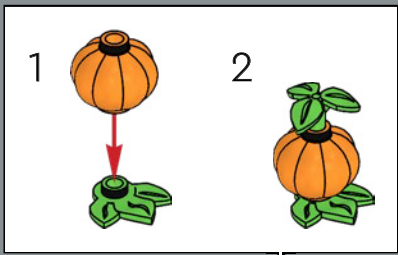



111

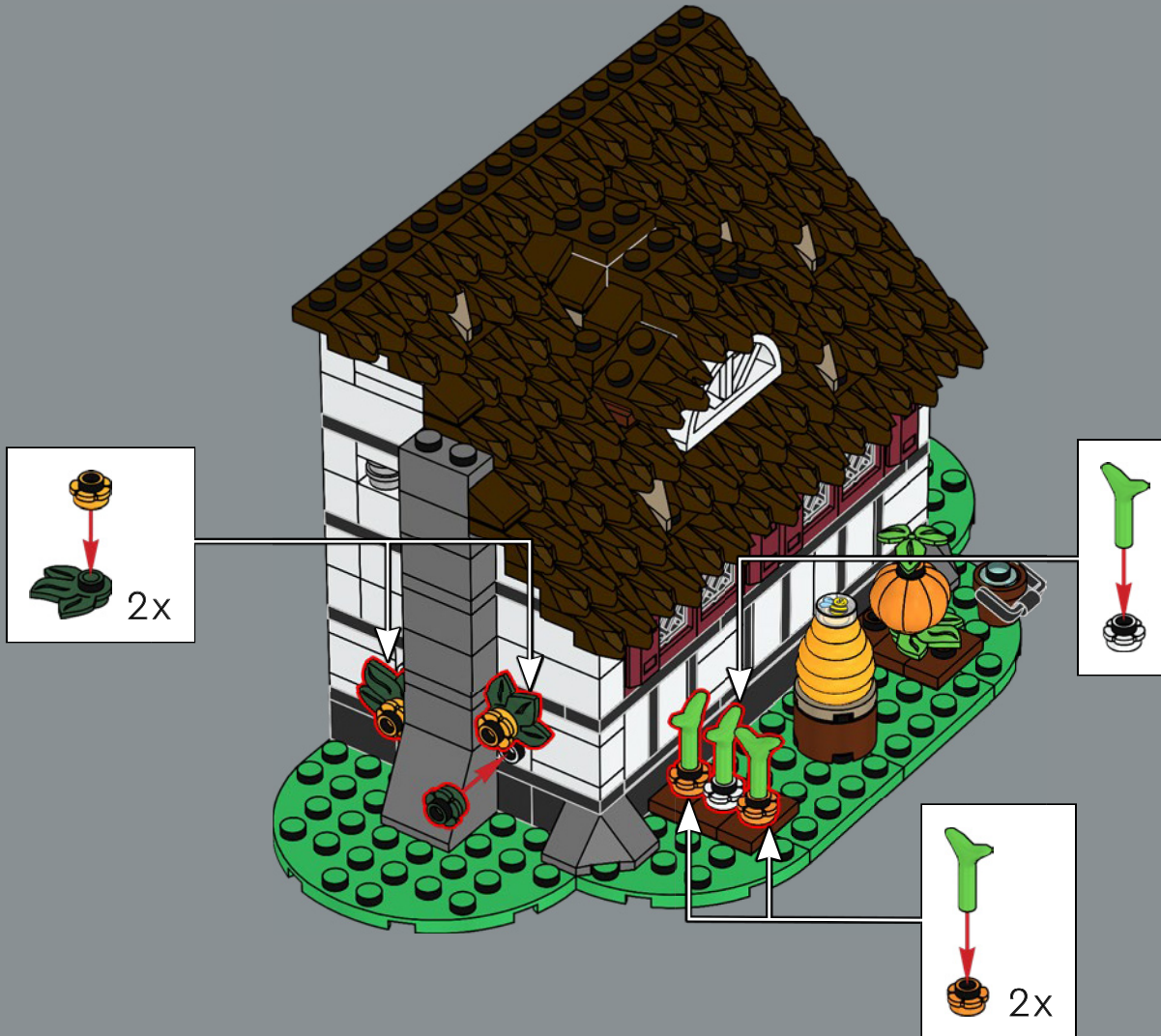

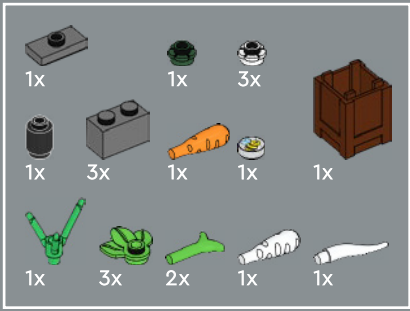

112

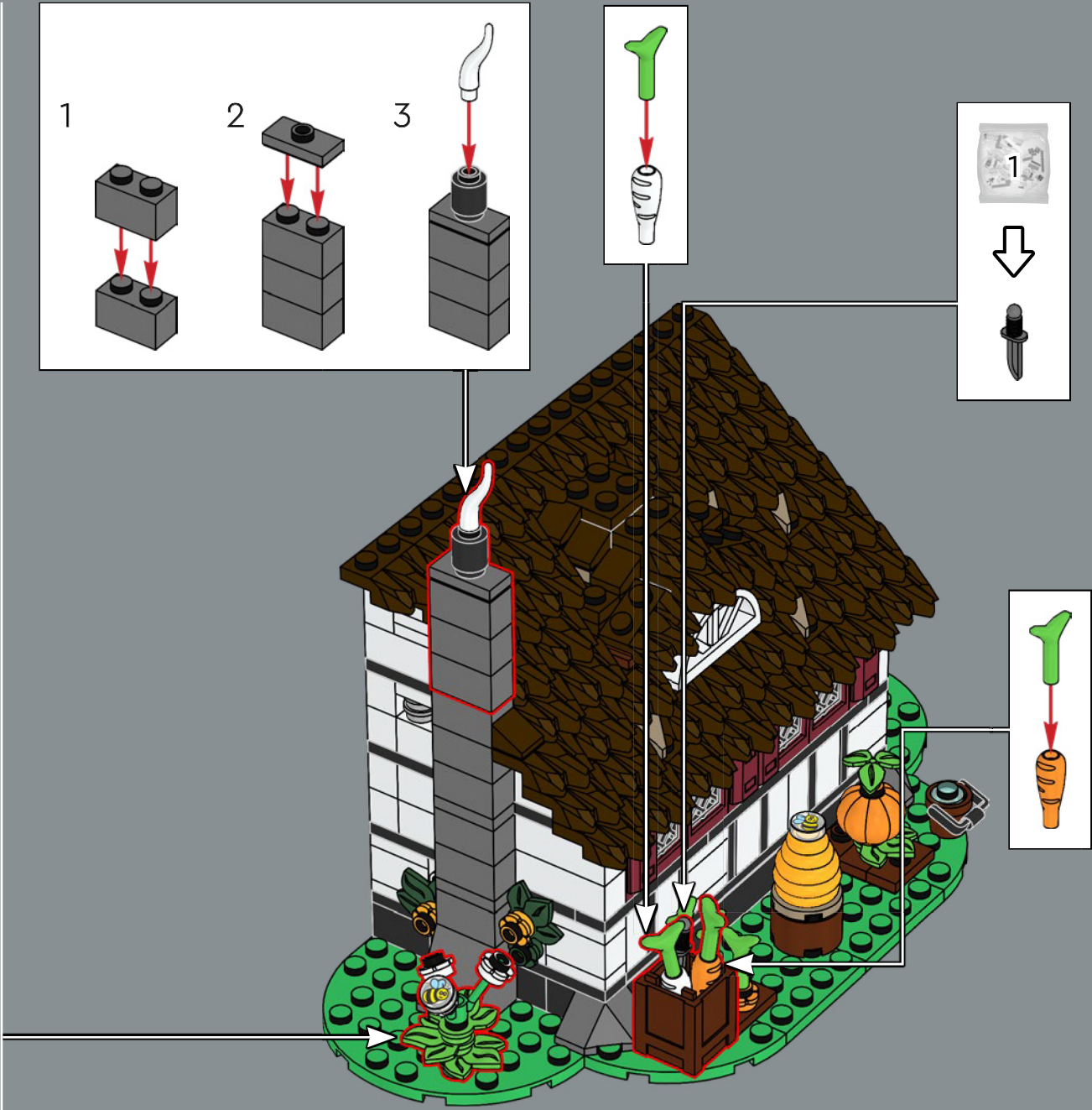
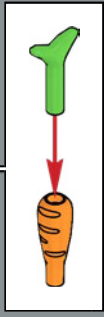
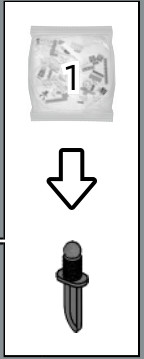
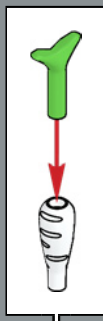
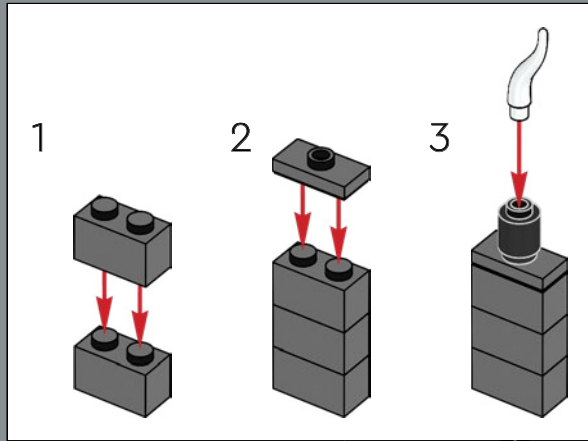
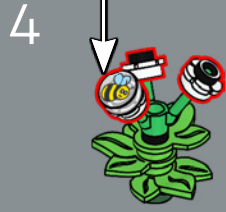
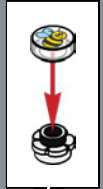
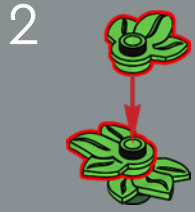
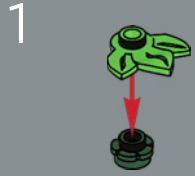

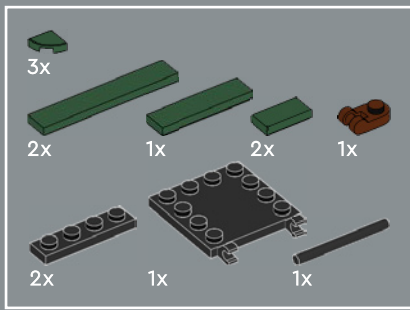

113

1

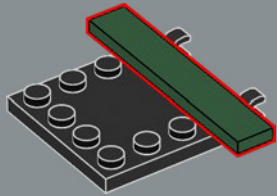

2

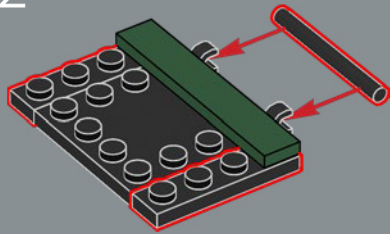

3

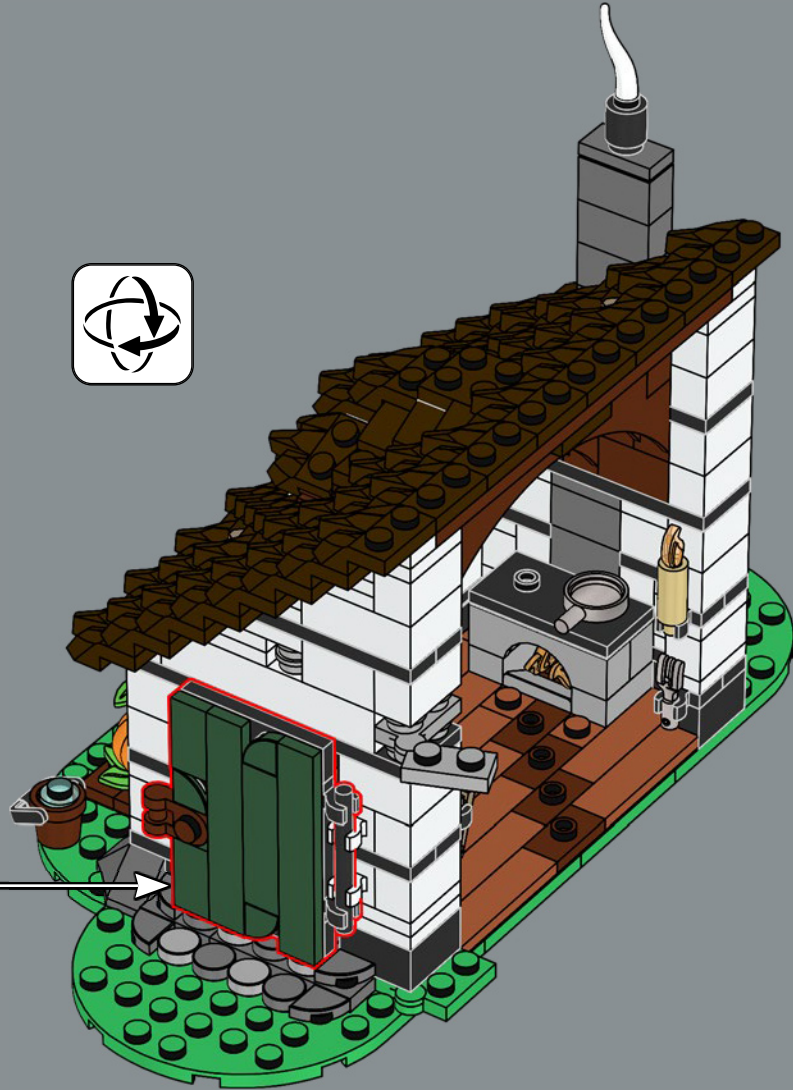
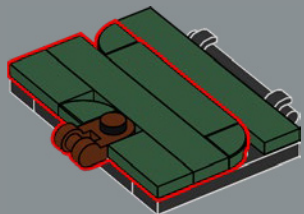

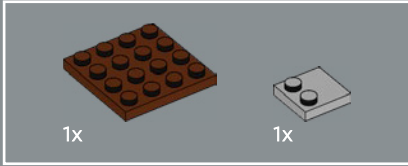

114

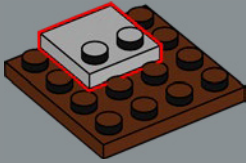

115

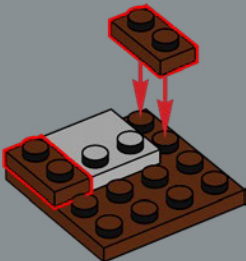

116

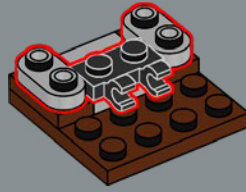

117

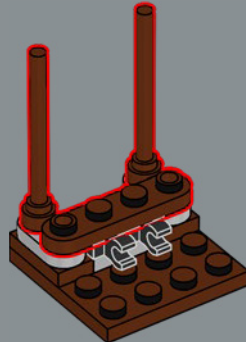



118

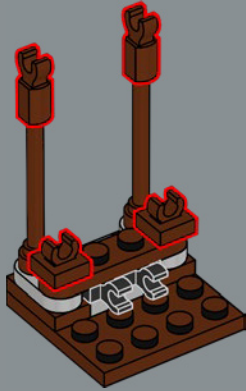

119

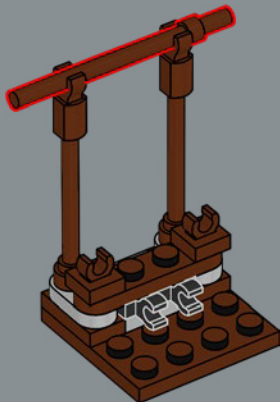

120

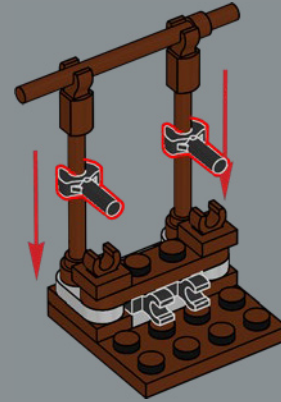

121

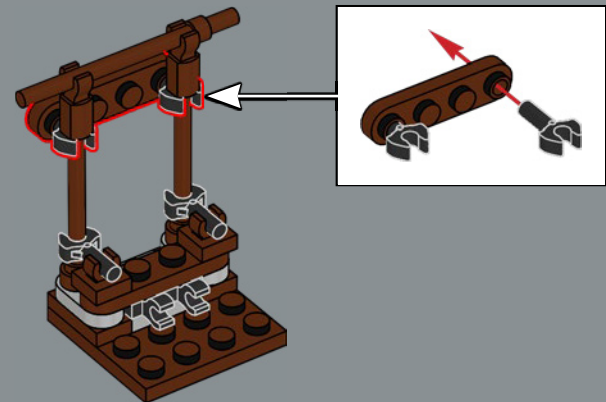



122

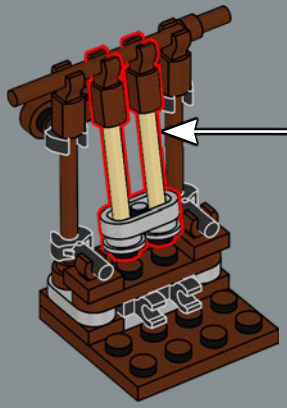
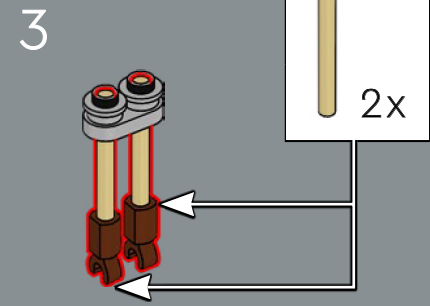
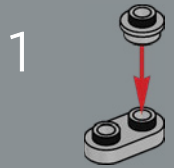





2x



4x

# 123

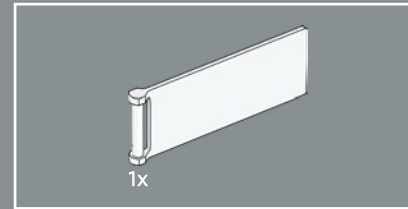
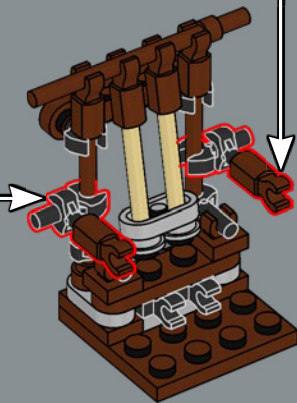
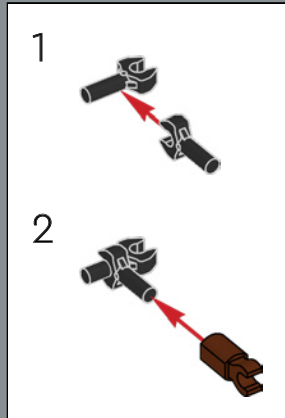
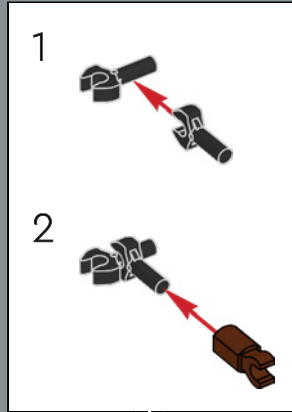

# 124

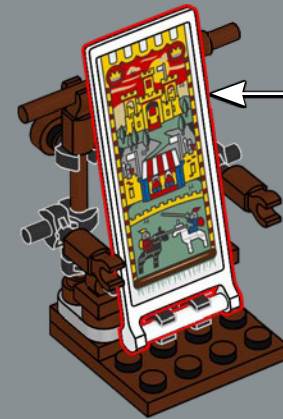
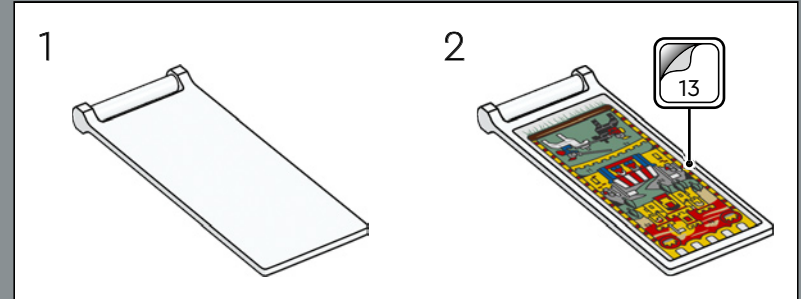



125



126

Cette tapisserie vous dit quelque chose ? Le motif de la dernière création du tapissier est en fait basé sur une scène de tournoi de joutes populaire tirée du modèle de château LEGO® (375) de 1978.

¿Te resulta familiar este tapiz? En realidad, el diseño de la última creación del tapicero se basa en una popular escena de un torneo de justas del modelo LEGO® Yellow Castle (375) de 1978.

Does this tapestry look familiar? The motif in the Tapestry-maker's latest design is actually based on a popular jousting tournament scene from the 1978 LEGO® model 375 Castle.



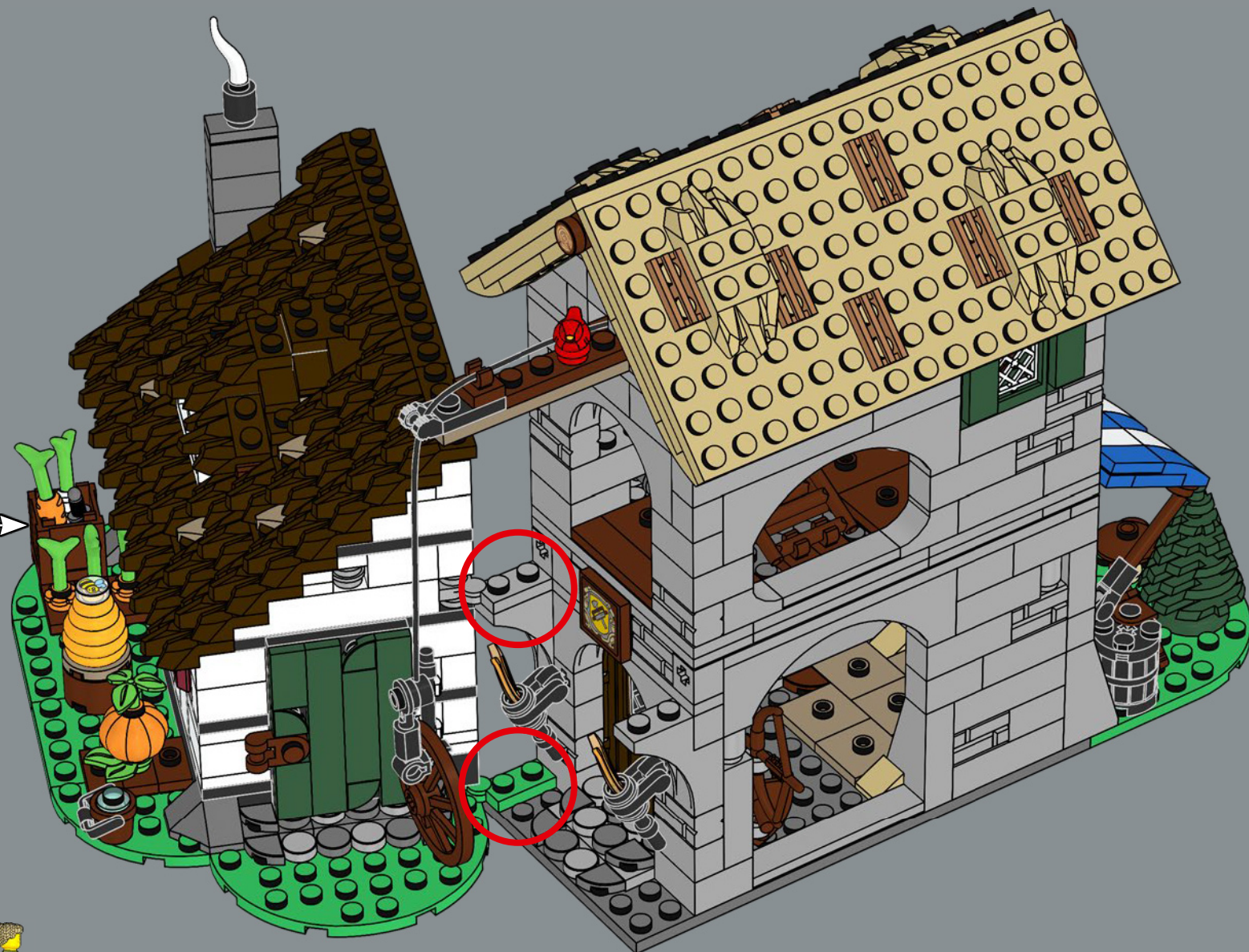

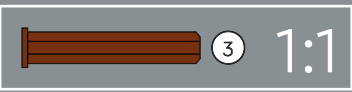
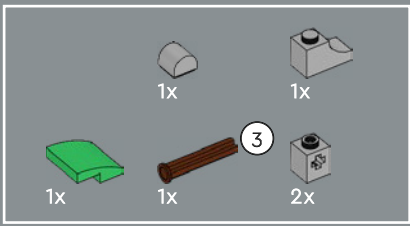

128

1

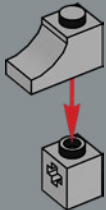

2

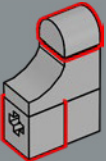

3

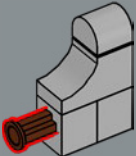

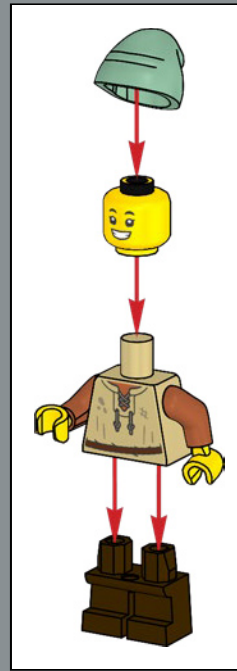
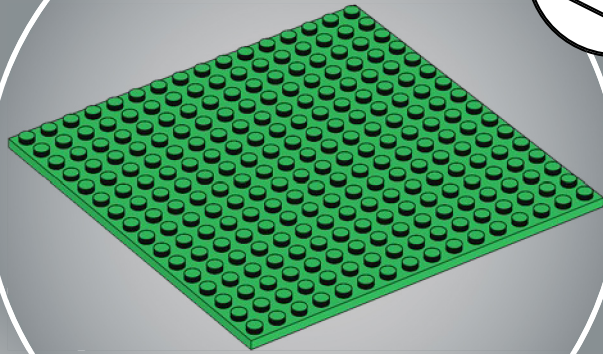
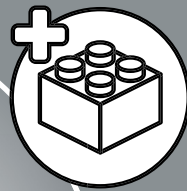

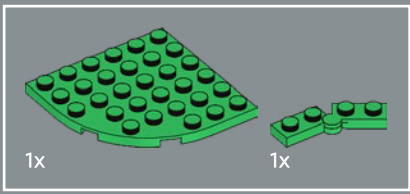

129

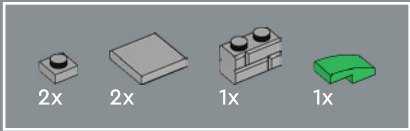
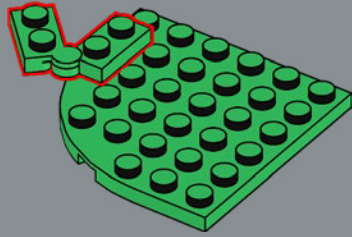

130

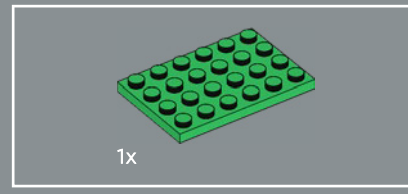
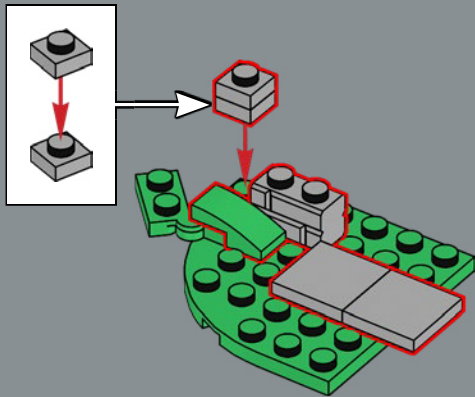

131

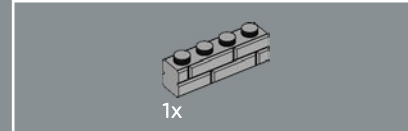
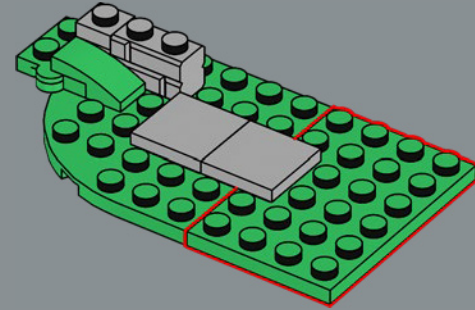

132

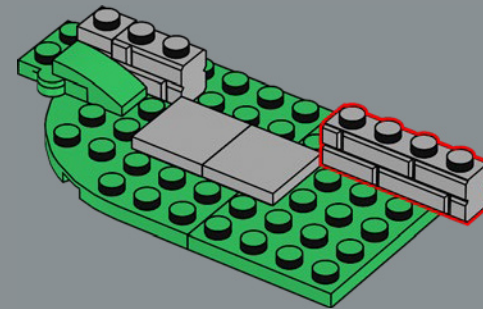

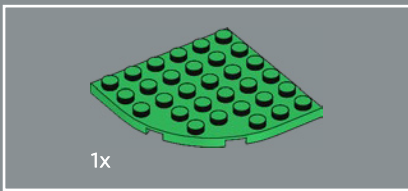

133

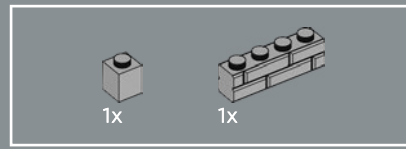
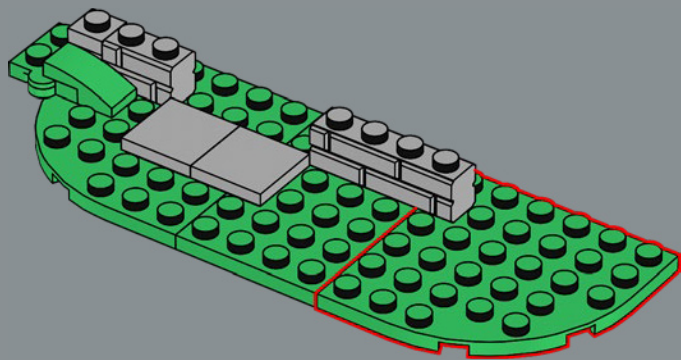

134

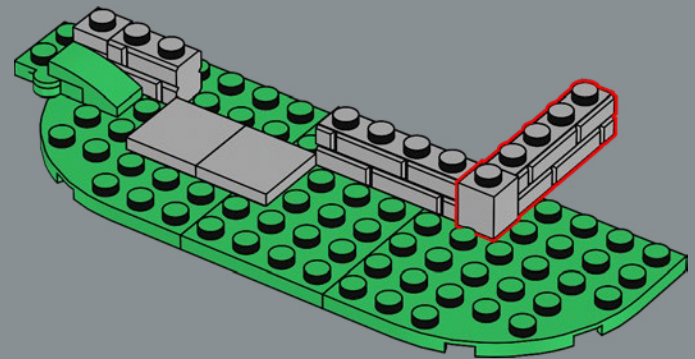

135

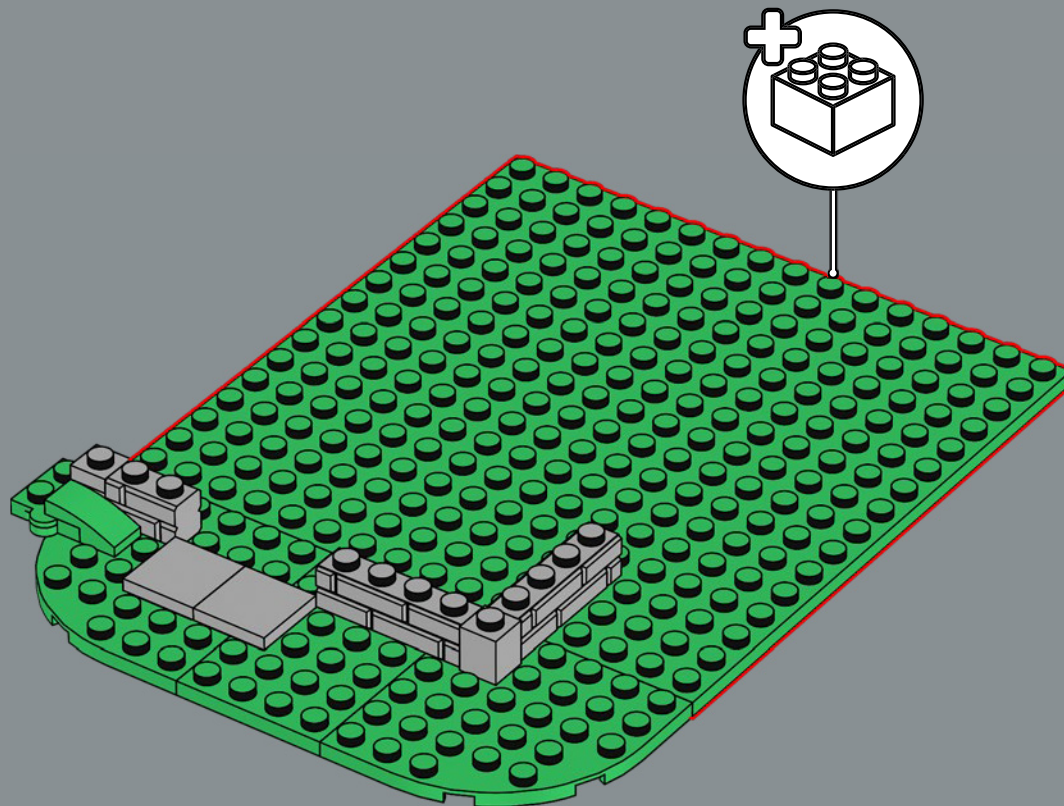



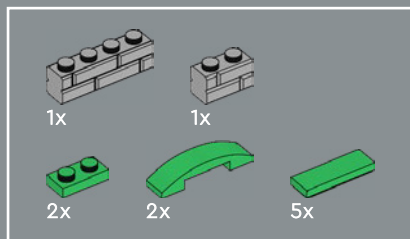

136

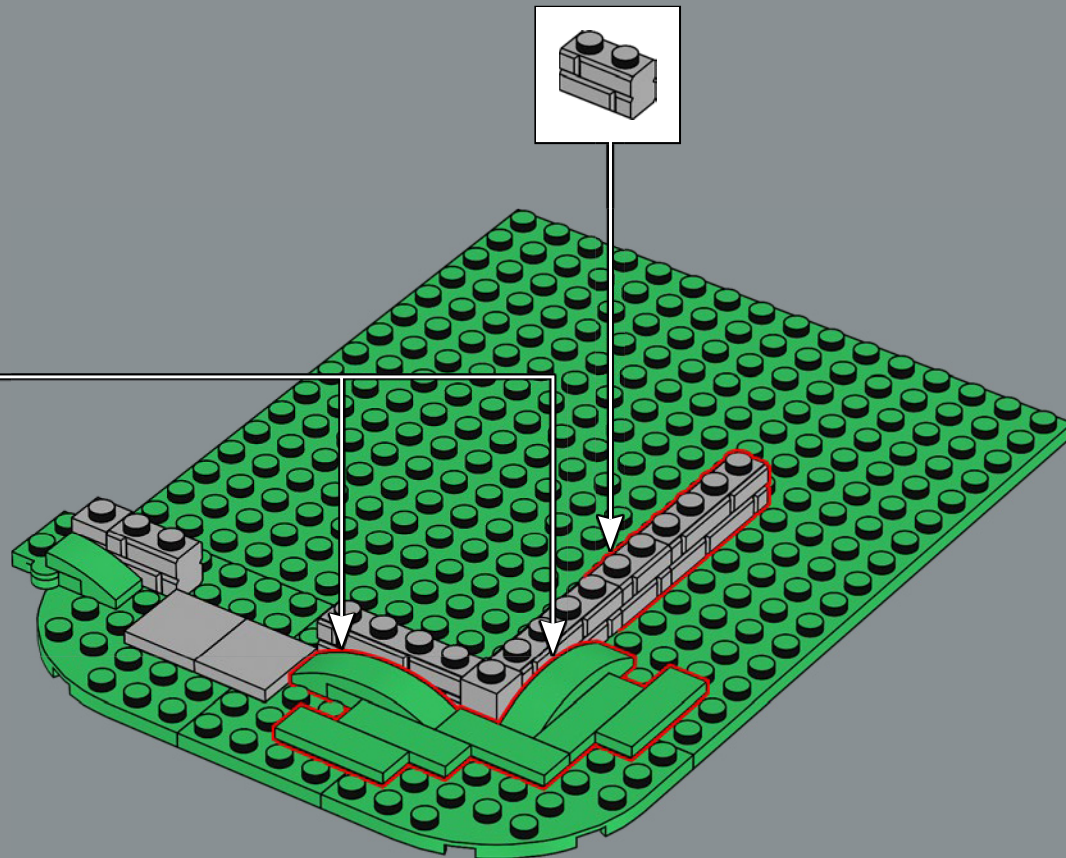
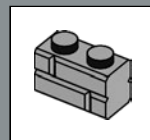
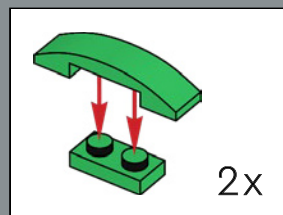

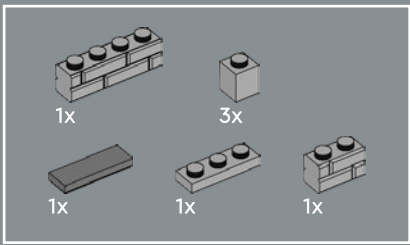

137

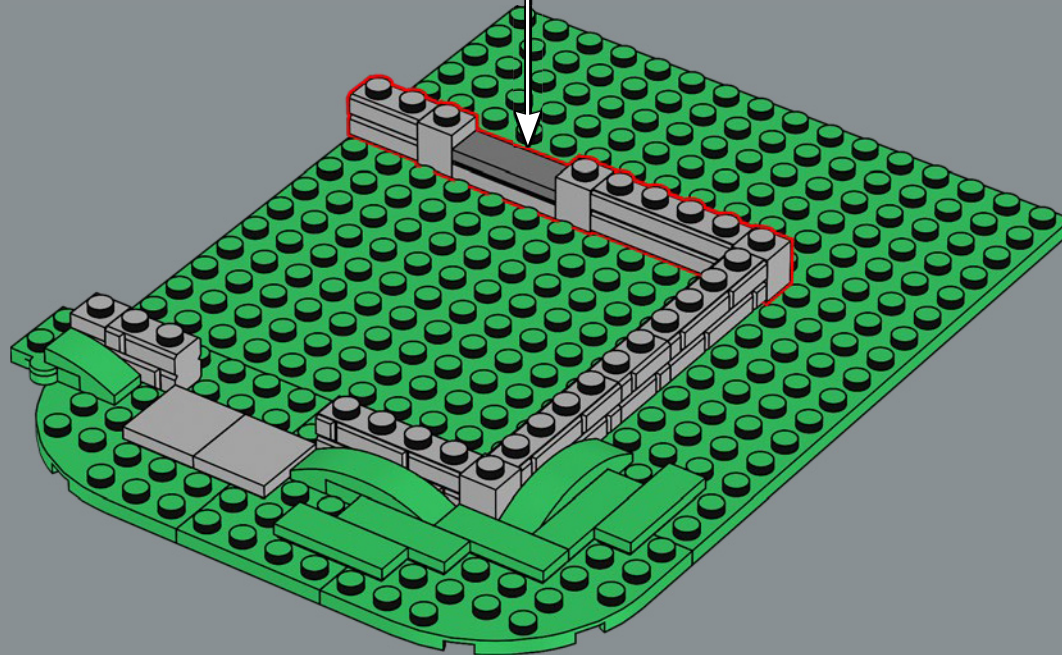
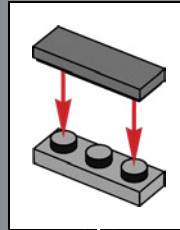

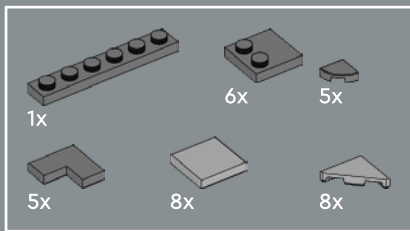

138

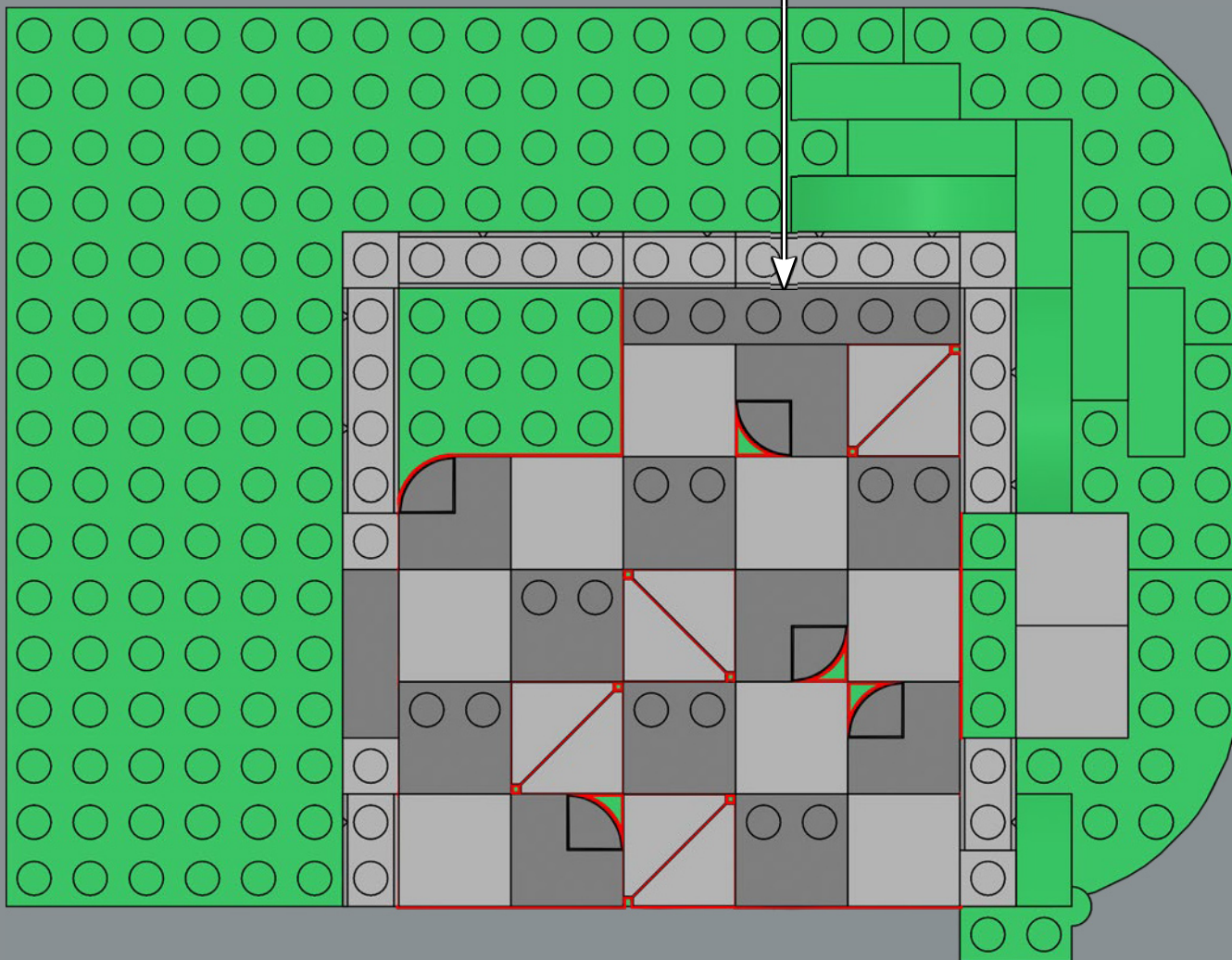
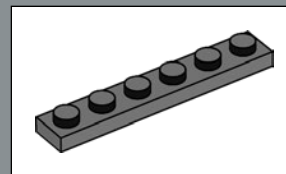

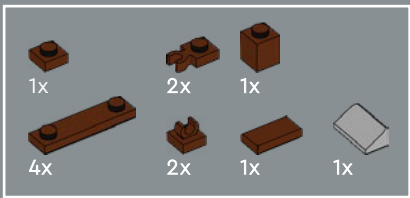

139

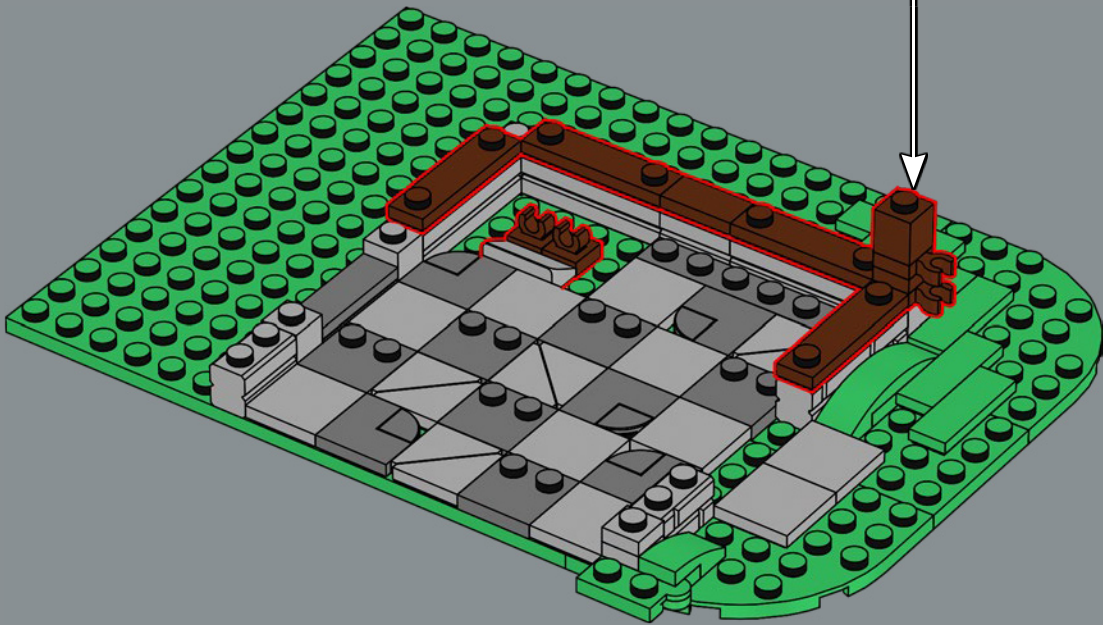
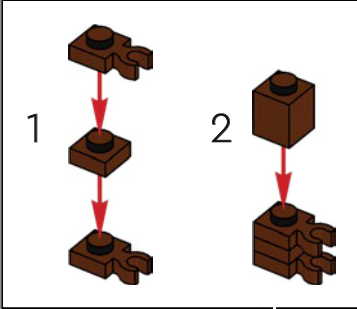



140

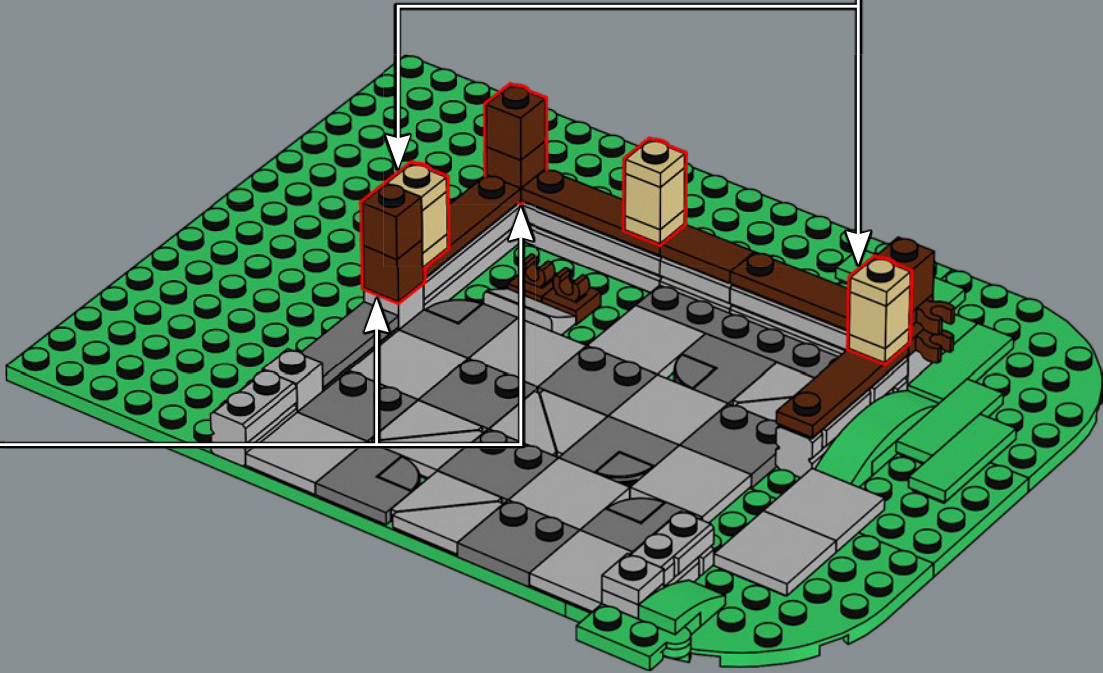
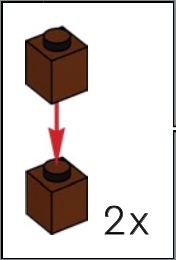
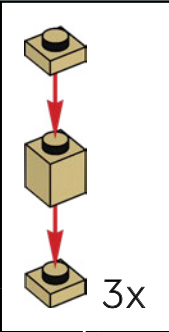

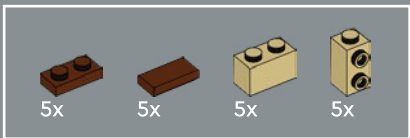

141

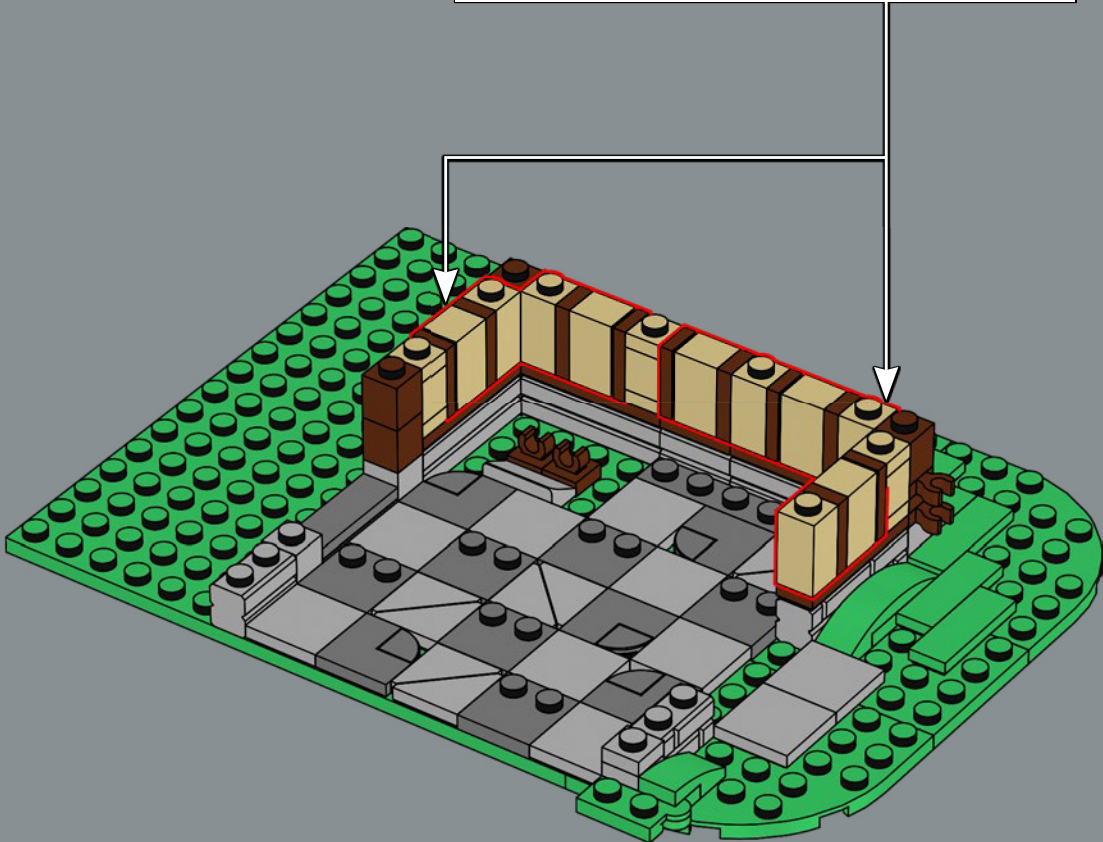
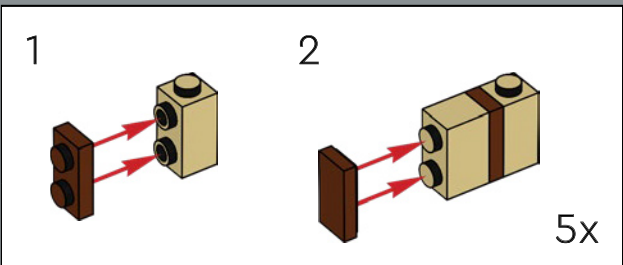

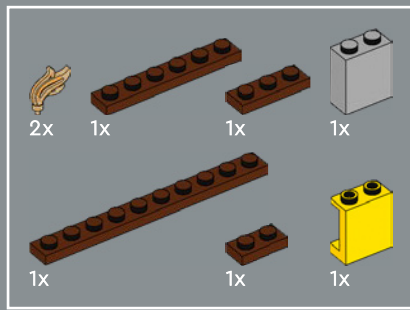

142

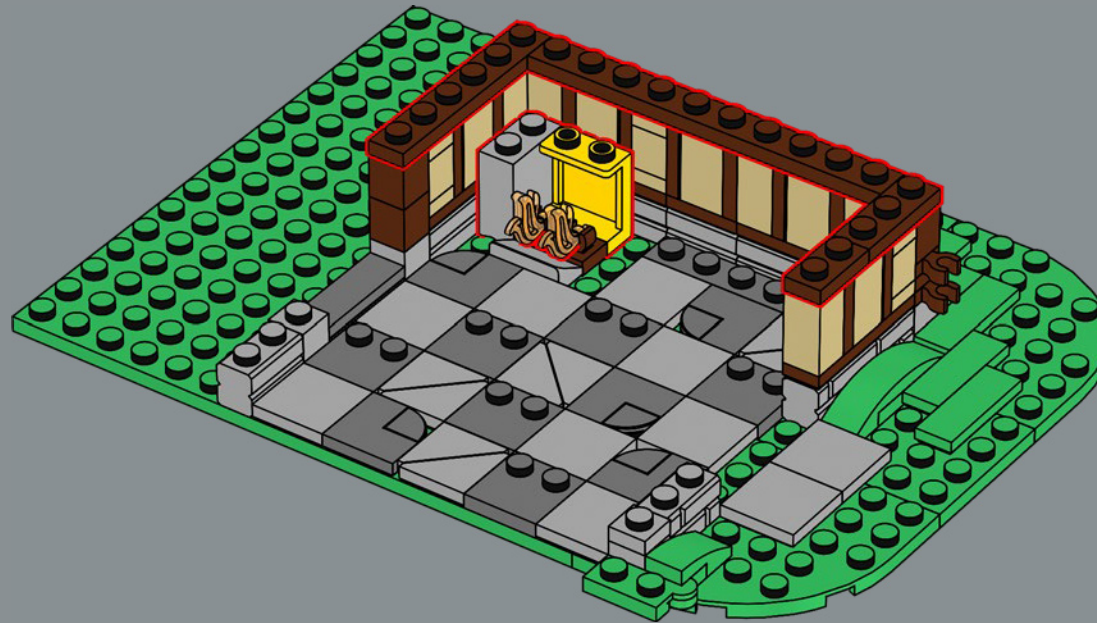

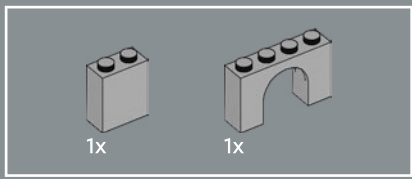

143

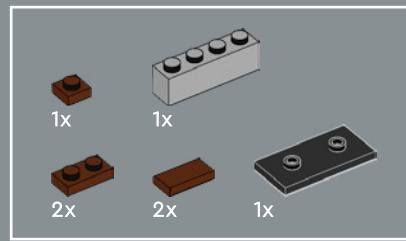
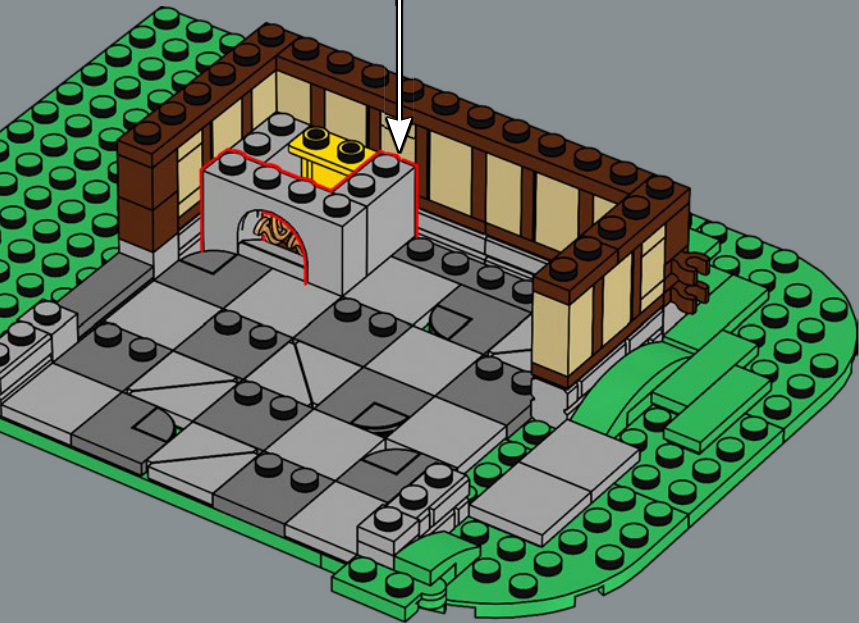
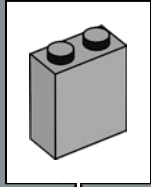

144

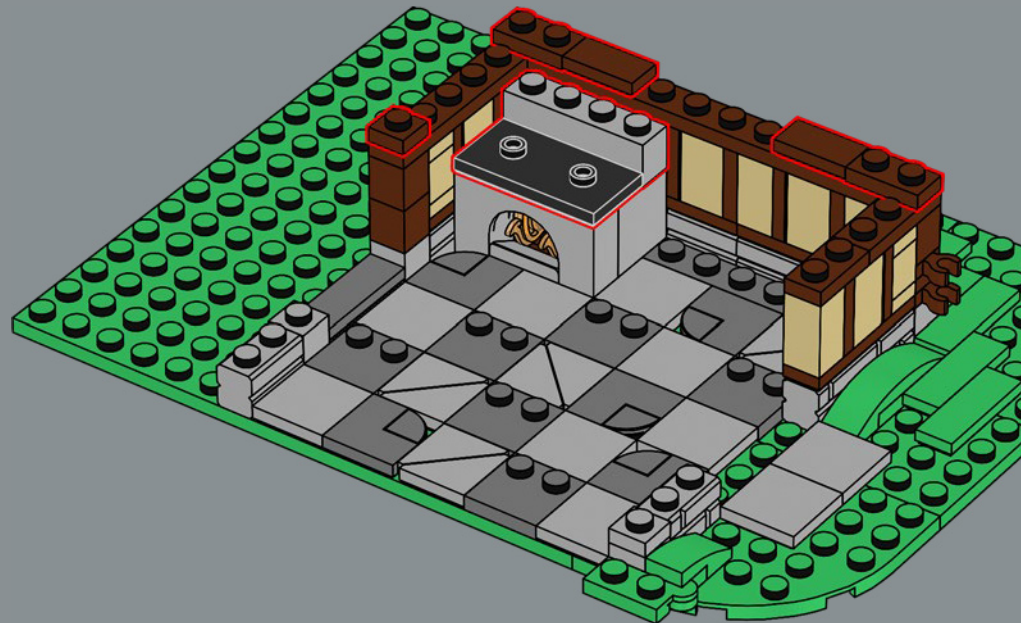



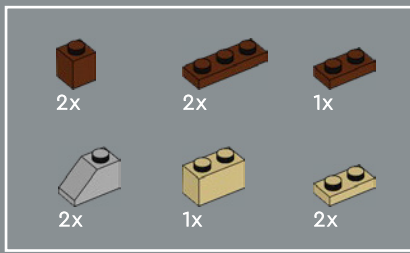

145

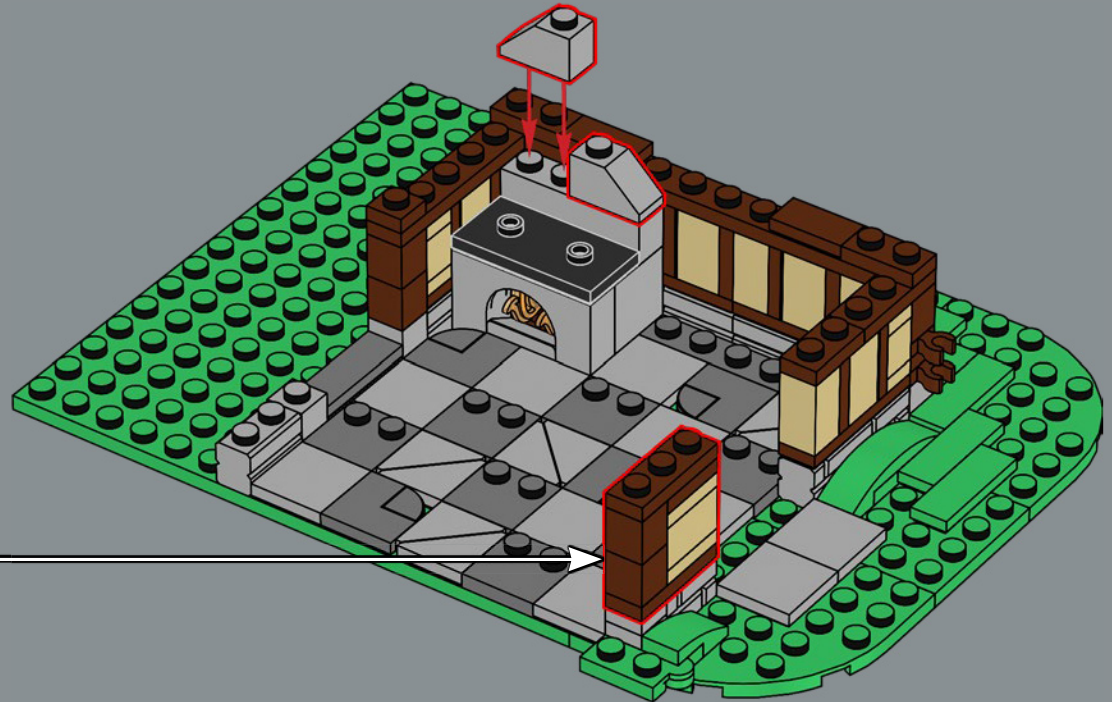
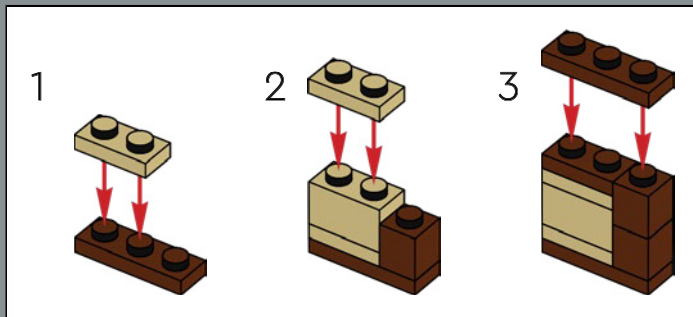

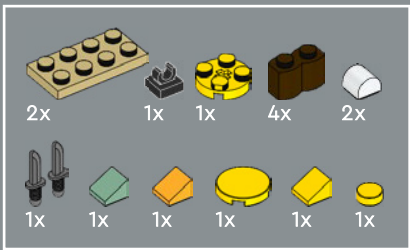

146

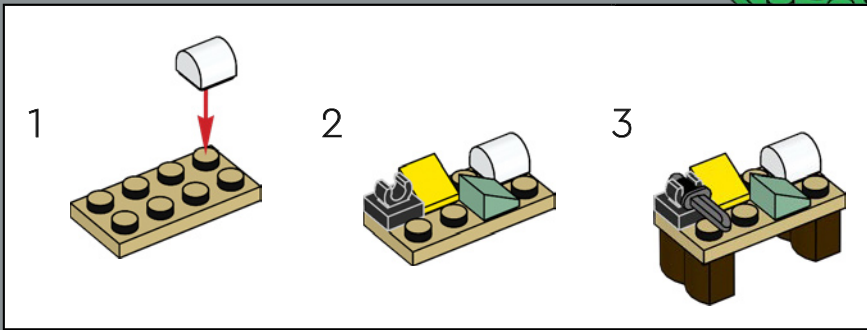
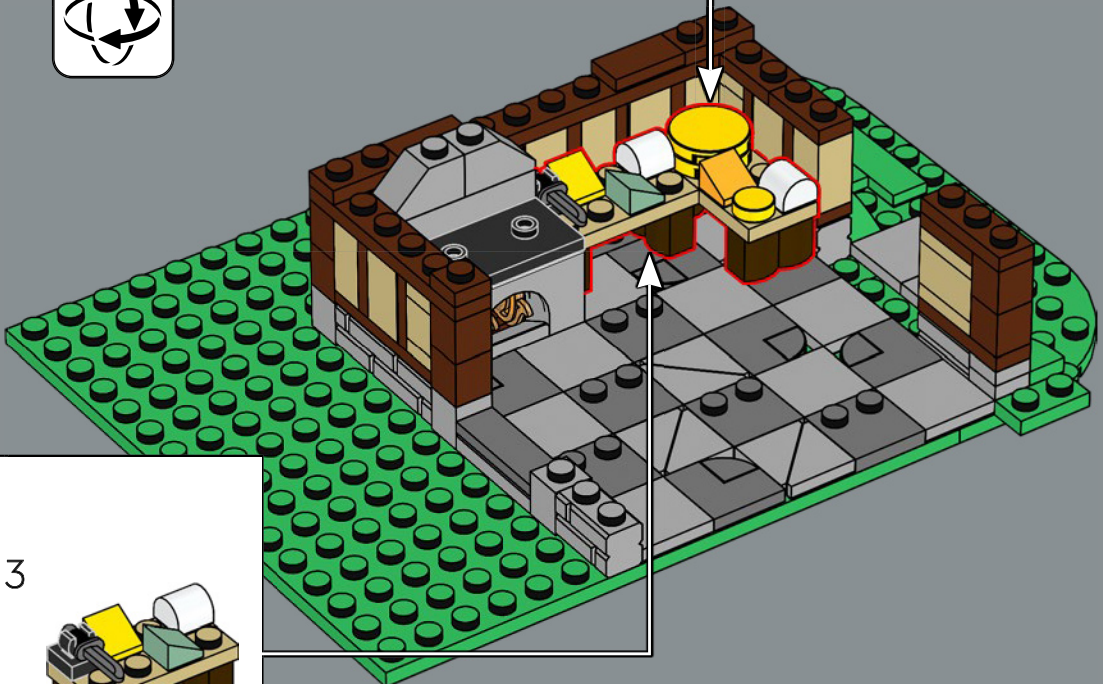
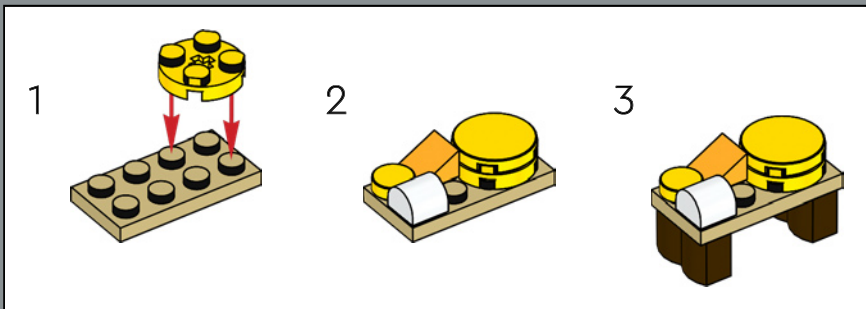

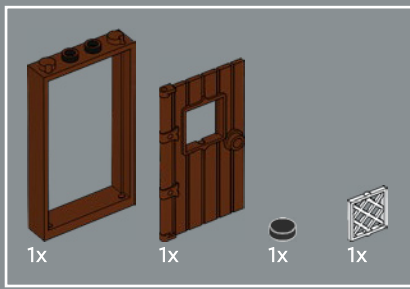

147

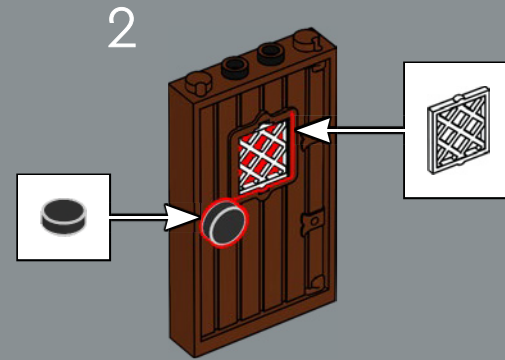
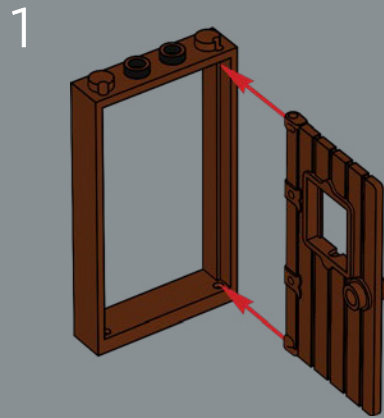

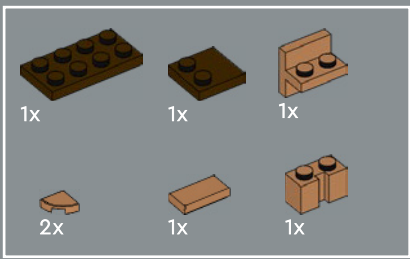

148

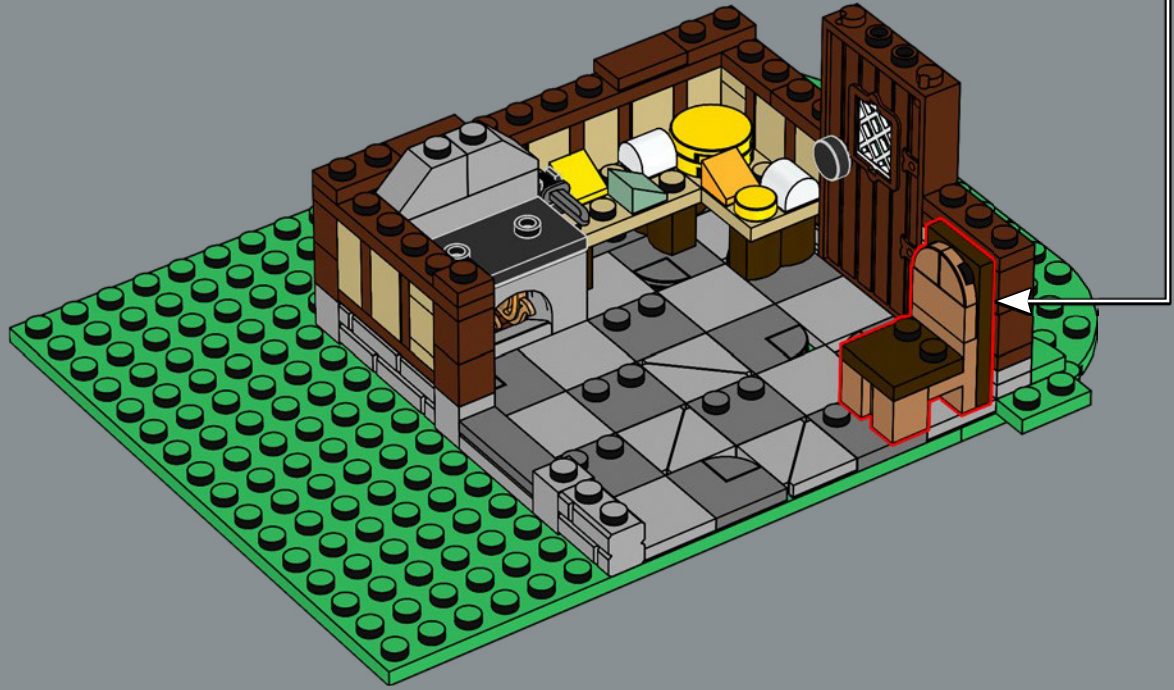
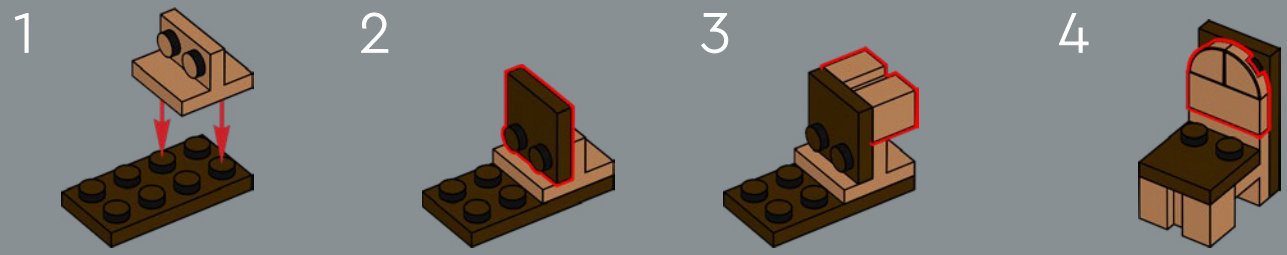

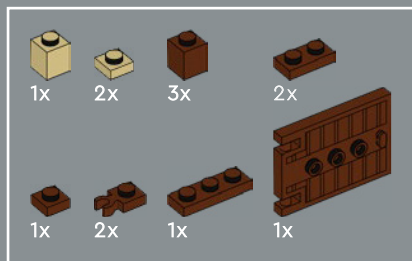

149

1

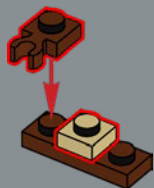

2

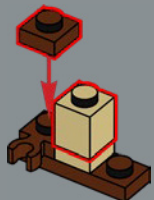

3

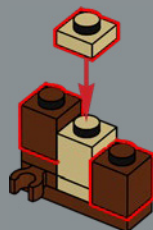

4

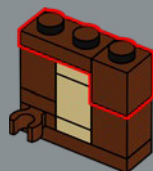

5

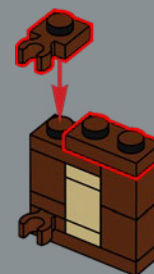

6

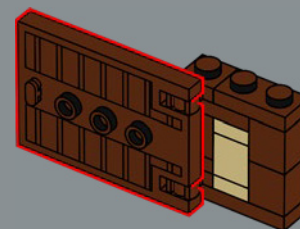

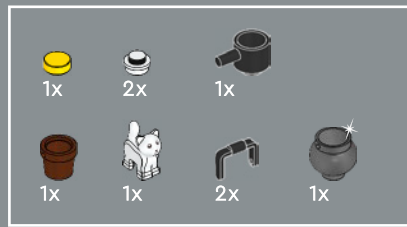

150

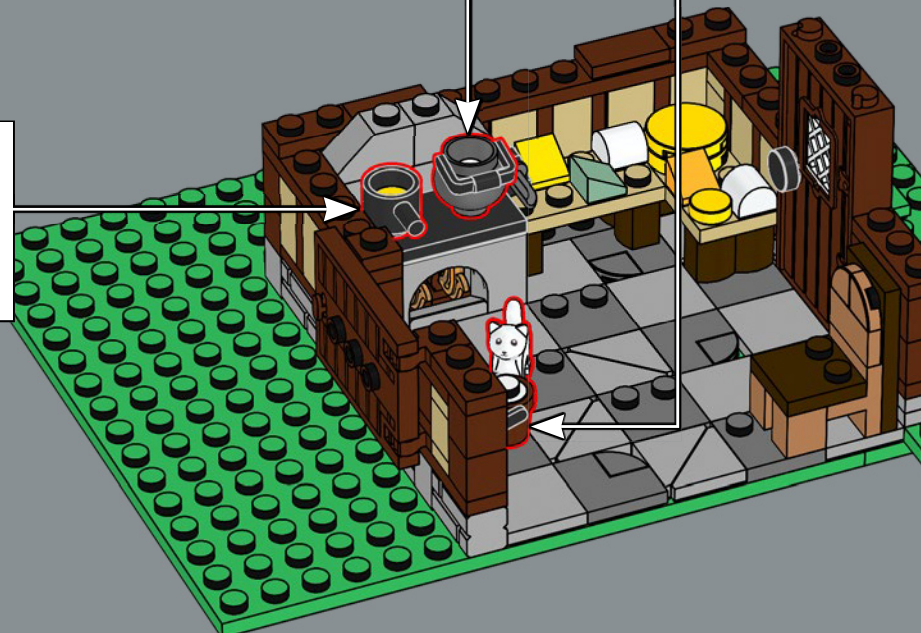
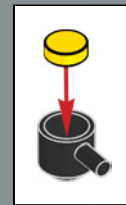
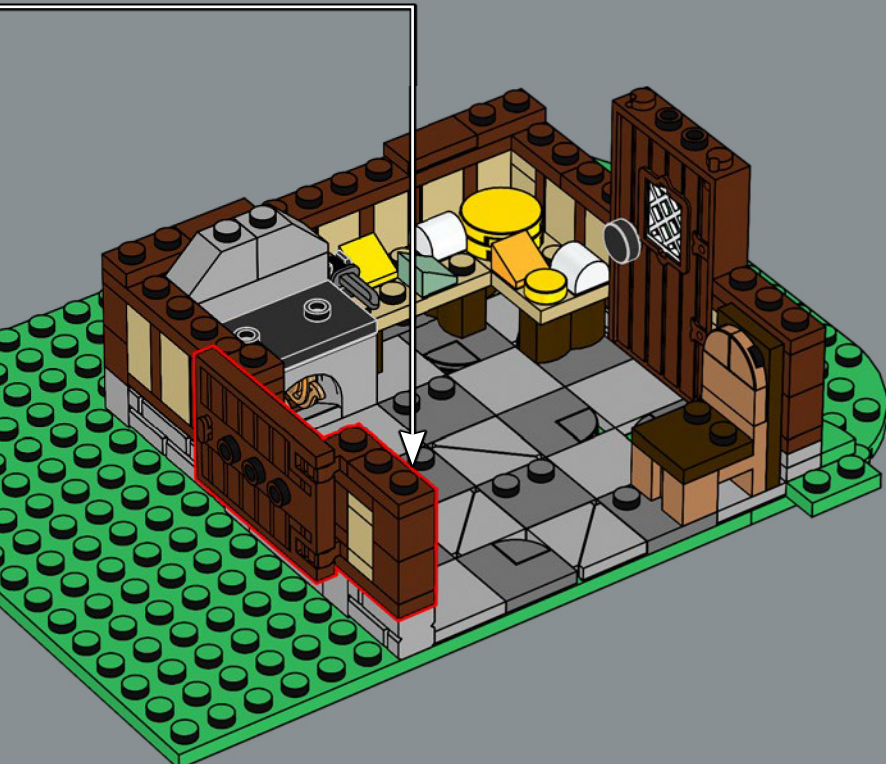
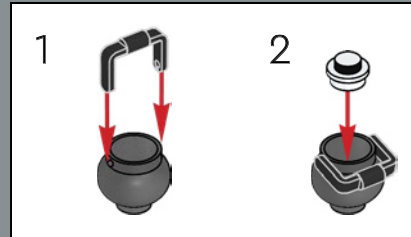
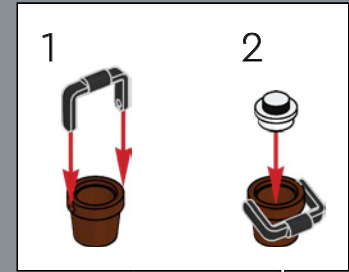

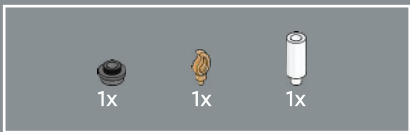

151

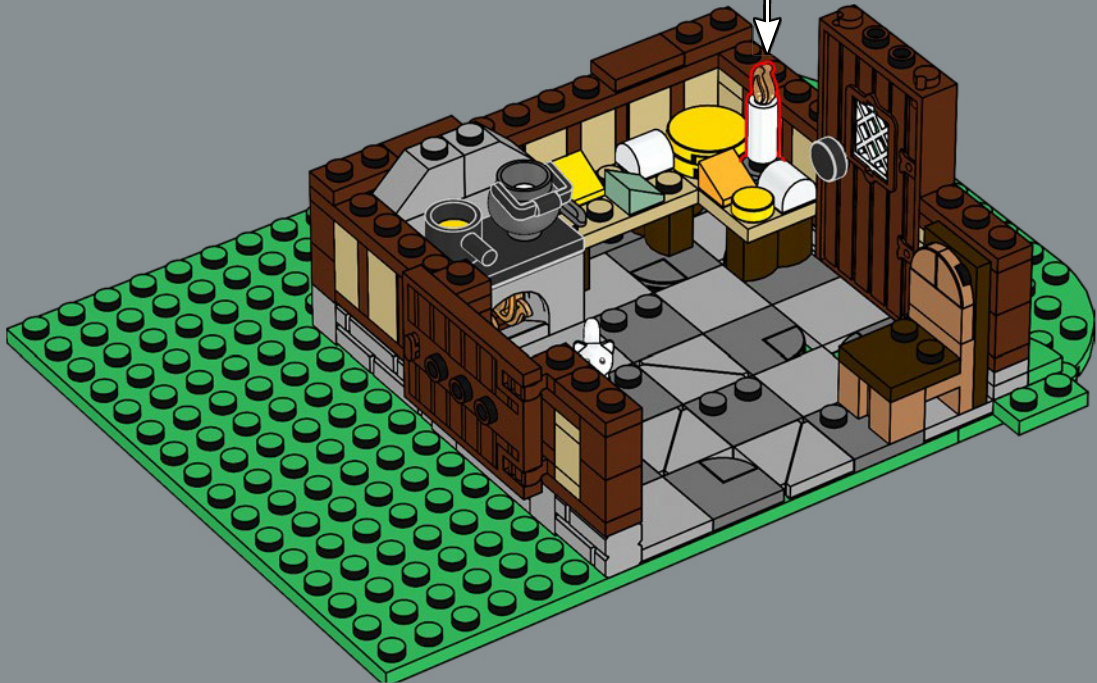
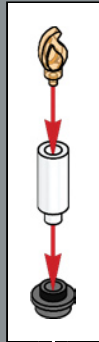

The cat fills a very important role in keeping the village free from mice and other pesky rodents. It seems only fair it should receive a little milk for its efforts.

Le chat joue un rôle très important dans la protection du village contre les souris et autres rongeurs nuisibles. Il semble normal qu'il reçoive un peu de lait pour ses efforts.

El gato desempeña un papel muy importante para mantener la aldea libre de ratones y otras molestas plagas. Parece justo que reciba un poco de leche por su esfuerzo.



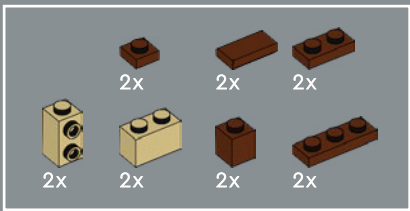

152

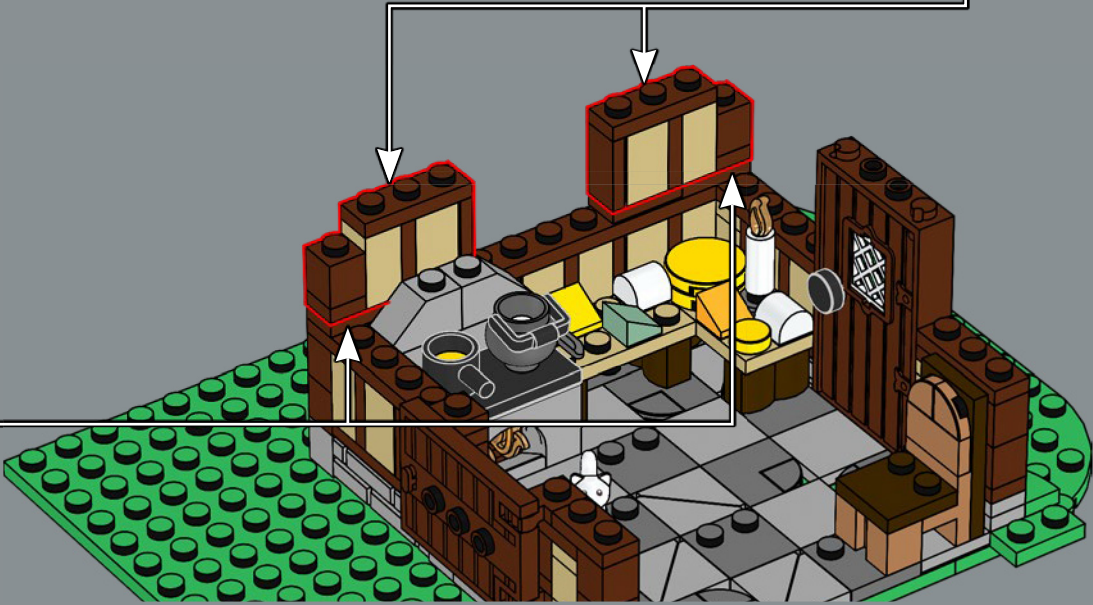
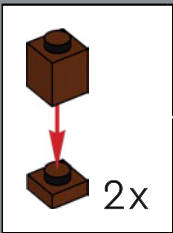
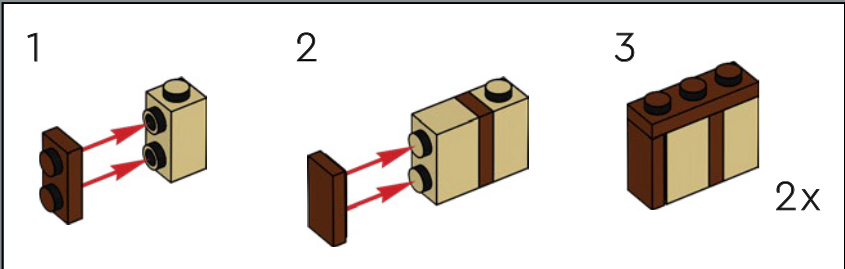



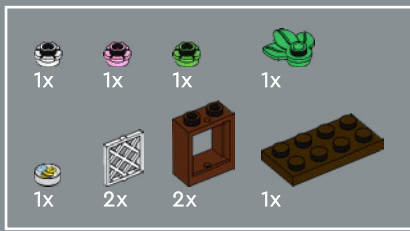

153

1

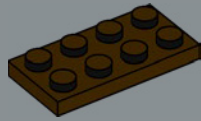

2

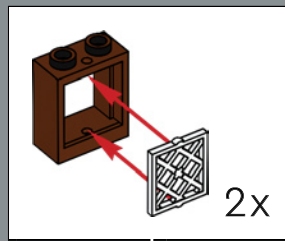
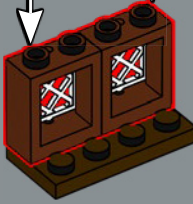

3

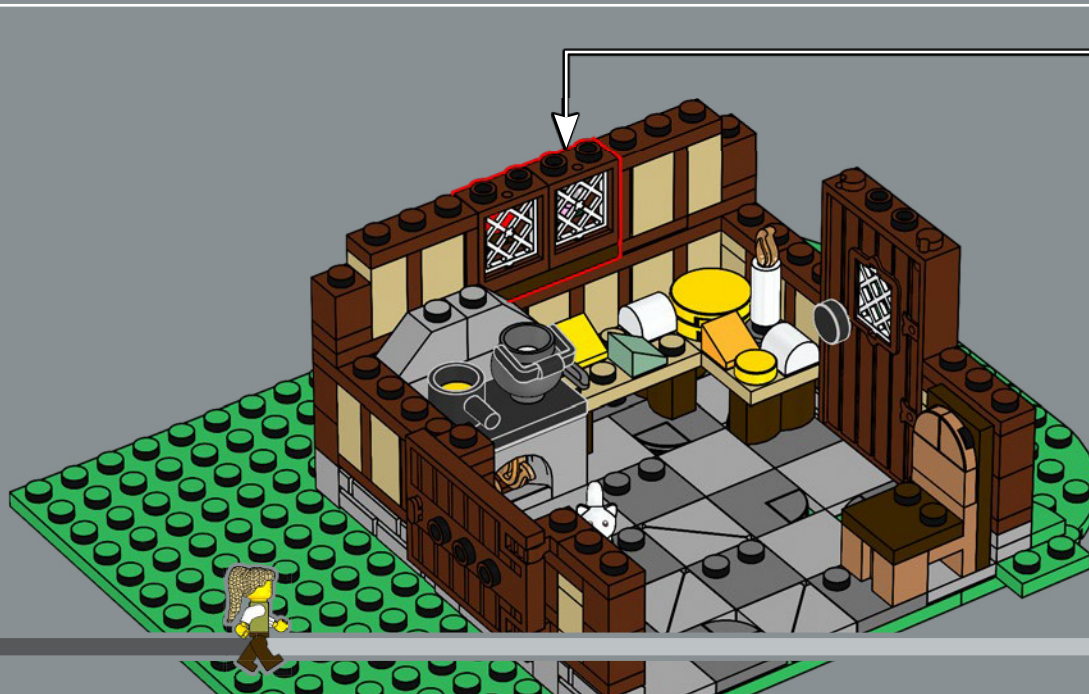
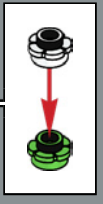
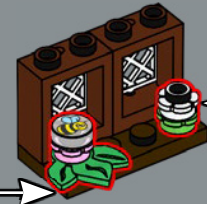
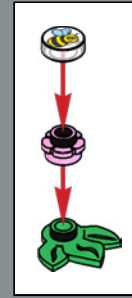

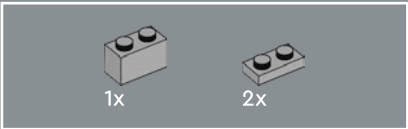

154

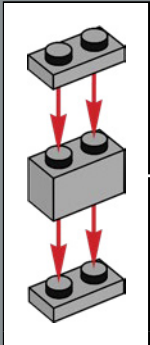

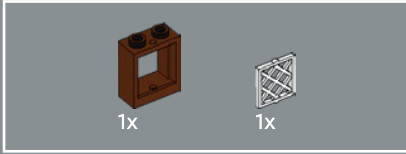

155

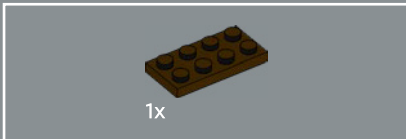
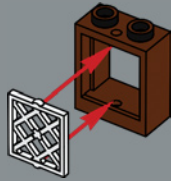

156

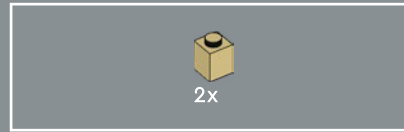
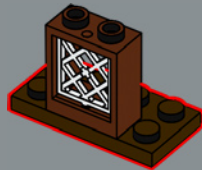

157

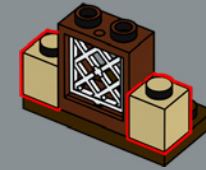

158

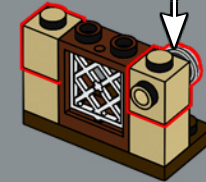
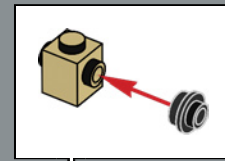

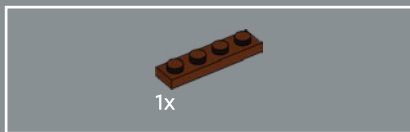

159

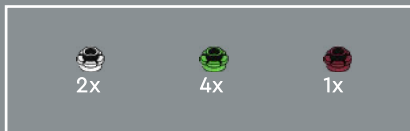
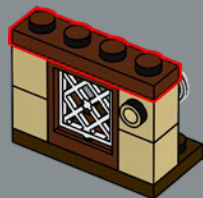

160

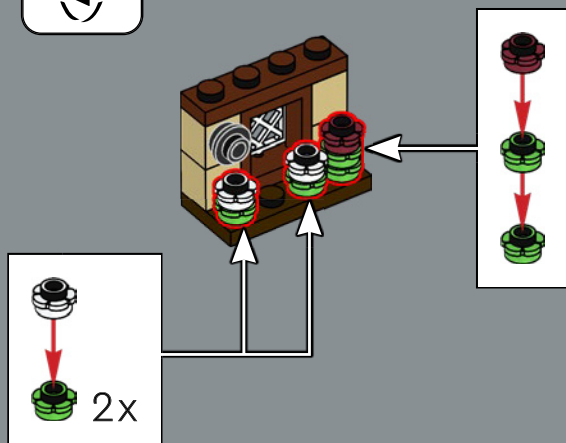

161

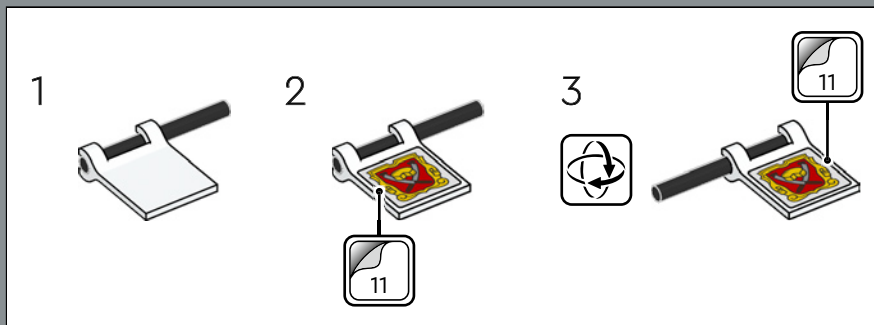



1x



1x

162

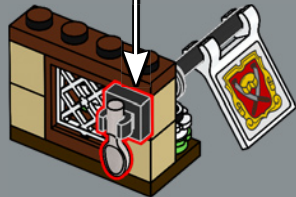
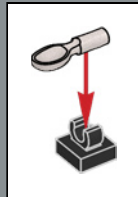

163

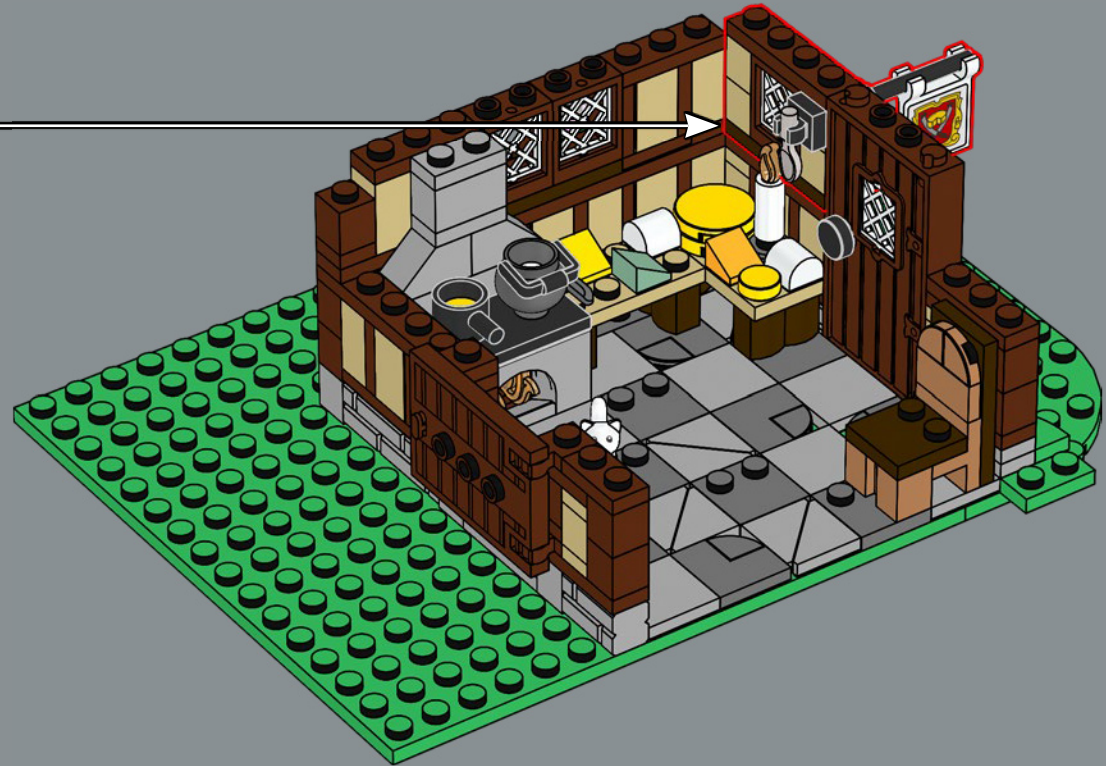

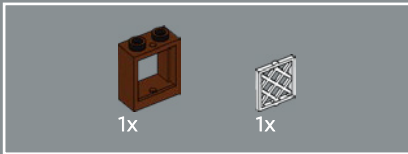
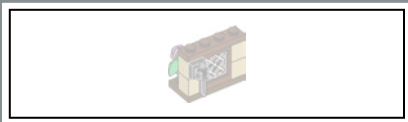

164

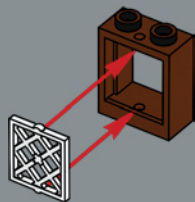

165

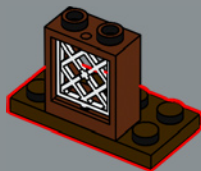

166

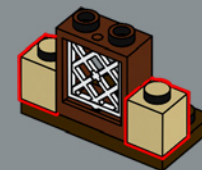

167

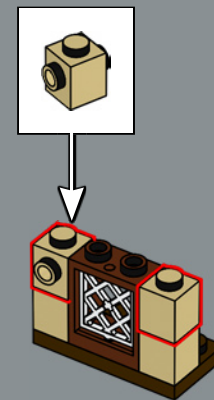

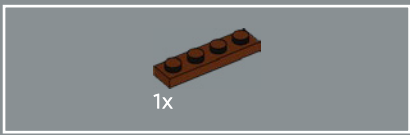

168

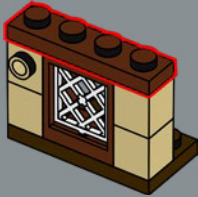

169

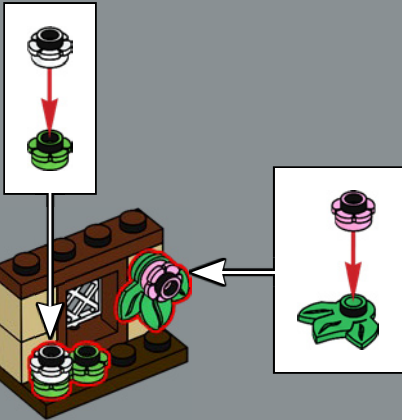

170

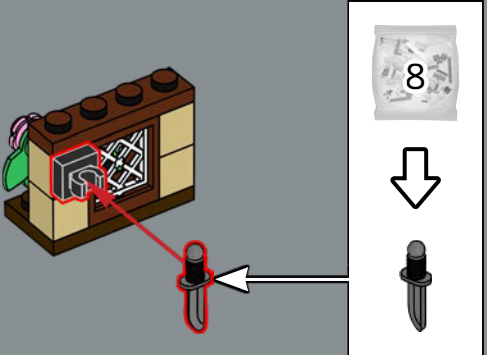

171

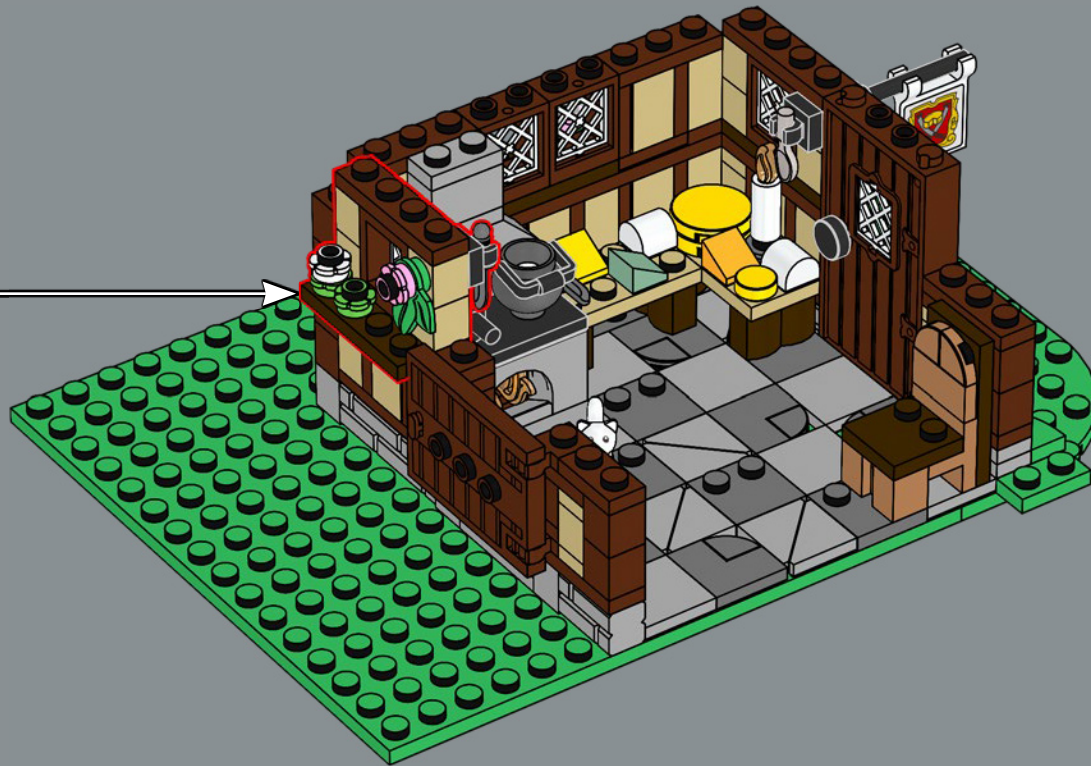



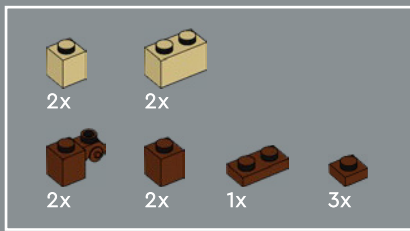

172



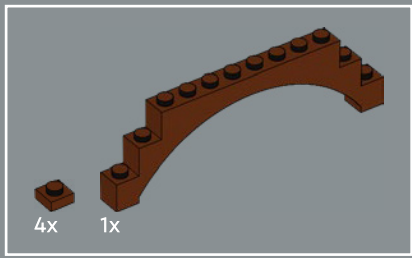

173

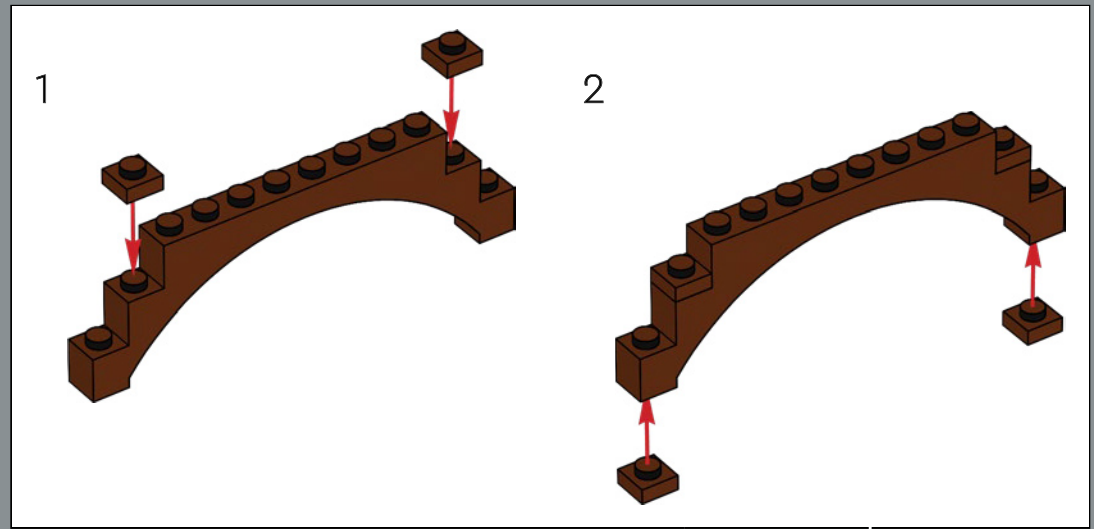

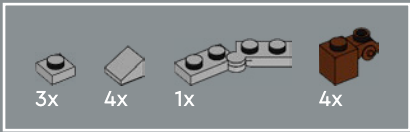

174

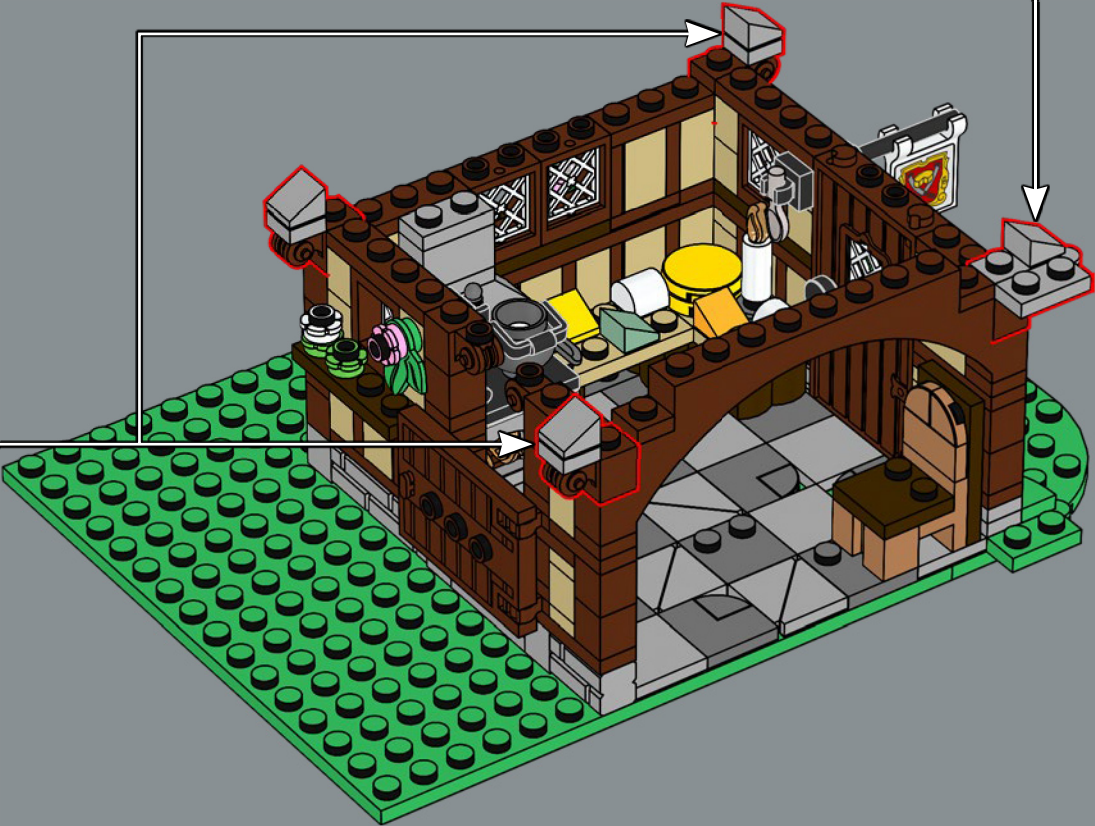
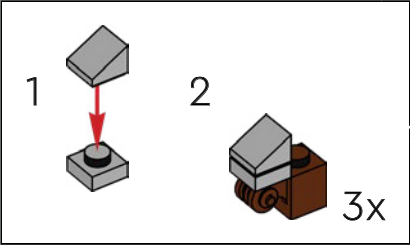
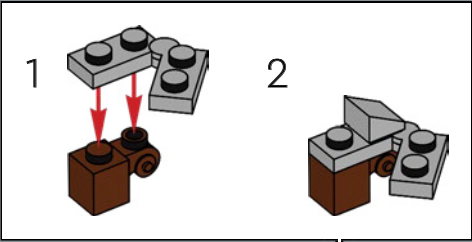

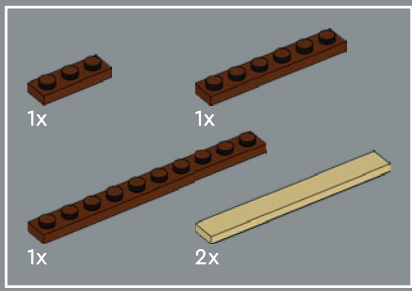

175

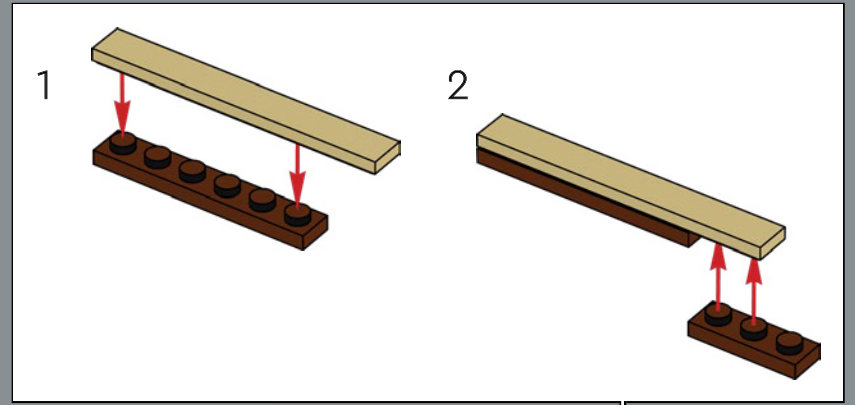
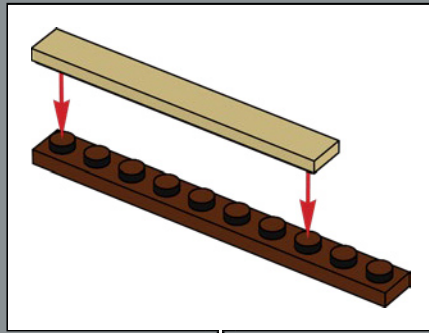

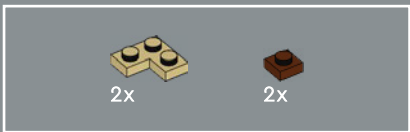

176





177



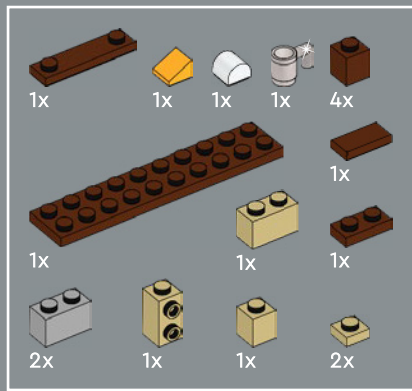

178

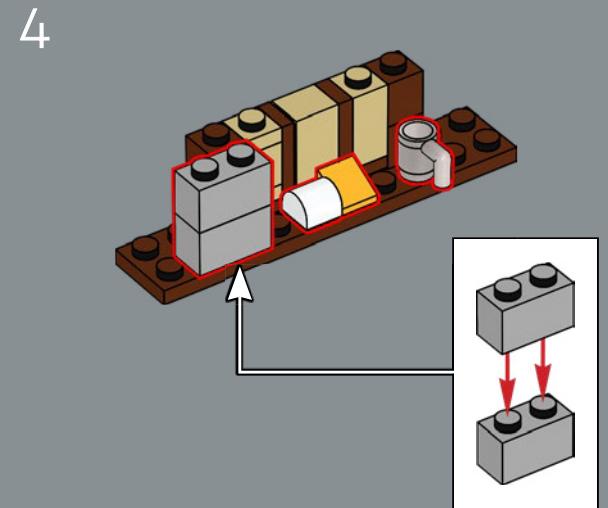
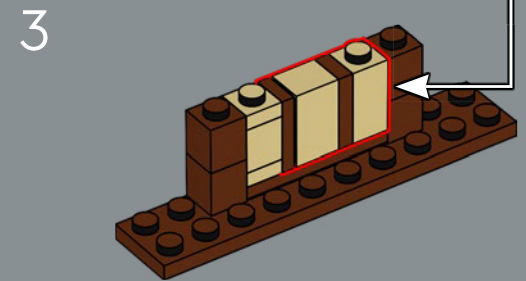
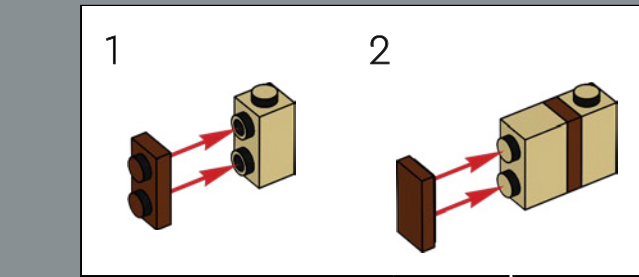
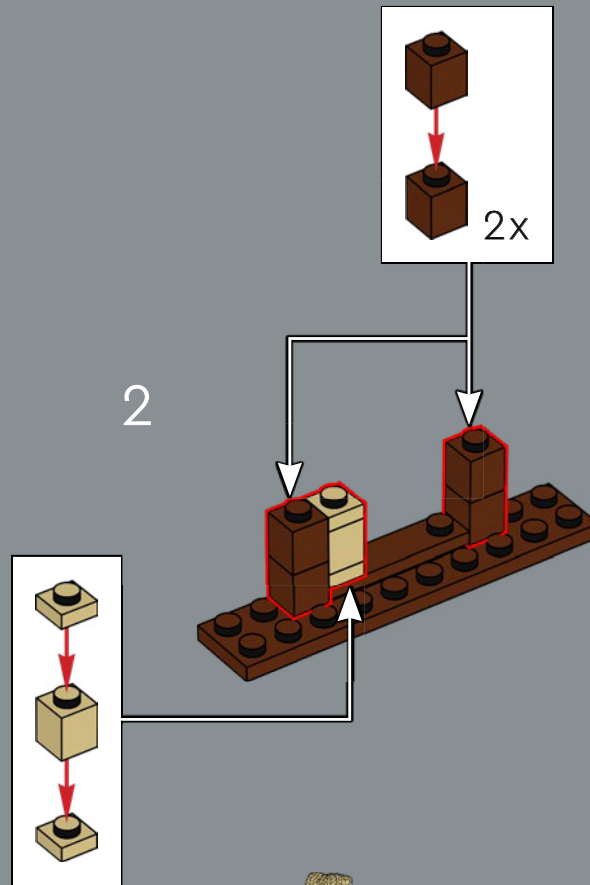
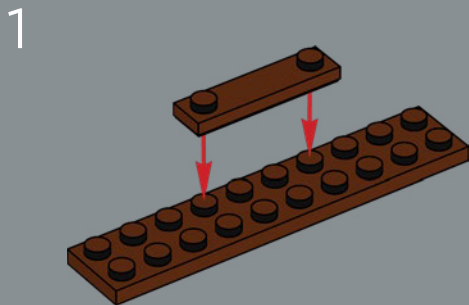

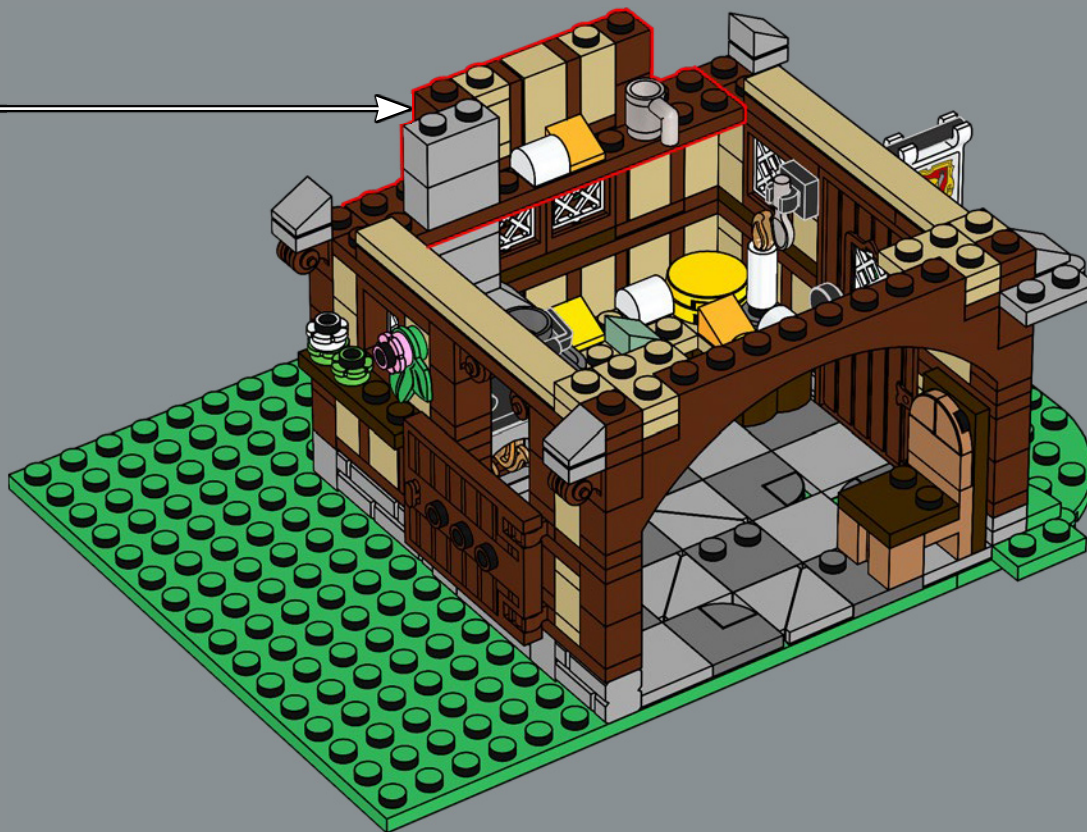



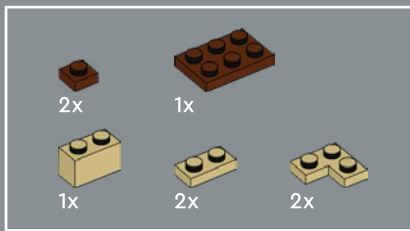

179

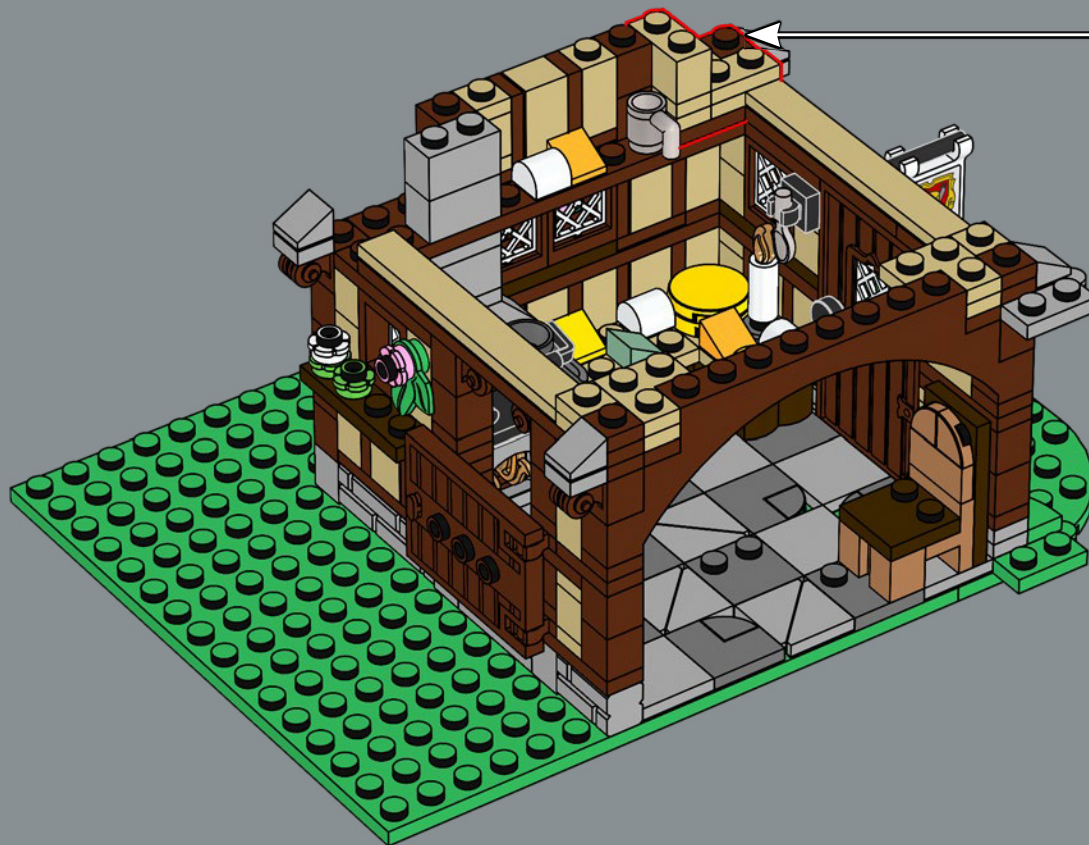
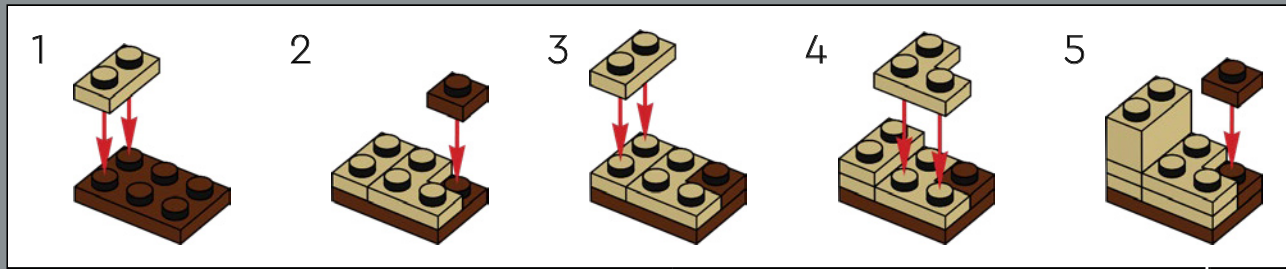

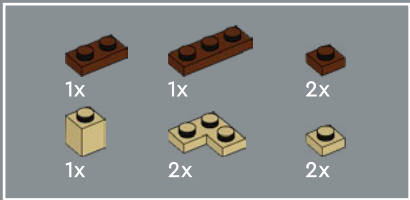

180



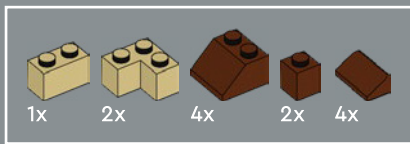

181

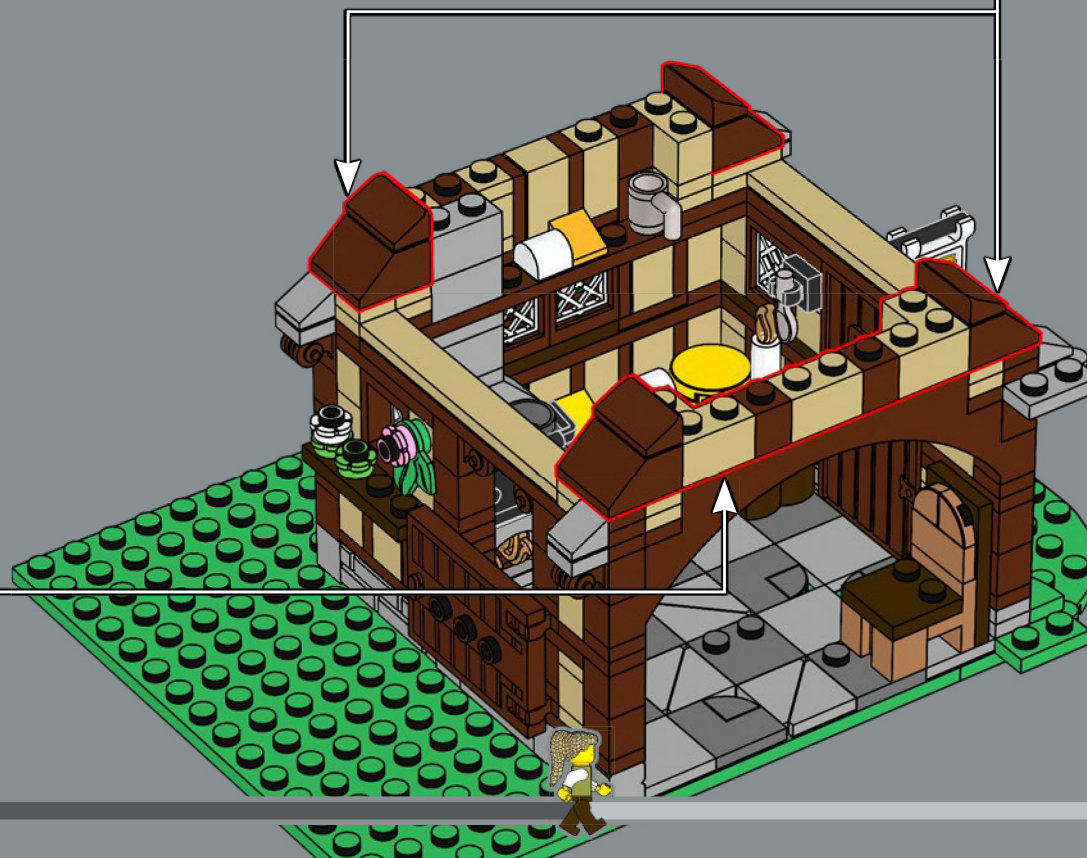
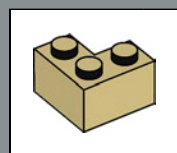
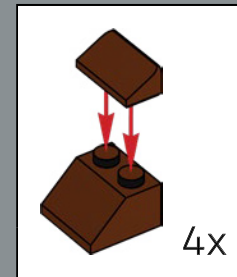

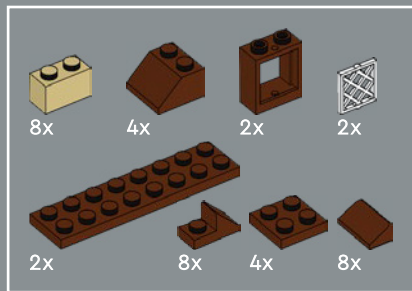
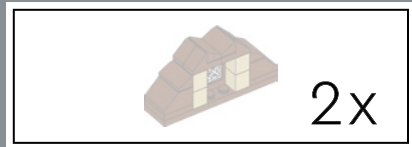

182

1

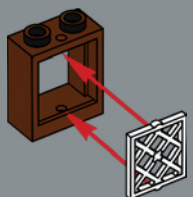

2

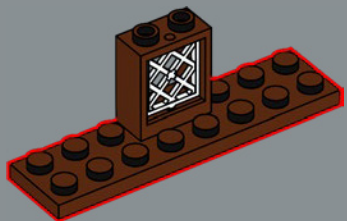

3

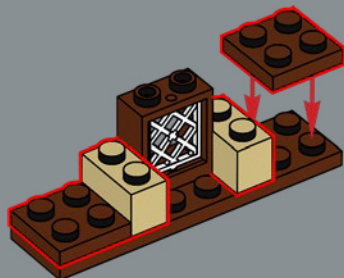

4

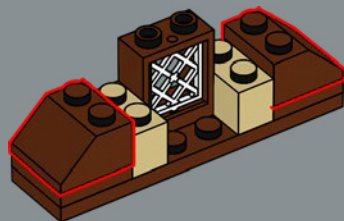

5

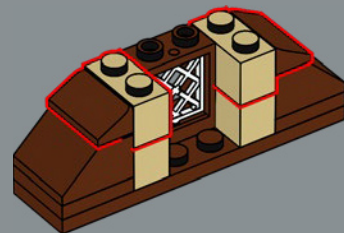

6

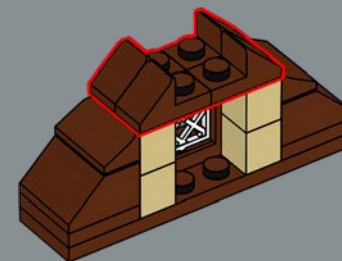

7

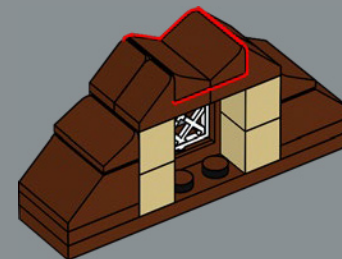

2x

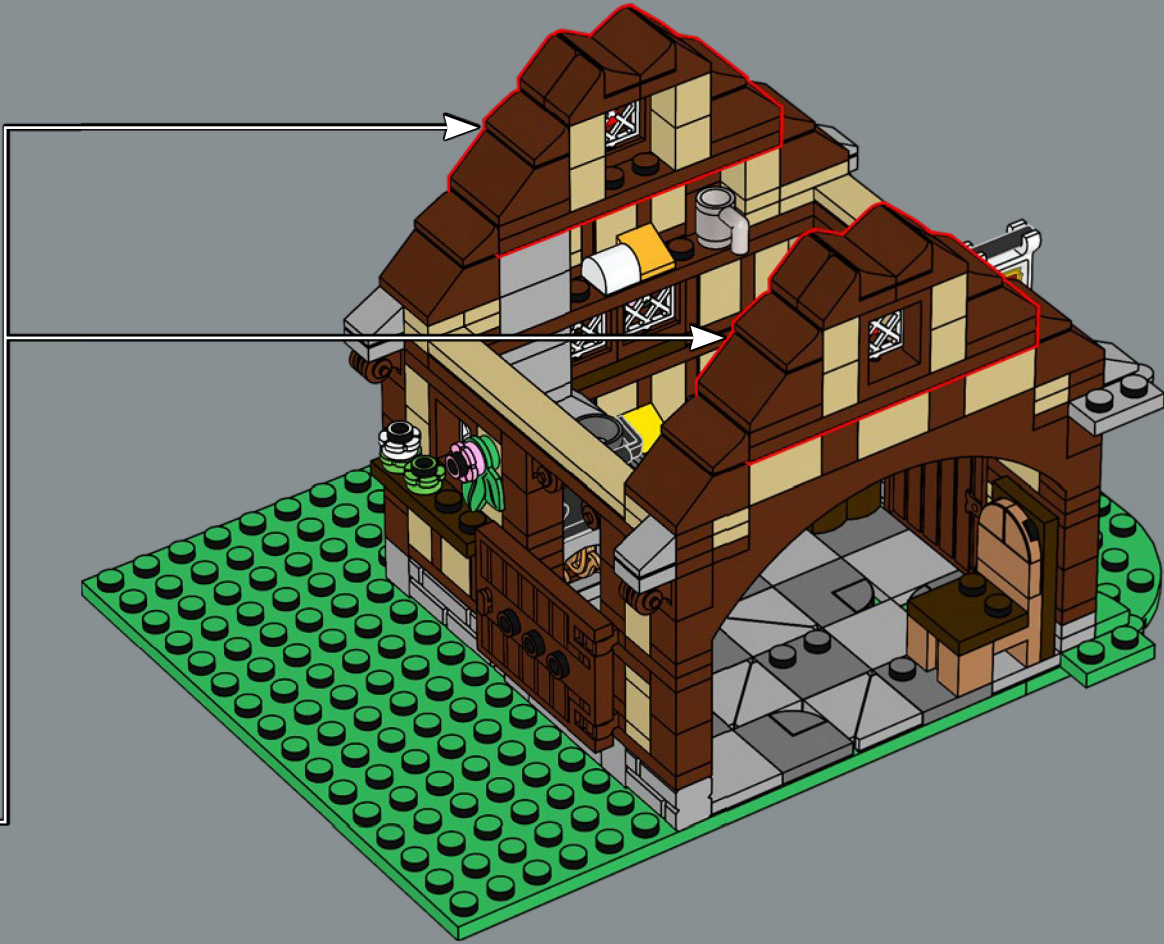



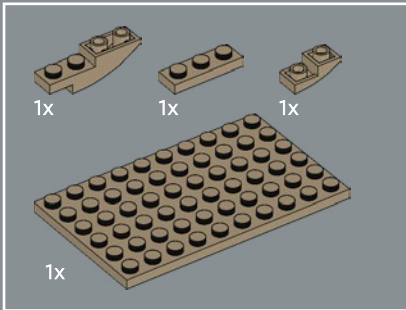
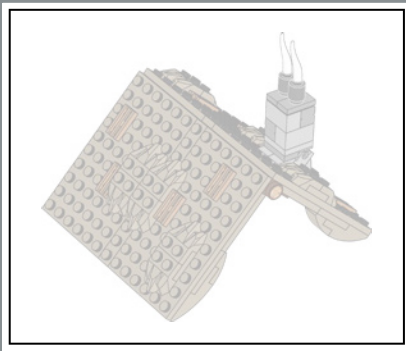

183

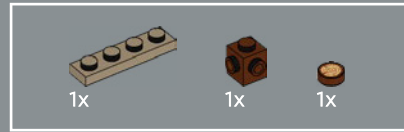
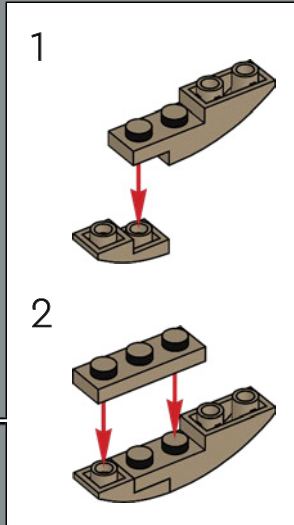
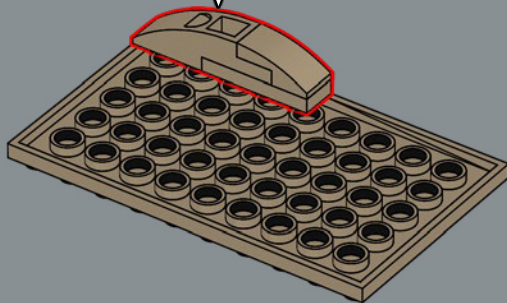

184

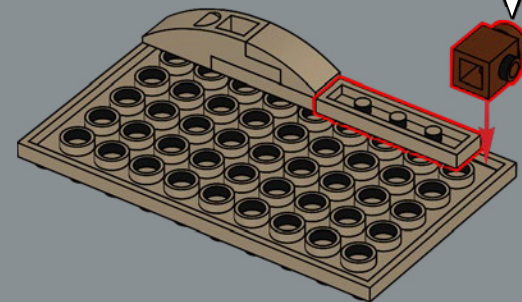
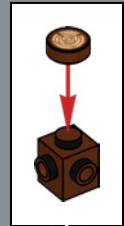

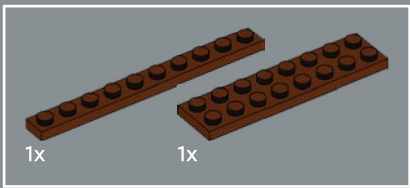

185

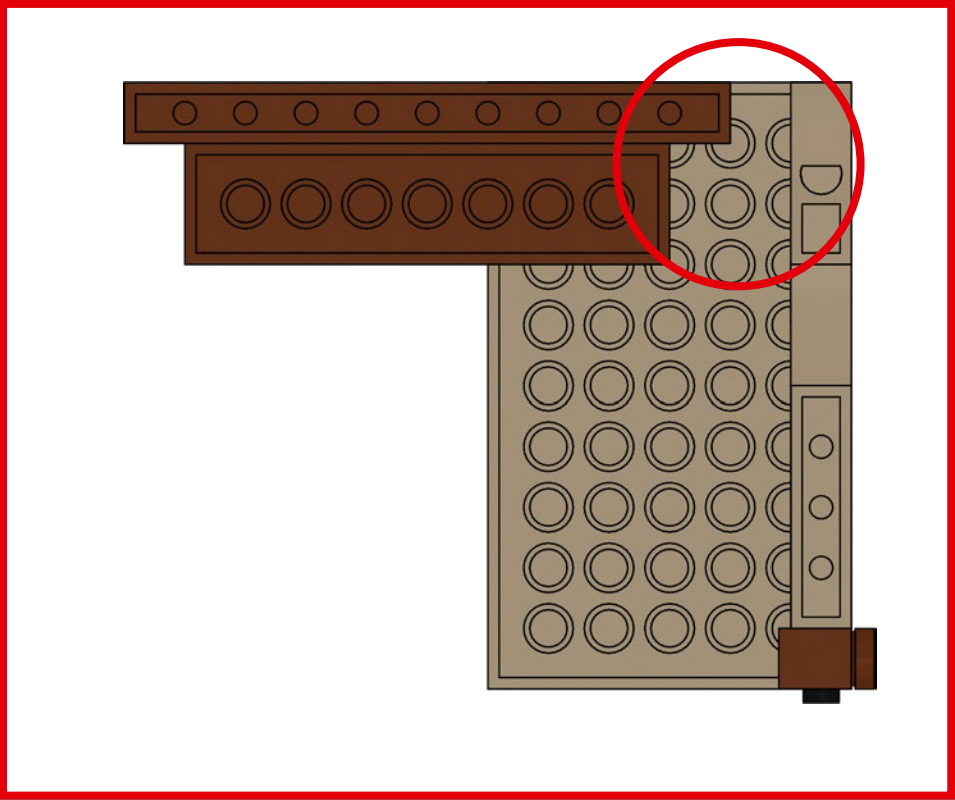
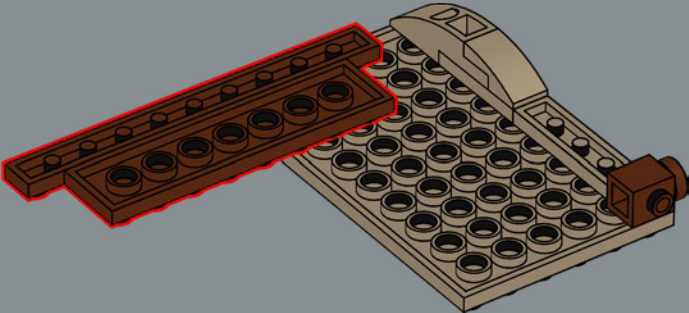



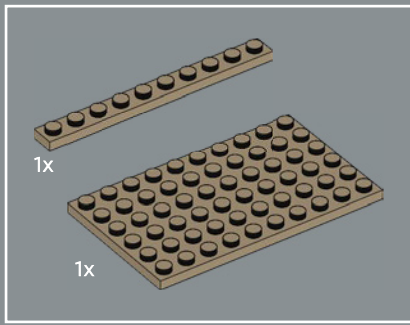

186

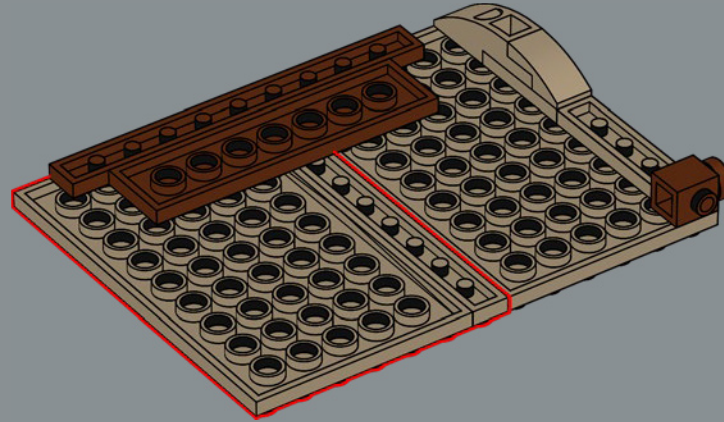

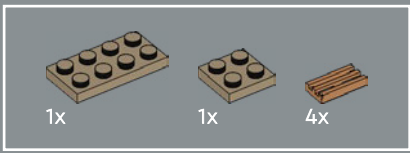

187

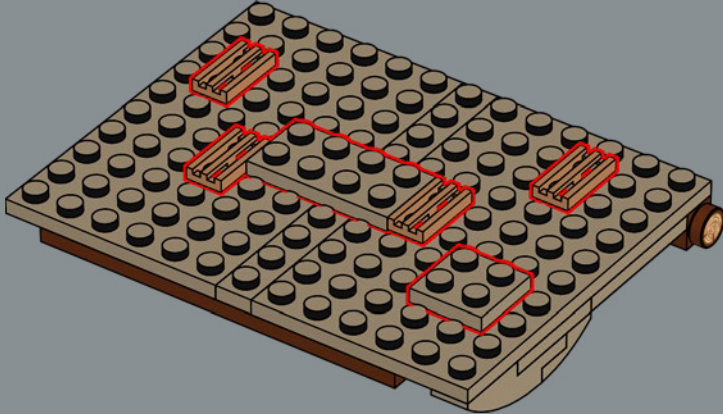

188

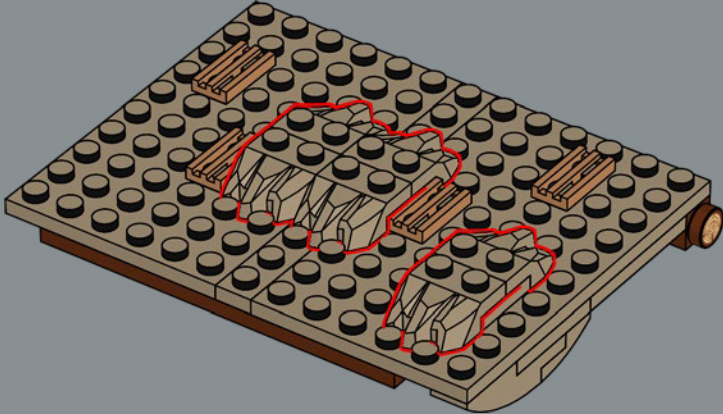

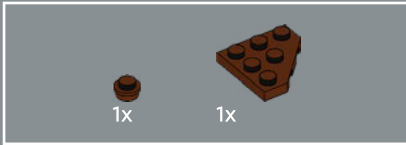
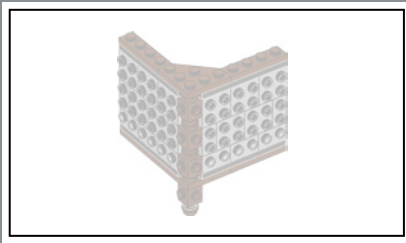

189

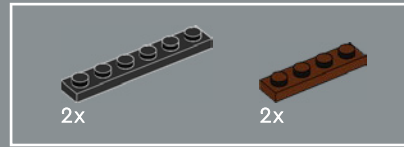
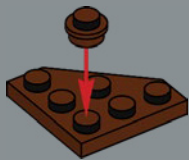

190

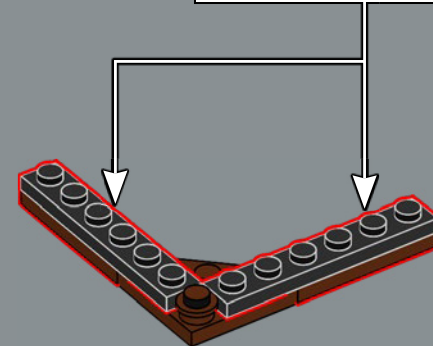
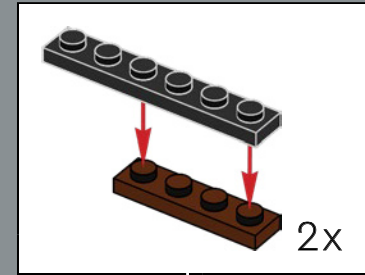

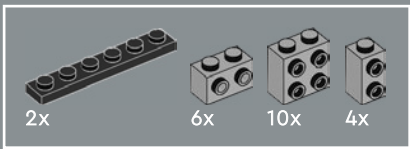

191

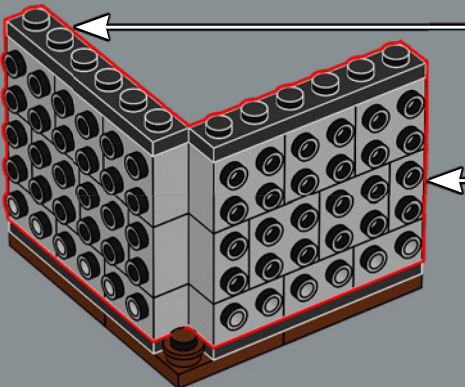
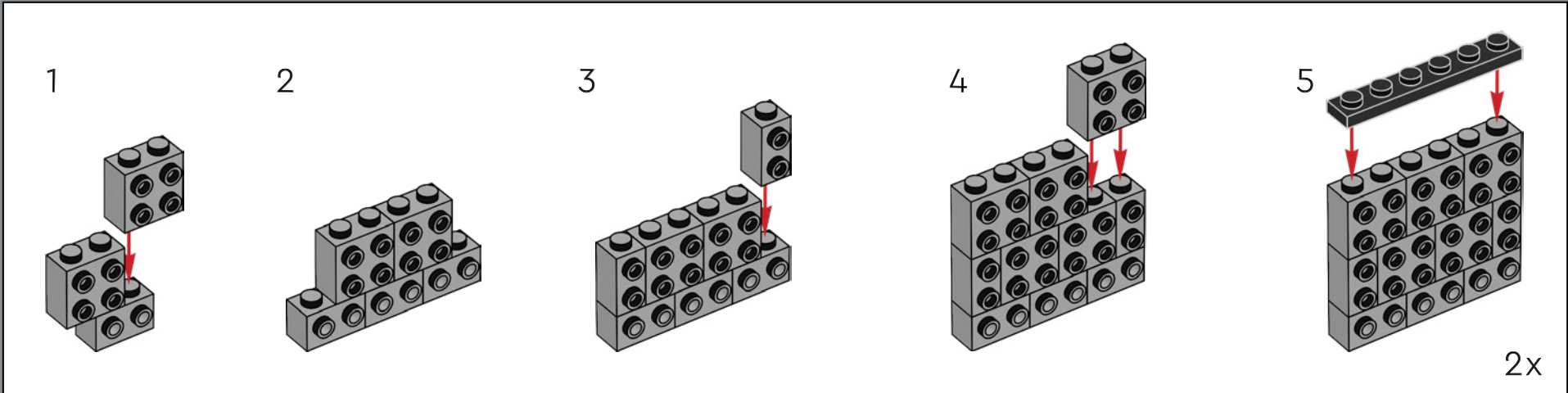



192

1

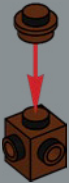

2



3



4

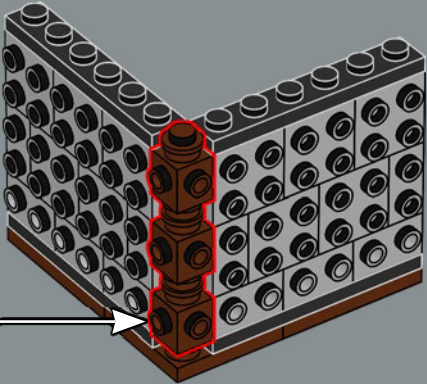
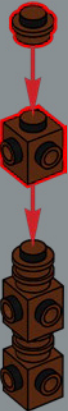

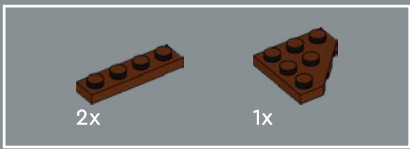

193

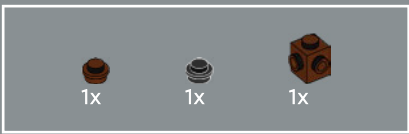
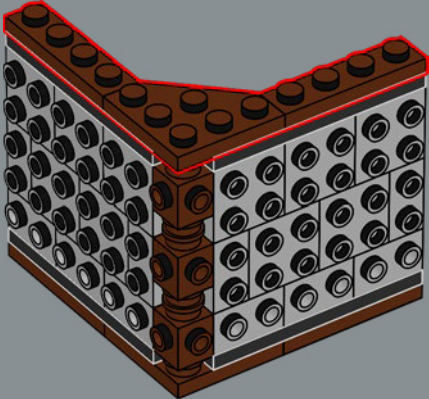

194

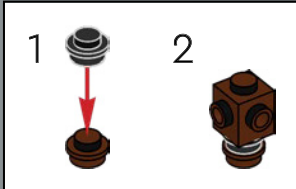
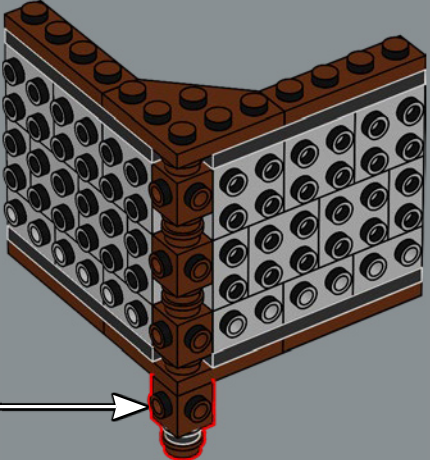

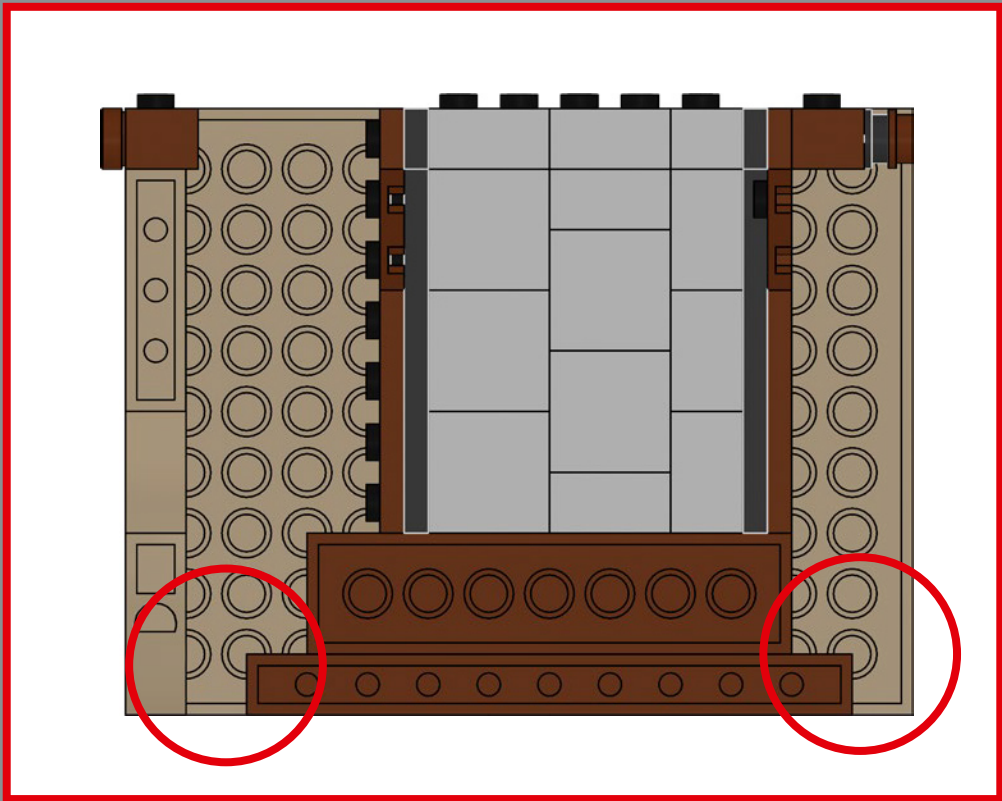

195

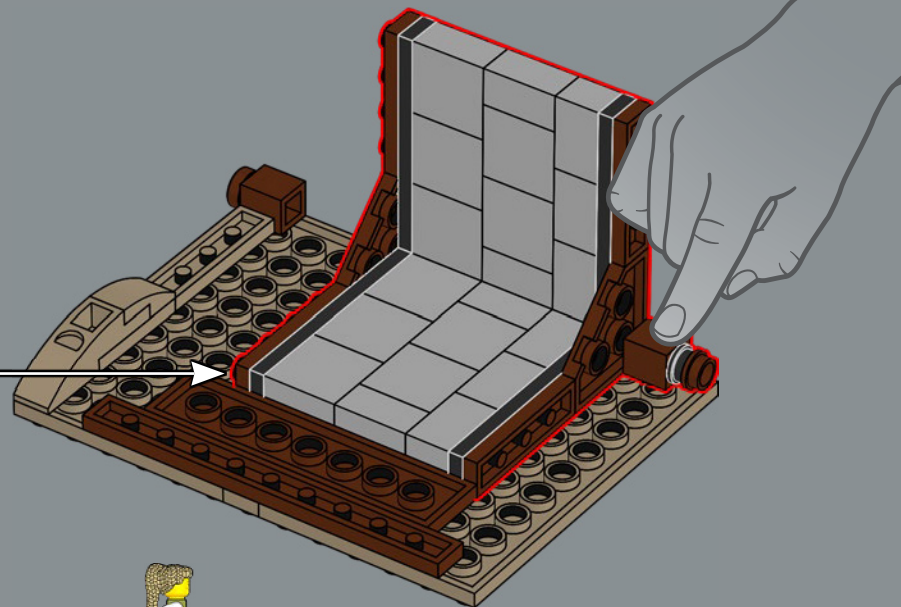

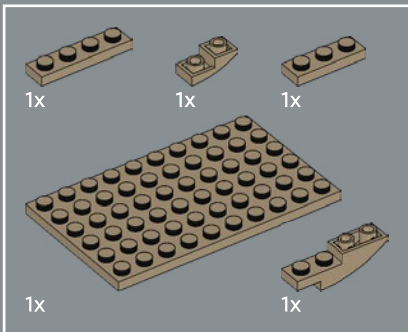
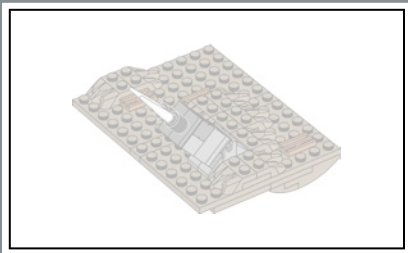

196

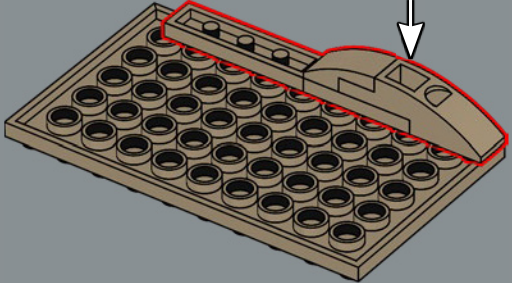
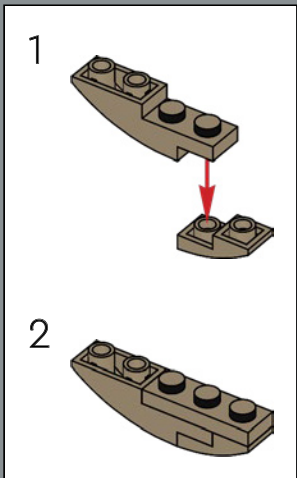



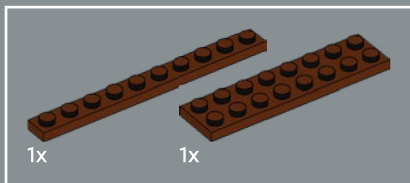

197

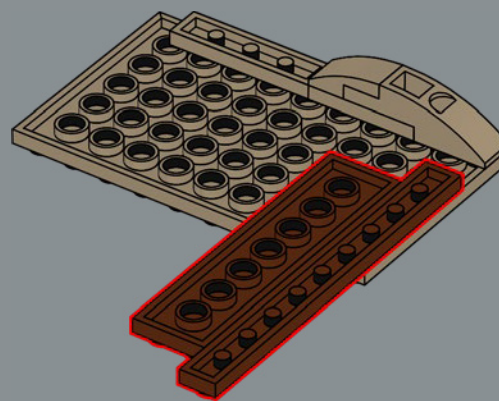
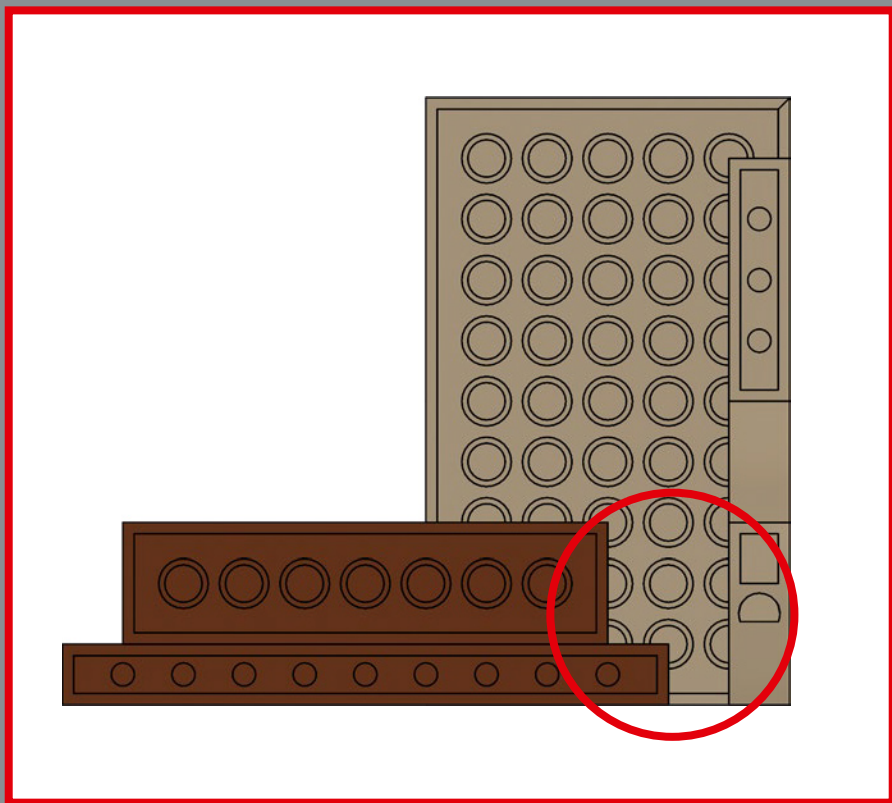

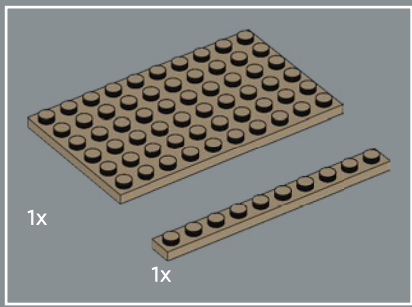

198

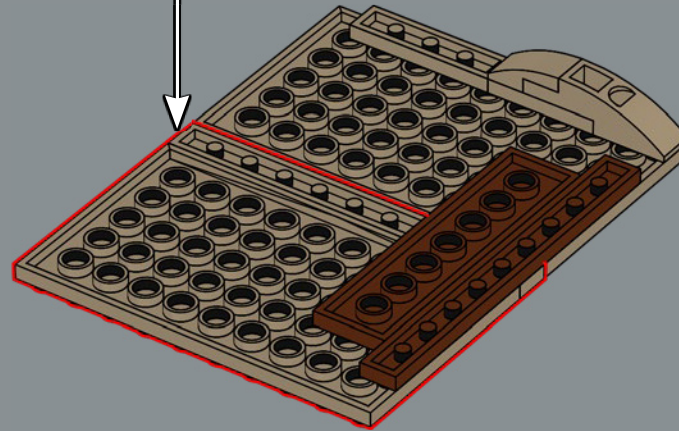
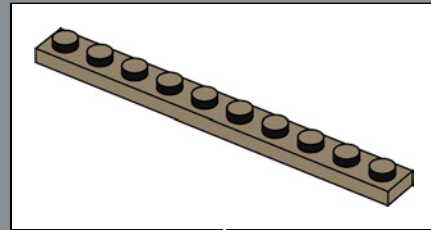

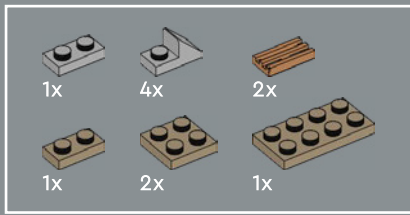

199

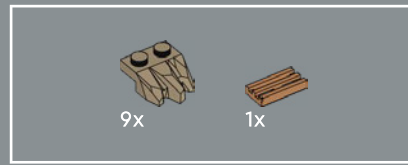
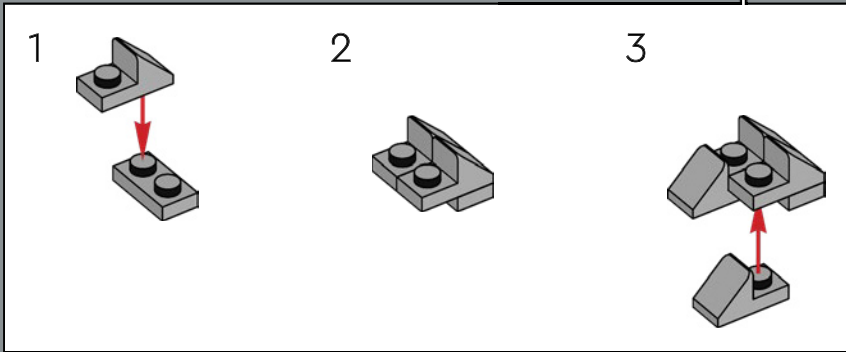
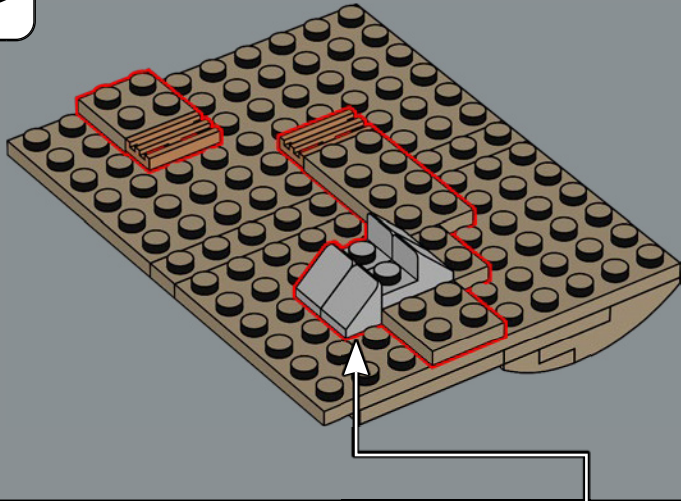

200

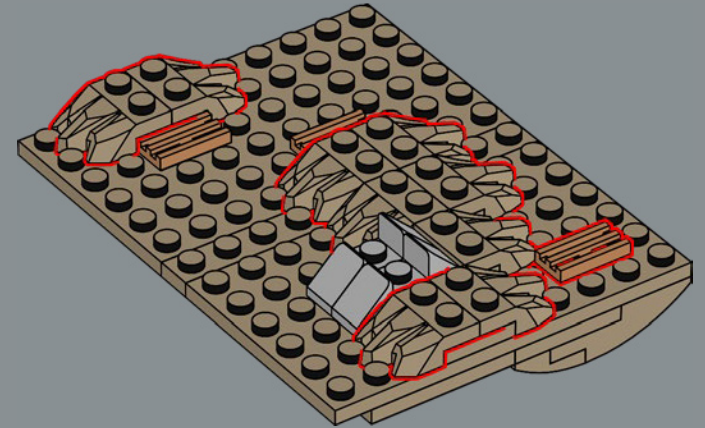

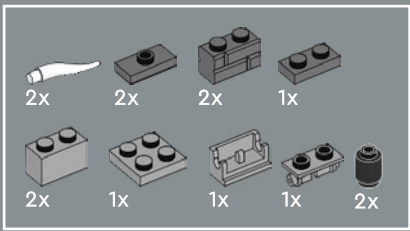

201

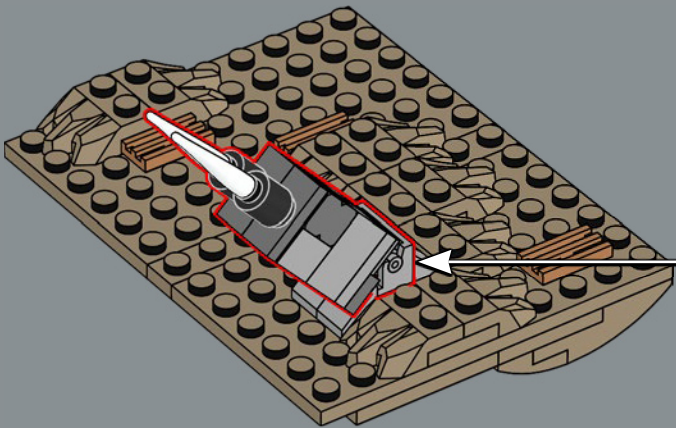
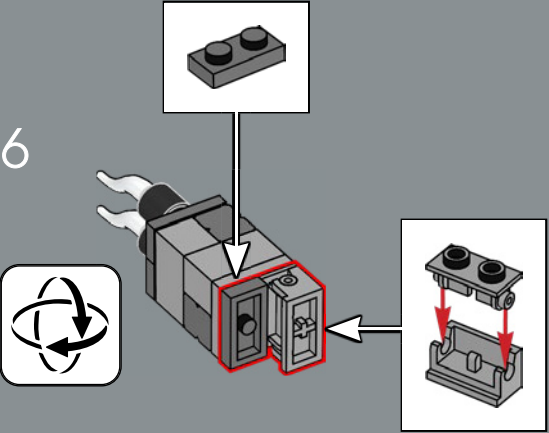
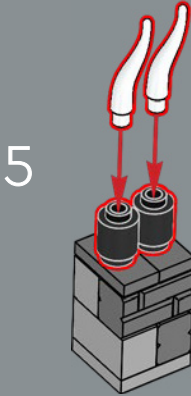
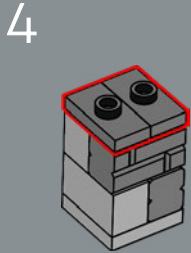
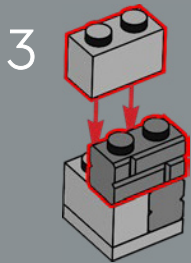
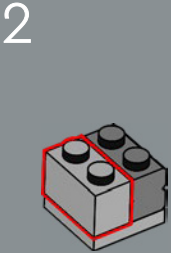
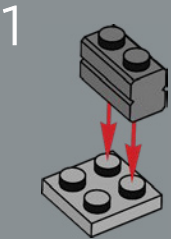

202

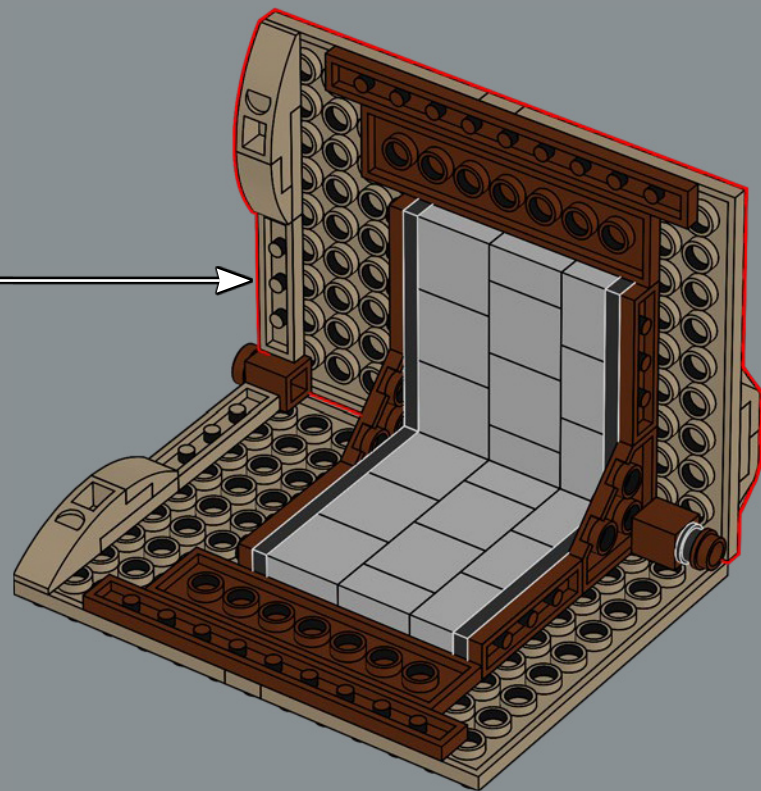

203

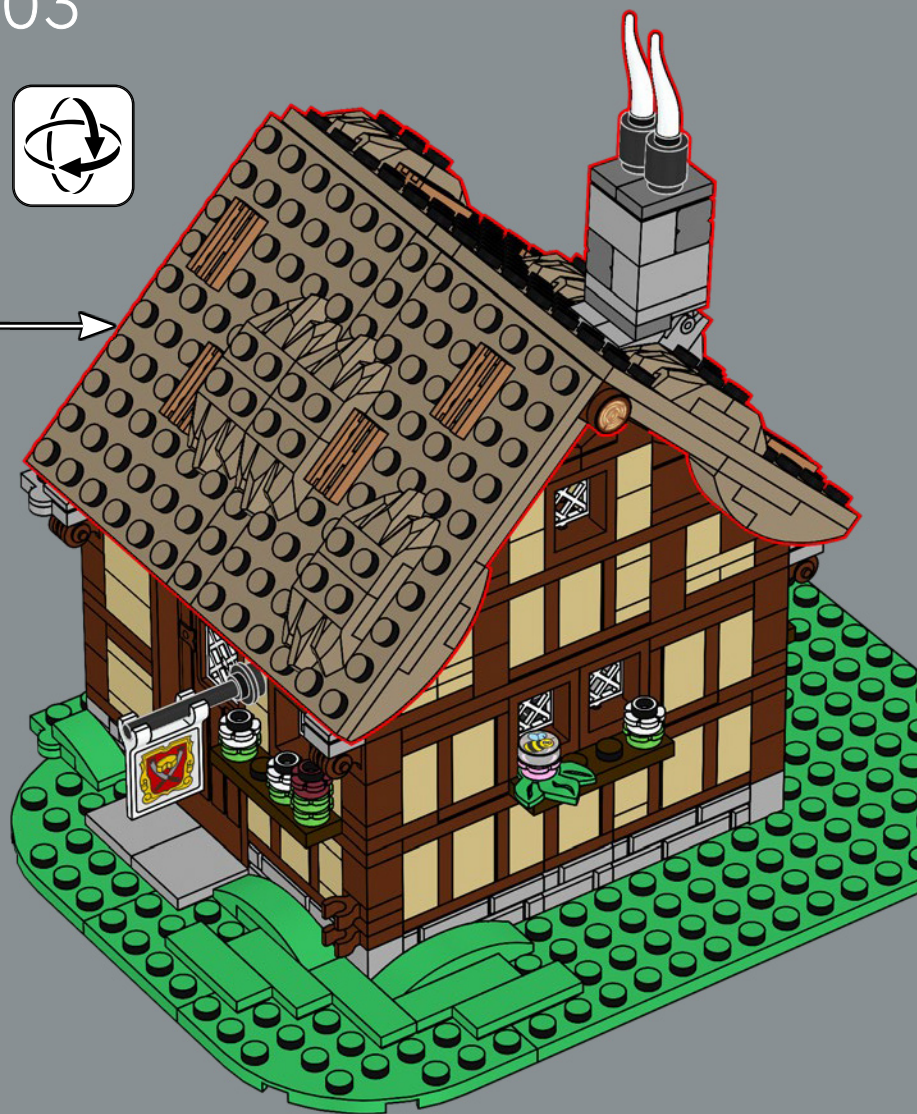





204

1

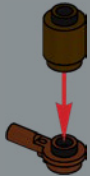

2

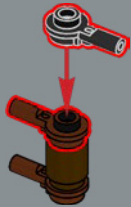

3

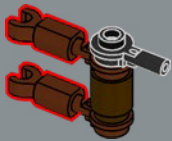

4

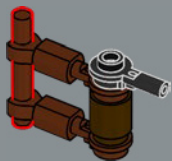

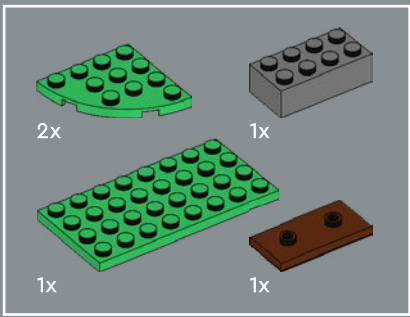

205

1

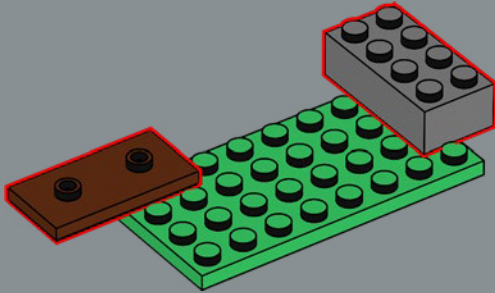

2

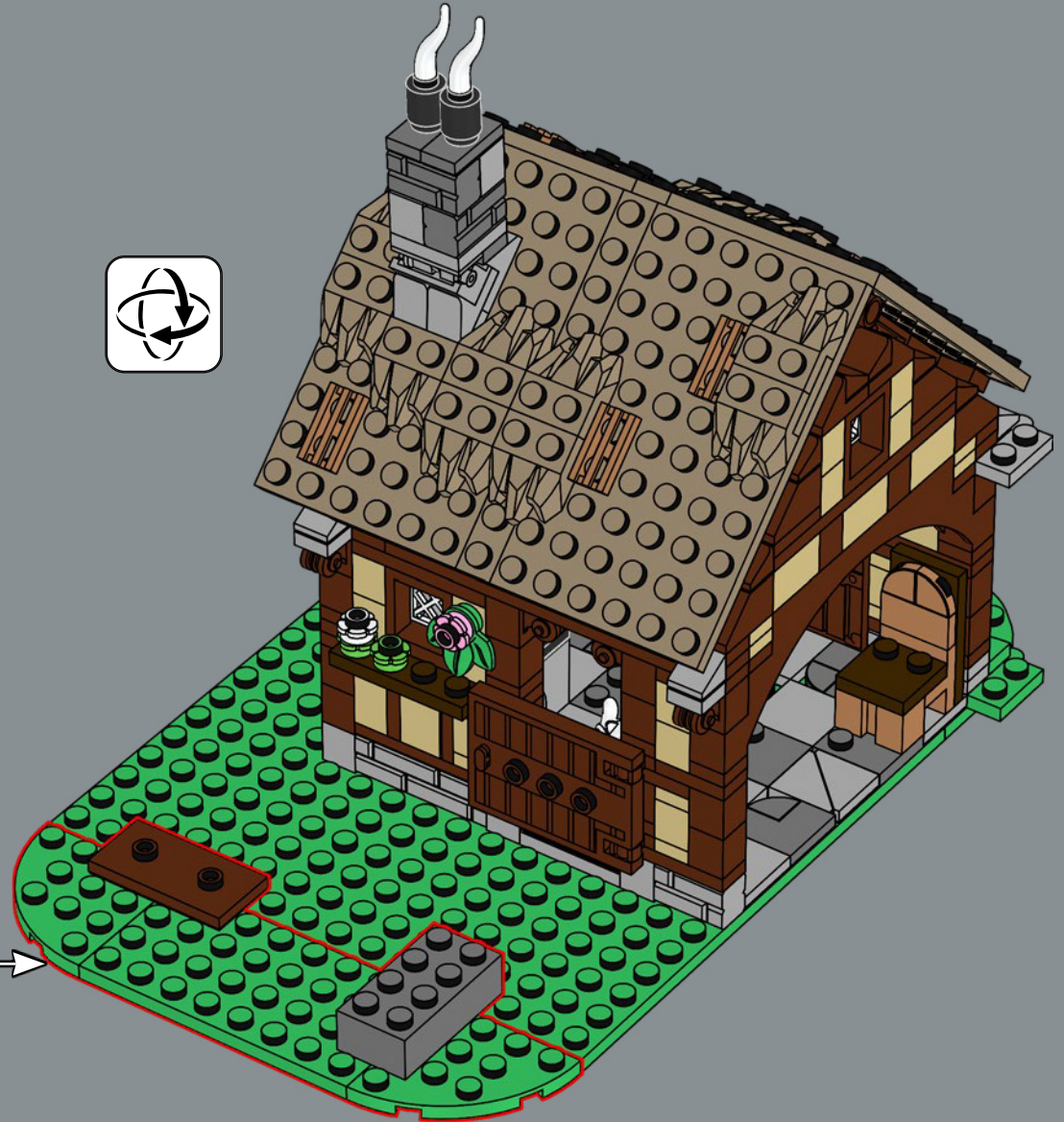
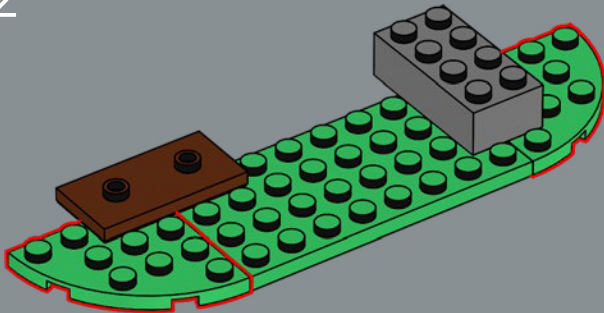



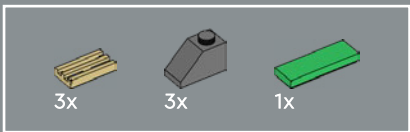

206





207

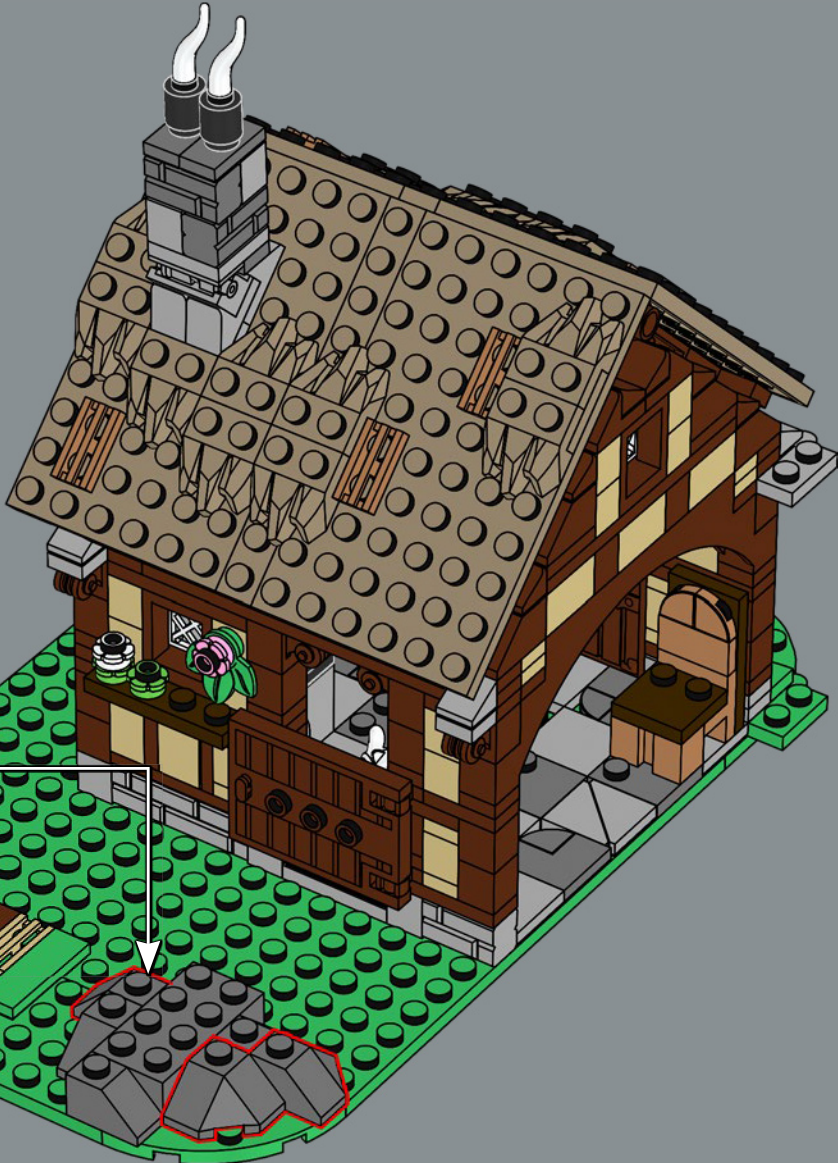



208



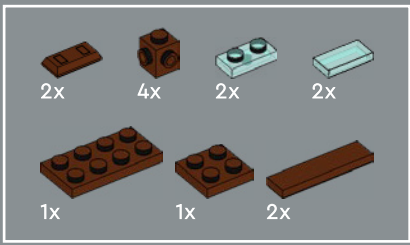

209

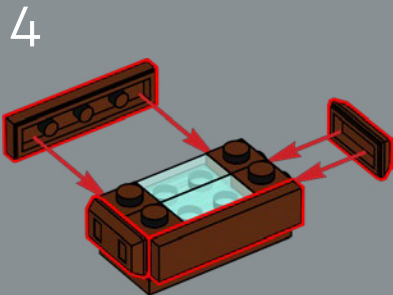
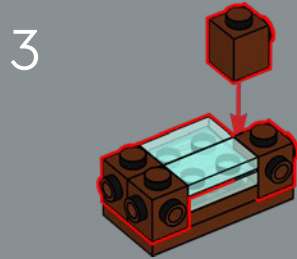
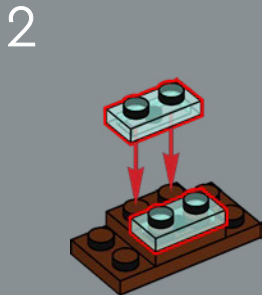
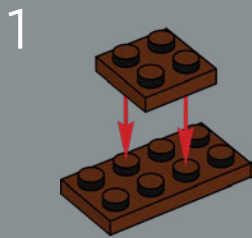



210

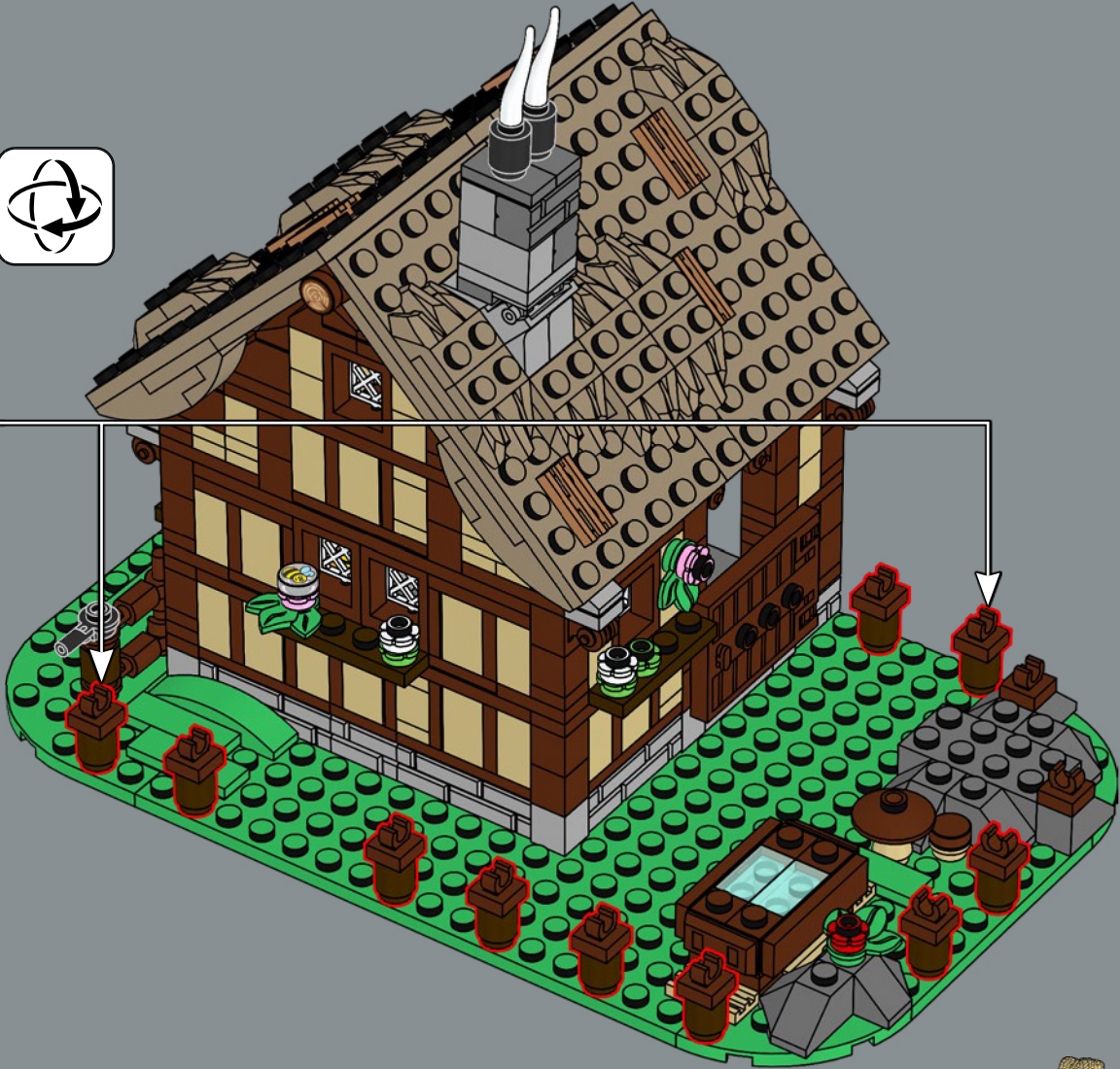
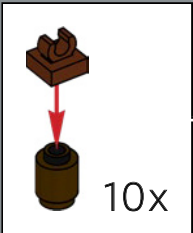



211

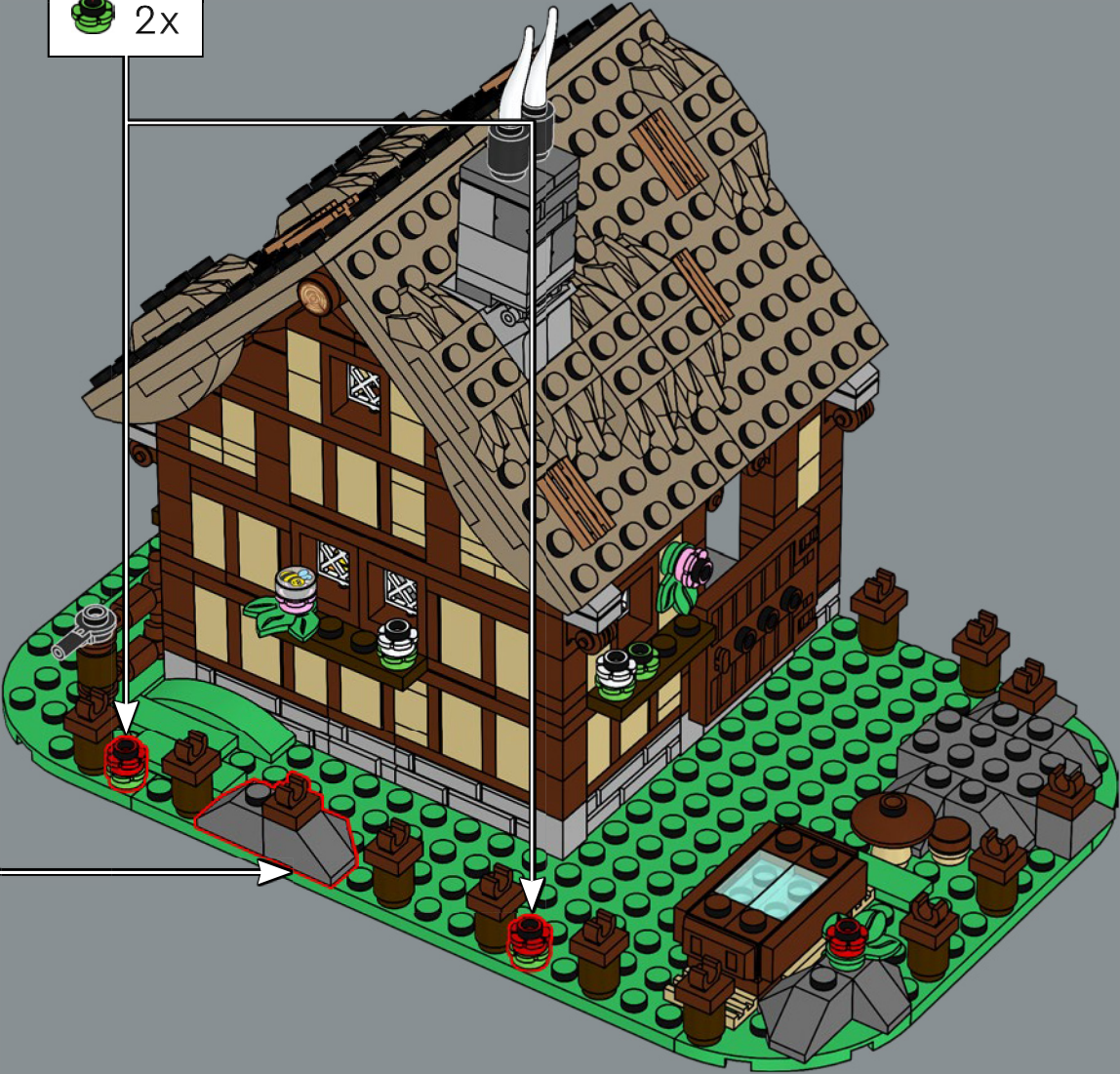
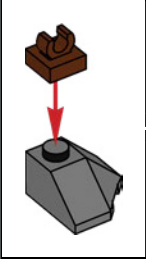
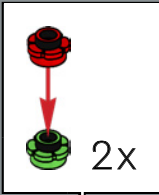



212



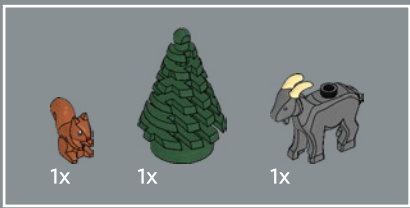

213







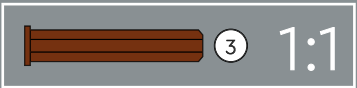
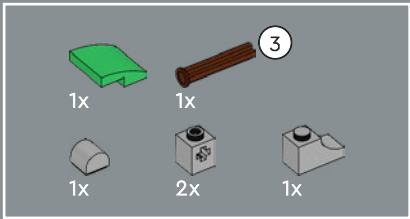

215

1

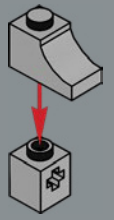

2

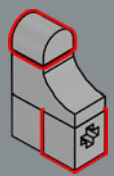

3

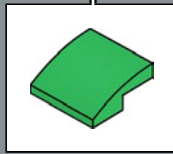
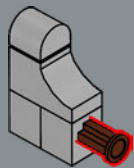



1

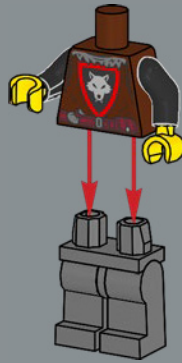

2

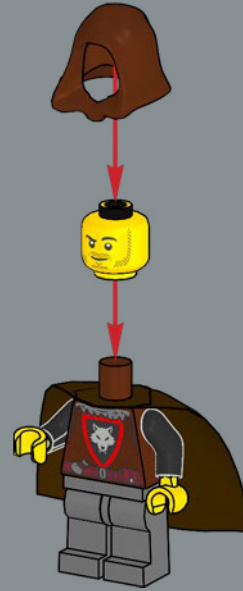

3



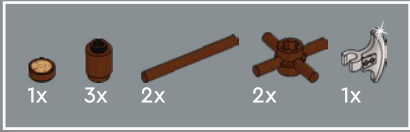
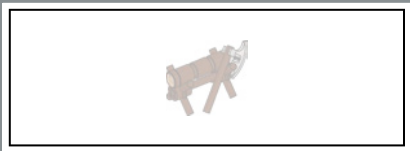

1

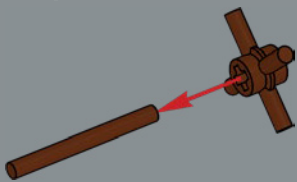

2

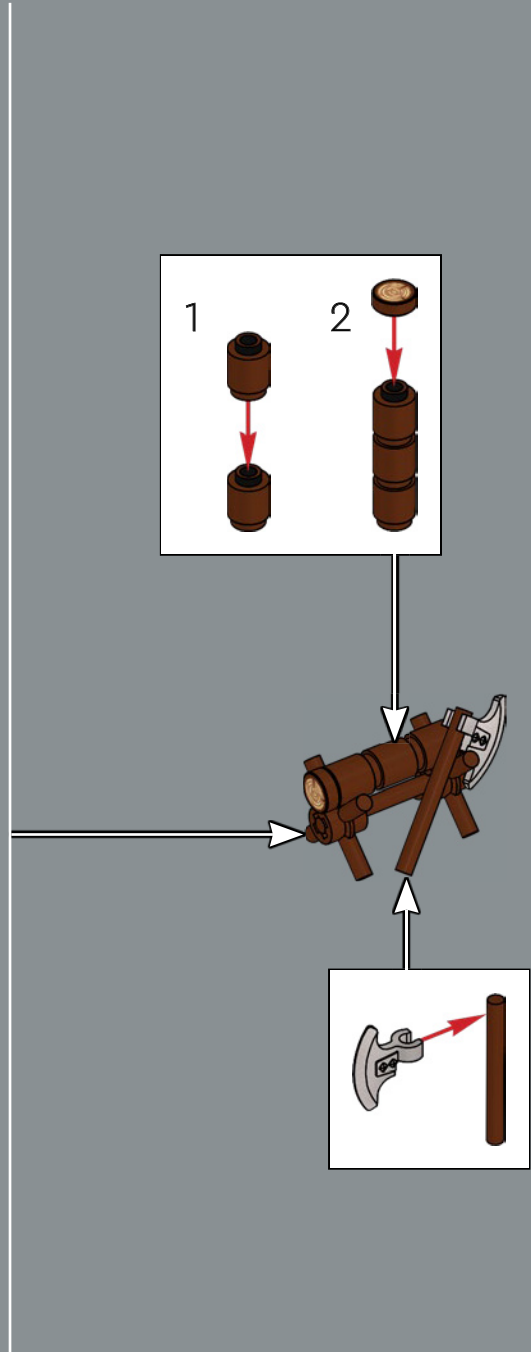
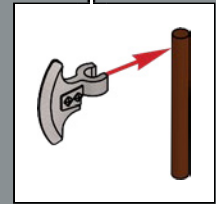
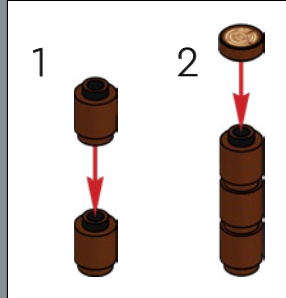
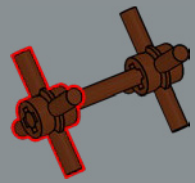

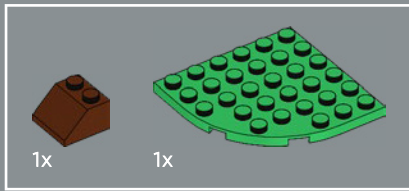
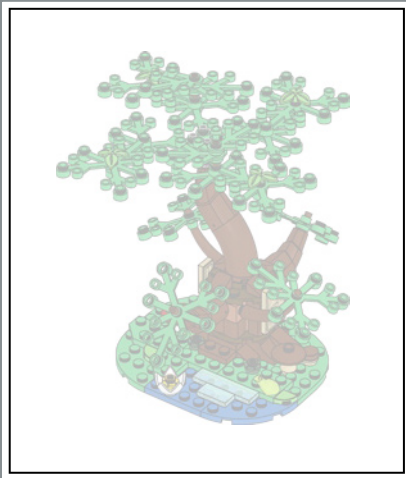

1

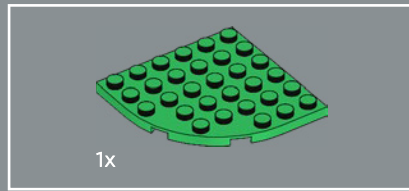
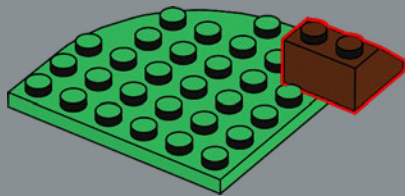

2

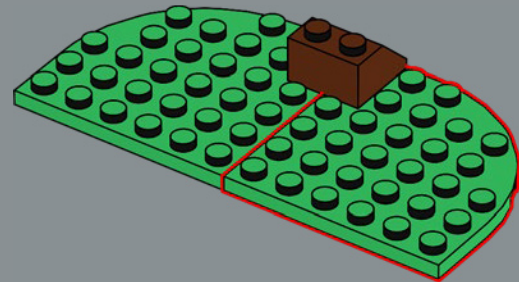

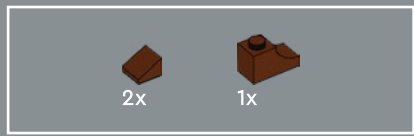

3

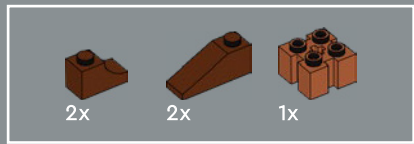
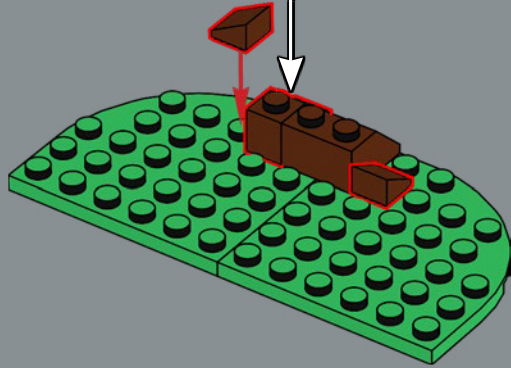

4

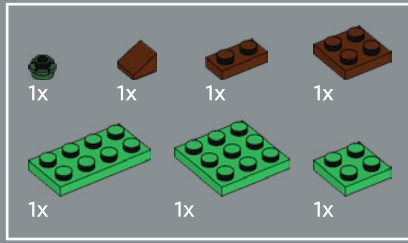
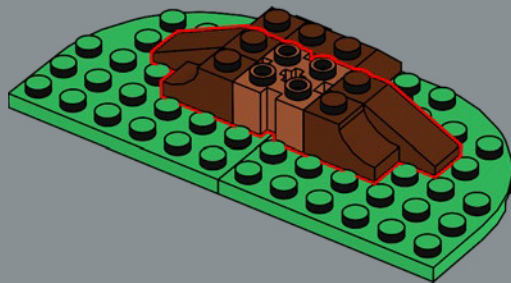

5

1

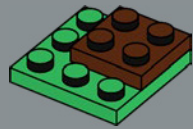

2

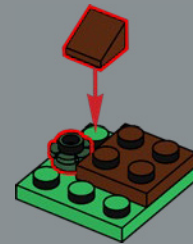

3

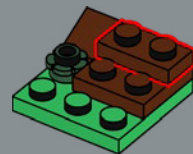

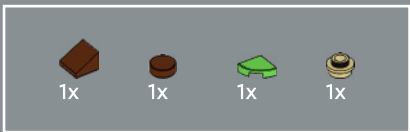

6

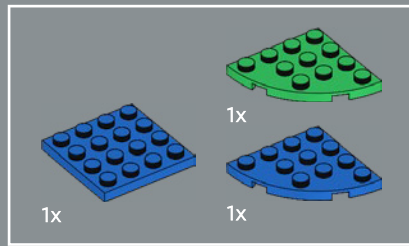
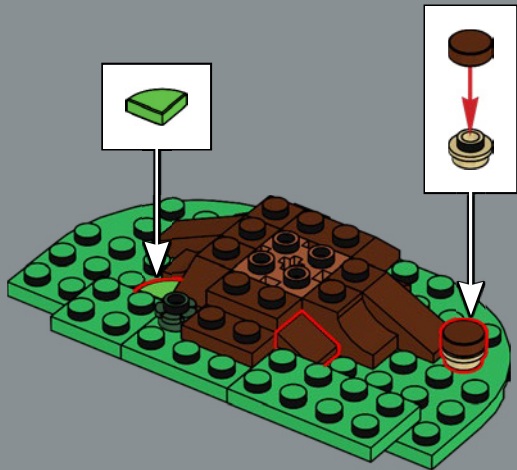

7

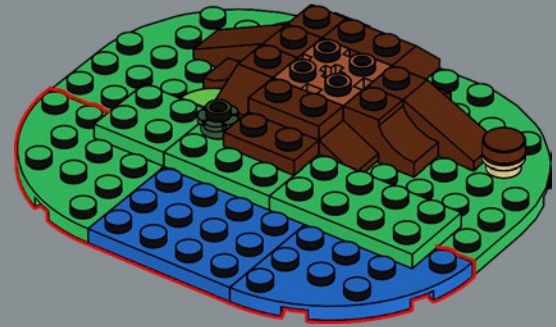

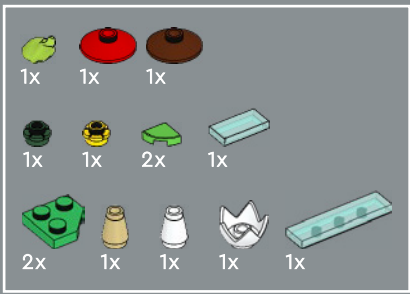

8

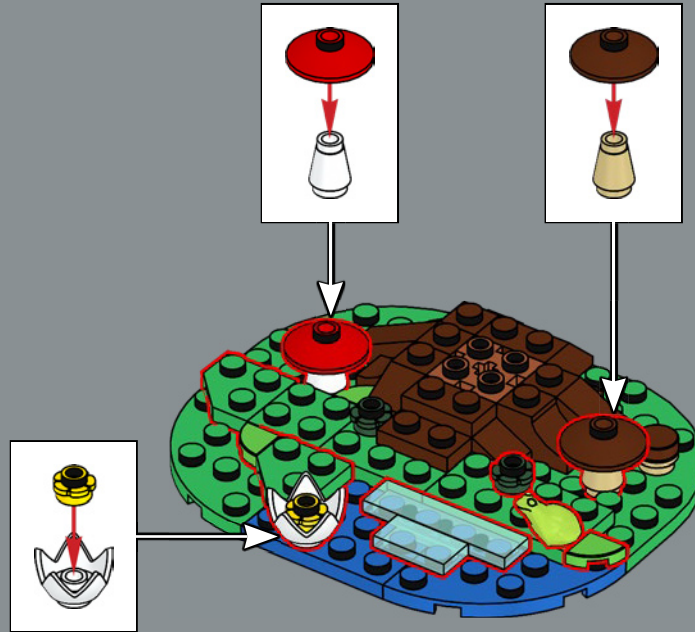



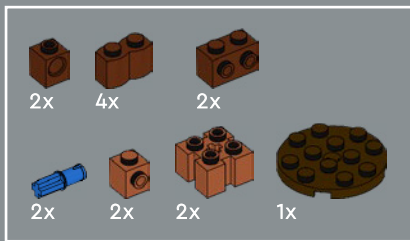

9

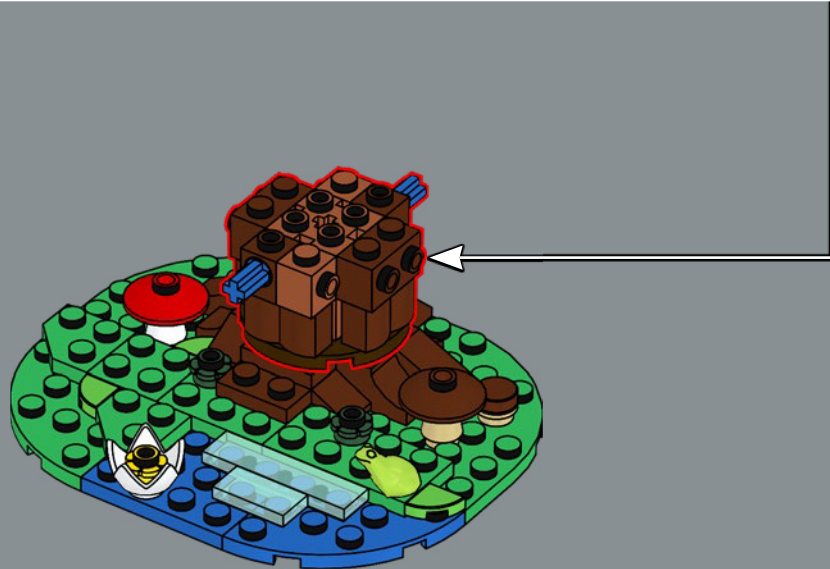
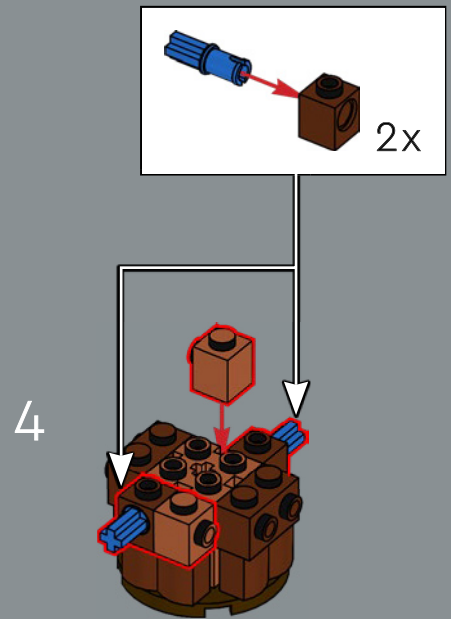
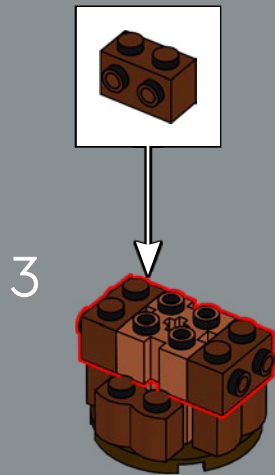
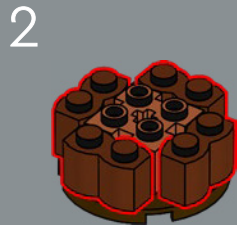
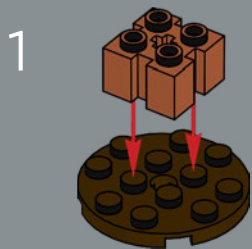

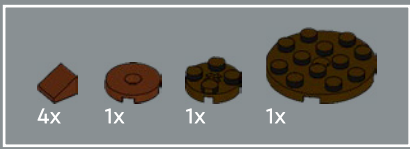

10

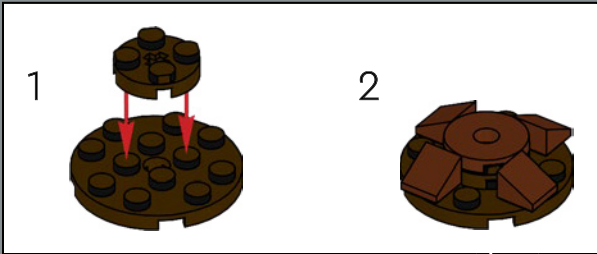

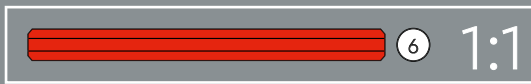
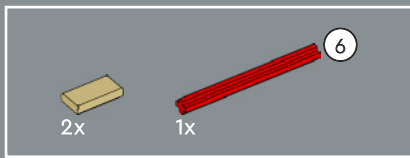

11

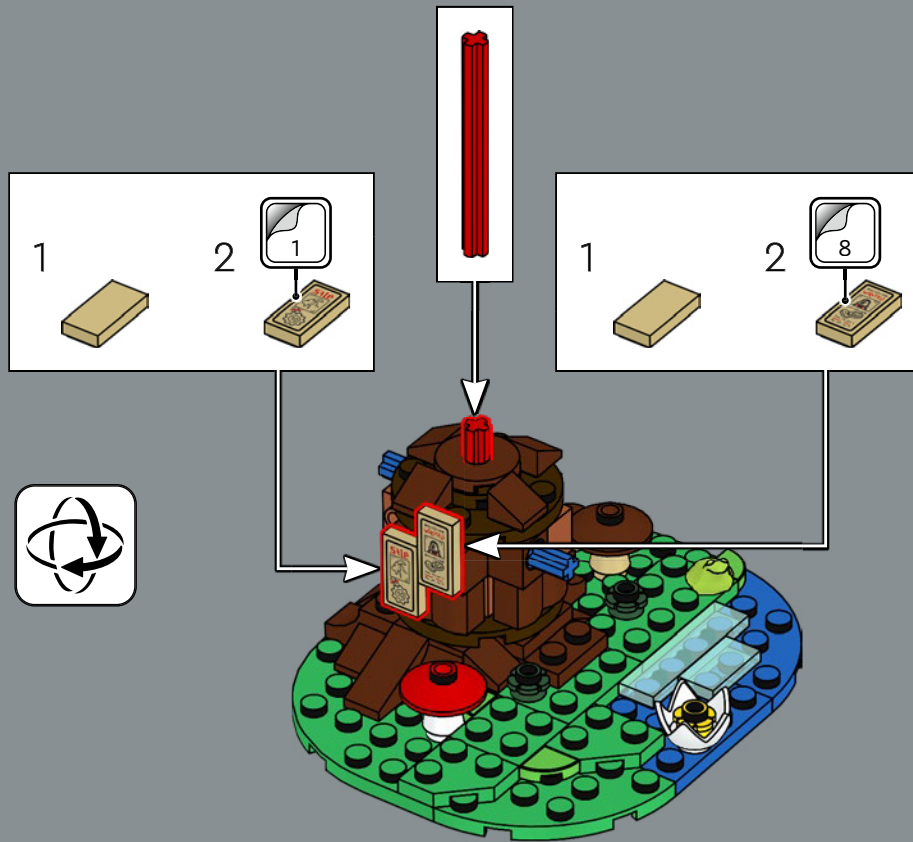

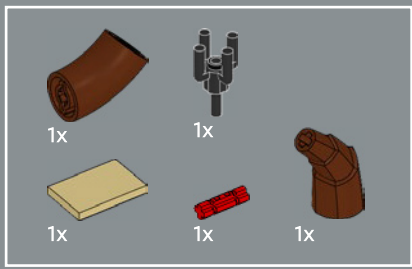

12

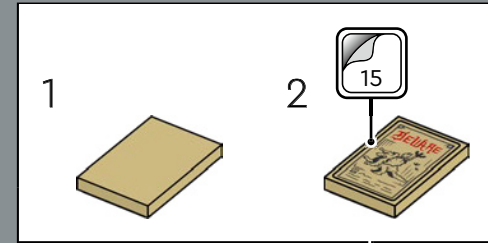
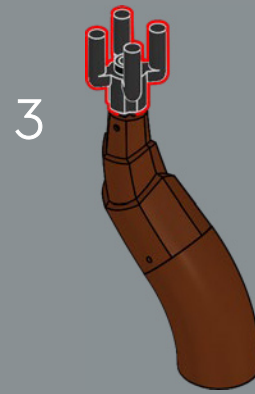
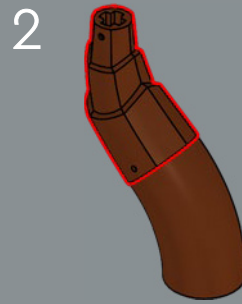
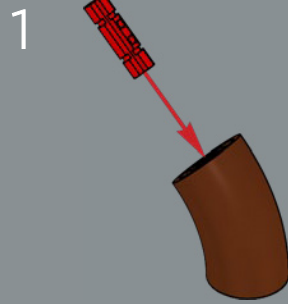

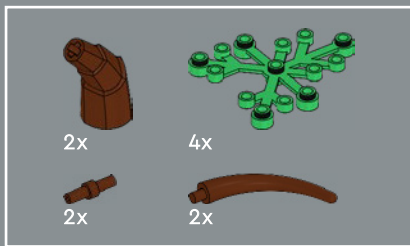

13

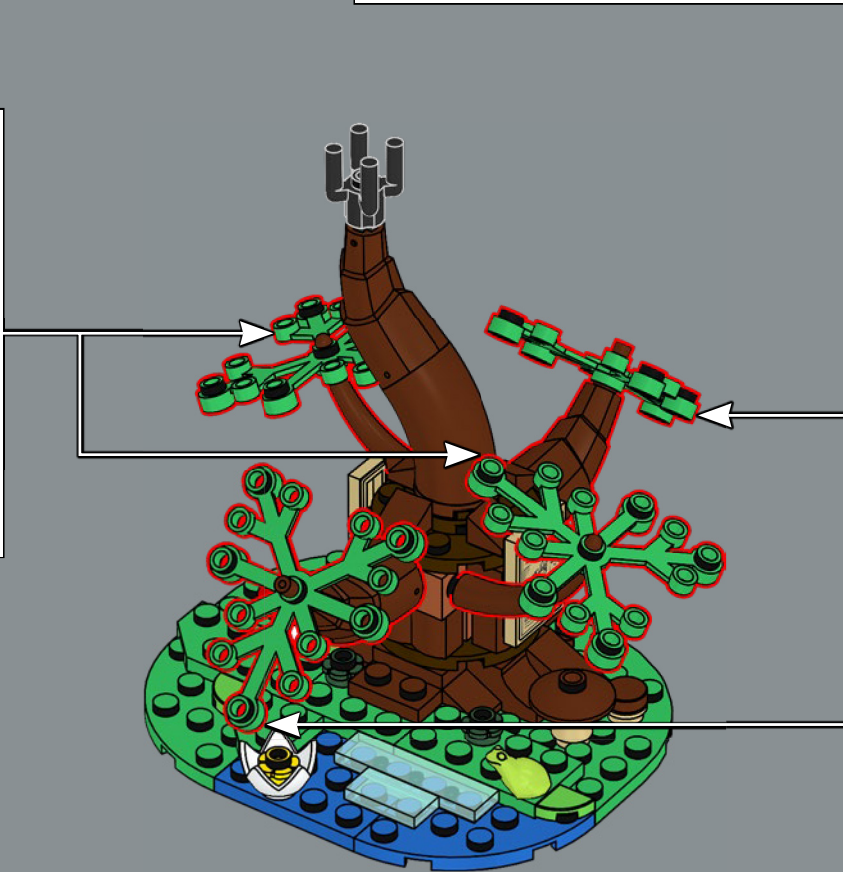
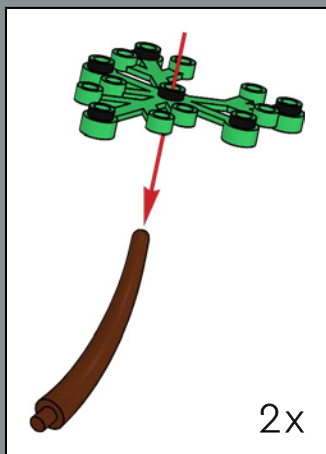
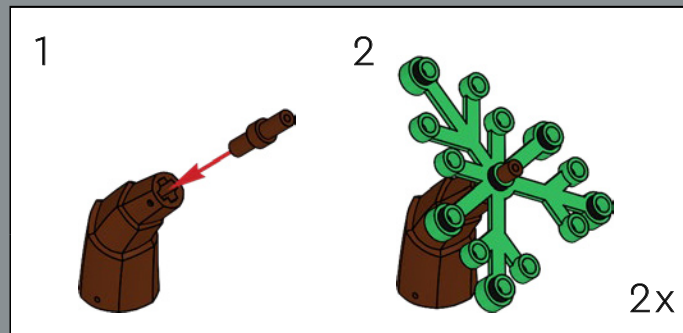

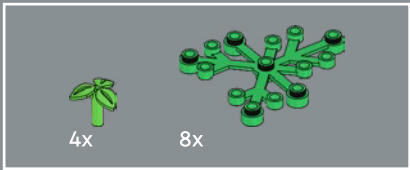

14

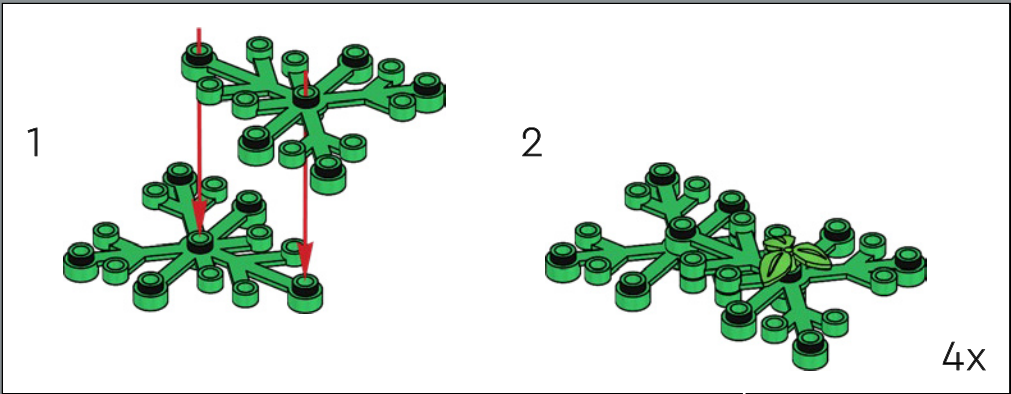

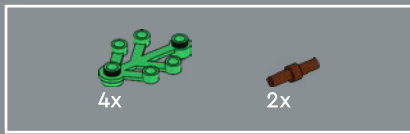

15

