



JUNIORS

10673



 **WARNING: CHOKING HAZARD.**
Small parts. Not for children under 3 years.



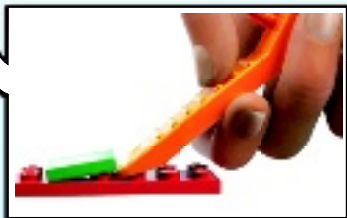
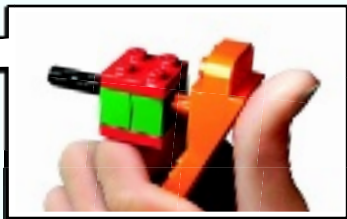
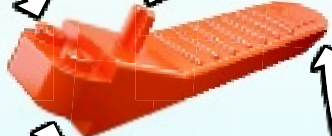
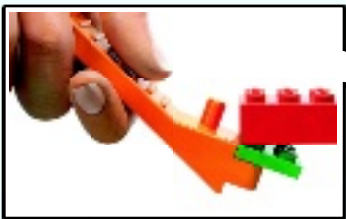
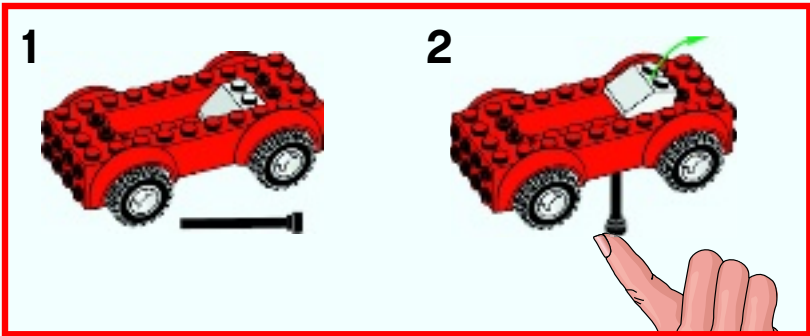

[LEGO.com/brickseparator](https://www.lego.com/brickseparator)

⚠️ AVERTISSEMENT : RISQUE D'ÉTOUFFEMENT.
Contient des petites pièces. Ne convient pas aux enfants de moins de 3 ans.

⚠️ ADVERTENCIA: PELIGRO DE ASFIXIA.
No recomendado para niños menores de 3 años. Contiene piezas pequeñas.

 **Build & Rebuild**

 **Construis et reconstruis**

 **Construye y reconstruye**

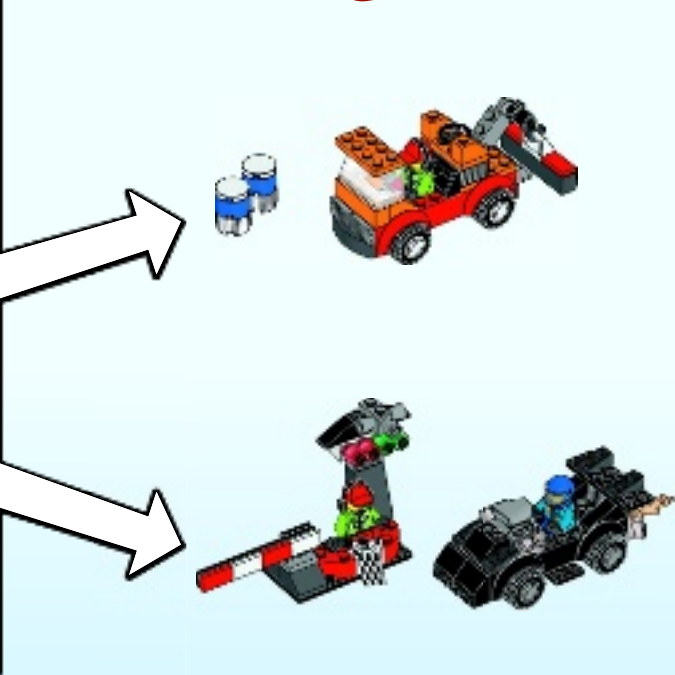
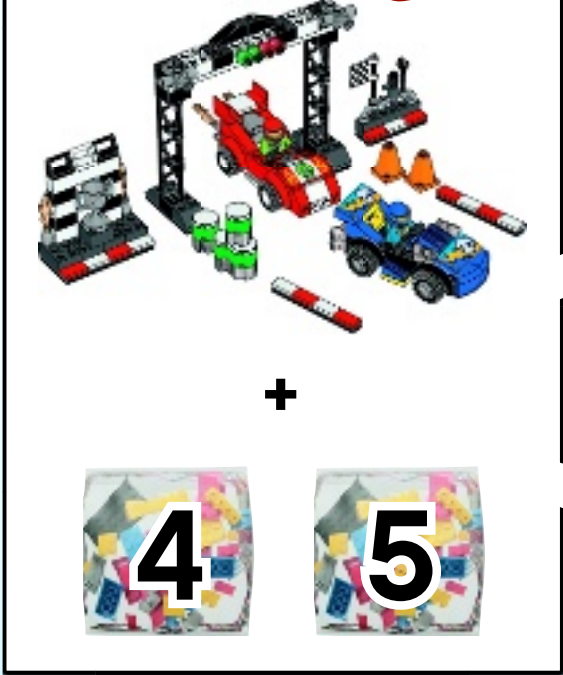



Build & Rebuild

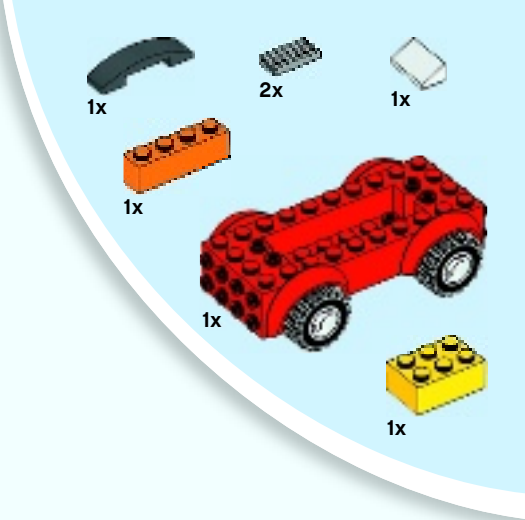

1



2





1x



1x



2x



2x



3



4

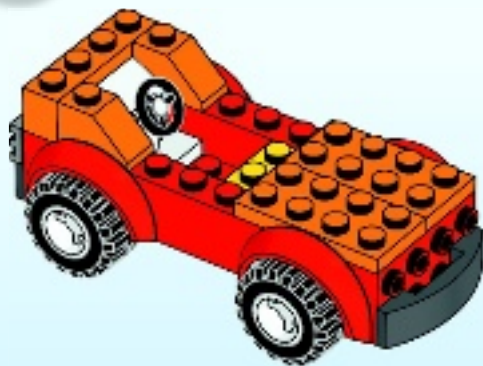

5

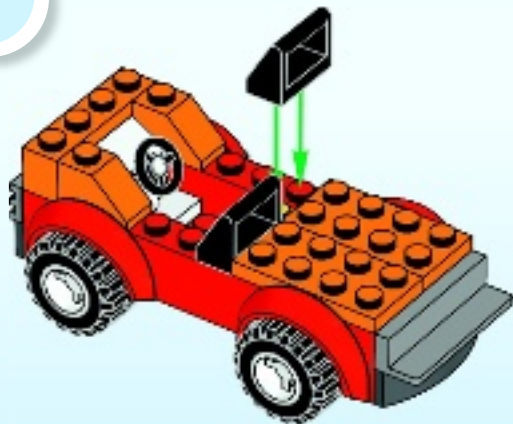

6

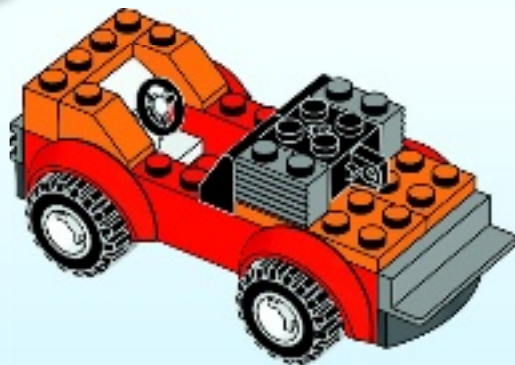

1x



2x



2x



1x



7

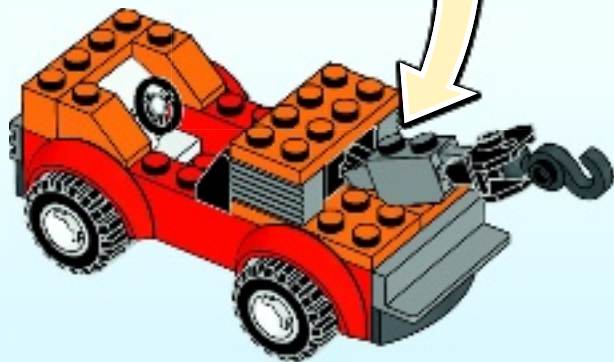
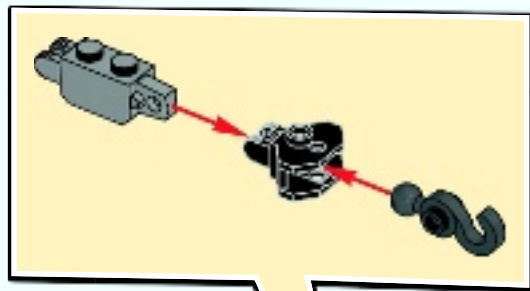



1x



1x



2x



1x

8

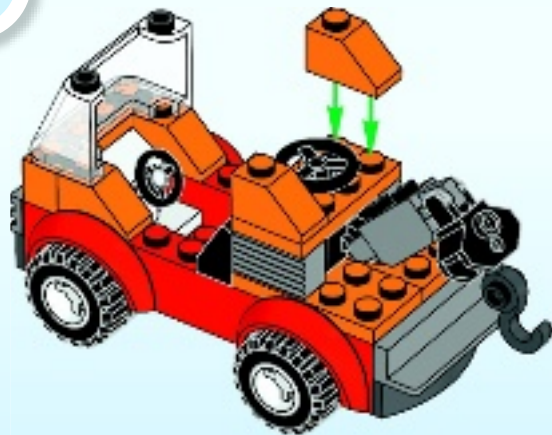

9

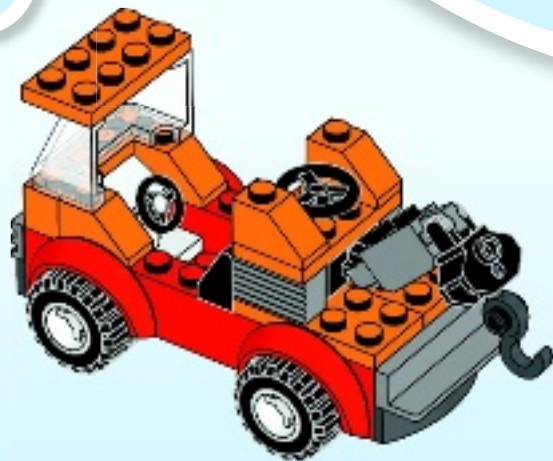

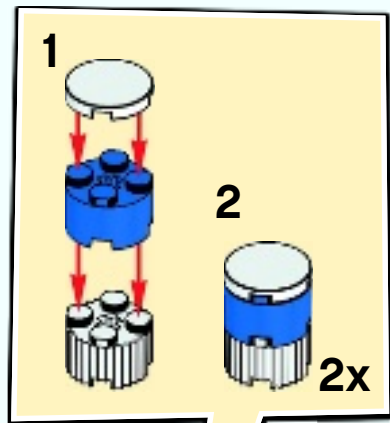

10

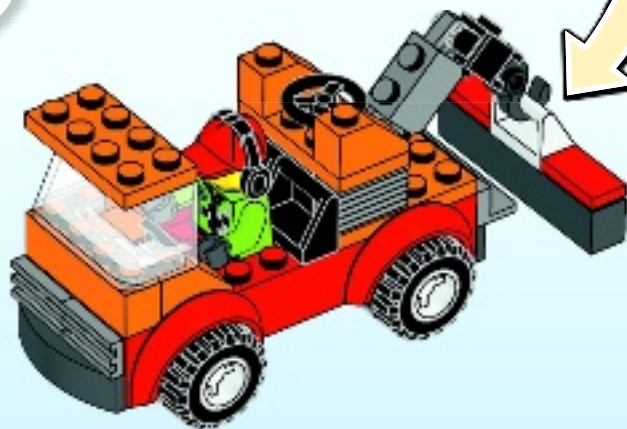

1

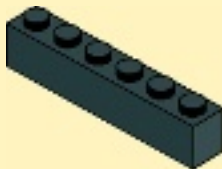

2

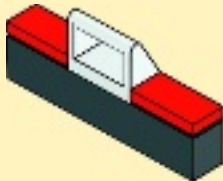

1x



2x



1x



Build & Rebuild

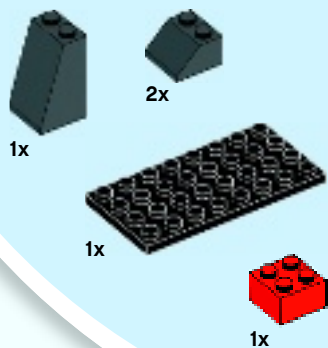
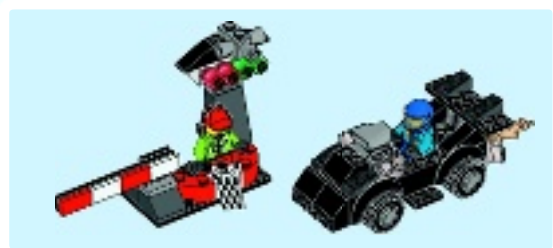

1



2

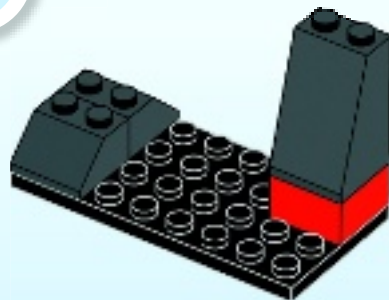



1x



1x



1x



2x



1x



3

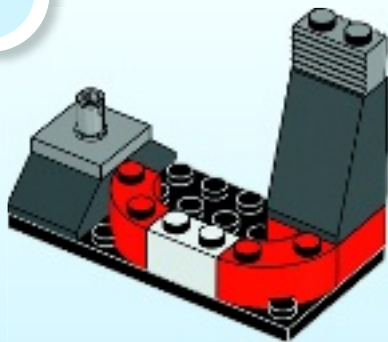

4

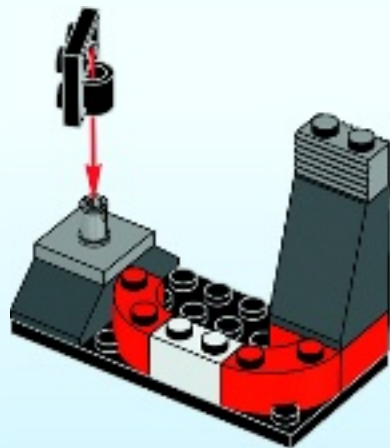



2x



2x



1x

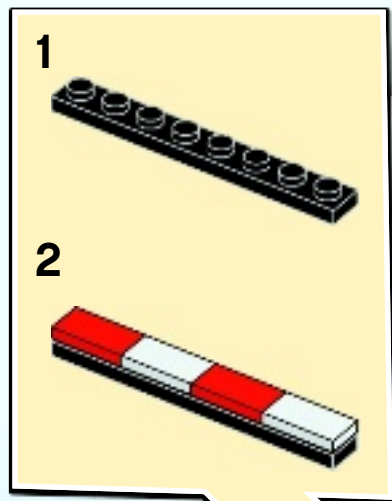

1

2

5

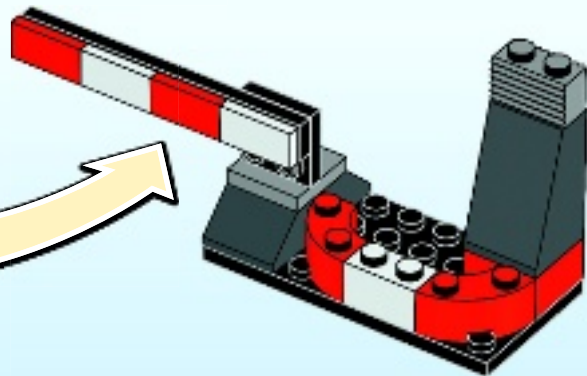

2x



2x



2x



1x



1x



1

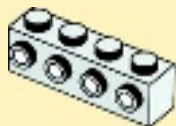

2

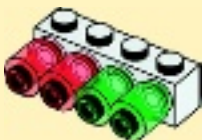

3



4

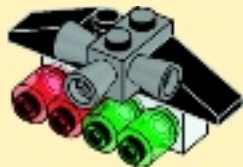

6

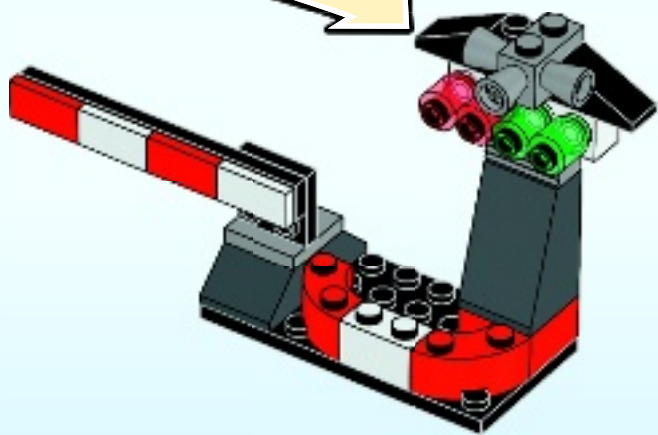



1x



1x



1x

7

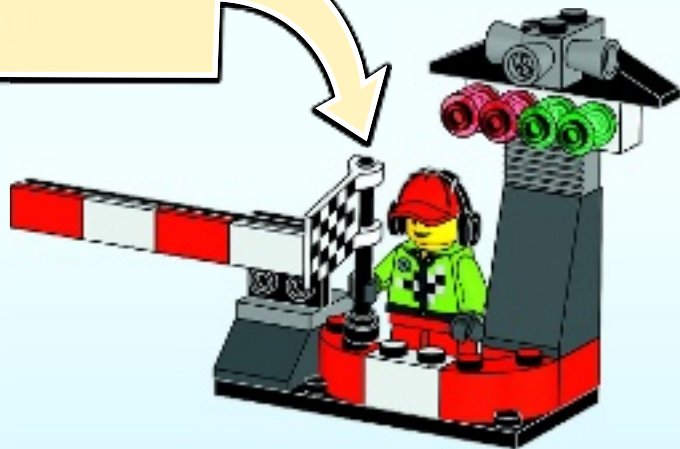
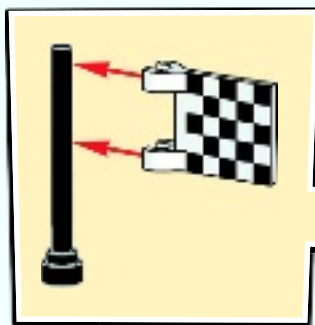



1x



1x

1

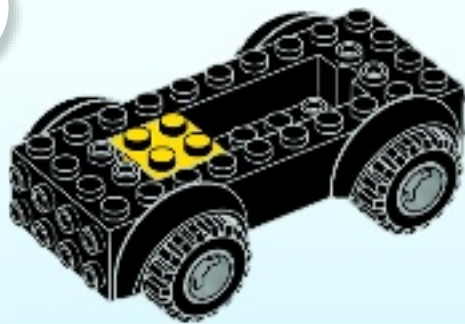



2

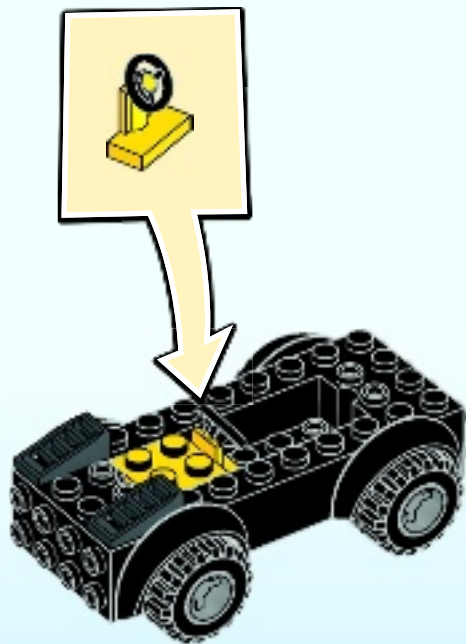

3

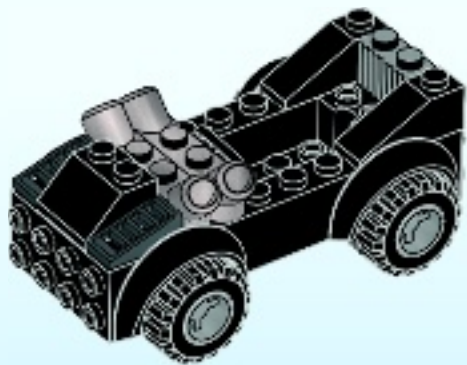

2x



1x



1x



2x



1x



2x



4

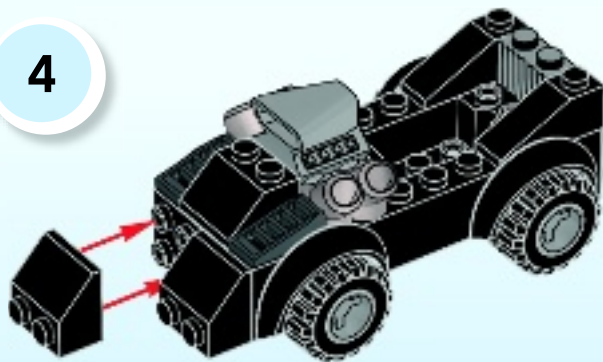

5

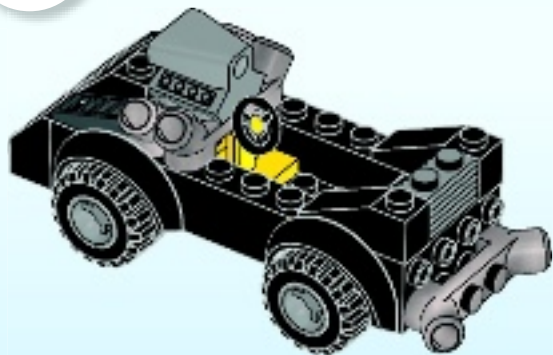

6

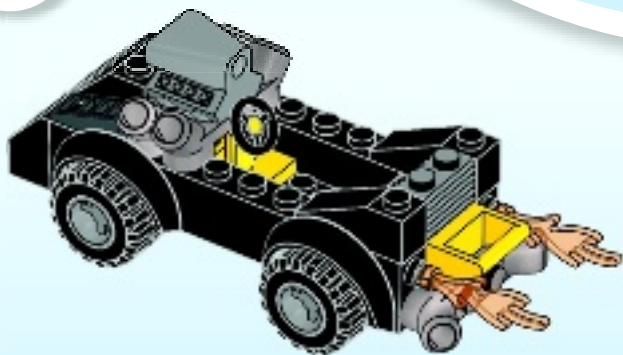

1x



2x



1x



1x



2x



2x

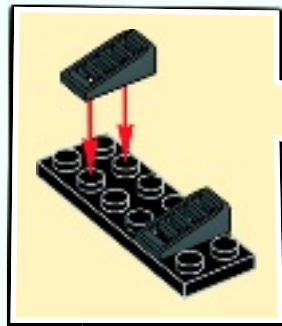

7



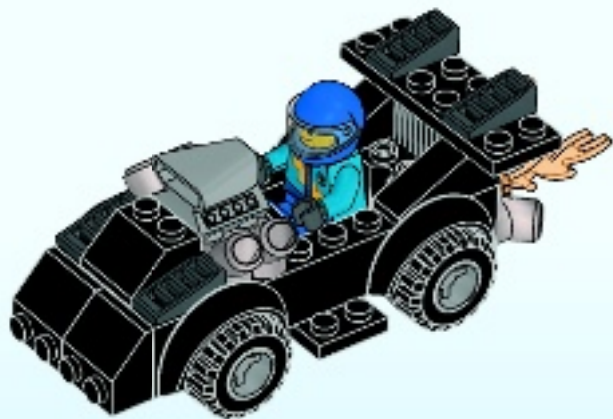
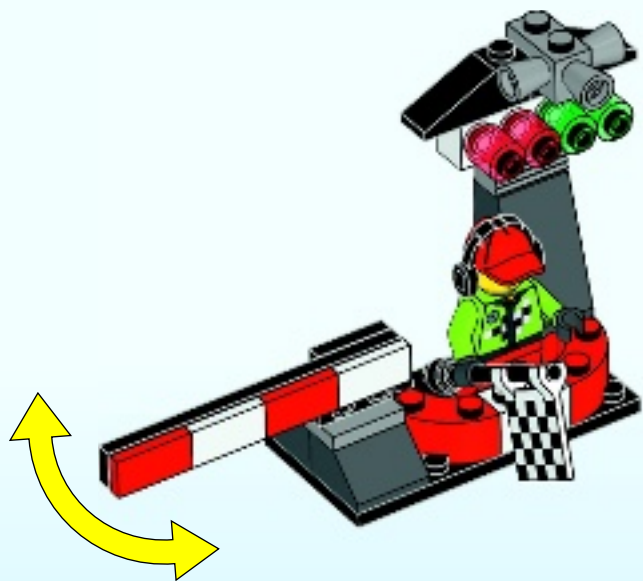

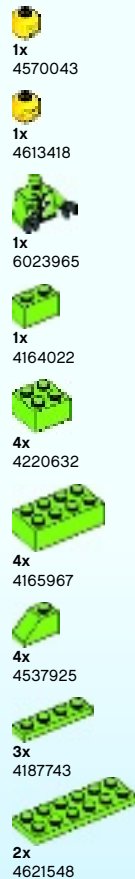
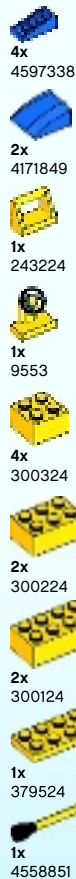
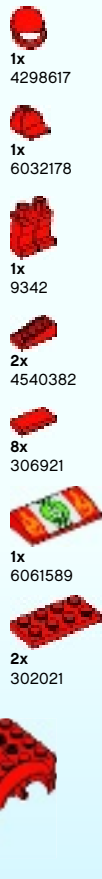
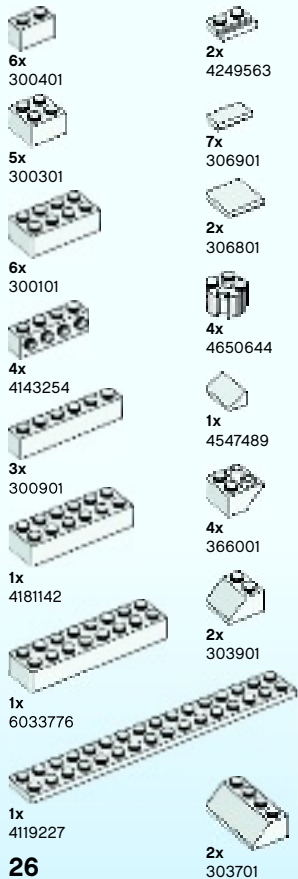

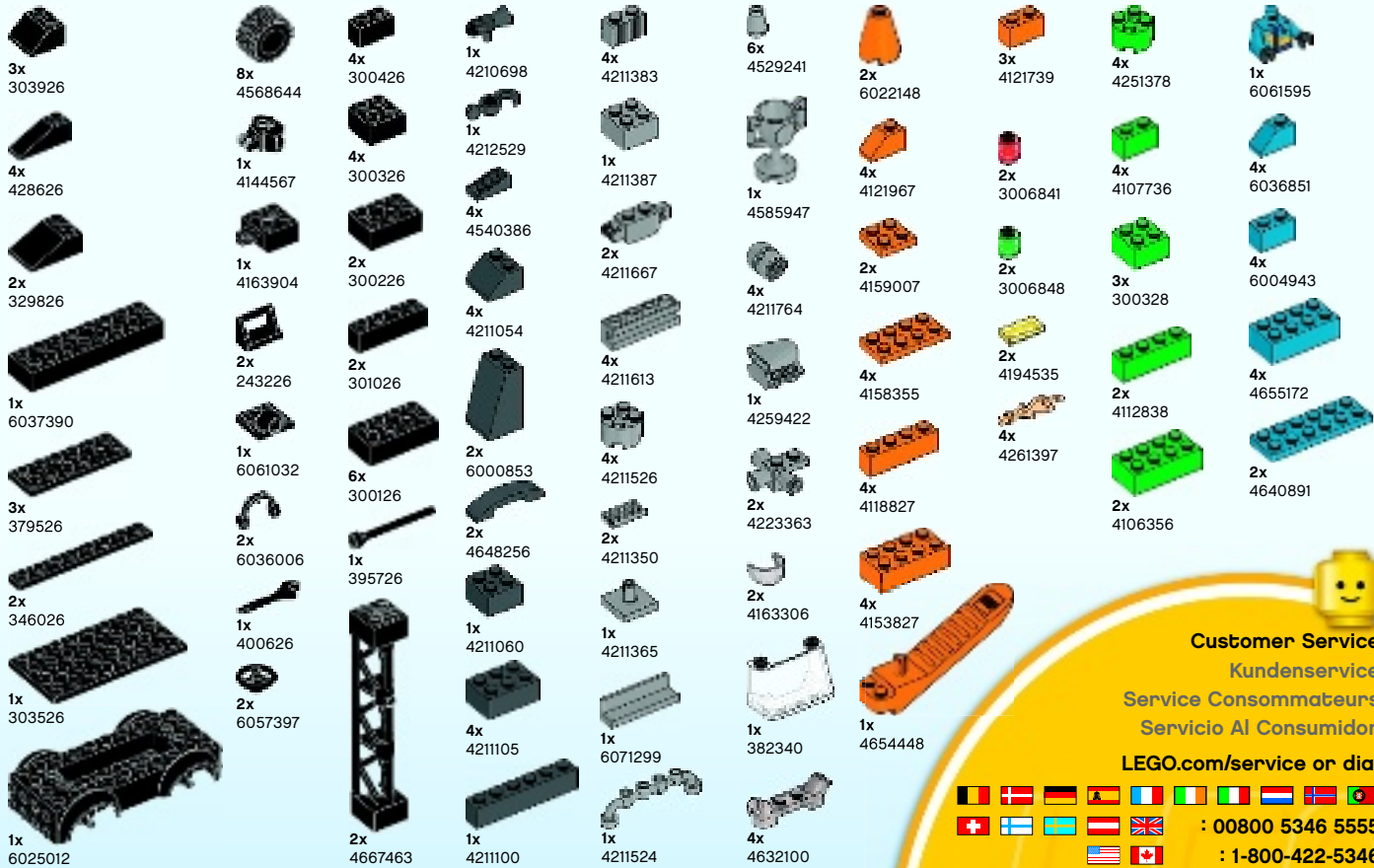

Customer Service
Kundenservice
Service Consommateurs
Servicio Al Consumidor
LEGO.com/service or dial



: 00800 5346 5555
: 1-800-422-5346



LEGO.com/Juniors



App



Games
Jeux
Juegos



Find more building instructions online
Trouve d'autres instructions de montage en ligne
Más instrucciones de construcción disponibles en Internet



6072716

LEGO and the LEGO logo are trademarks of the/
sont des marques de commerce de/son marcas
registradas de LEGO Group. ©2014 The LEGO Group.