



DREAMWORKS  
**GABBY'S  
DOLLHOUSE**

10788





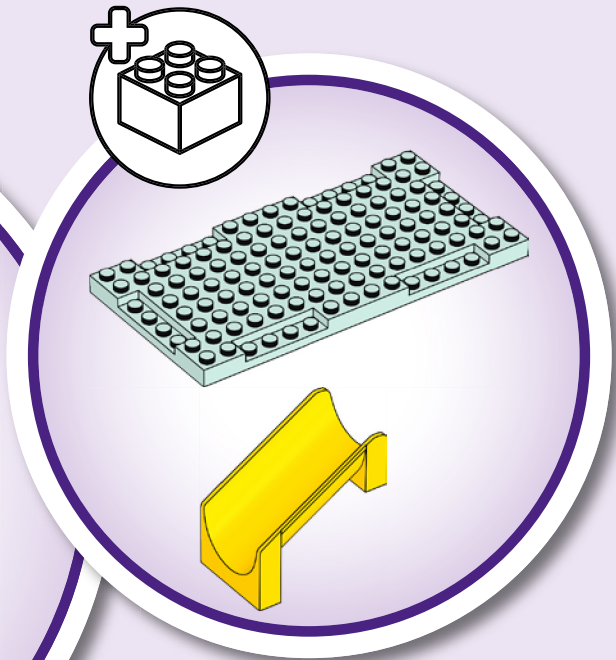

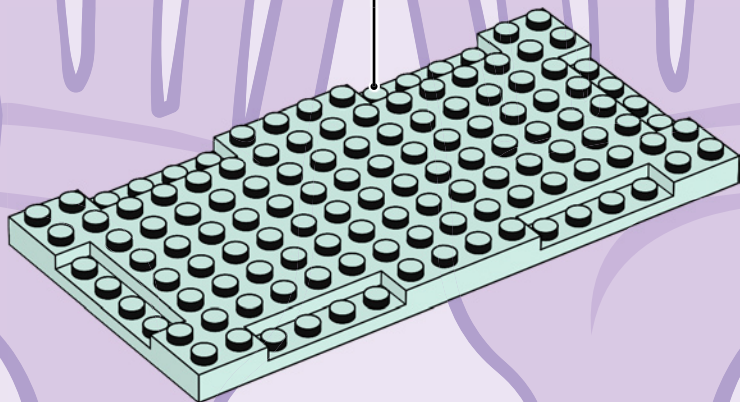
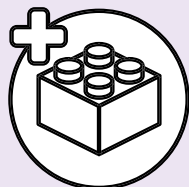

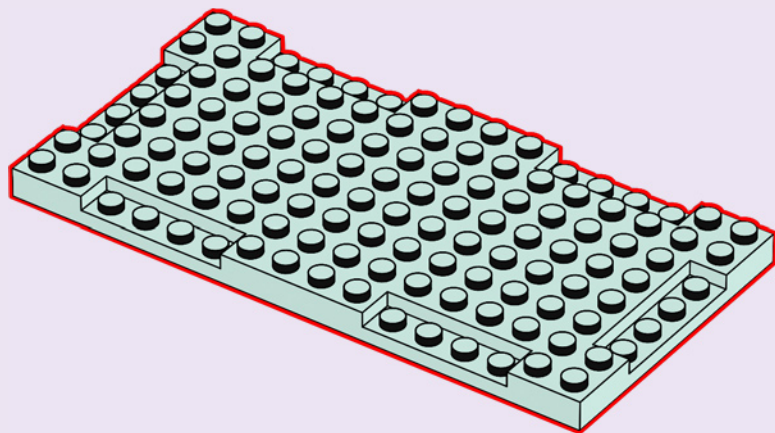

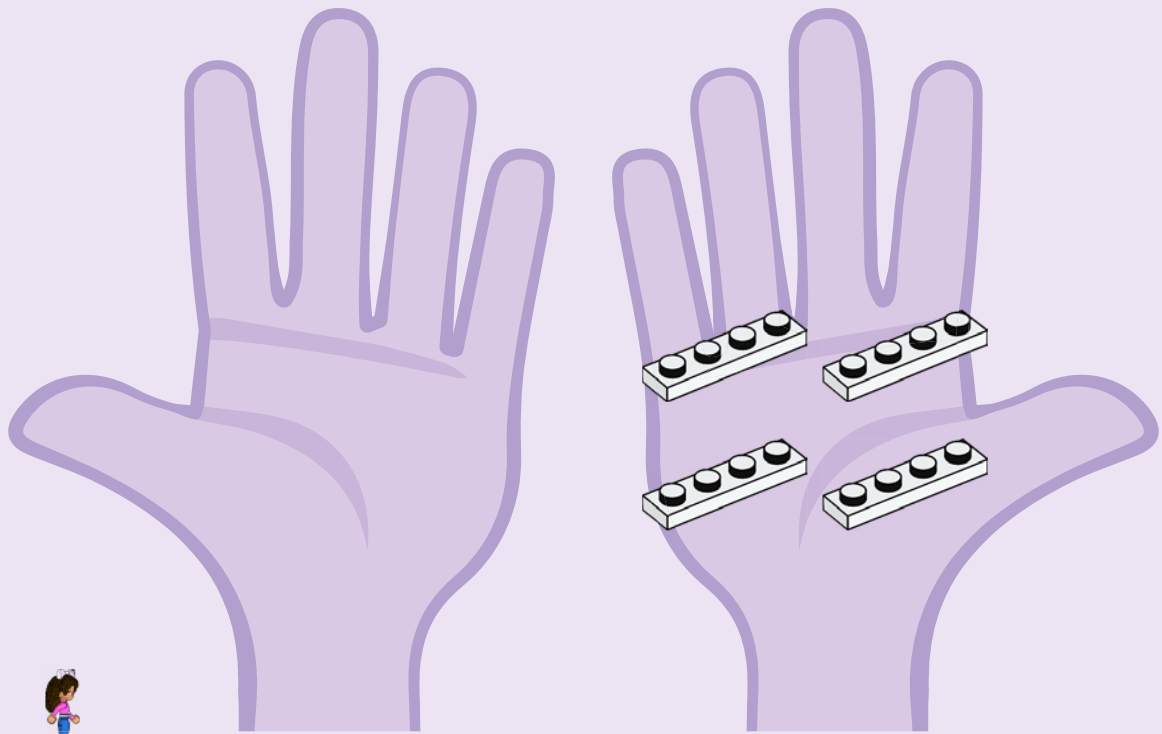



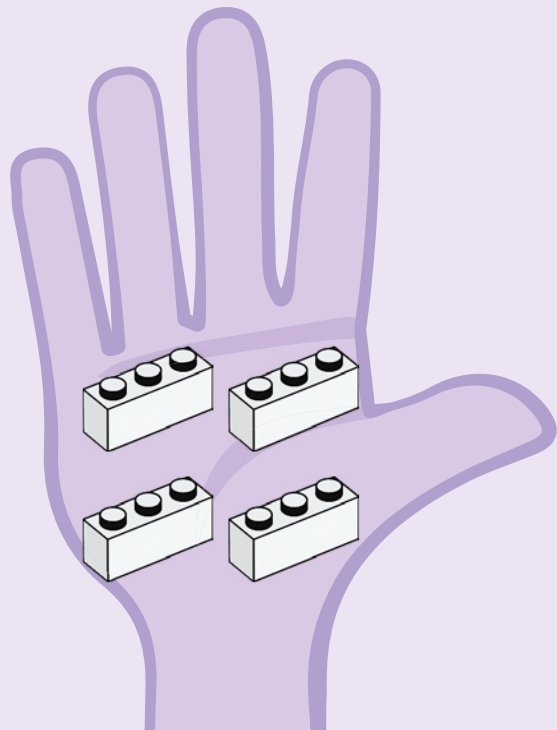
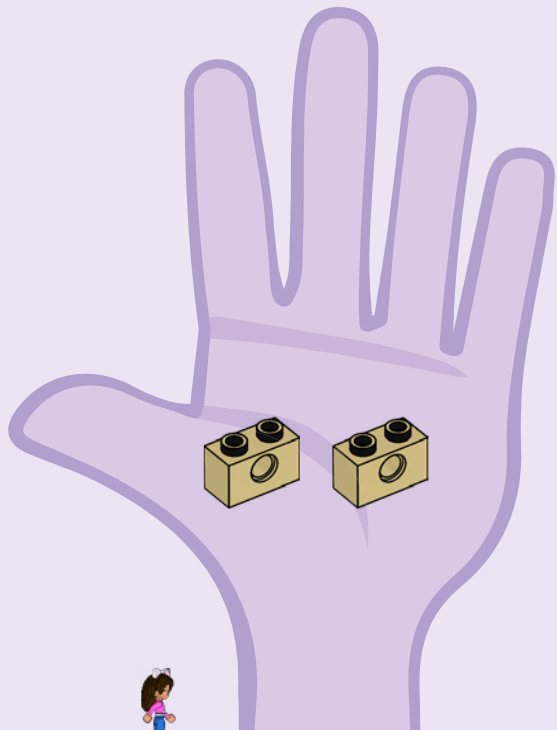



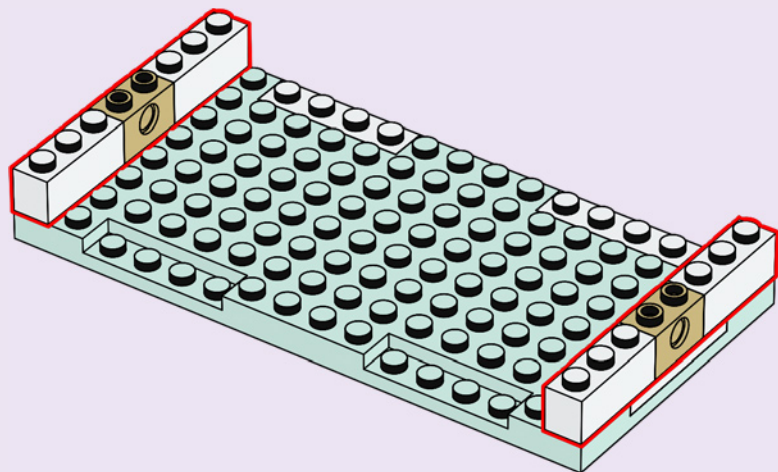

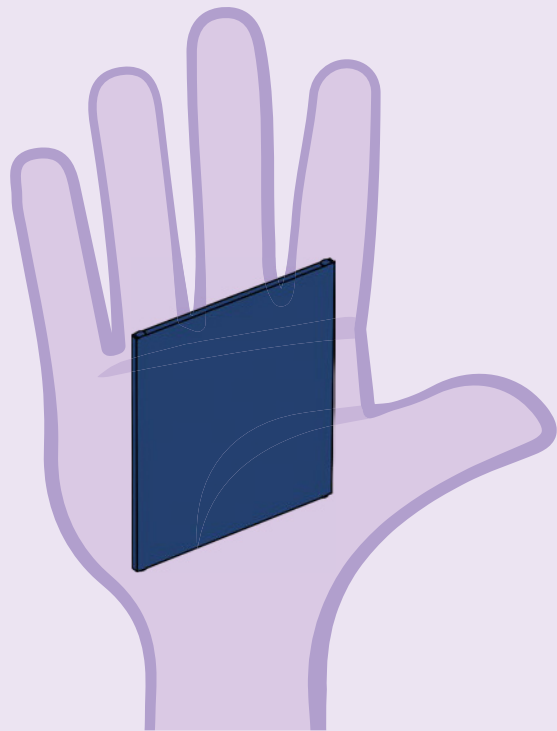
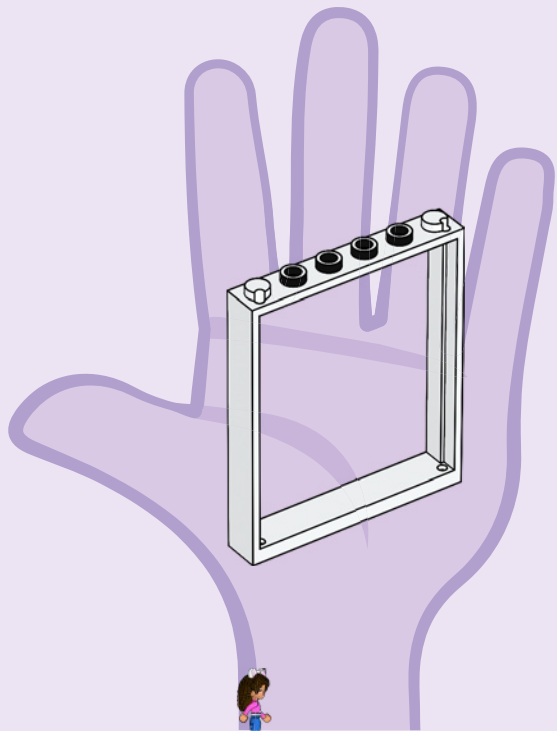

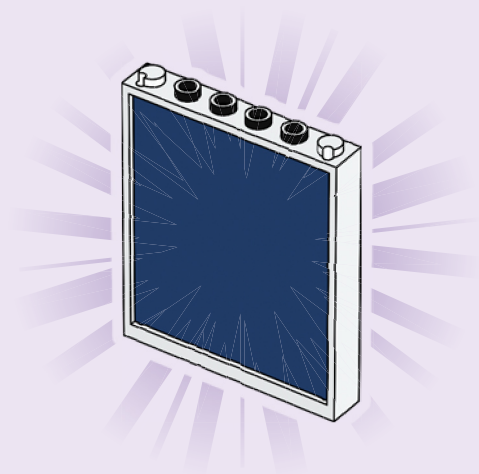
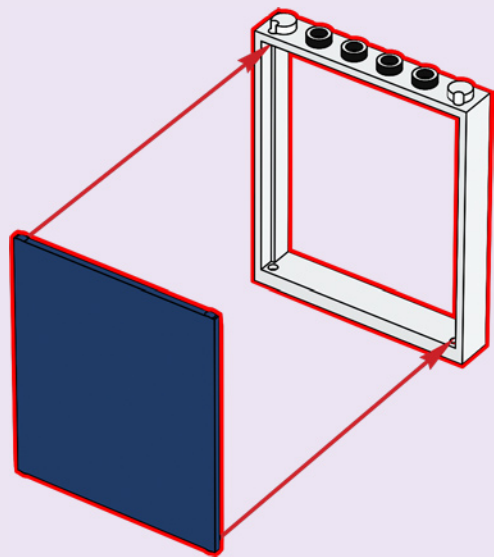

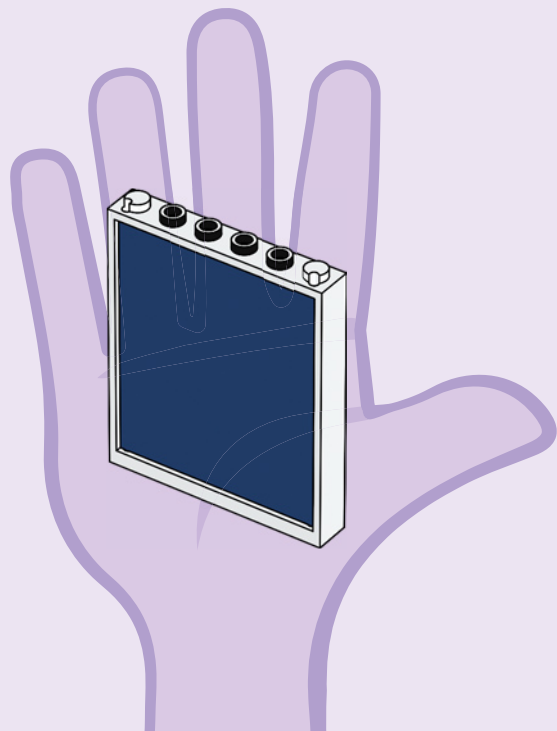

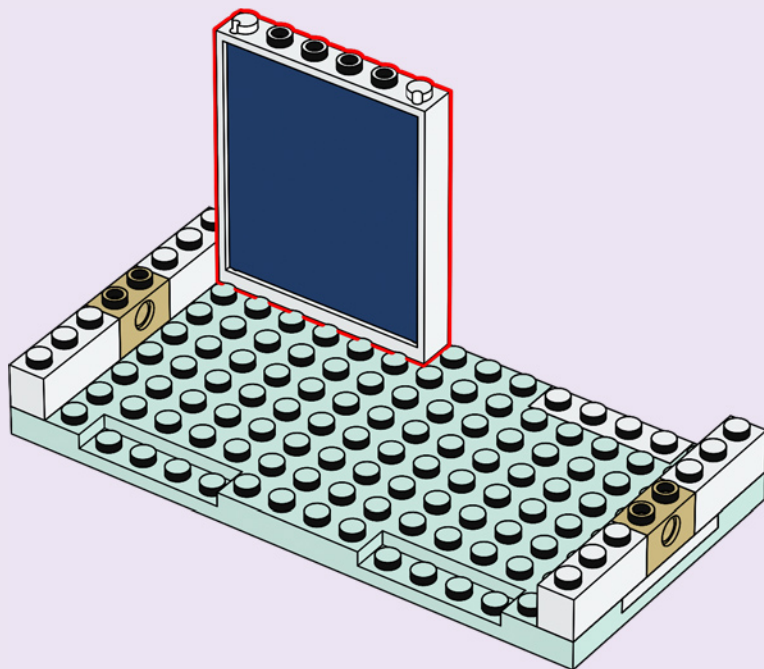

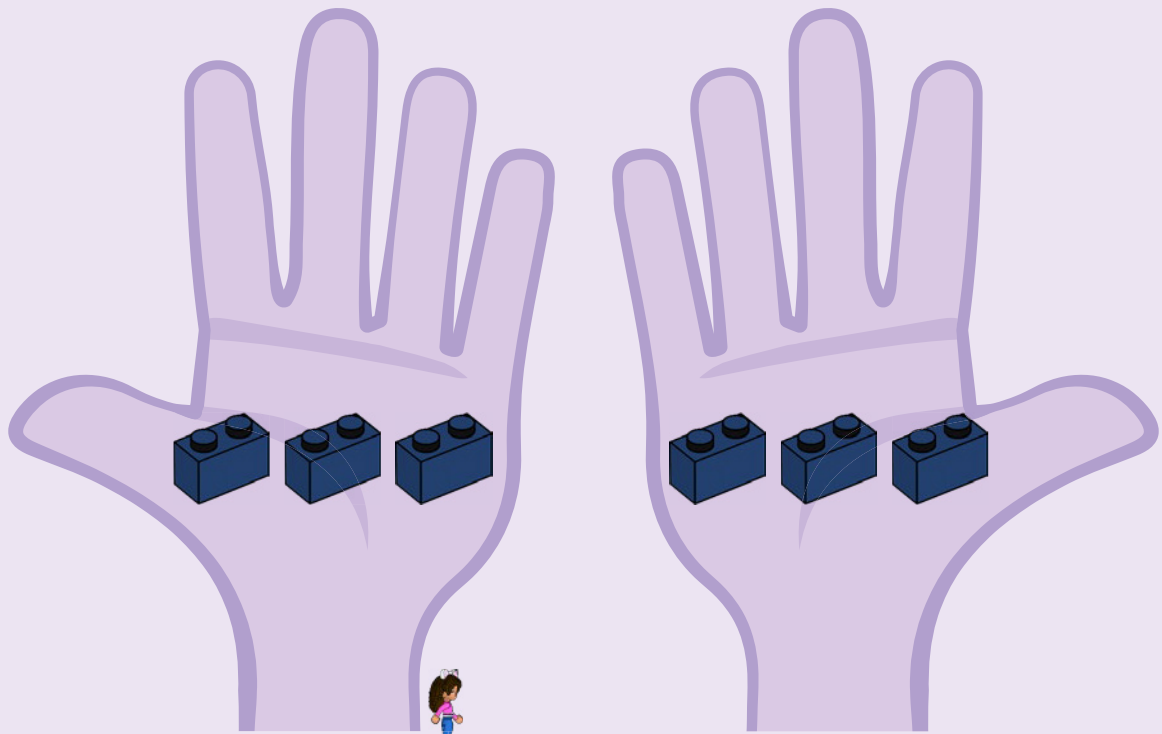

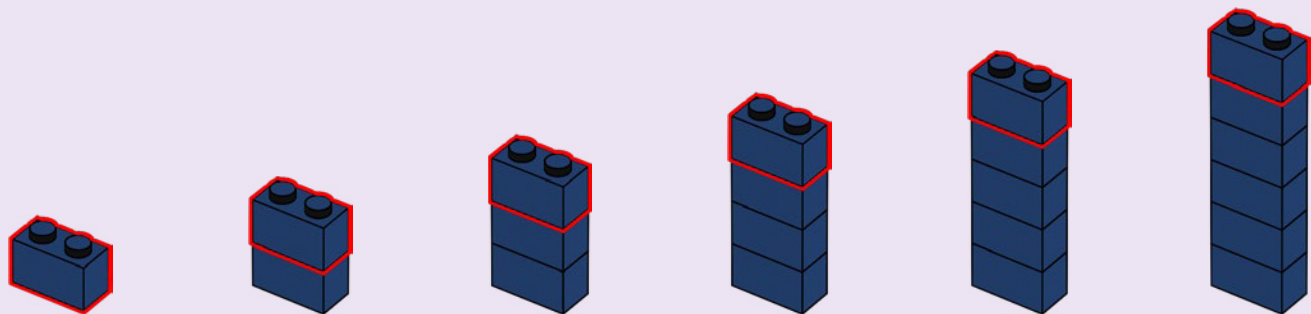

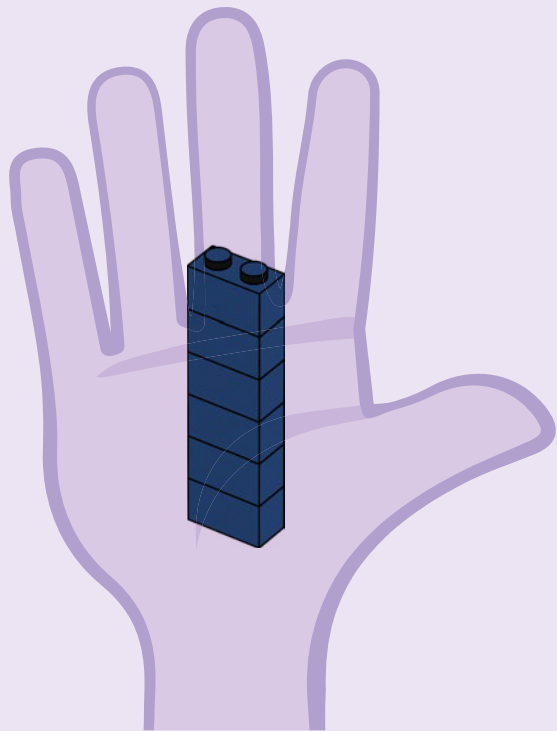



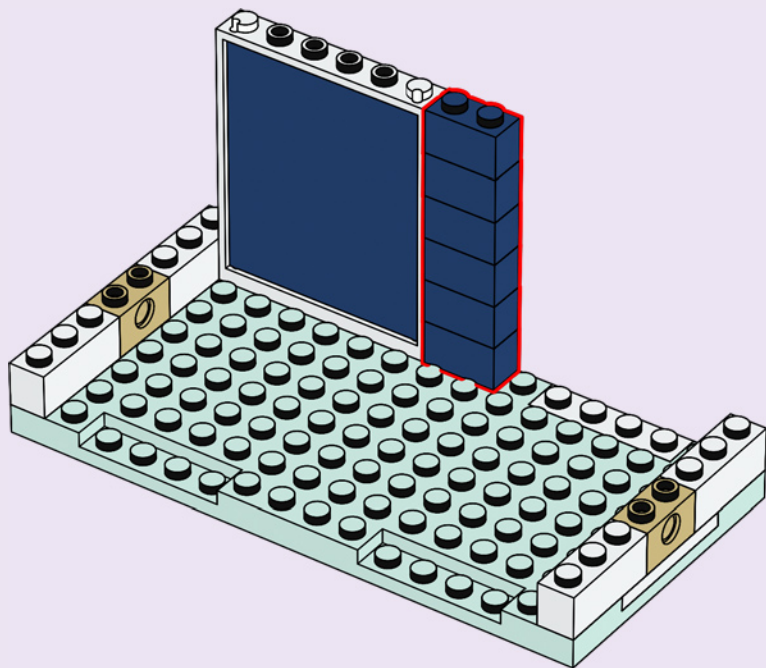

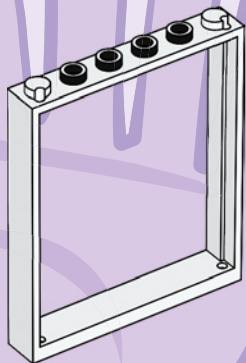

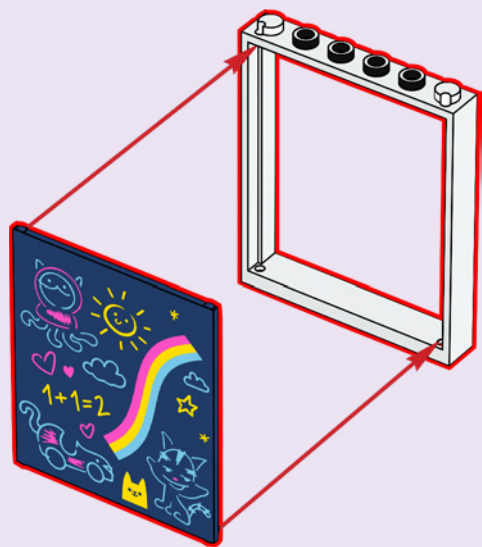



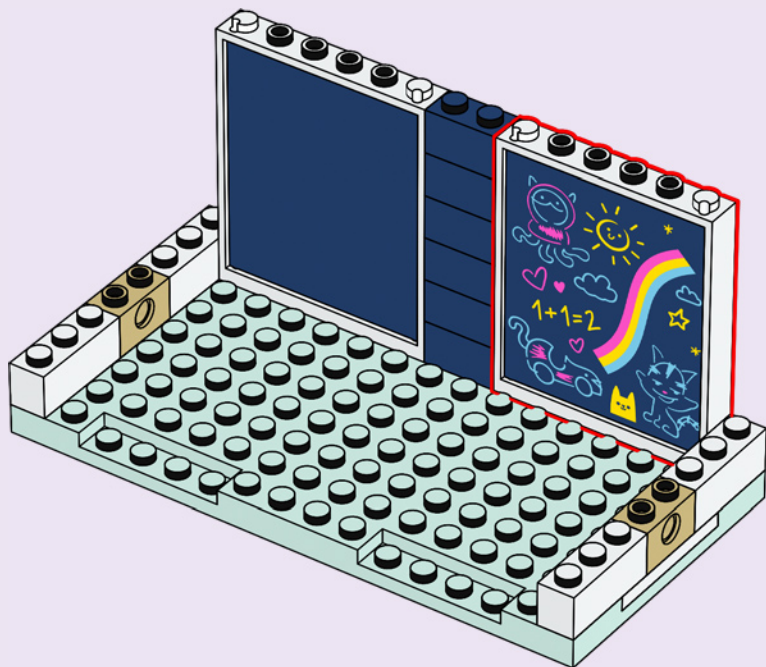

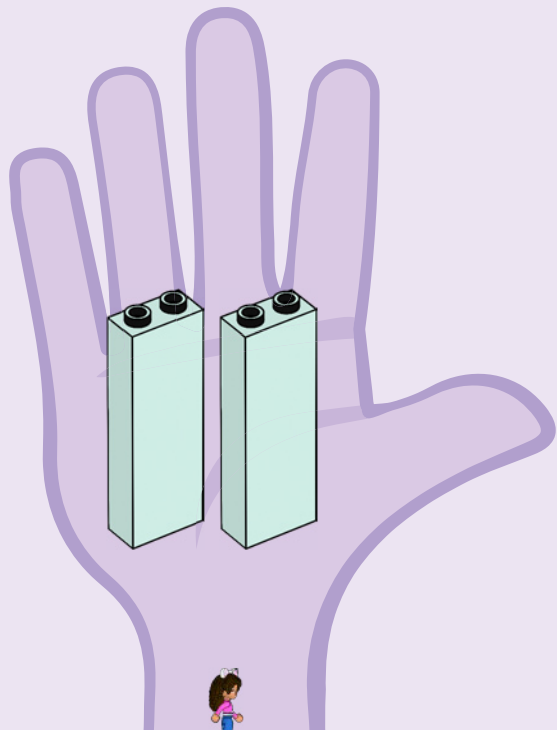

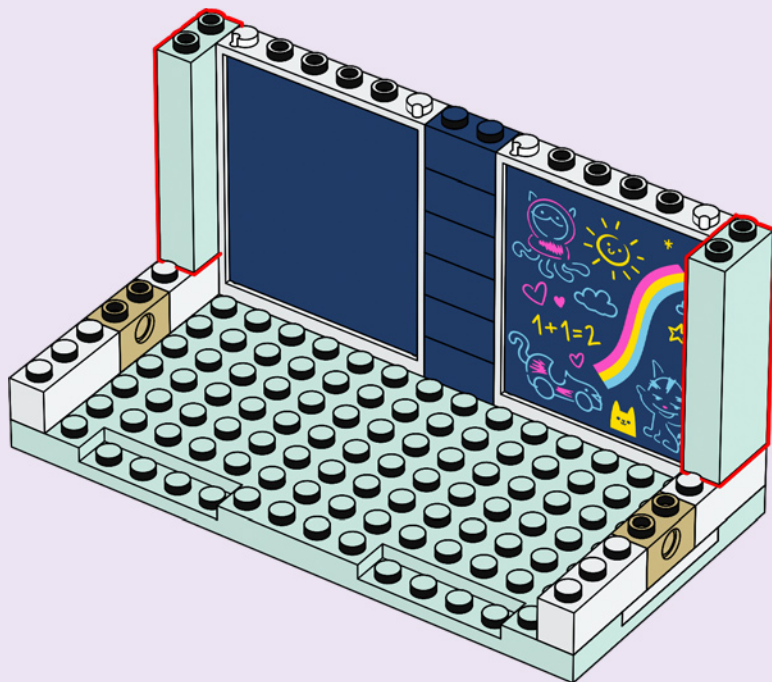

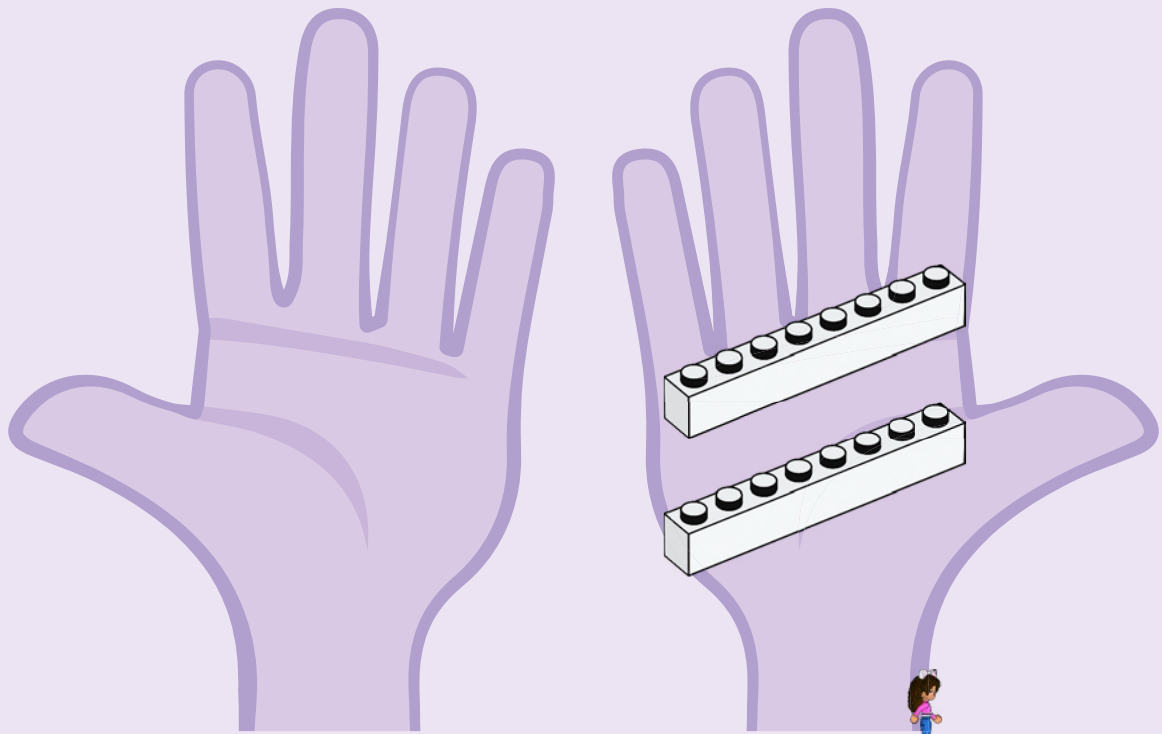



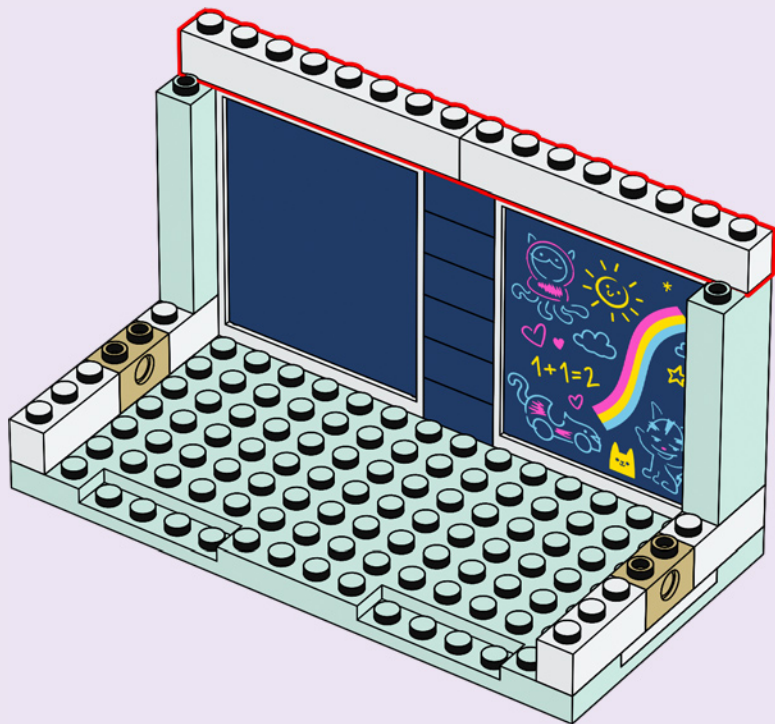

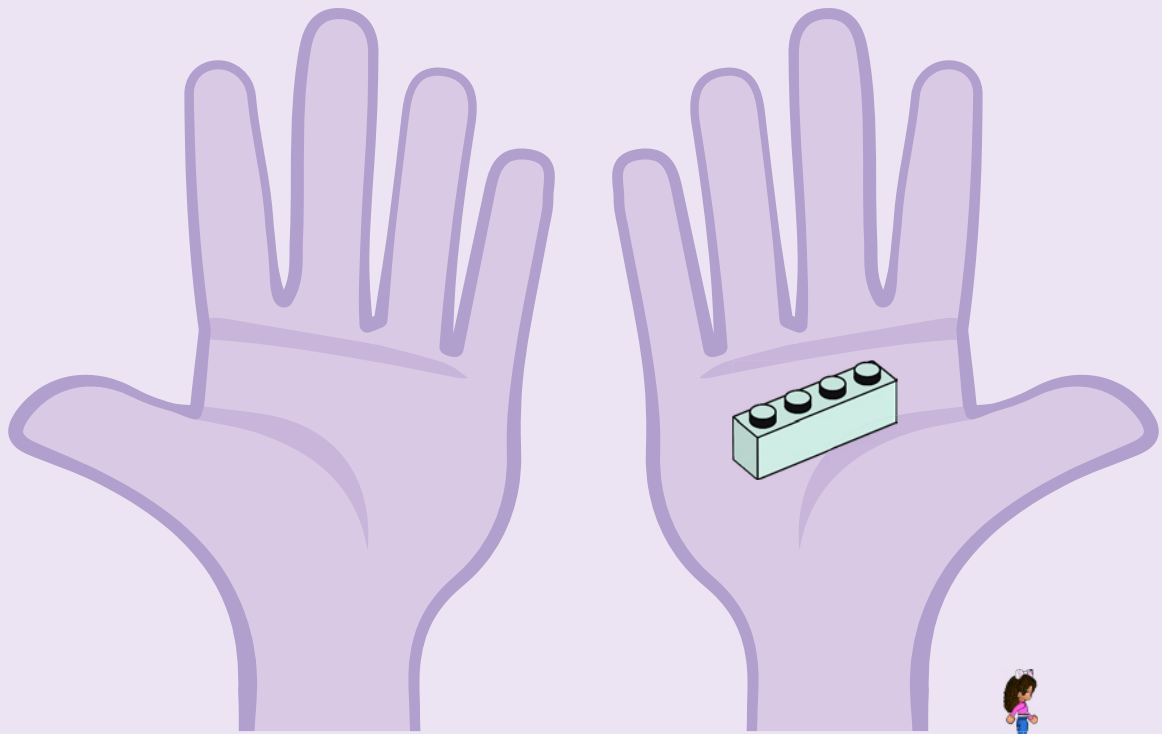

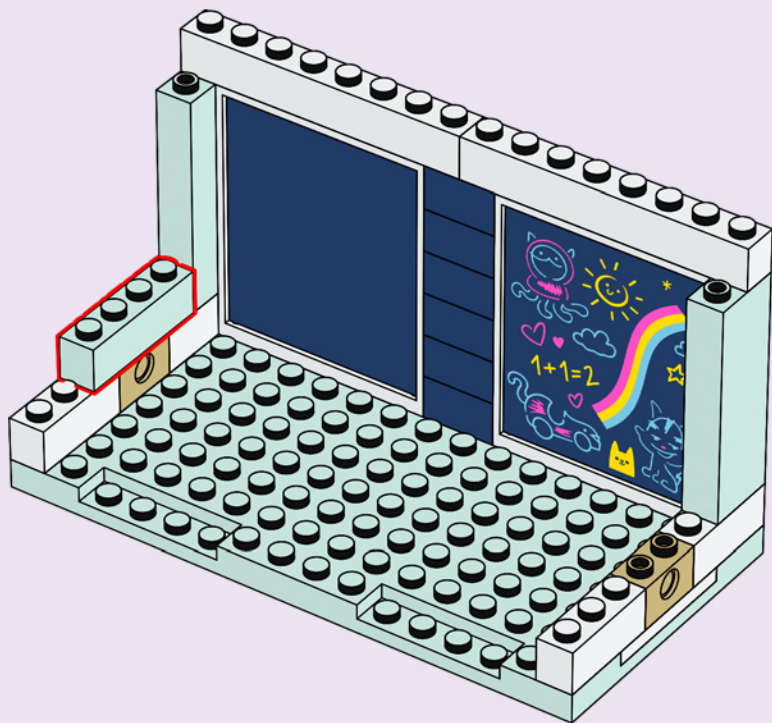

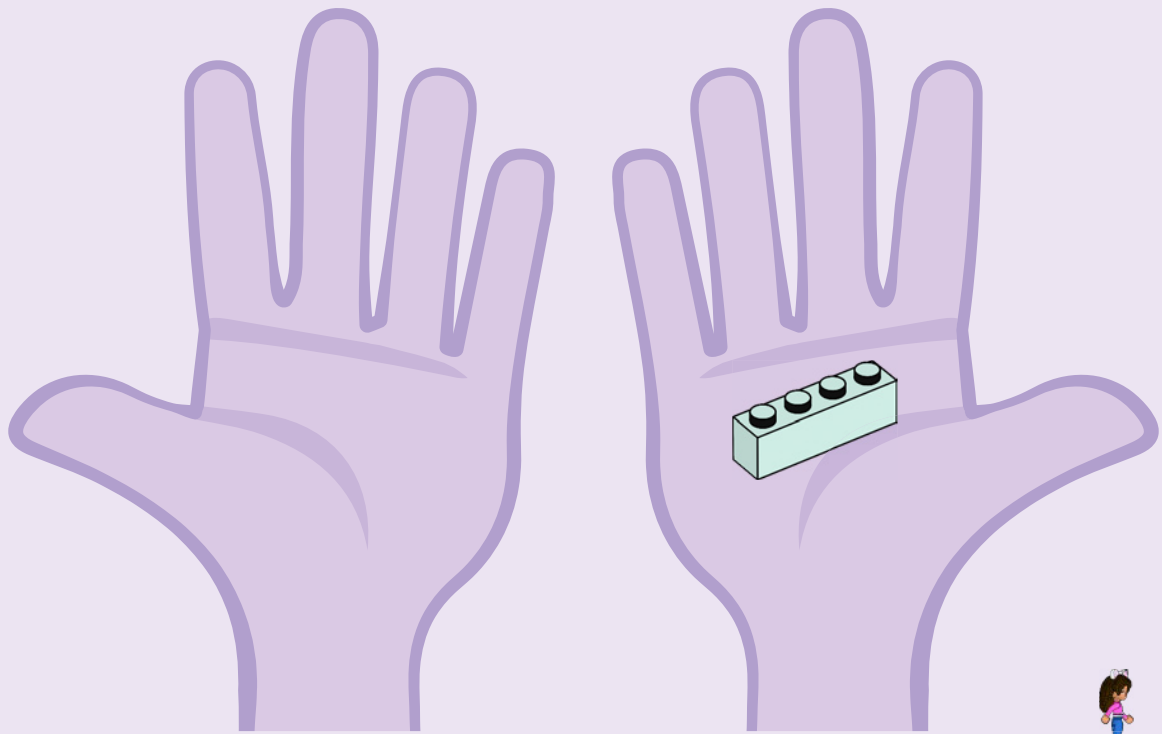

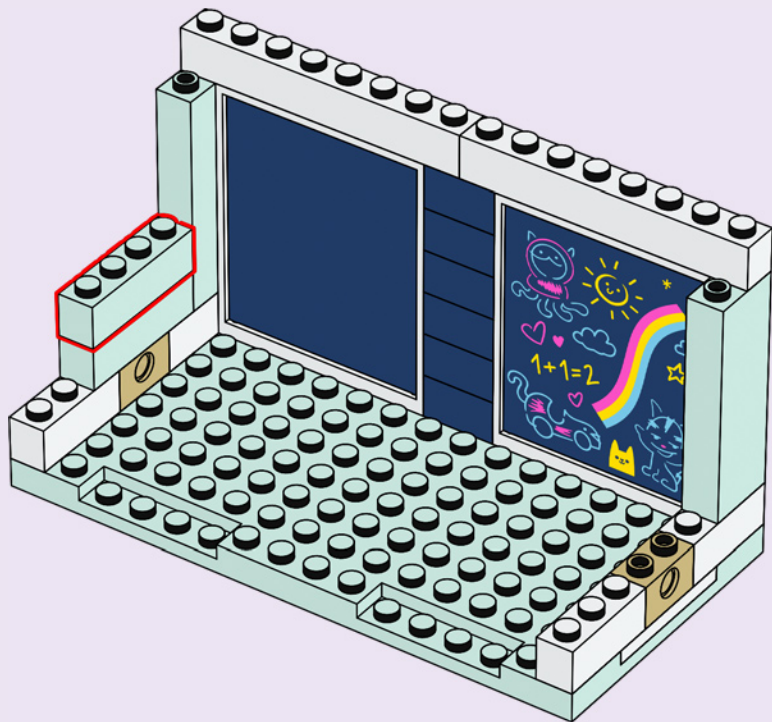

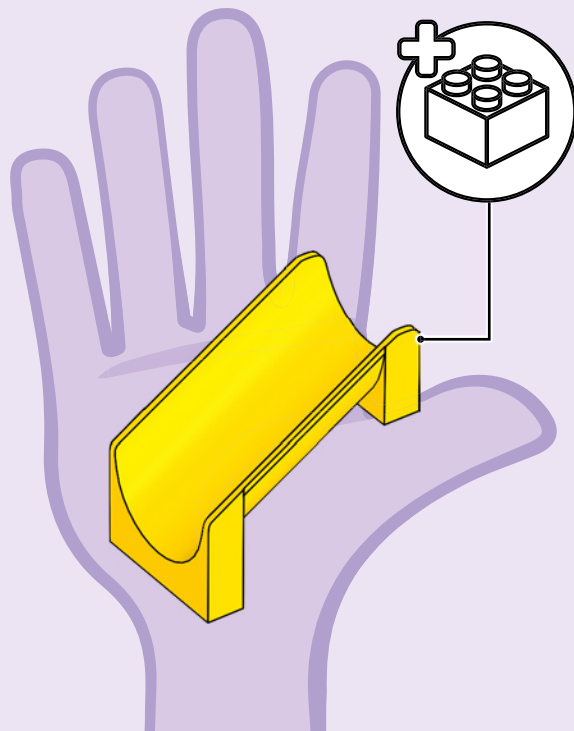

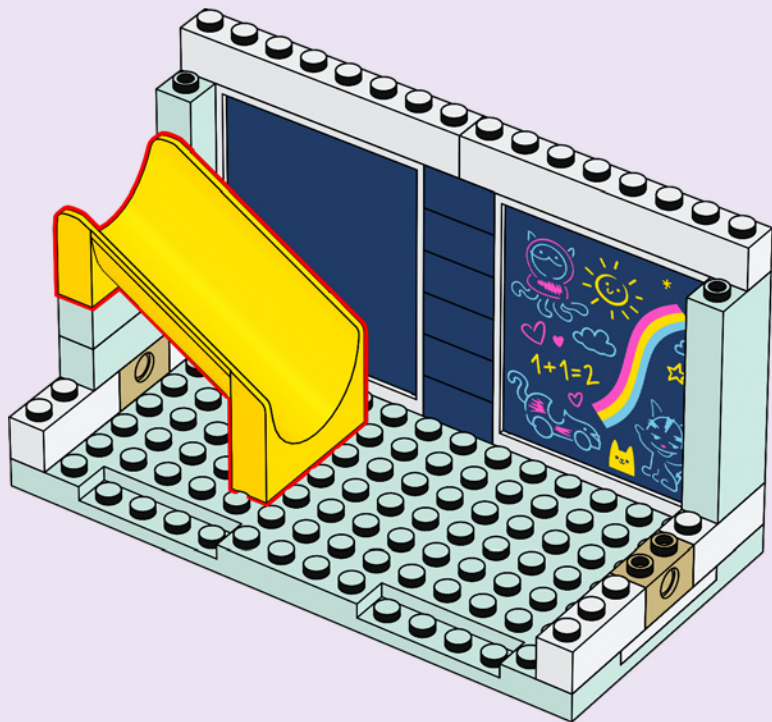

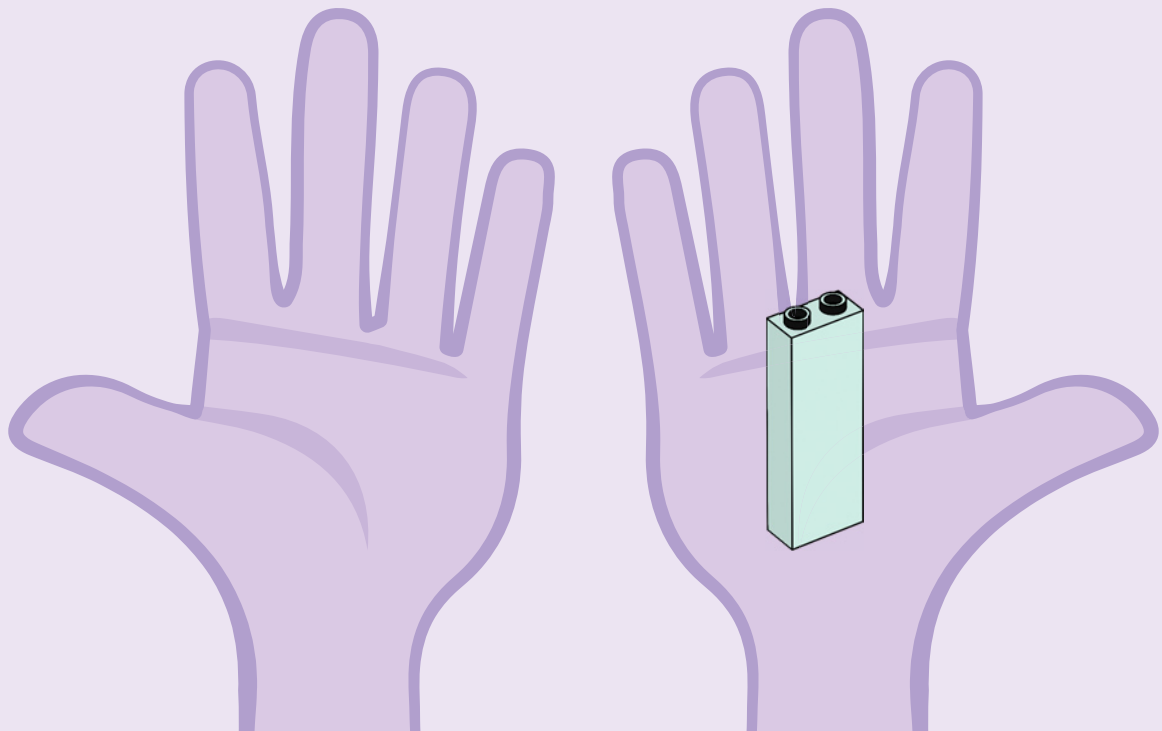



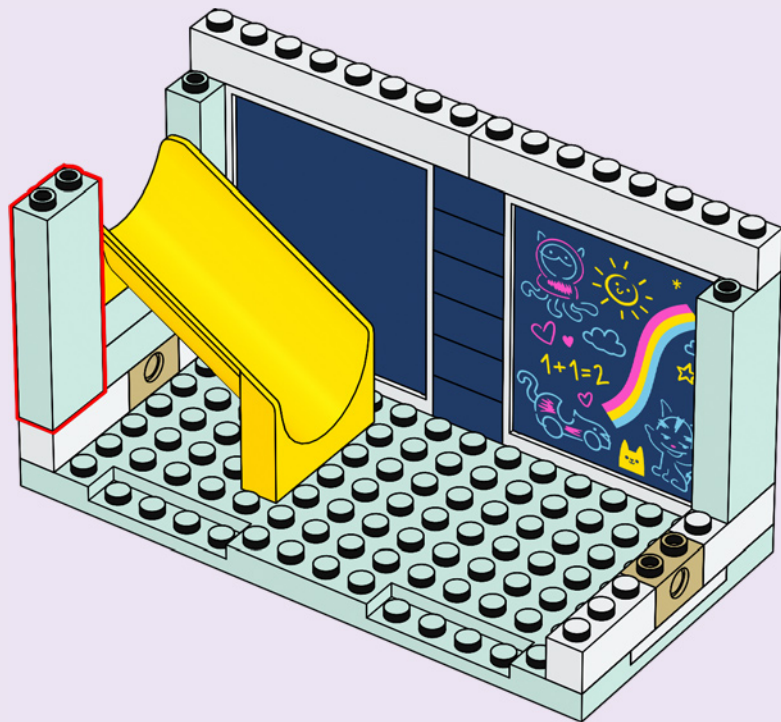

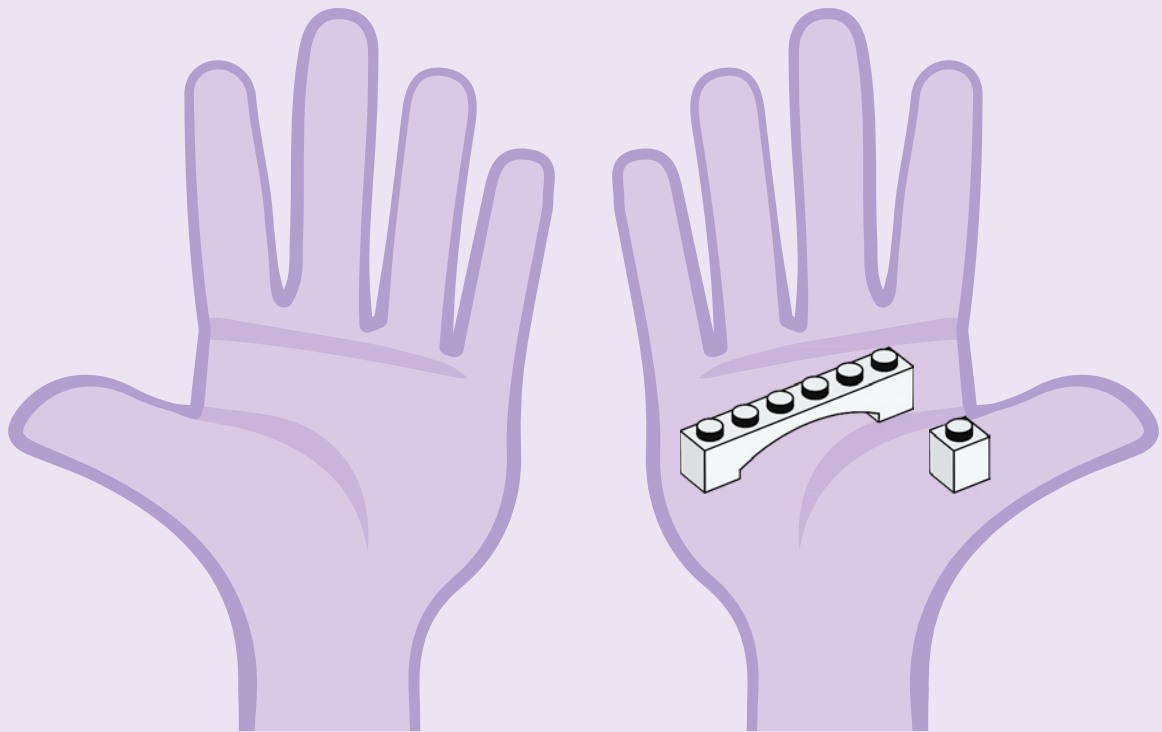

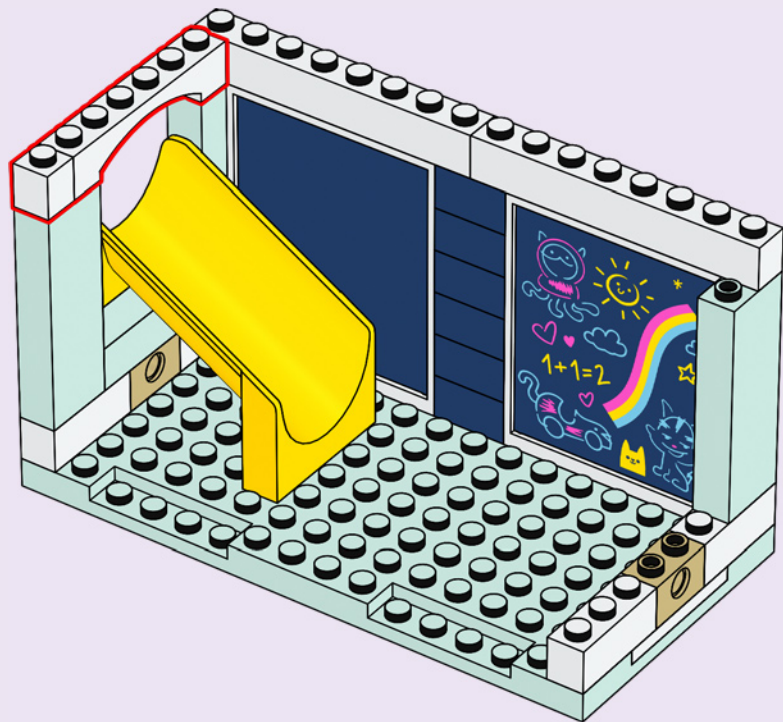

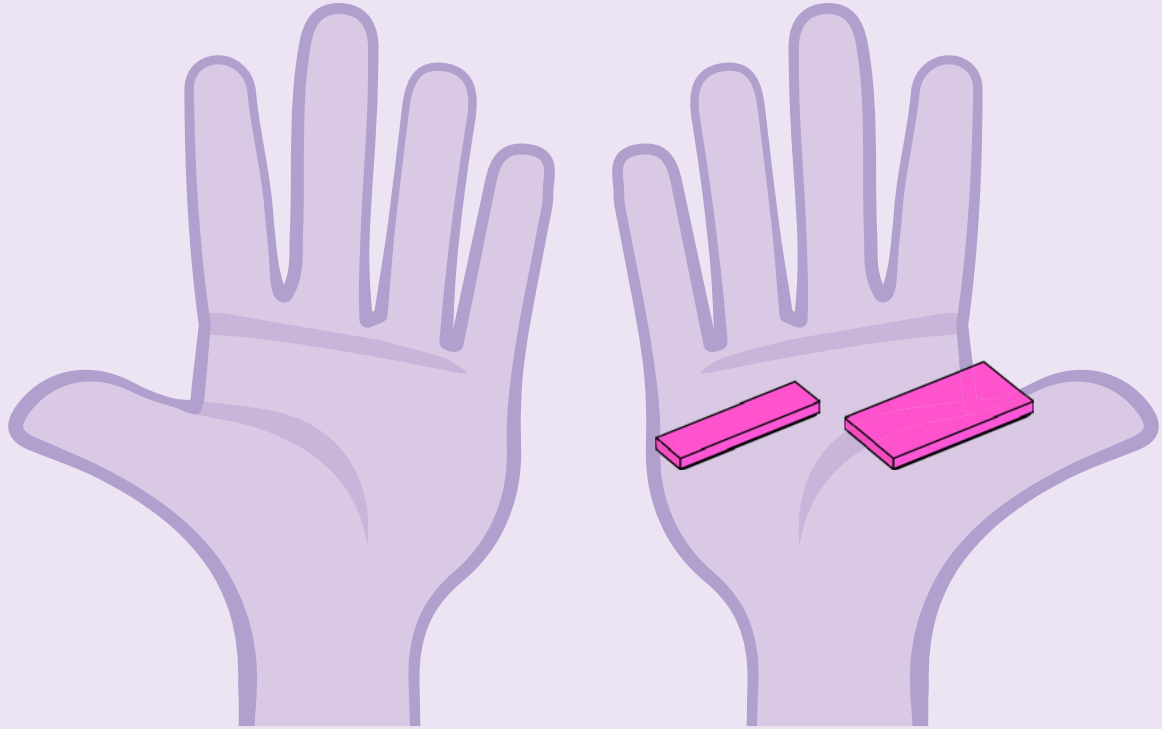

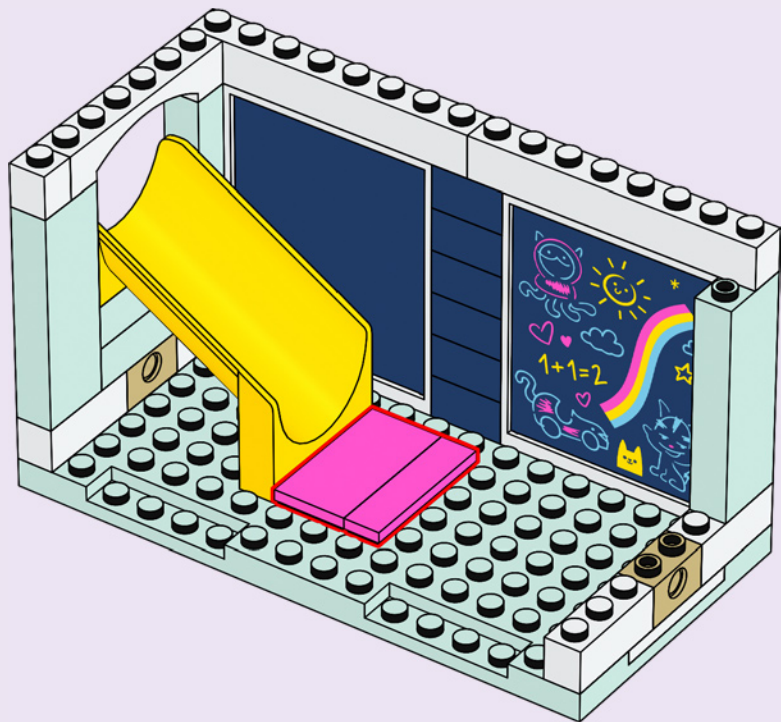

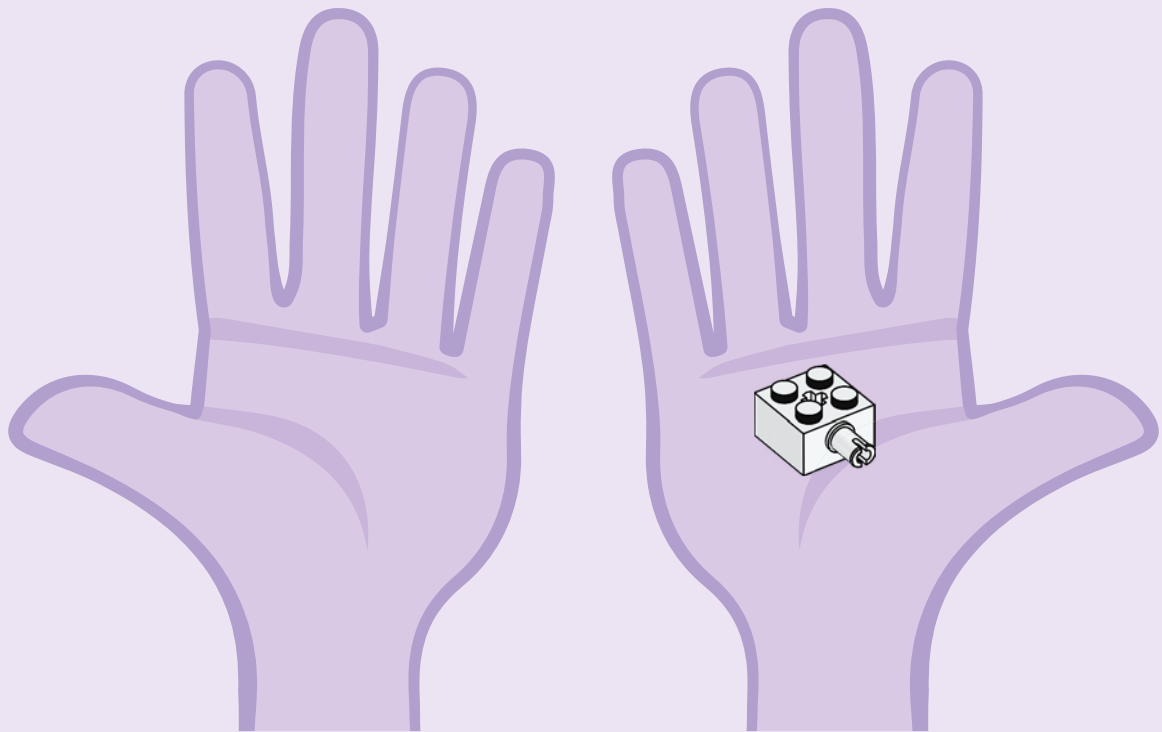

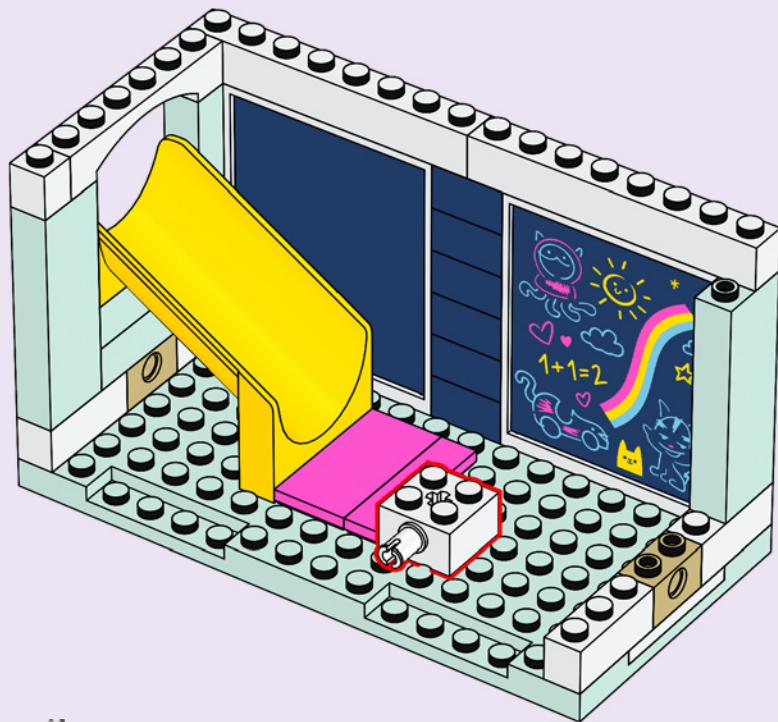

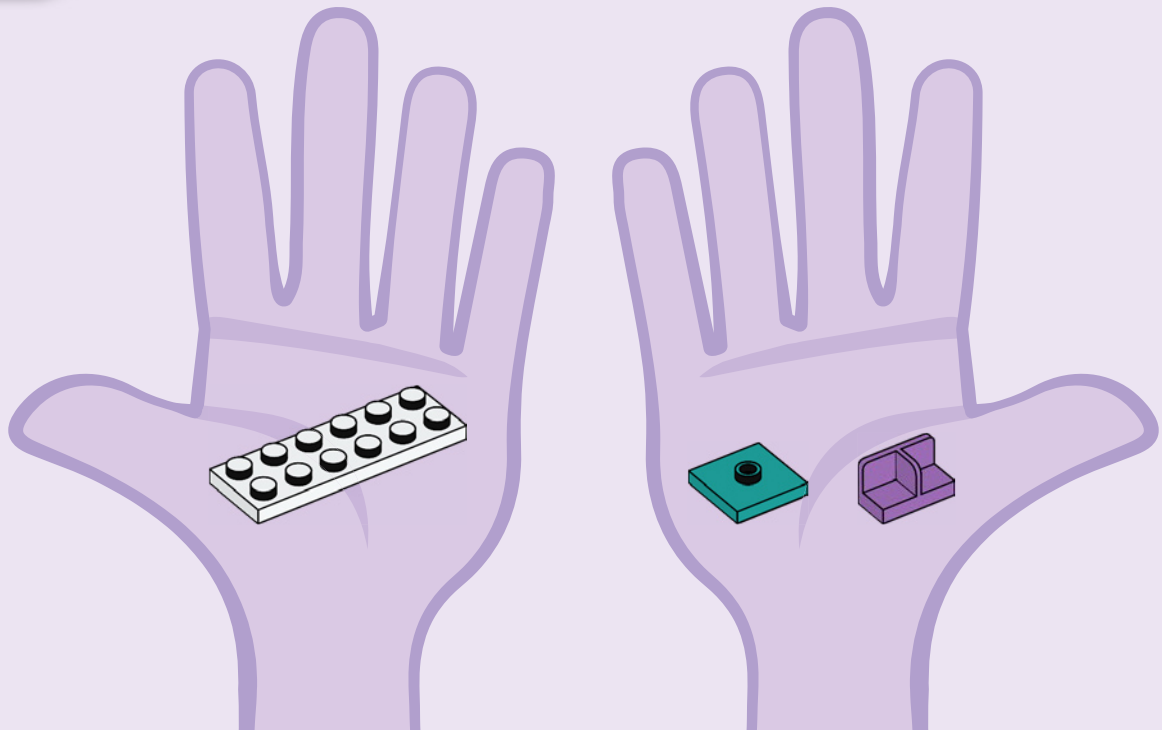



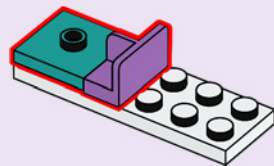

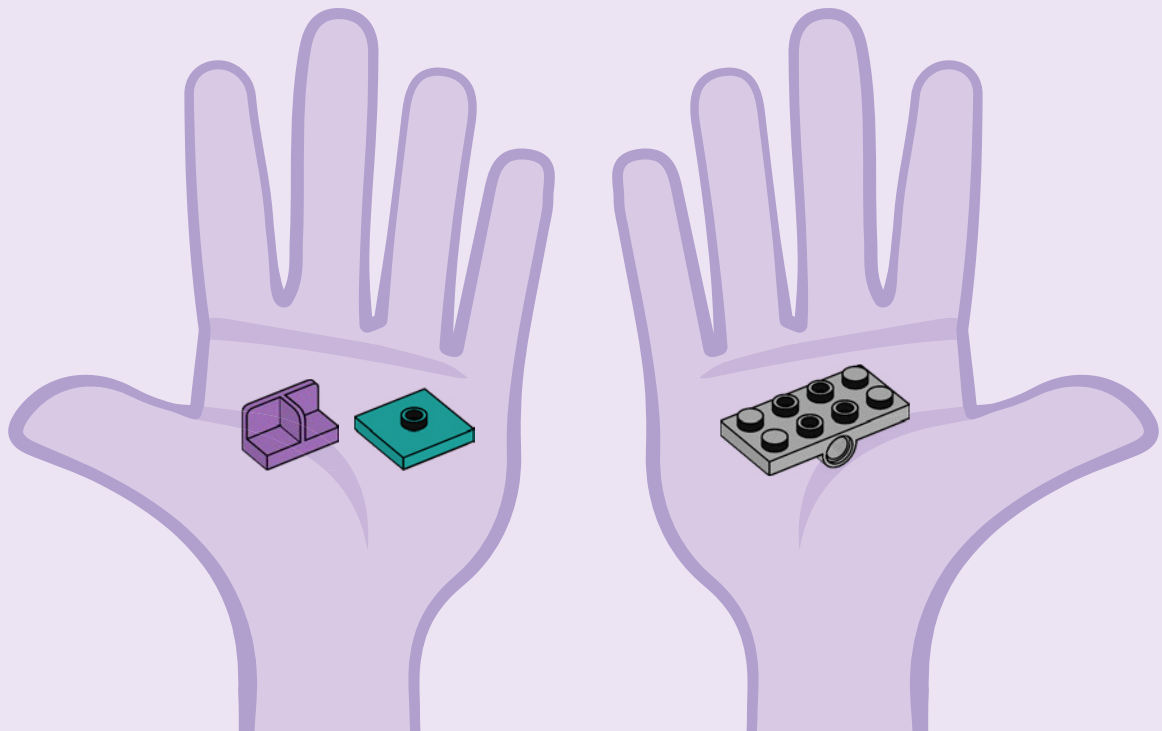

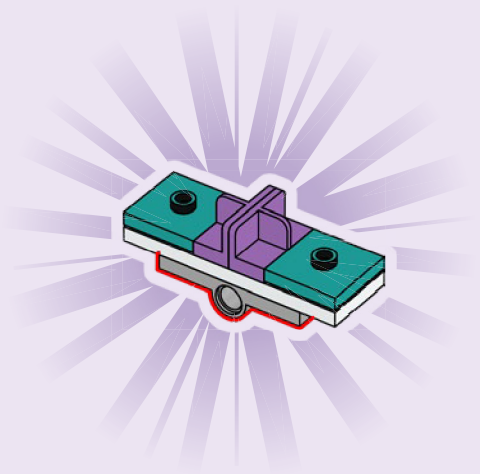
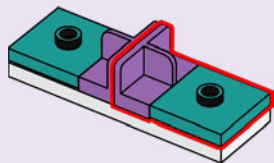

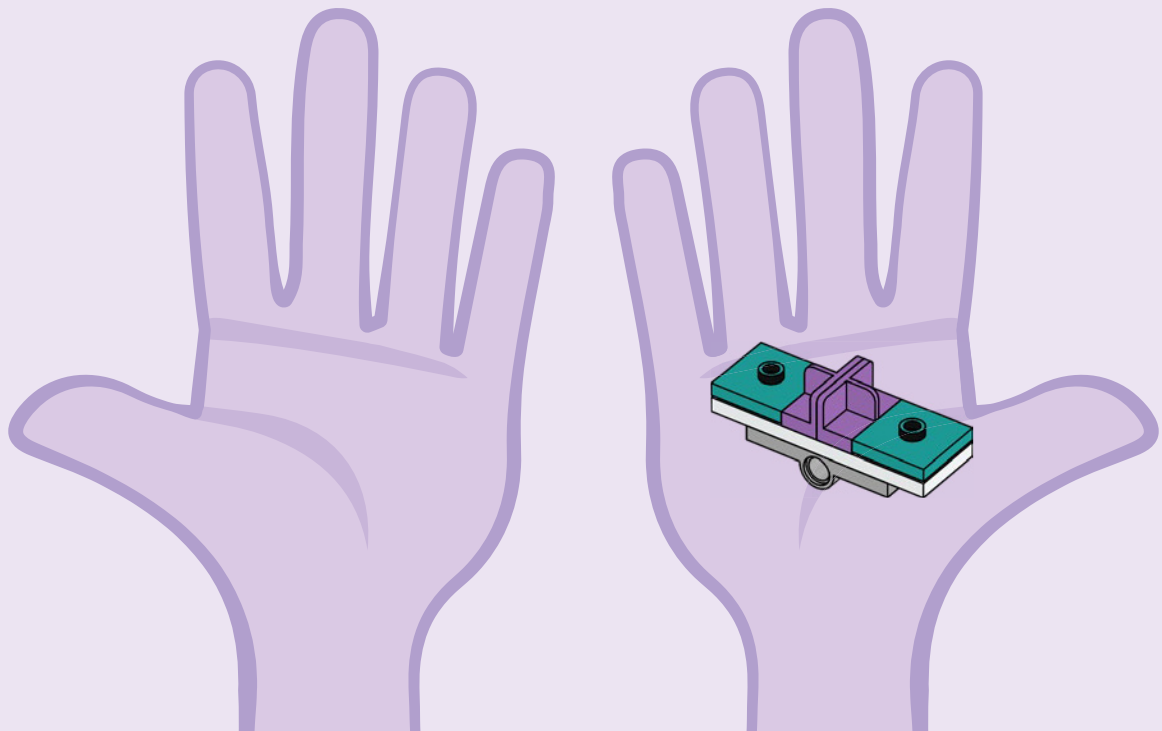

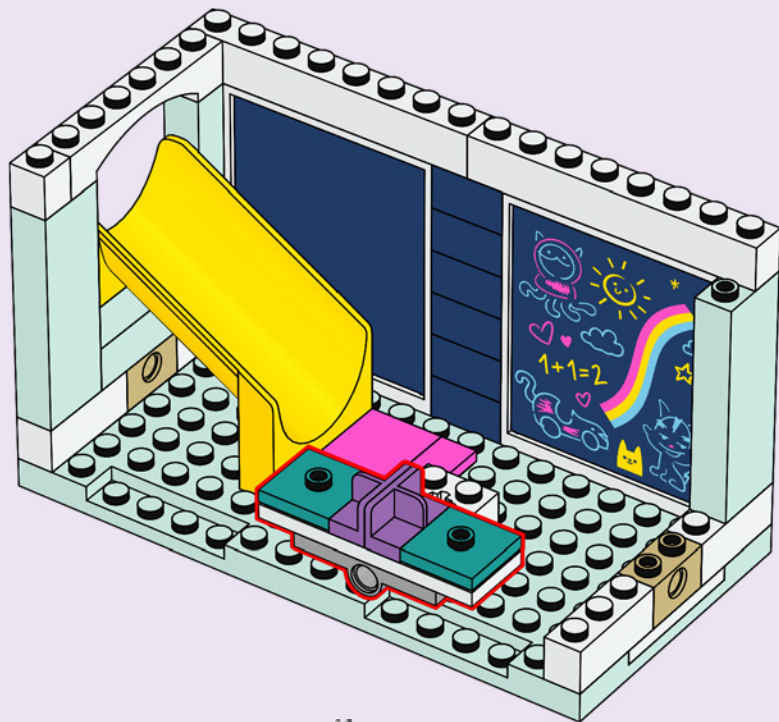

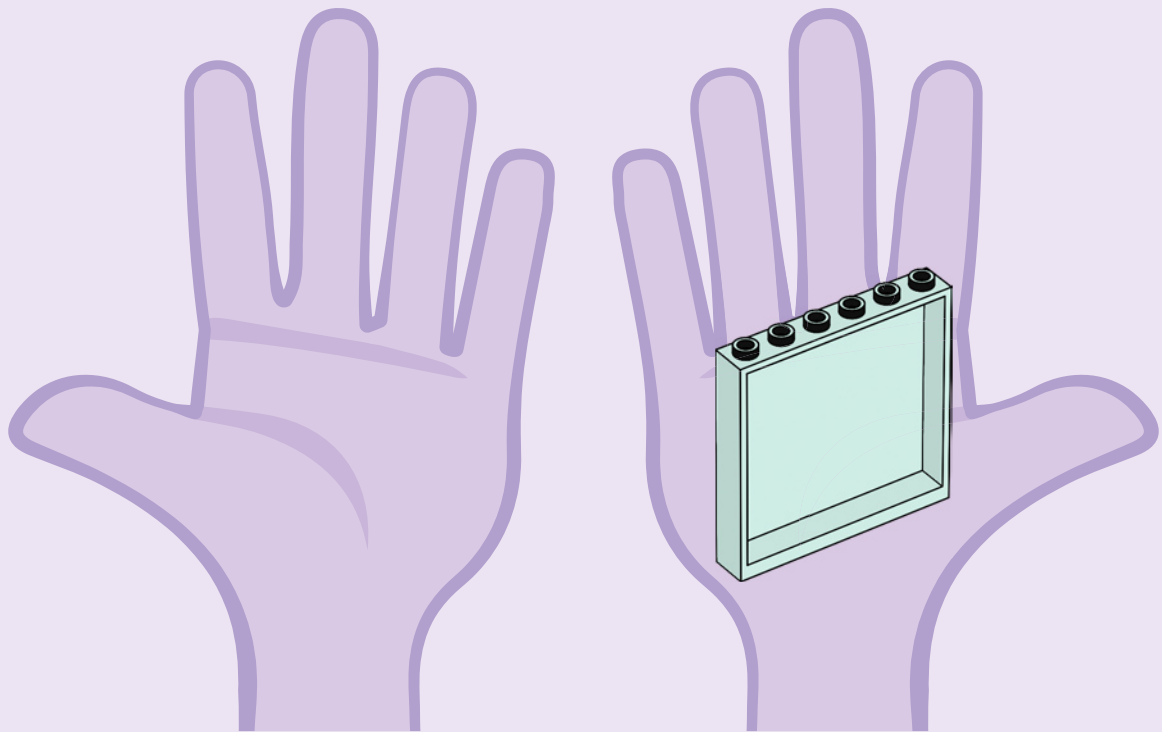

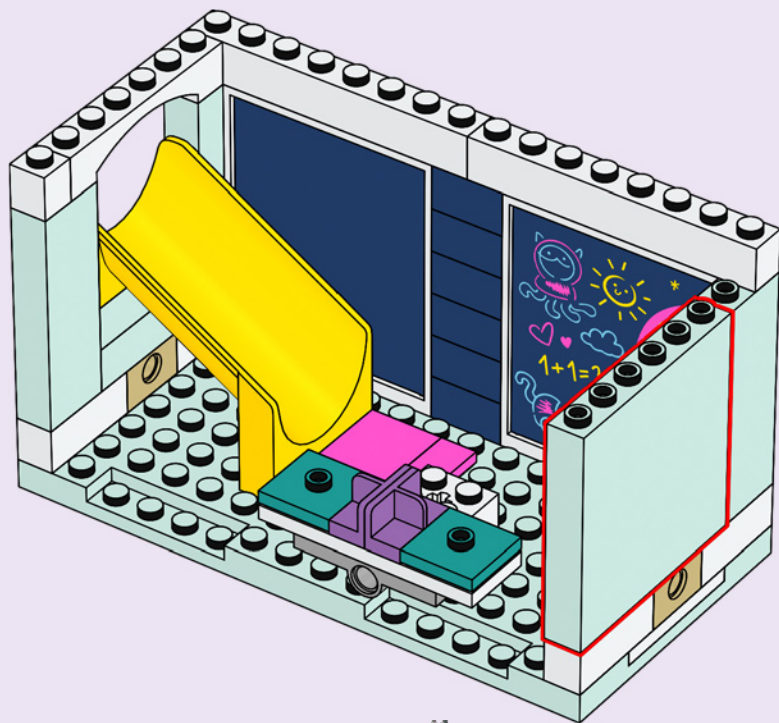

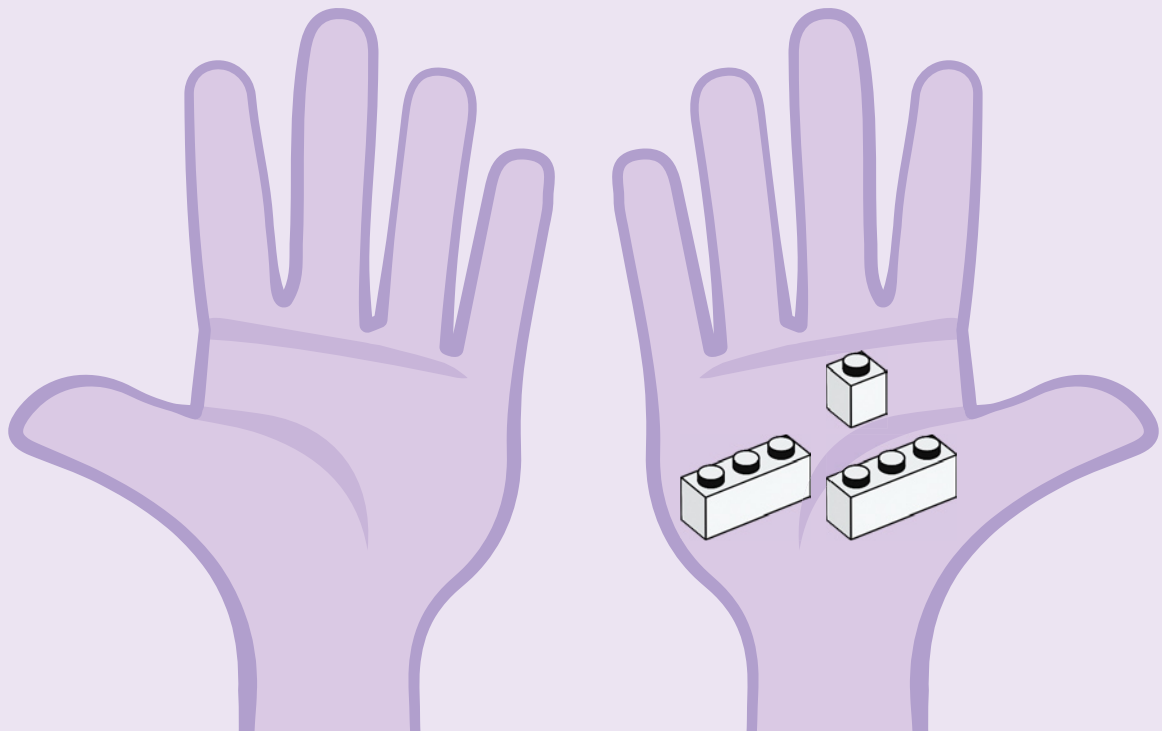



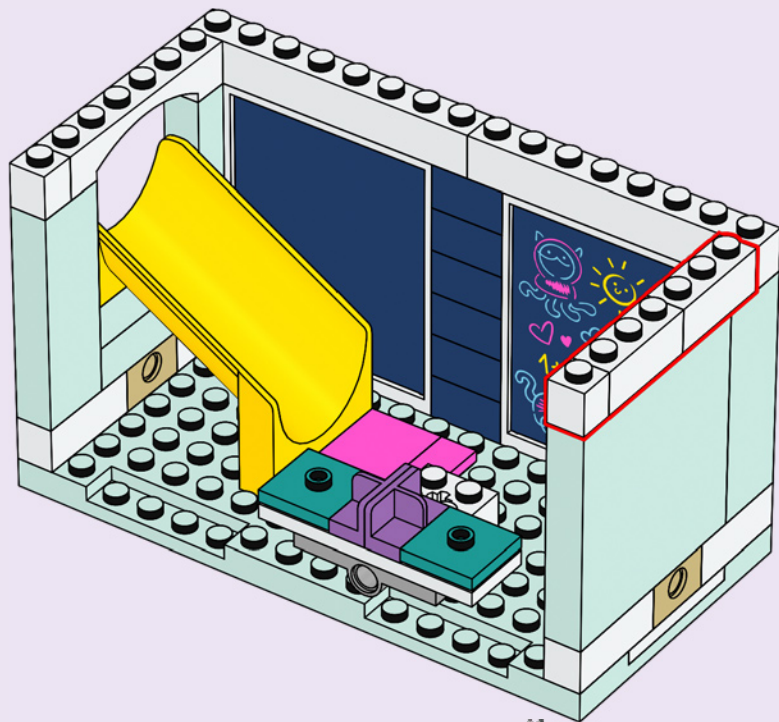

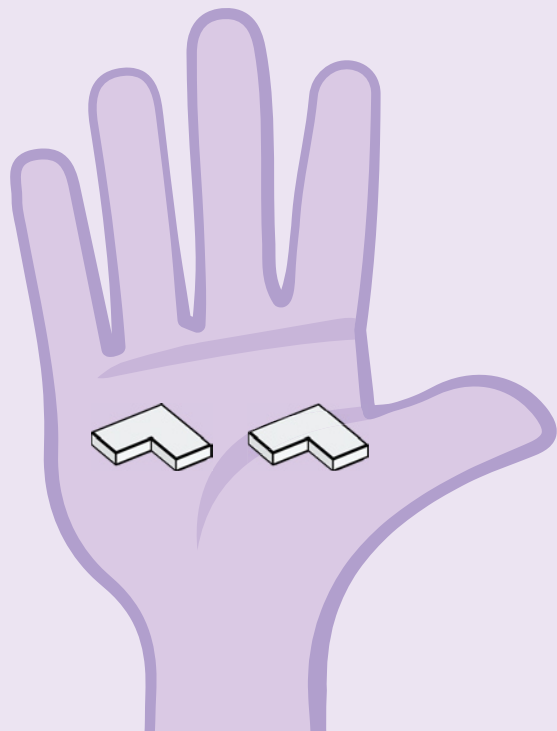
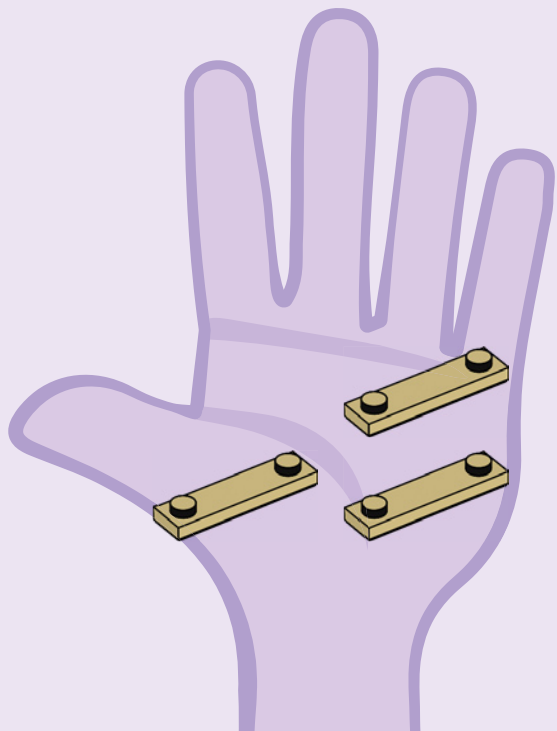

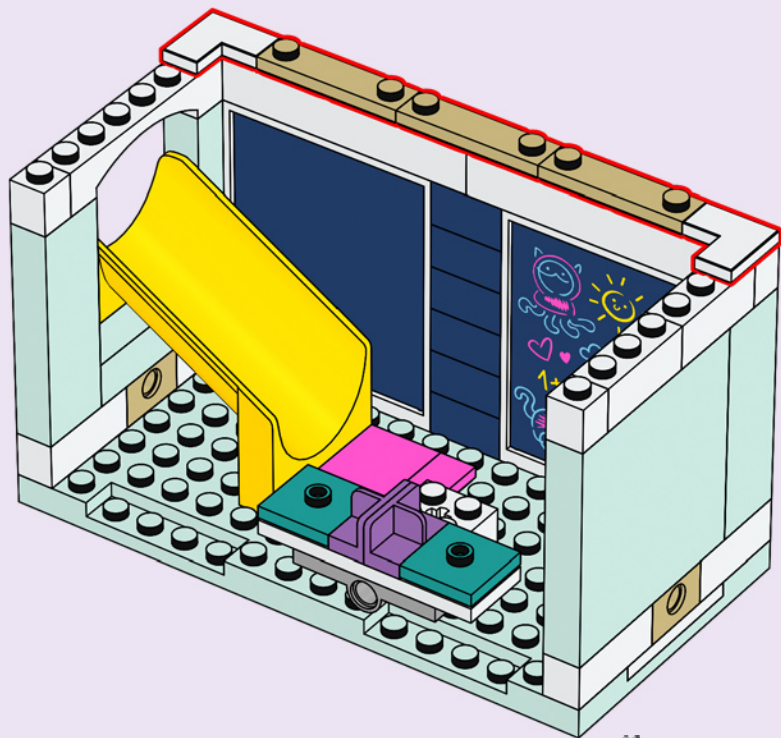

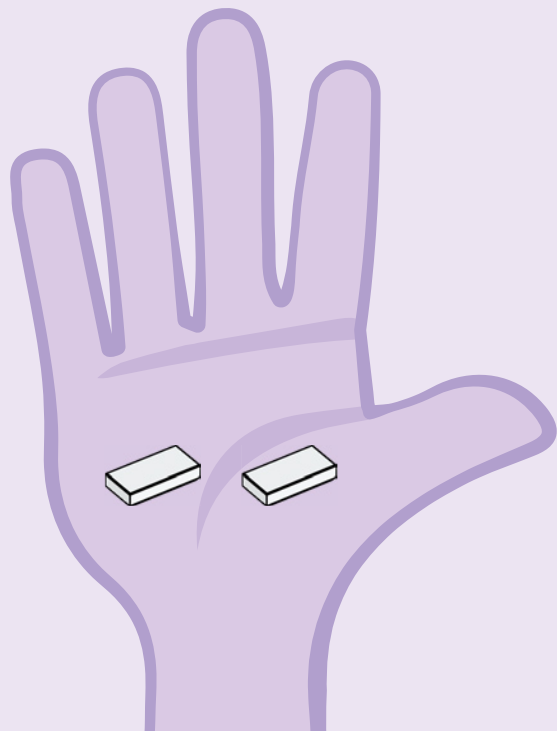
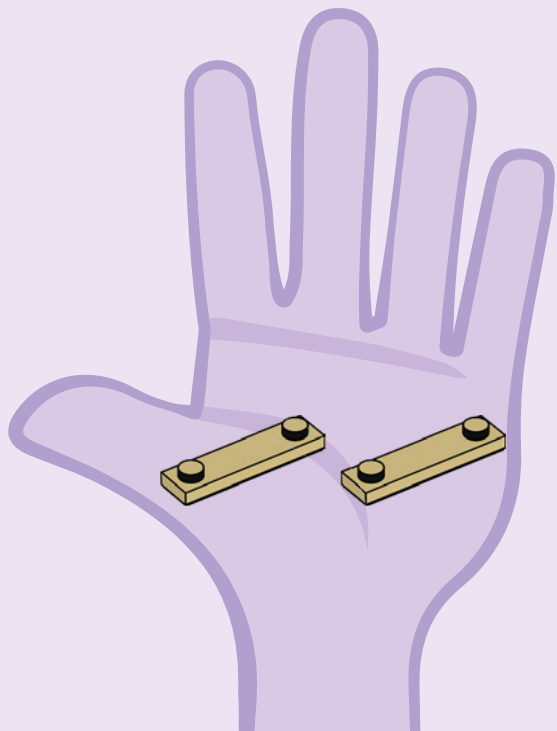

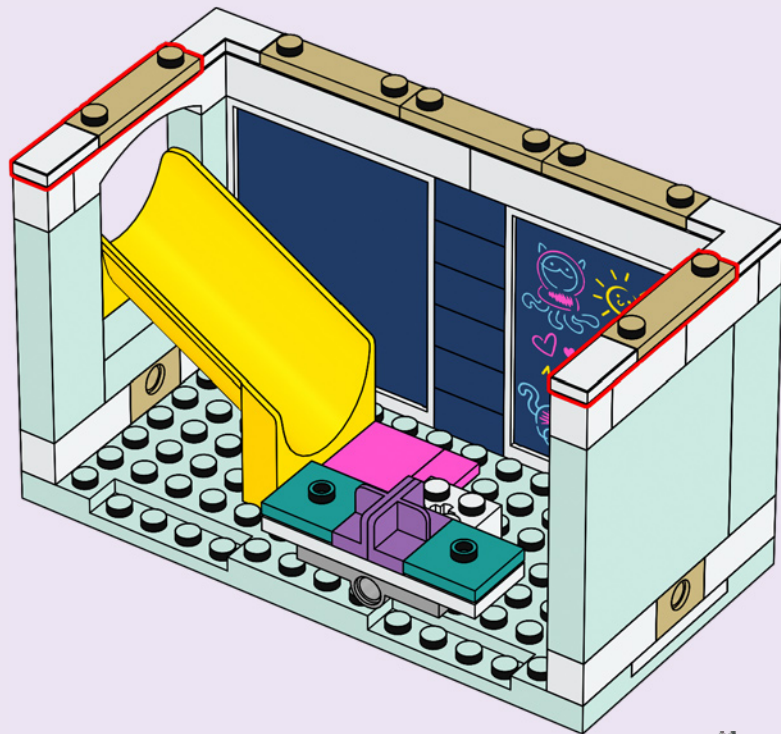

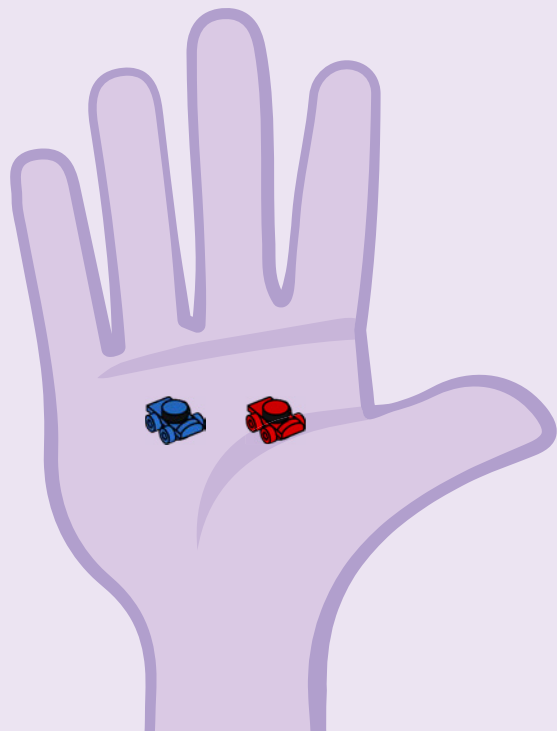
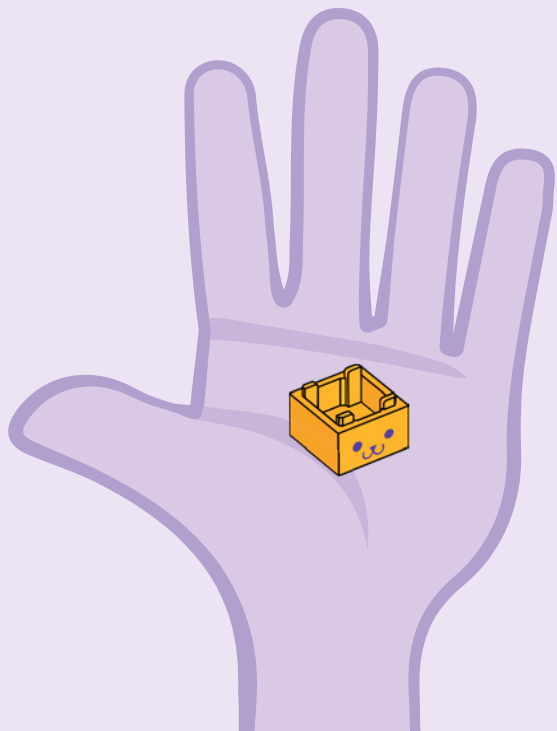

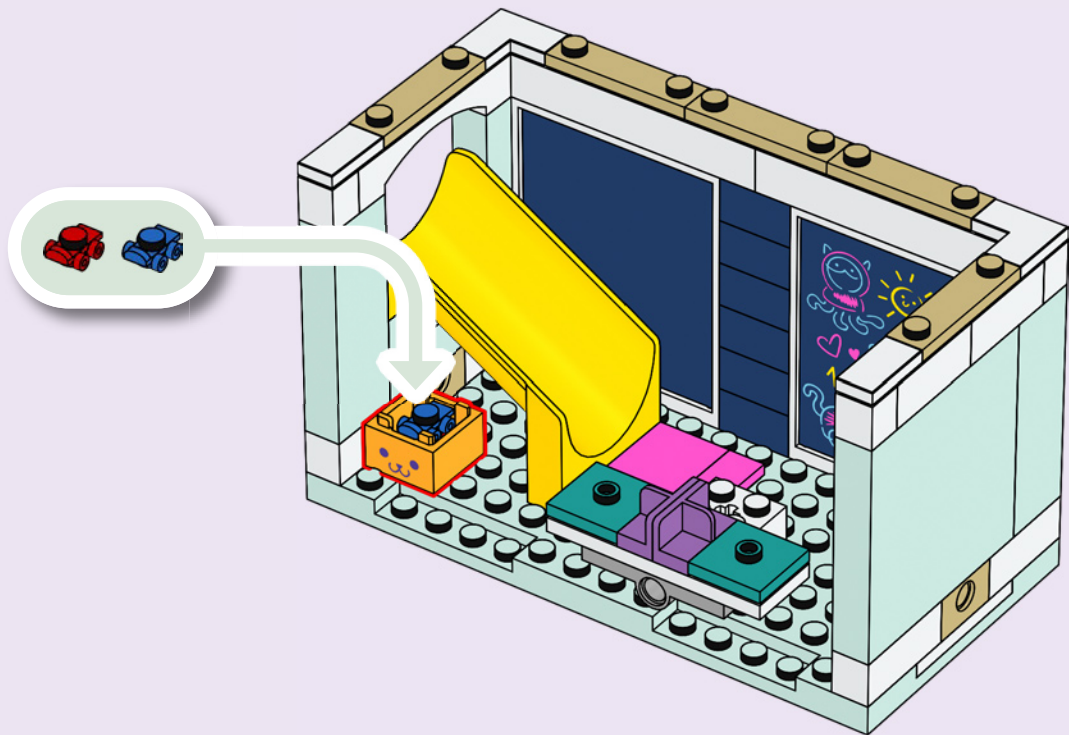

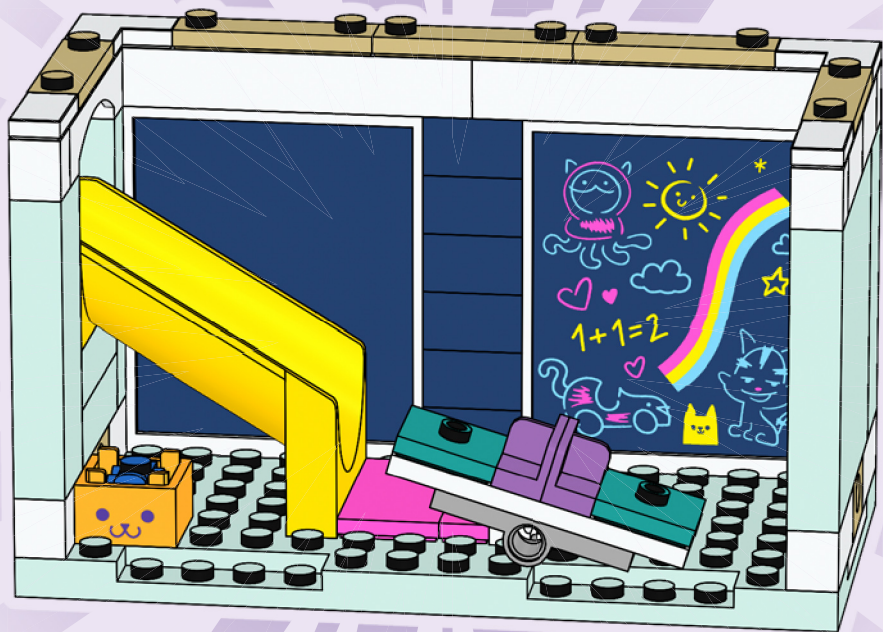



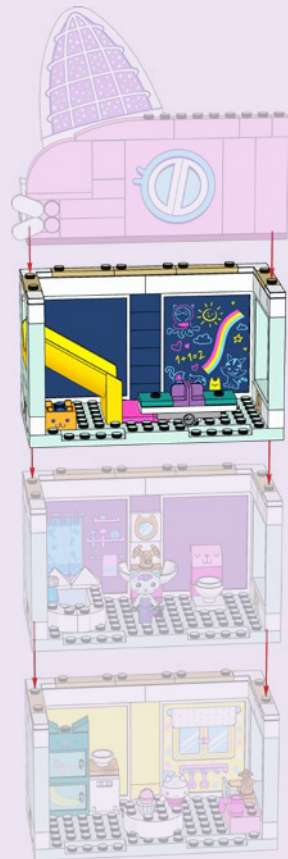

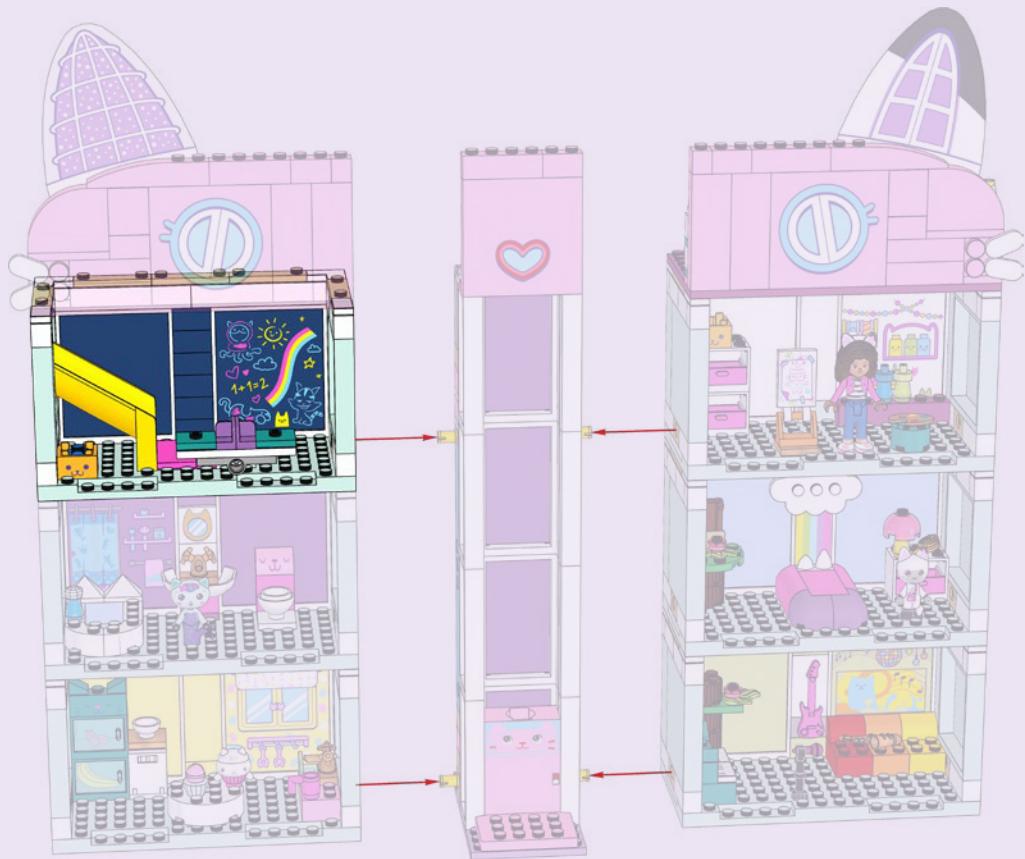



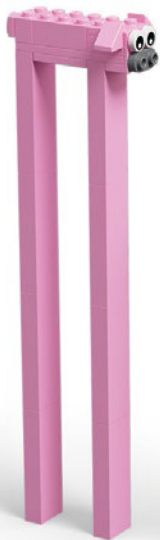

Rebuild  
the  
world™



LEGO and the LEGO logo are trademarks of the LEGO Group.  
©2023 The LEGO Group. 6473581  
DreamWorks Gabby's Dollhouse © DreamWorks Animation LLC.  
All rights reserved.