



**duplo**



**MA VILLE**

**MI CIUDAD**



**10839**  
LEGO.com/DUPL0

**LEGO** duplo



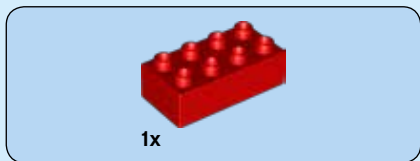

1

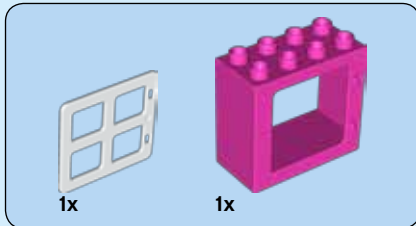
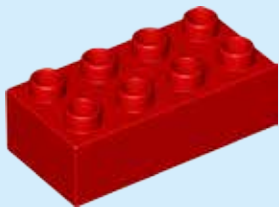

2

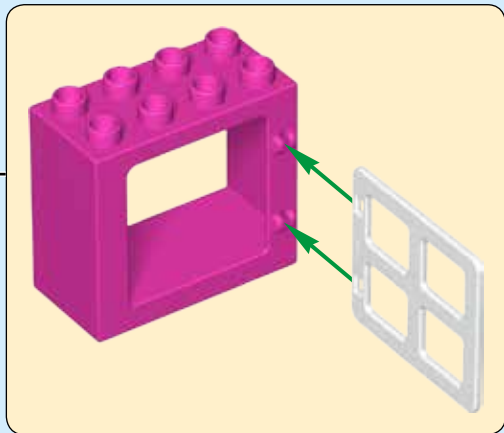

3

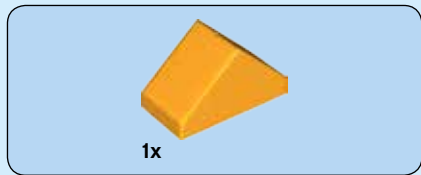

3



4

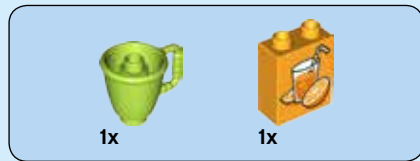

4

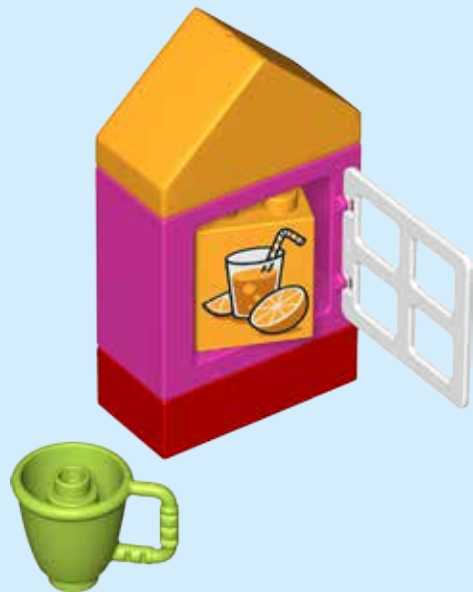

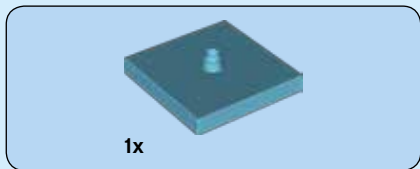

**1**

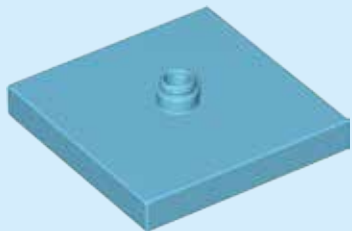

**2**

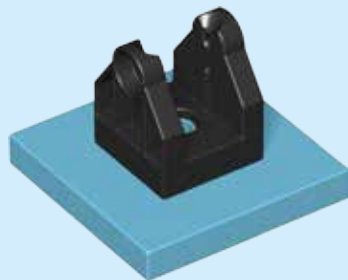



3

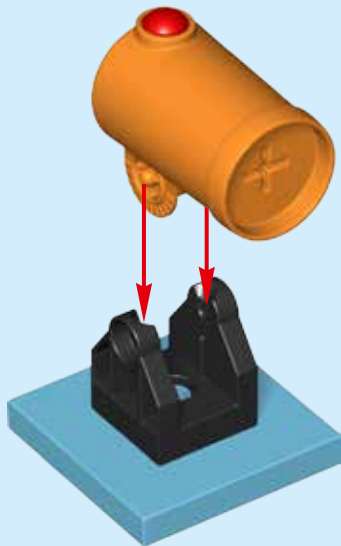

6

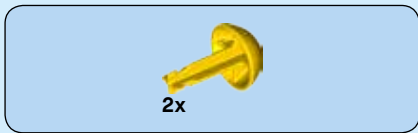

4

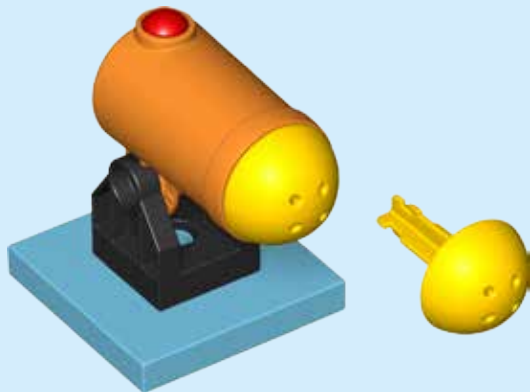

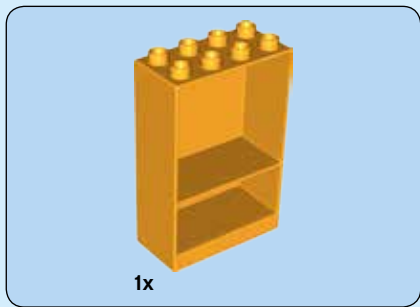

1x

1

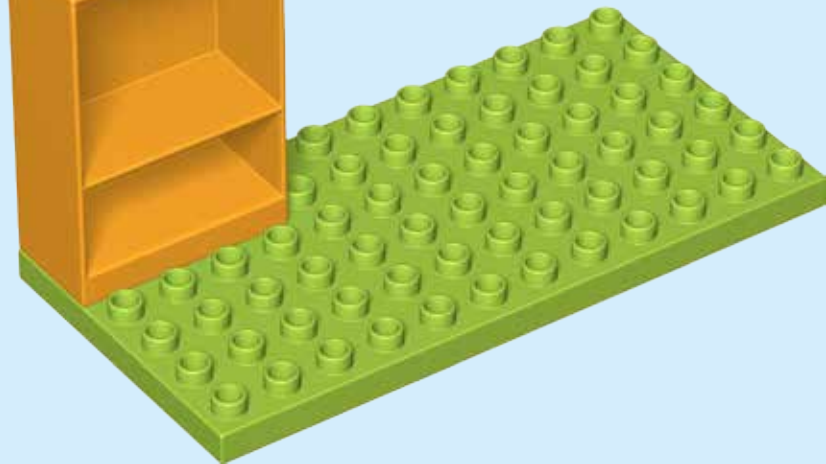

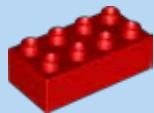

2x

2

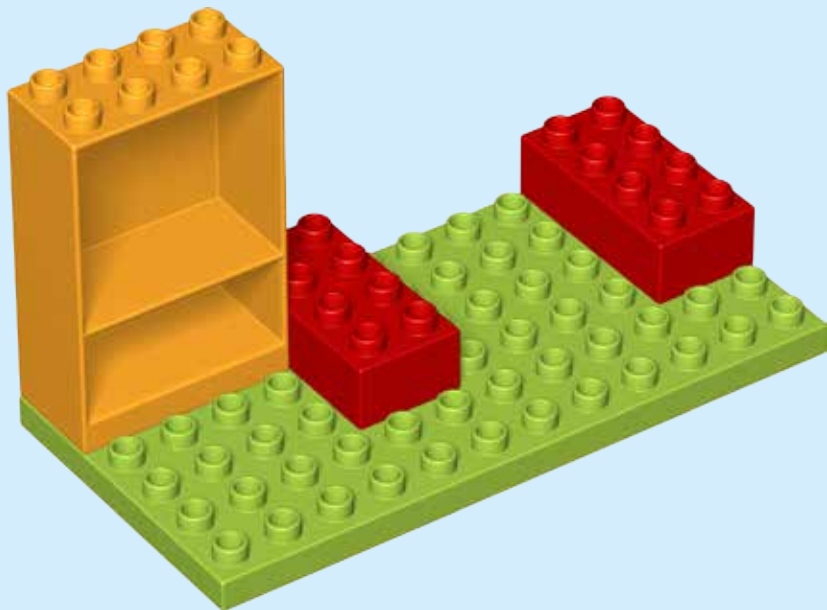

8



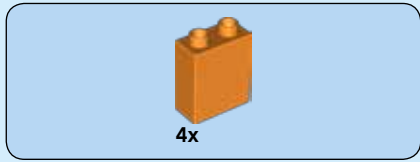

3

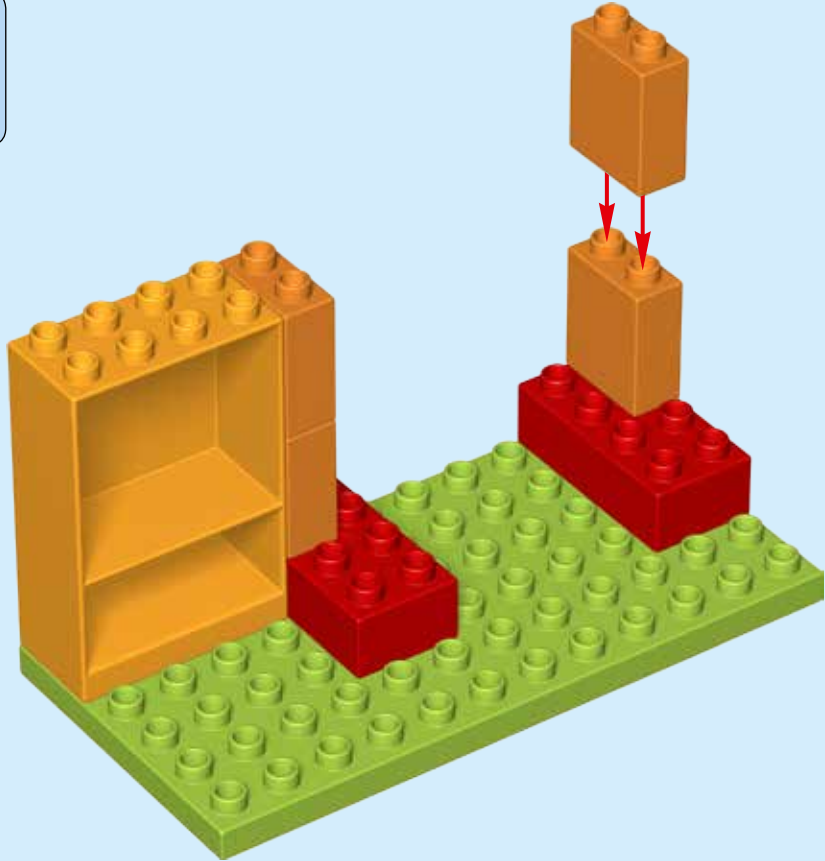

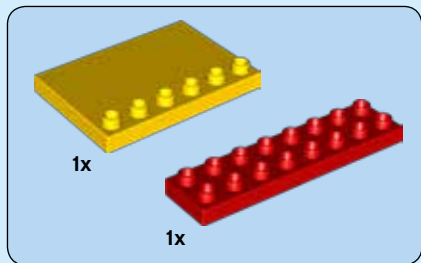

4

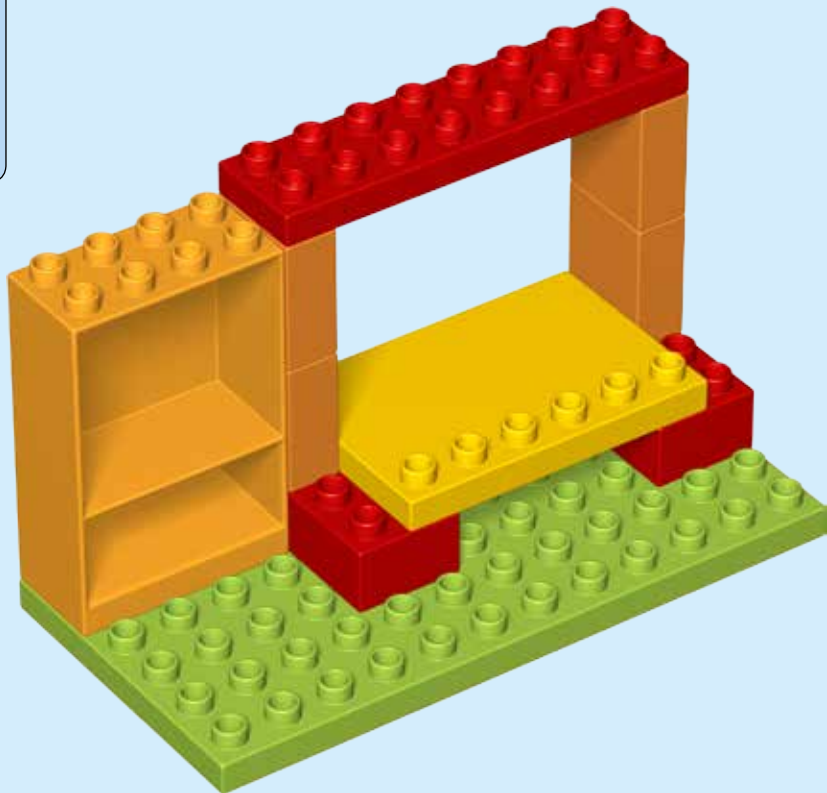

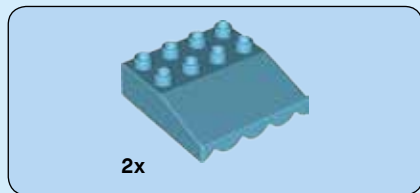

5

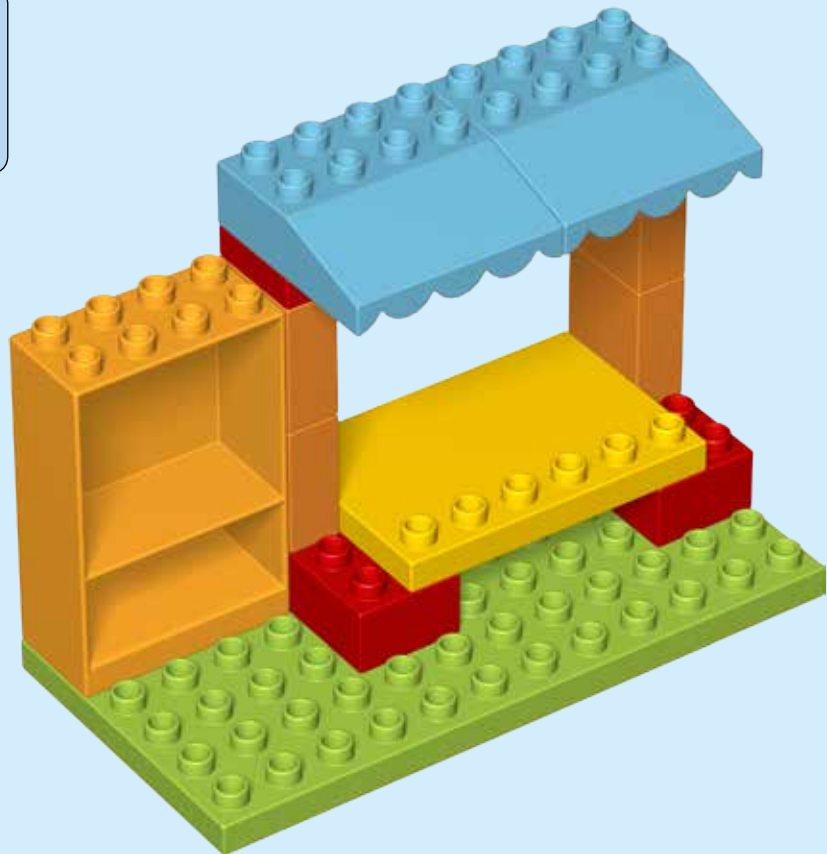

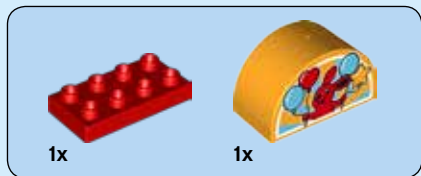

6



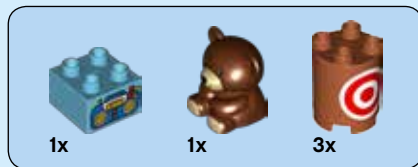

7





8



LEGO

duplo





**MY FIRST LEGO® DUPLO® SETS**  
**MES PREMIERS ENSEMBLES LEGO® DUPLO®**  
**MIS PRIMEROS SETS LEGO® DUPLO®**



10818



10845



10816



10847



**LEARN TO COUNT**

**APPRENDS A COMPTER**

**APRENDE A CONTAR**

Ages/edades  
**1½-3**



**FAVORITE CHARACTERS**  
**PERSONNAGES PRÉFÉRÉS**  
**PERSONAJES FAVORITOS**

Ages/edades  
**2-5**



10856



10857



10846

© Disney/Pixar. rights in underlying vehicles are the property of third parties, as applicable. FIAT™, Mack™.



# MY LEGO® DUPLO® TOWN MA VILLE LEGO® DUPLO® MI CIUDAD LEGO® DUPLO®

Ages/edades  
**2-5**



**MY TOWN**

**MA VILLE**

**MI CIUDAD**



10834



10835



10525



10812



10507



**MOTOR  
SOUNDS**

**MOTEUR  
SONS**

**MOTOR  
SONIDOS**

The fun continues!  
L'amusement continue !  
¡La diversión continúa!

EASY TO BUILD

LEGO JUNIORS

FACILE À CONSTRUIRE

FÁCIL DE CONSTRUIR



LEGO duplo



1½-5

4-7

LEGO.com/juniors



INSPIRATION & ACTIVITIES  
 IDÉES ET ACTIVITÉS  
 IDEAS Y ACTIVIDADES

[pinterest.com/LEGO/LEGO-DUPLO](https://pinterest.com/LEGO/LEGO-DUPLO)



#LEGODUPLO

facebook.com/LEGODUPLO

LEGO.com/DUPLO

FREE APP  
 APPLI GRATUITE  
 APP GRATIS

The LEGO Group





Our games are available for download for both Android and iOS.

Nos jeux peuvent être téléchargés sur les appareils Android et iOS.

Nuestros juegos están disponibles para dispositivos Android e iOS.

Customer Service  
 Kundenservice  
 Service Consommateurs  
 Servicio Al Consumidor

LEGO.com/service or dial

 : 00800 5346 5555  
 : 1-800-422-5346

# win

Go to  
[www.LEGO.com/productfeedback](http://www.LEGO.com/productfeedback)  
and give us your short  
feedback about this LEGO® DUPLO®  
set for a chance to win  
a cool LEGO prize

Terms & Conditions apply



## LEGO.com/productfeedback

### GEWINNE

Erzähle uns auf  
[www.LEGO.com/productfeedback](http://www.LEGO.com/productfeedback)

etwas über die Erfahrungen, die du mit  
diesem LEGO® Set gemacht hast, und  
sichere dir die Chance auf einen coolen  
LEGO Preis!

Es gelten die Teilnahmebedingungen

### GAGNE

Rends-toi sur  
[www.LEGO.com/productfeedback](http://www.LEGO.com/productfeedback)

et donne-nous quelques commentaires sur  
ce produit LEGO® pour avoir une chance  
de gagner un prix LEGO !

Voir Conditions Générales

### GANAN

Visita  
[www.LEGO.com/productfeedback](http://www.LEGO.com/productfeedback)

y envíanos tu opinión acerca de este set  
LEGO®. ¡Participarás en el sorteo de un  
premio LEGO!

Términos y Condiciones aplicables

### 获取奖品

登录  
[www.LEGO.com/productfeedback](http://www.LEGO.com/productfeedback)

给出关于此乐高®套装的简短反馈，  
就有机会获得炫酷乐高奖品

《条款及条件》适用

LEGO, the LEGO logo, DUPLO and the DUPLO logo are trademarks of the/sont des marques de commerce du/son marcas registradas de LEGO Group. ©2017 The LEGO Group.