



Architecture

21033
Chicago
Illinois, USA



Chicago

Known as the Windy City, Chicago rises up from the shores of Lake Michigan to present the perfect image of a modern American metropolis.

As the 'Gateway to the West' and the starting point of the famous Route 66, Chicago became America's fastest growing city as the country expanded westward. It is now

the third largest city in the USA, with 77 distinct districts and a population of nearly three million people.

History and architecture have always gone hand-in-hand in Chicago. The Great Fire of 1871 forced the city to completely reinvent itself and provided the foundation for the vibrant modern skyline we see today.

["It is hopeless for the occasional visitor to try to keep up with Chicago. She outgrows his prophecies faster than he can make them."]

Mark Twain





Willis Tower™

Located in the heart of the city, the 110-story Willis Tower was completed in 1974 at a cost of \$175 million. The tower was the first to use the “bundled-tubular” construction principle, where nine independent sections were joined together to provide extra stability against Chicago’s high winds. The Willis Tower has more than 16,000 bronze-tinted windows and 28 acres (11.3 ha) of black aluminum cladding or “skin”. The Ledge, the famous glass balcony that extends from the tower’s observation deck, leaves visitors standing 1,353 ft. (412 m) in the air.



Cloud Gate

Designed by British artist Anish Kapoor, the 110-ton (99,790.3 kg) elliptical sculpture is forged from a seamless series of highly polished stainless steel plates, which reflect Chicago's famous skyline and the clouds above. Inspired by liquid mercury, the sculpture is among the largest of its kind in the world, measuring 66 ft. (20 m) long by 33 ft. (10 m) high.



© Patrick Pyszka



DuSable Bridge

The DuSable Bridge is where the famous Michigan Avenue crosses the Chicago River and is both a beautiful work of art and a great civil engineering feat. Completed in 1920, the Beaux Arts style bridge was designed to resemble the

Alexander III Bridge over the Seine in Paris. The double-deck bridge with highways on both levels opens up to allow boats to pass underneath.



The Wrigley Building™

Standing on a triangular piece of land at the northwest corner of Michigan Avenue and the Chicago River, The Wrigley Building has been an iconic part of the city's skyline for over 95 years. The Wrigley Building consists of two towers, completed in 1921 and 1924, connected by walkways at the 3rd and 14th floors. The Wrigley Building's architecture combines French Renaissance and Spanish Revival styles, but adds a unique American twist.

The Wrigley Building is clad in more than 250,000 terra cotta tiles of more than 500 unique designs. The tiles are six different colors, ranging from blue-white at the bottom to creamy white at the top, to enhance a sunlit appearance.





Big Red



This simple, rectangular International Style structure was completed in 1973 and is famous for its eye-catching red color. The 600 ft. (183 m) tall building is also renowned for using its lights and windows to display messages during festive and sporting events. A computer program is used to calculate which windows need to be activated to create the proper message.

John Hancock Center



Completed in 1970, the distinctive 100-story John Hancock Center reaches 1,127 ft. (343.5 m) into the city skyline. Named after an insurance company and original tenant, the tower is known locally in Chicago as “Big John”. A band of white lights adorn the top of the building and are visible throughout Chicago at night. The color of these lights changes to mark different holidays such as Christmas (red & green), Valentine’s Day (red & white) and St Patrick’s Day (green).



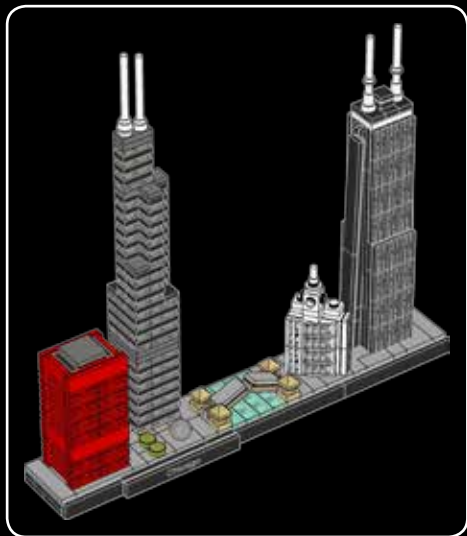

1

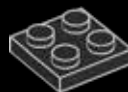



2

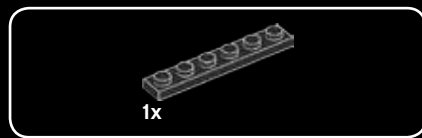
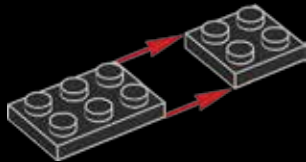

3

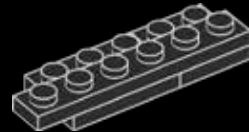



1x

4

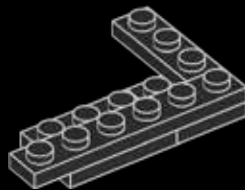



5

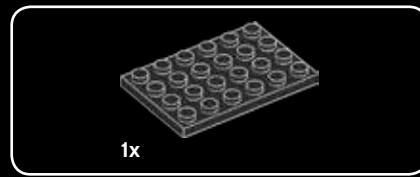
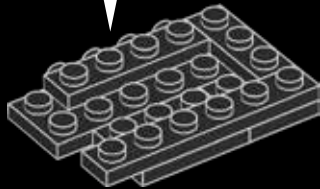
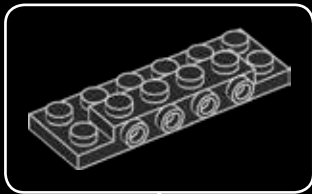

6

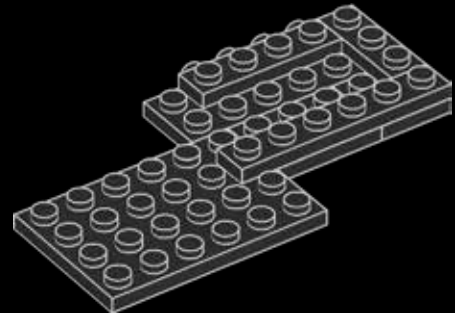



1x

7

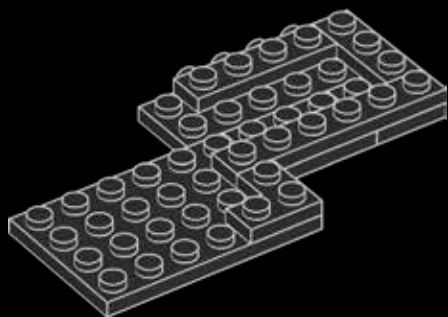

1x

8

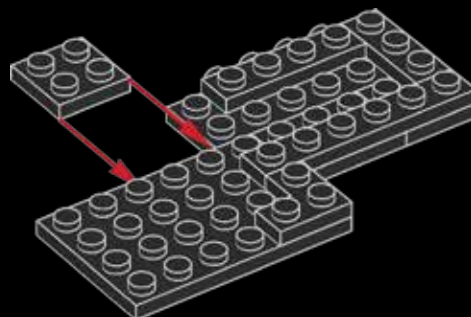

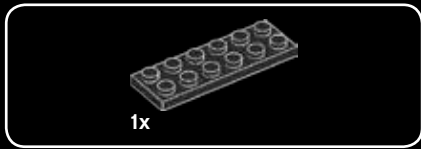

9

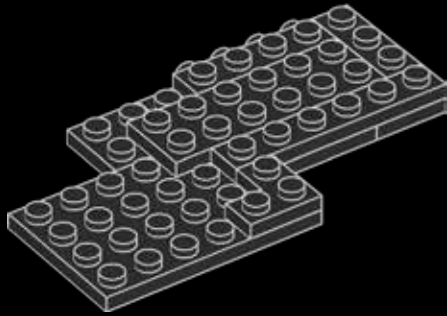

10

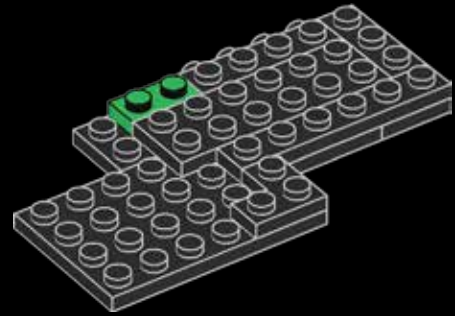



1x

11

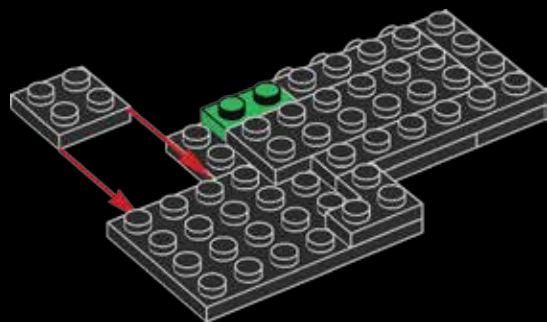

1x

12

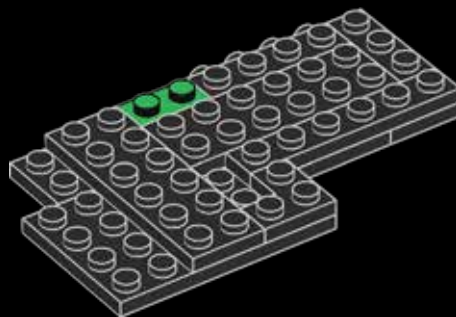



13

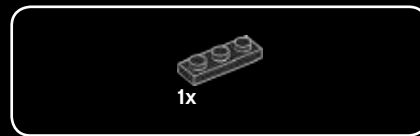
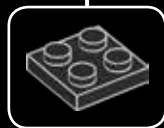
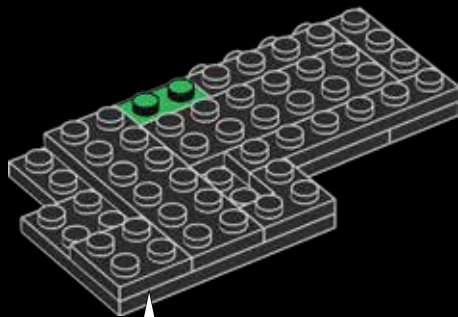

14

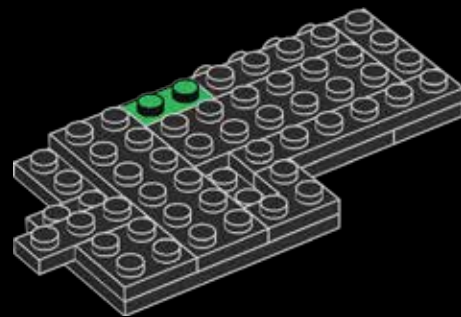

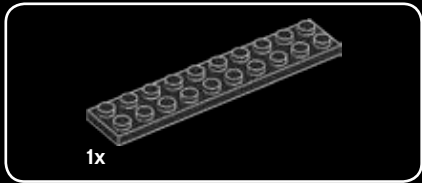

15

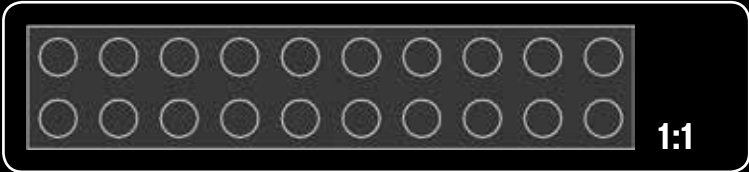
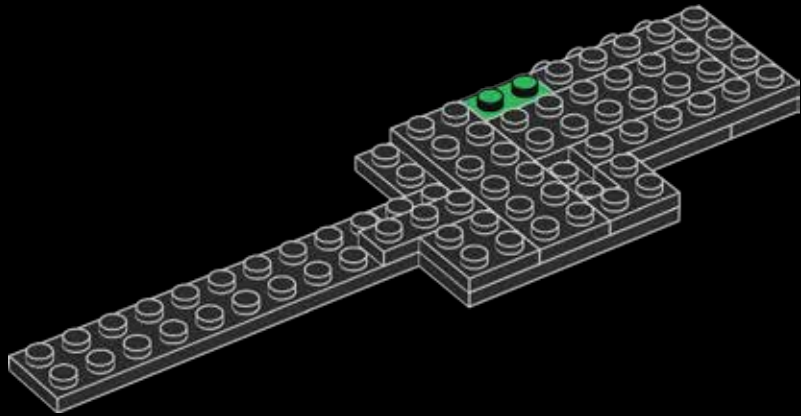

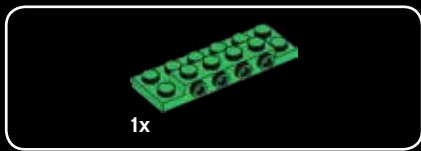

16

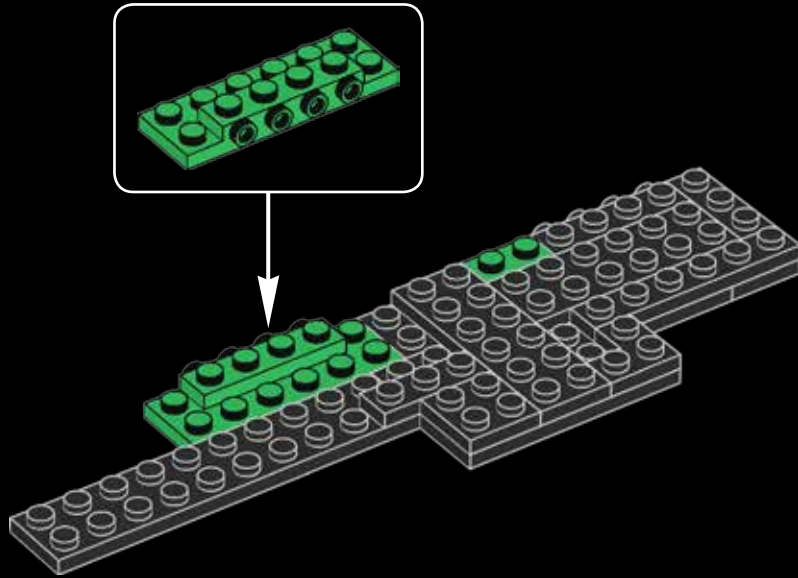

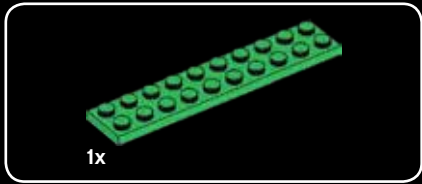

17

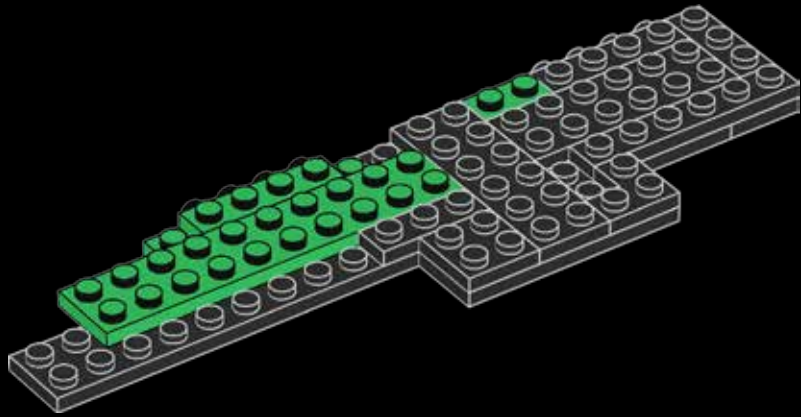



18

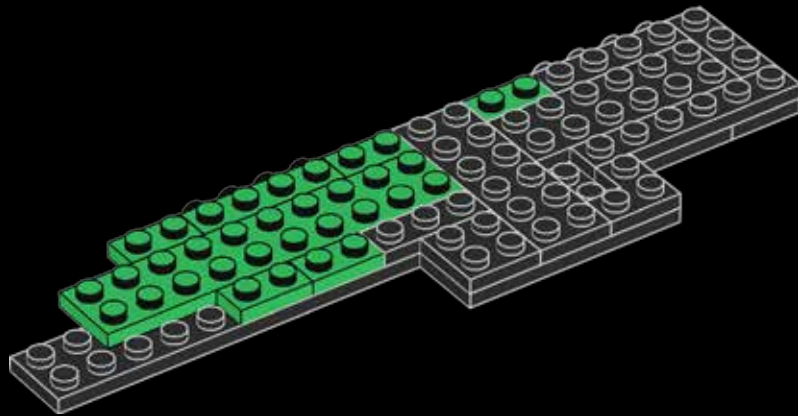



1x

19

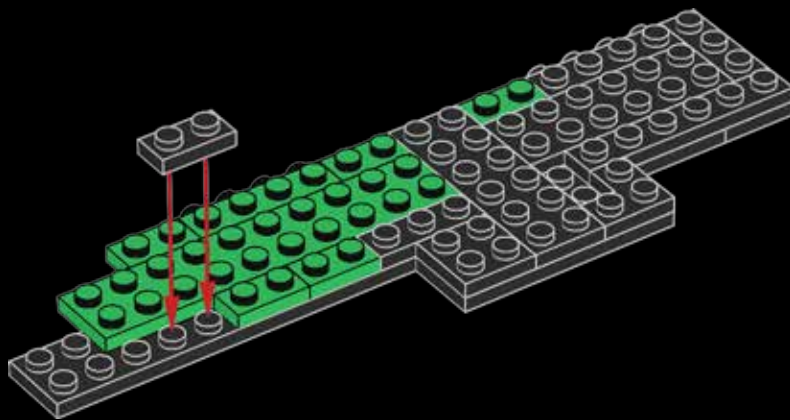

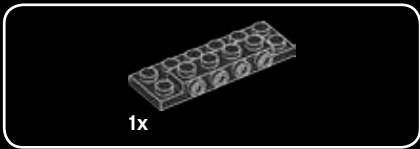

20

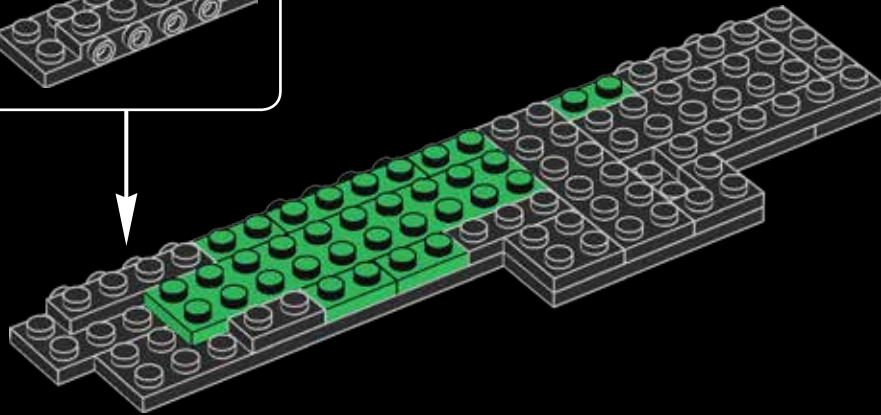
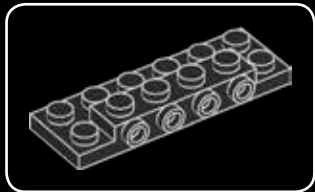



1x

21

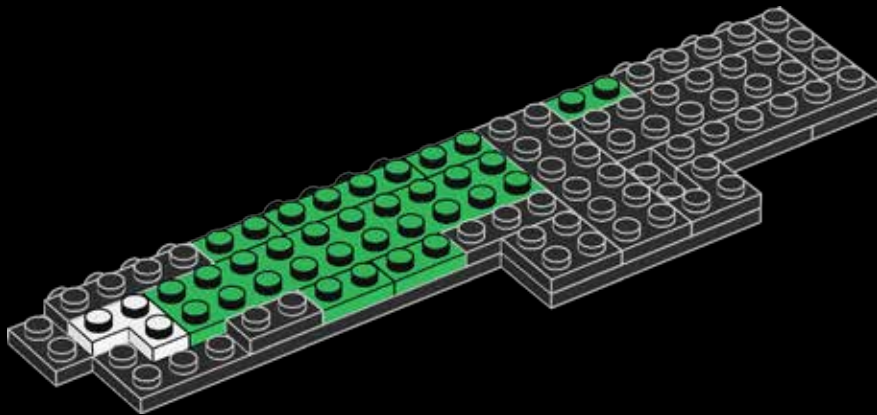



22

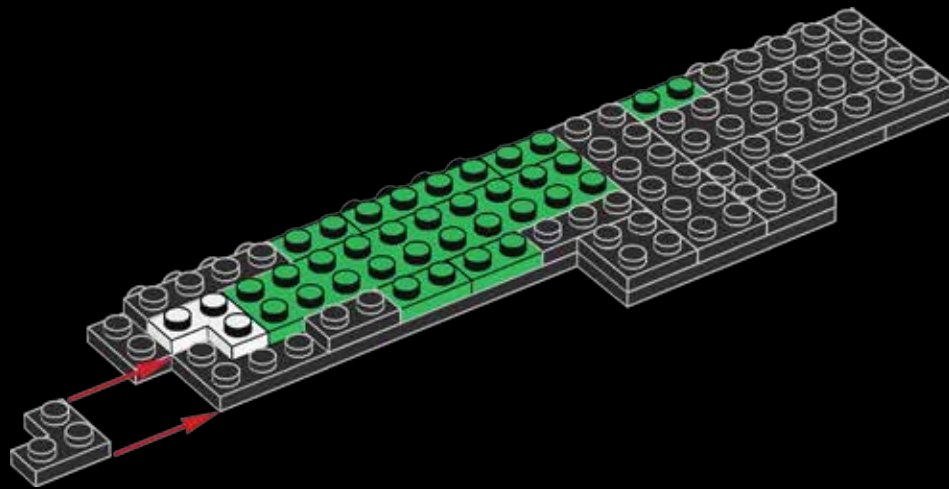

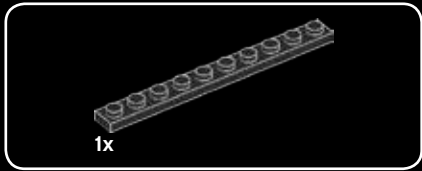

23

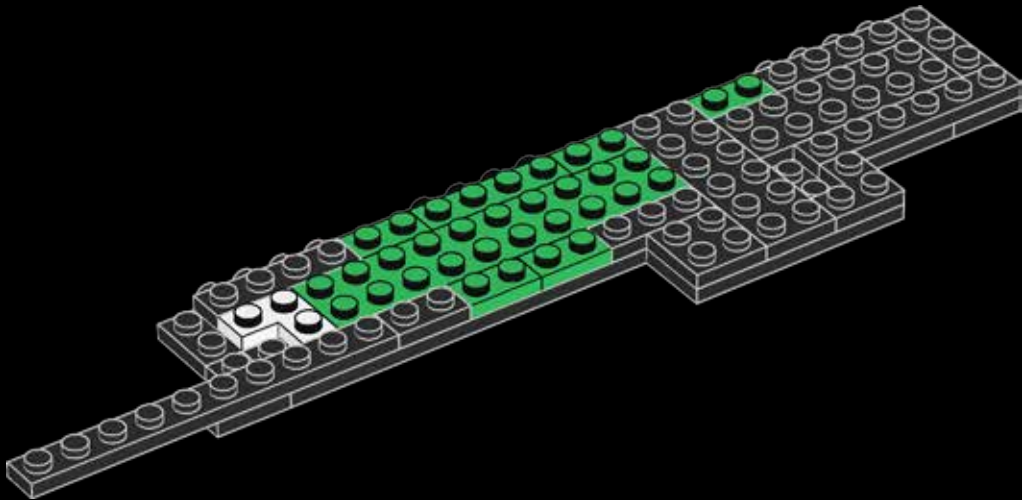



24

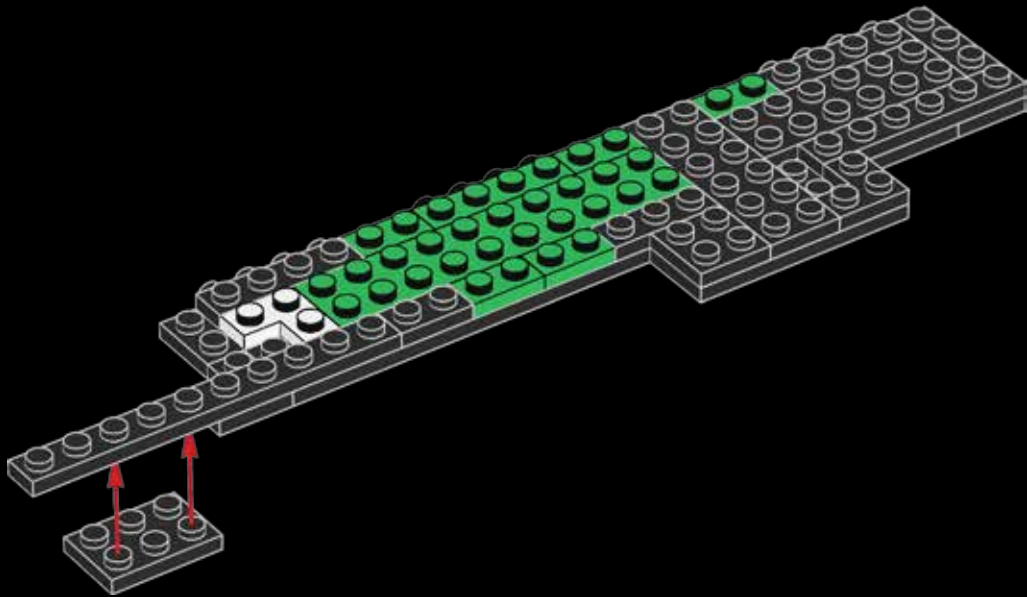



1x

25

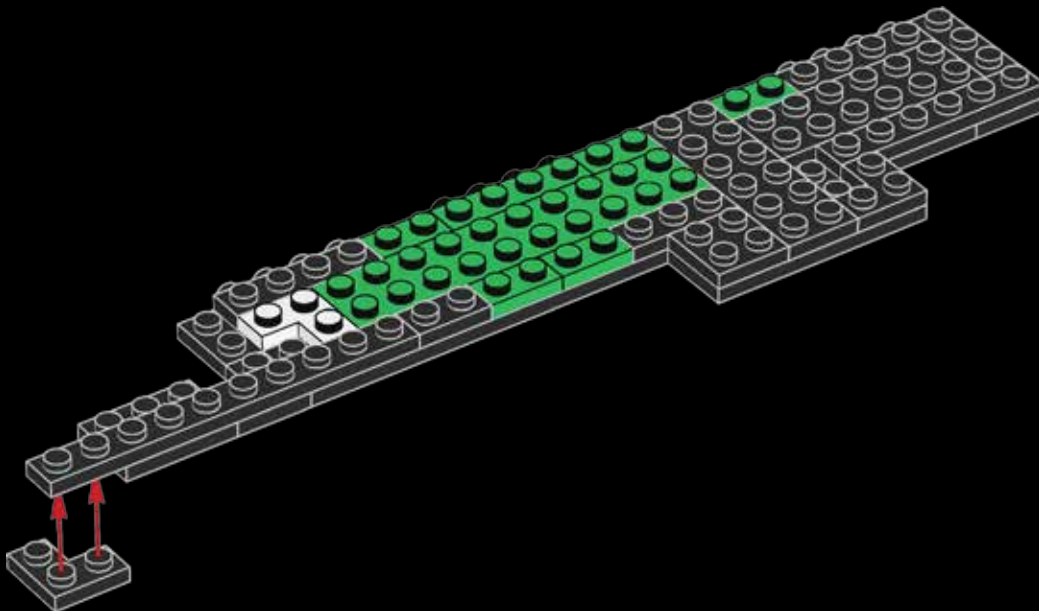



26

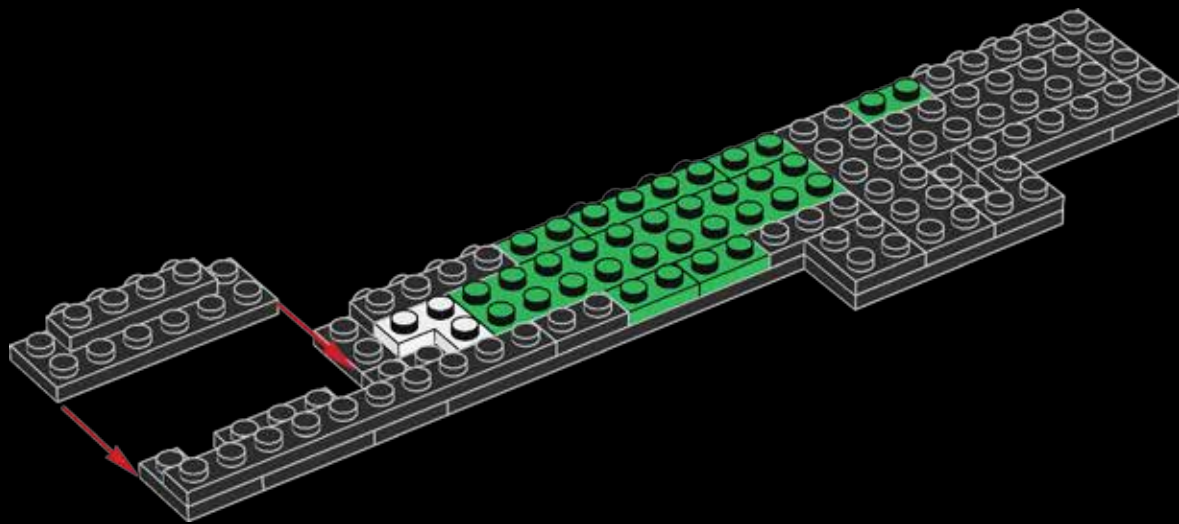



1x

27

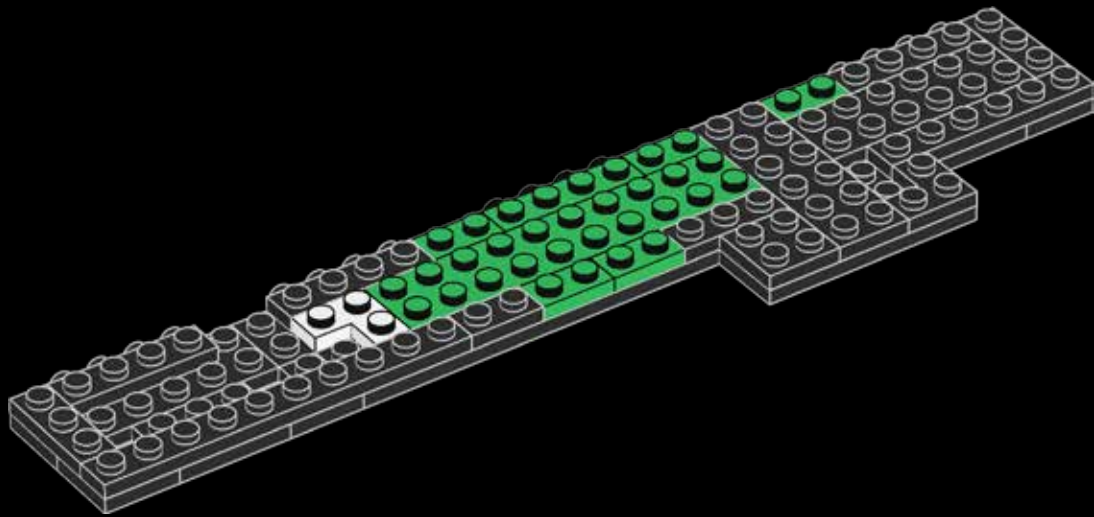



28

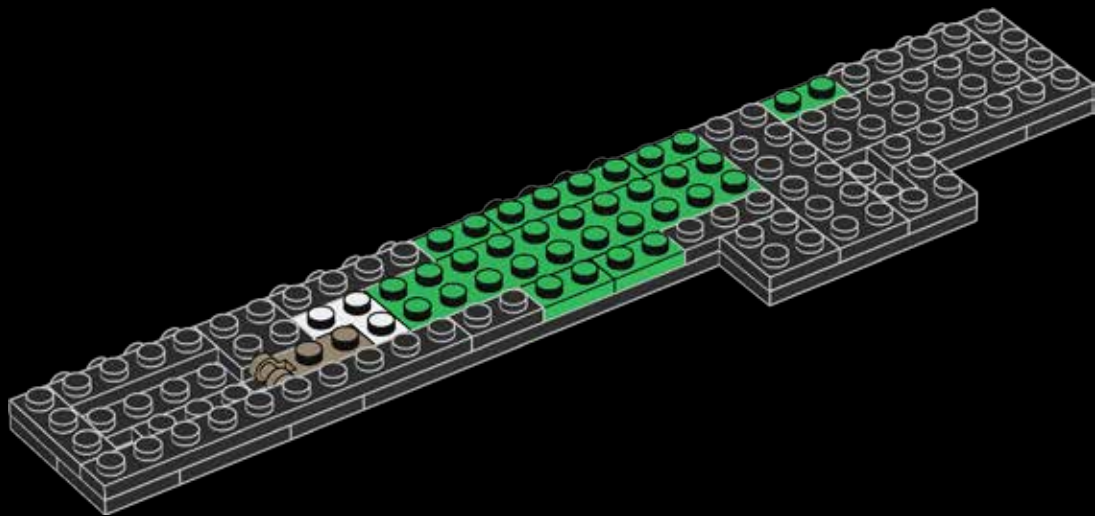



29

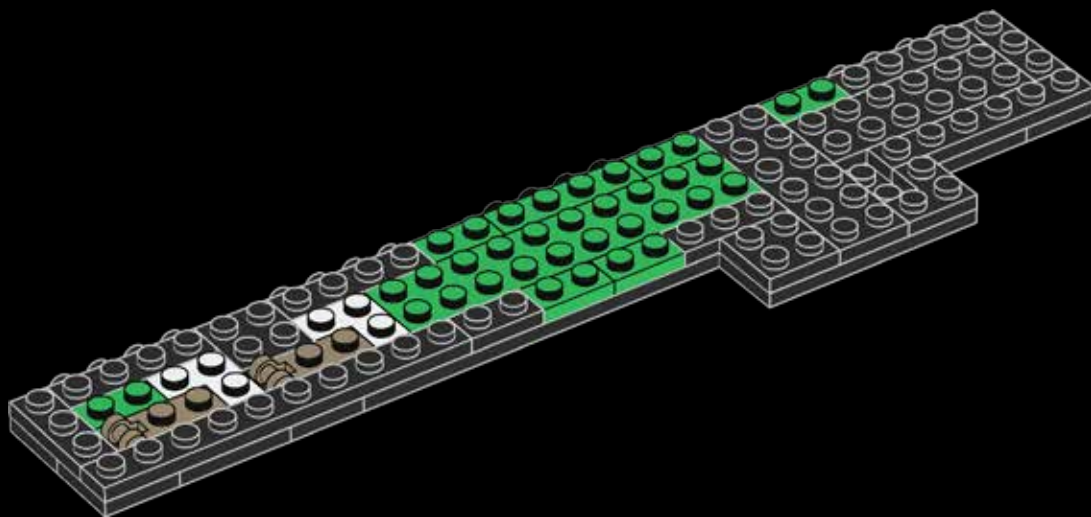

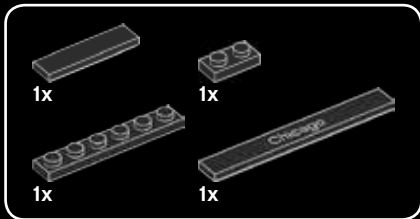

30

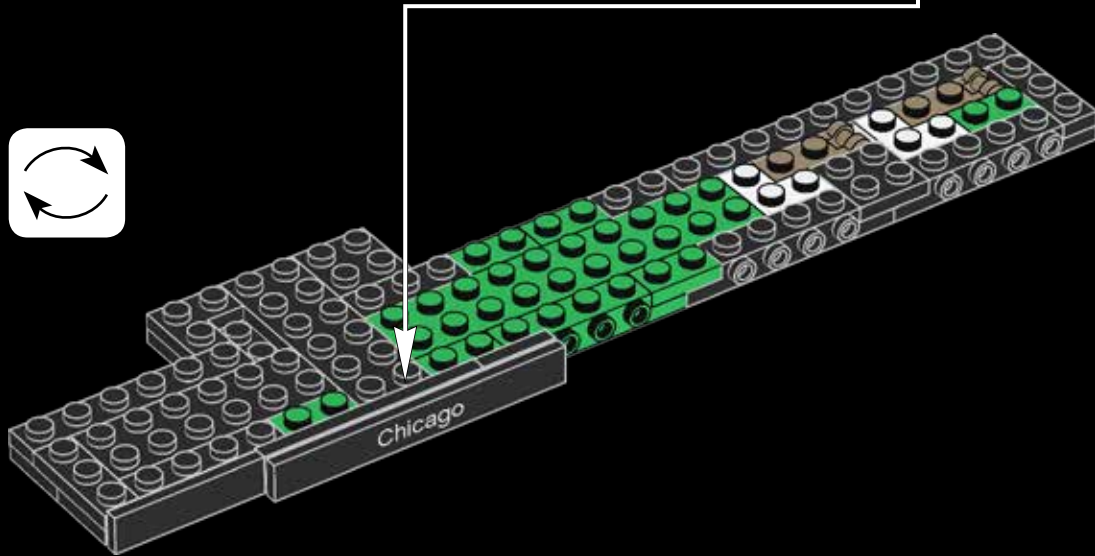
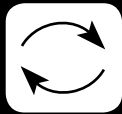
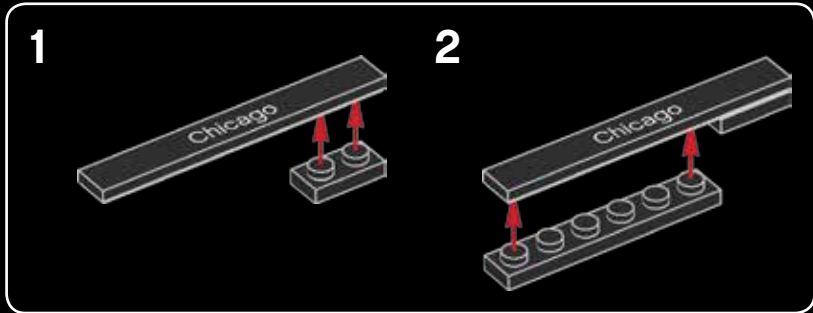

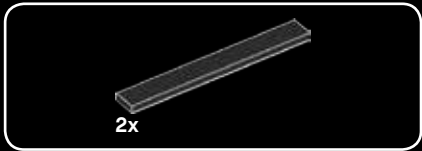

31

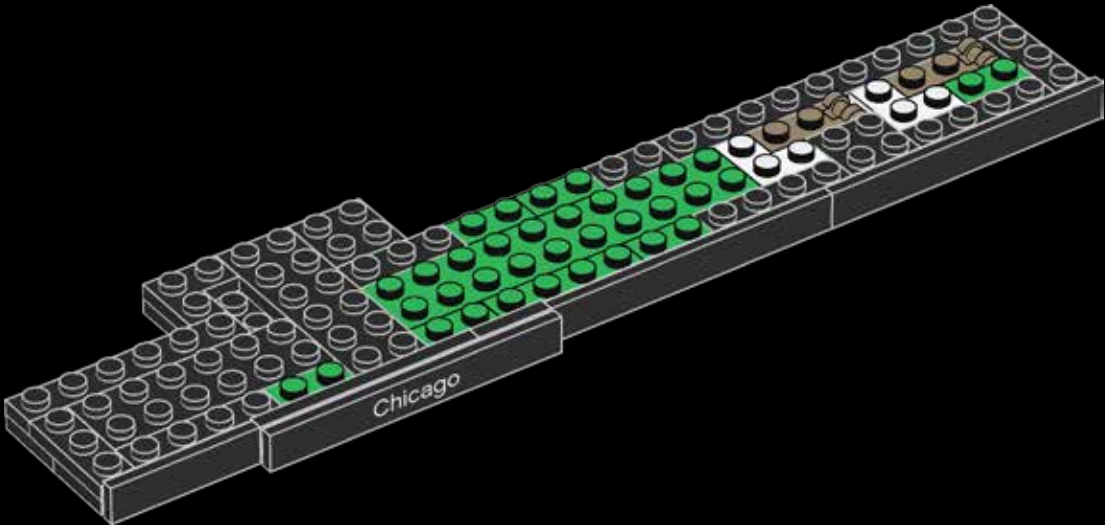

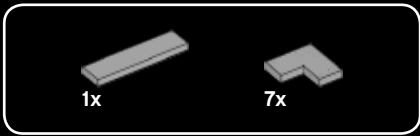

32

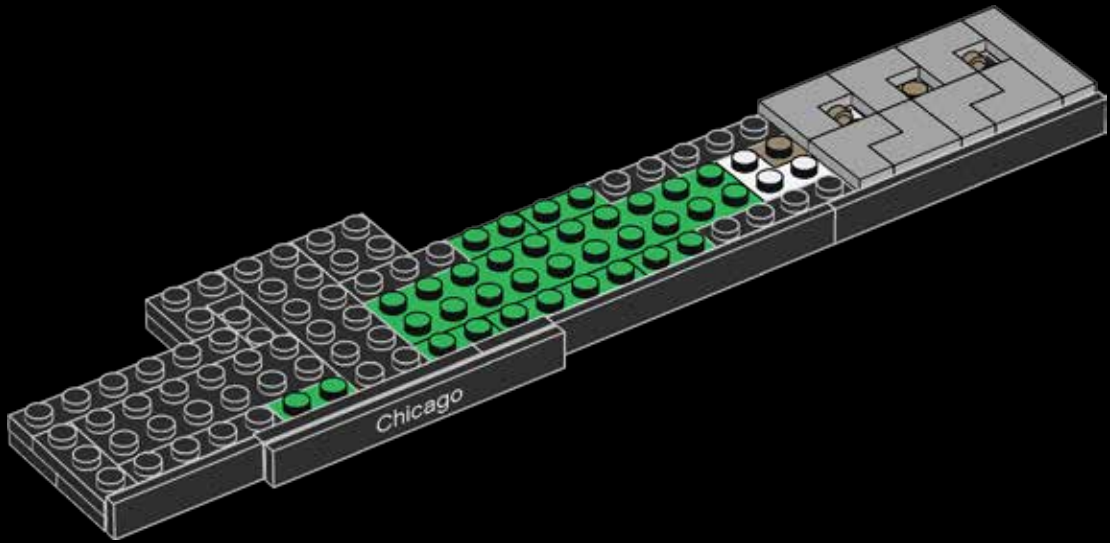

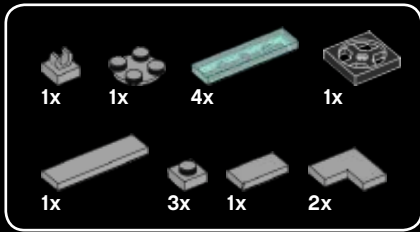

33

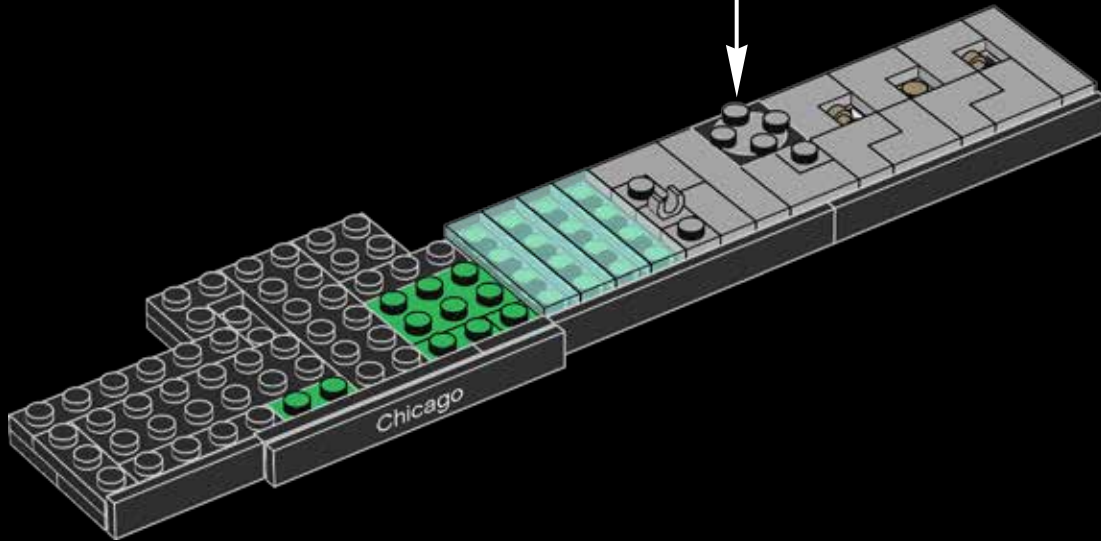
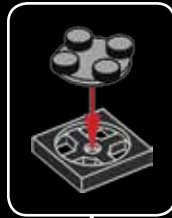

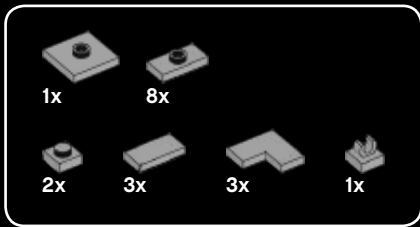

34

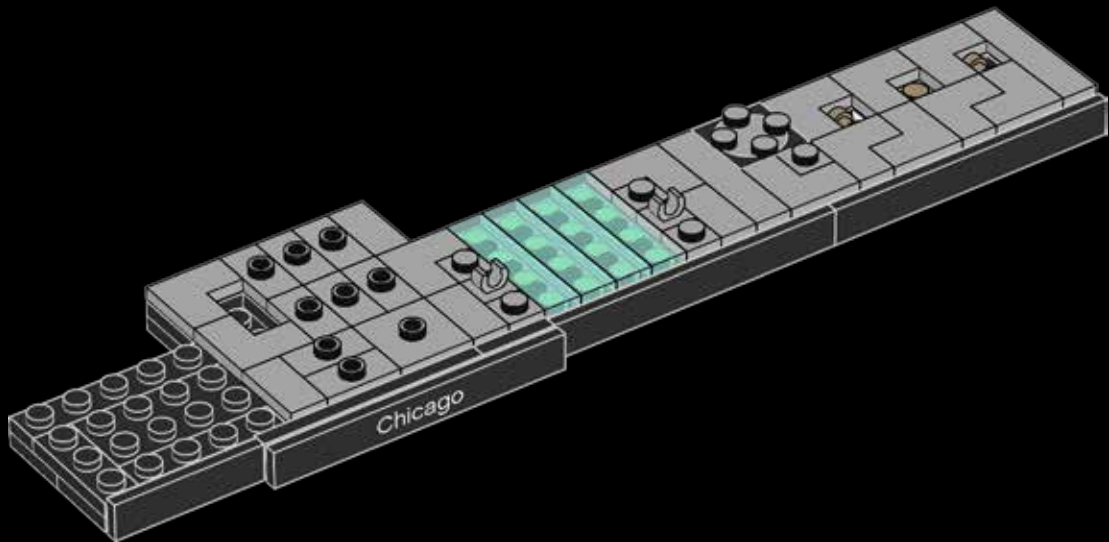

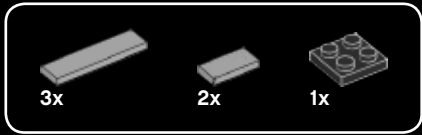

35

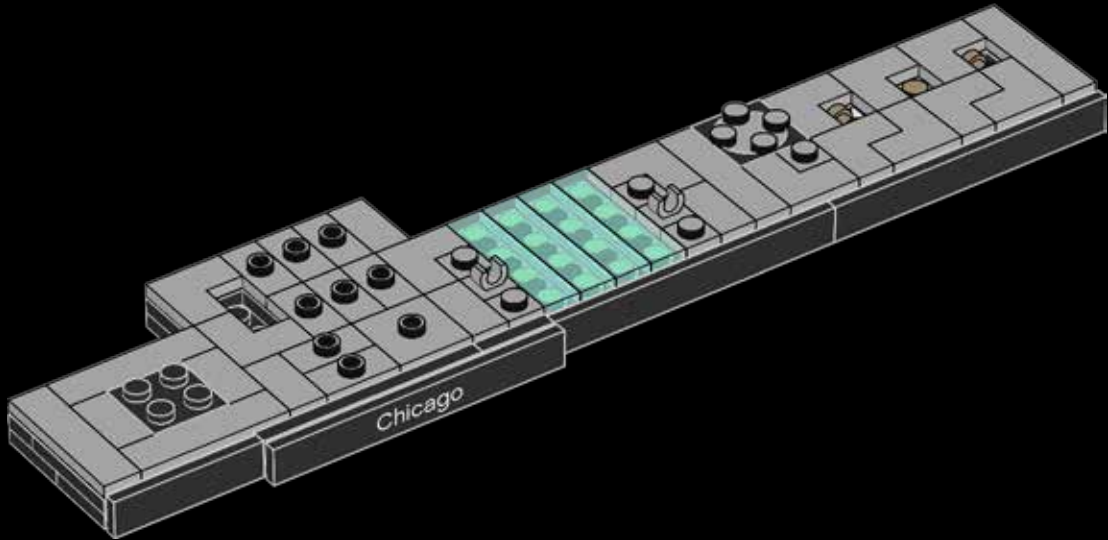

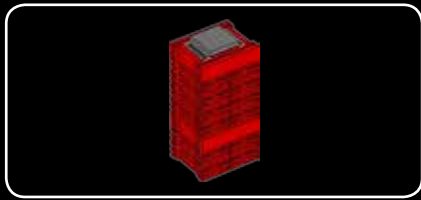

1x

36



2x

37

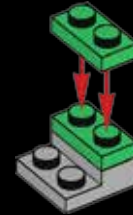

1x

38



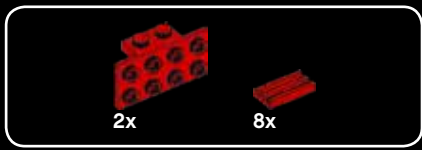

39

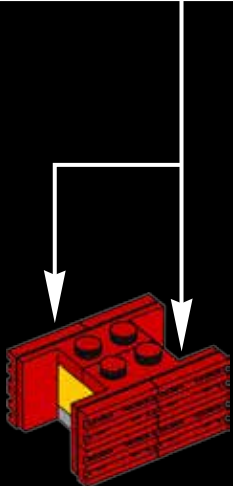
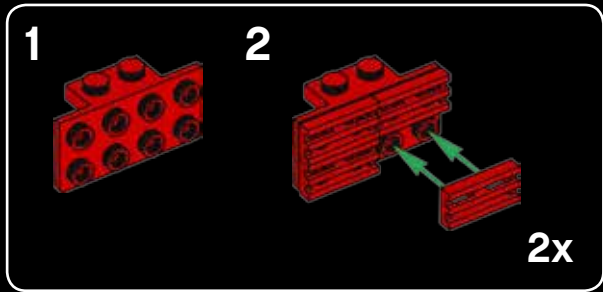

40

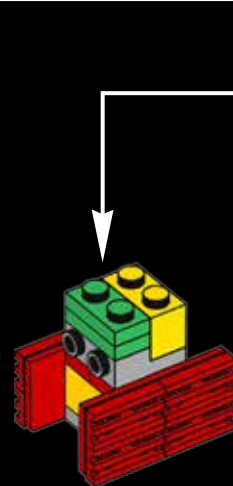
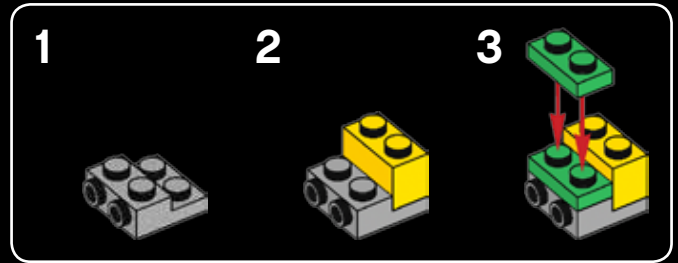

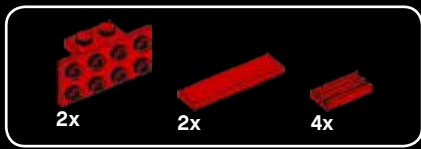

41

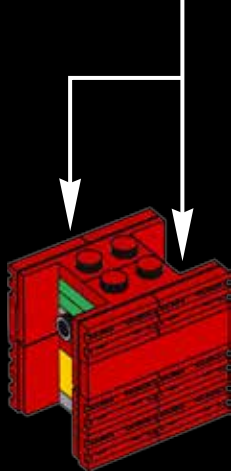
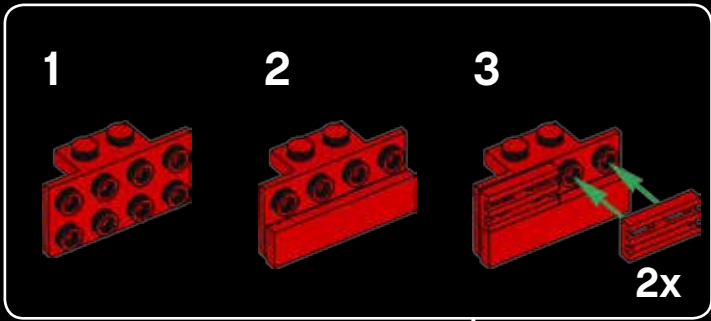

42

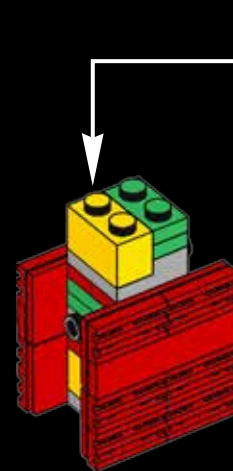
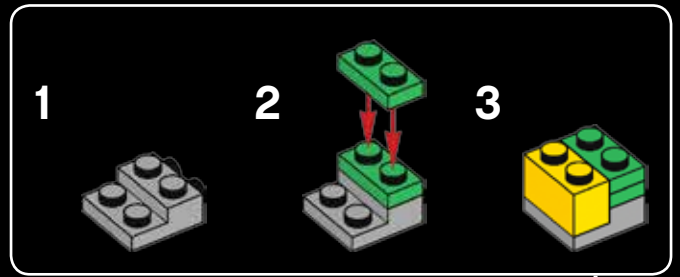

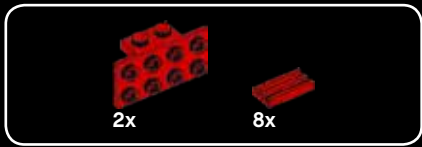

43

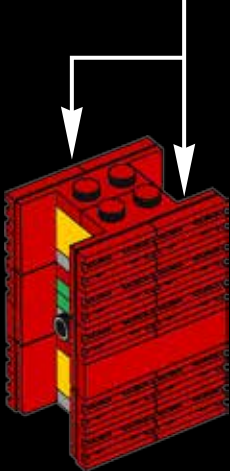
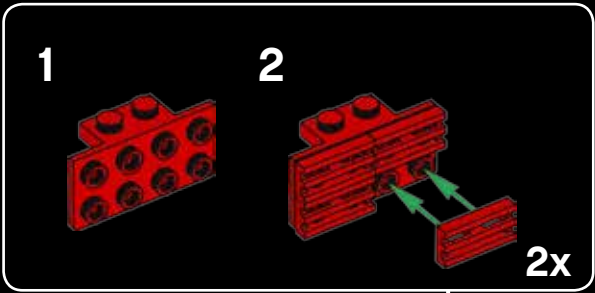

44

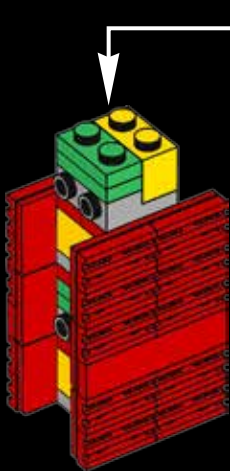
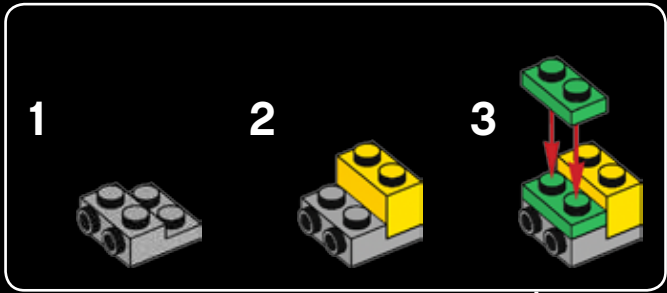

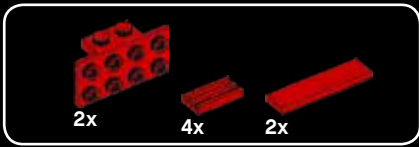

With only 44 stories, Big Red is not a massive structure by Chicago standards.



45

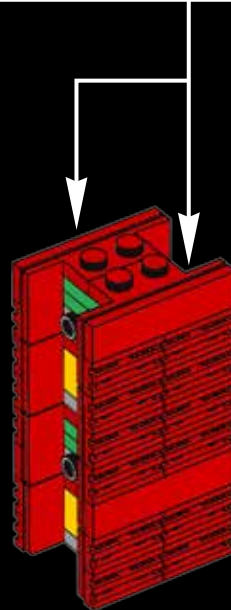
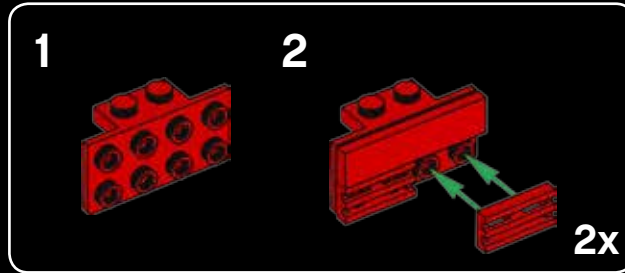

The total floor area of the building is
1,299,990 sq. ft. (120,773 m²)

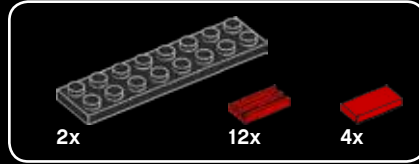

46

1

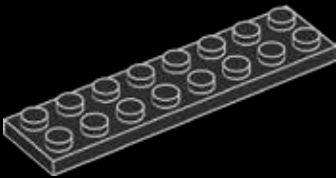

2

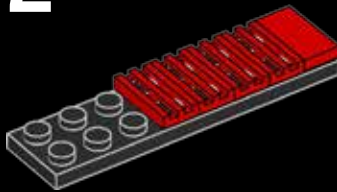

3



2x

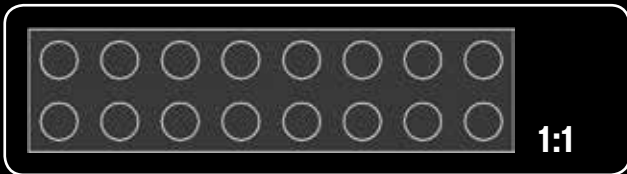



47

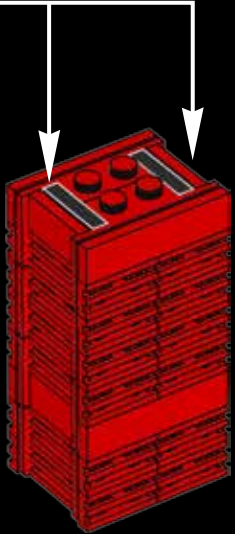

48



The sculpture was assembled in California and sailed through the Panama Canal and St Lawrence Seaway to Chicago.



© Patrick Pyska

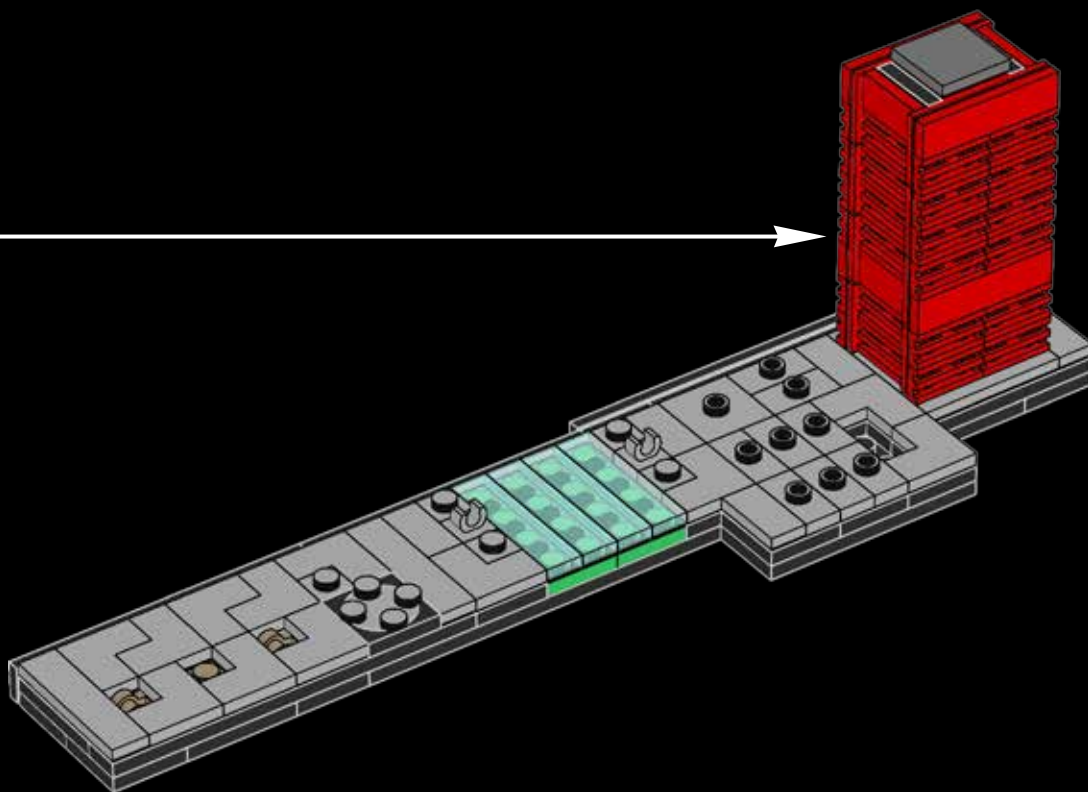



49

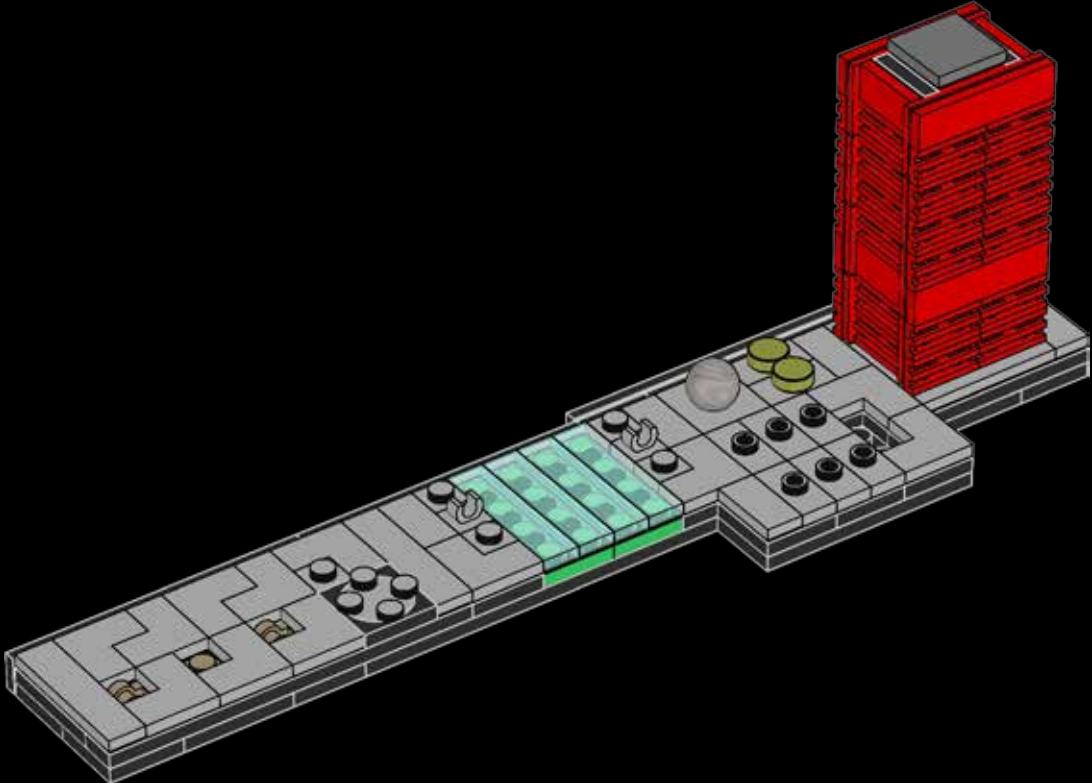

The entire sculpture is cleaned and washed twice a year with 40 US gallons (150 liters) of liquid detergent.



© Patrick Pyszka

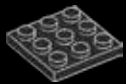

1x

50

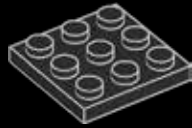

4x

51

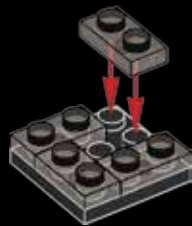

52

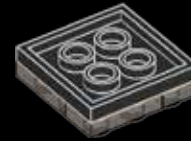

1x

53



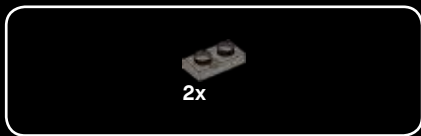

54



55

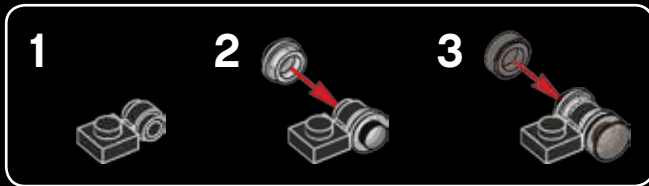

56



57



58

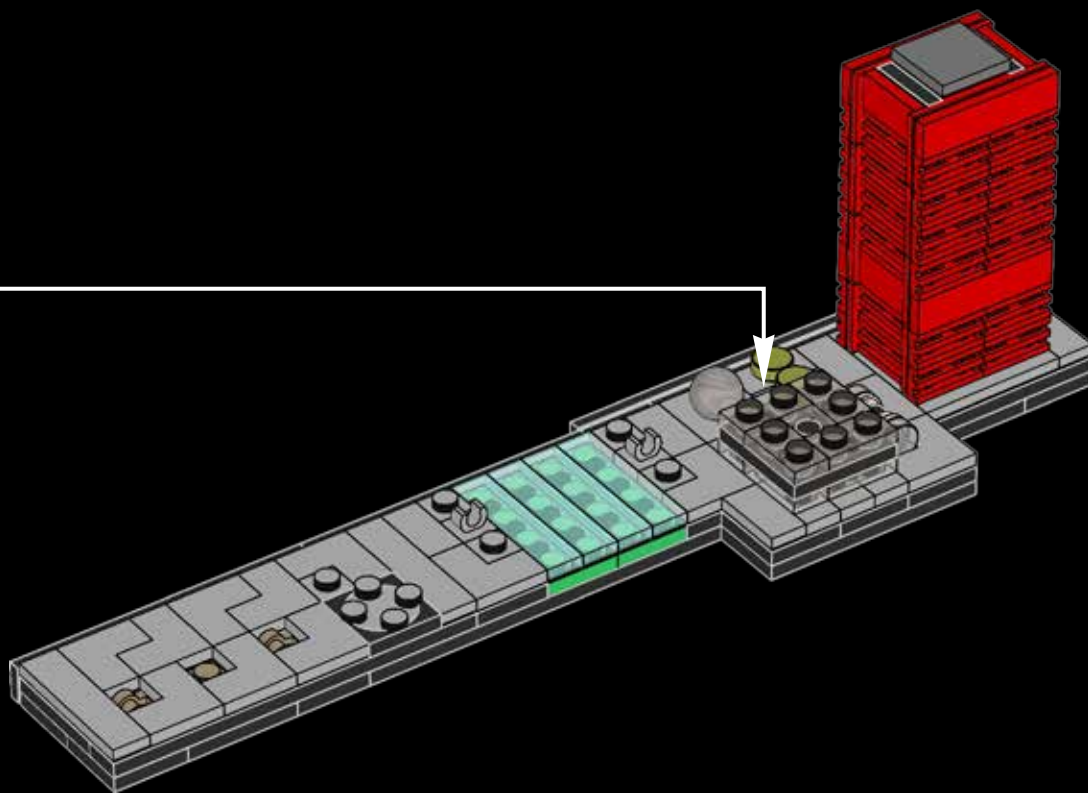

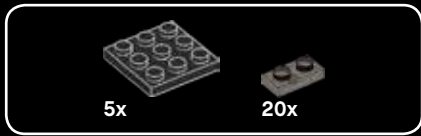

59

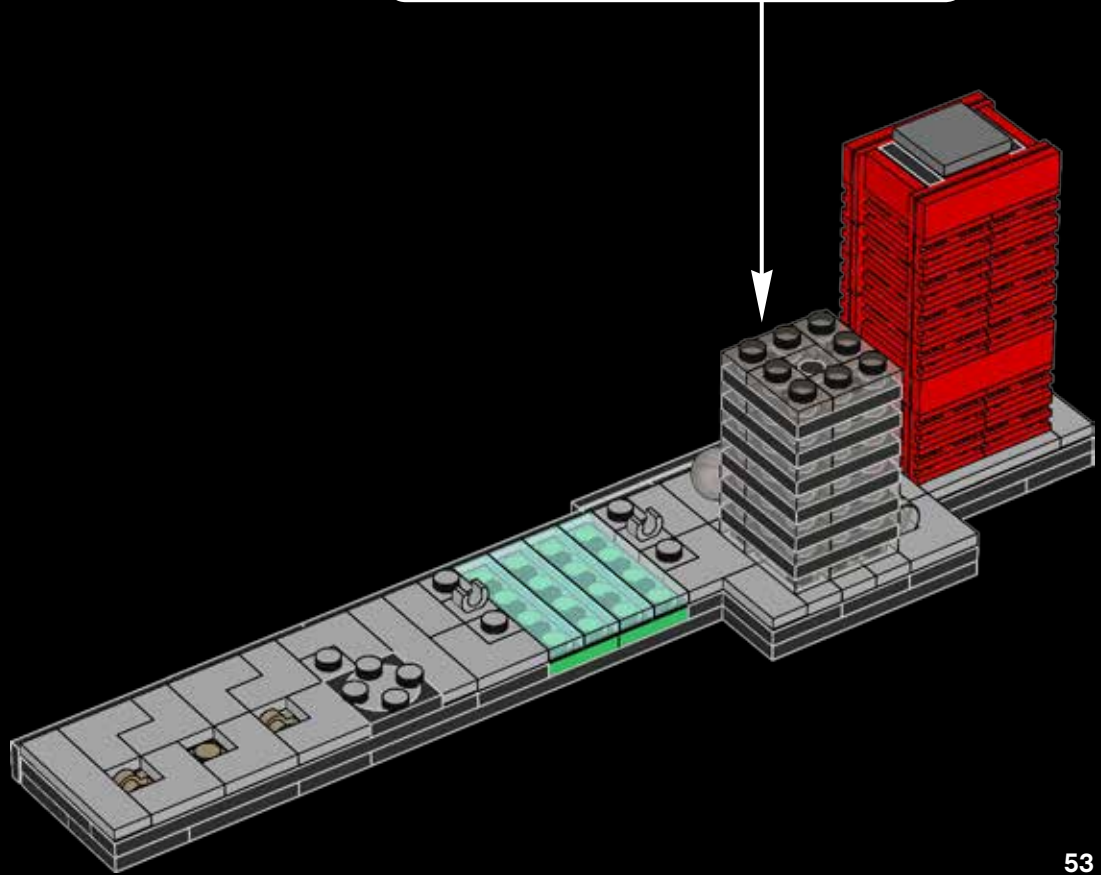
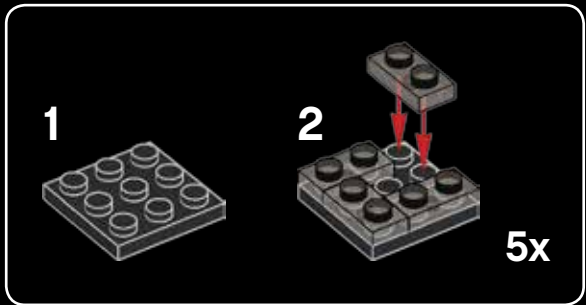



1x

60

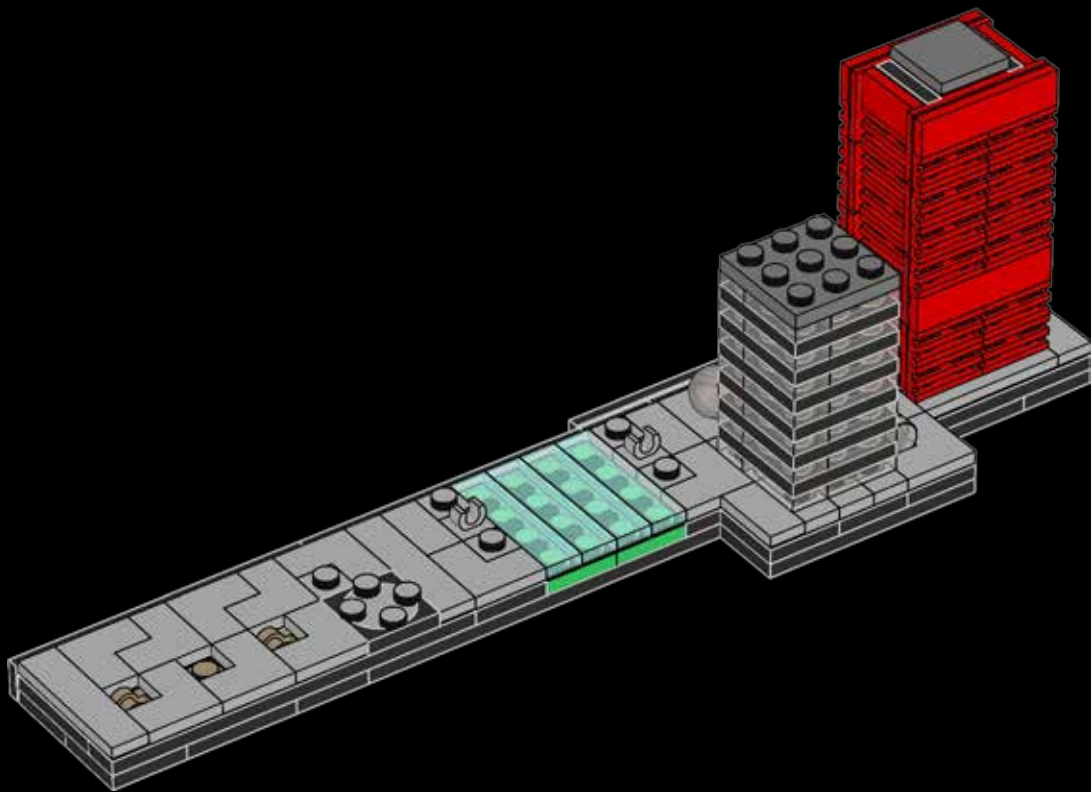

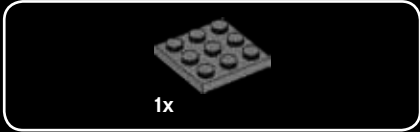

61



62

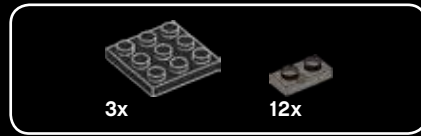
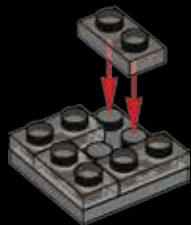

63

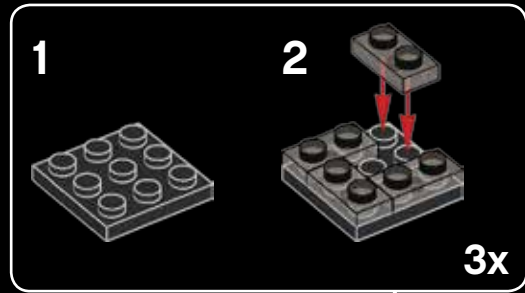



2x



2x



1x

64

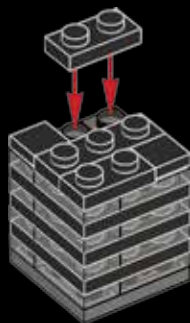

65

Within the tower, there are 25 miles (40.2 km) of plumbing, 1,500 miles (2,414 km) of electric wiring, 80 miles (129 km) of elevator cable, and 145,000 light fixtures.

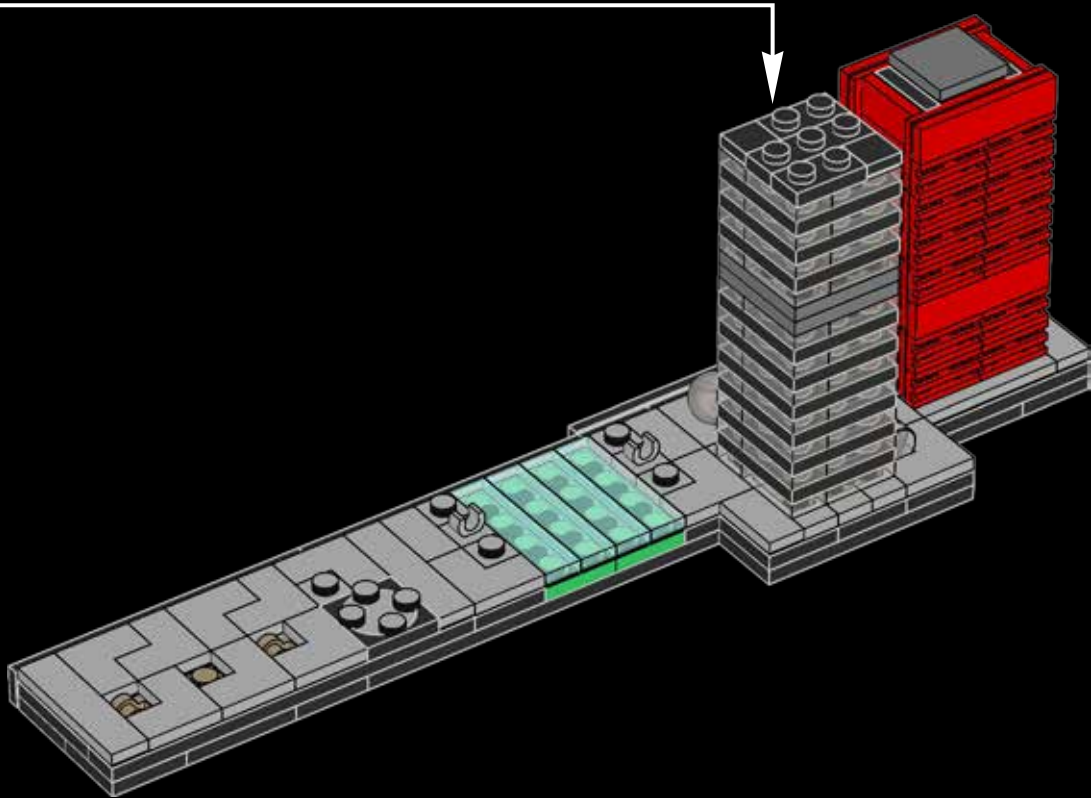



2x



2x

66

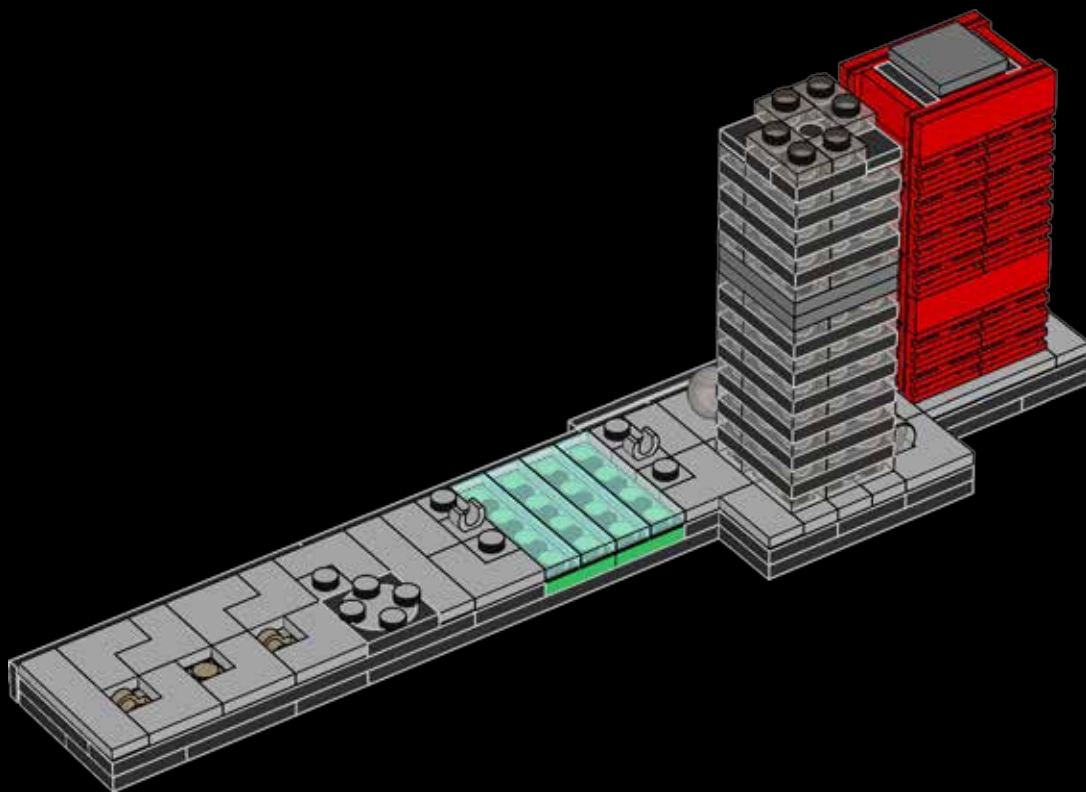



67

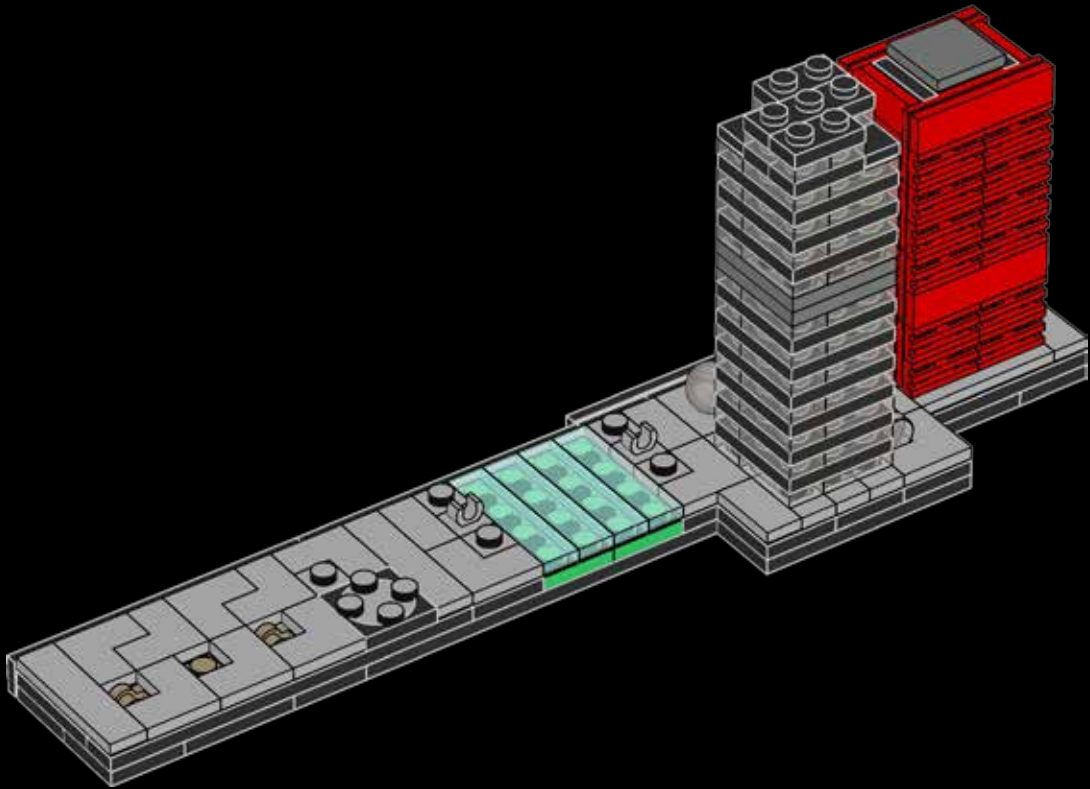



2x



2x

68

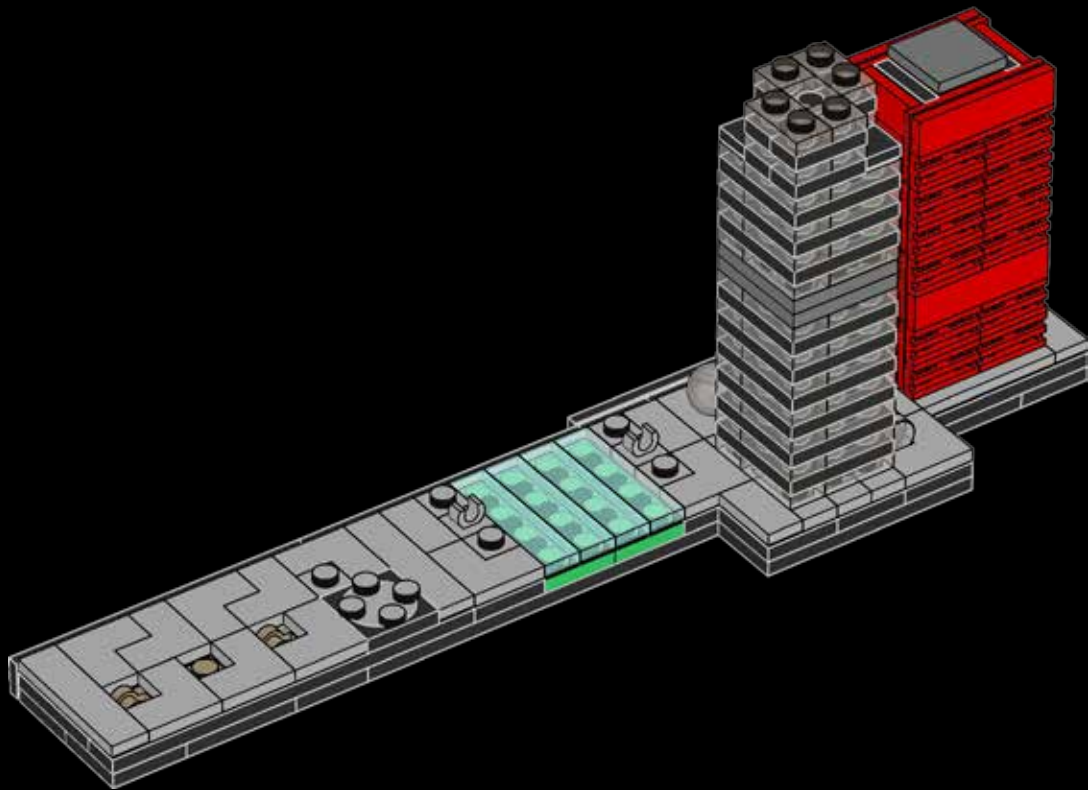



69

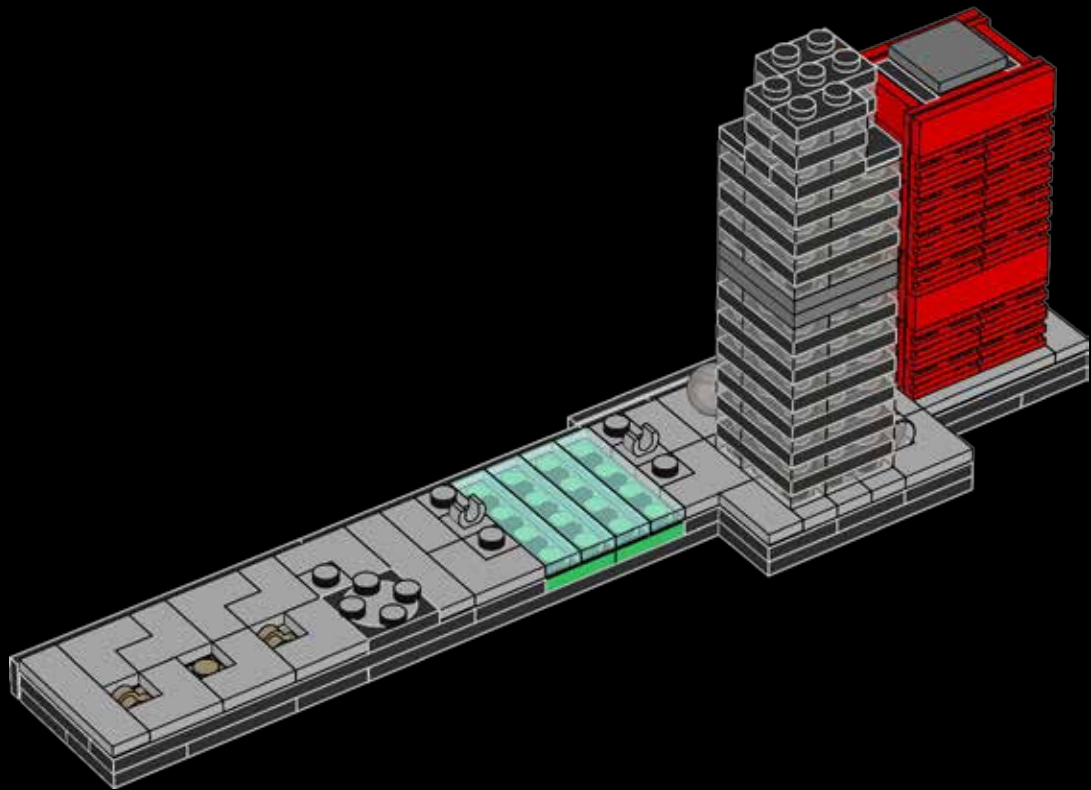



70

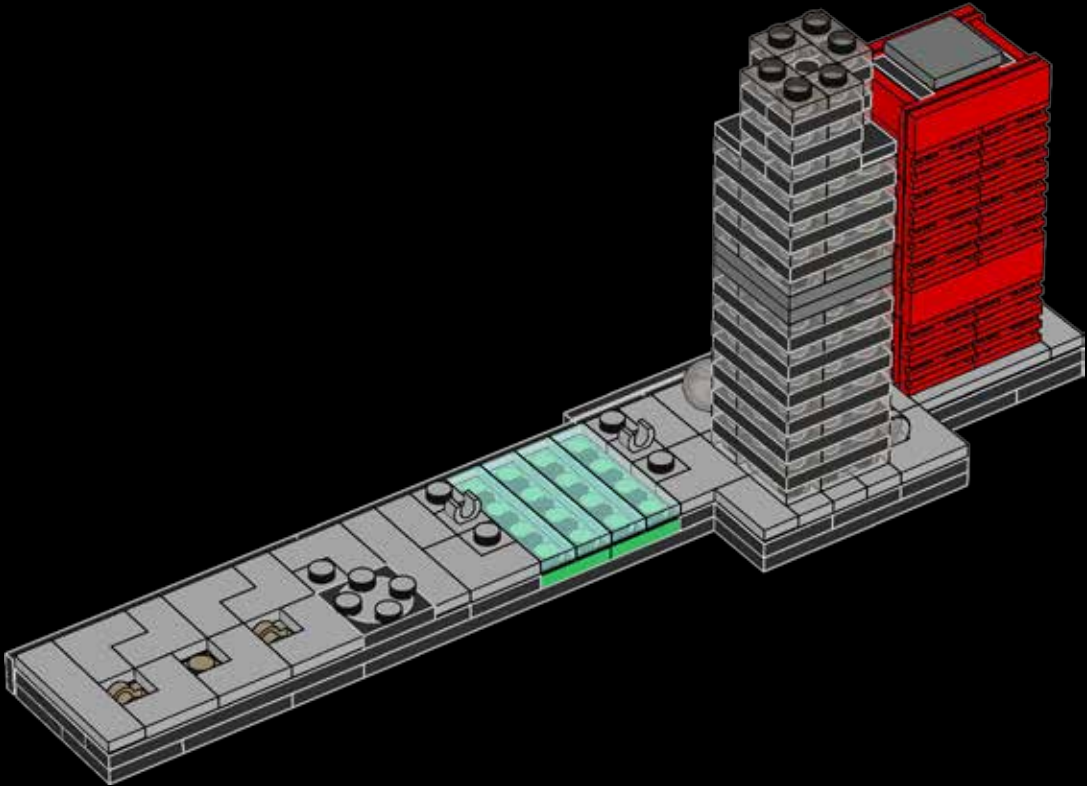



71

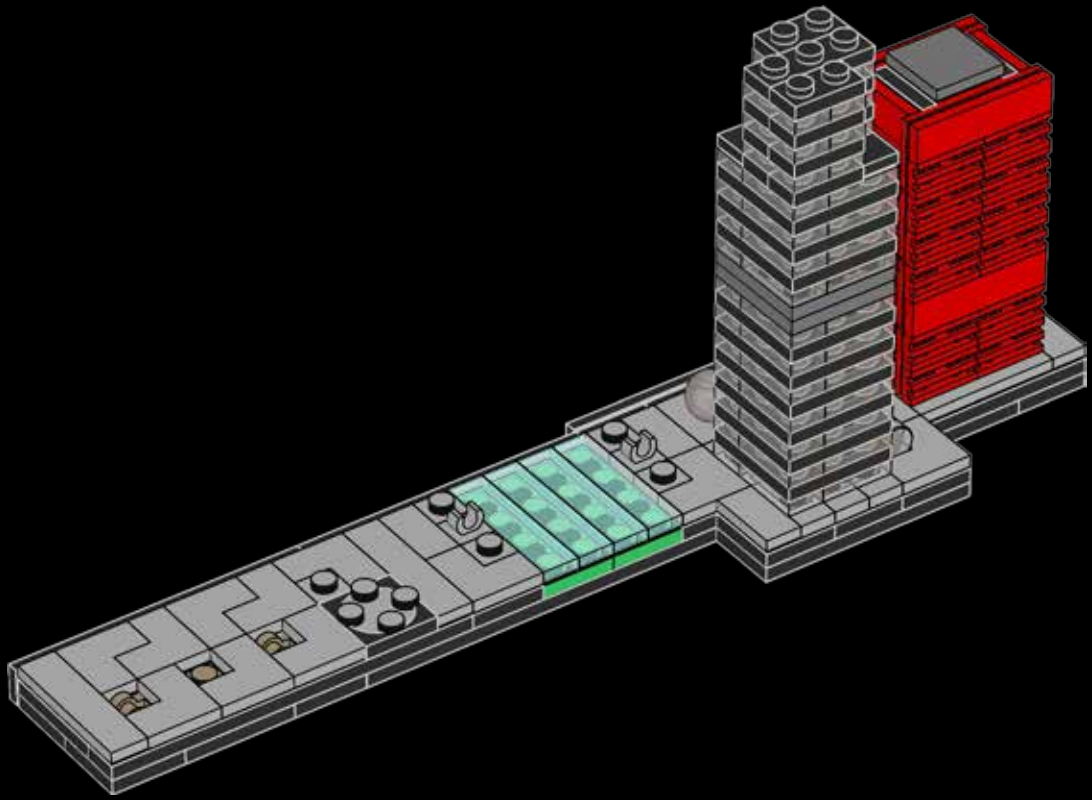



The tower weighs more than 222,500 tons (201,848,605 kg), took three years to complete and used enough concrete to make an eight-lane, five mile long (8 km) highway.



72

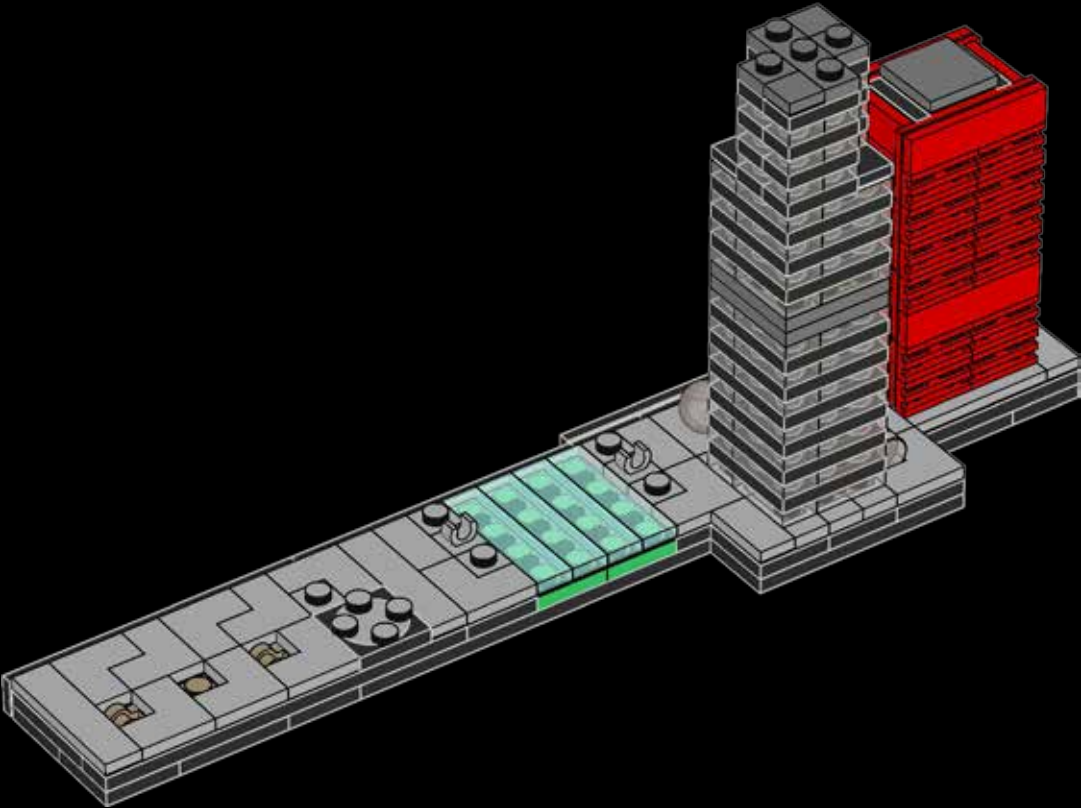



73

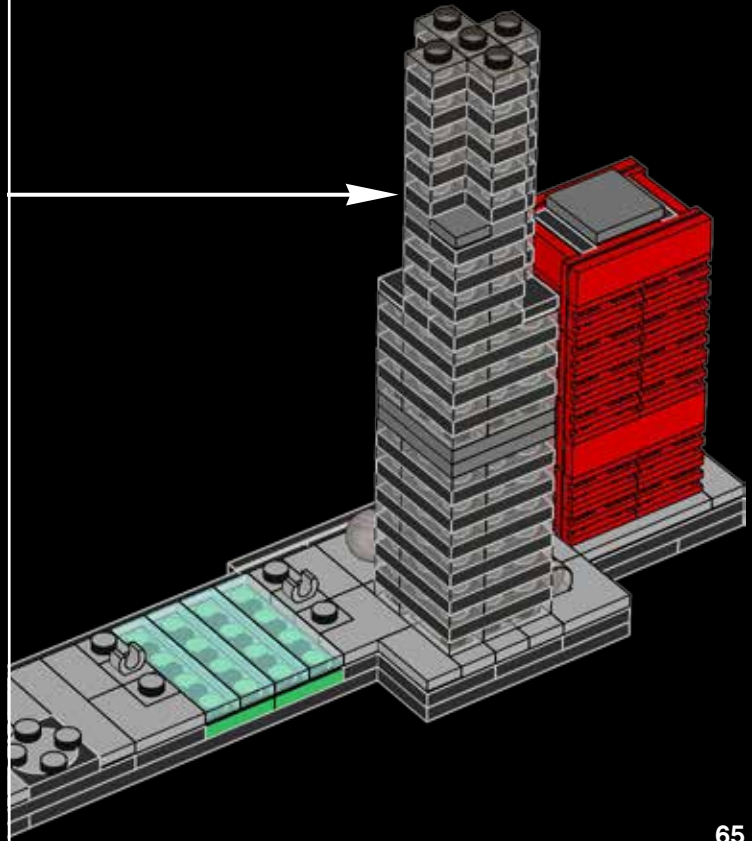
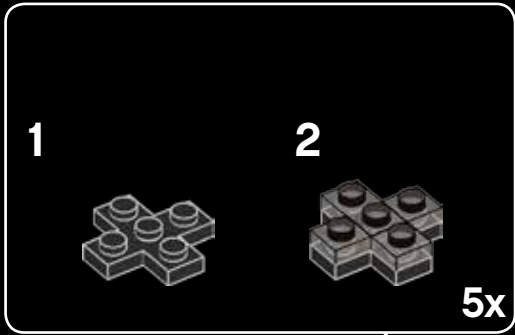

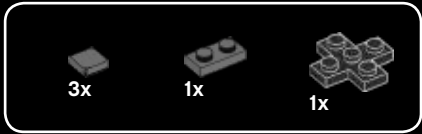

74

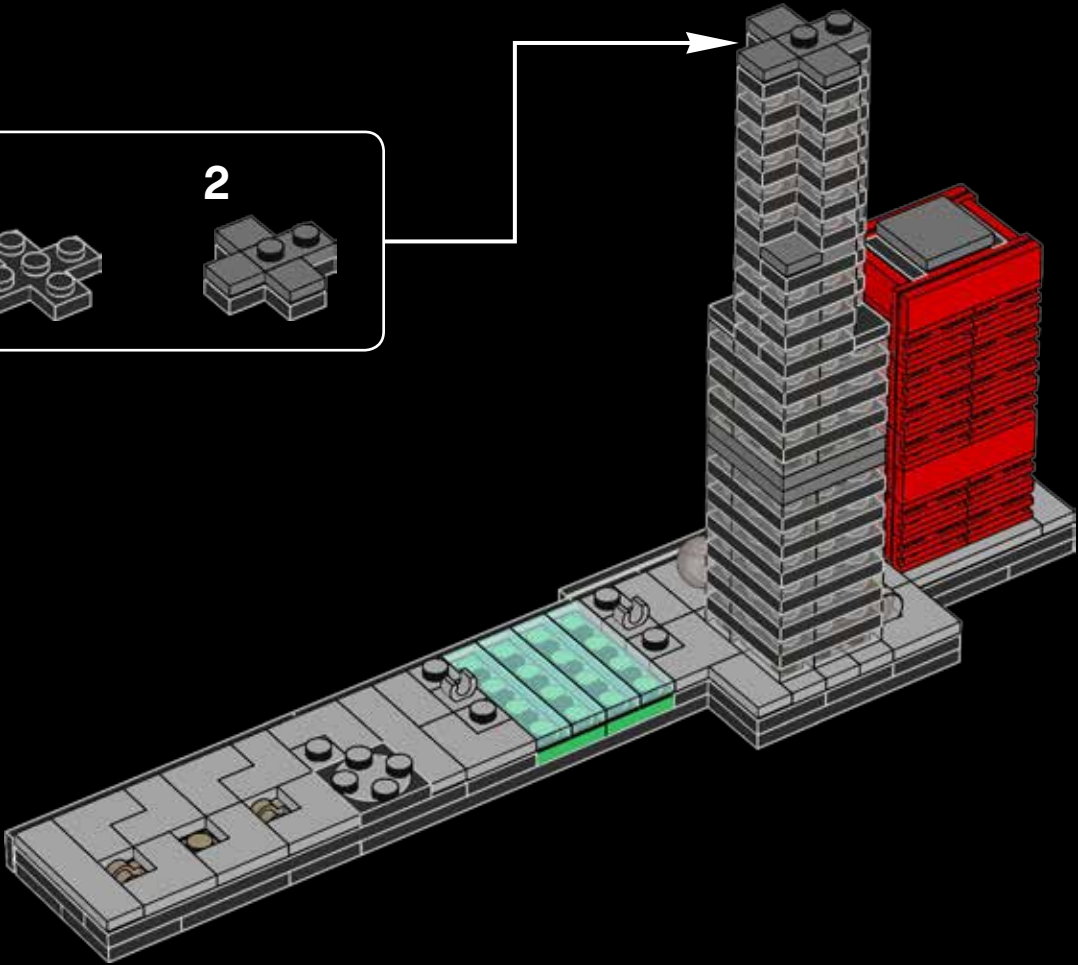
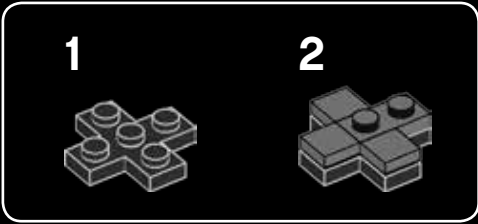



75

1



2

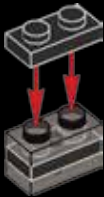

3

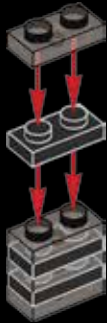

4

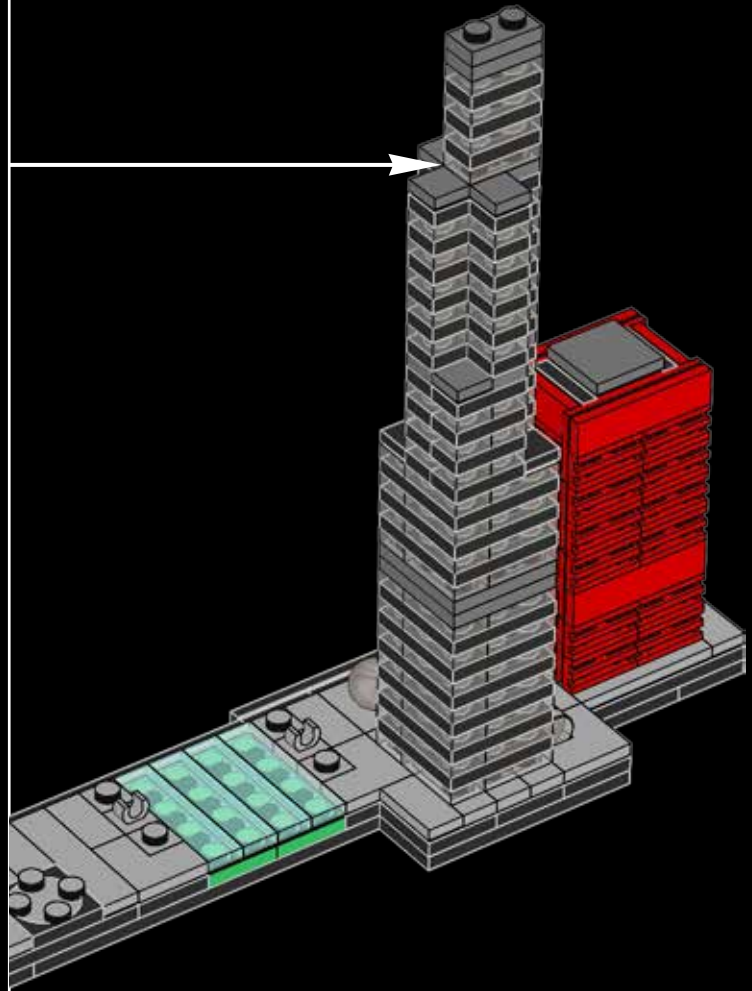



1x

76

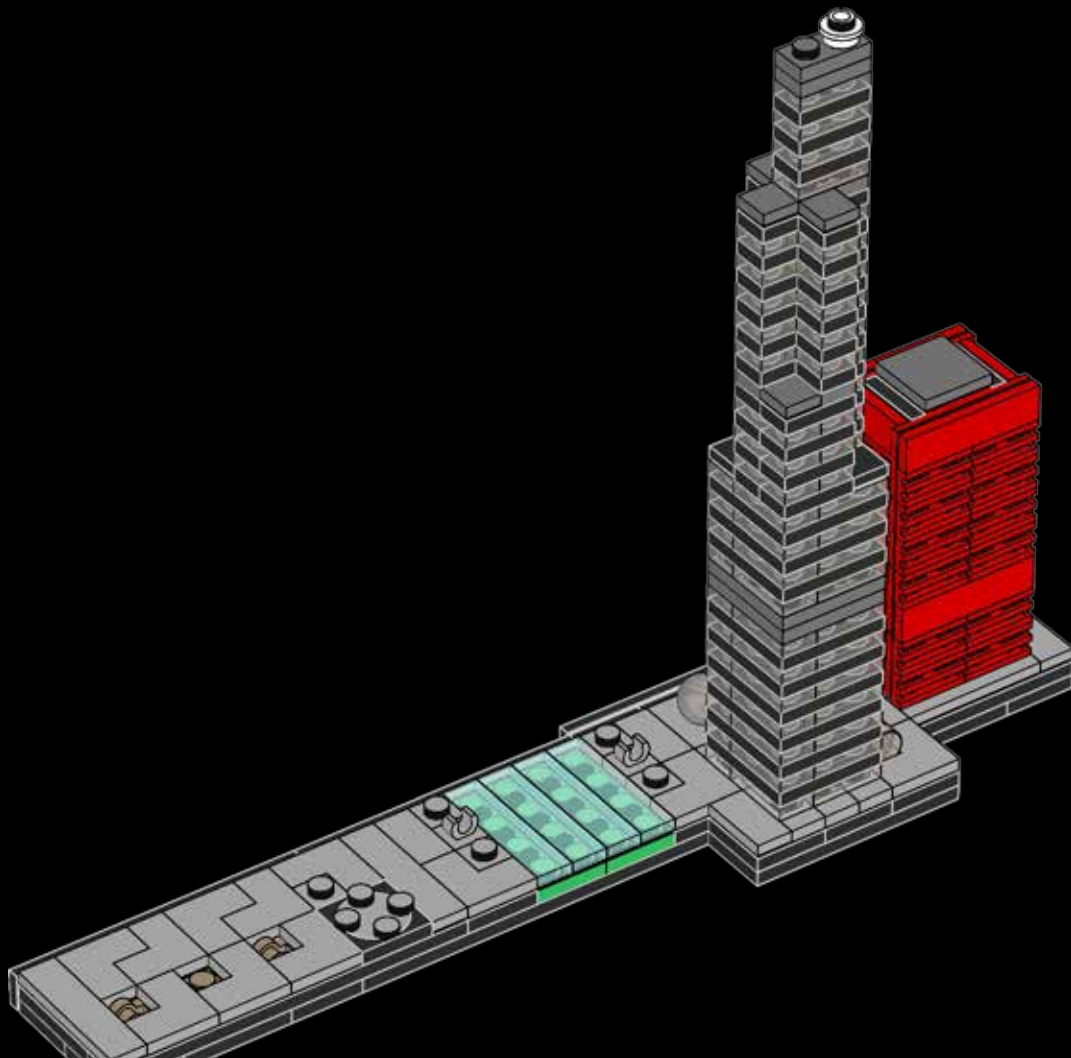

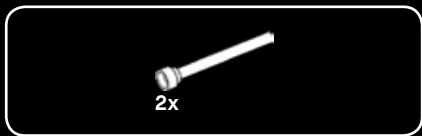

77

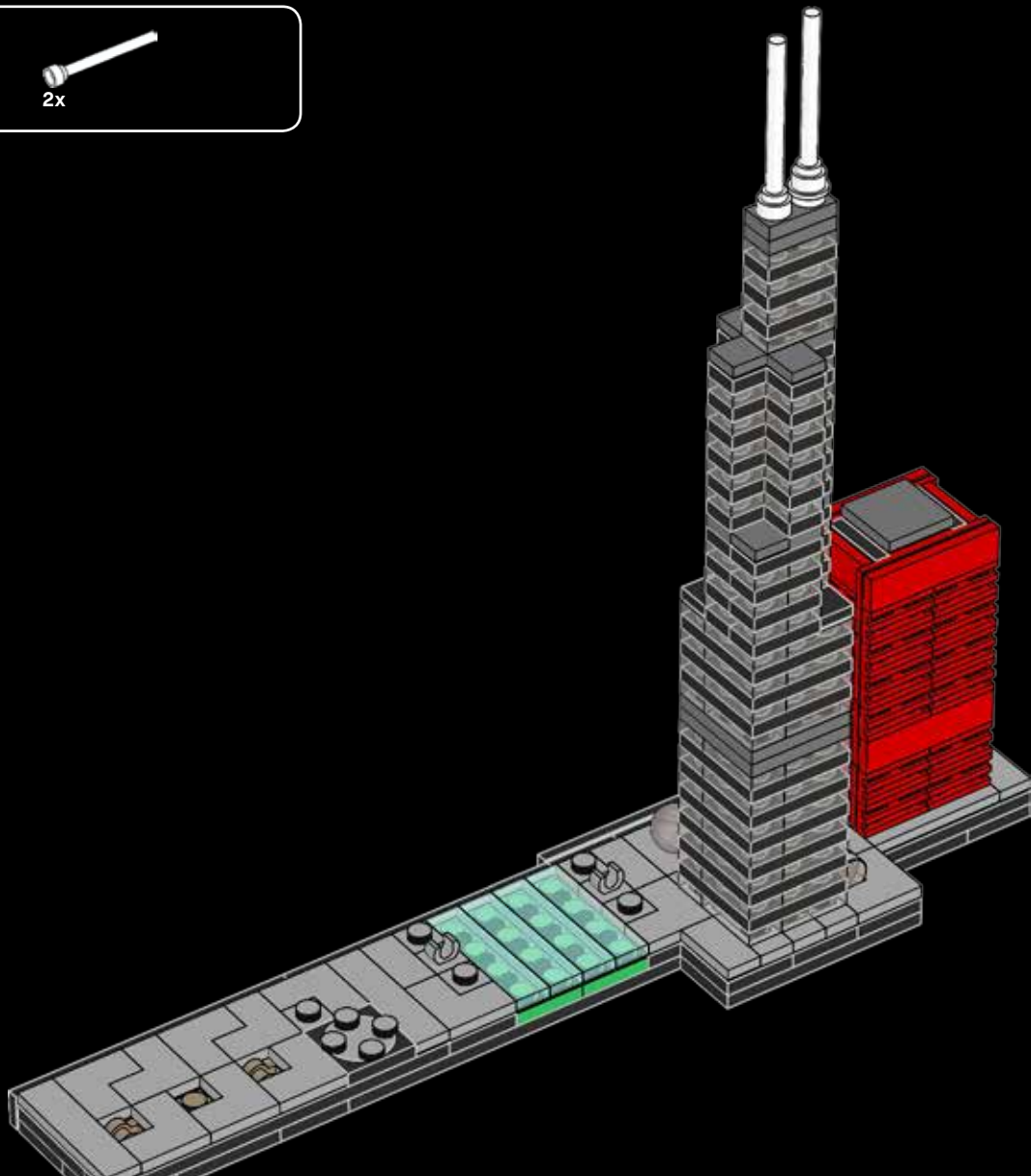

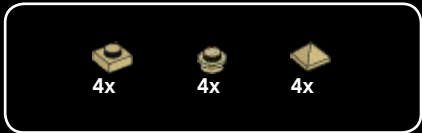

78

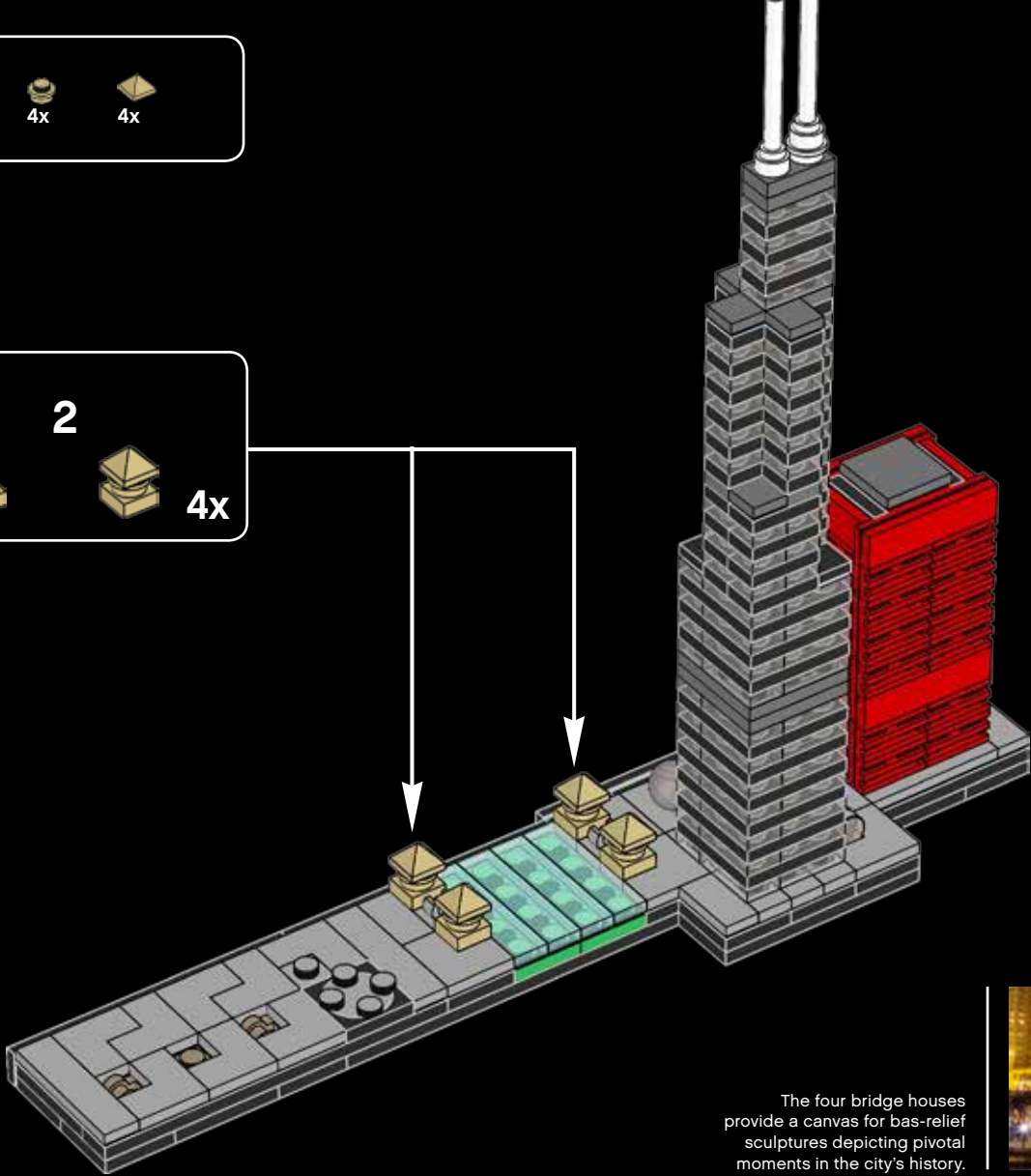
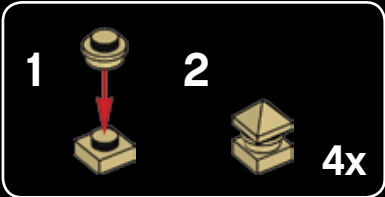

The four bridge houses provide a canvas for bas-relief sculptures depicting pivotal moments in the city's history.





79

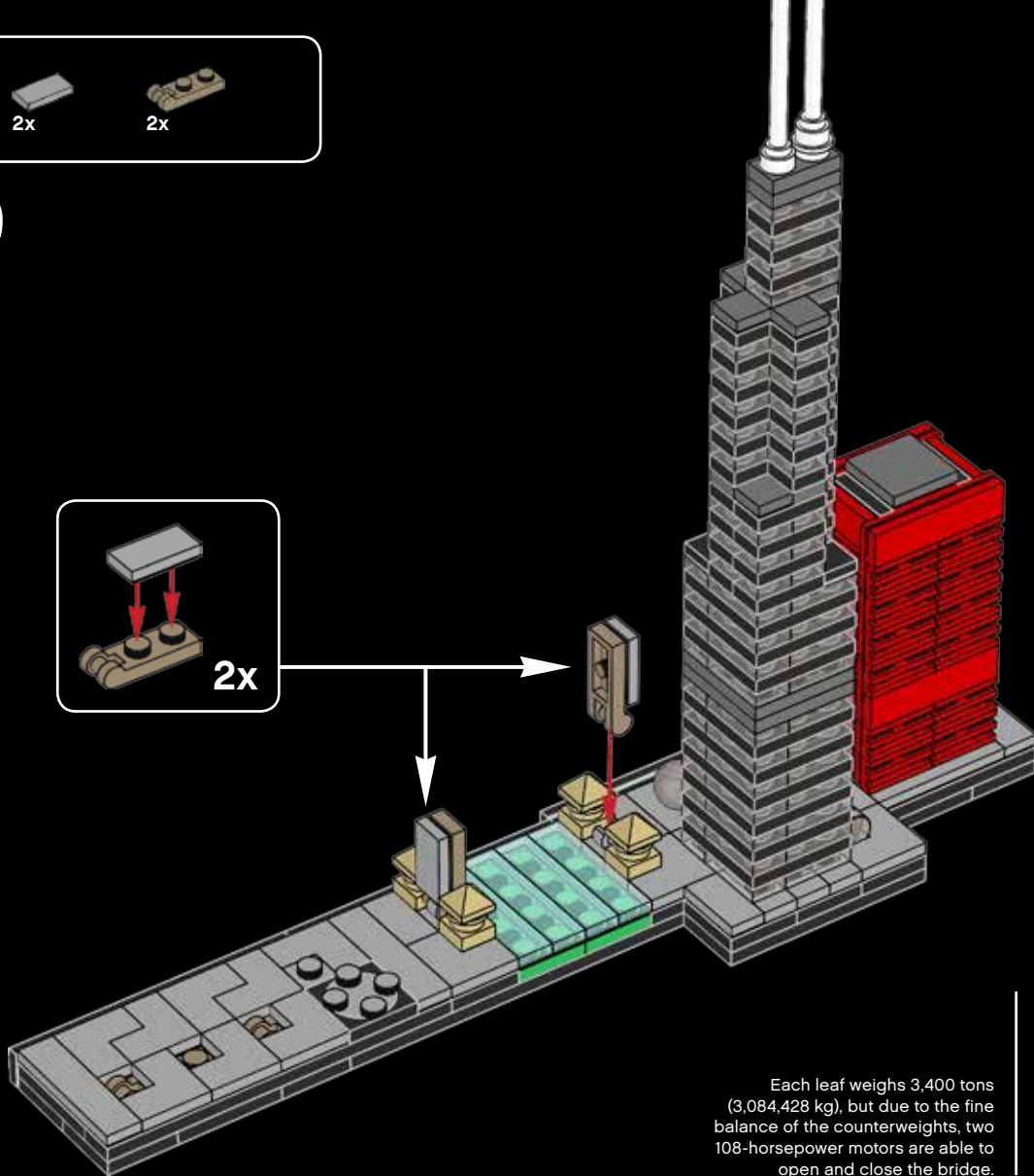
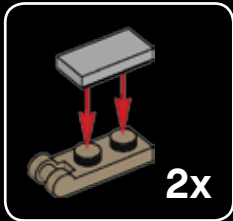

Each leaf weighs 3,400 tons (3,084,428 kg), but due to the fine balance of the counterweights, two 108-horsepower motors are able to open and close the bridge.





2x

80

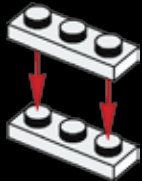

1x



1x

81

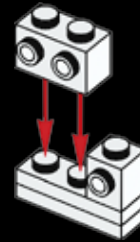

1x

82

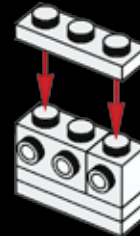

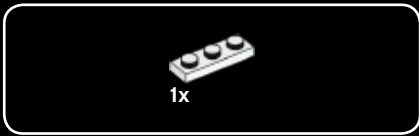

83

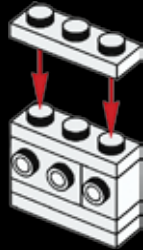

84

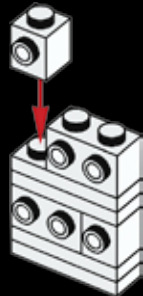

When The Wrigley Building opened, there was an observatory above the 26th floor in the Clock Tower. Admission was 5 cents and included a piece of Wrigley gum. The Clock Tower was inspired by La Giralda, which is now part of Spain's Seville Cathedral.



85

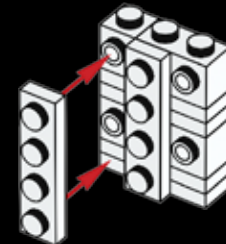



2x

86

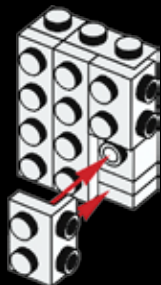

1x

87

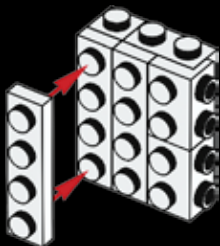

2x



4x

88

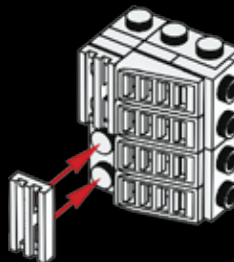

2x

89

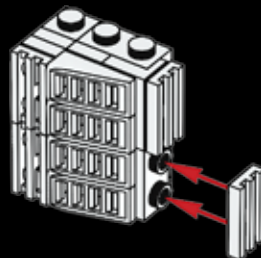



90

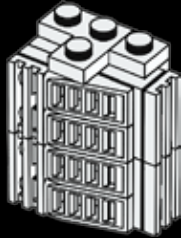

91

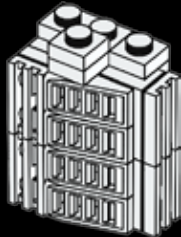

92

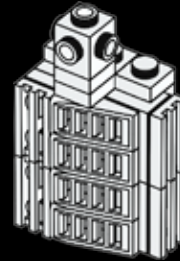

93





The Wrigley Building was the first to be air-conditioned in Chicago and the tallest at the time of its construction.

94

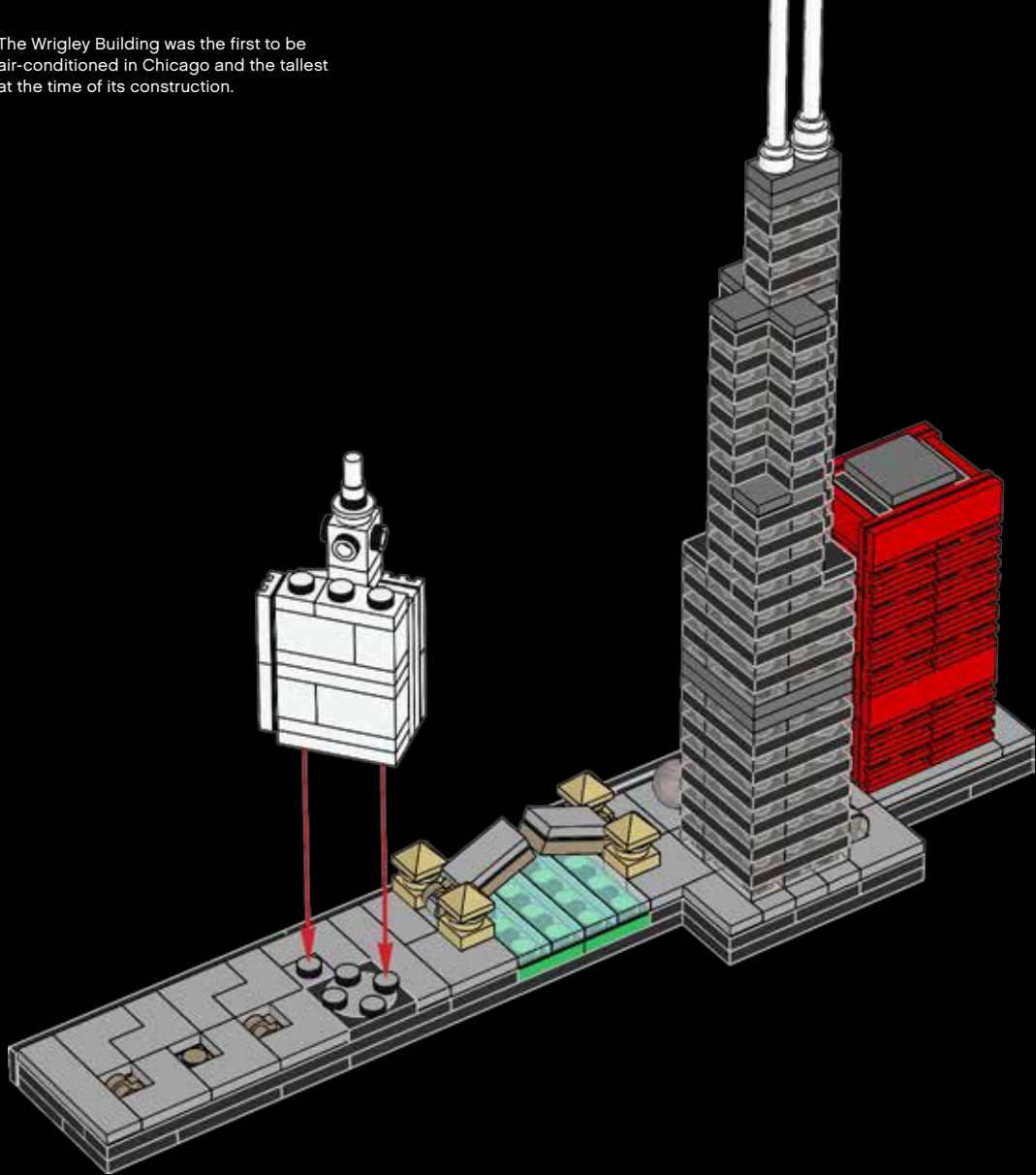

There are 1,632 steps from the main lobby to the observatory on level 94 of the tower.

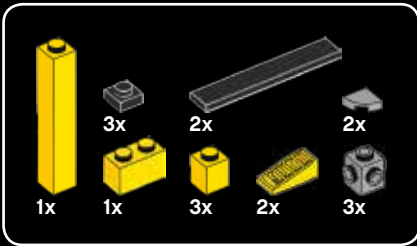

95

1



2



3



4

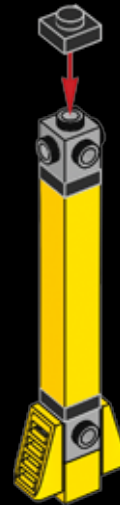

5



6

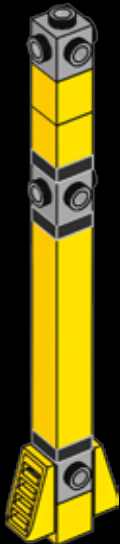

7



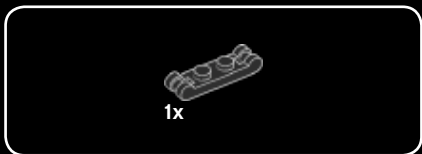
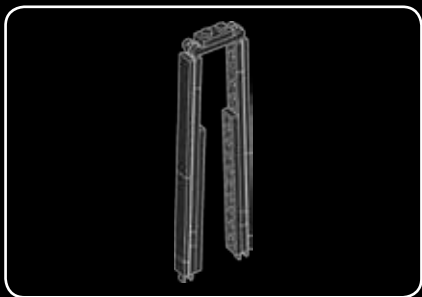

96



97

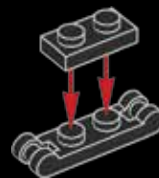

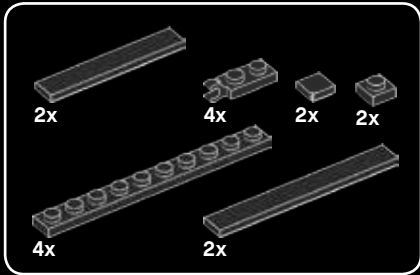
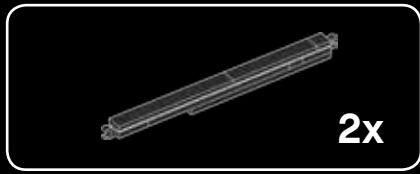

98

1

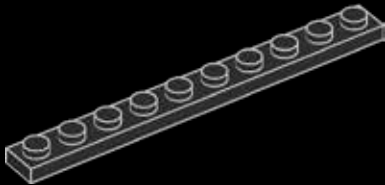

2

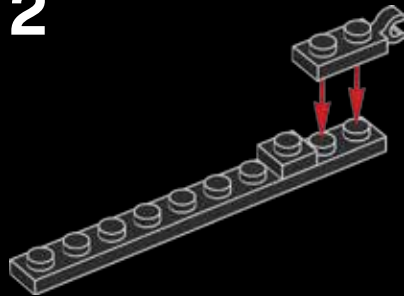

3

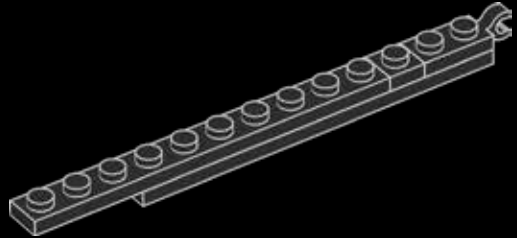

The tower's design was tested to withstand winds of 132 miles per hour (212.4 km per hour).

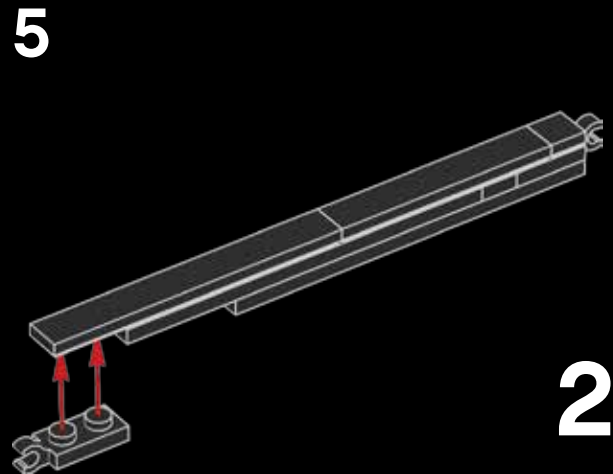
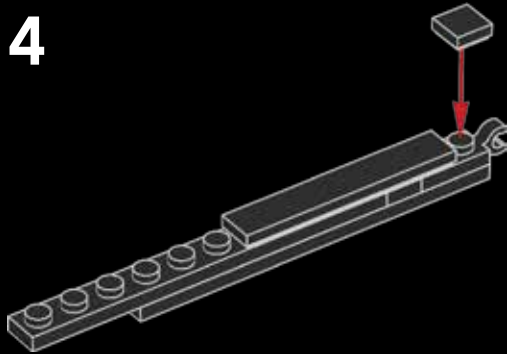

2x
81

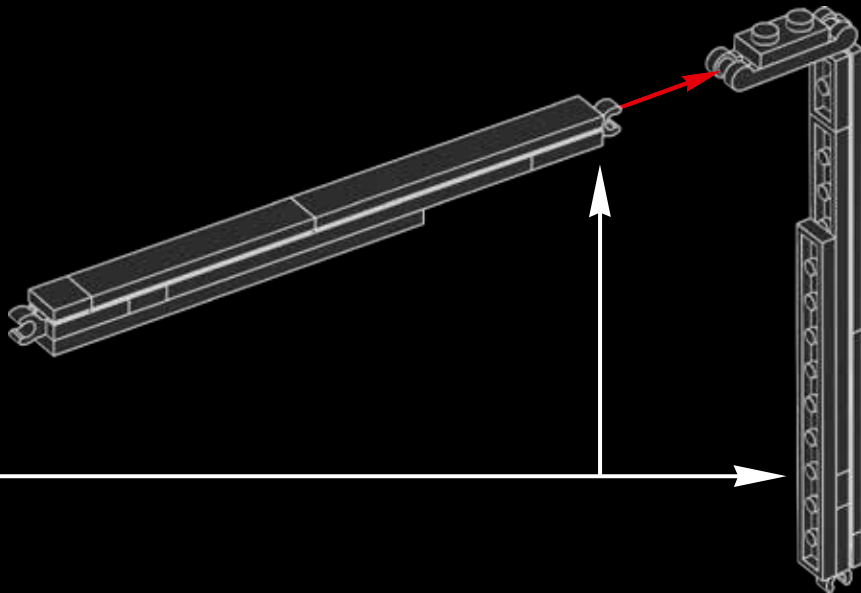

99

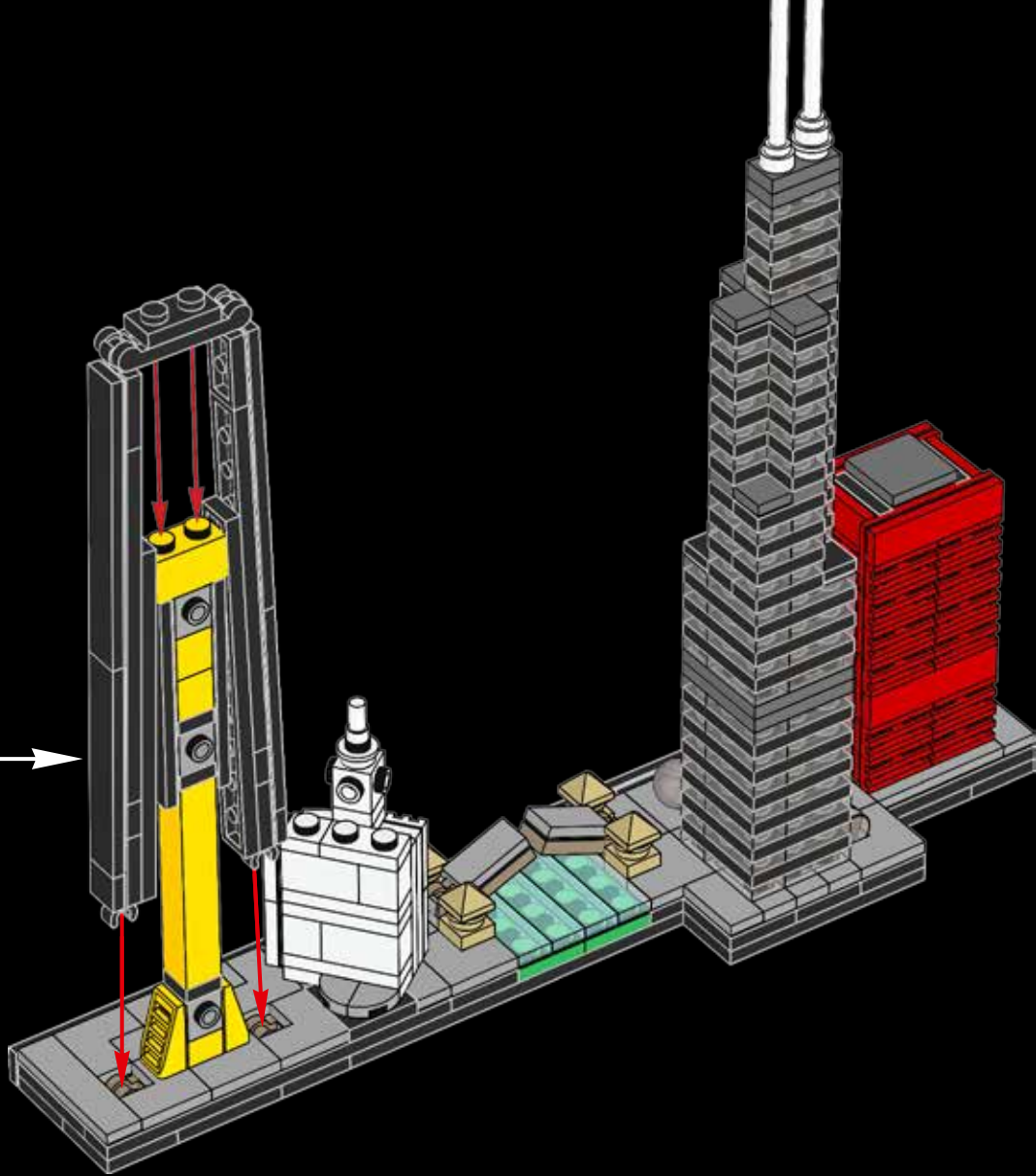

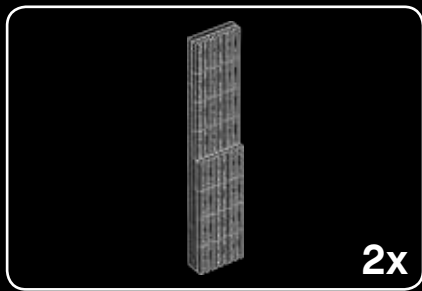

100

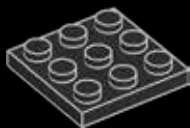

101

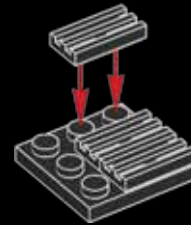

102

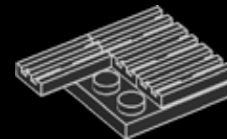

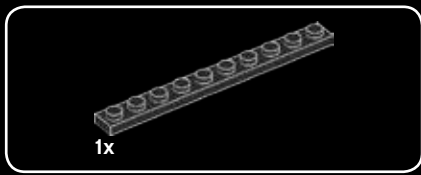

103

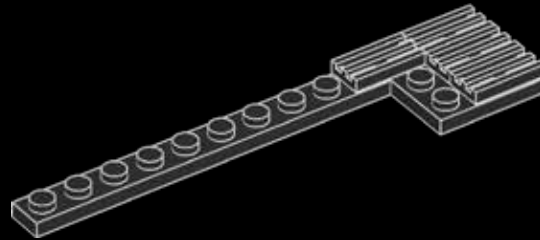

104

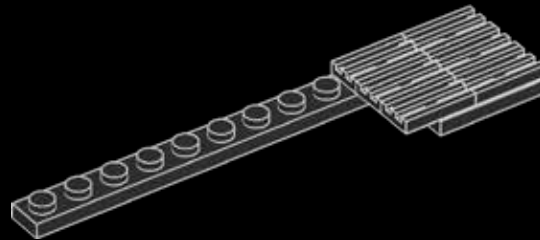

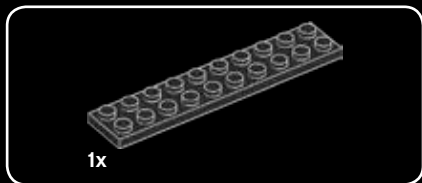

105

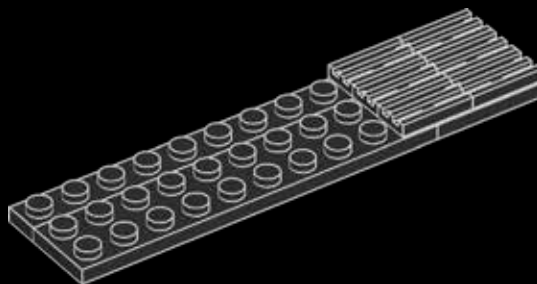

106

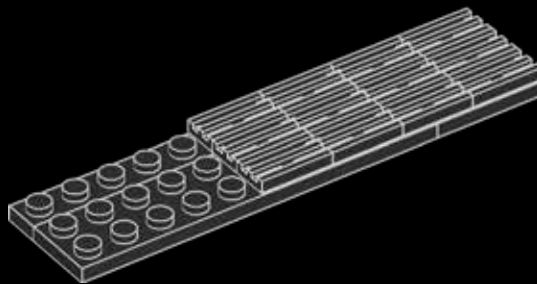



107

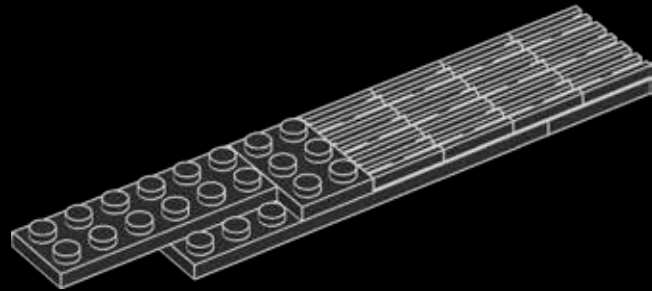

108

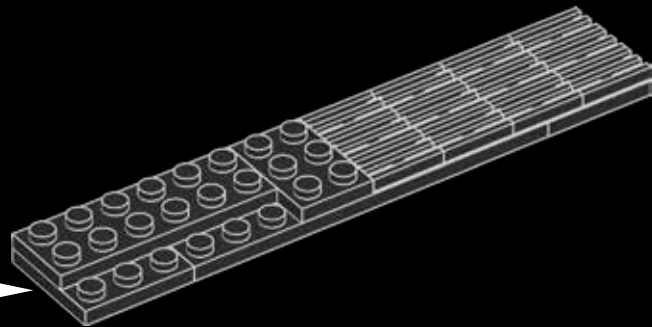
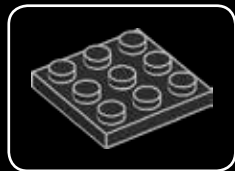

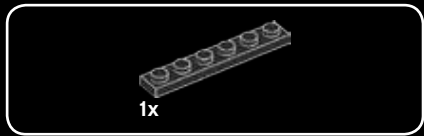

109

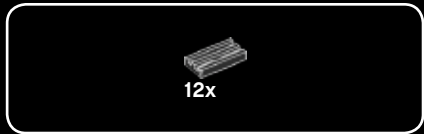
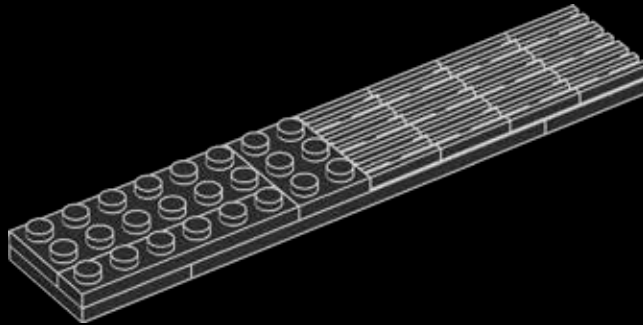

110

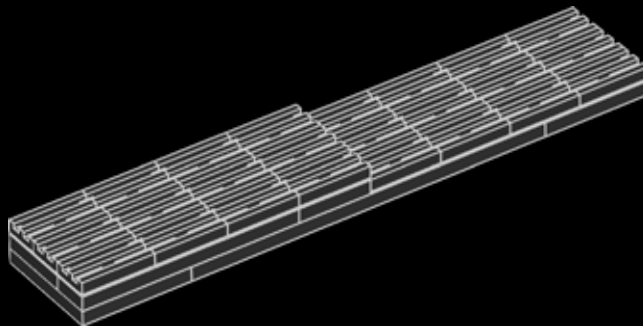

2x

111

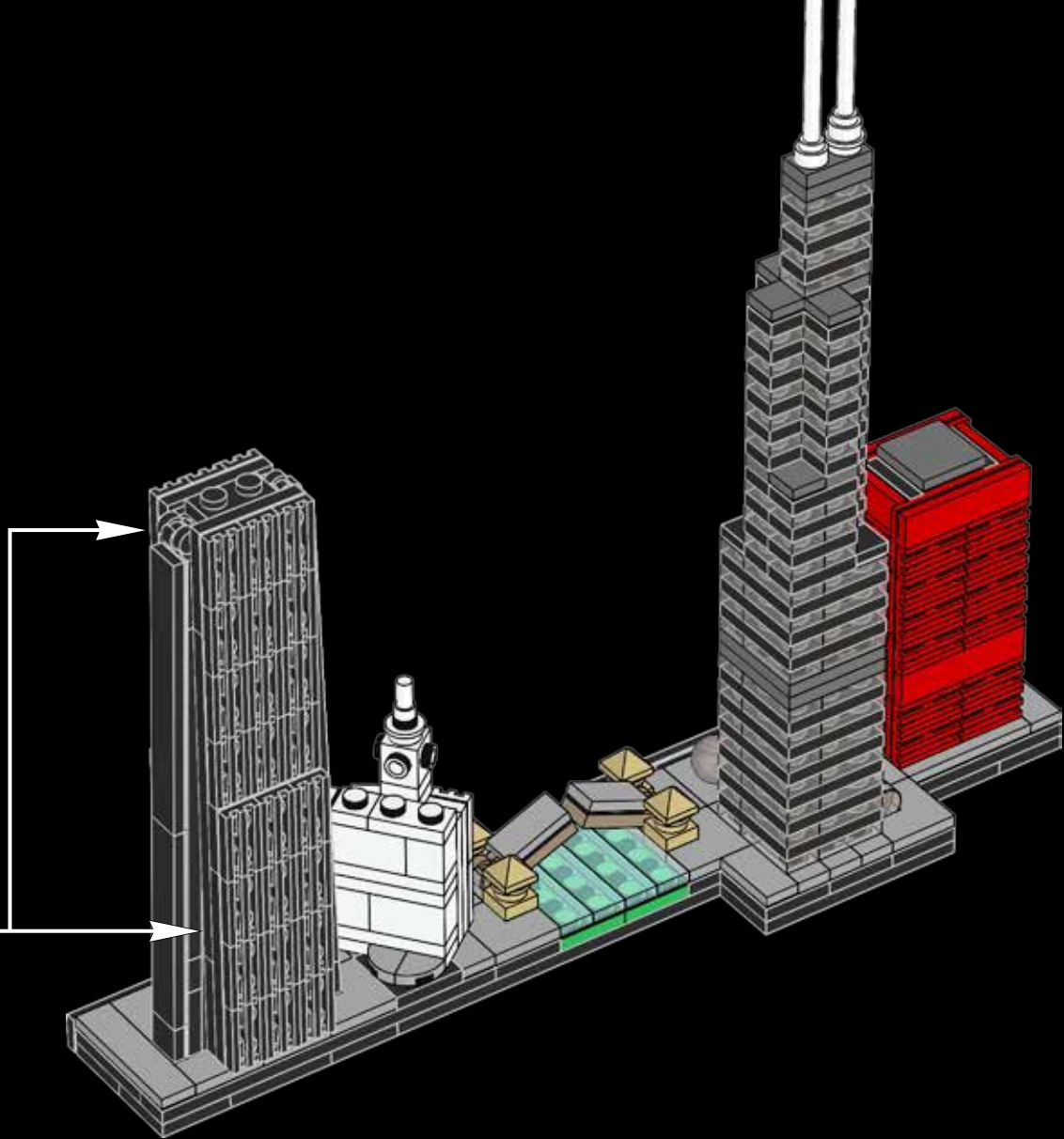

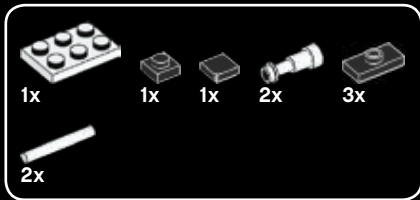

112

1



2

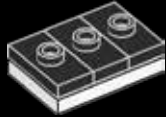

3

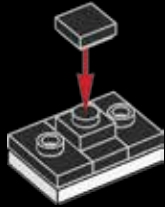

4



5

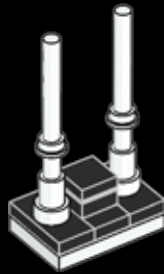

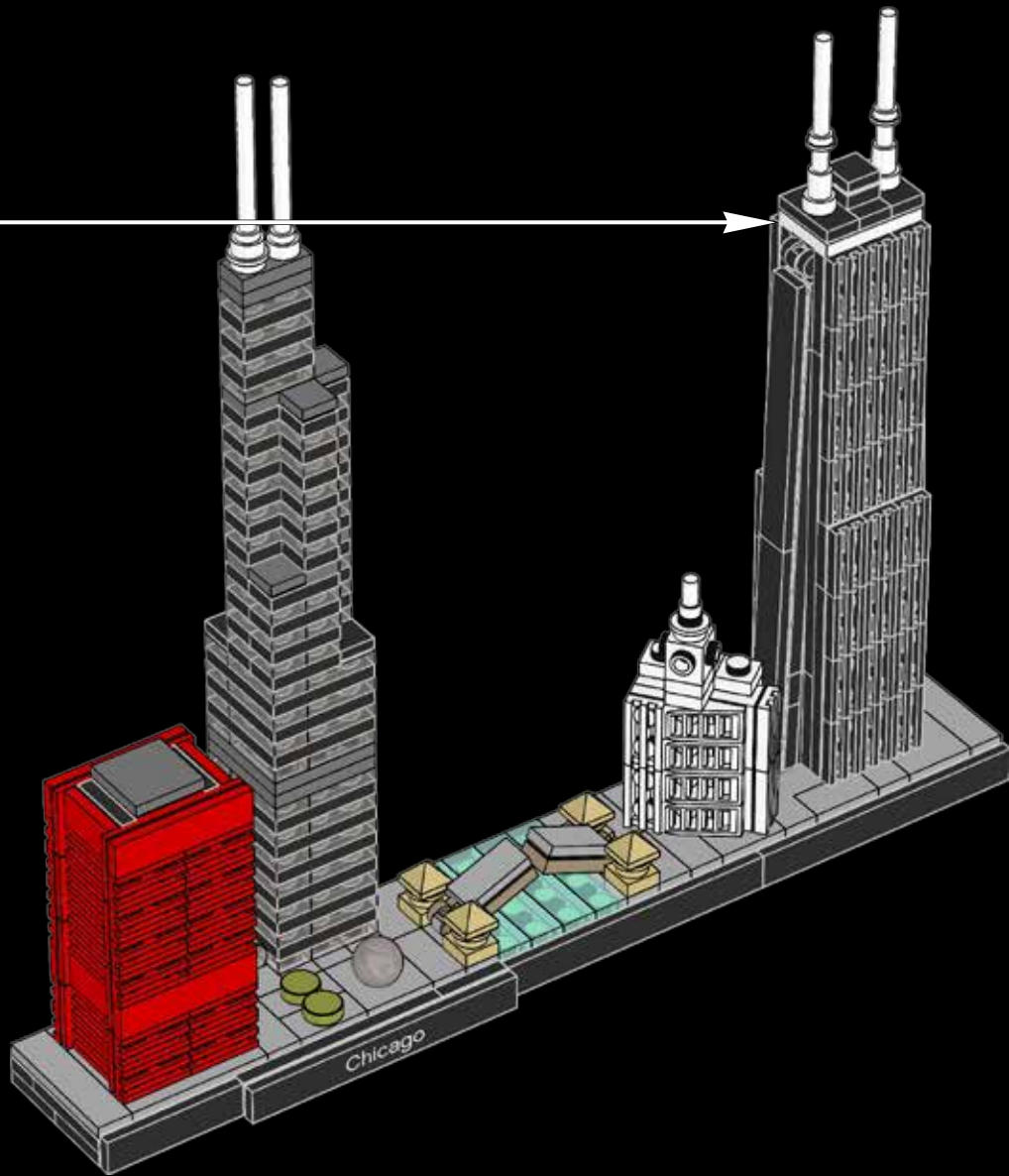



LEGO® Architecture – do you like it?

The LEGO Group would like your opinion on the new product you have just purchased. Your feedback will help shape the future development of this product series.

Please visit:

[LEGO.com/productsurvey](https://www.lego.com/productsurvey)

By completing our short feedback survey, you will be automatically entered into a drawing to win a LEGO® prize.

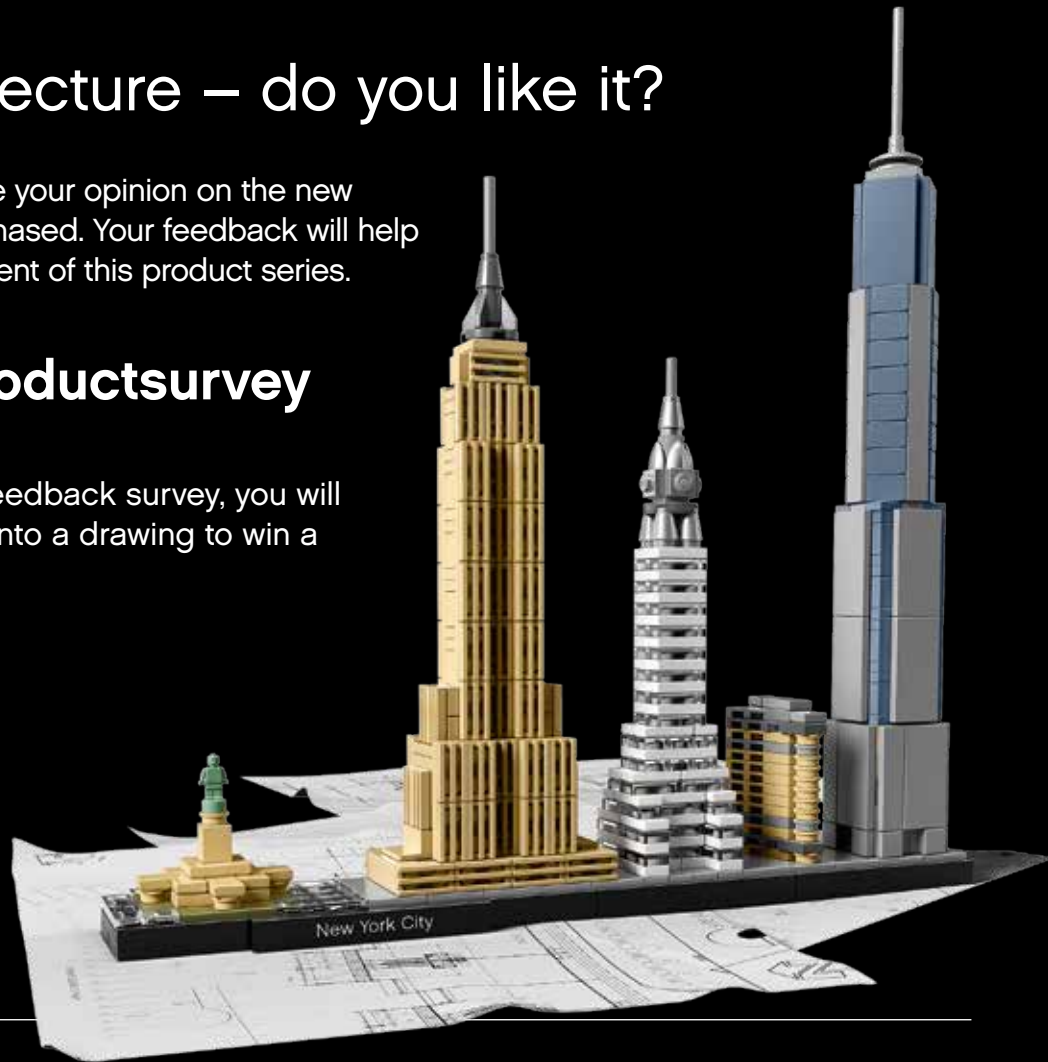

See website for official rules and details. Open to all countries where not prohibited.

LEGO and the LEGO logo are trademarks of the/son des marques de commerce du/son marcas registradas de LEGO Group.
©2017 The LEGO Group.

LEGO® Architecture—then and now

There has always been a natural connection between the LEGO® brick and the world of architecture. Fans who build with LEGO elements instinctively develop an interest in the form and function of the structures they create. At the same time, many architects have discovered that LEGO bricks are the perfect way of physically expressing their creative ideas.

This connection was confirmed in the early 1960s with the launch of the LEGO 'Scale Model' line. It matched the spirit of the age where modern architects were redefining how houses look and people were taking an active interest in the design of their new homes. These sets were designed to be different from the normal, brightly colored LEGO boxes; they also included a book on architecture as a source of inspiration.

Decades later, architect and LEGO fan Adam Reed Tucker, revived the idea of expressing architecture using LEGO bricks and in partnership with the LEGO Group, launched the LEGO Architecture line that we know today.

His first models, and the original sets in the current LEGO Architecture series, were interpretations of famous skyscrapers from his hometown of Chicago. Since then LEGO Architecture has developed and evolved, first with well-known buildings from other cities in the United States, and now with iconic structures from Europe, the Middle East and Asia.

The introduction of our LEGO Architecture Studio set echoes the ambitions of the earlier LEGO 'Scale Model' line and widens the potential of the LEGO Architecture series. Now you can enjoy building and learning about specific landmark buildings, or create exciting architectural models from your own fantasy. An inspiring 270-page book, featuring a number of renowned architects from around the world, guides you through the principles of architecture and encourages you in your own creative building.



21050
Studio

Celebrate the world of architecture and collect all the models



21024
Louvre



21030
United States Capitol Building

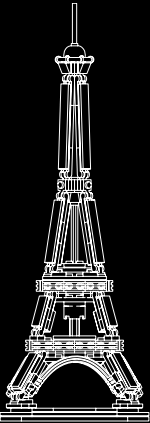

21019
The Eiffel Tower

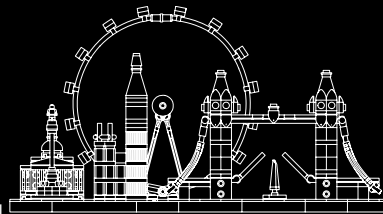

21034
London

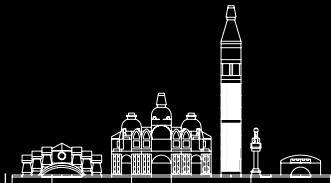

21026
Venice

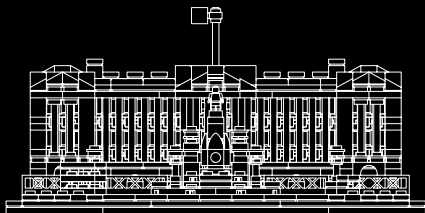

21029
Buckingham Palace

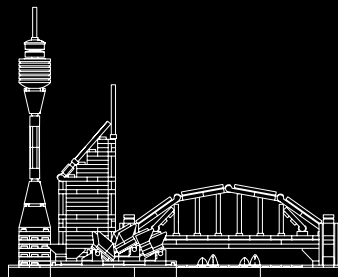

21032
Sydney



21027
Berlin



21028
New York City

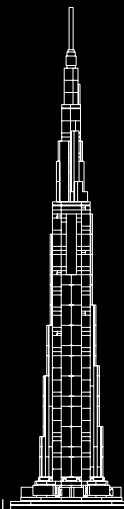

21031
Burj Khalifa

References:

Pictures -

© Shutterstock

© Offset

Text -

www.johnhancockcenterchicago.com

www.willistower.com

www.thewrigleybuilding.com

www.cityofchicago.org

www.architecture.org

Customer Service
Kundenservice
Service Consommateurs
Servicio Al Consumidor
LEGO.com/service or dial

00800 5346 5555 : 
1-800-422-5346 : 

1x
6189137

2x
4547649

2x
4558952

2x
302401

2x
6058177

4x
241201

4x
6023804

2x
6070327

2x
6018774

2x
6093526

3x
242001

4x
362301

1x
302101

3x
371001

2x
395701

4x
4161734

4x
4159553

4x
6177165

4x
306921

36x
241221

8x
6118830

4x
243121

3x
300524

1x
6119192

2x
4540384

5x
300424

5x
307026

6x
302426

1x
4632571

3x
6092585

48x
241226

14x
302326

4x
4535739

6x
302226

1x
368026

3x
242026

6x
6097283

7x
362326

1x
6174624

13x
6174917

1x
6099483

4x
302126

1x
243126

4x
366626

4x
663626

4x
379526

3x
4653049

4x
416226

1x
303226

2x
303426

7x
447726

3x
383226

14x
302328

1x
6000070

1x
383228

2x
3005740

4x
4586557

2x
6079000

22x
6030982

58x
6001197

4x
6135607

2x
6176433

2x
6071229

5x
4211399

3x
4211511

1x
4540203

8x
6066097

8x
4211414

1x
6126082

12x
6065824

4x
4654577

5x
4211356

2x
4210719

5x
4210848

3x
4211063

1x
4211055

1x
4211133

2x
6039176

2x
6047015

1x
6082975

1x
4111971

