

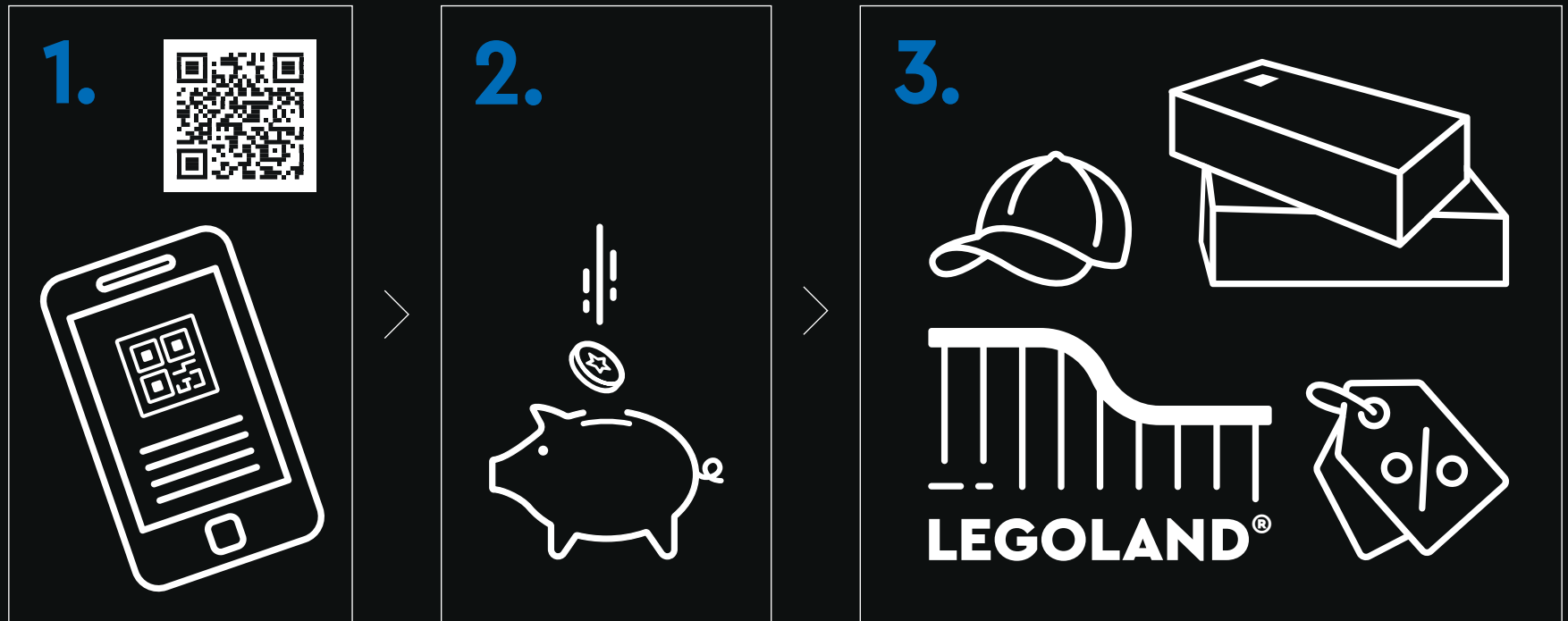



LEGO.com/sustainable-packaging

LEGO® VIP



1. Sign up **2.** Earn points for purchases **3.** Redeem points for rewards, experiences, discounts & more | **1.** Melde dich an **2.** Sammle Punkte bei jedem Kauf **3.** Löse die Punkte für Belohnungen, Erlebnisse, Rabatte und Ähnliches ein | **1.** Inscrivez-vous **2.** Gagnez des points lors de vos achats **3.** Échangez vos points contre des récompenses, des expériences, des remises et bien plus encore | **1.** Iscriviti **2.** Guadagna punti con i tuoi acquisti **3.** Riscatta punti per premi, esperienze, sconti e altro ancora | **1.** Regístrate **2.** Gana puntos por tus compras **3.** Canjea puntos por recompensas, experiencias, descuentos y mucho más | **1.** Registe-se **2.** Ganhe pontos em compras **3.** Troque os pontos para prémios, experiências, descontos e muito mais | **1.** 注册 **2.** 购物赚积分 **3.** 用积分兑换奖励、体验、折扣等 | **1.** Zarejestruj się **2.** Zdobywaj punkty za zakupy **3.** Wymieniaj punkty na rabaty, przygody i inne nagrody | **1.** Zaregistrujte se **2.** Sbírejte body za nákupy **3.** Vyměňujte body za odměny, zážitky, slevy a spoustu dalšího | **1.** Zaregistrujte se **2.** Získavajte body za nákupy **3.** Uplatnite si body a získajte odmeny, rôzne zážitky, zľavy a ešte viac | **1.** Regisztrálj **2.** Szerezz pontokat minden vásárlással **3.** Váltsd be pontjaidat jutalmakra, élményekre, kedvezményekre és egyebekre | **1.** Înscric-te **2.** Câștigă puncte pentru achiziții **3.** Valorifică puncte pentru recompense, experiențe, reduceri și multe altele | **1.** Регистрируйте се **2.** Получайте точки за покупки **3.** Используйте точки за награды, услуги, отстъпки и т.н. | **1.** Reģistrējies **2.** Pelni punktus par pirkumiem **3.** Izmanto punktus, lai saņemtu balvas, izklaides iespējas, atlaides un daudz ko citu | **1.** Registreeru **2.** Teeni ostude eest punkte **3.** Lunasta punktide eest preemiad, elamused, allahindlused ja muu | **1.** Užsiregistruokite **2.** Pelnykite taškų už pirkinius **3.** Panaudokite taškus atlygiui, funkcijoms, nuolaidoms ir ne tik





姫路城

LE CHÂTEAU D'HIMEJI / LE CHÂTEAU DU HÉRON BLANC

🏰 Dominant majestueusement la ville japonaise d'Himeji, le superbe château d'Himeji est un joyau architectural inscrit au patrimoine mondial de l'UNESCO. Tout a commencé en 1333. Alors que le Japon est secoué par de nombreuses guerres civiles, une forteresse est érigée. Le château subira ensuite plusieurs transformations au cours des siècles. En 1600, une reconstruction majeure commence, aboutissant à la structure actuelle qui a été préservée dans son intégrité jusqu'à aujourd'hui, d'abord par les maîtres féodaux, puis par le gouvernement japonais. Son labyrinthe de passages, autrefois conçu pour confondre et piéger les ennemis, entraîne les visiteurs dans un voyage troublant. Échappant aux guerres, aux tremblements de terre et aux incendies, le château du Héron blanc continue de se dresser là, comme un vibrant hommage à la culture japonaise. Découvrez les détails complexes du donjon principal et l'histoire du château au fur et à mesure de la construction.

CHRIS MCVEIGH
Senior Designer LEGO®

HOMMAGE À UN MONUMENT EMBLÉMATIQUE

🍷 « 2023 marque le 30^e anniversaire de l'inscription du château d'Himeji sur la liste du patrimoine mondial de l'UNESCO, mais le mystère de l'architecture et de l'histoire du monument reste entier. Nous avons conçu le château de telle manière que le donjon principal soit l'élément central du modèle, en jouant sur les proportions et les dimensions. Si vous avez visité le château, vous reconnaîtrez peut-être certains détails intérieurs, et si vous ne l'avez jamais vu, nous espérons que ce modèle stimulera votre imagination et votre curiosité. »





Empruntez les chemins, passerelles et escaliers complexes du château.



UNE ILLUSION D'OPTIQUE

🌸 La toiture du château d'Himeji est composée de tuiles rectangulaires et semi-circulaires imbriquées de couleur noire. Plusieurs couches d'argile blanche viennent souligner les tuiles, ce qui apporte à la toiture un aspect contrasté, semblable à un maillage, lorsqu'on la regarde de près. Cependant, à distance, le maillage semble gris. Les tuiles de ce set arborent la couleur *Dark Stone Grey* (Gris pierre foncé), qui évoque l'aspect vieilli des tuiles.



Jetez un œil à l'intérieur après avoir construit le modèle.



Chaque tour est construite différemment - même au sommet.

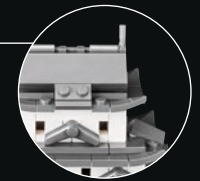

De loin, le maillage de tuiles noires et d'argile blanche donne l'impression que le toit est gris.

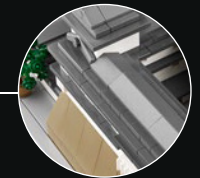

Chaque étage du donjon principal évoque la structure réelle du château.



Les angles irréguliers sont prédominants dans tout le château et sur les murs.



Ornez les cerisiers de fleurs roses ou de feuilles vertes.

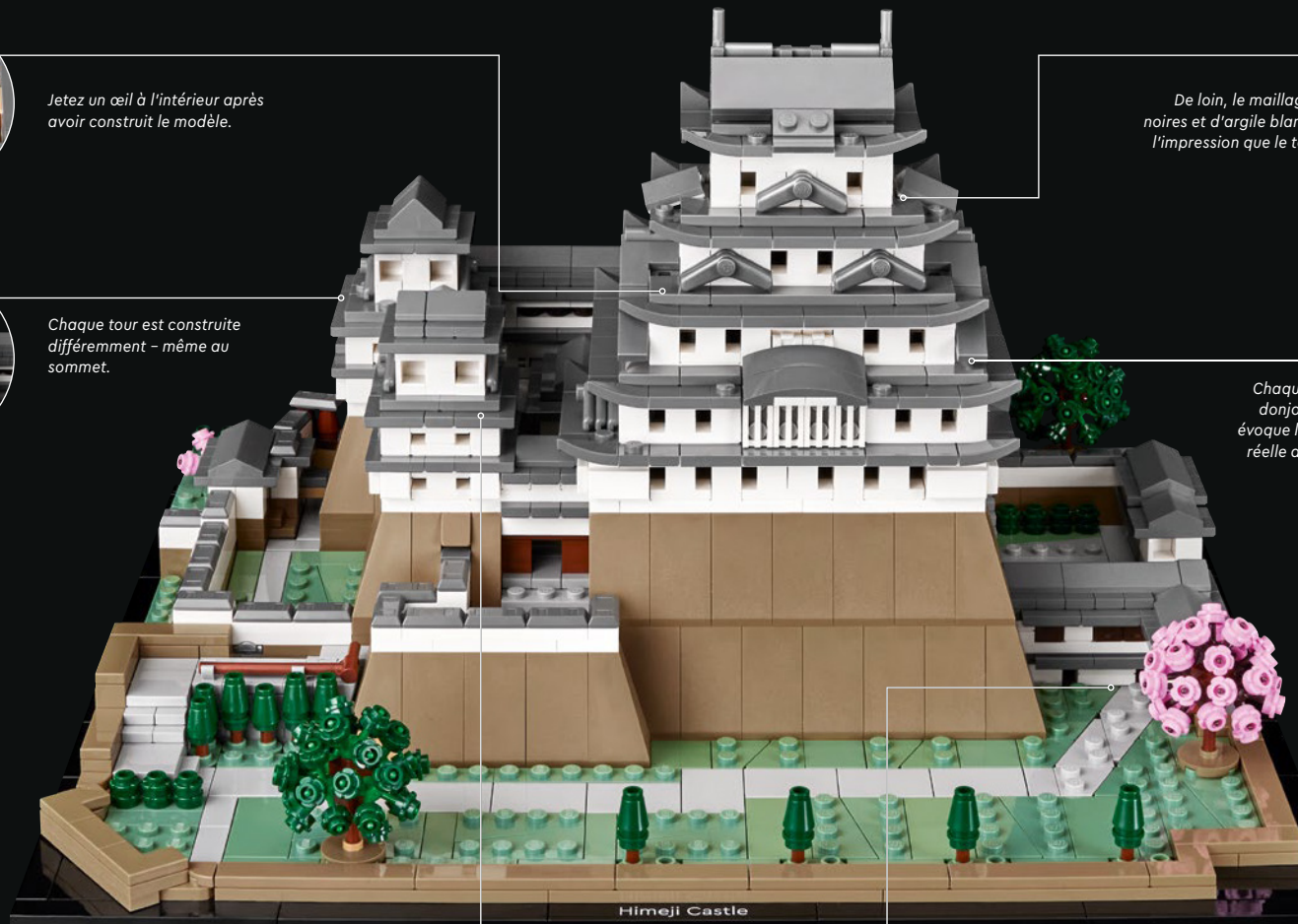

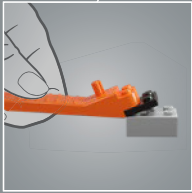
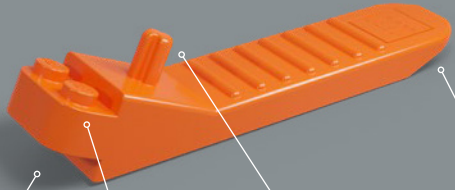

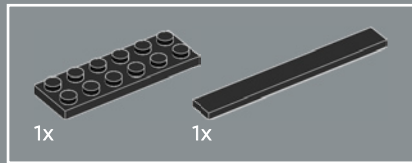

1

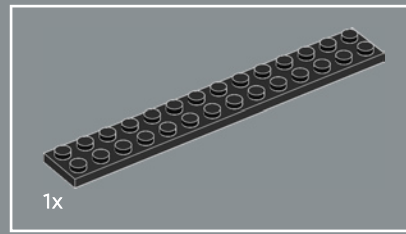
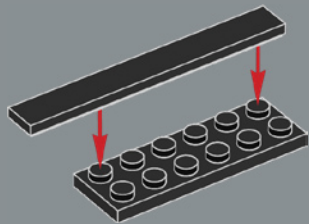

2

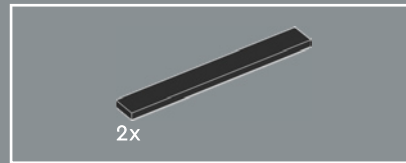
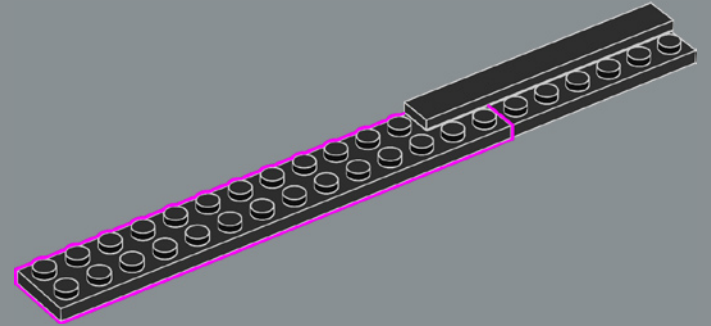

3

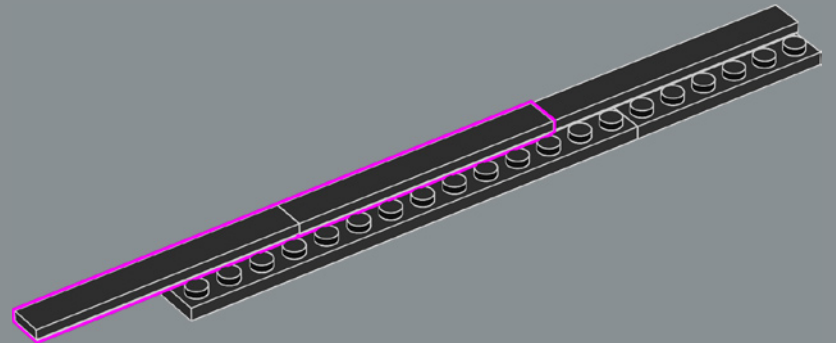

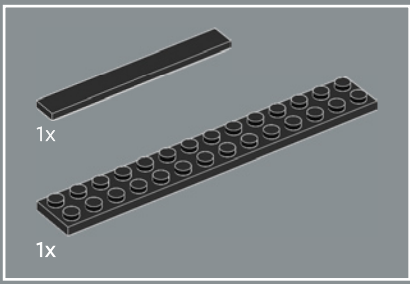

4

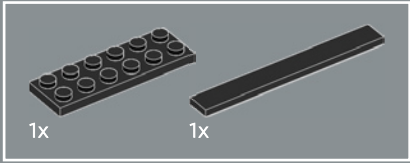
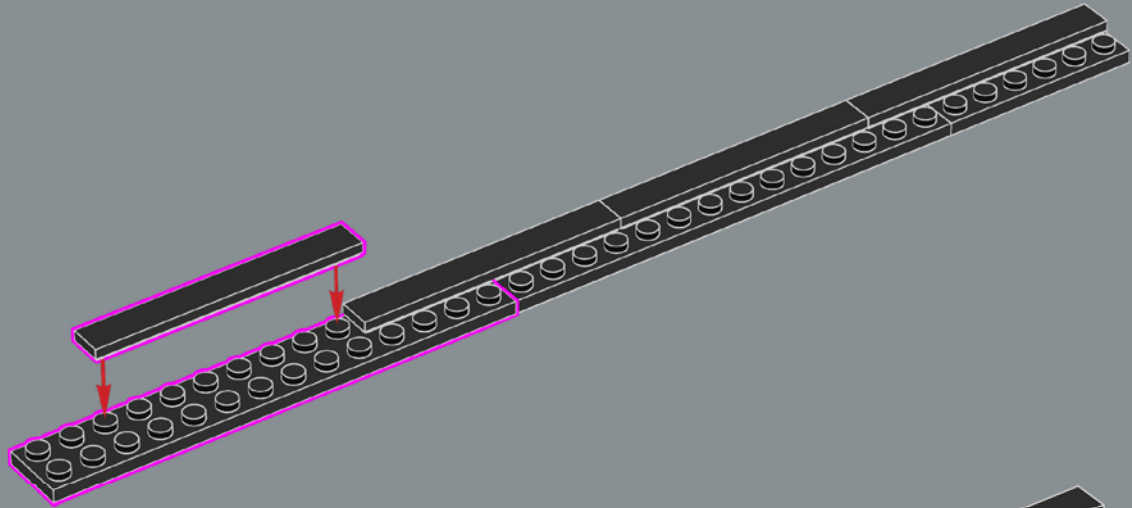

5

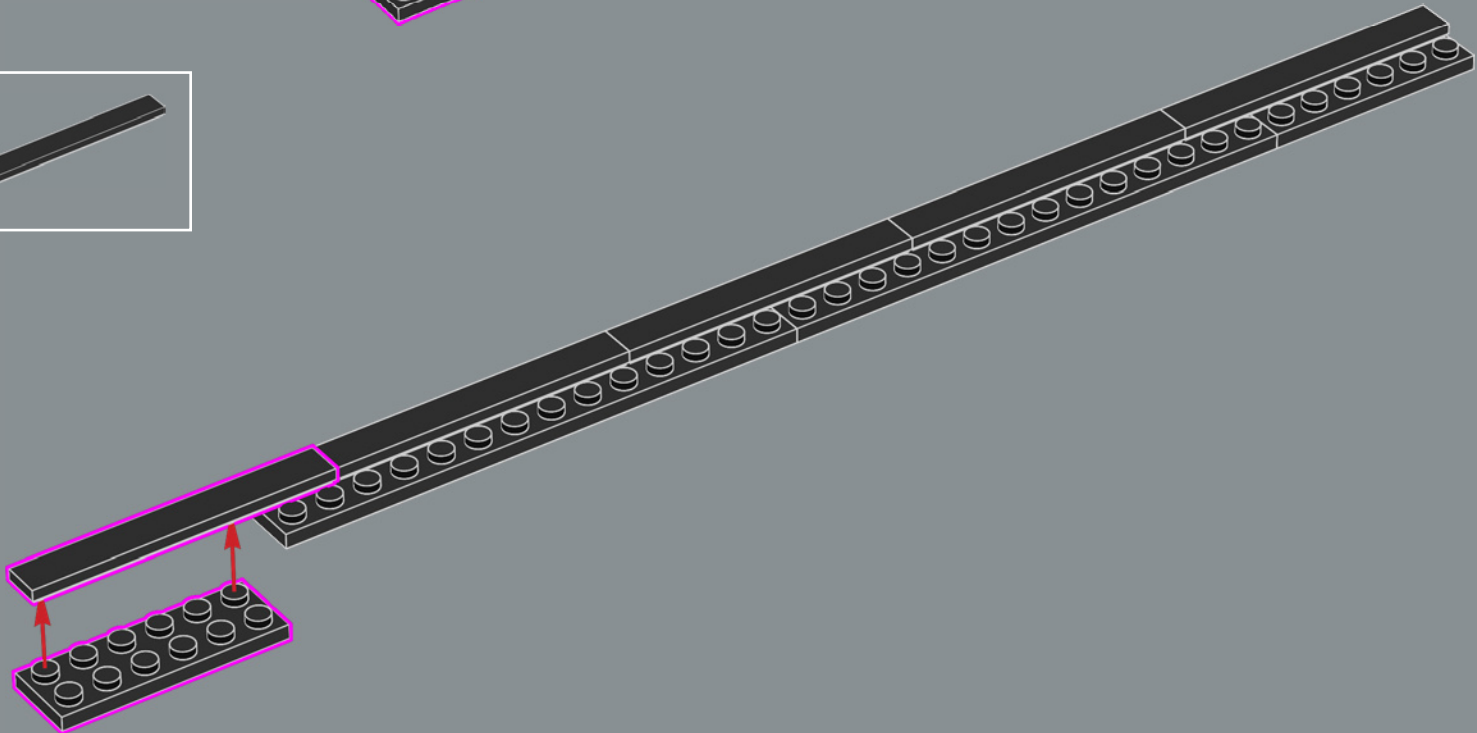

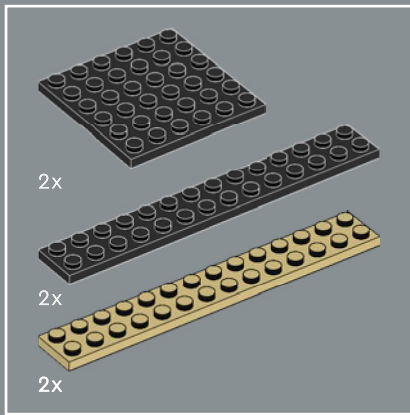

6

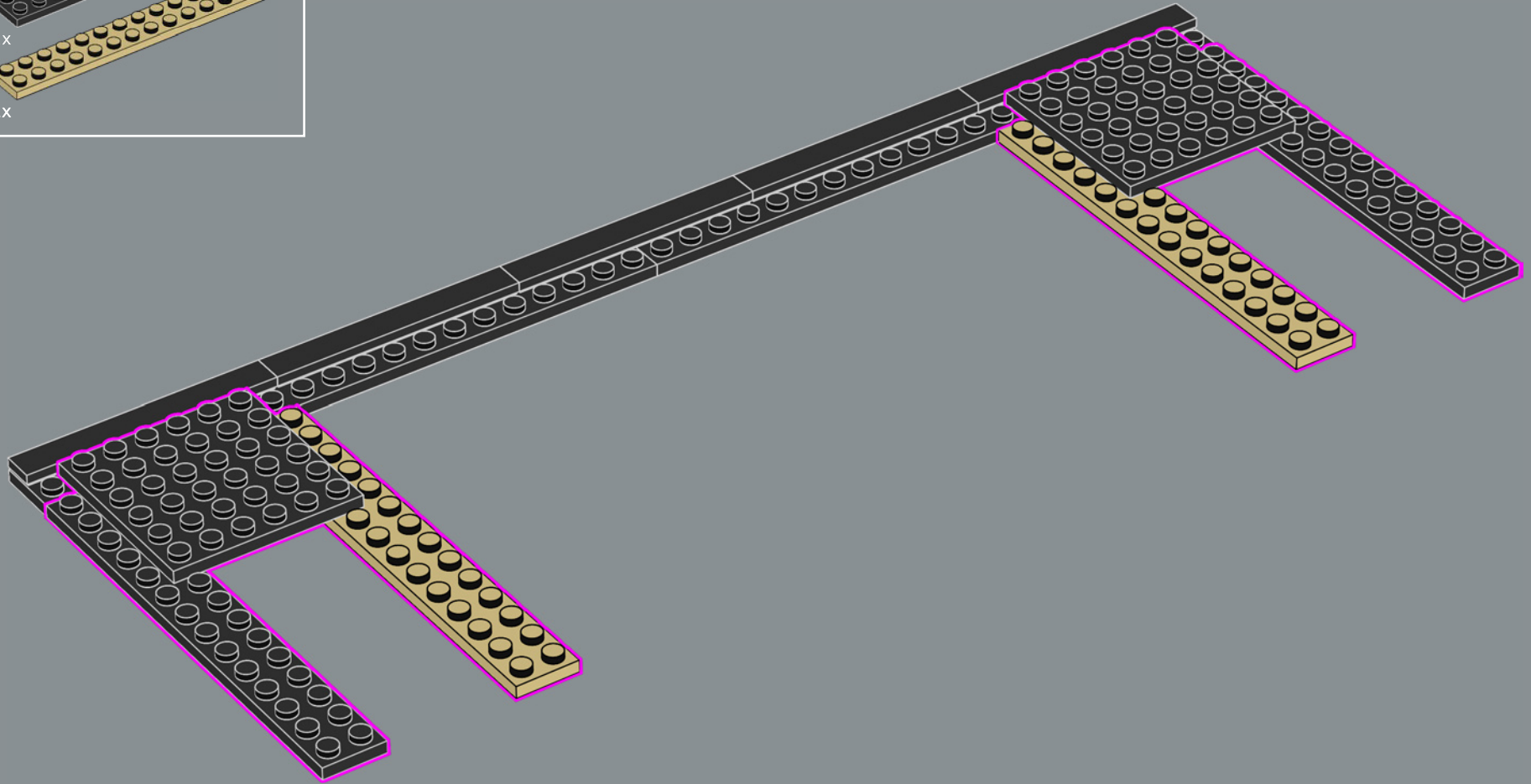

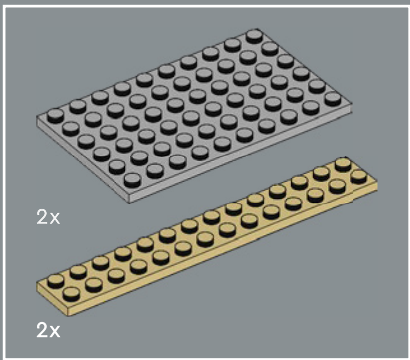

7

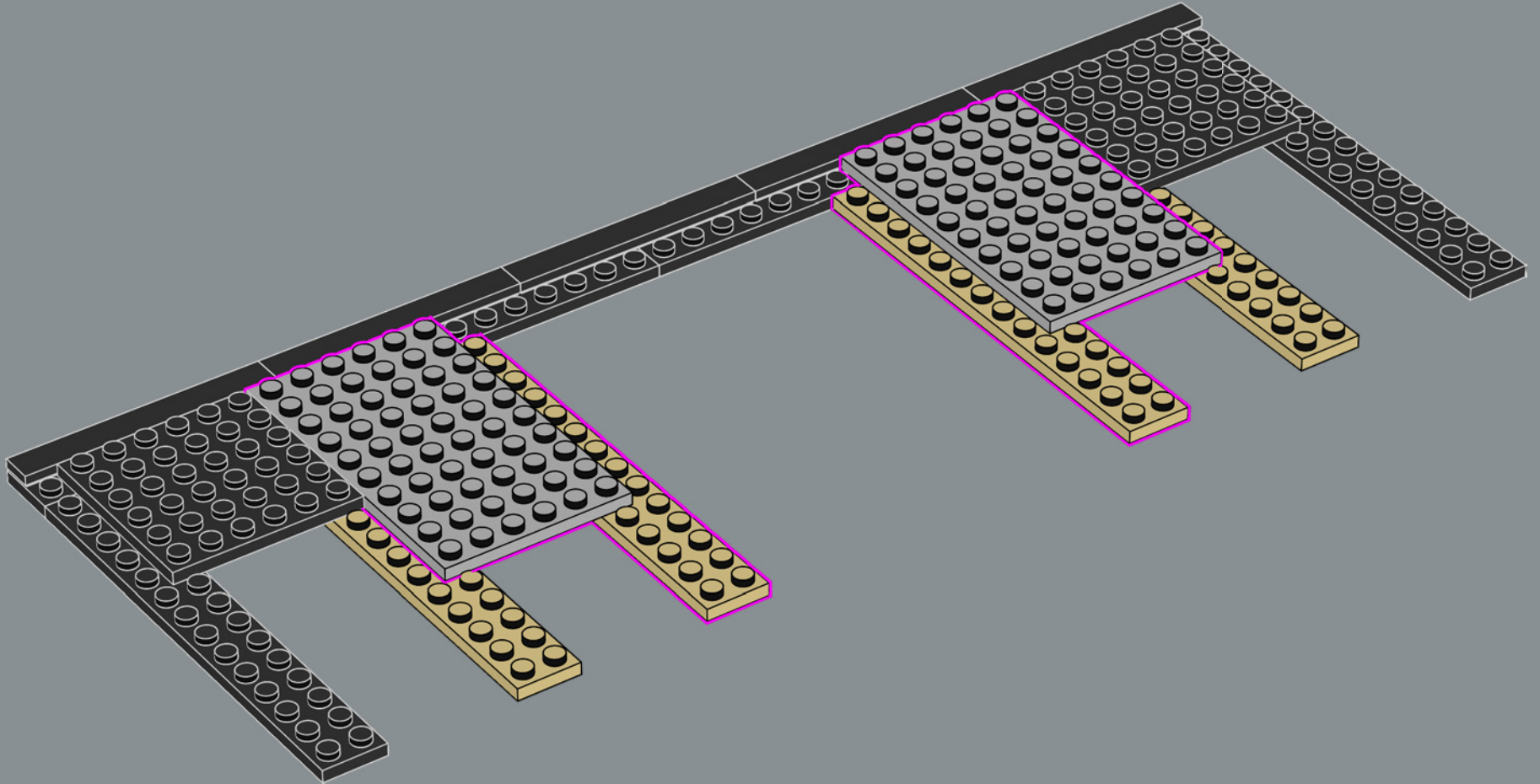

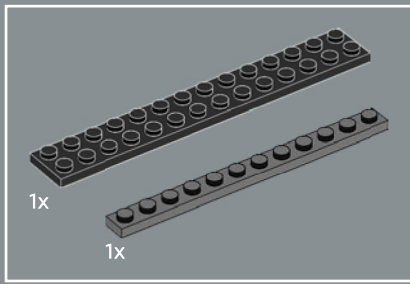

8

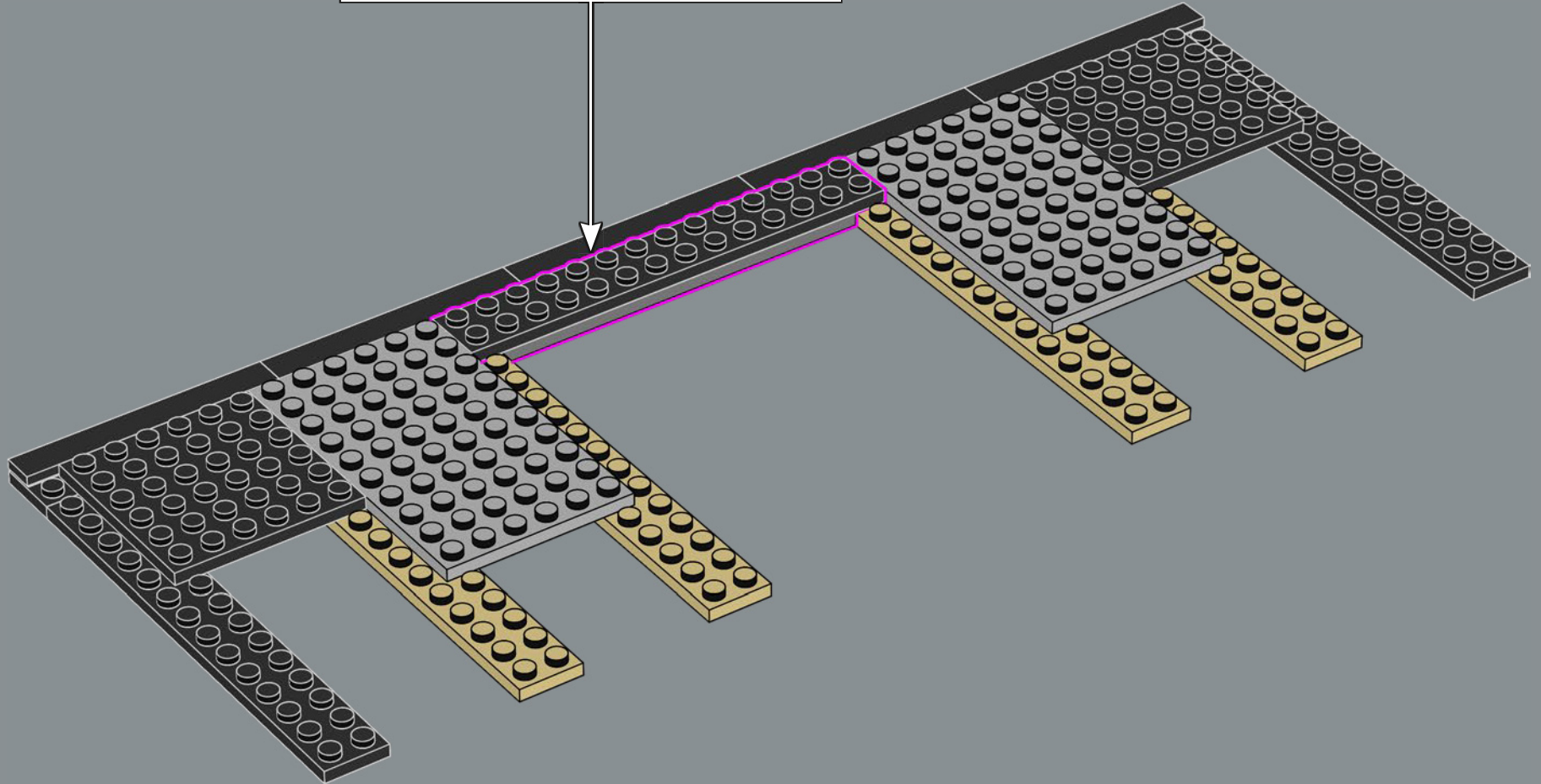
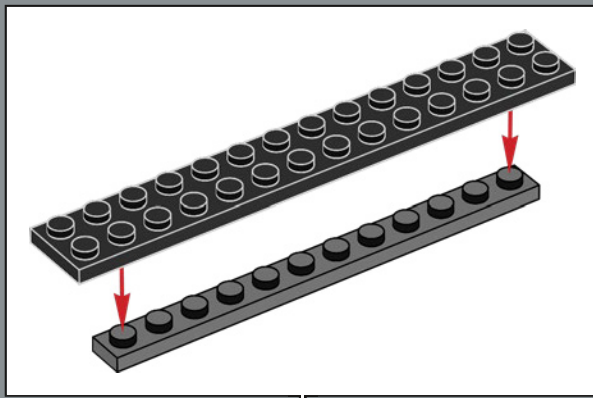

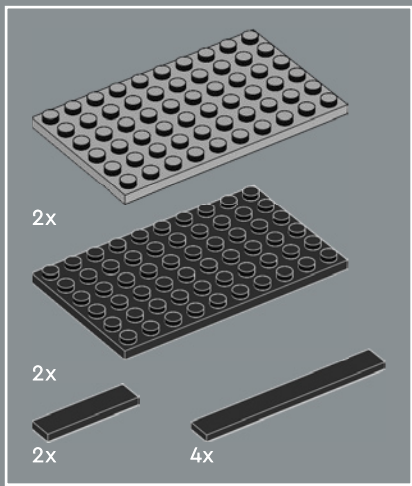

9

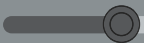
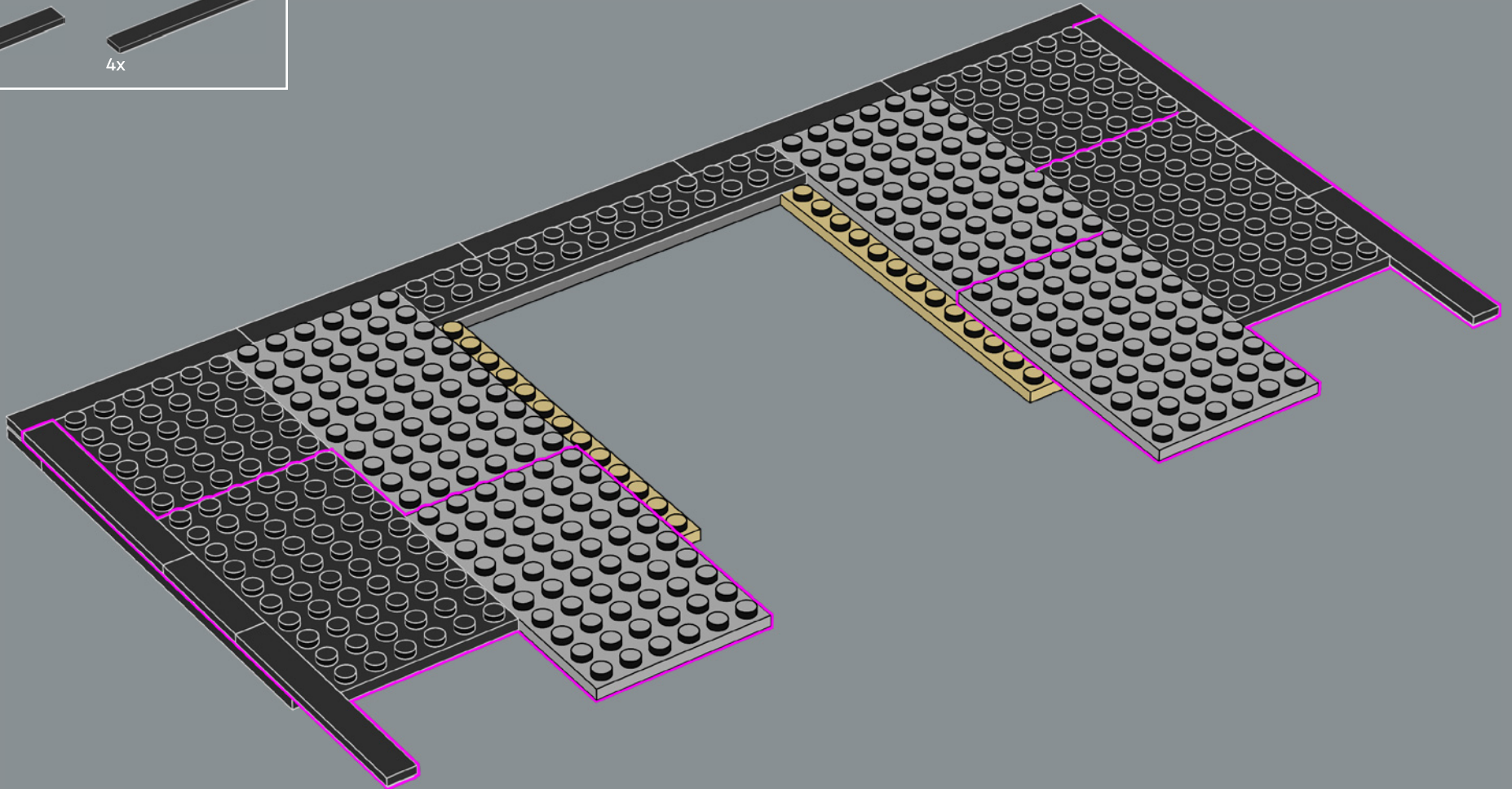

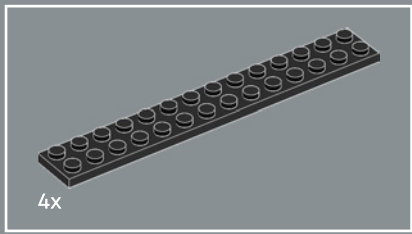

10

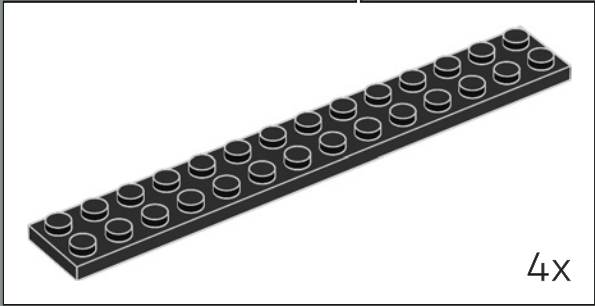
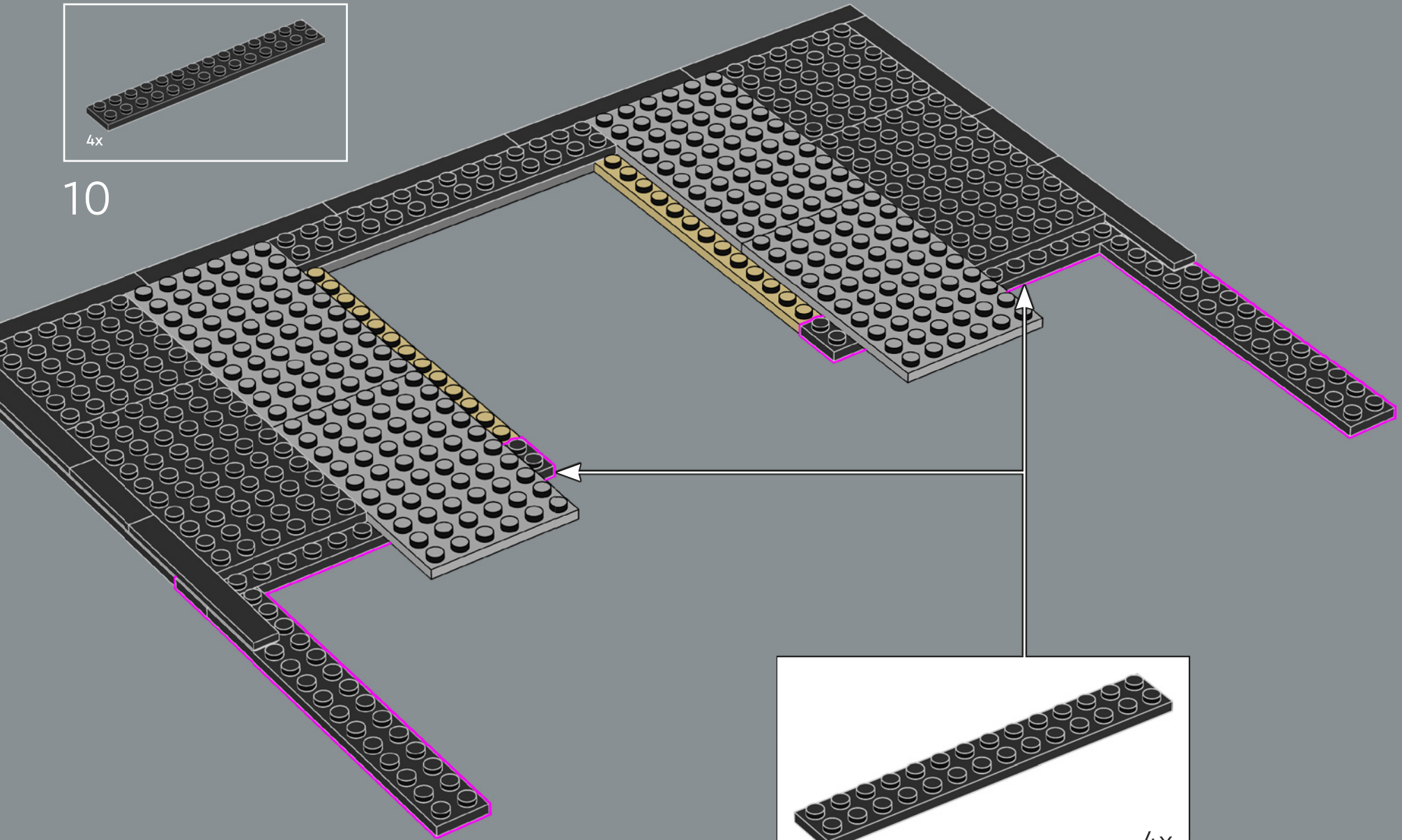

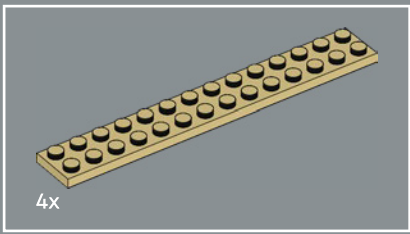

11

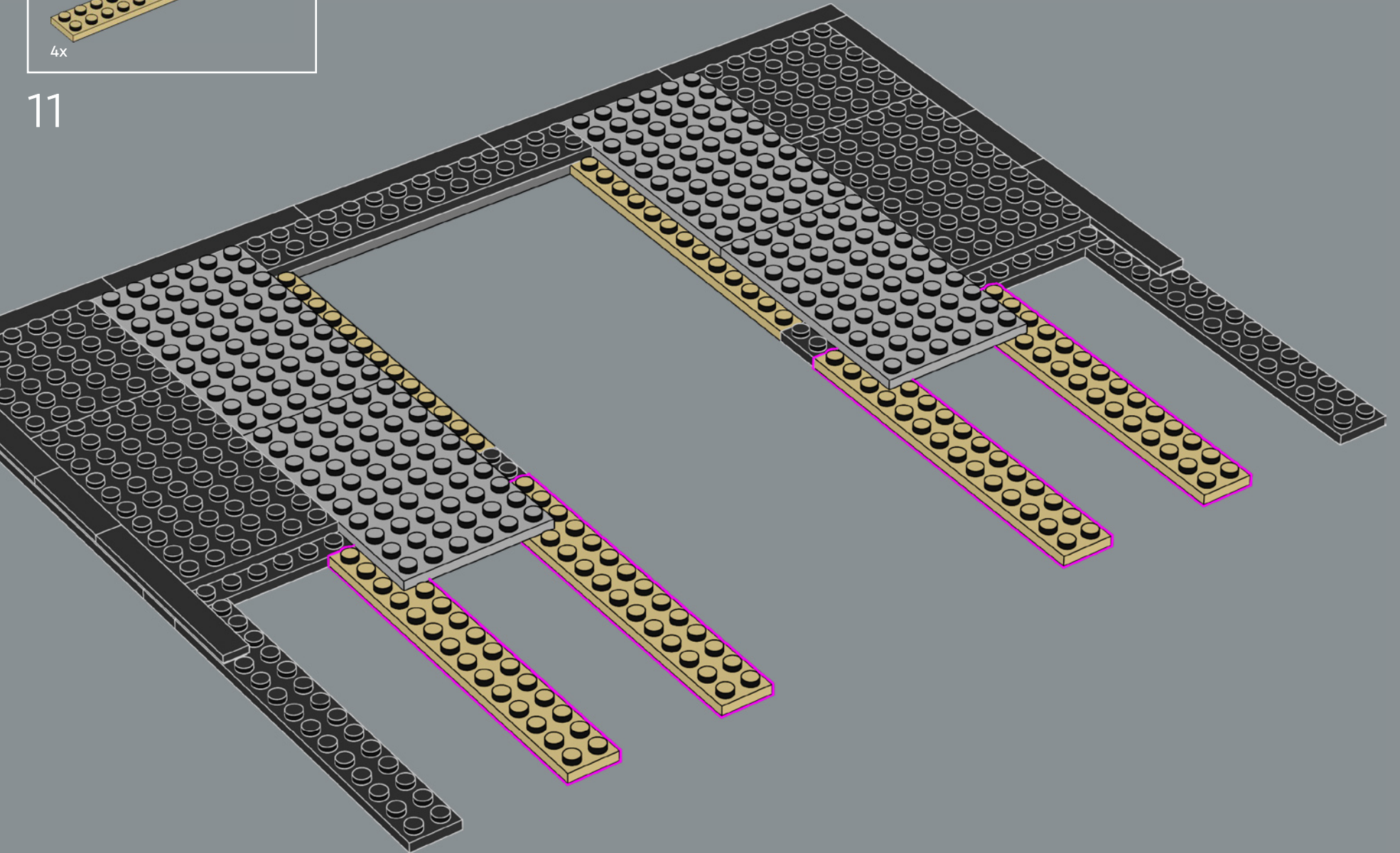

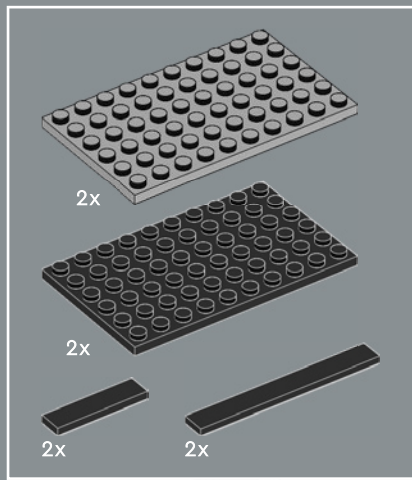

12

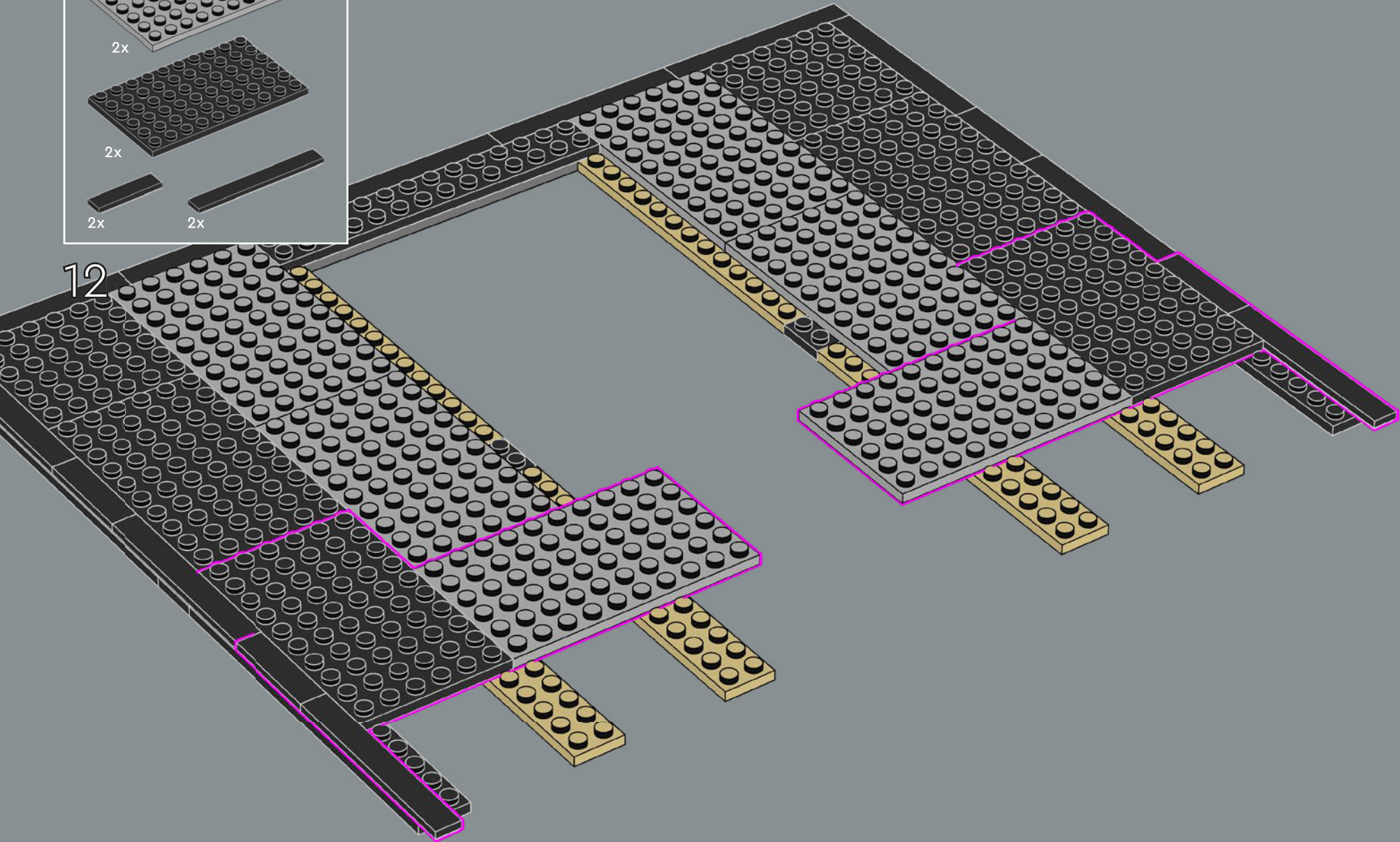

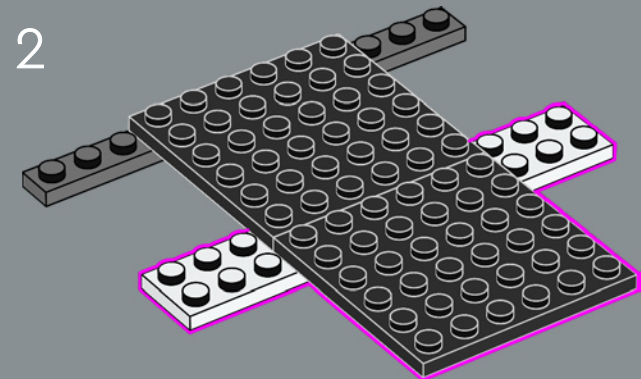
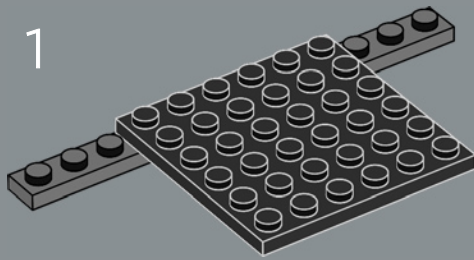
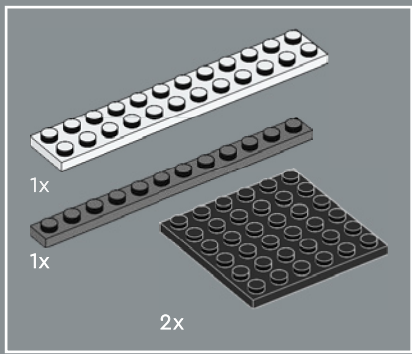

13

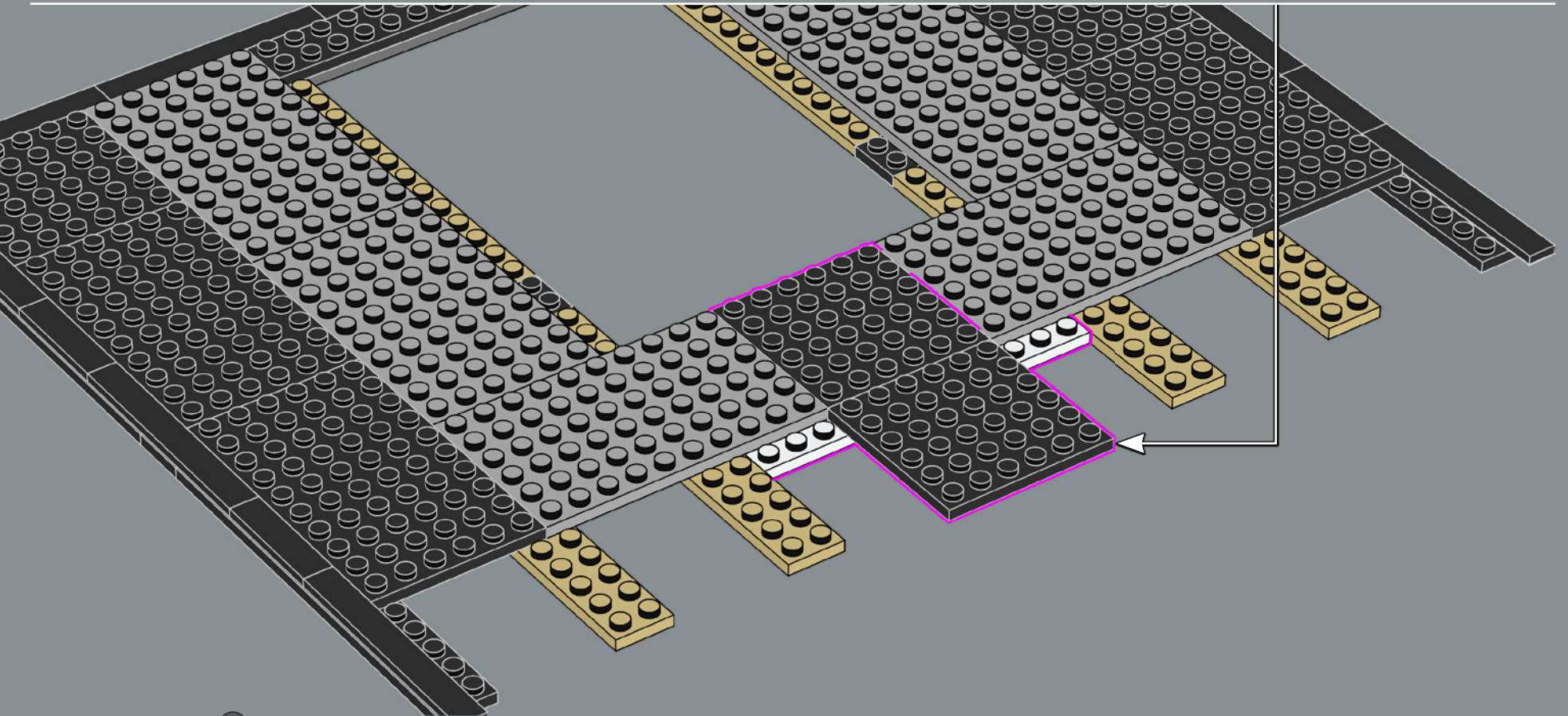

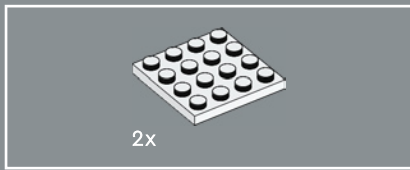

14

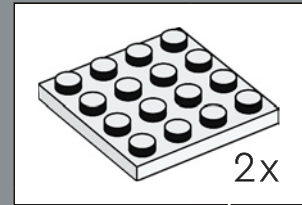
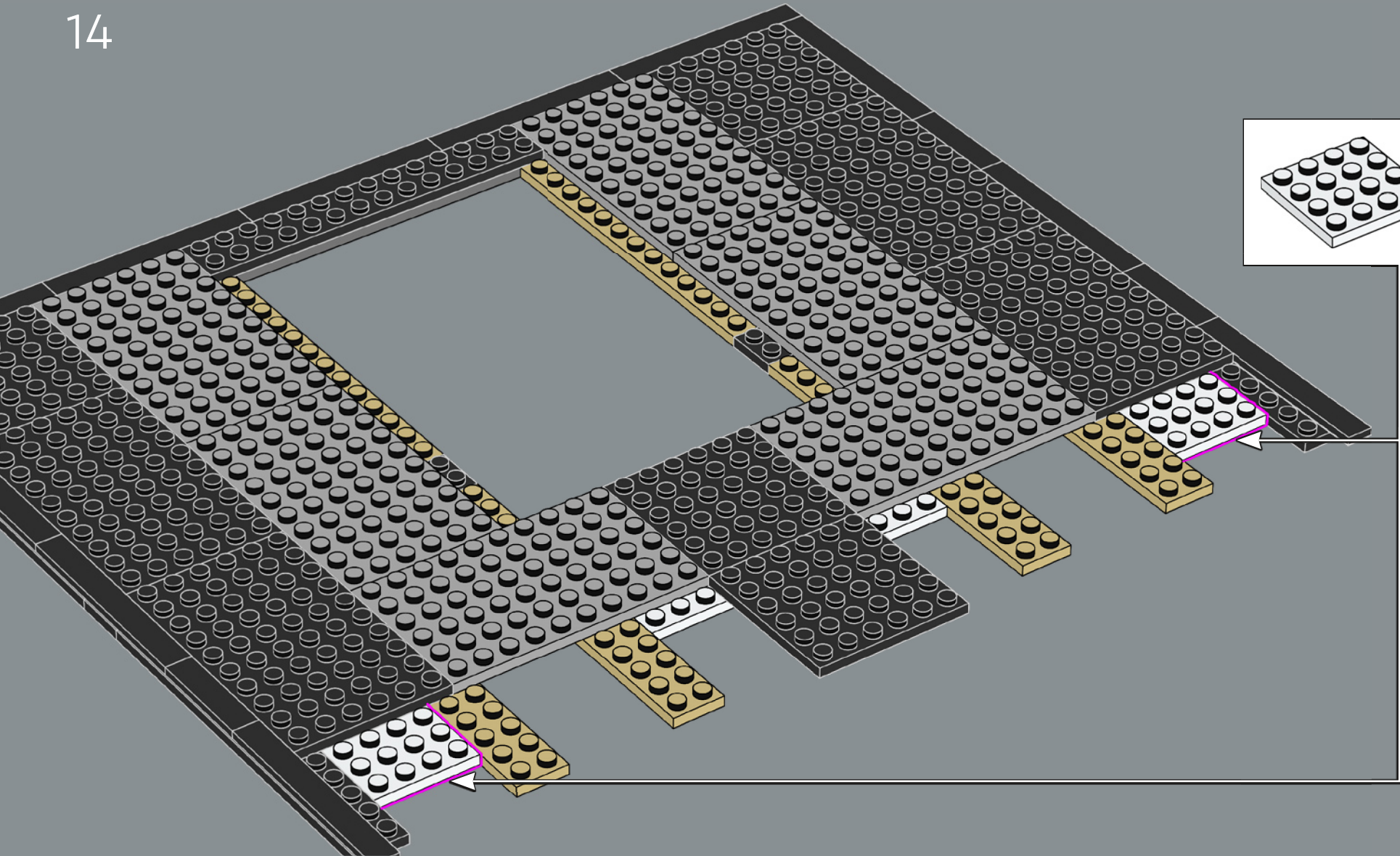

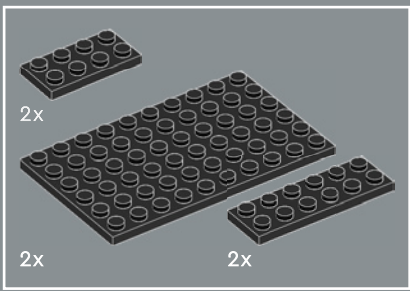

15

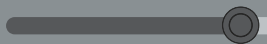
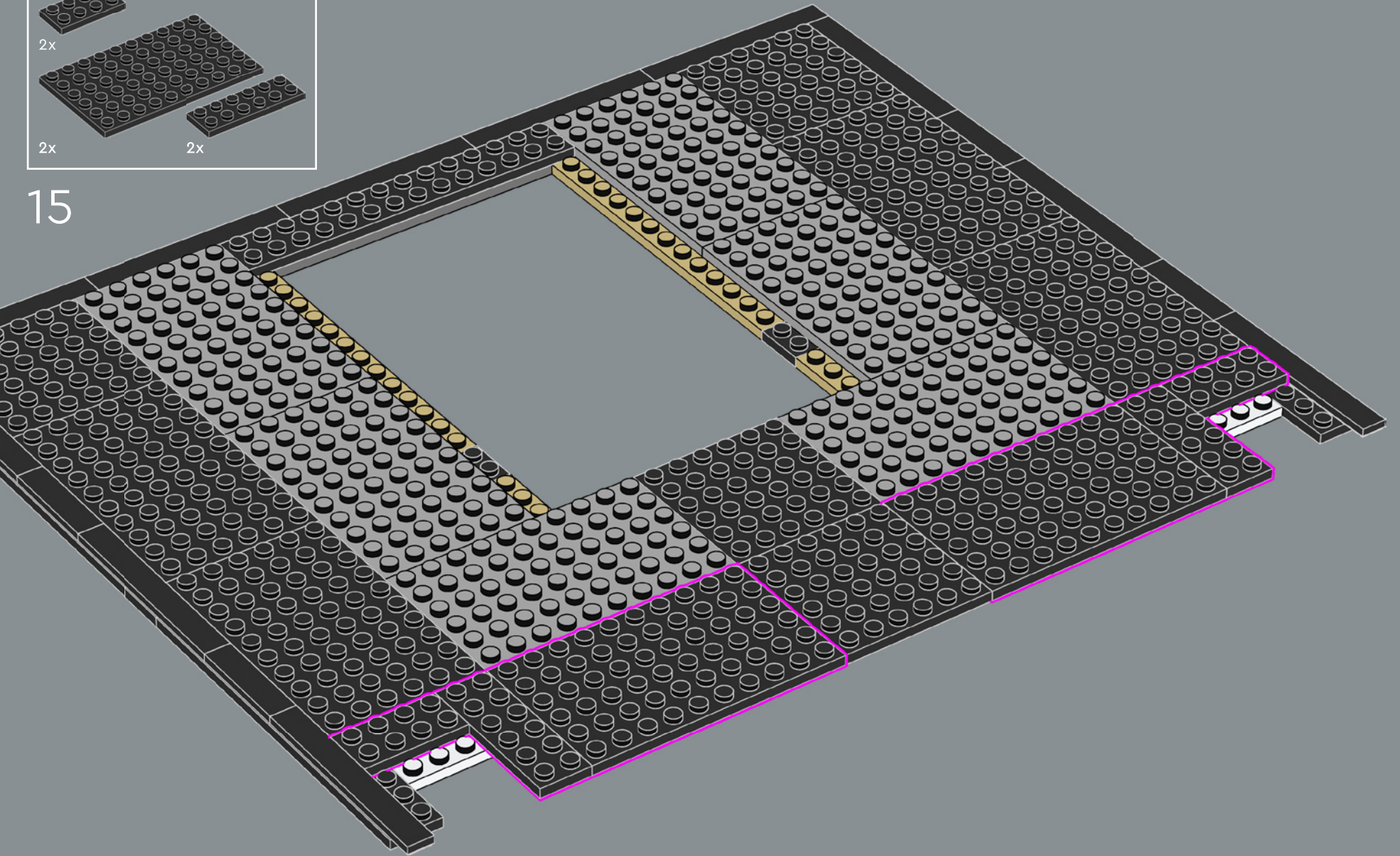

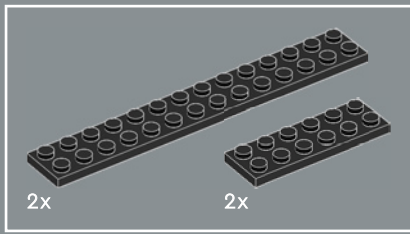

16

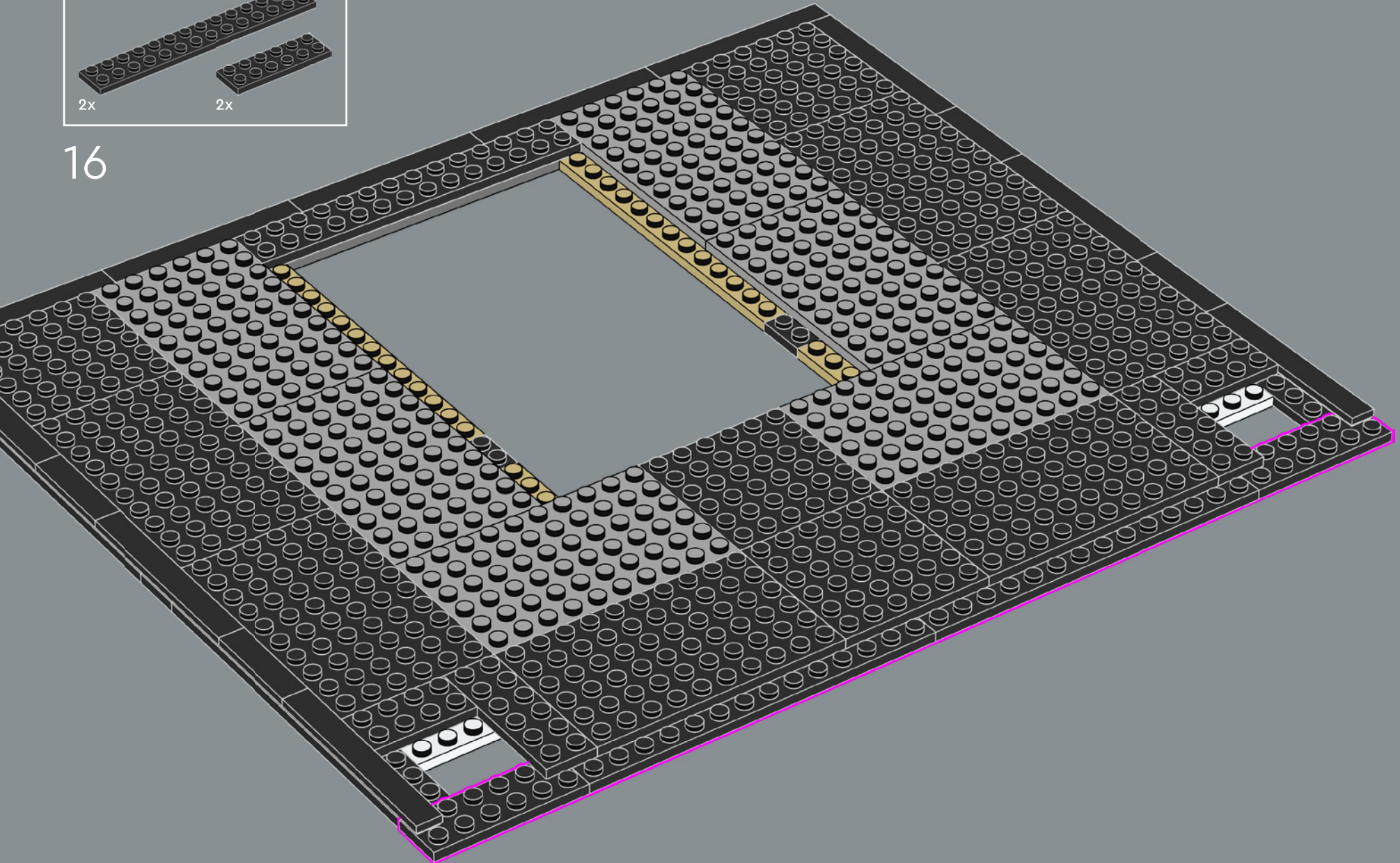

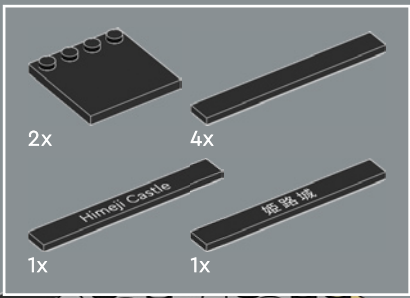

17

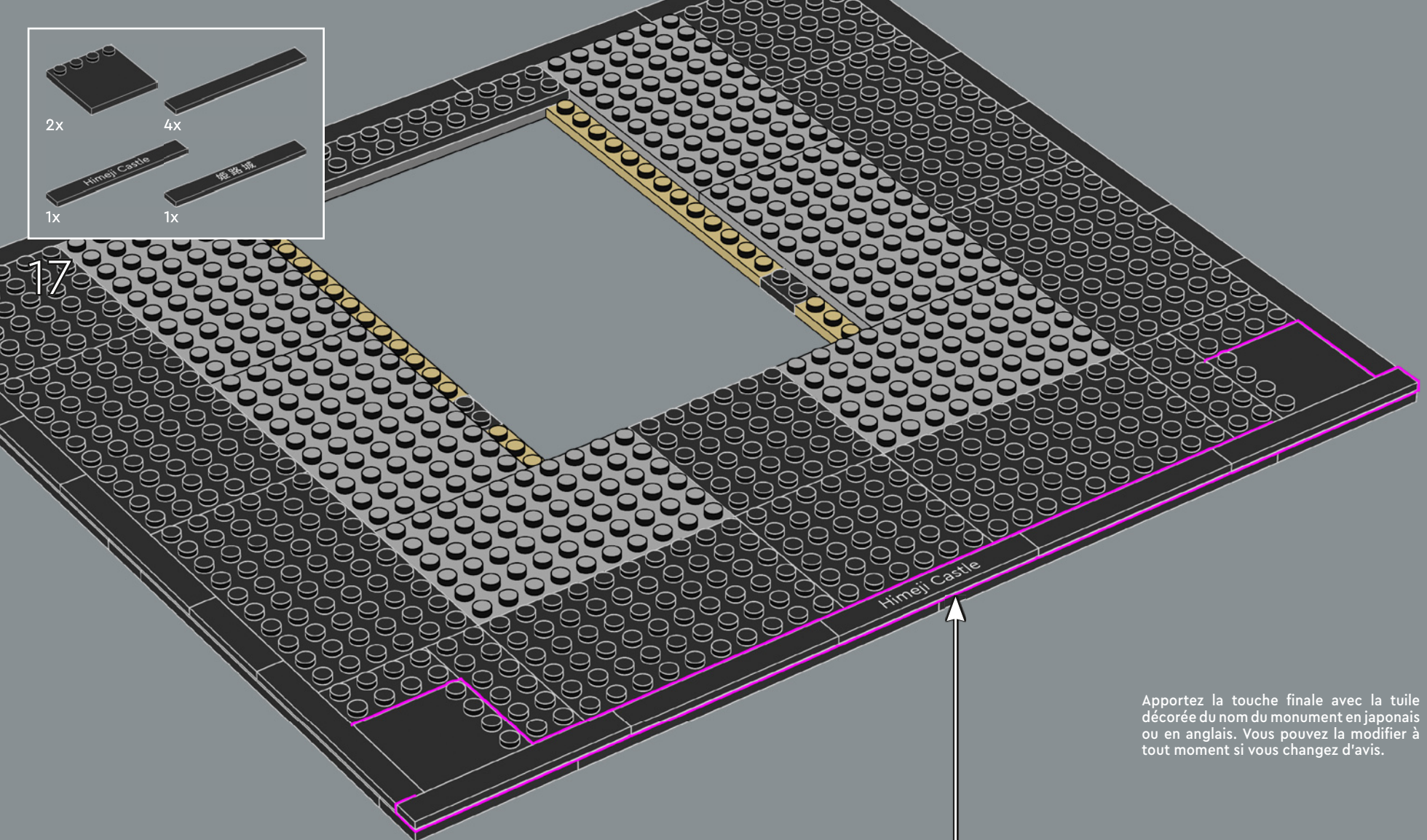

Apportez la touche finale avec la tuile décorée du nom du monument en japonais ou en anglais. Vous pouvez la modifier à tout moment si vous changez d'avis.

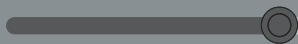
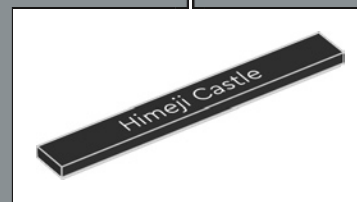

Depuis 1993, le château d'Himeji est inscrit au patrimoine mondial de l'UNESCO : c'est un hommage à la majesté mais aussi à l'architecture en bois de ce château japonais.

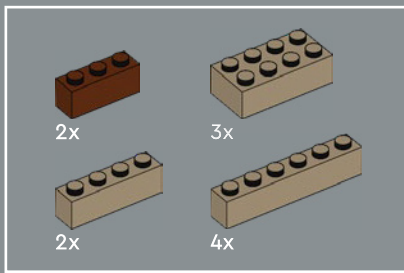

18

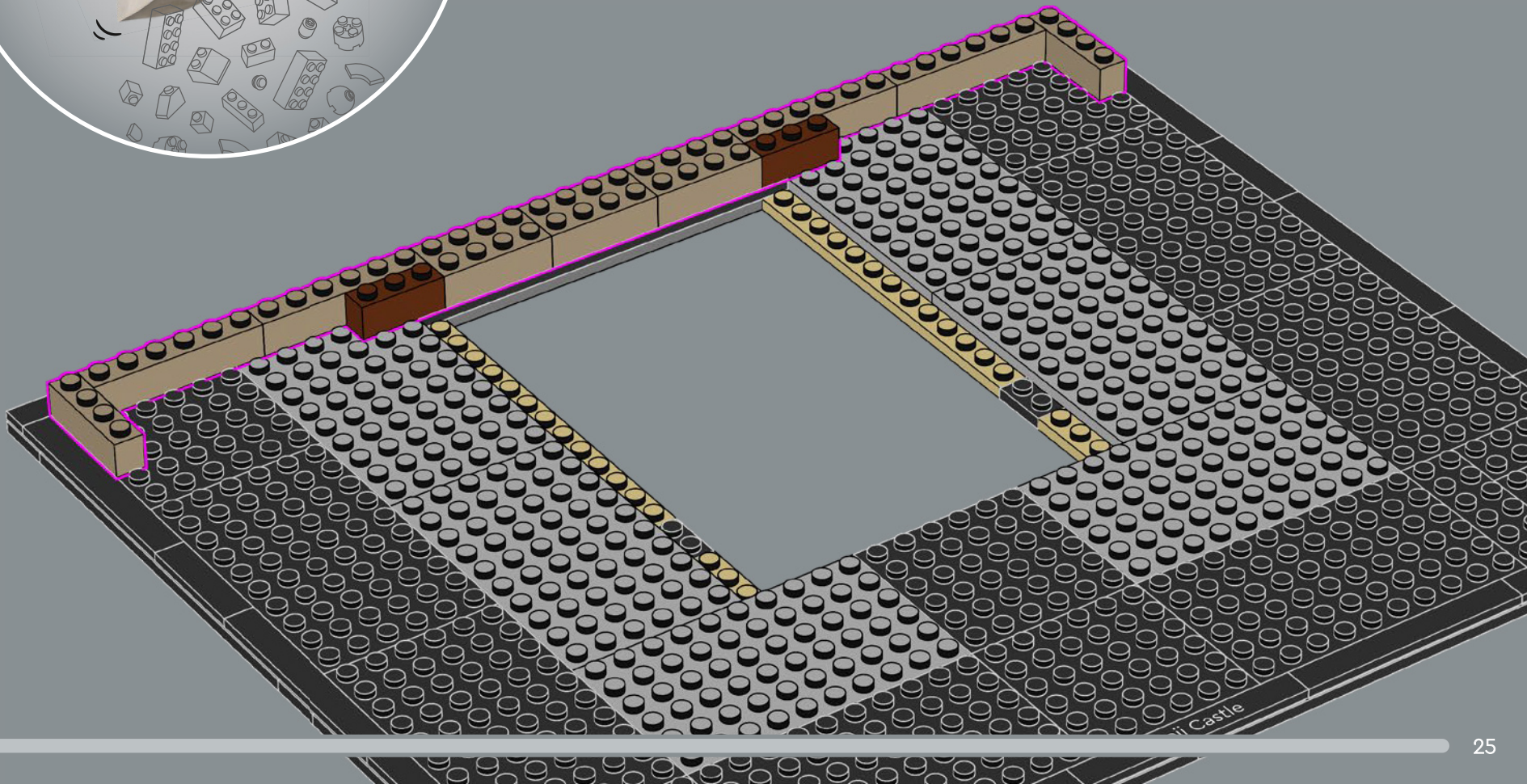

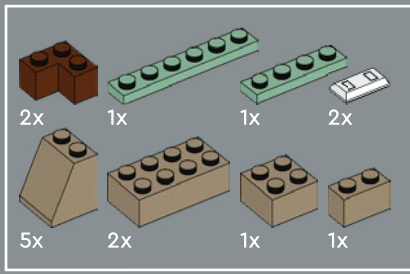

20

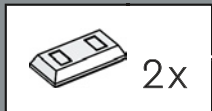
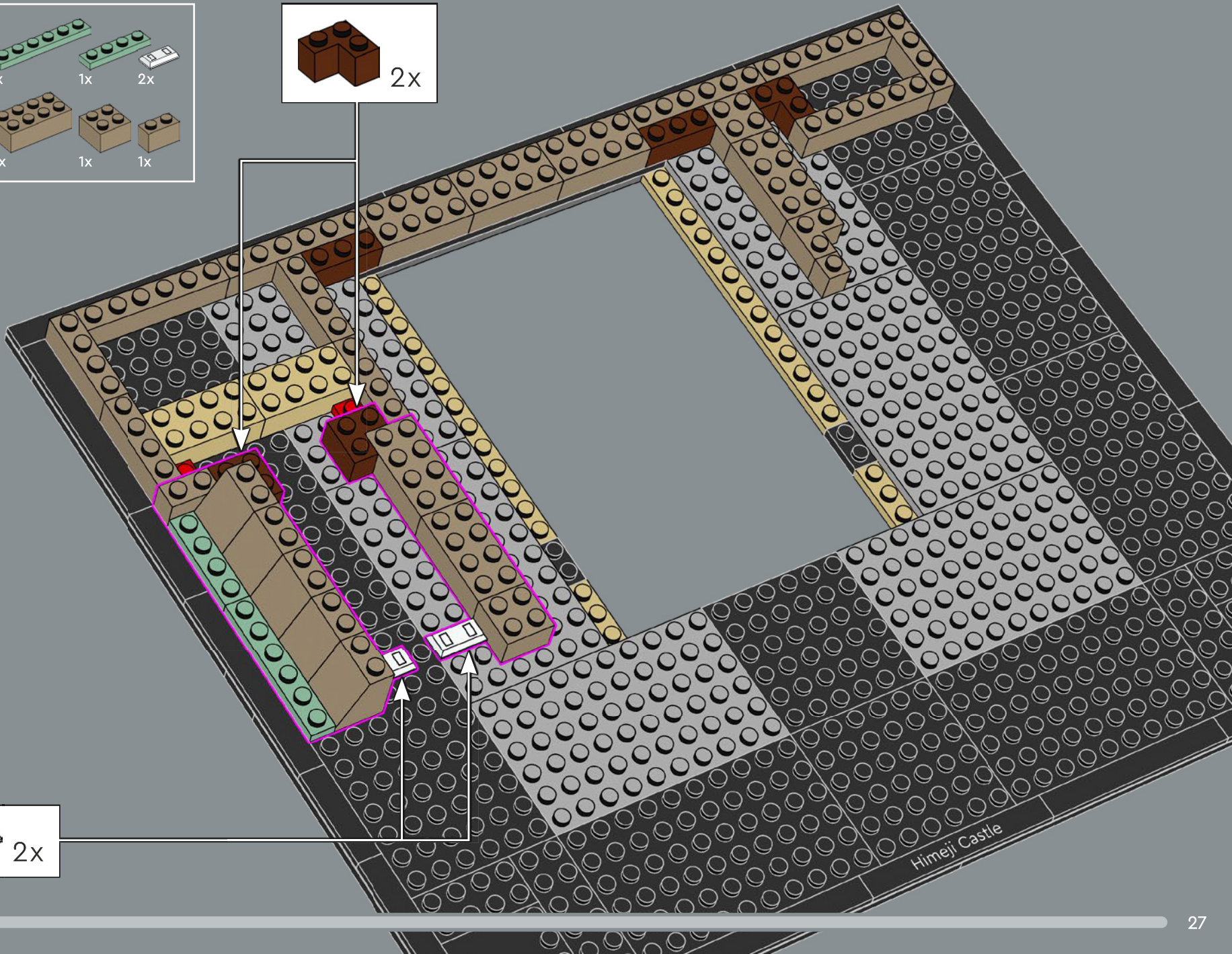

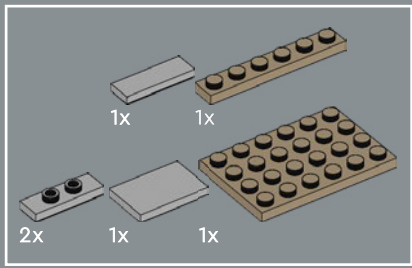



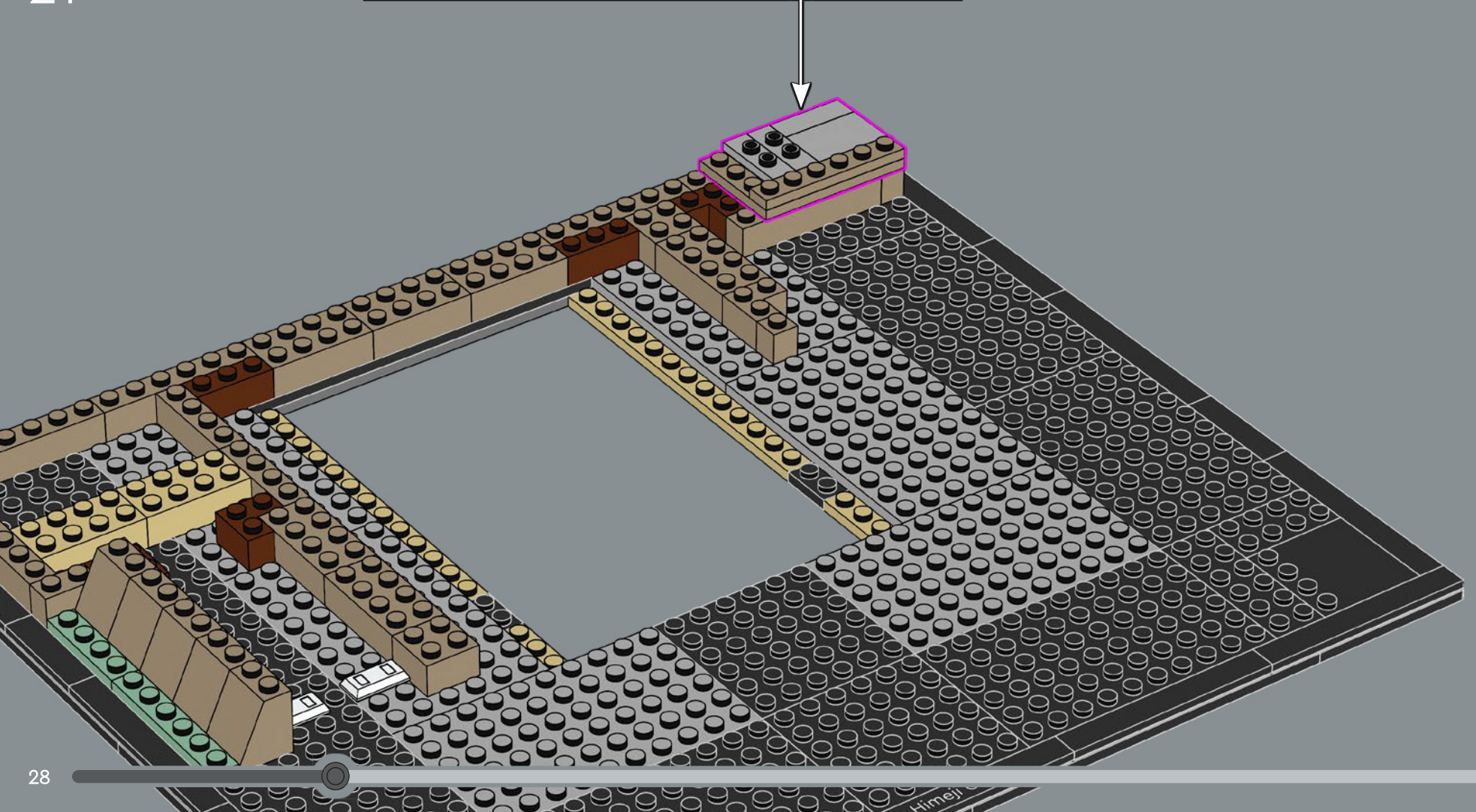
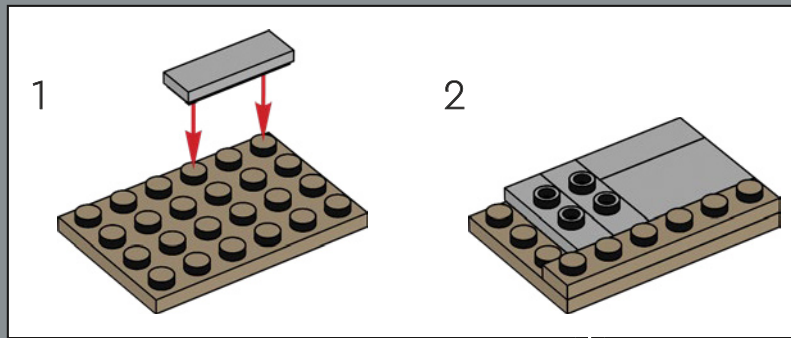

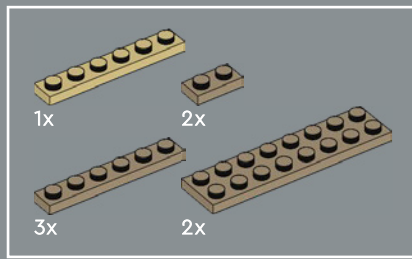

21

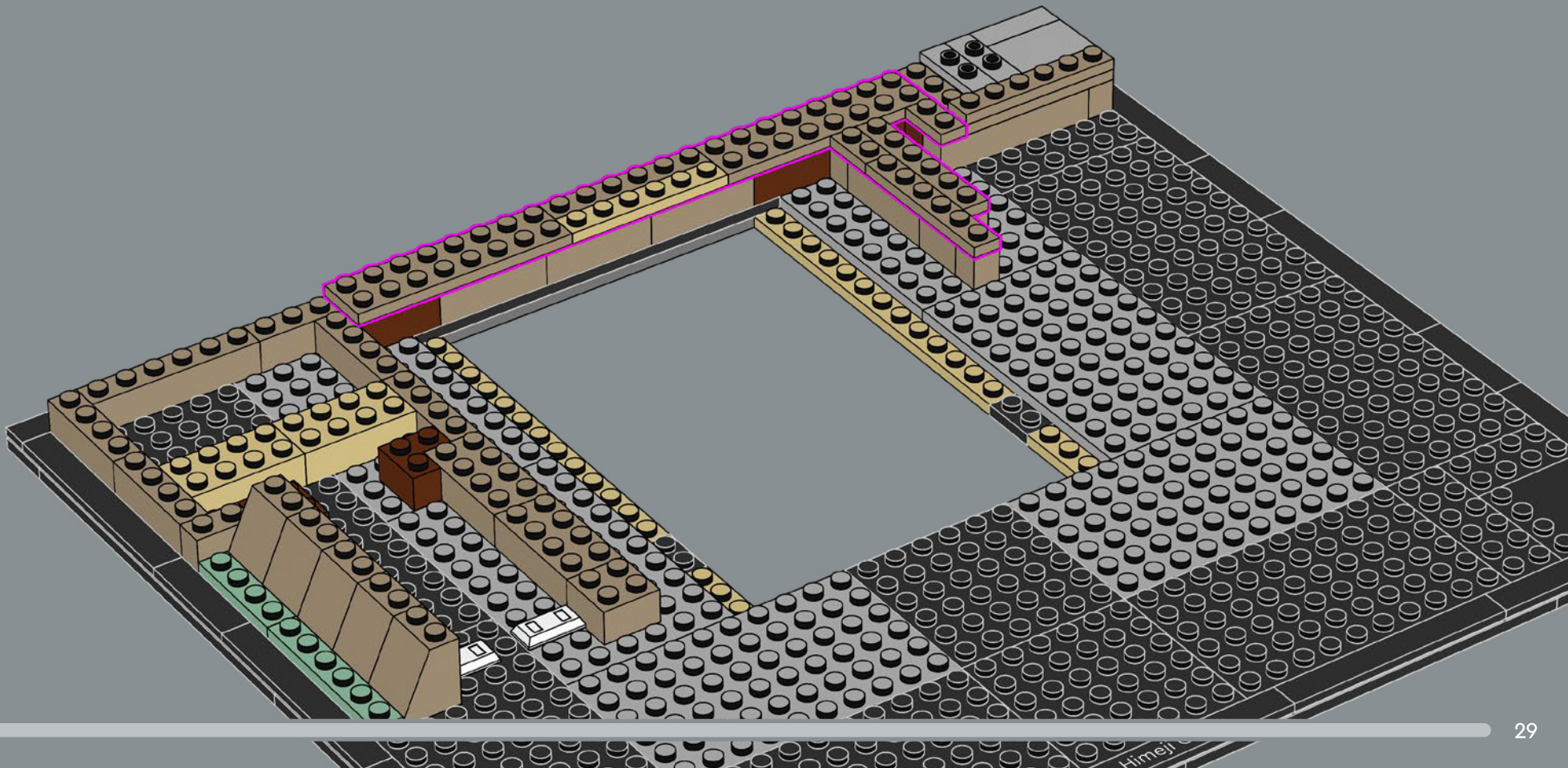



22



- 1x 
- 1x 
- 2x 
- 2x 
- 1x 

23

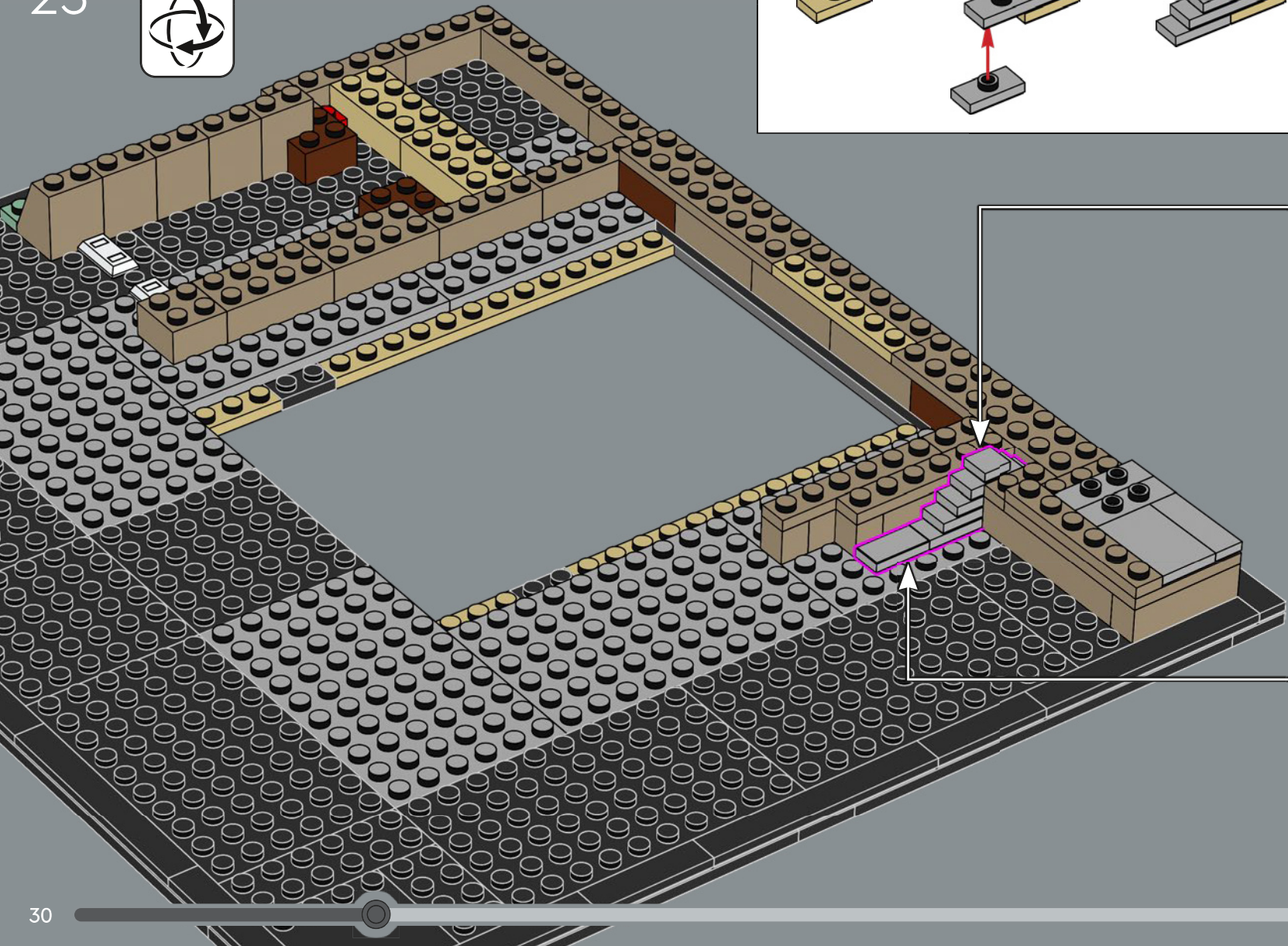
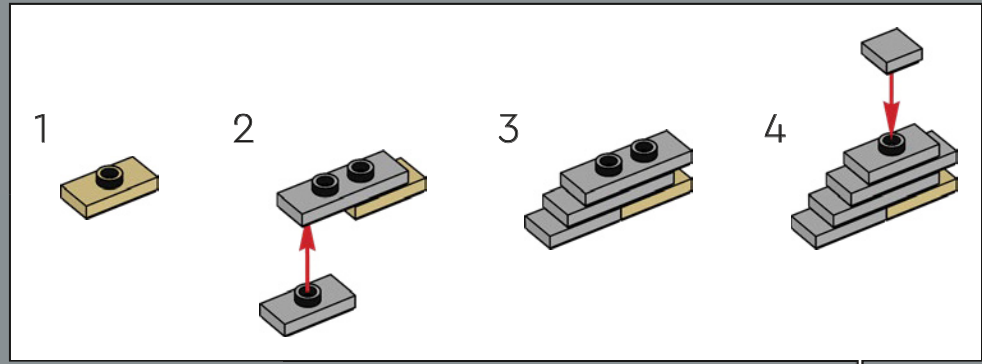

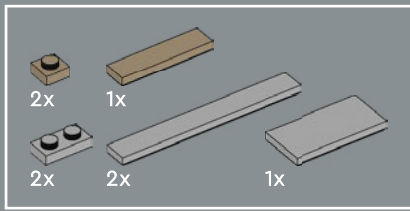

24

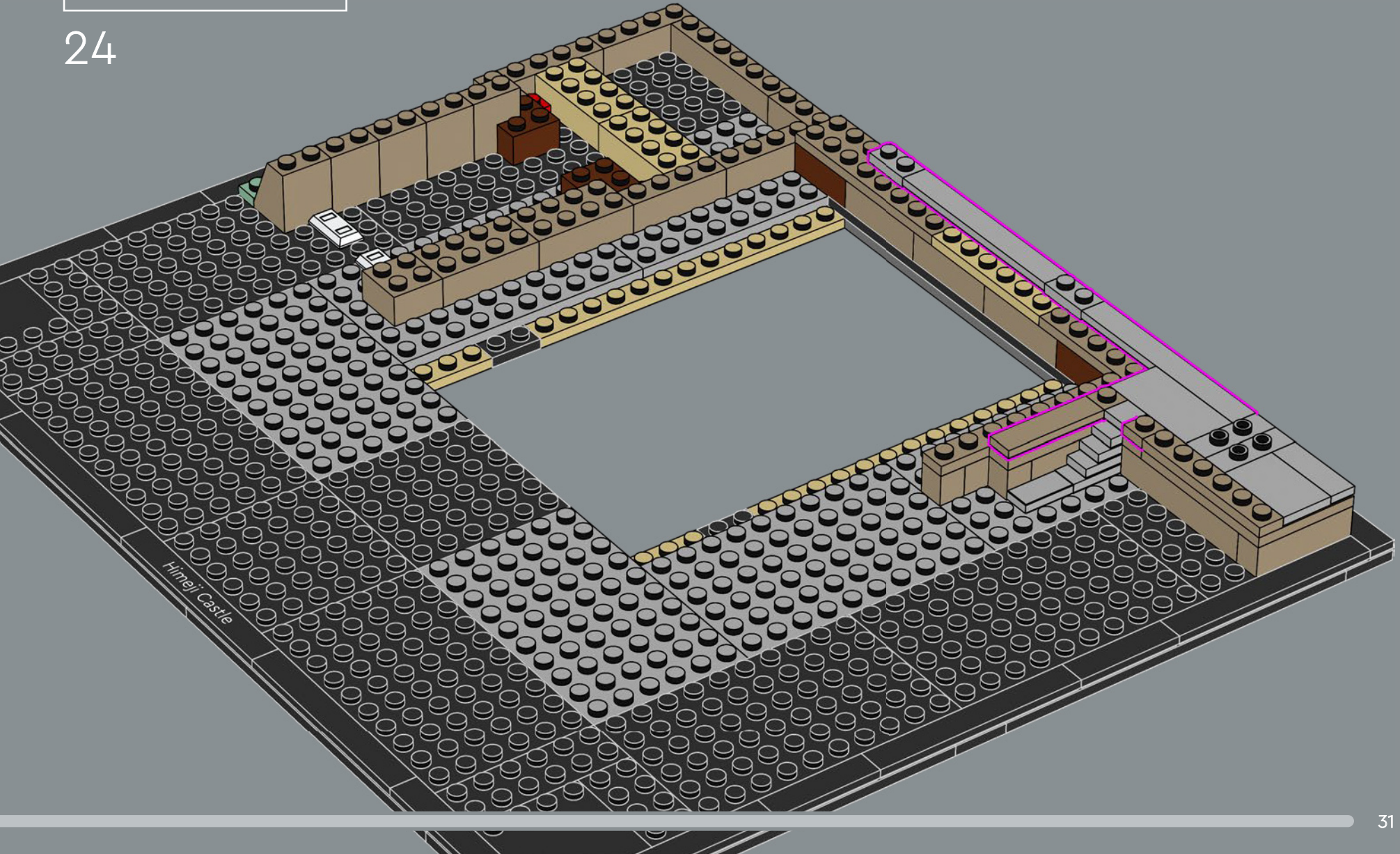

1x  4x  1x 

25

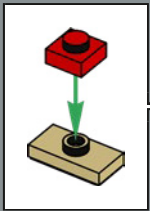
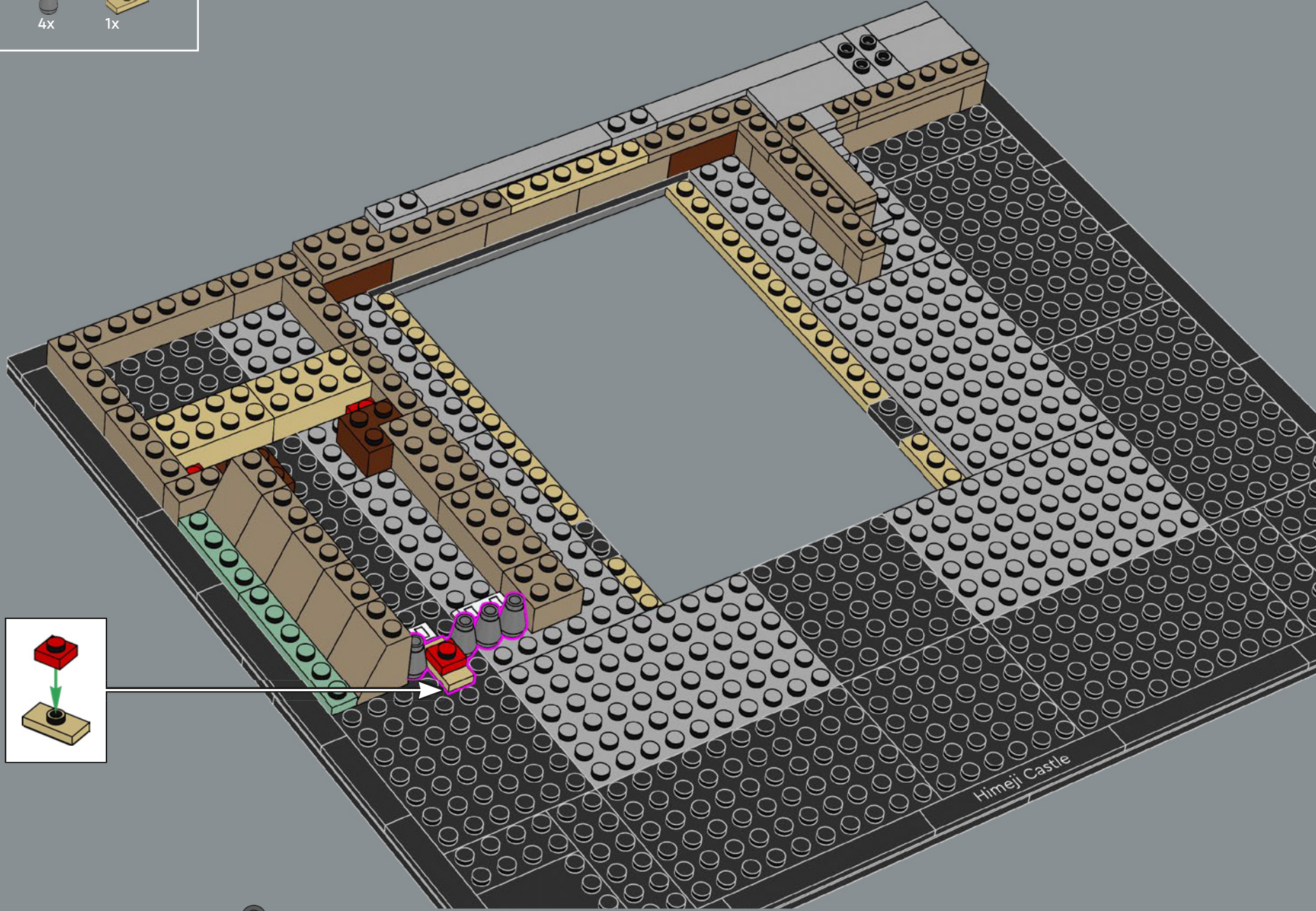

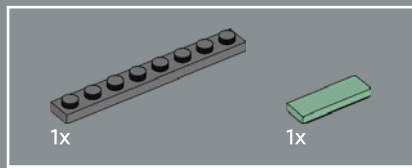

26

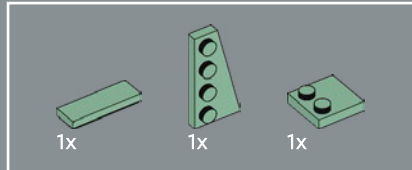
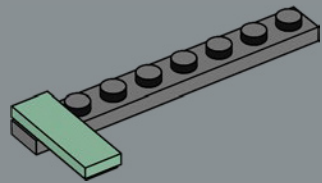

27

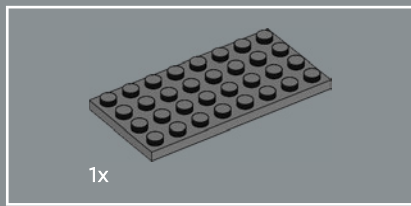
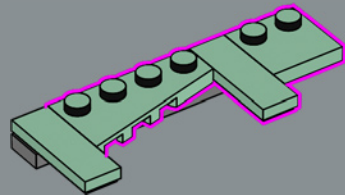

28

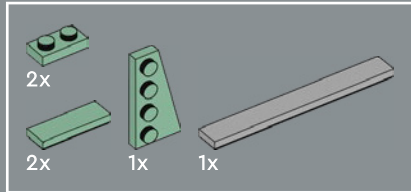
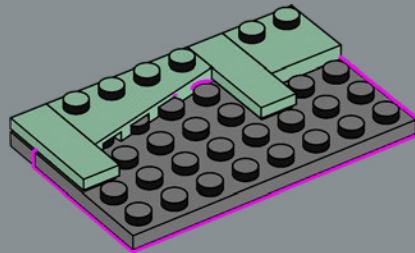

29

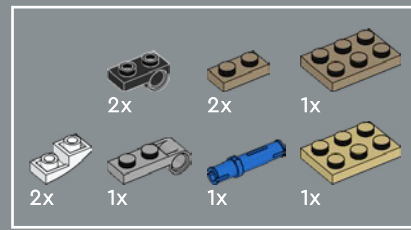
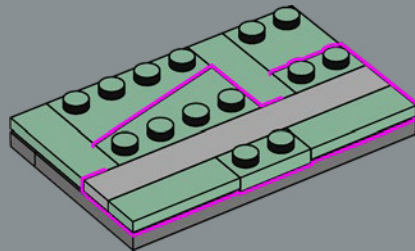

30

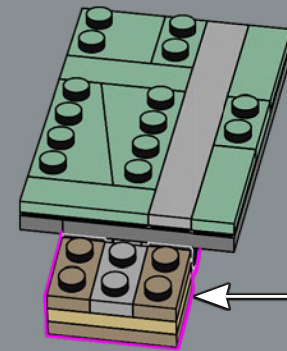
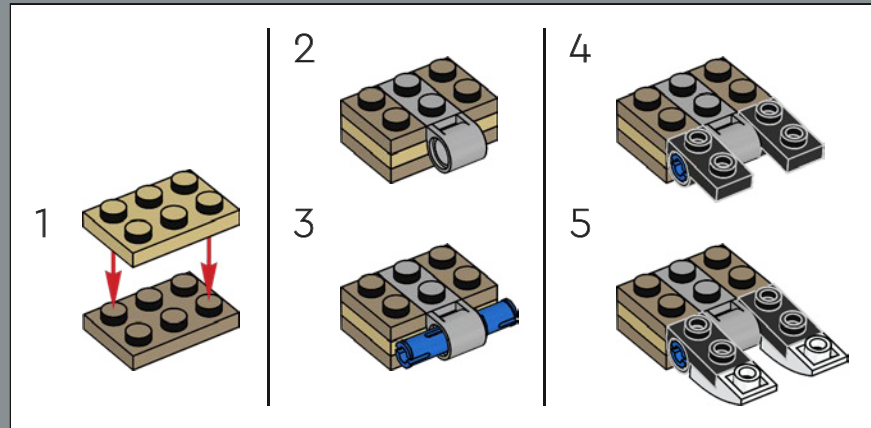

31

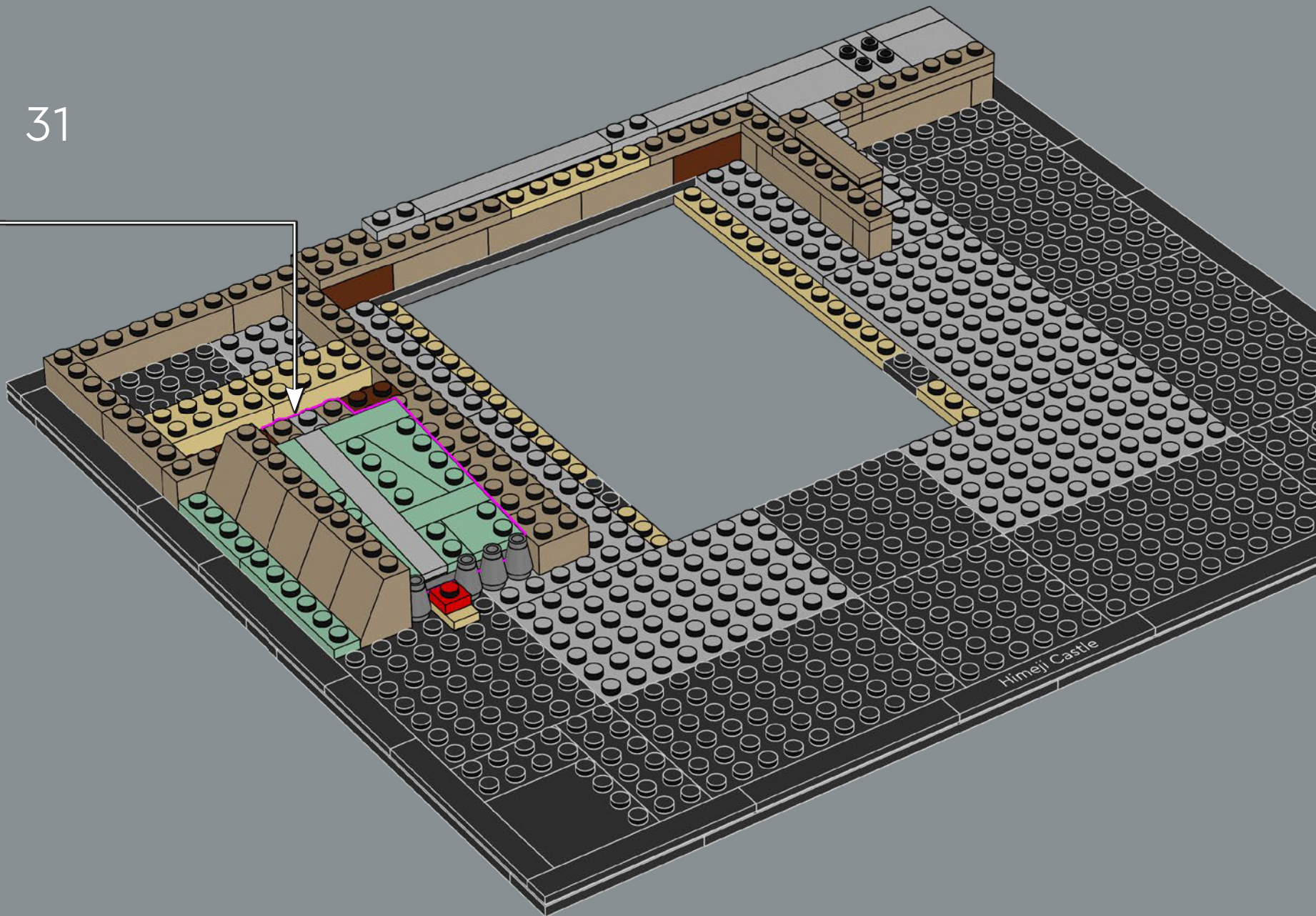

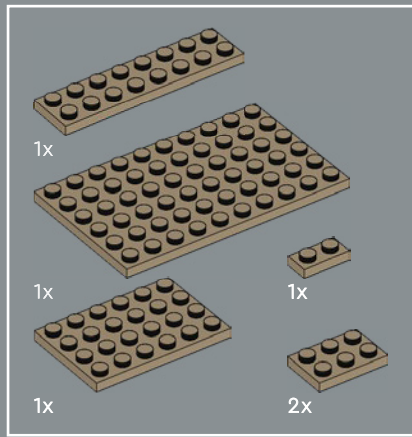

32

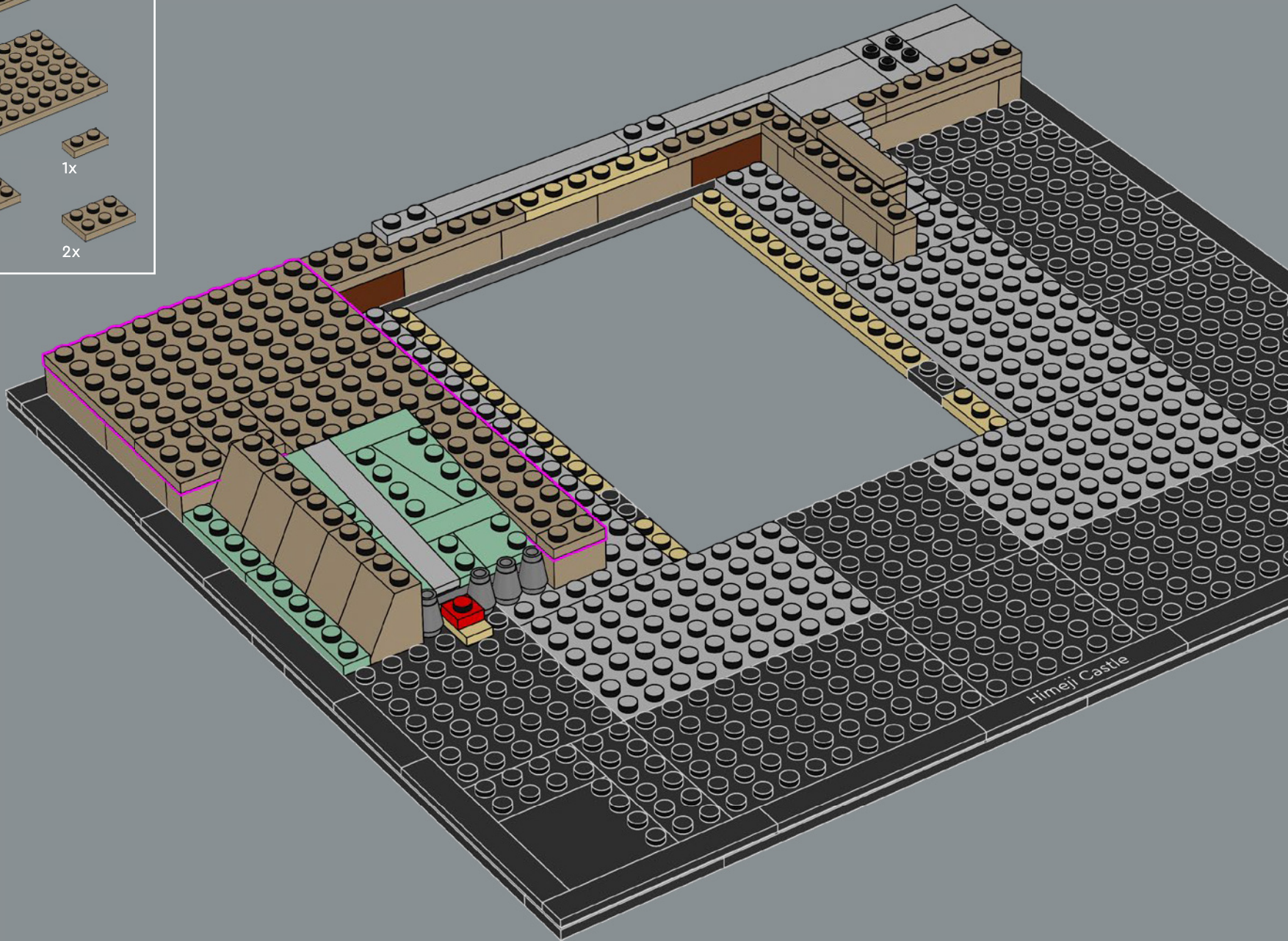

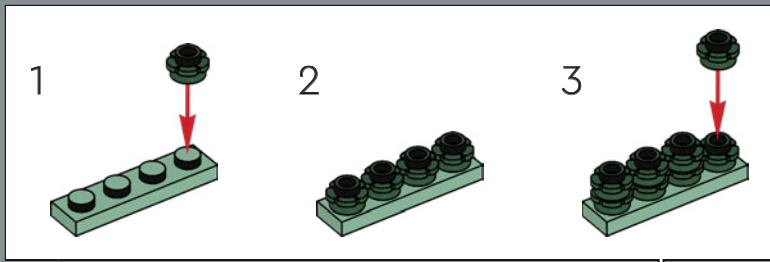
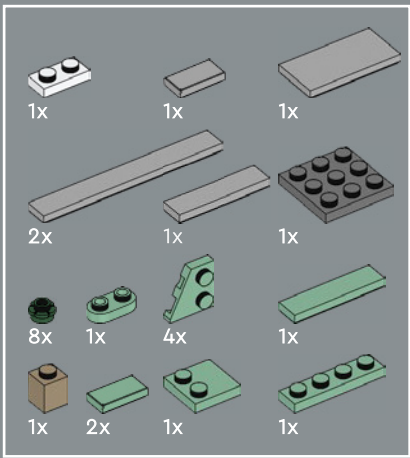

33

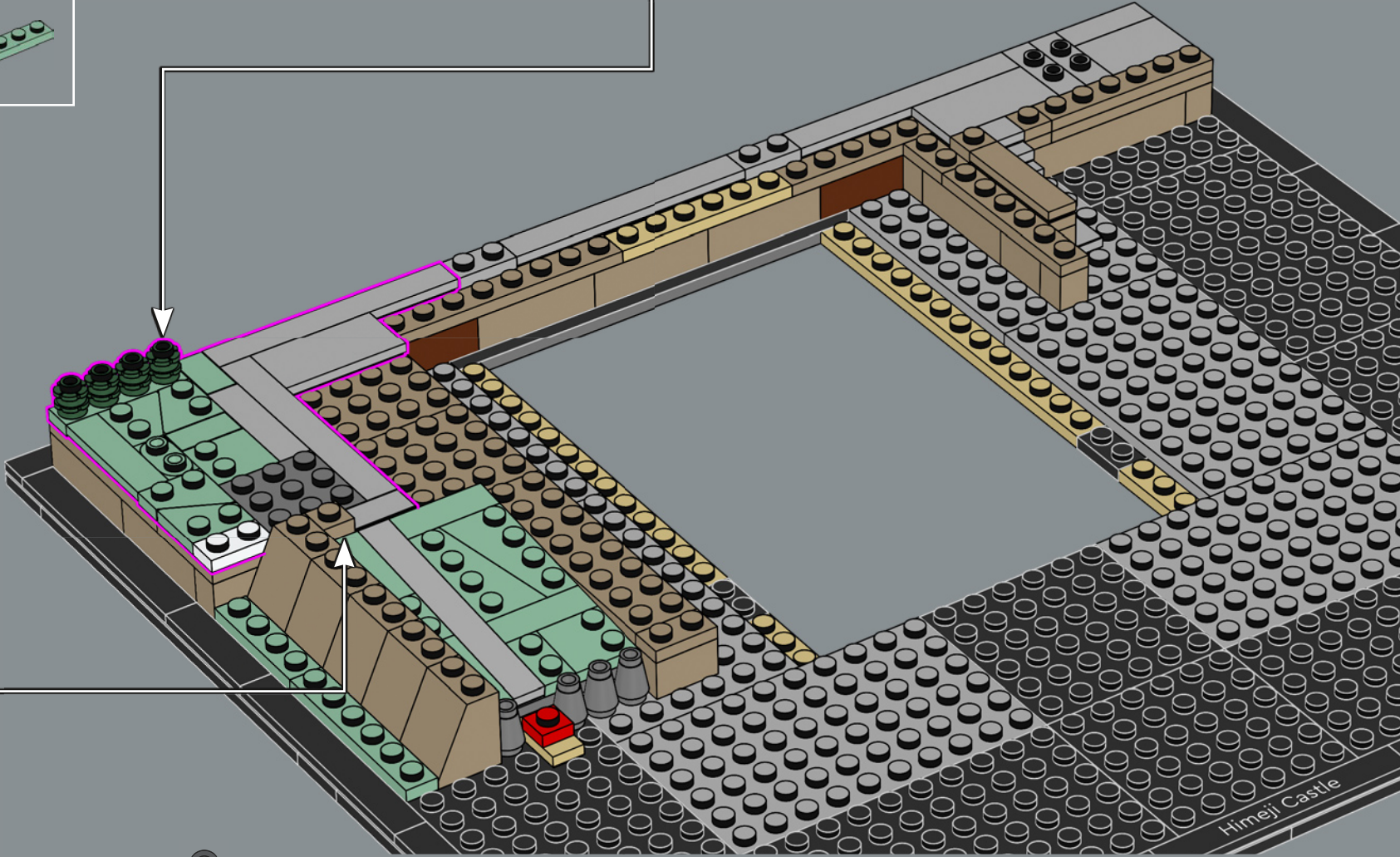

Himeiji Castle

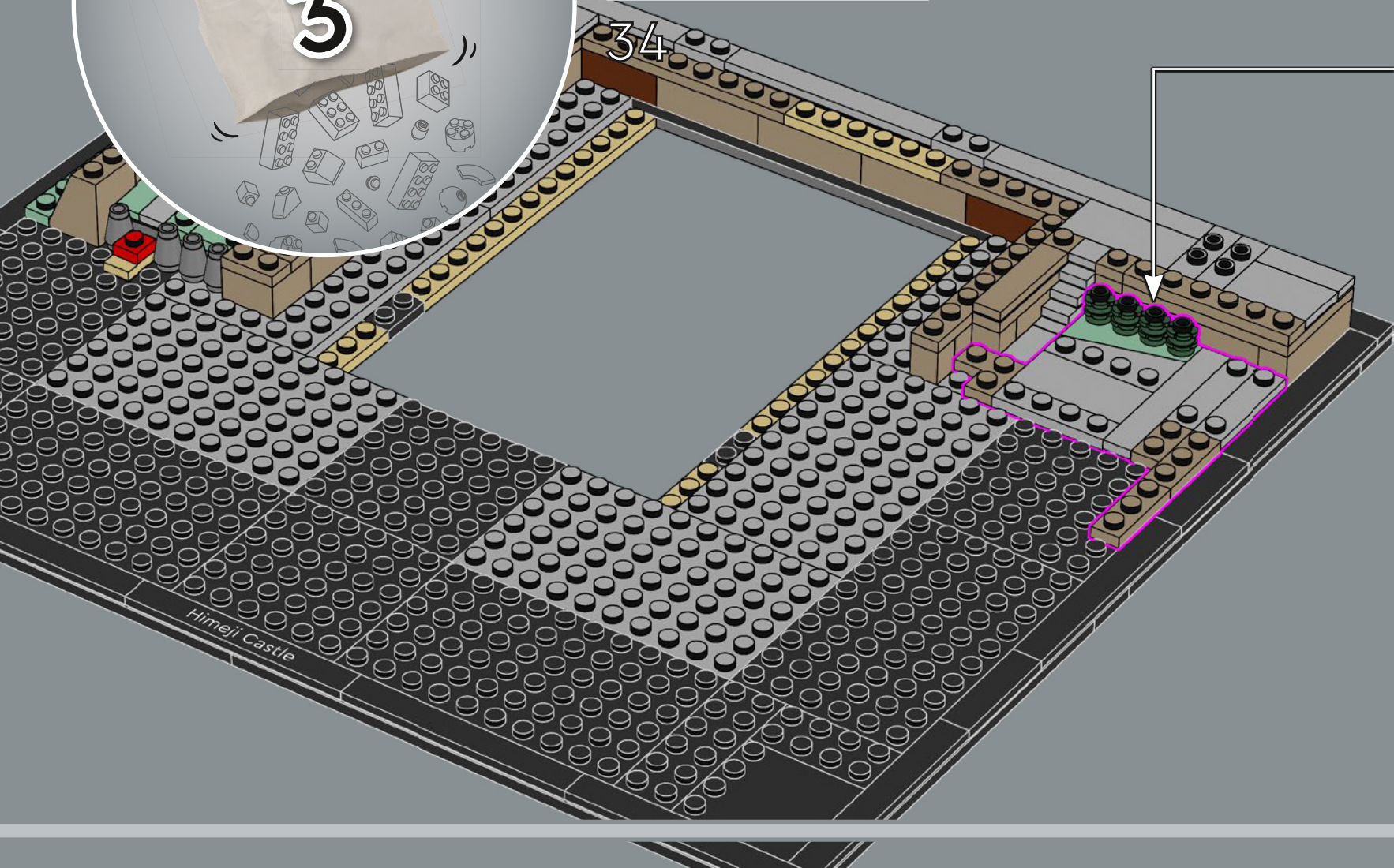
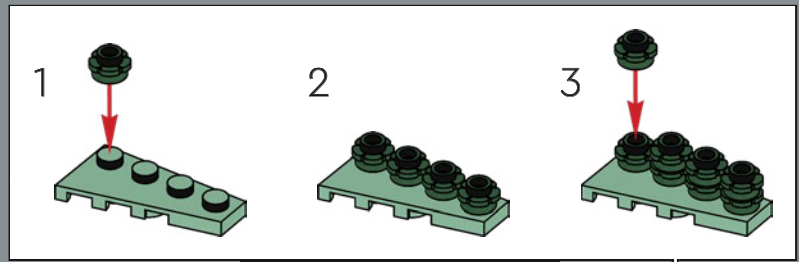
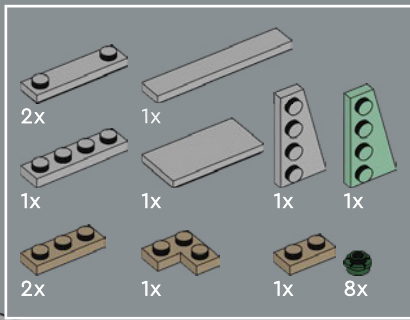

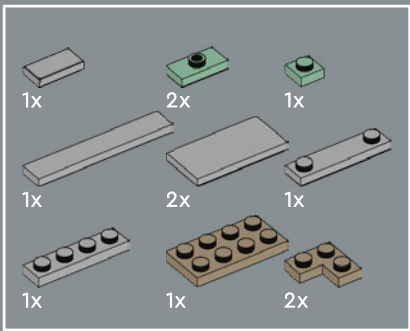

35

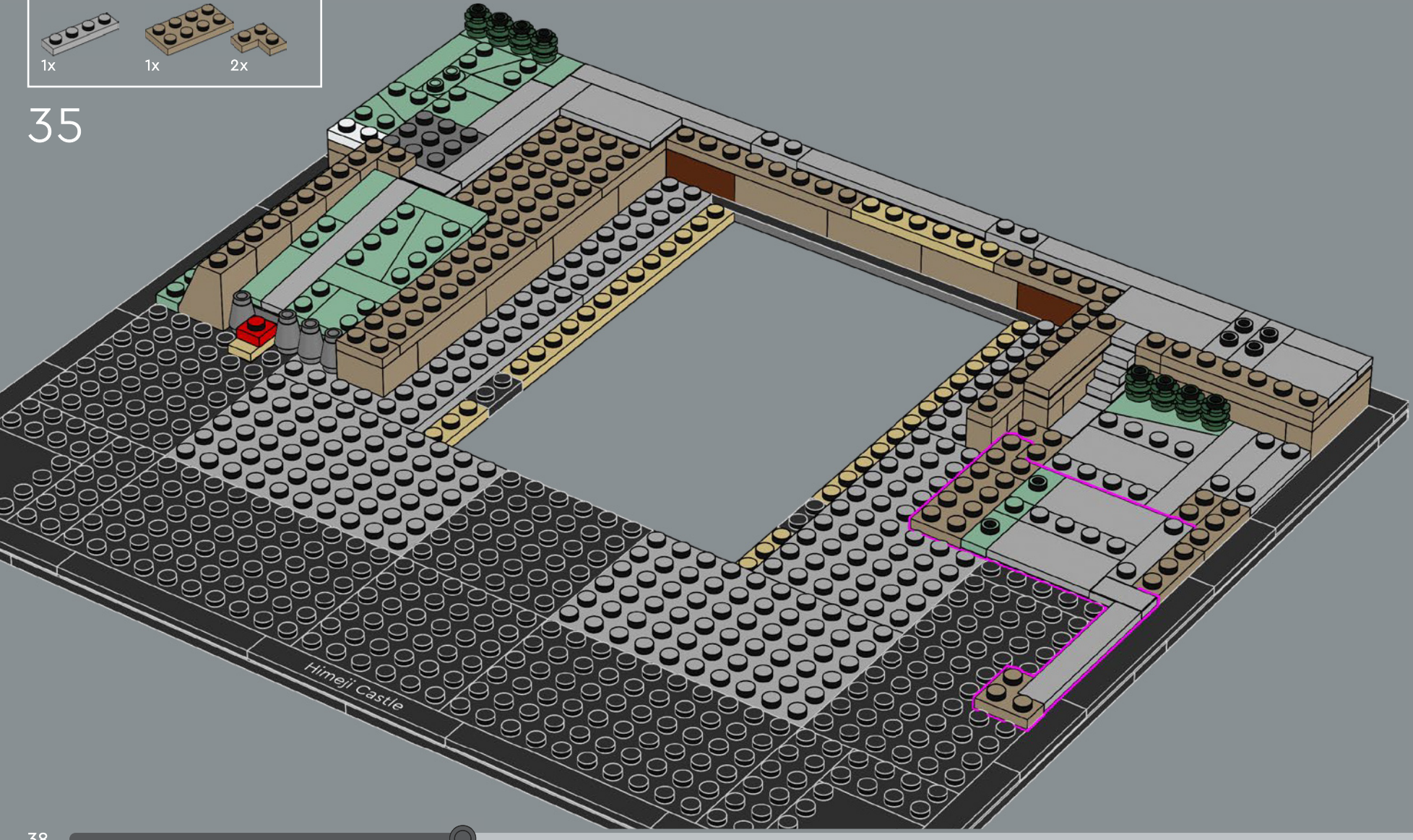

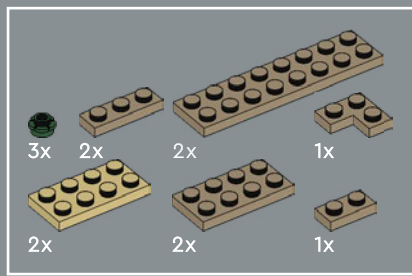

36

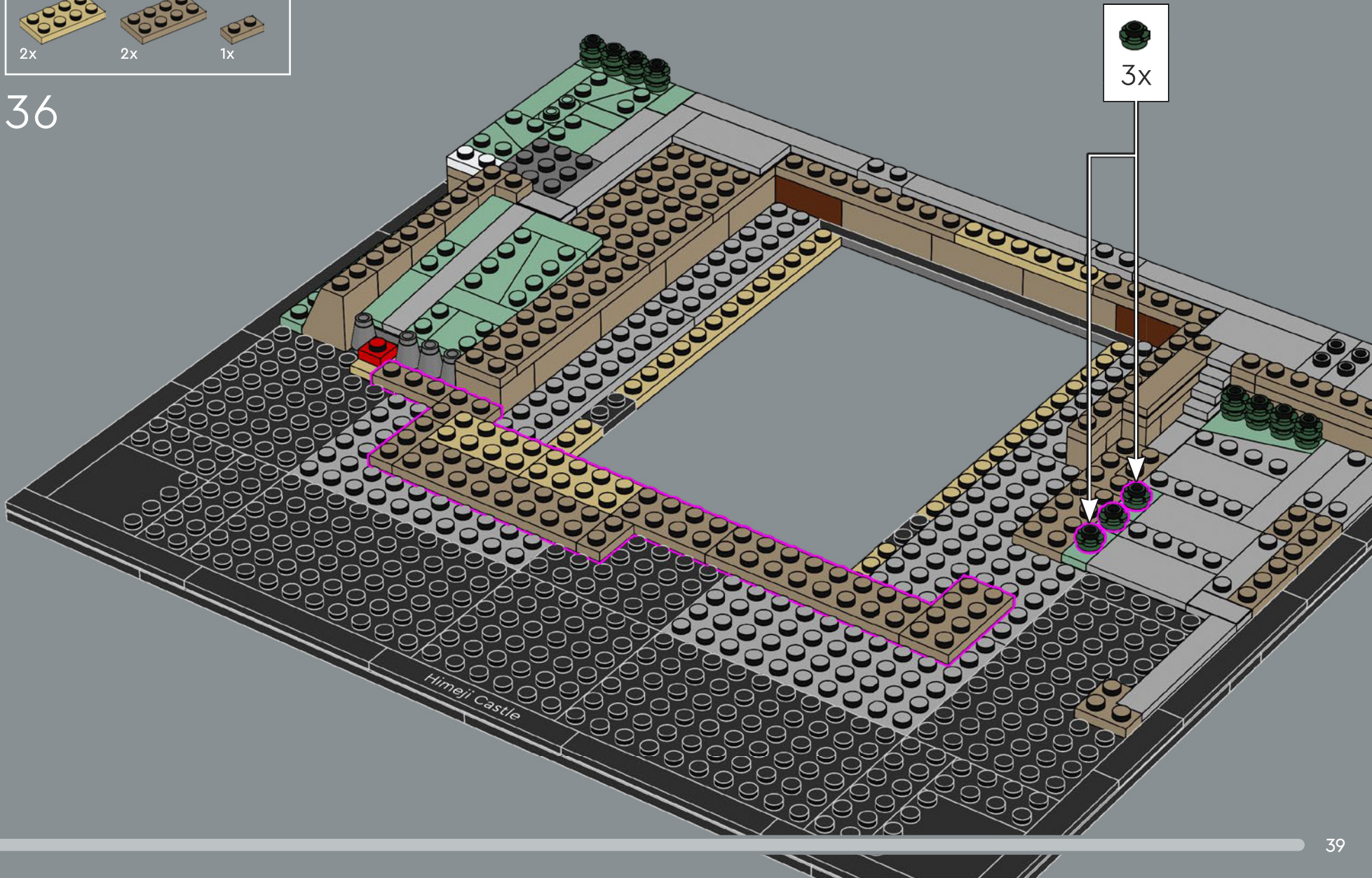

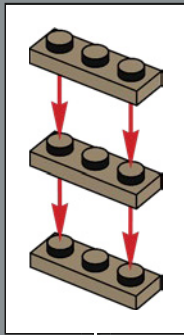
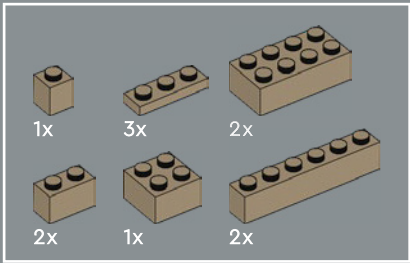

37

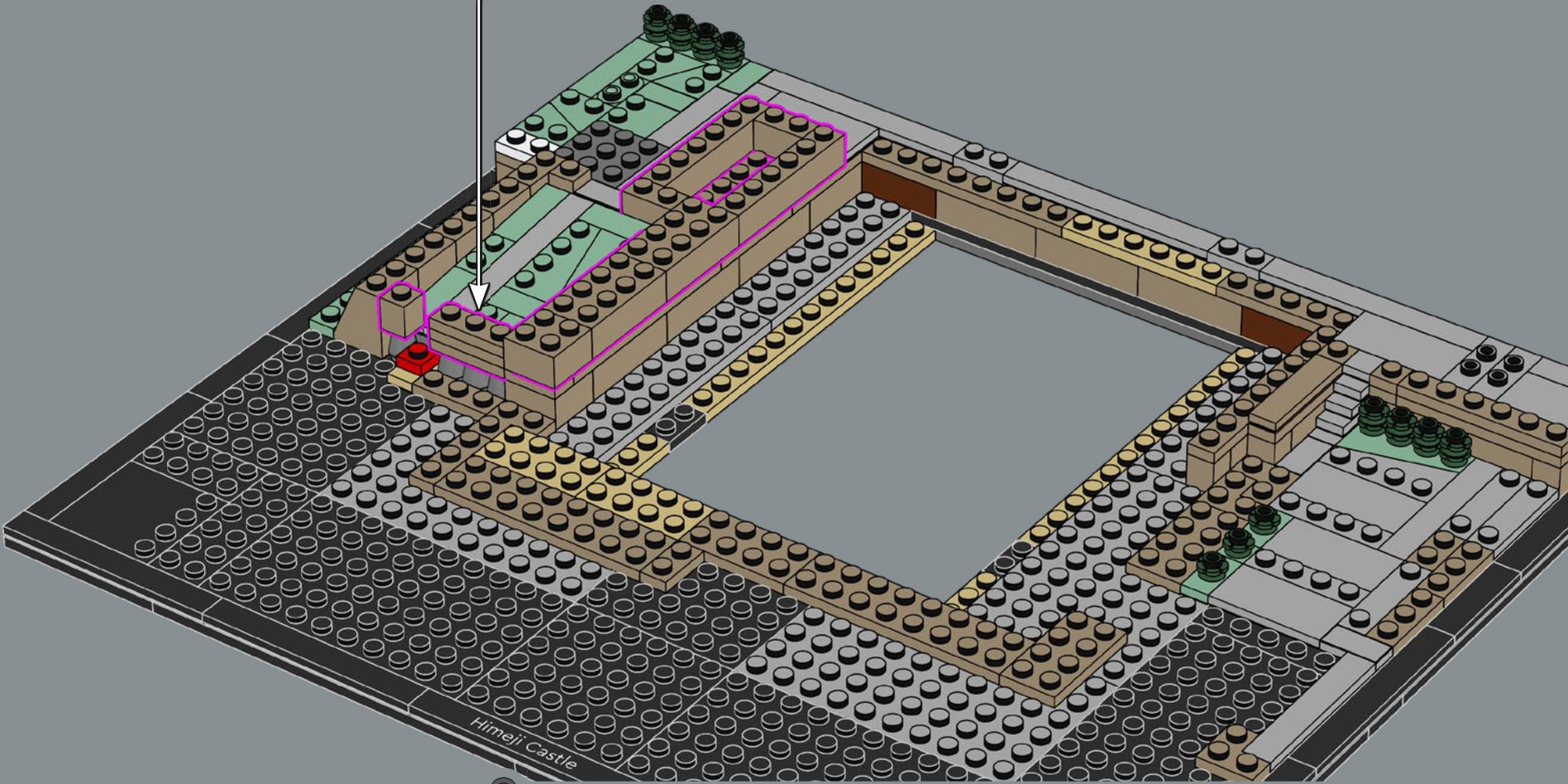

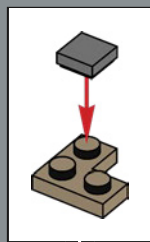
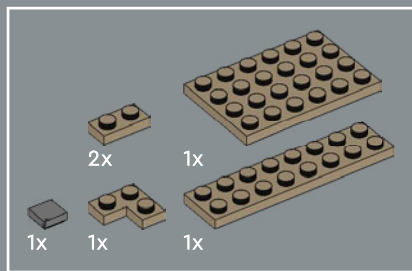

38

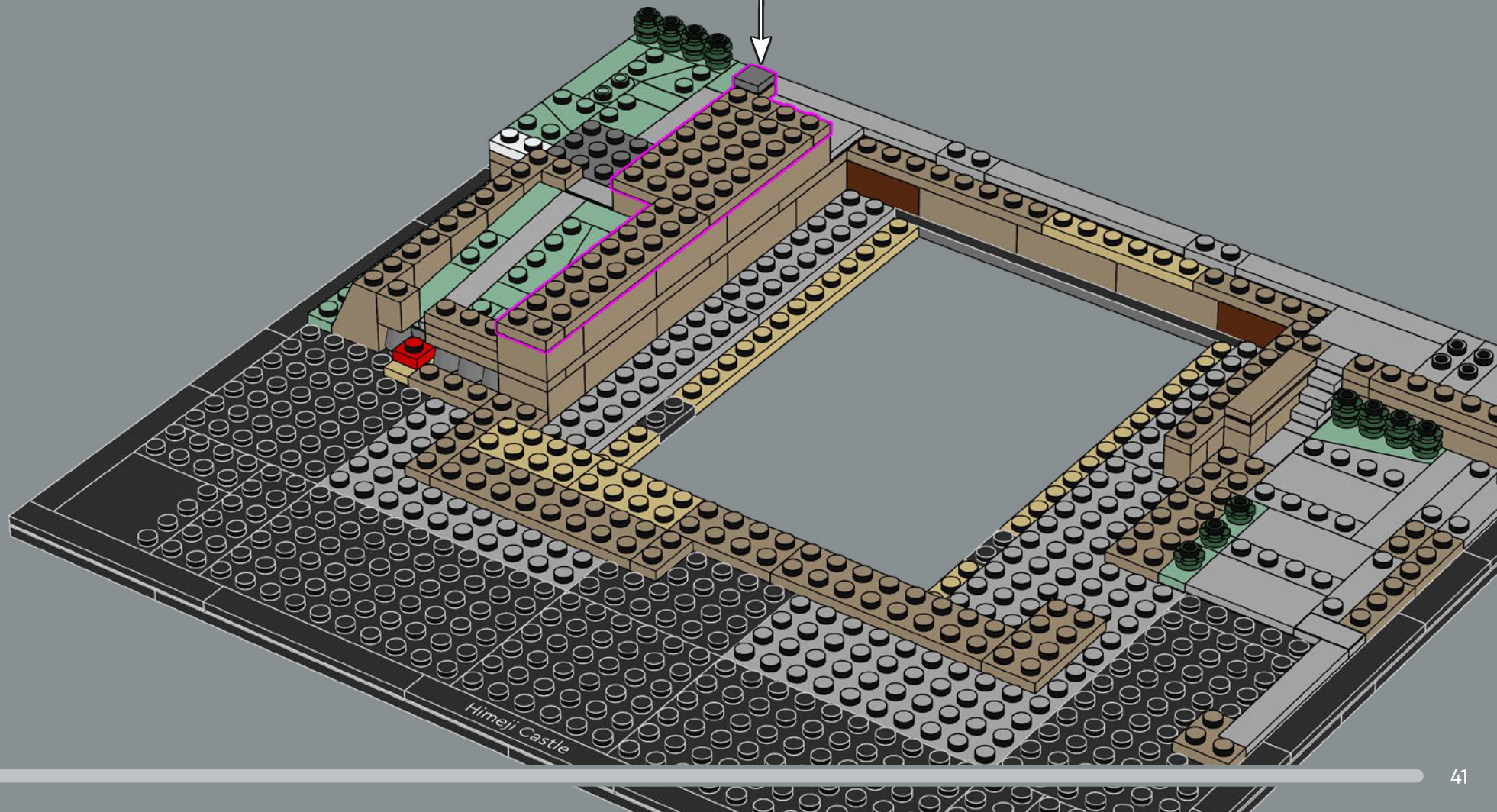

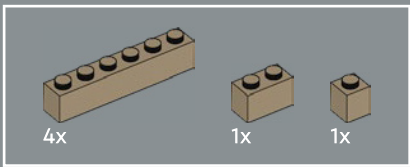

39

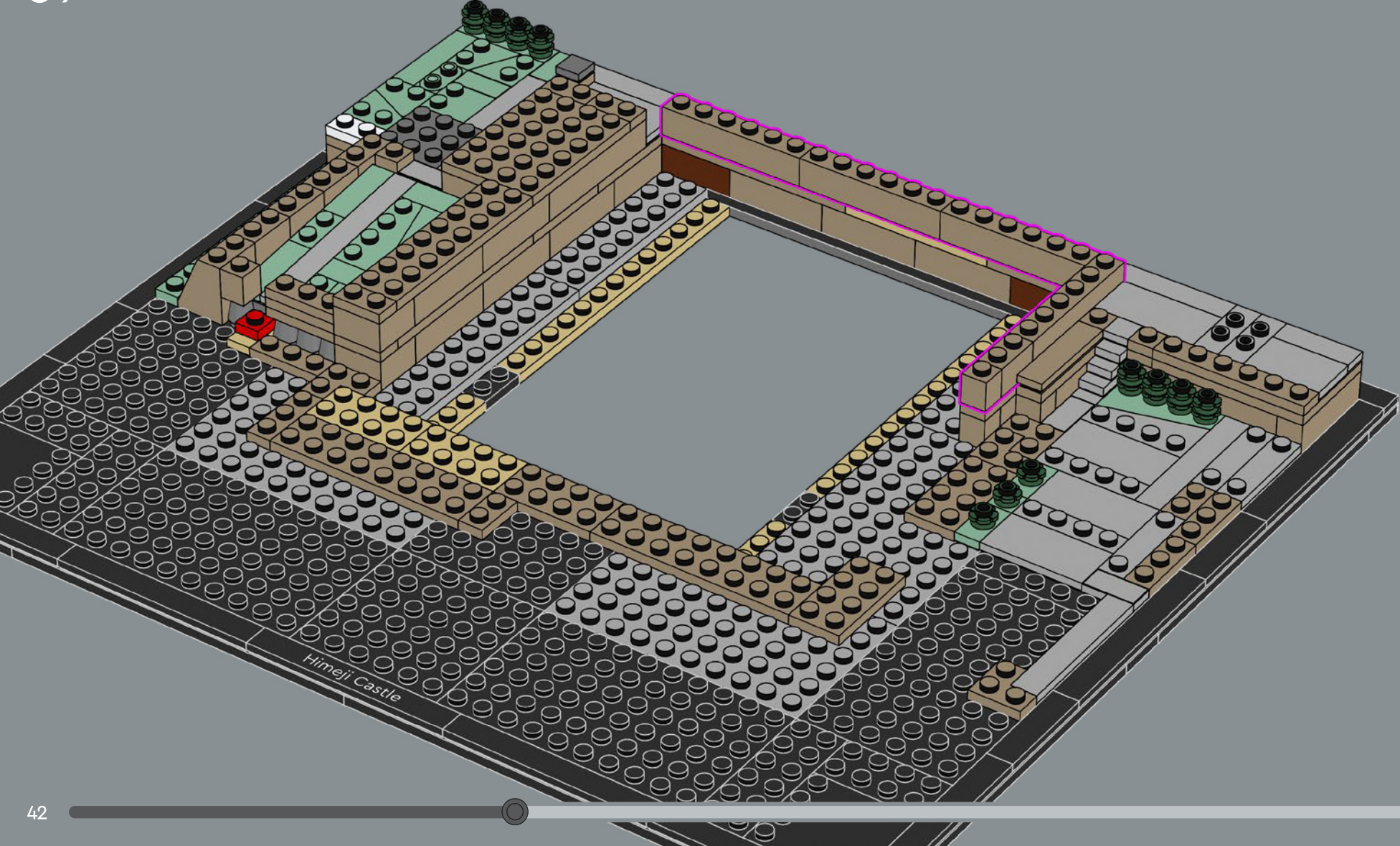

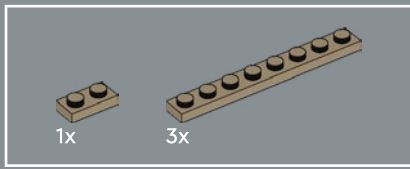

40

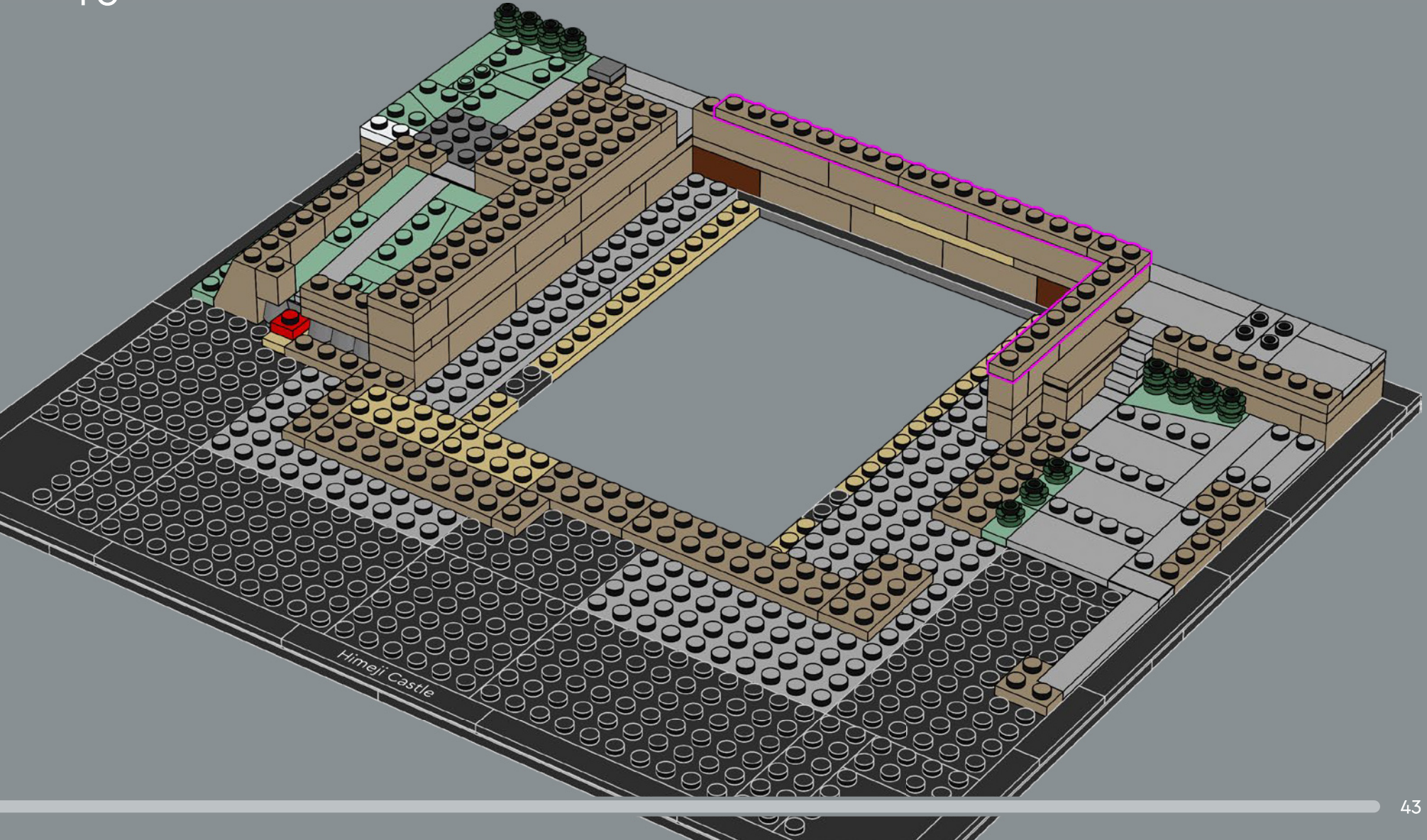

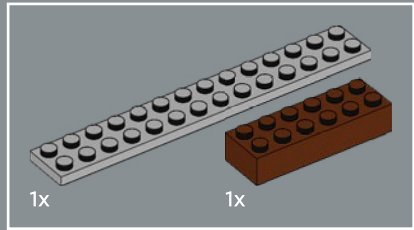
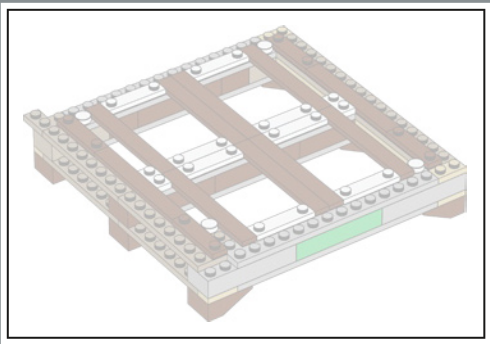

41

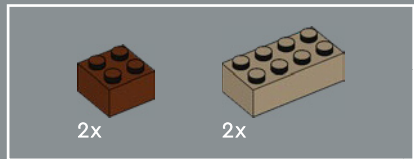
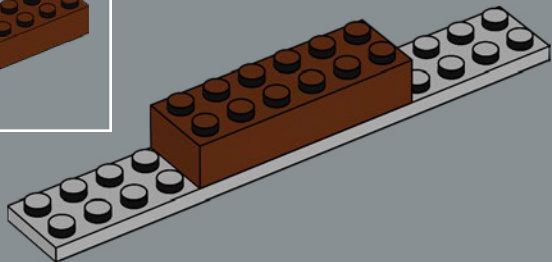

42

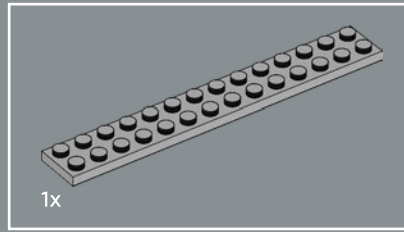
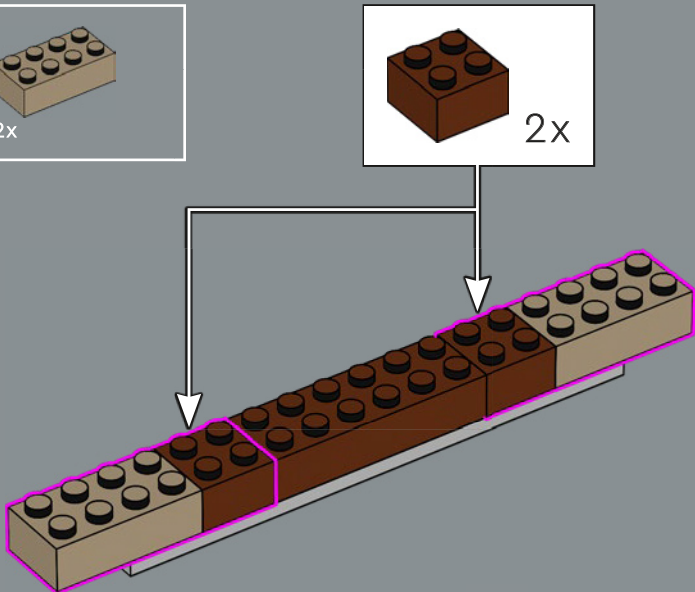

43

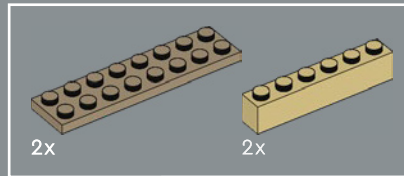
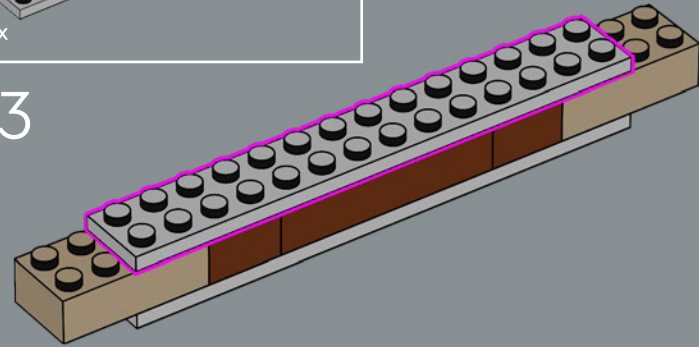

44

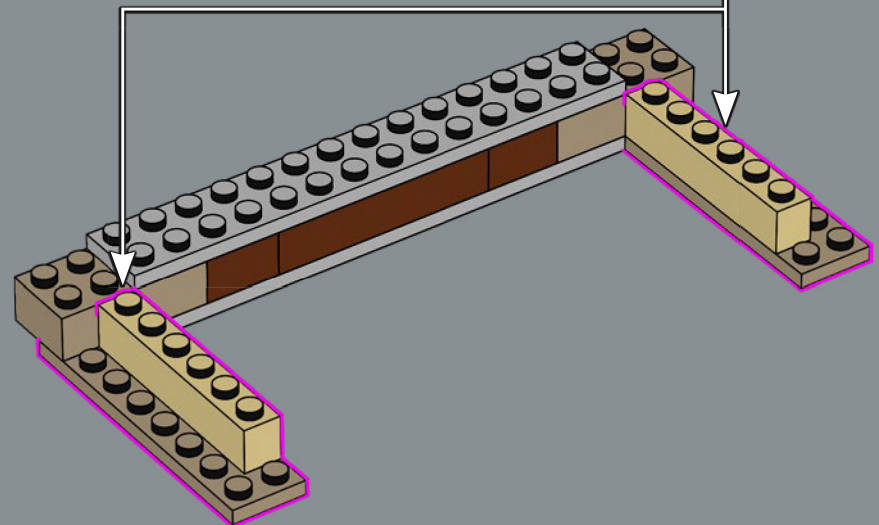
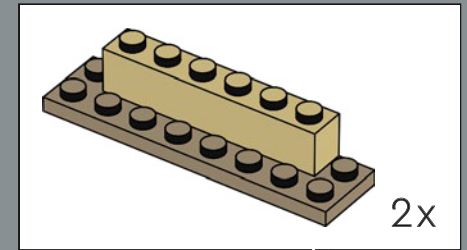

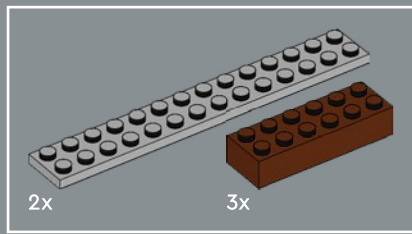

45

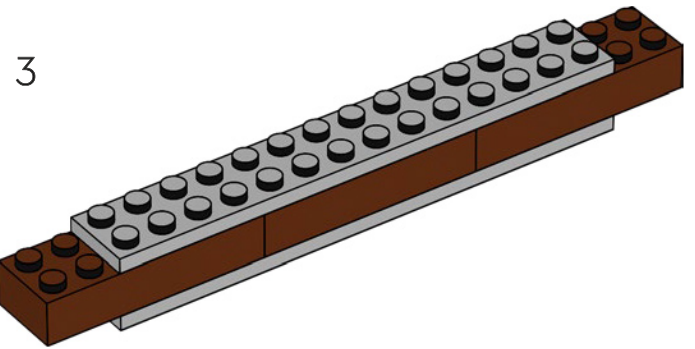
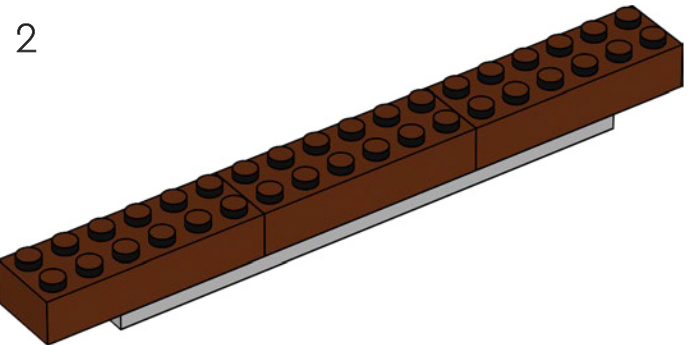
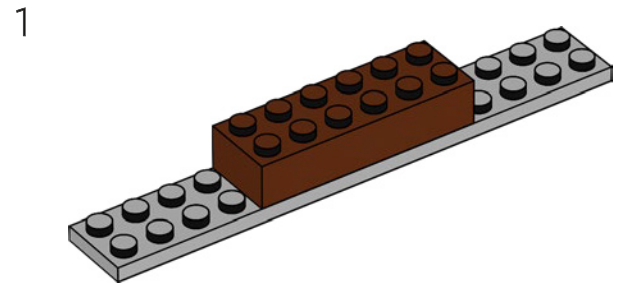
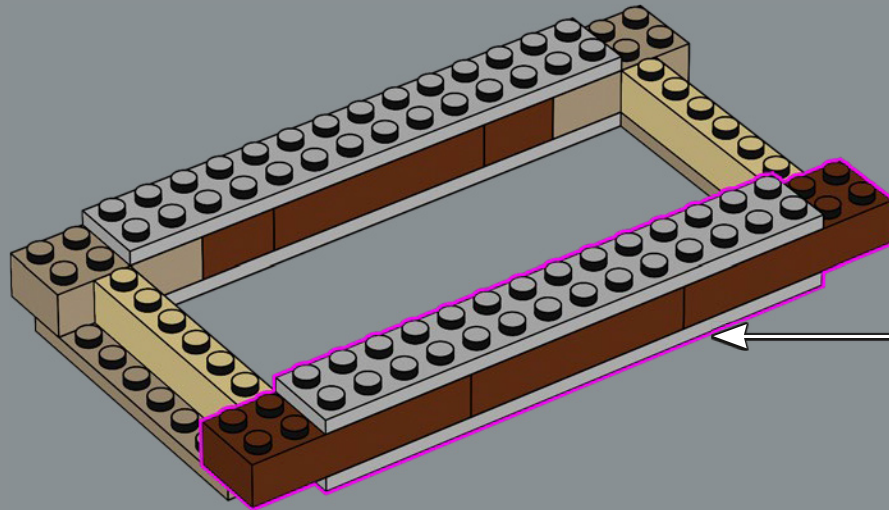

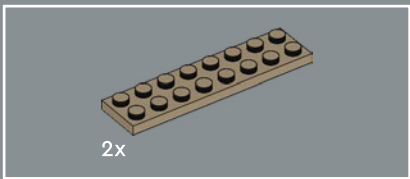

46

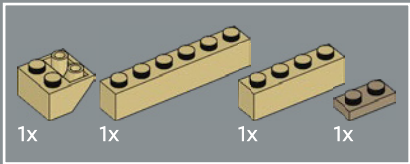
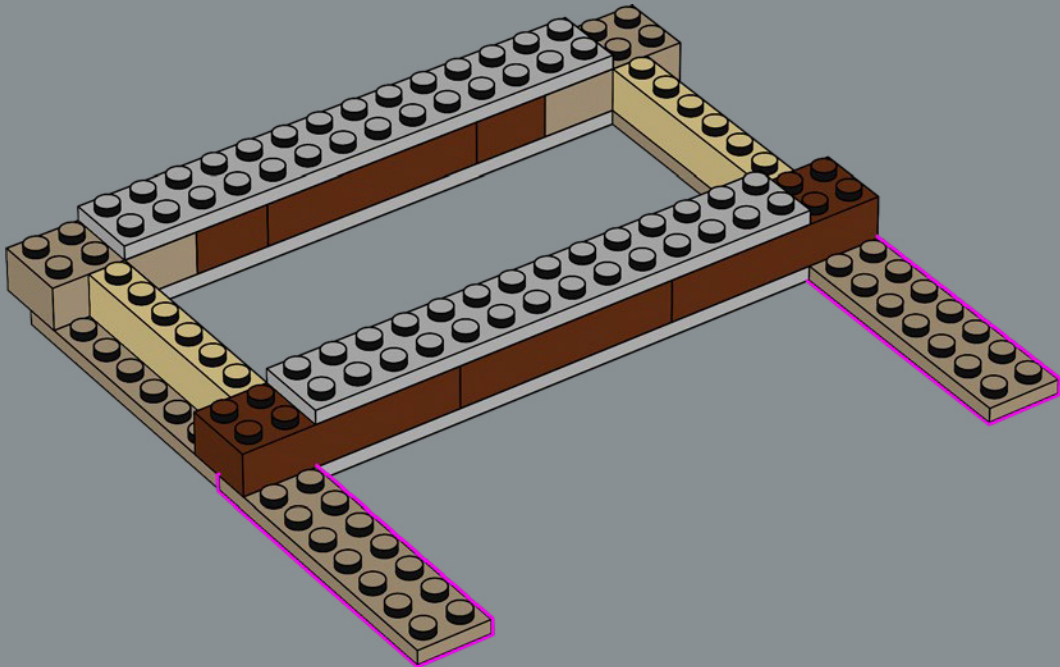

47

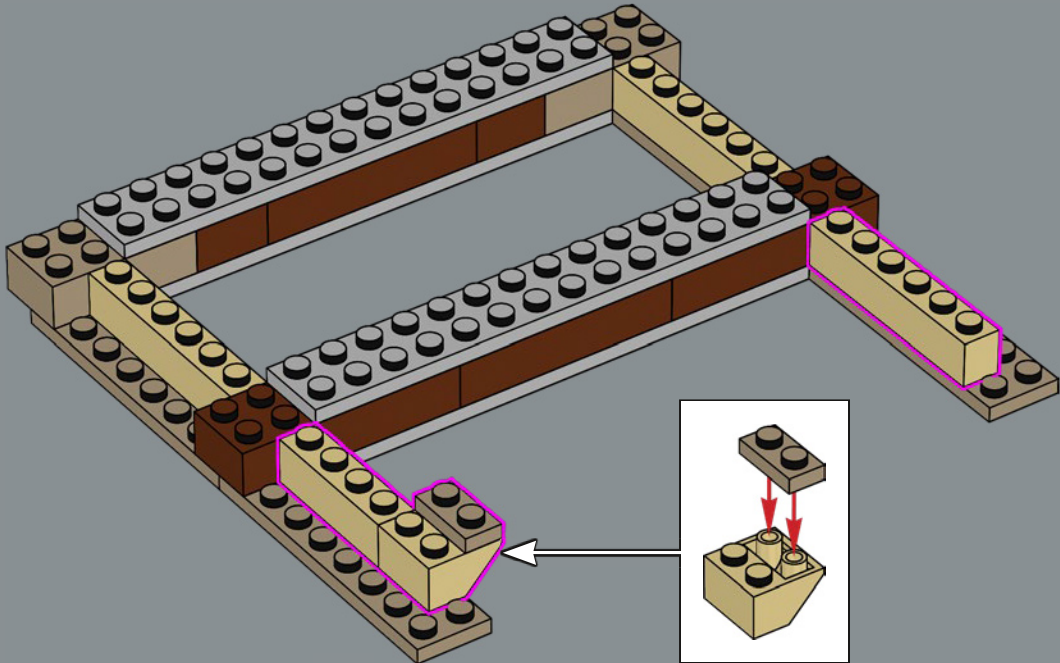

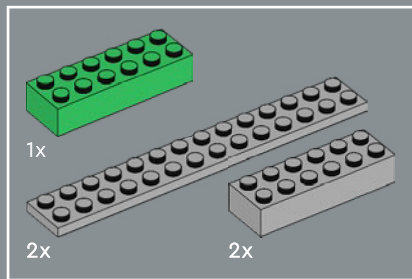

48

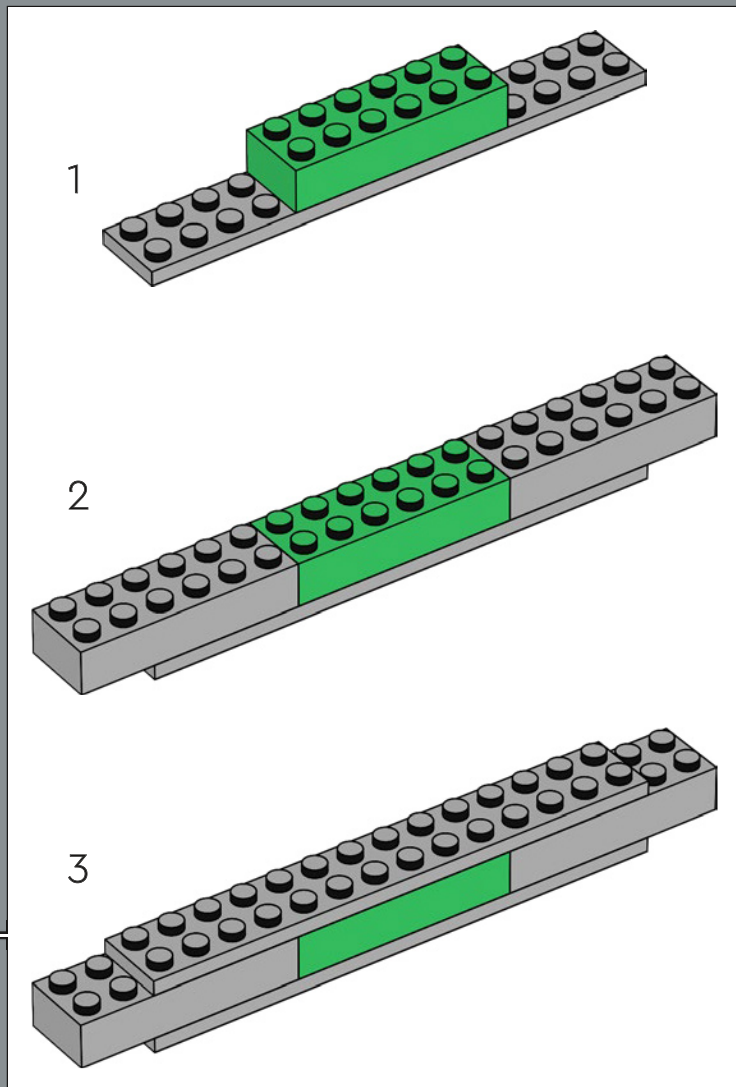
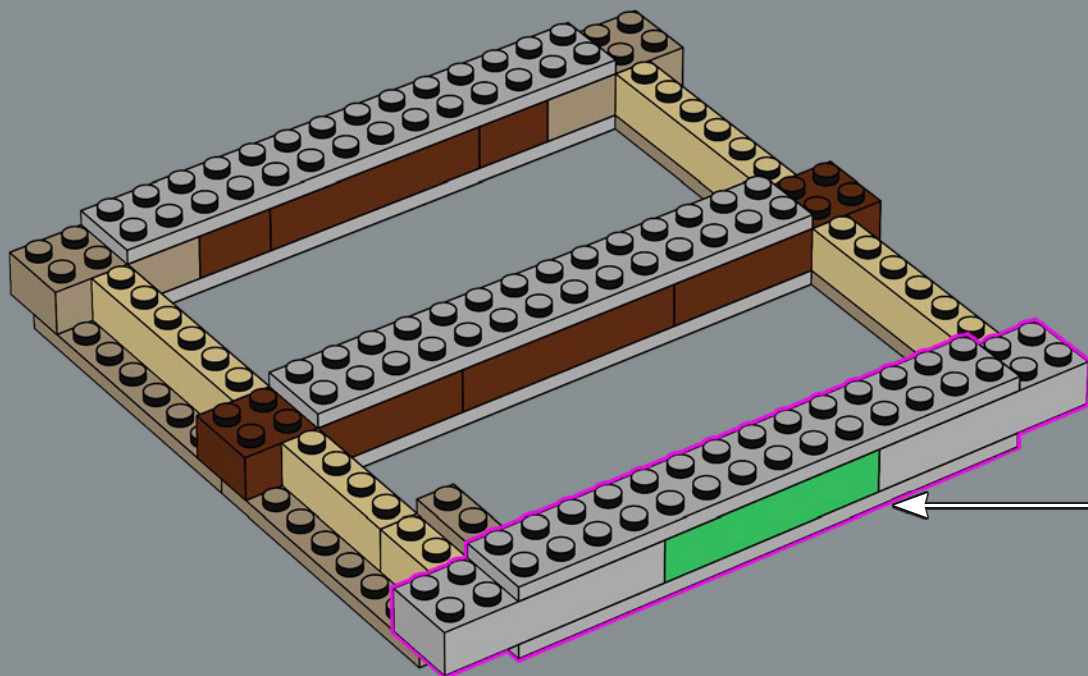

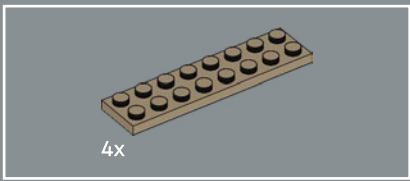

49

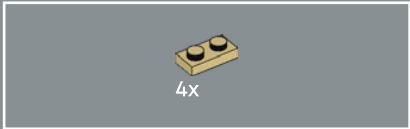
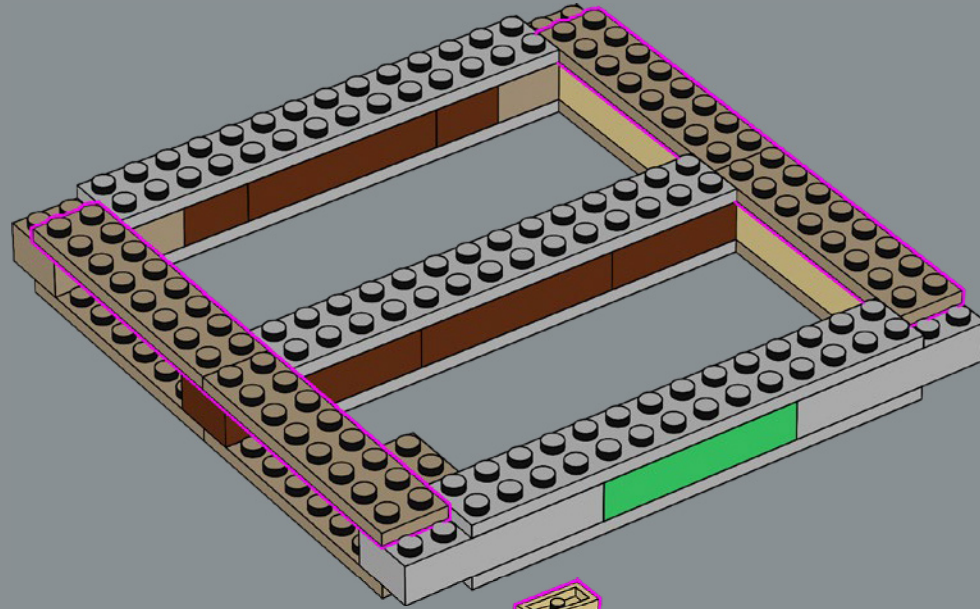

50

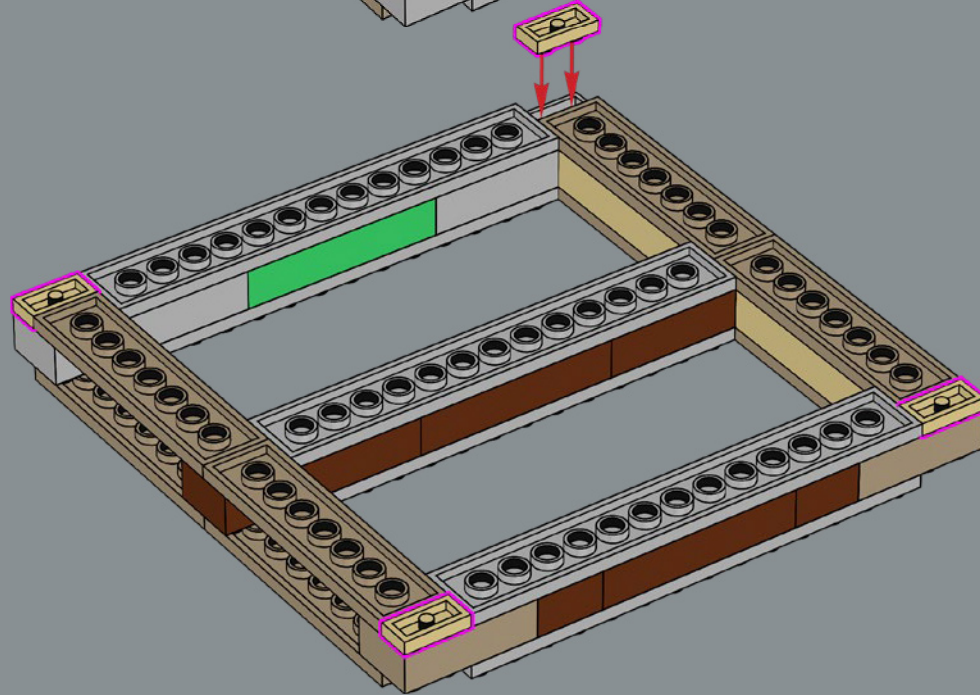



51

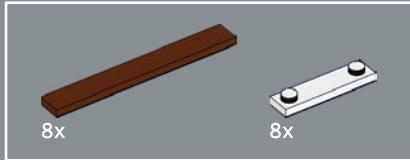
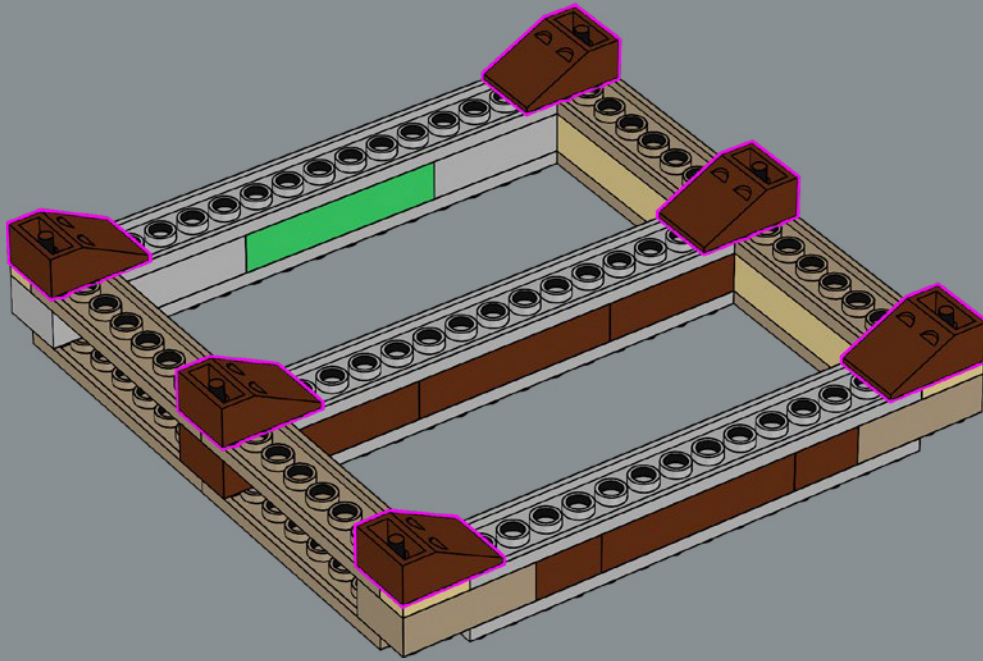

52

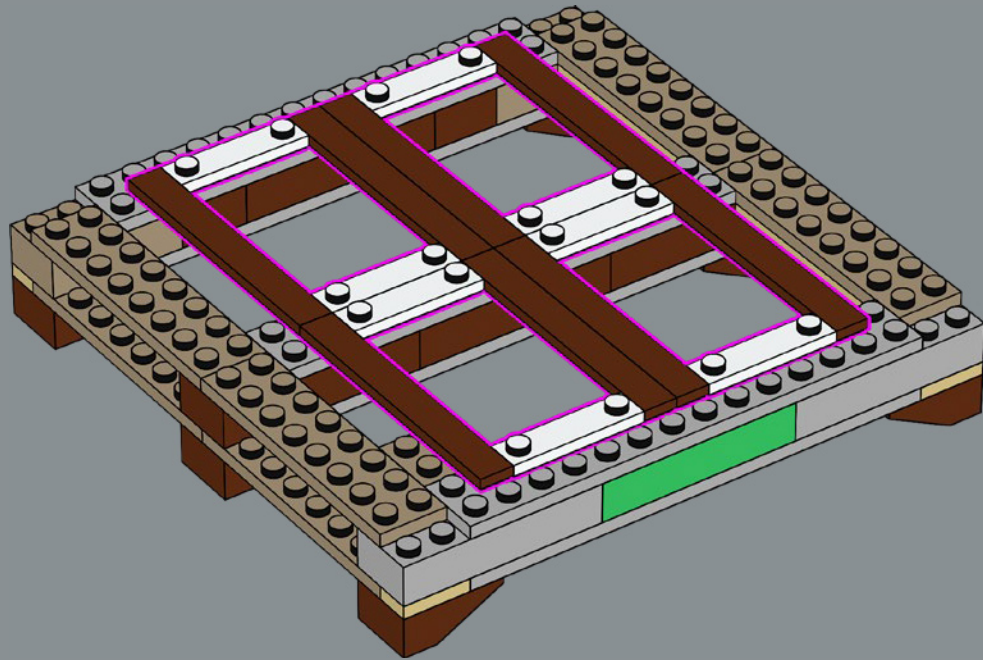

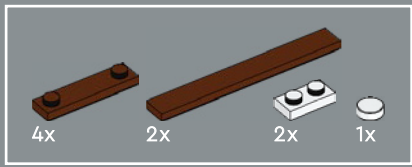

53

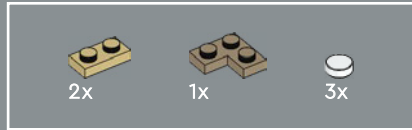
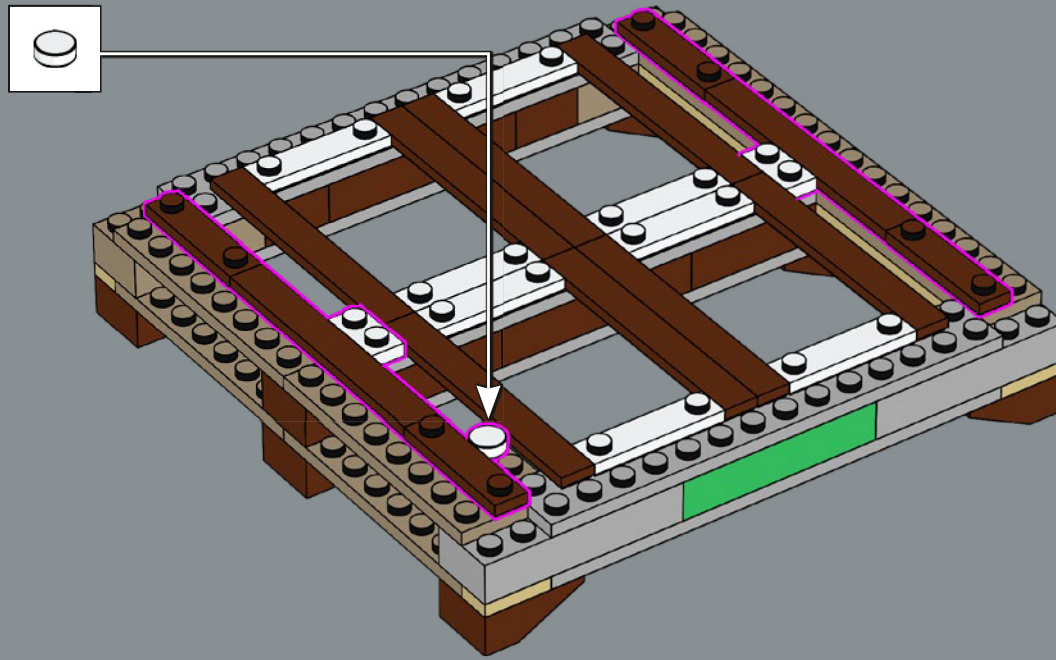

54

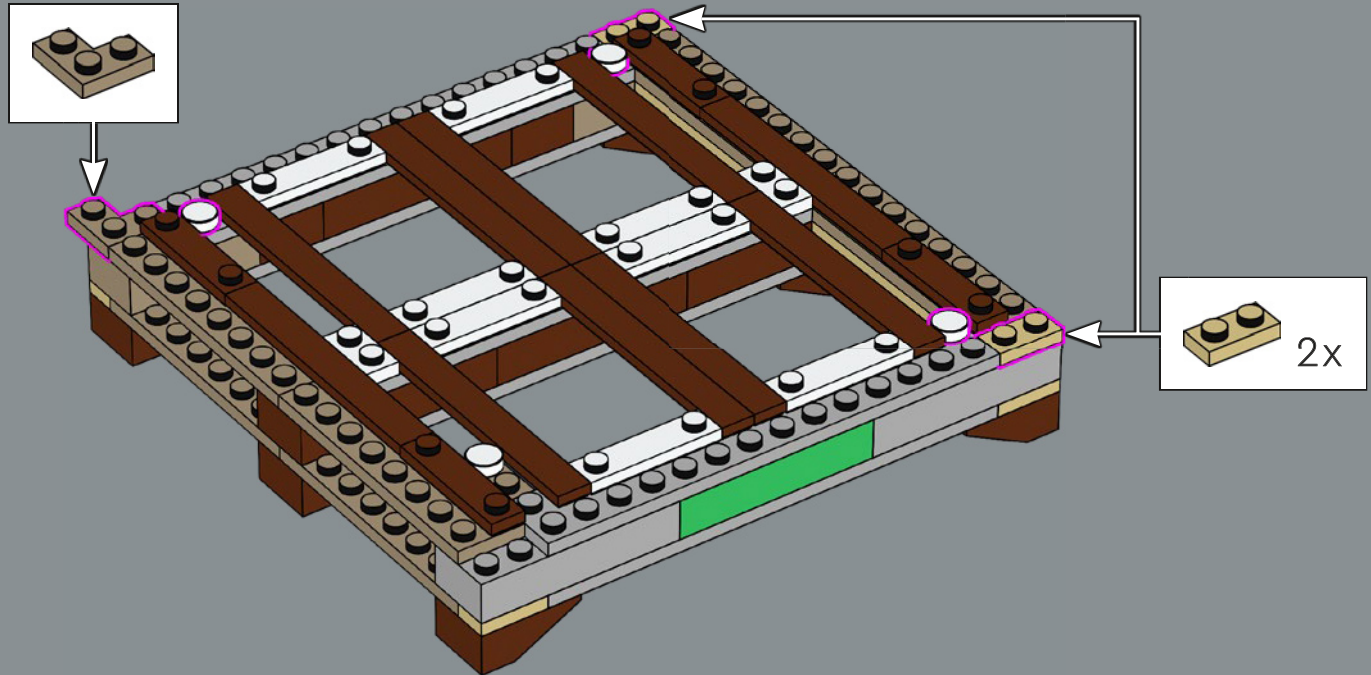

55

Le château repose sur une plaque en briques, qui a été conçue pour recréer le décor brun et blanc omniprésent à l'intérieur du château.

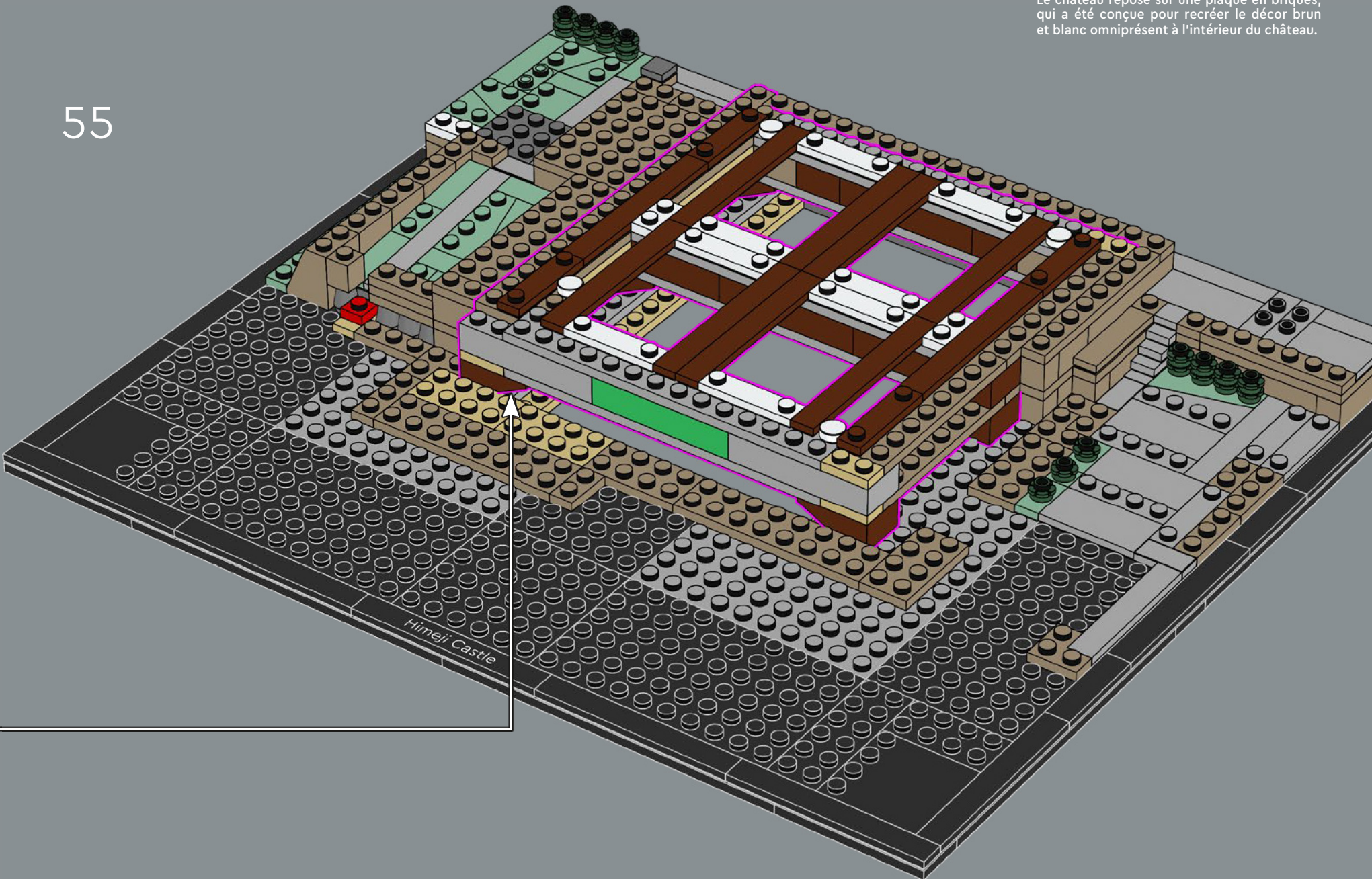

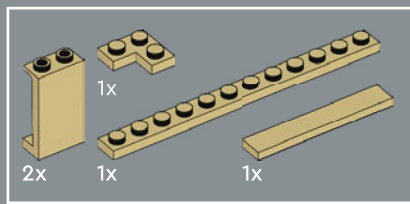

56

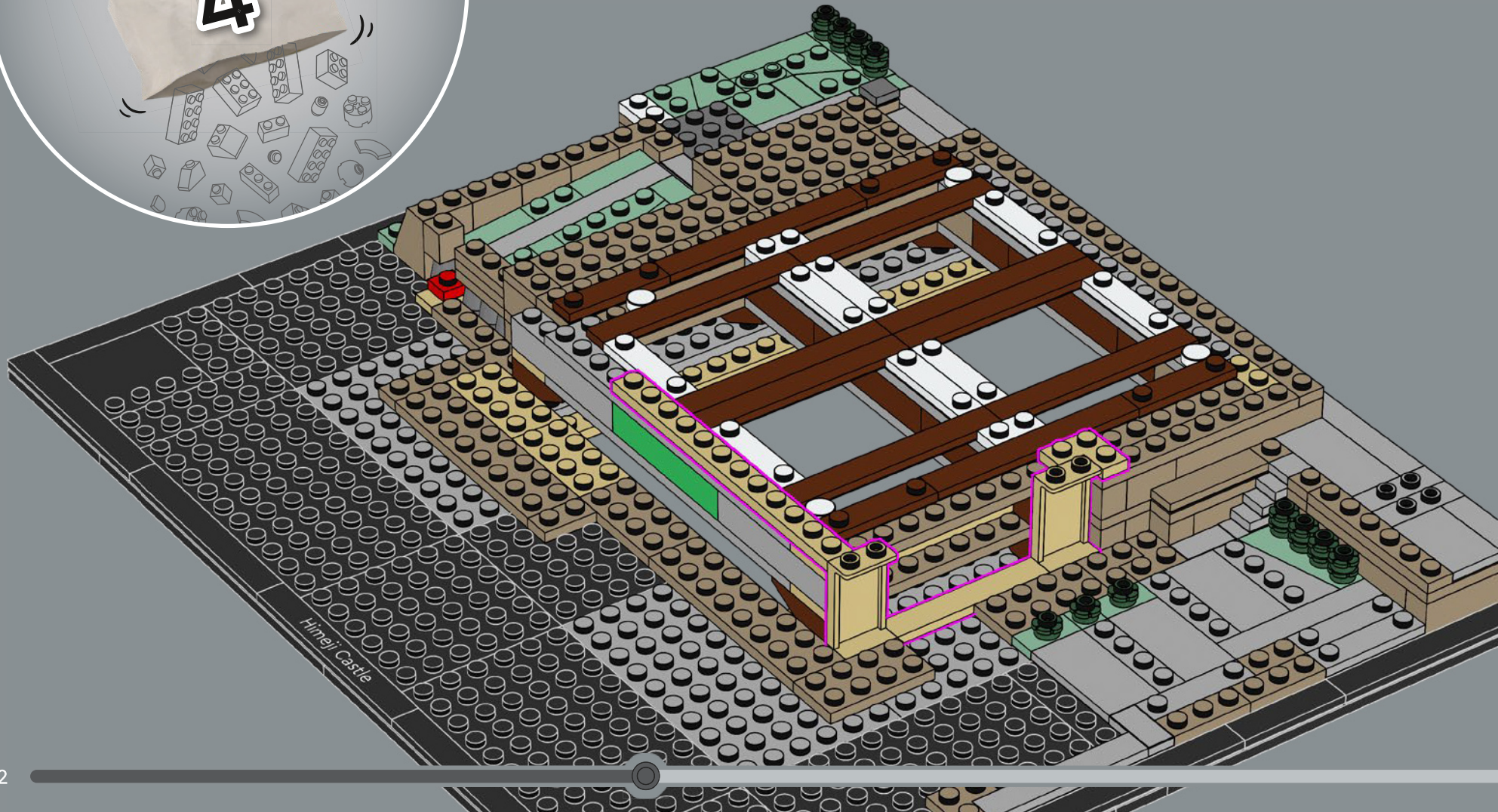

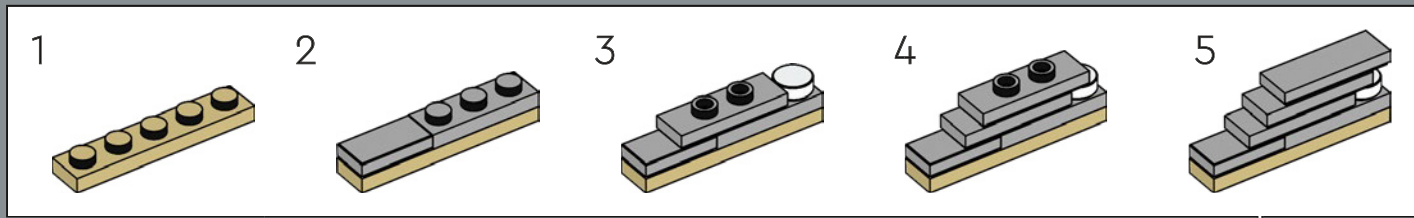
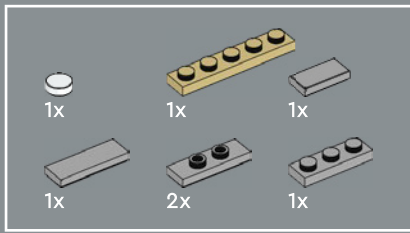

57

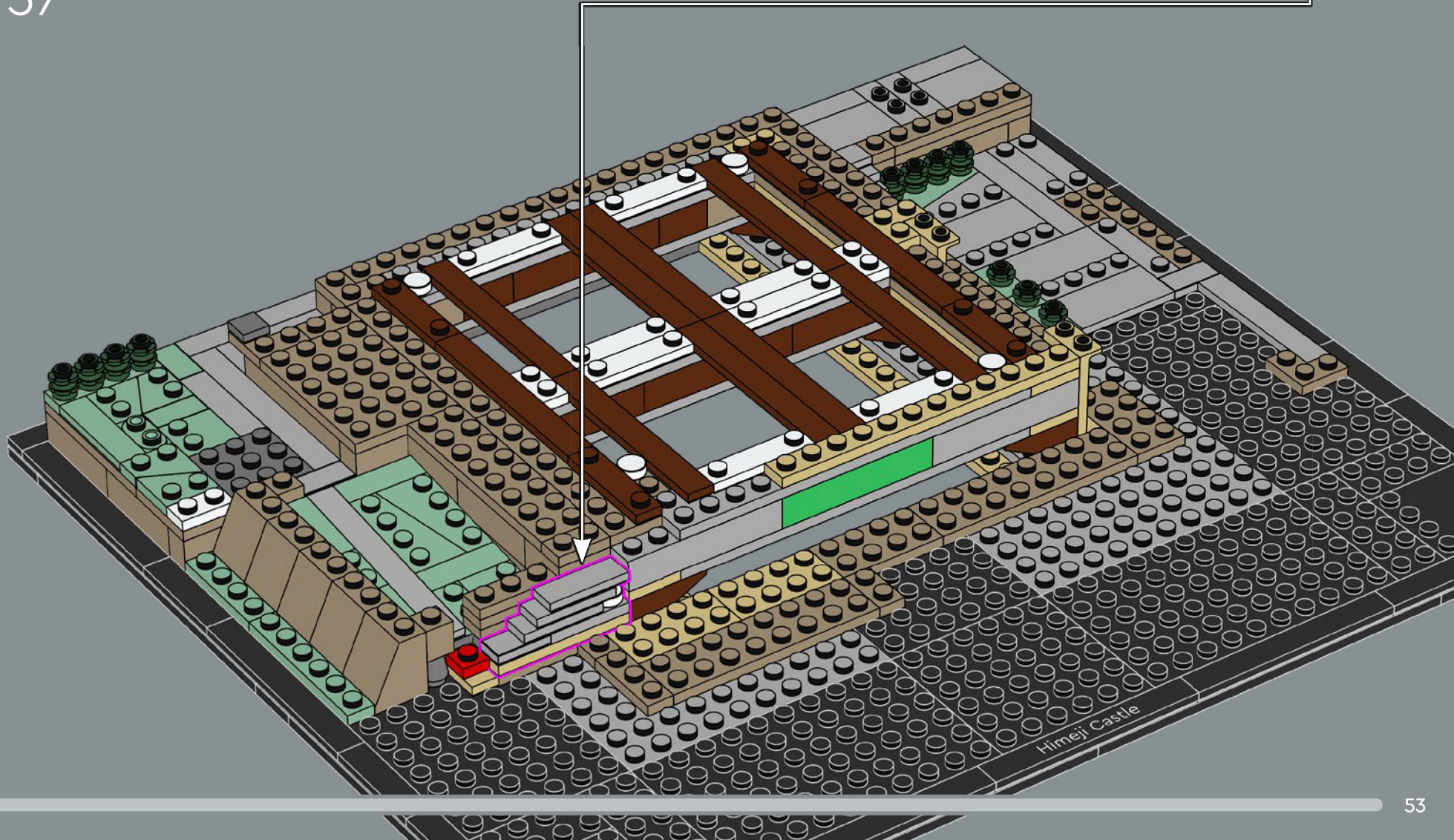

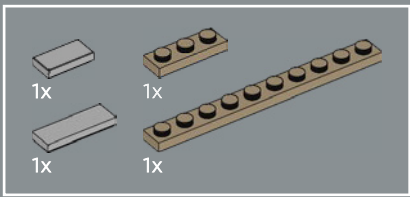

58

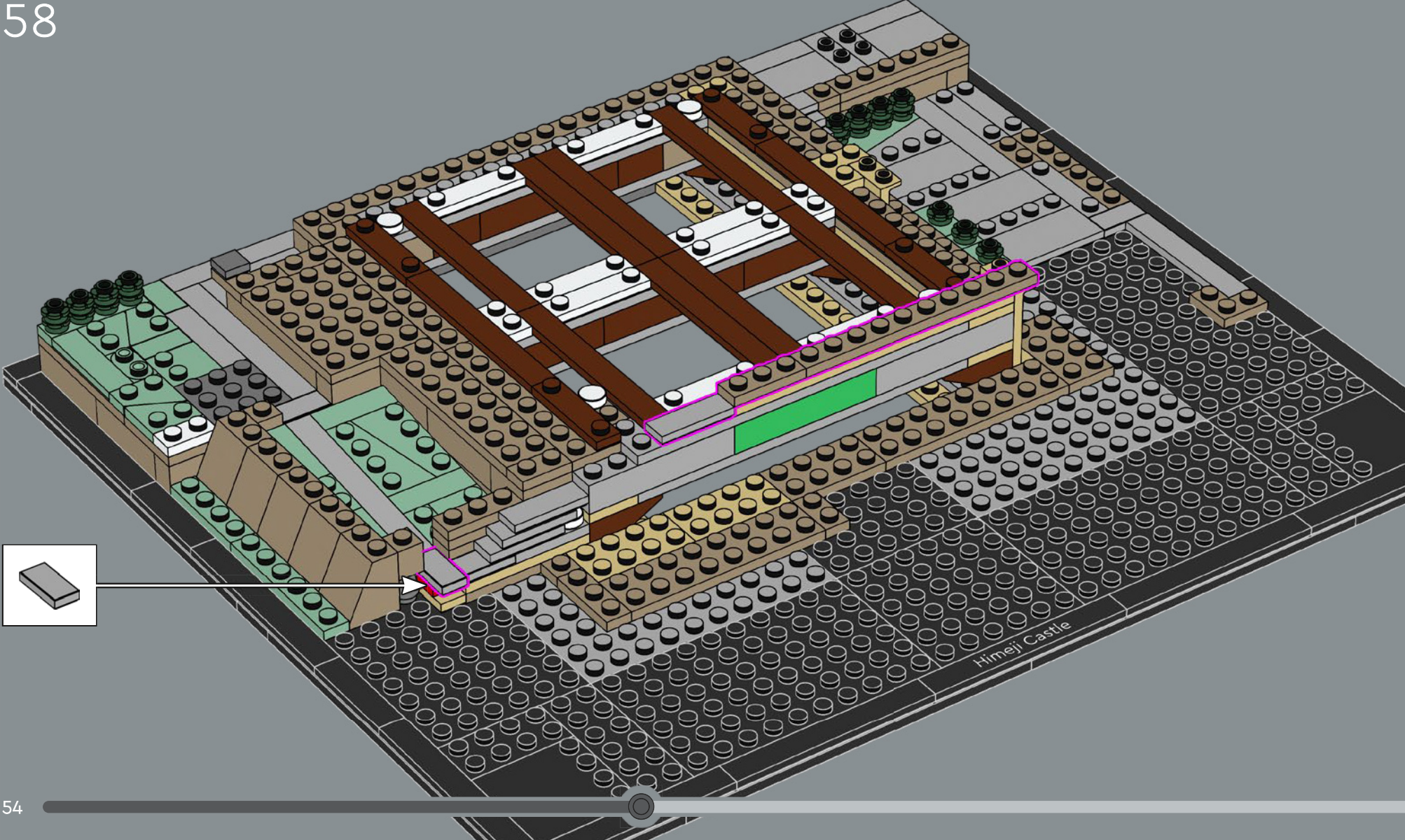

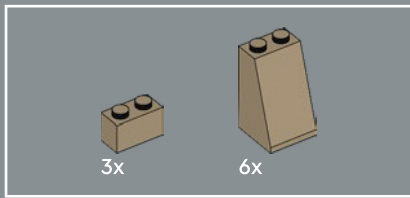

59

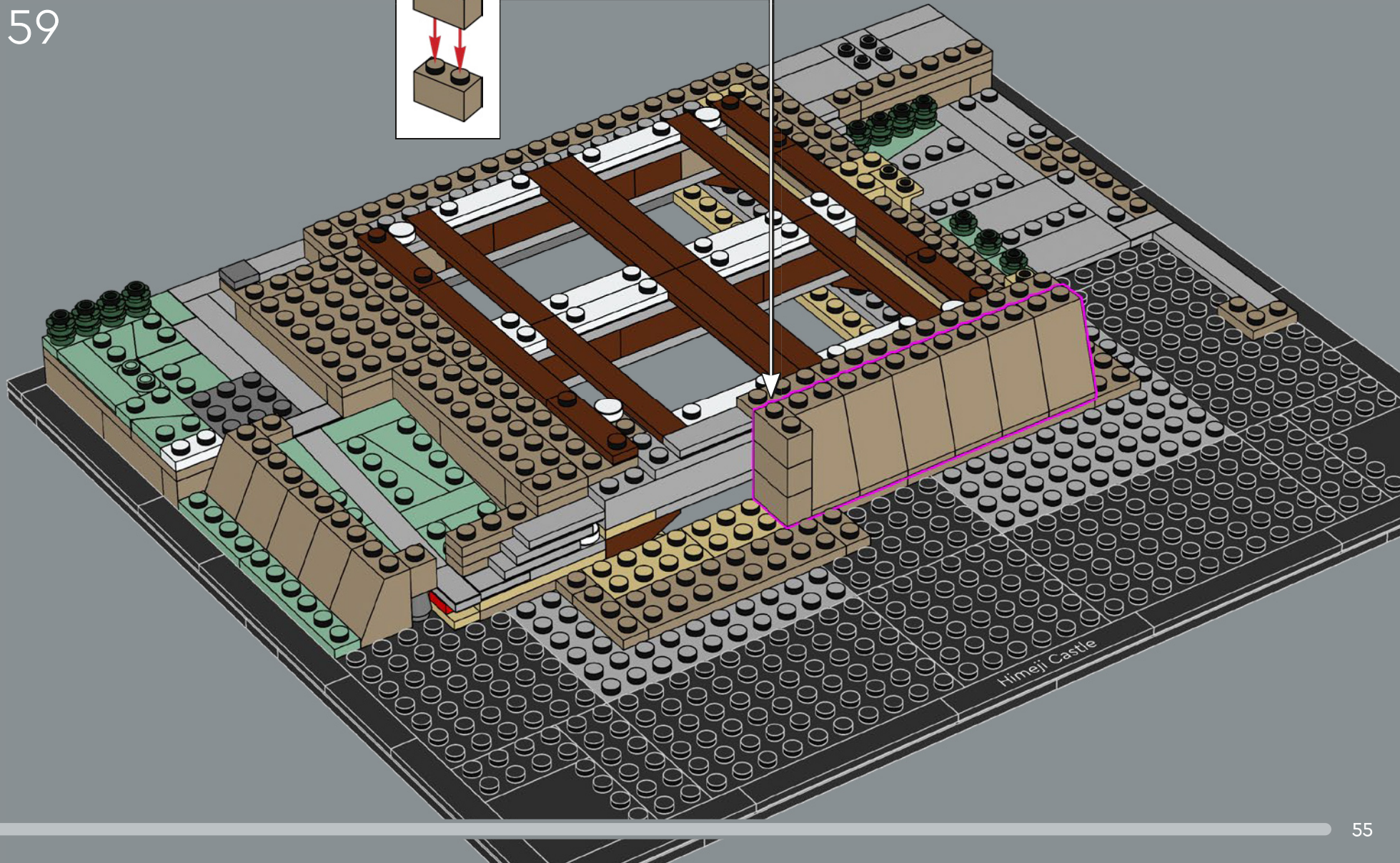
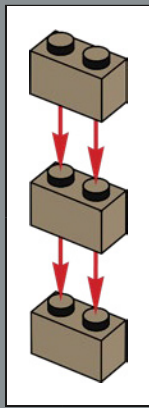

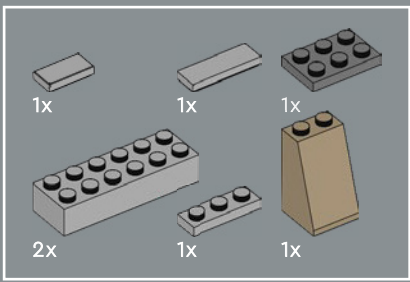

60

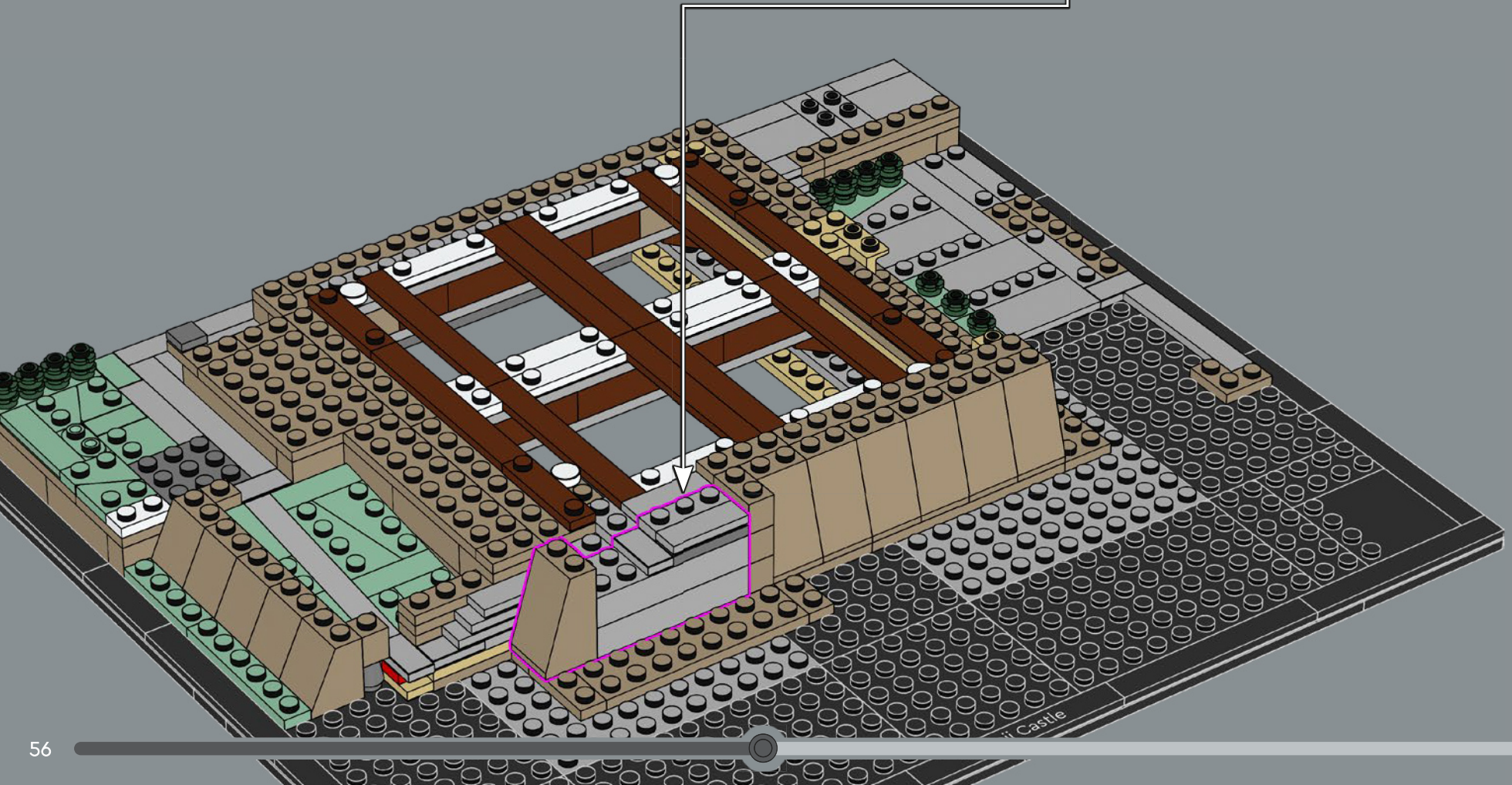
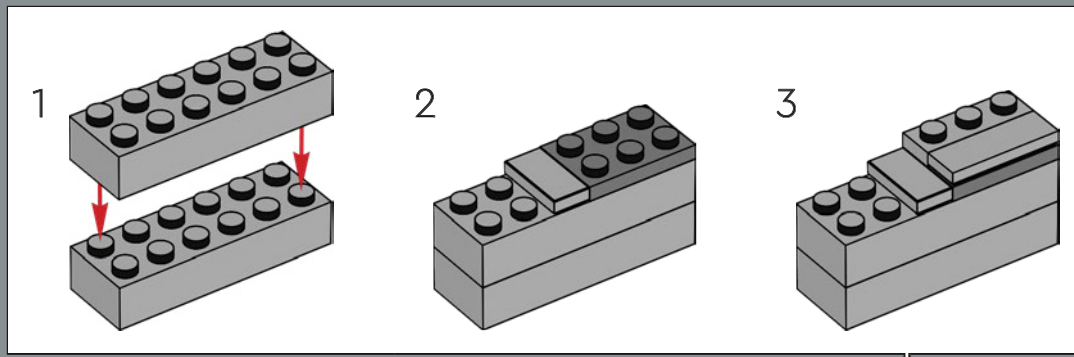

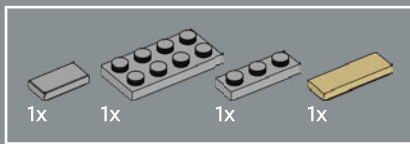

61

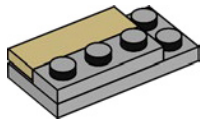
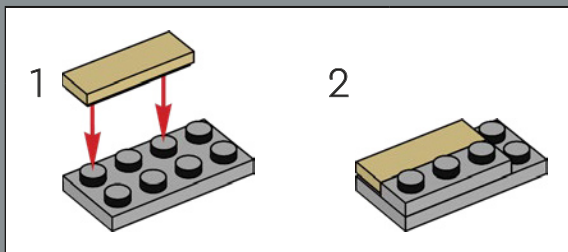
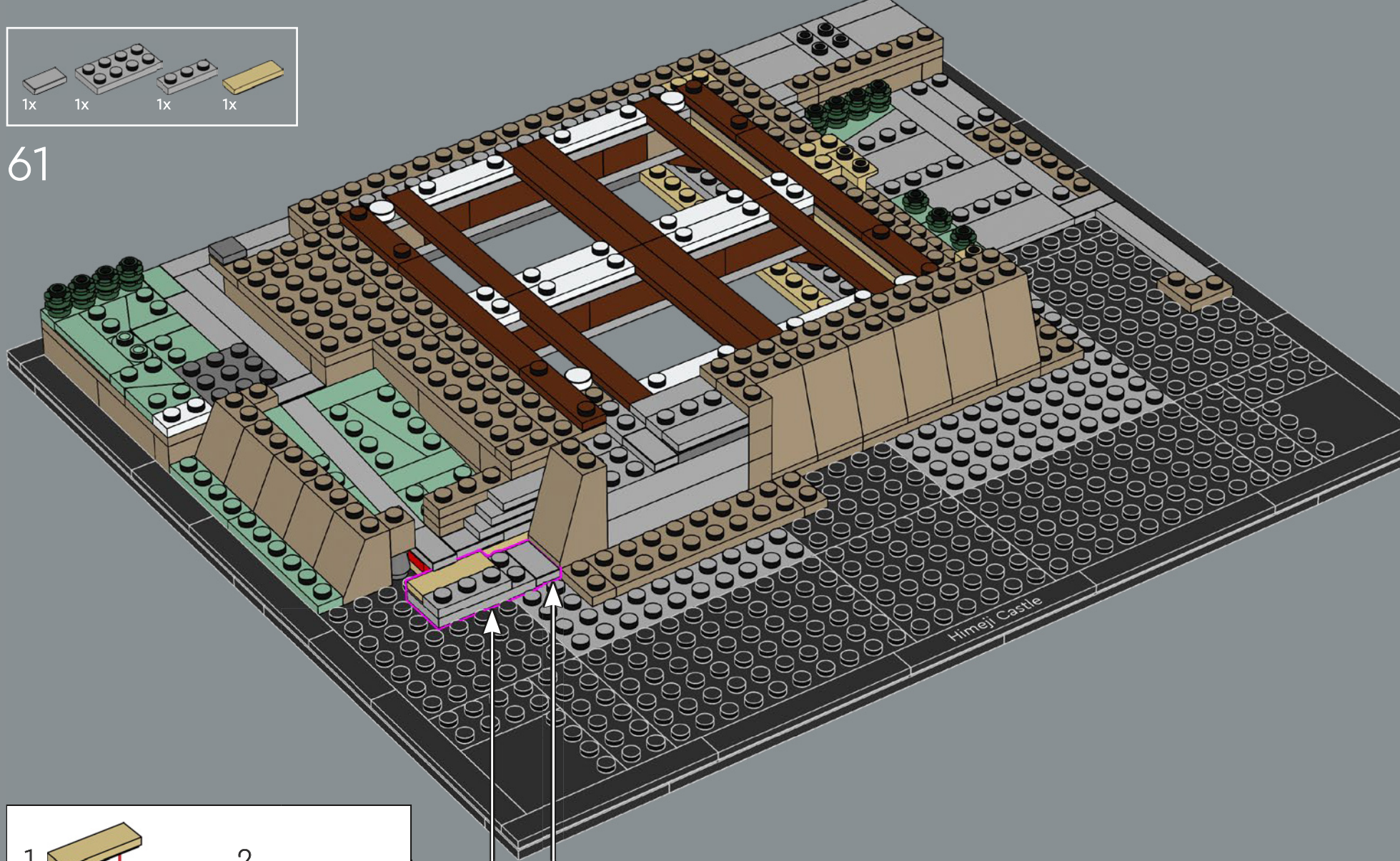

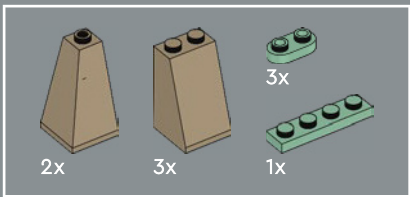

62

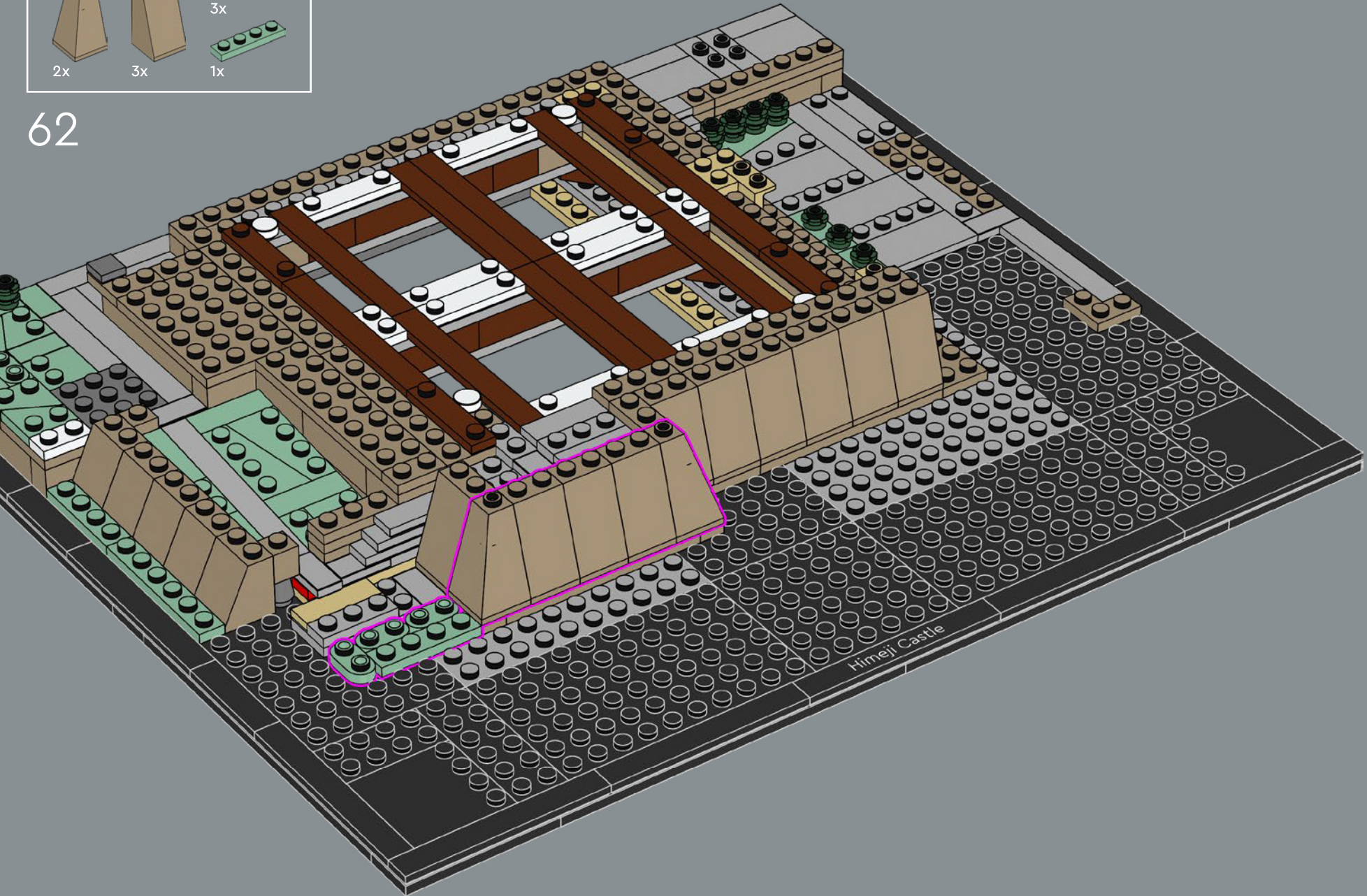

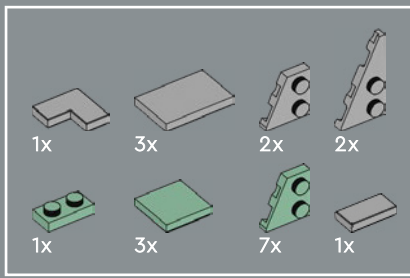

63

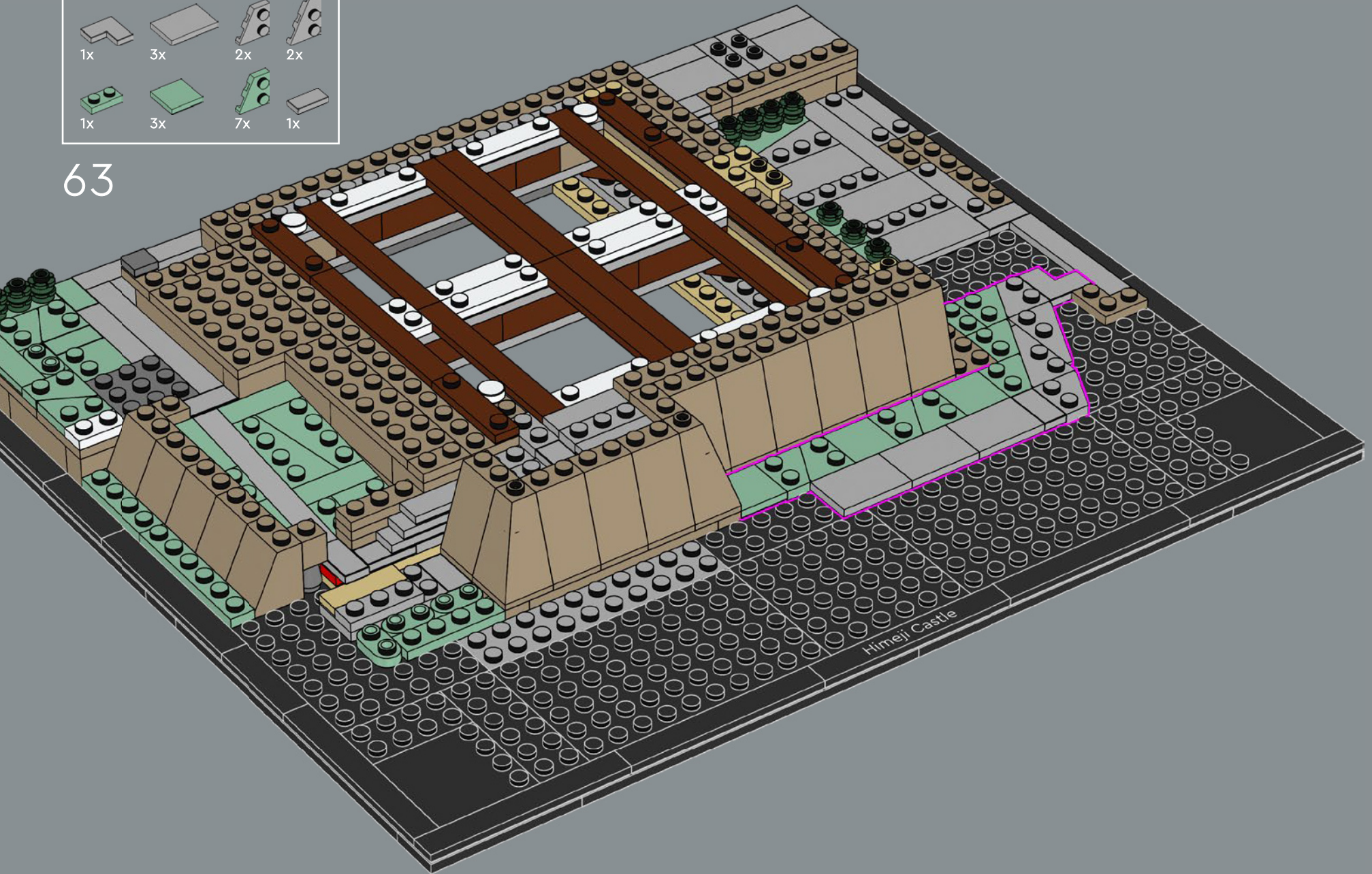

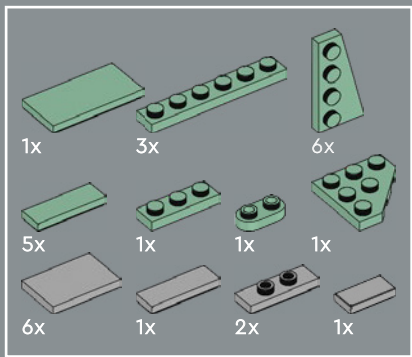

64

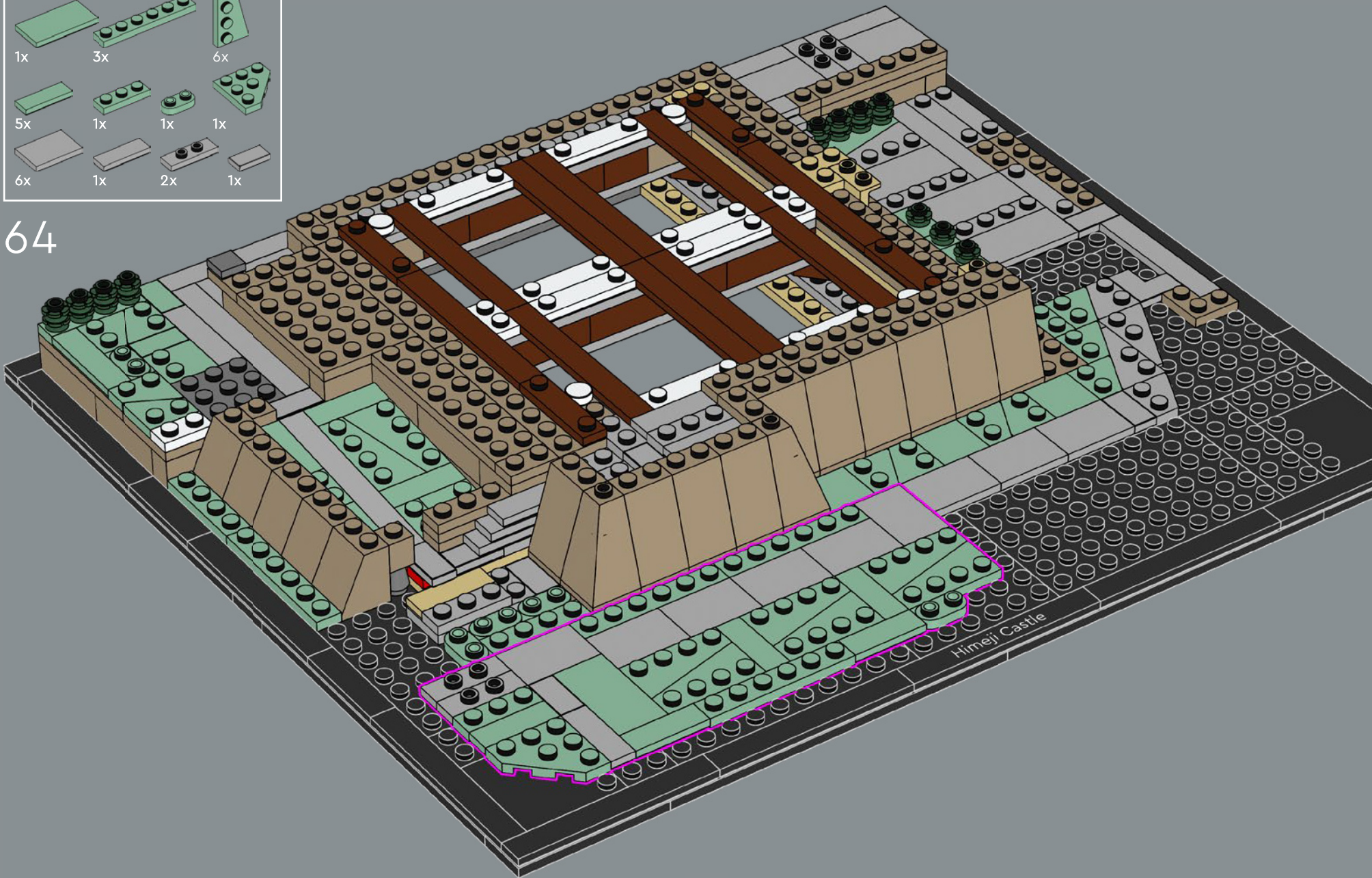

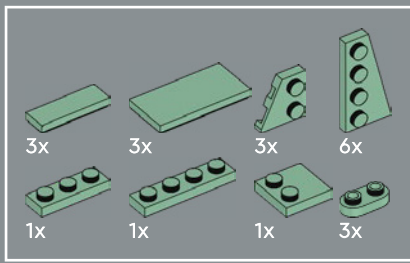

65

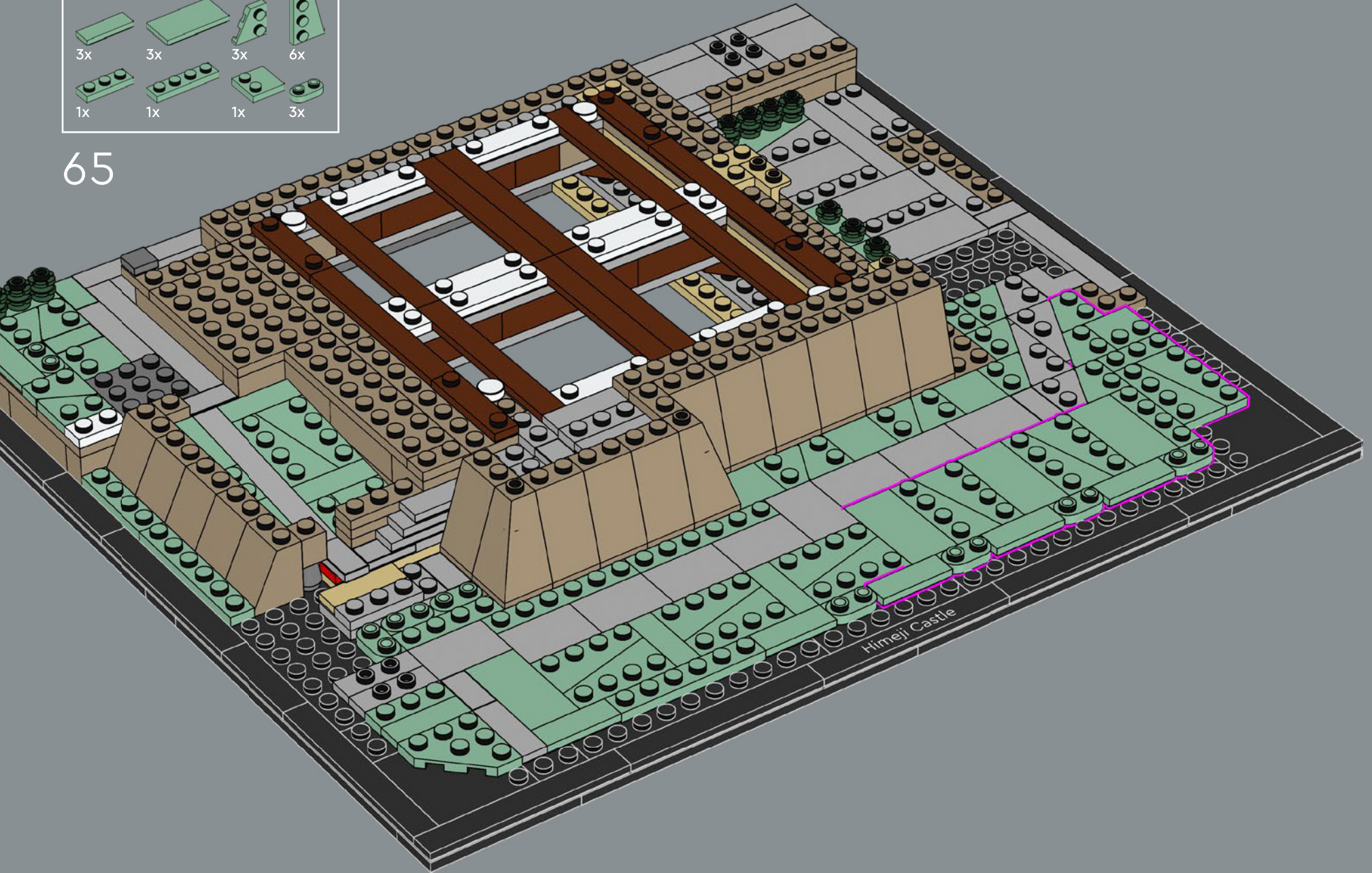

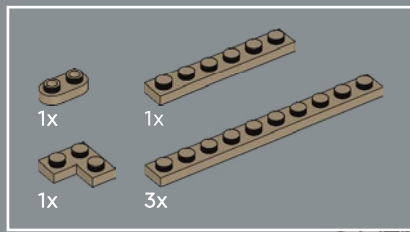

66

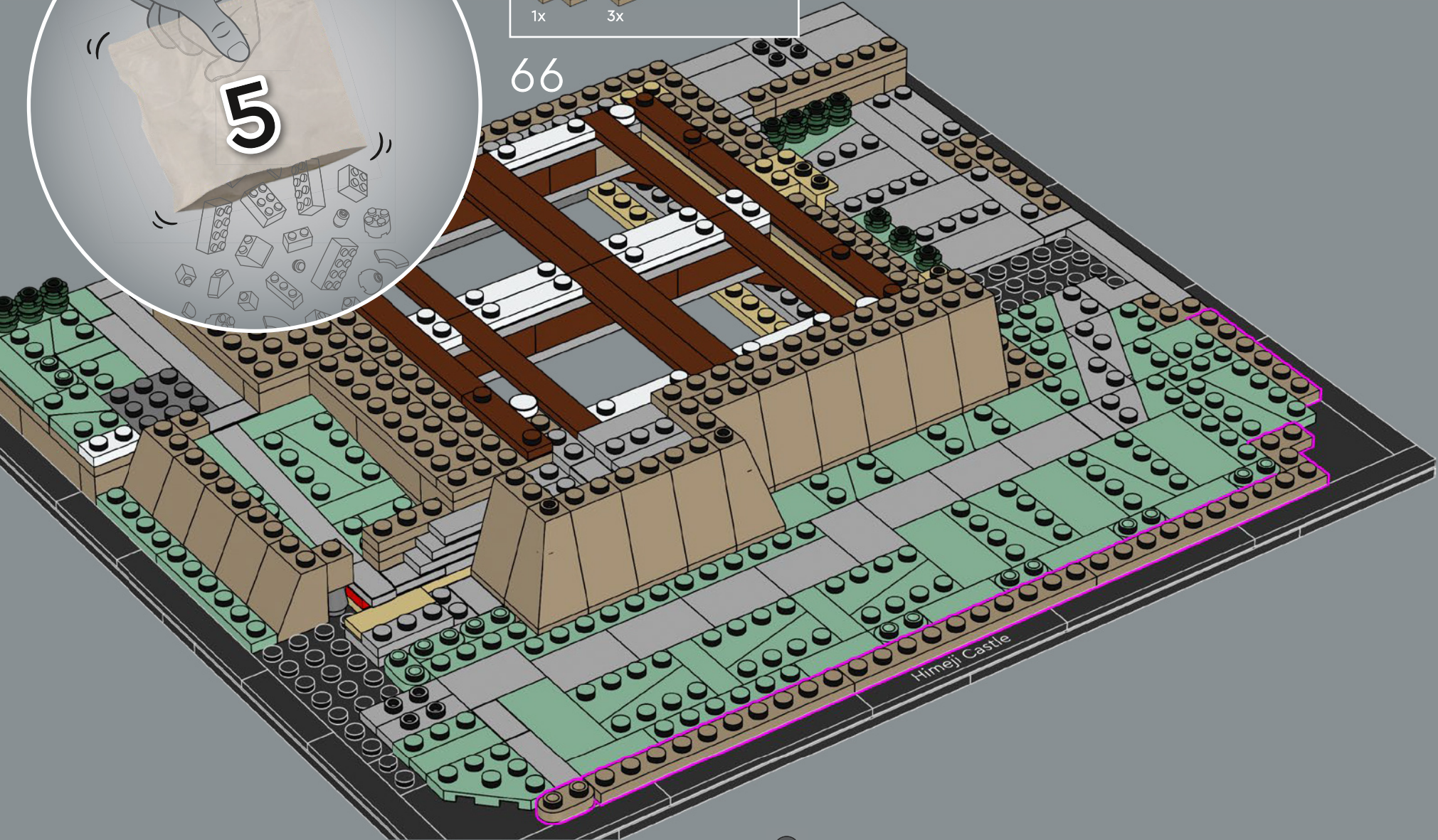

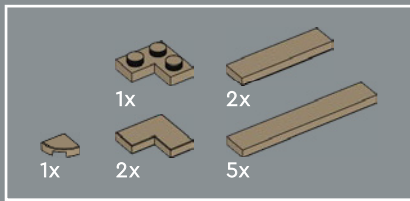

67

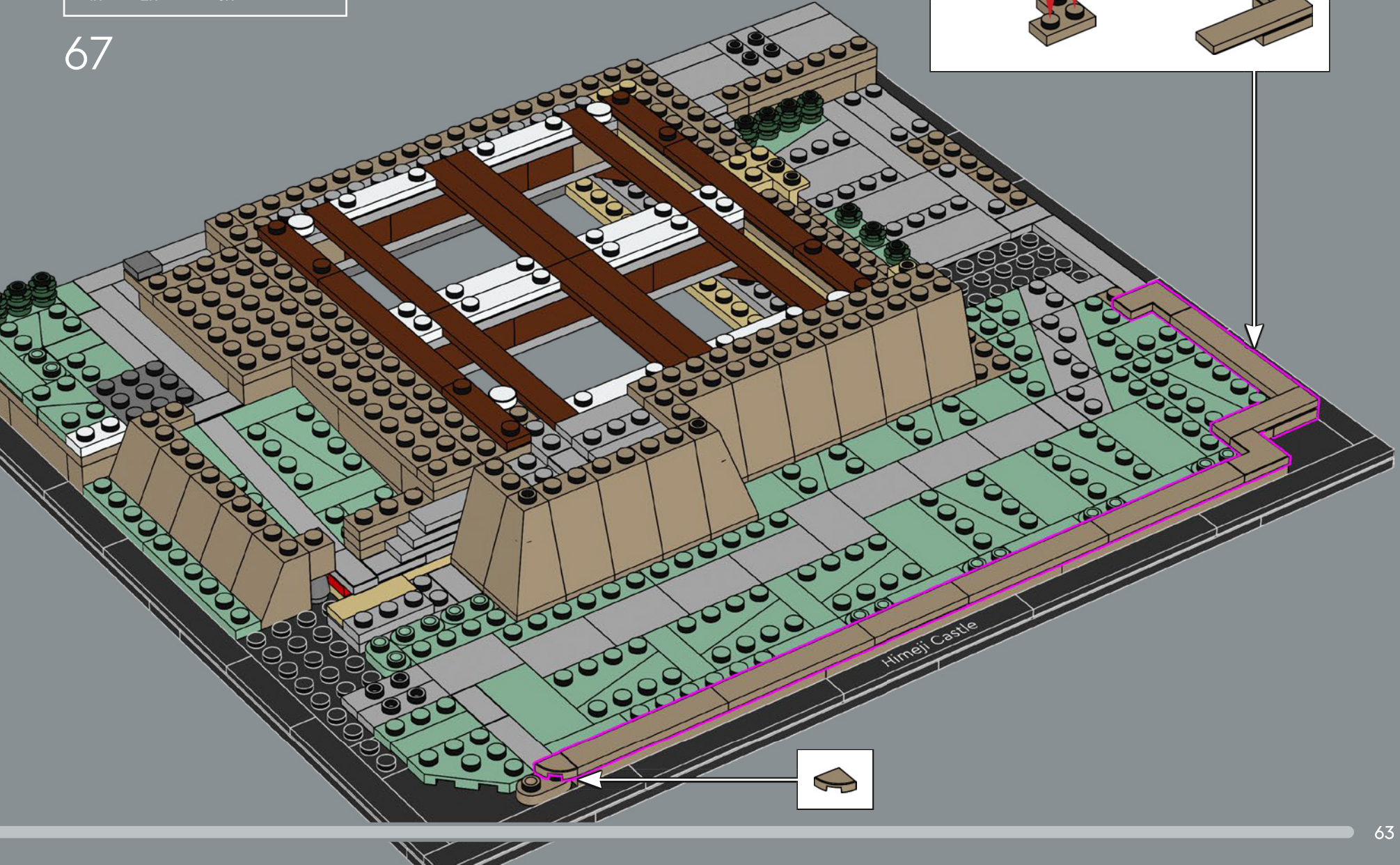
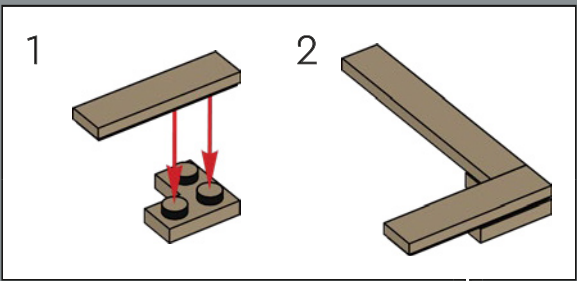

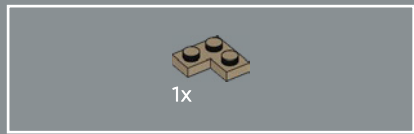

68

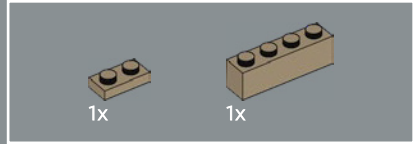
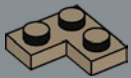

69

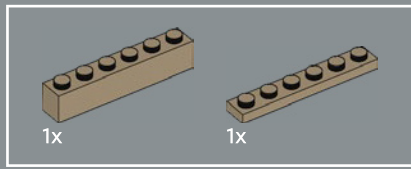
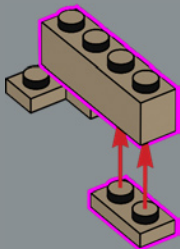

70

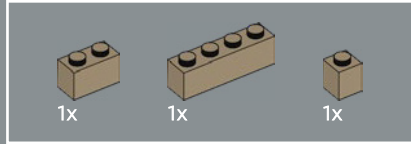
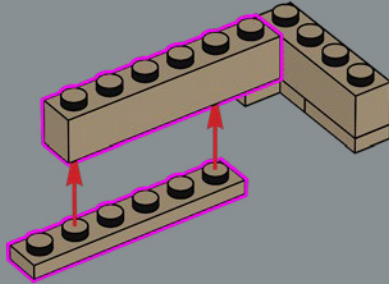

71

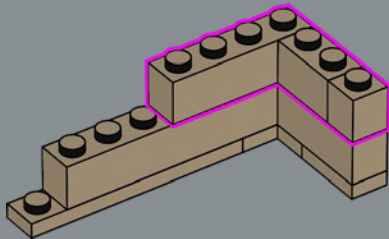

72

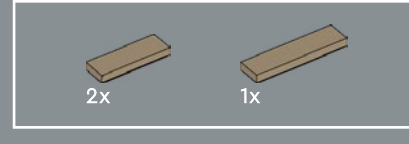
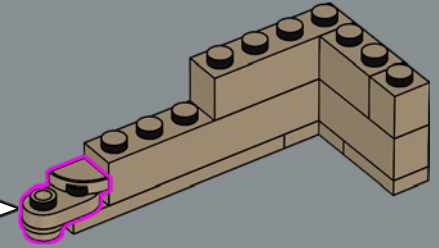
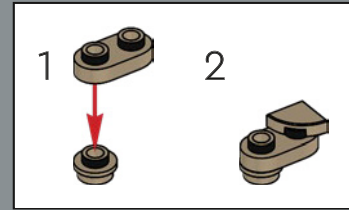

73

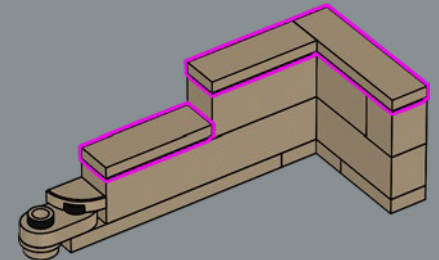

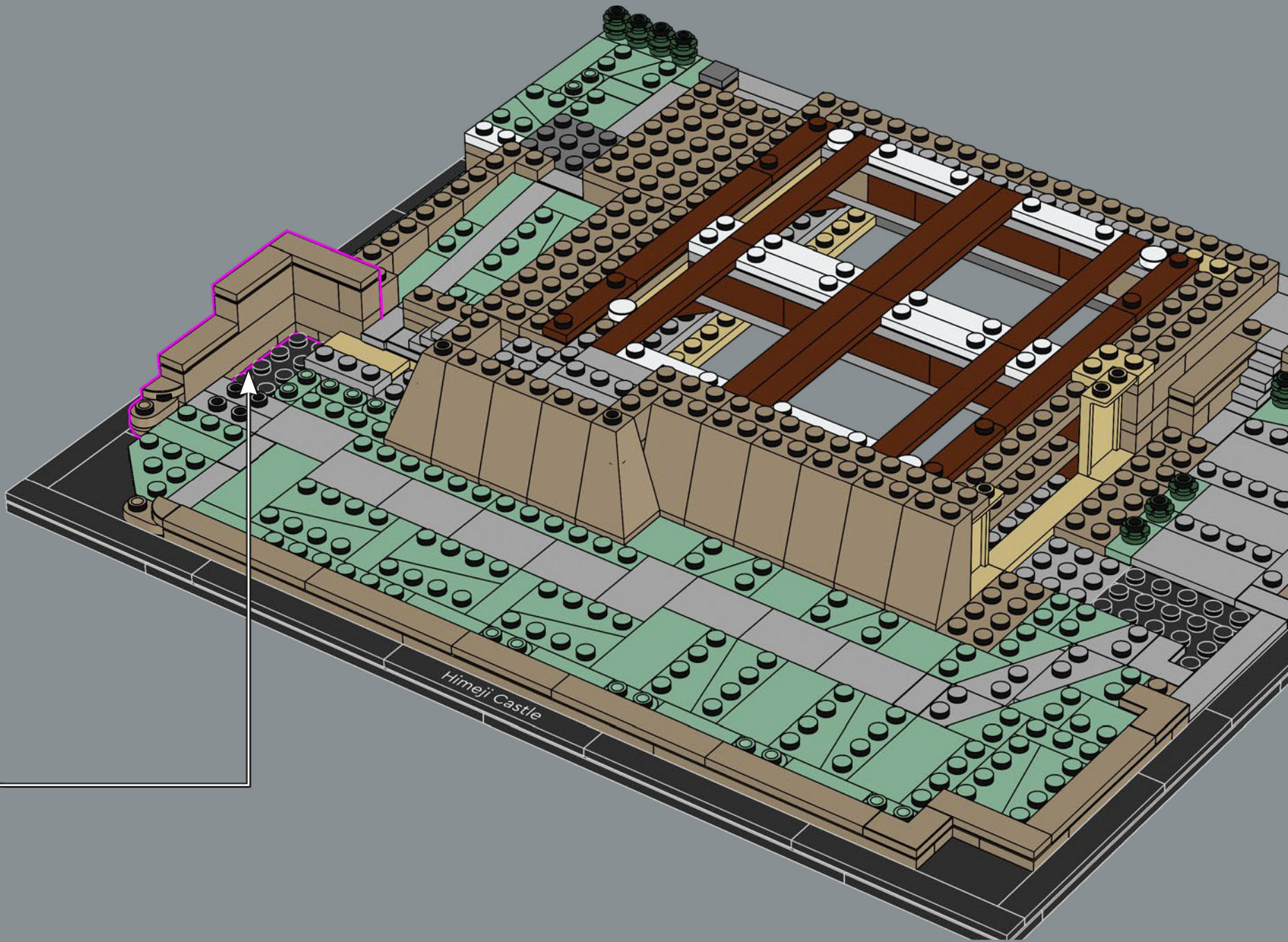

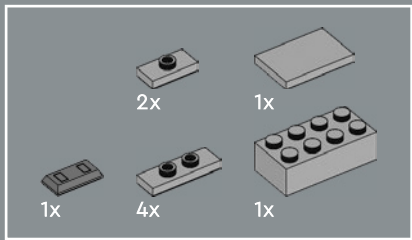

75

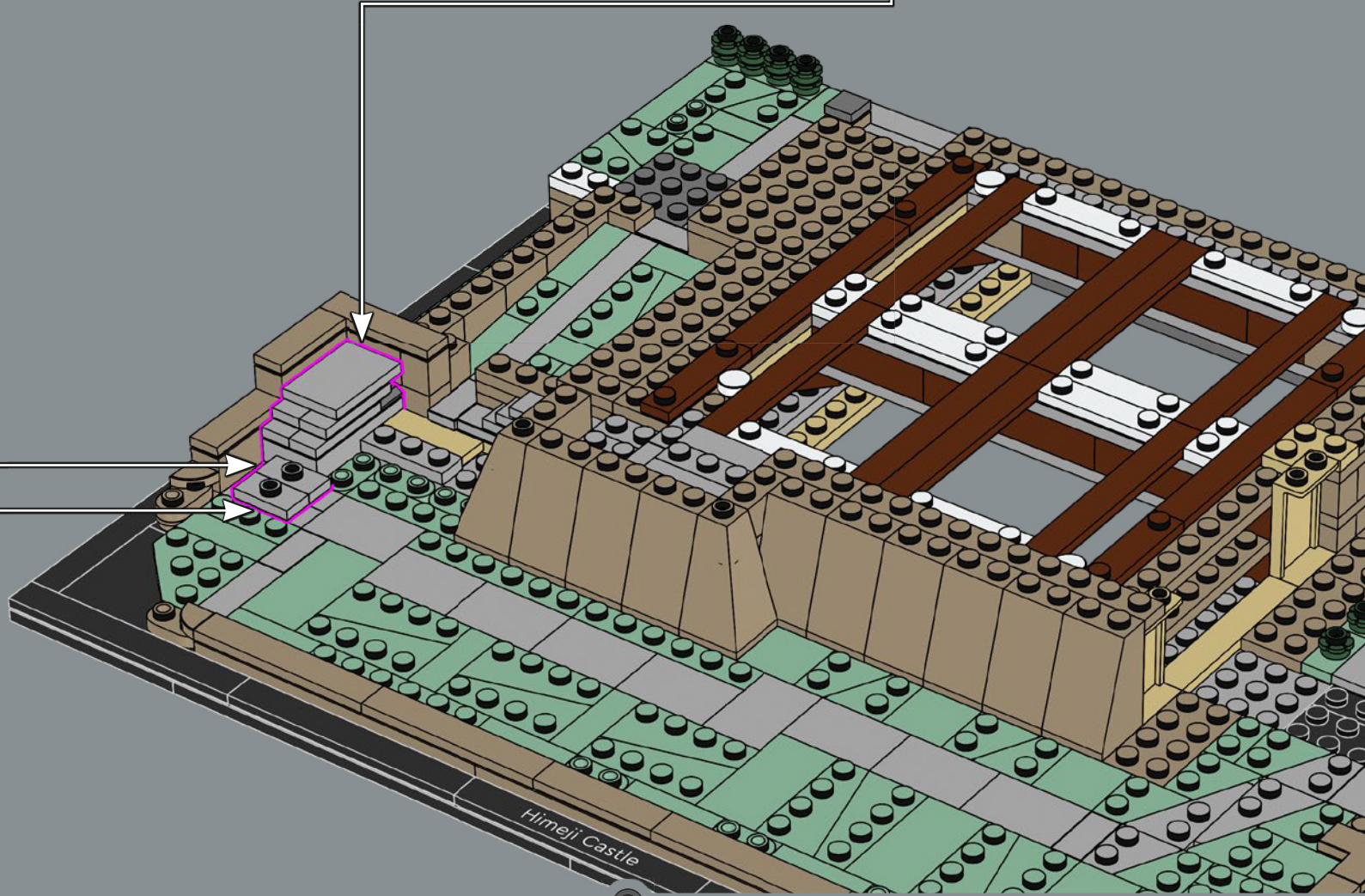
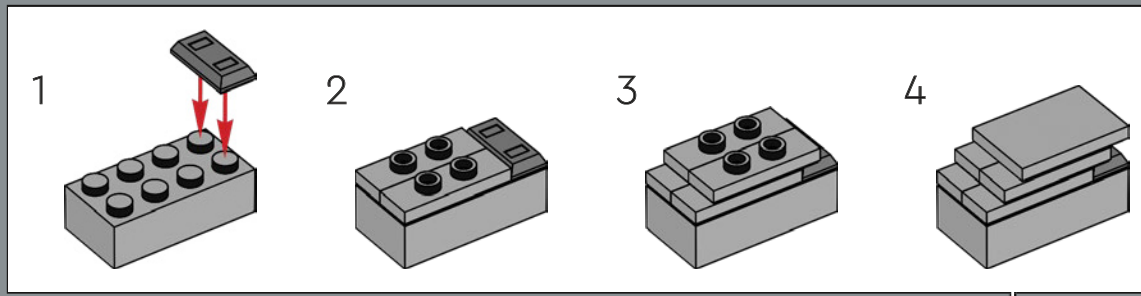

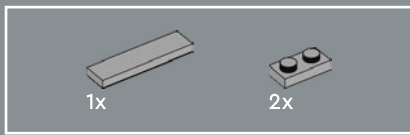

76

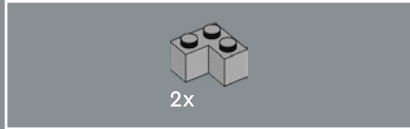
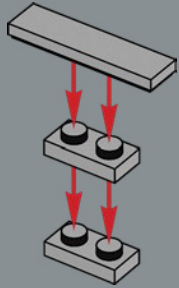

77

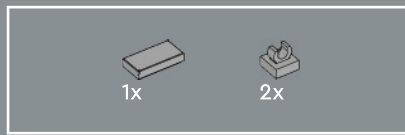
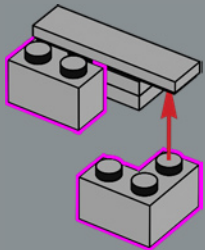

78

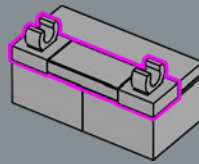

79

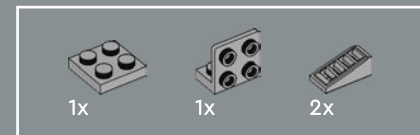
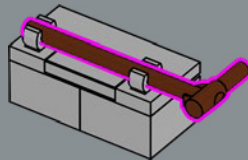

80

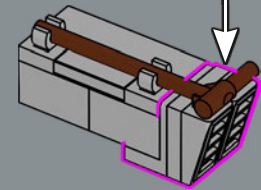
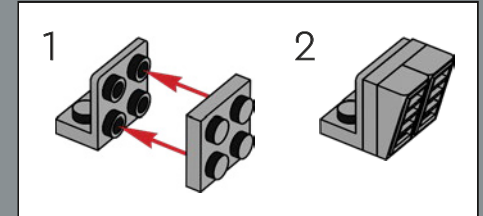

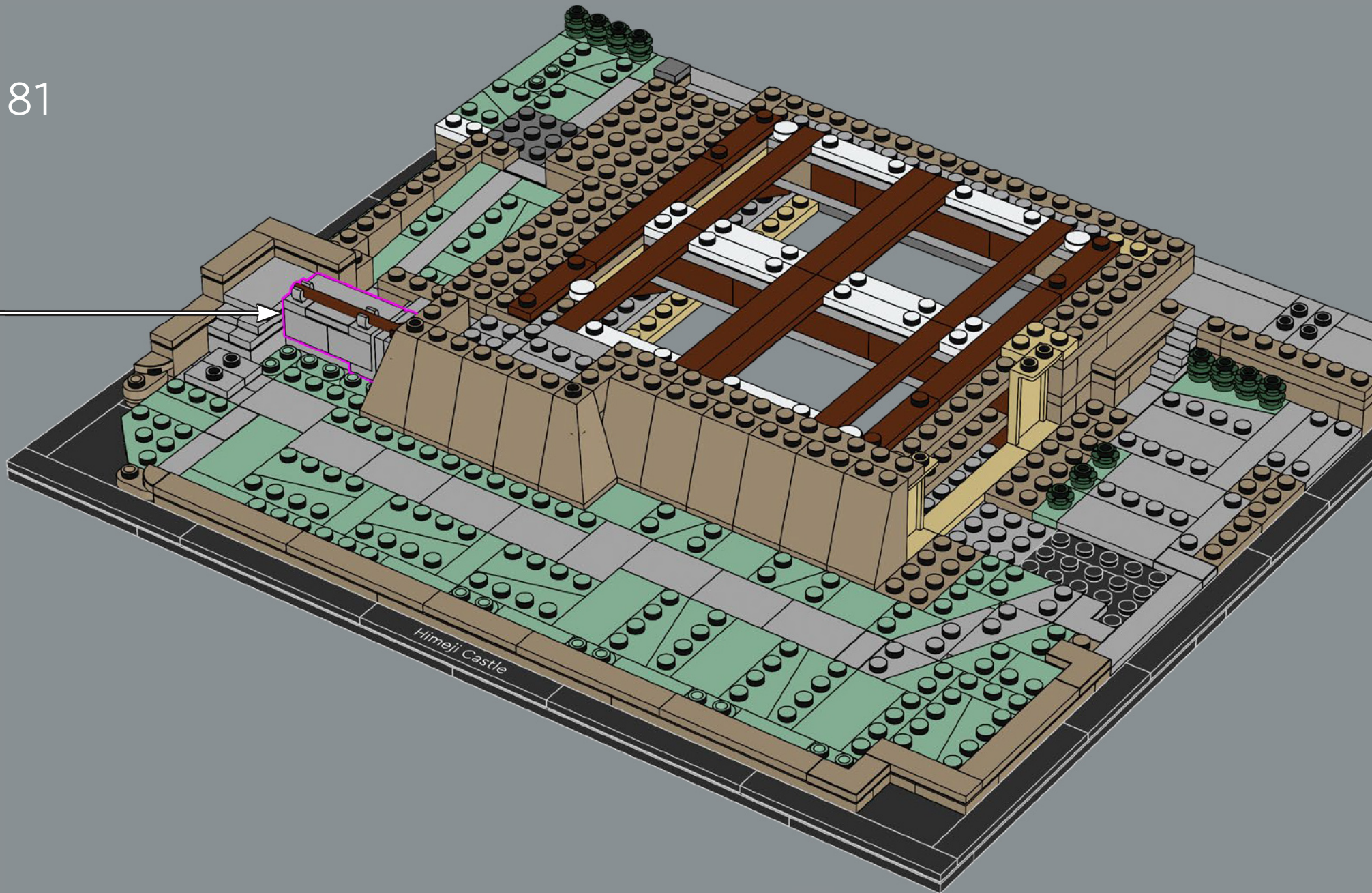

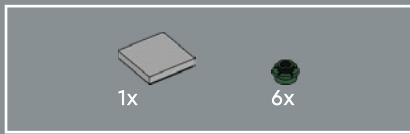

82

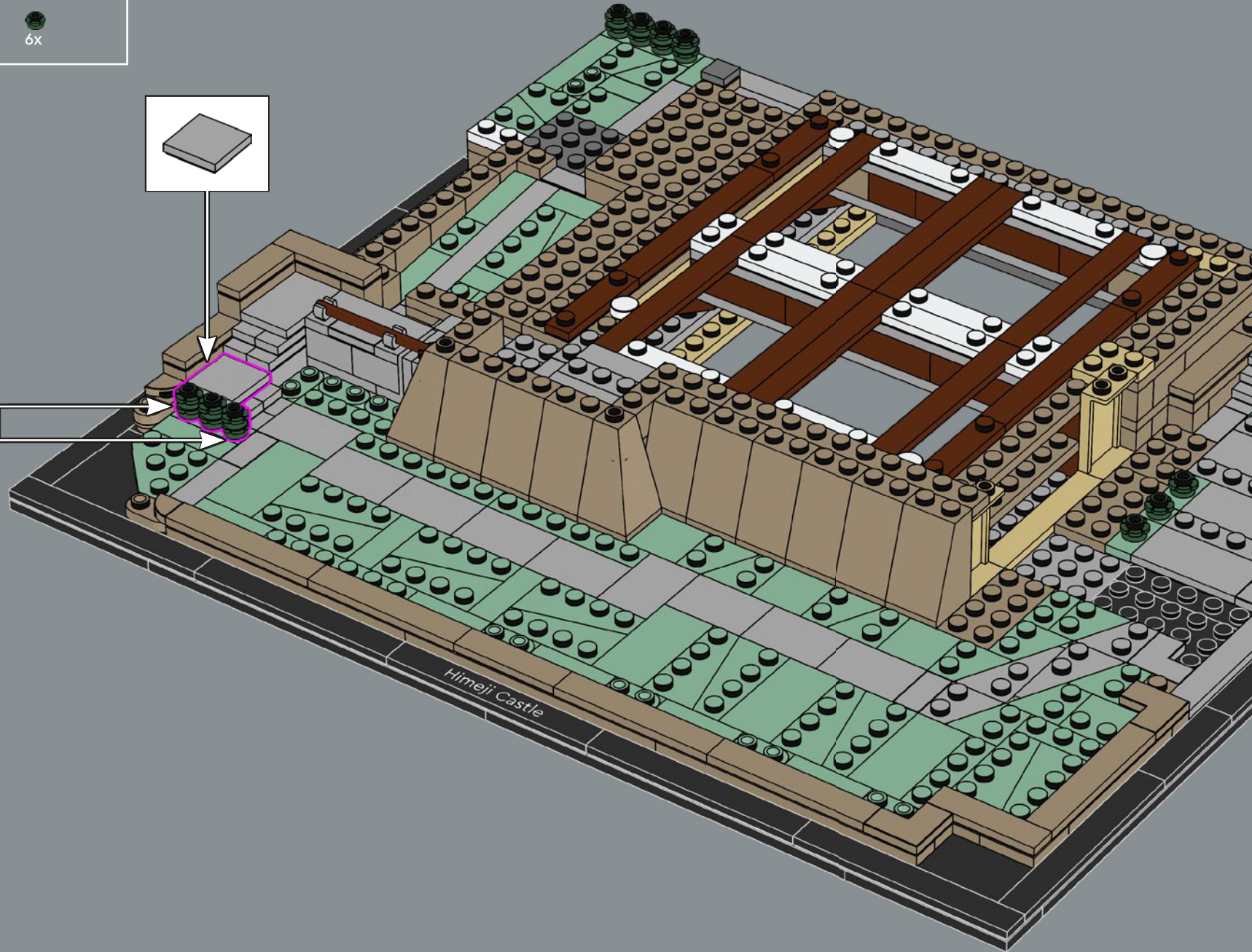
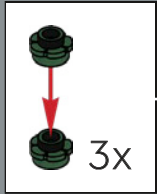

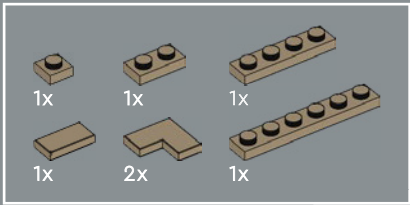

83

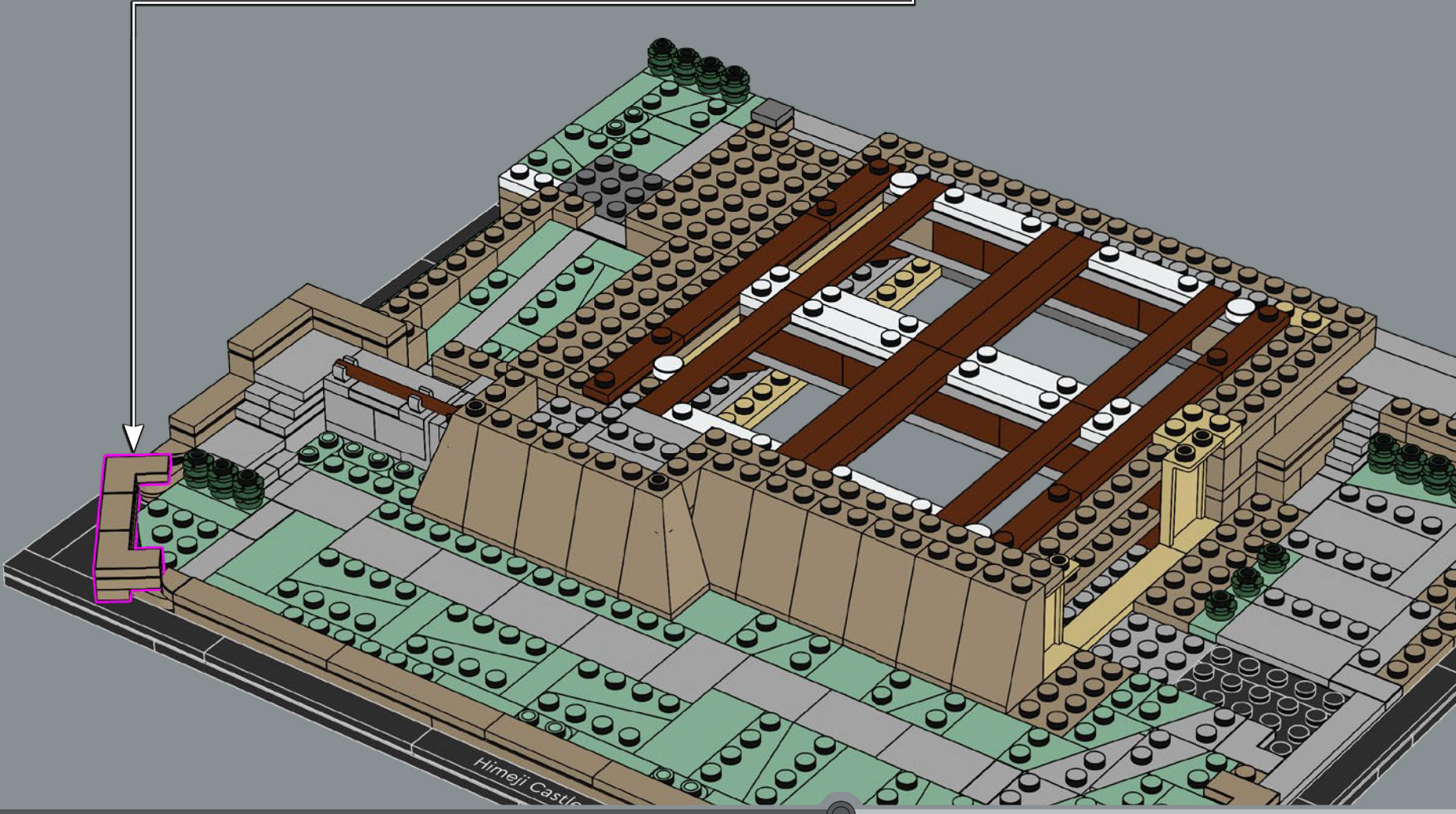
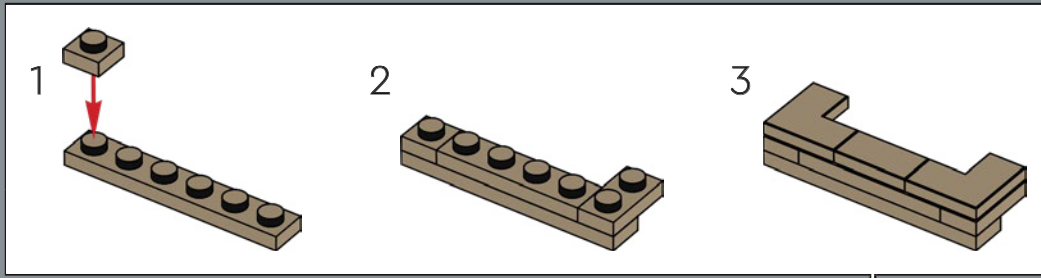

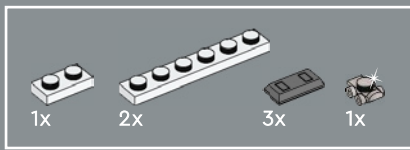

84

1

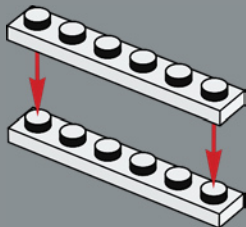

2

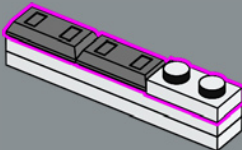

3

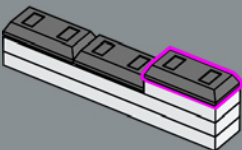

4



1:1

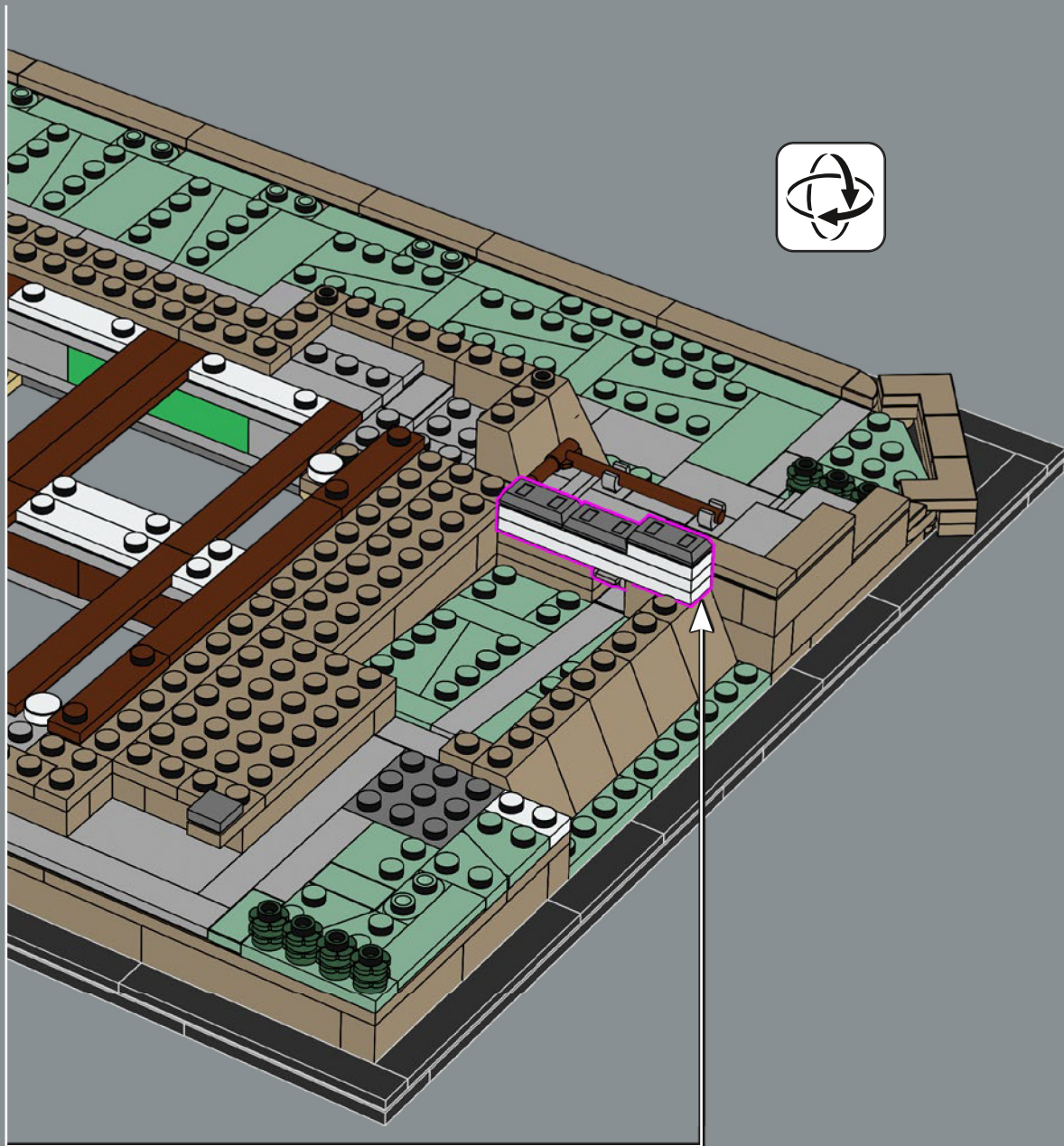

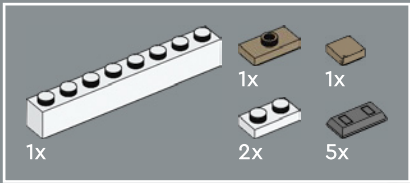

85

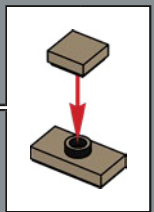
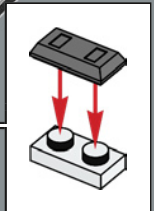
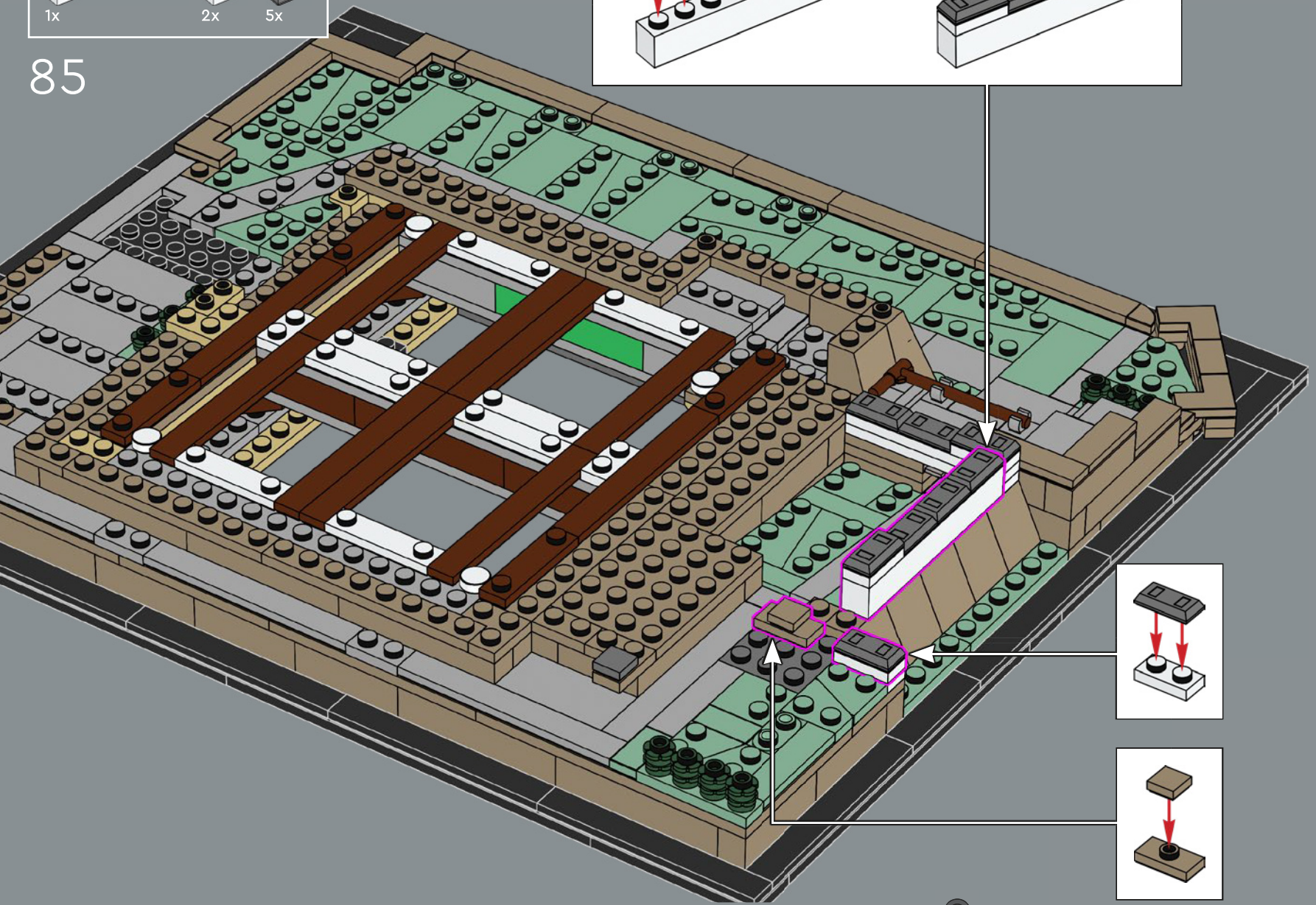
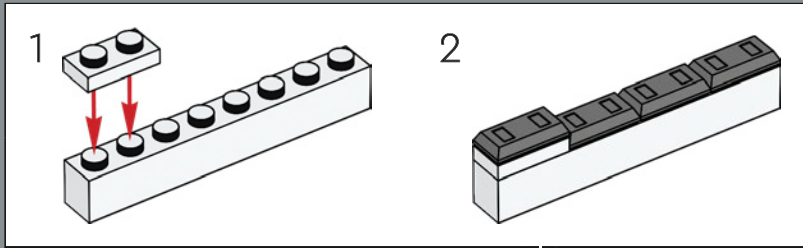

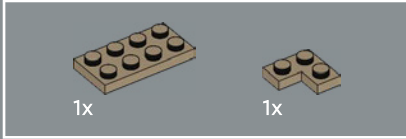
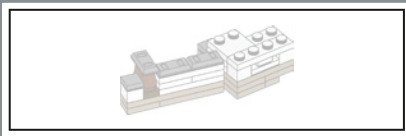

86

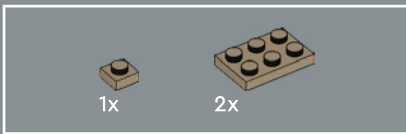
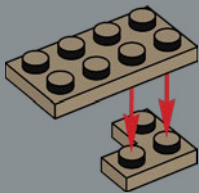

87

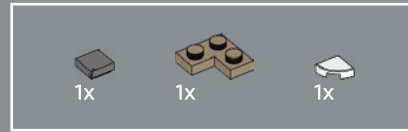
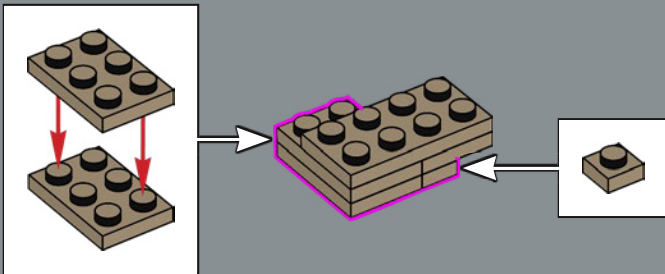

88

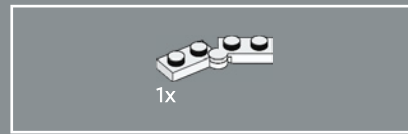
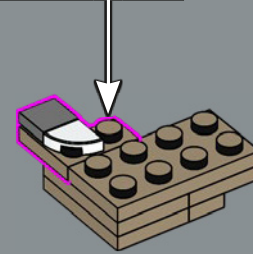
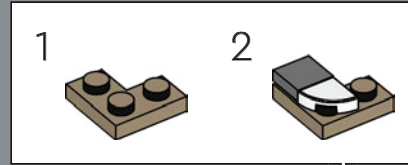

89

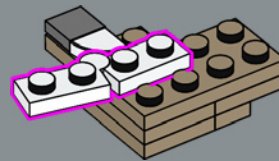

90

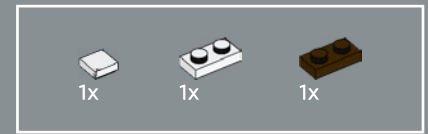
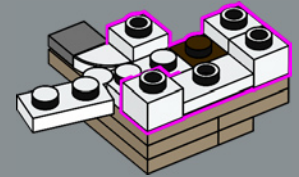

91

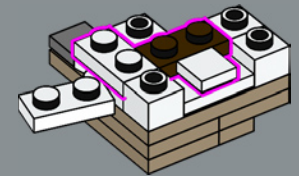

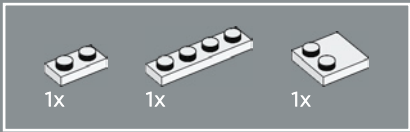

92

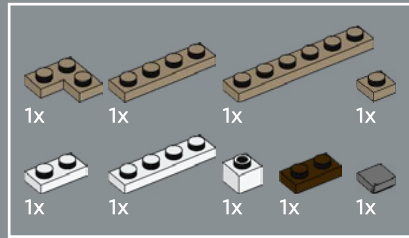
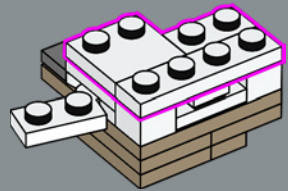

93

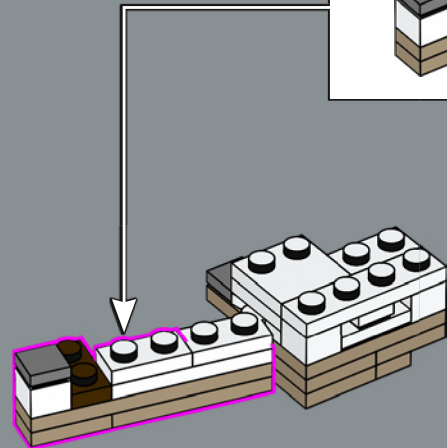
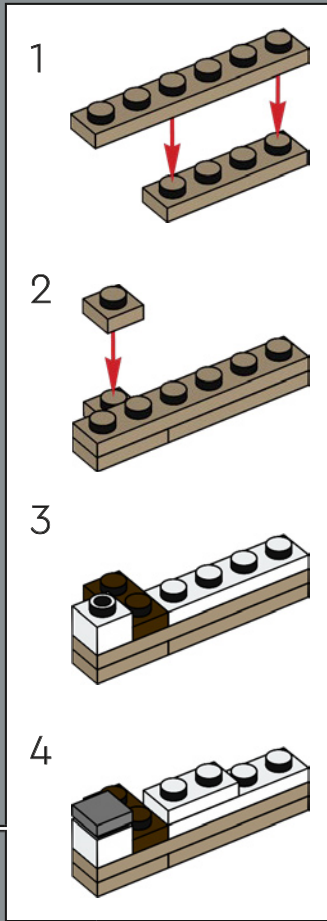

94

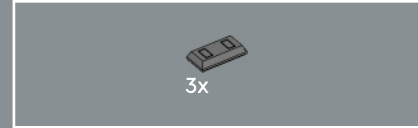
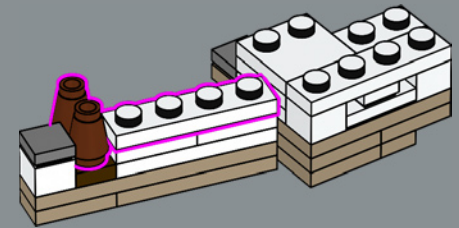

95

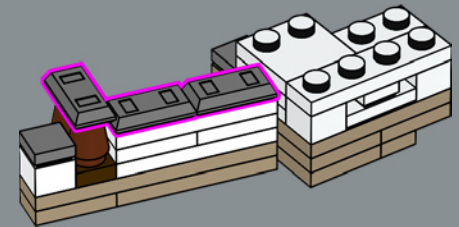

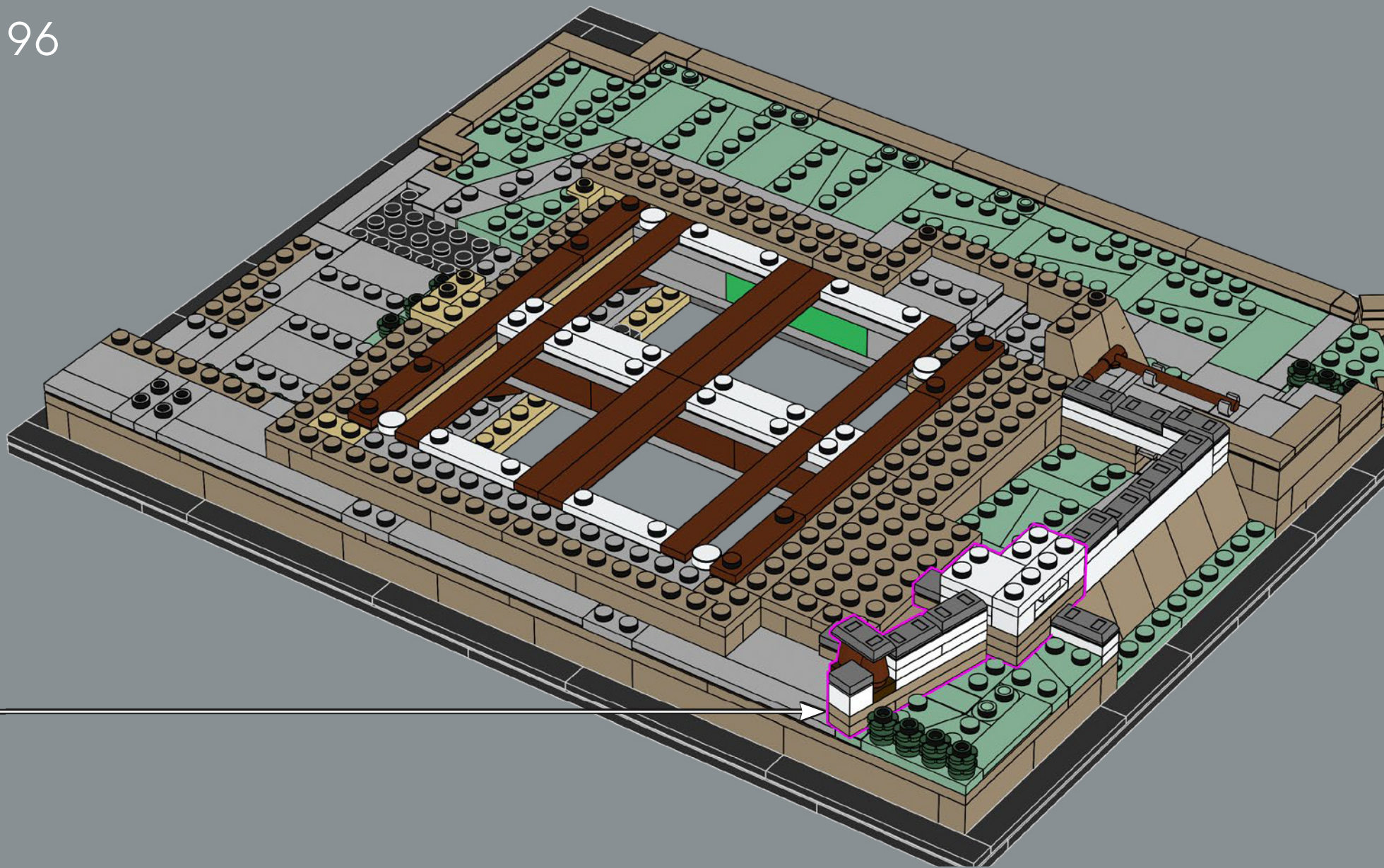

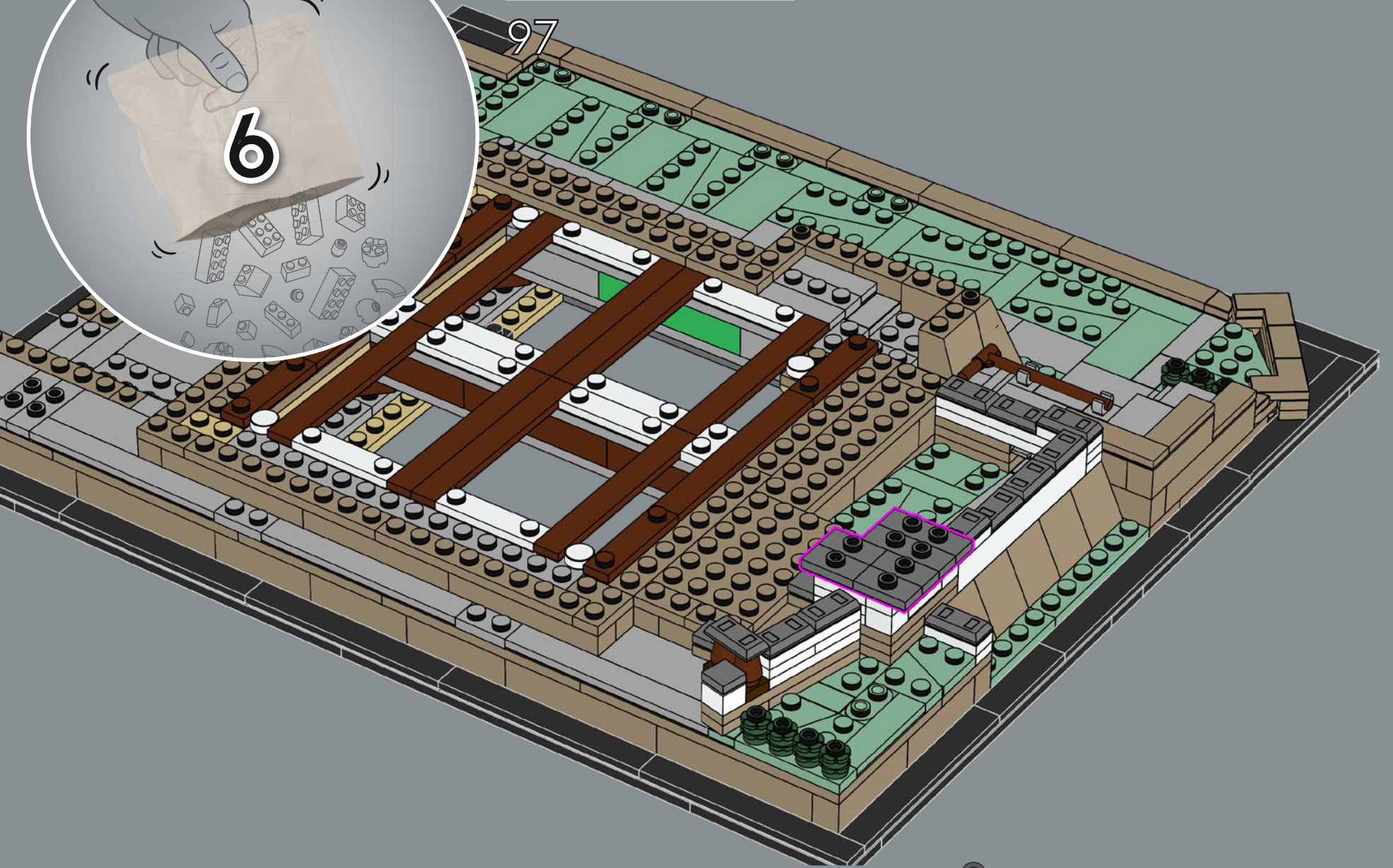
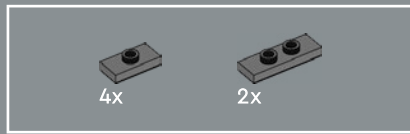

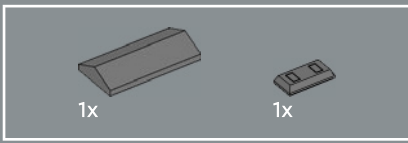

98

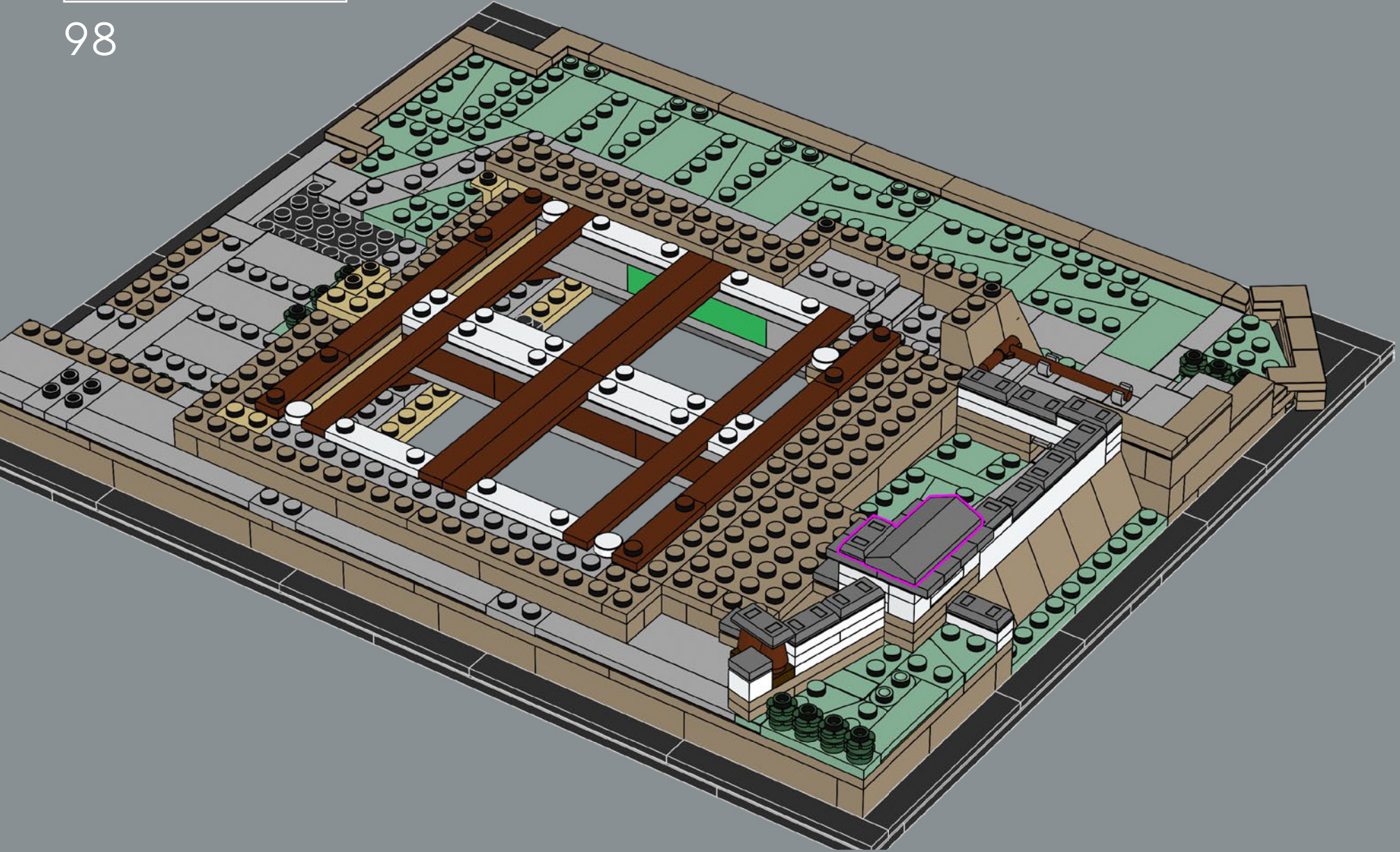

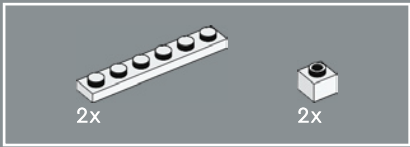

99

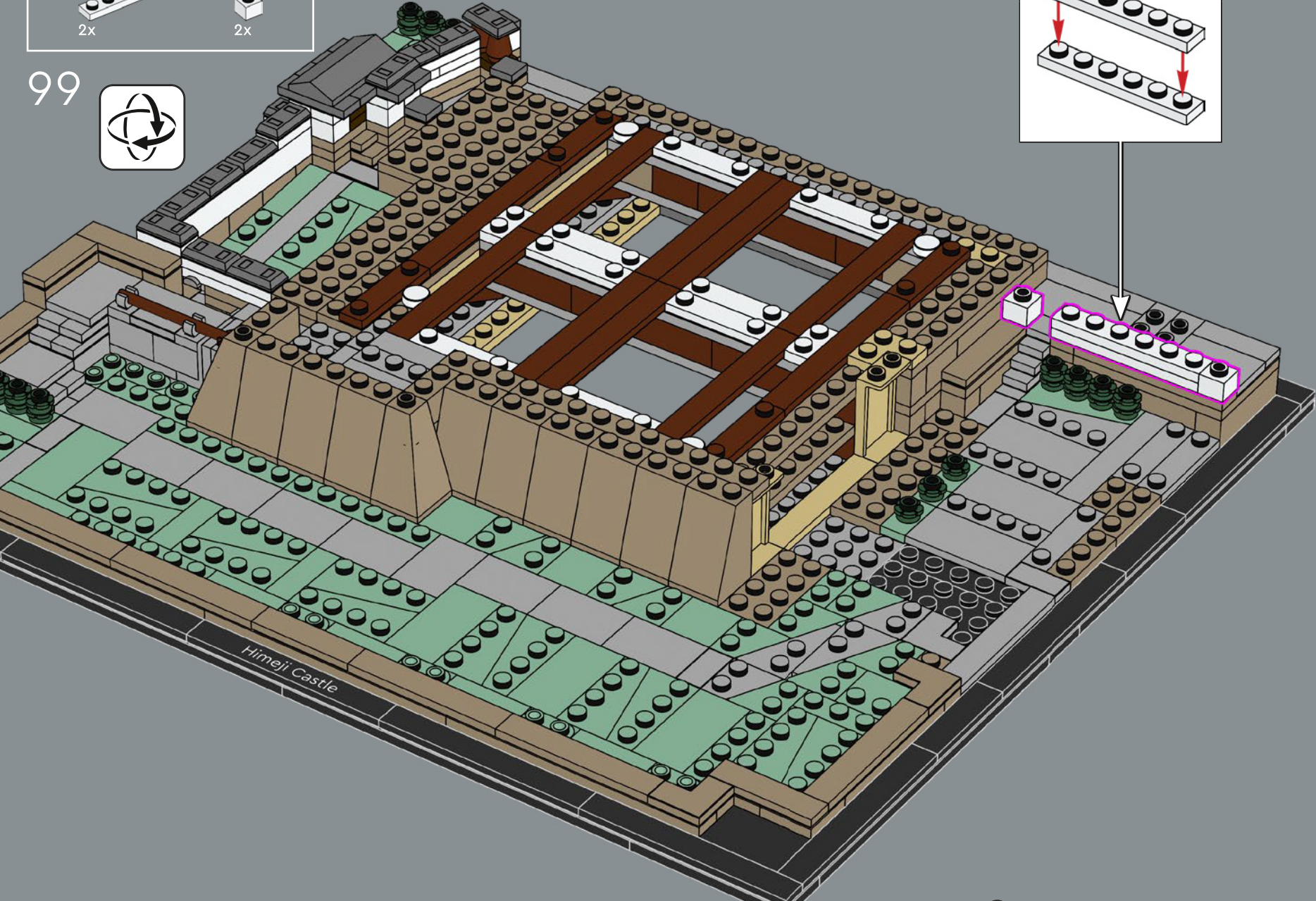
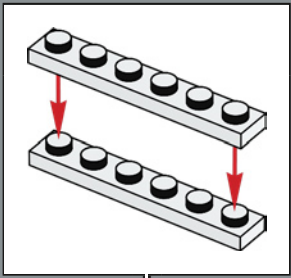

Himeji Castle



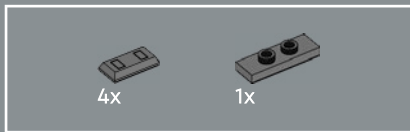

100

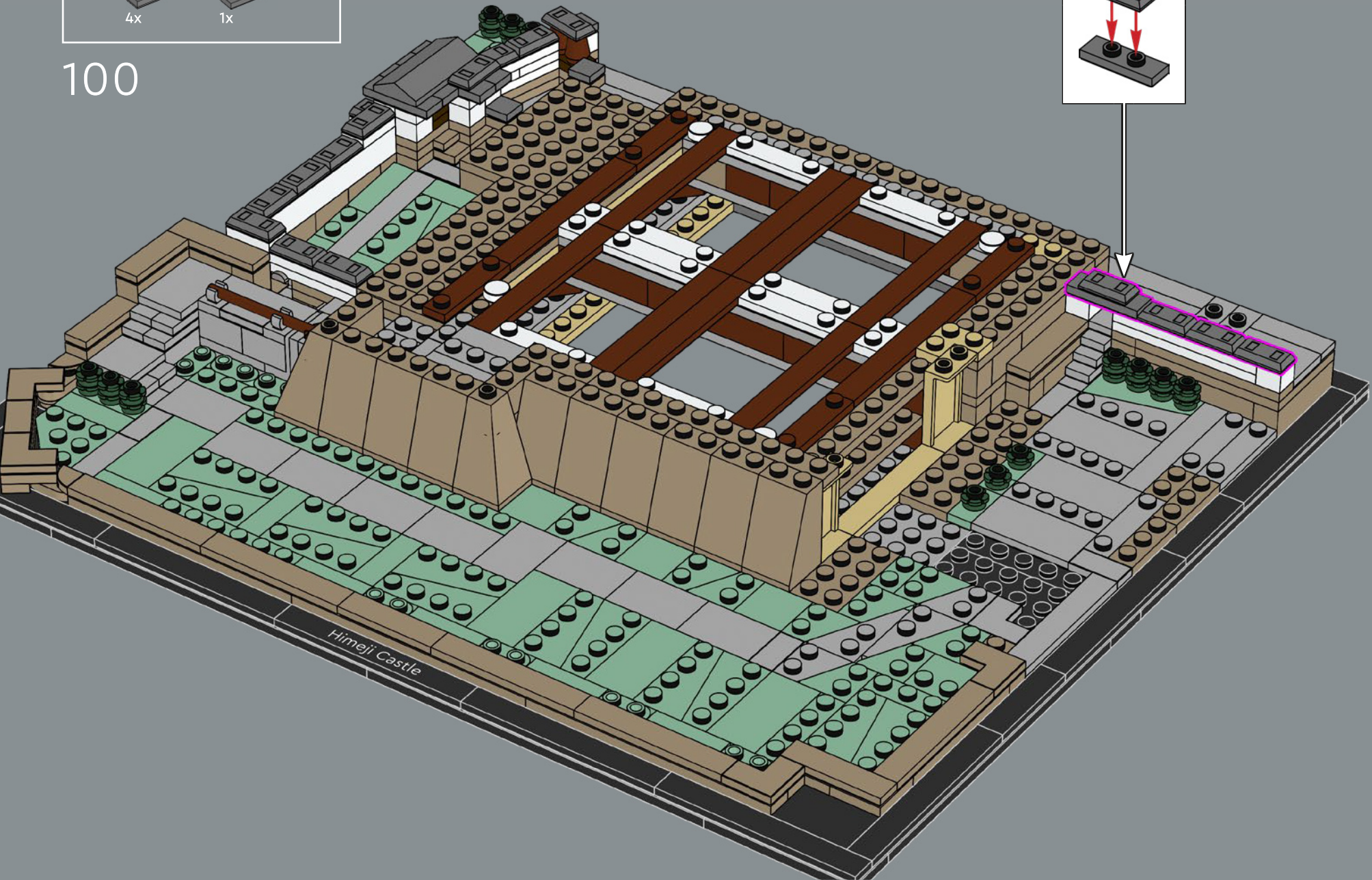
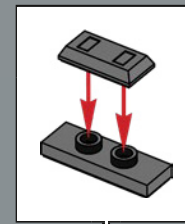

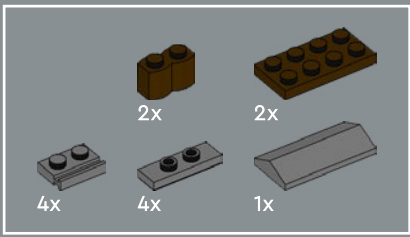

101

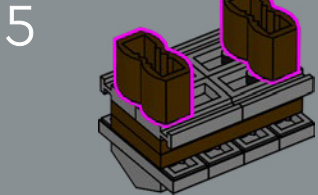
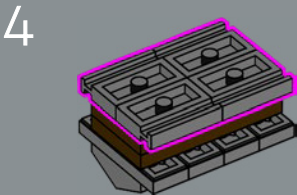
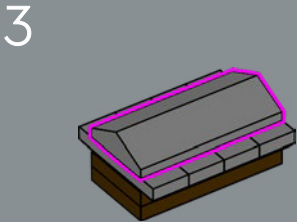
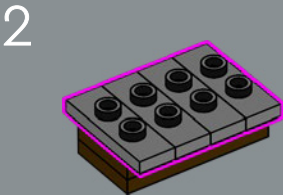
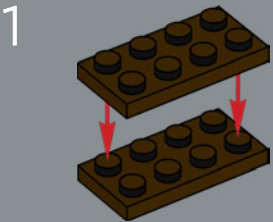

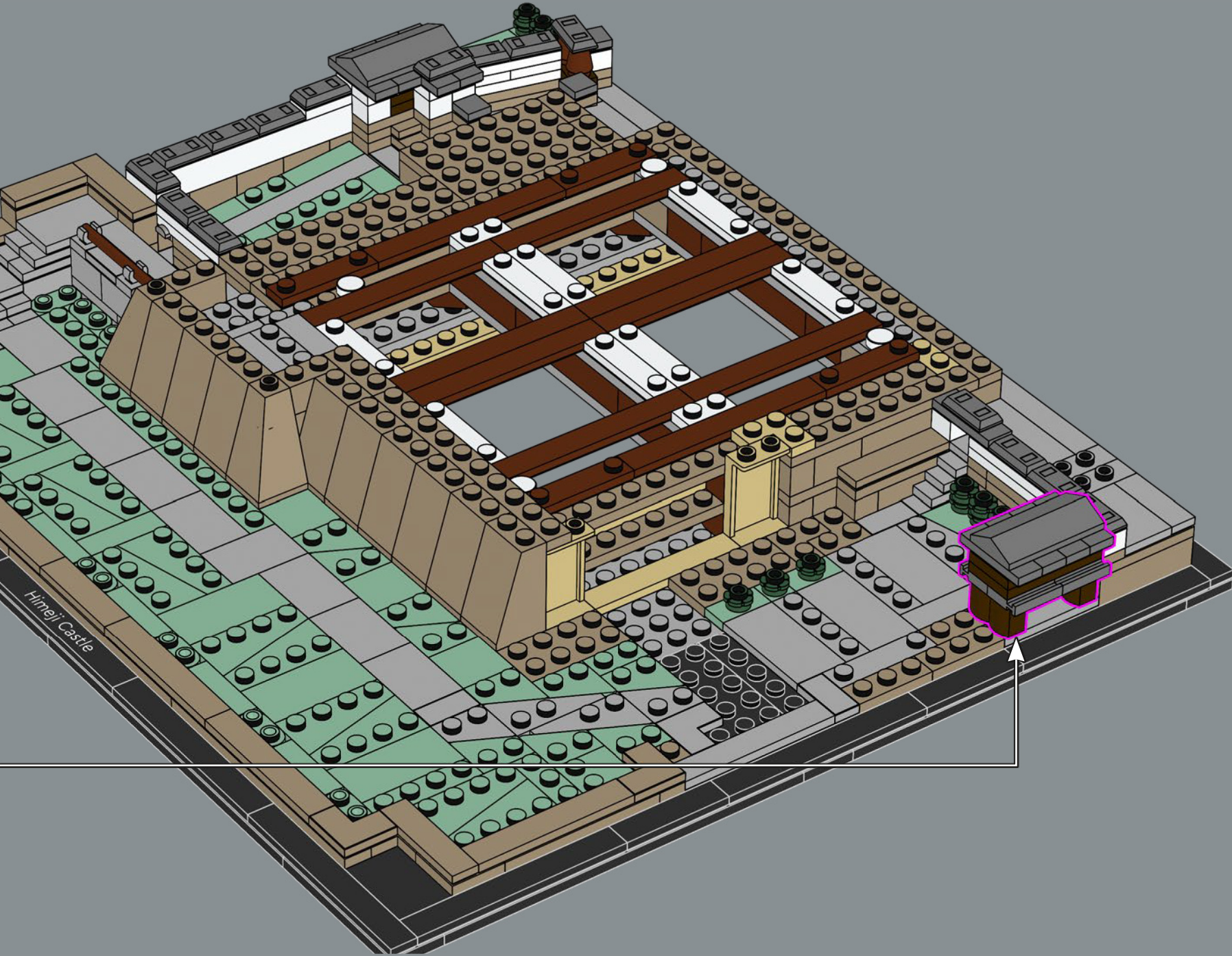

Himeji Castle

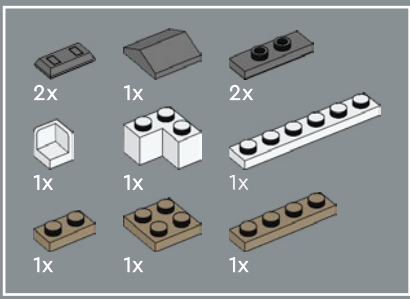

102

1

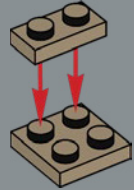

2

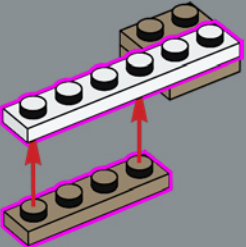

3

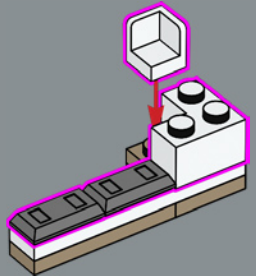

4

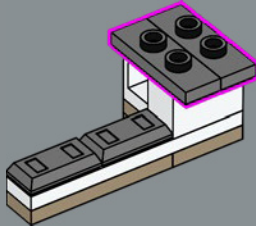

5

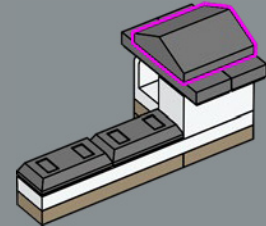

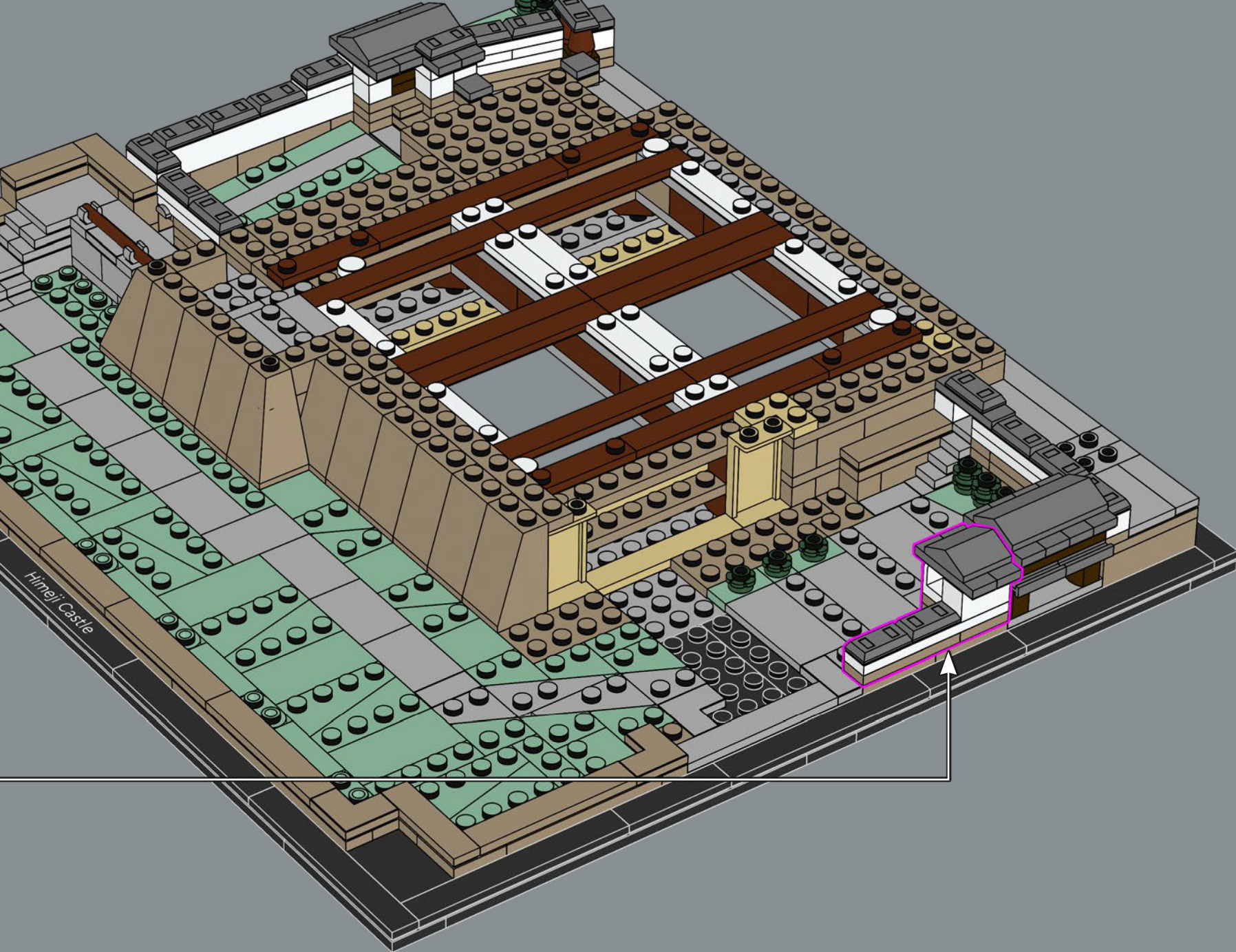

1x 2x 1x

103

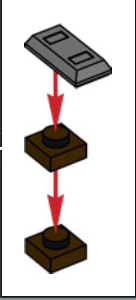
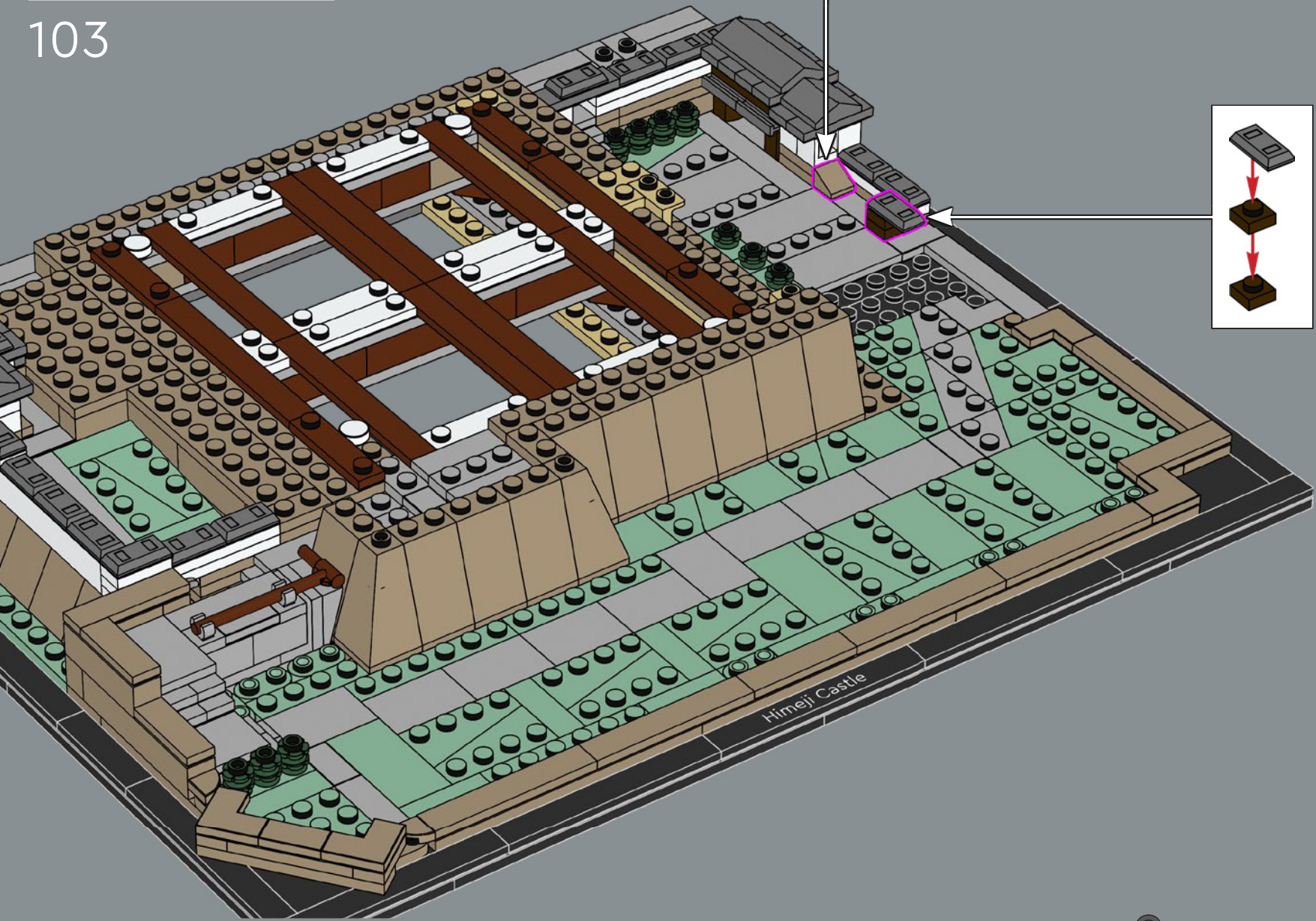

Himeji Castle



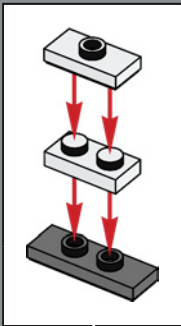
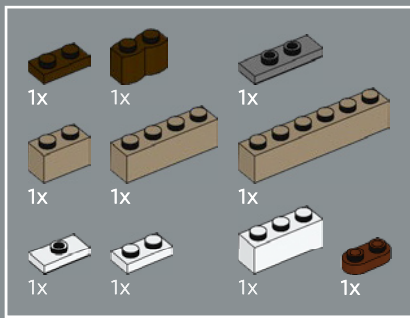

104

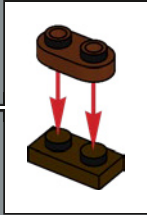
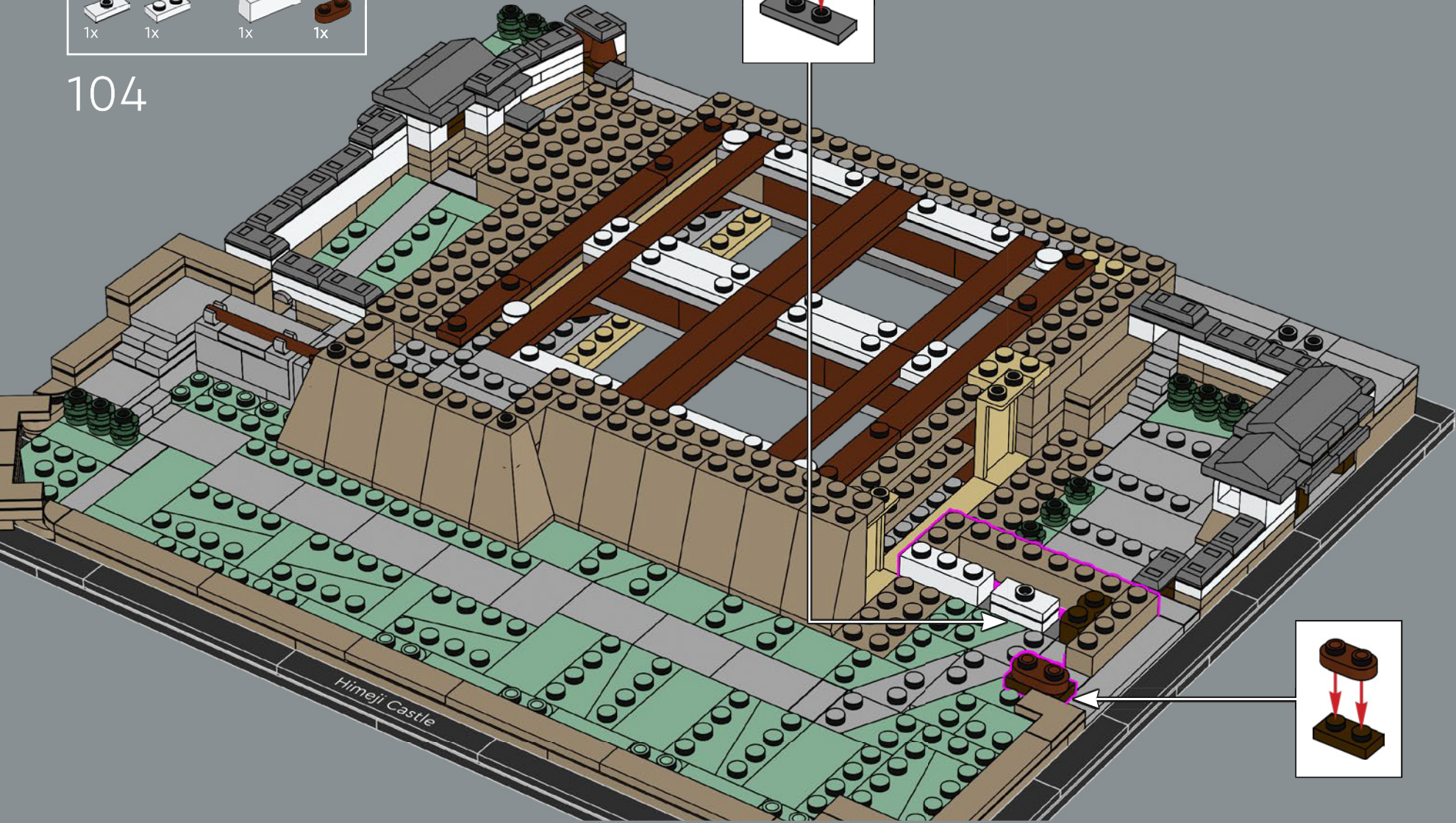

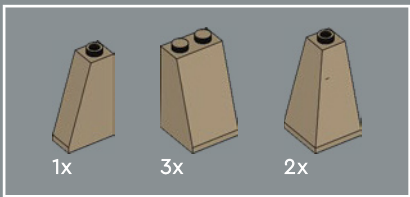

105

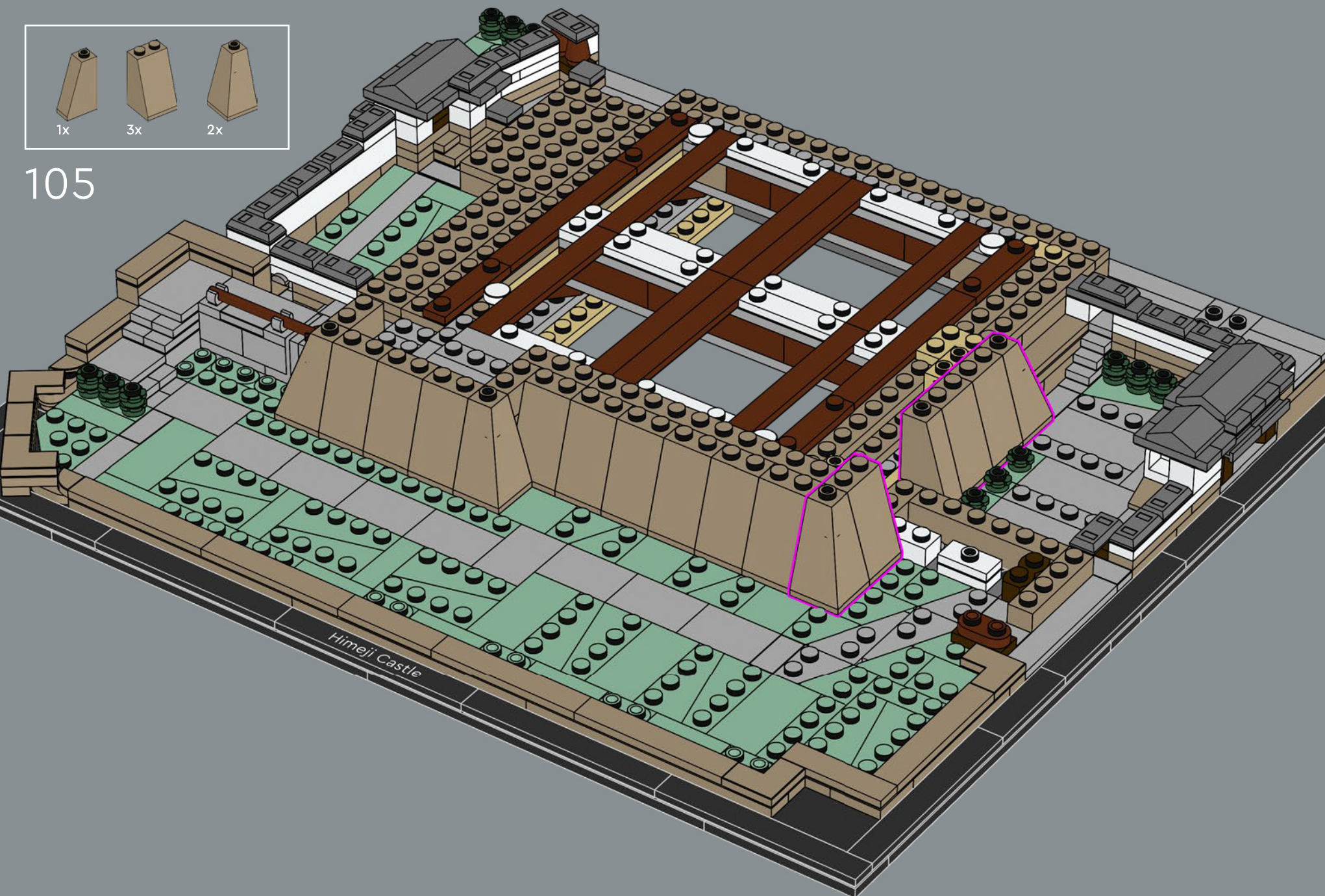

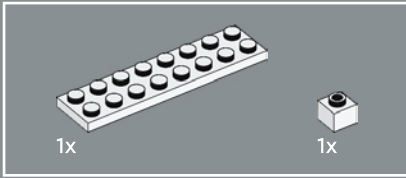
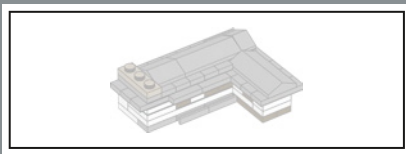

106

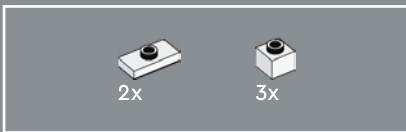
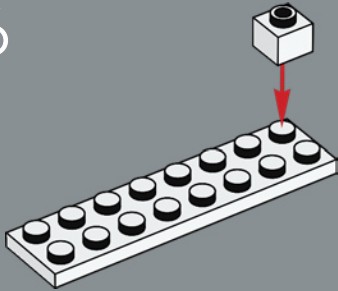

107

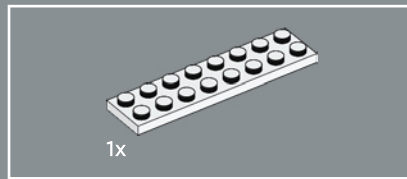
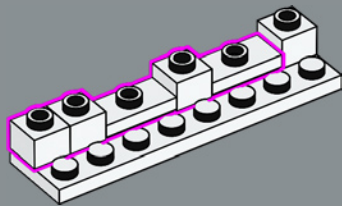

108

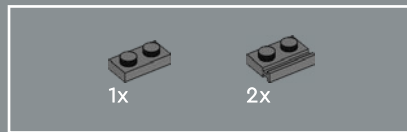
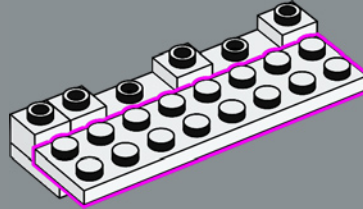

109

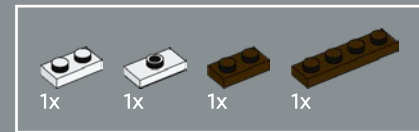
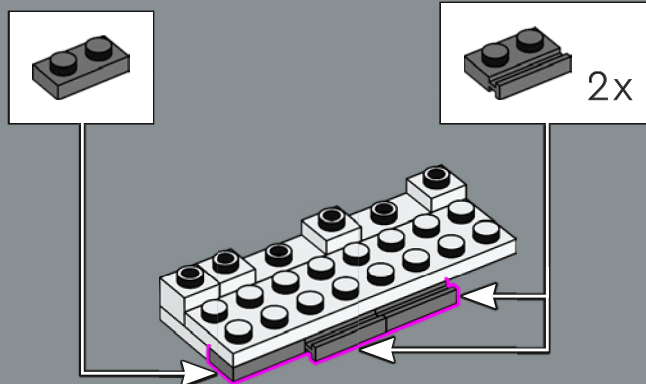

110

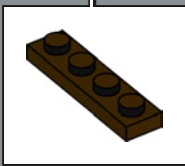
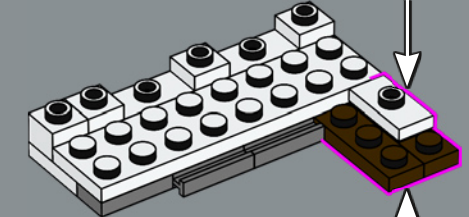
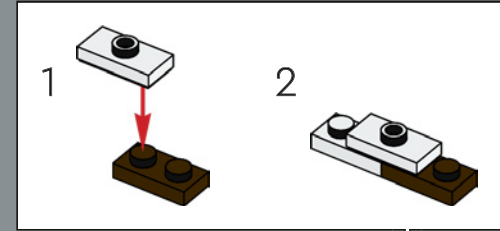

111

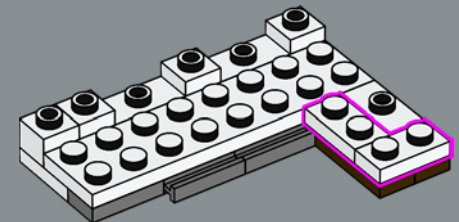

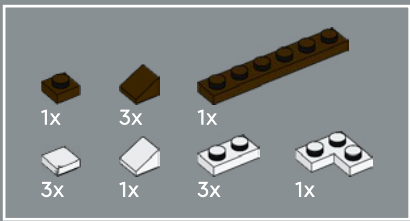

112

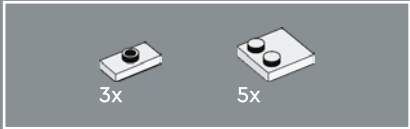
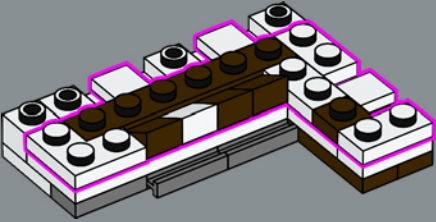

113

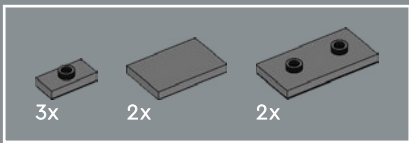
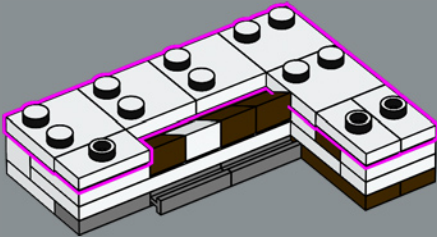

114

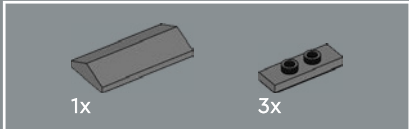
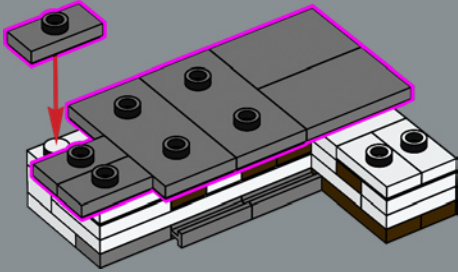

115

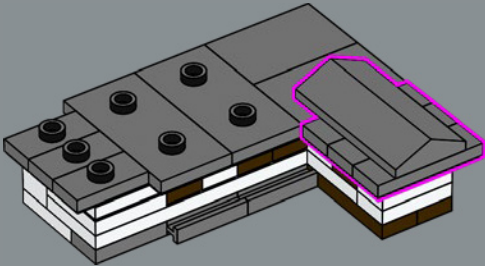
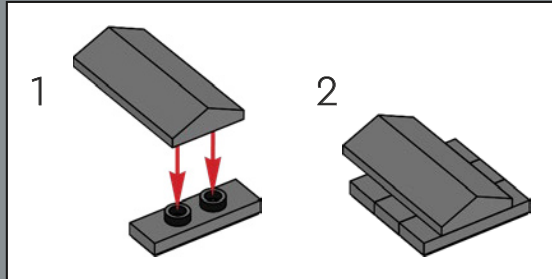

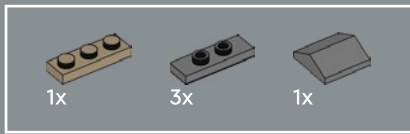

116

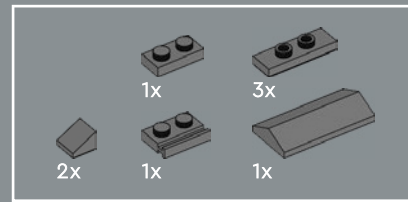
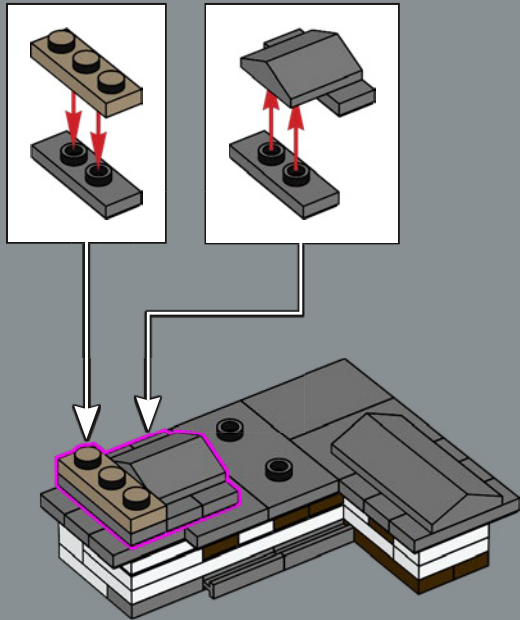

117

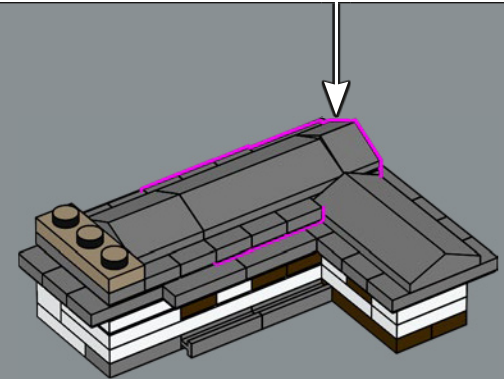
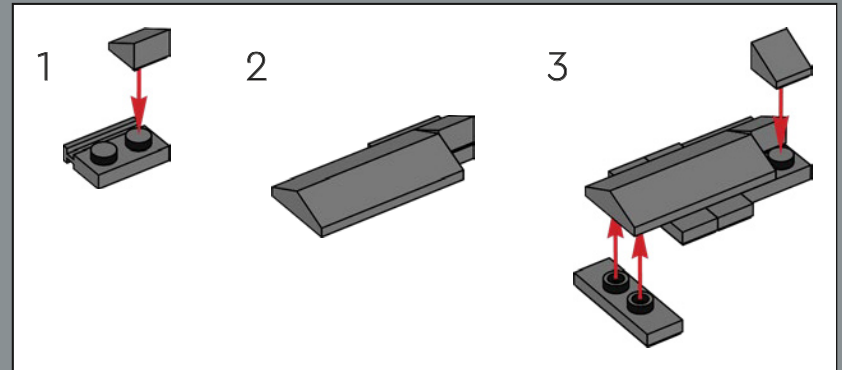

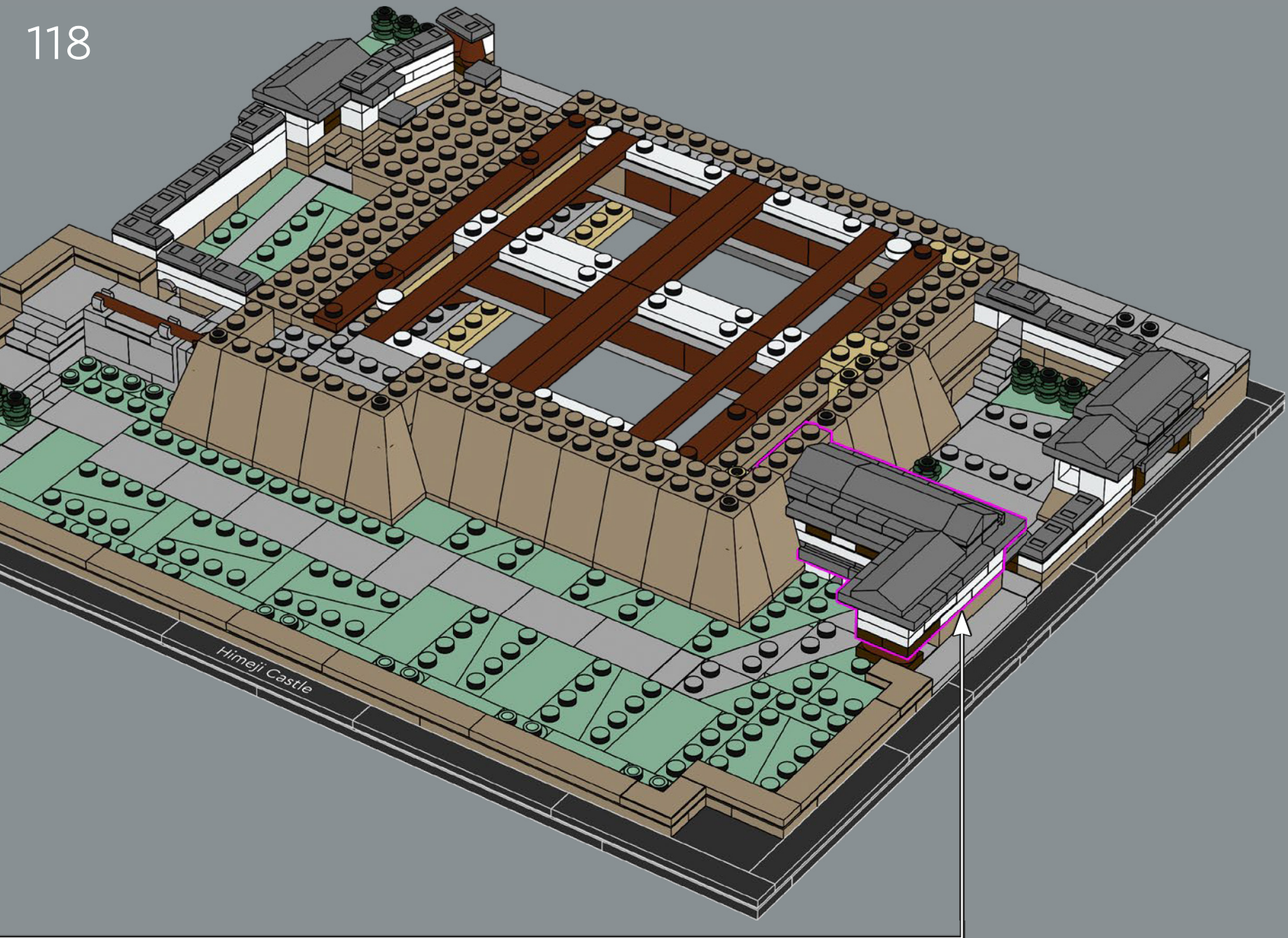

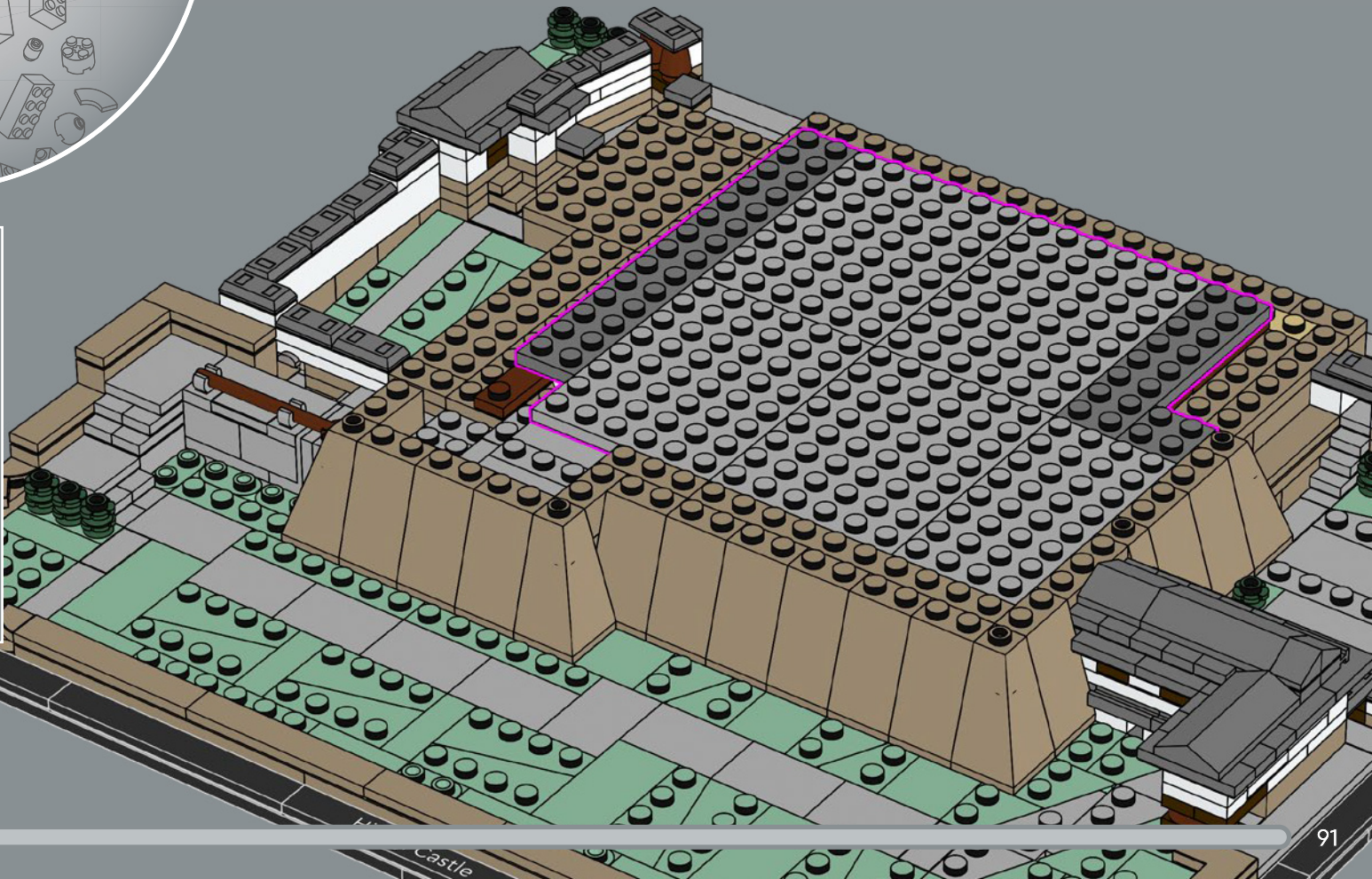
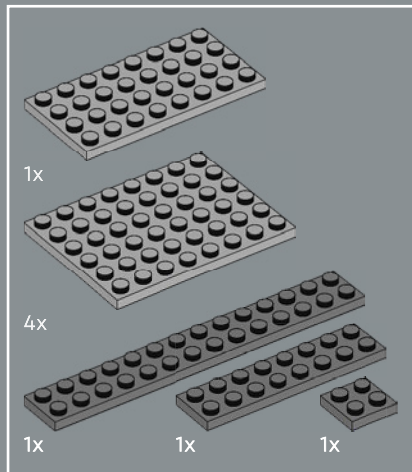

119

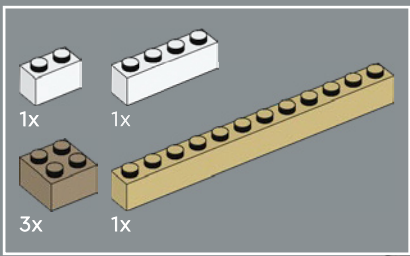

120

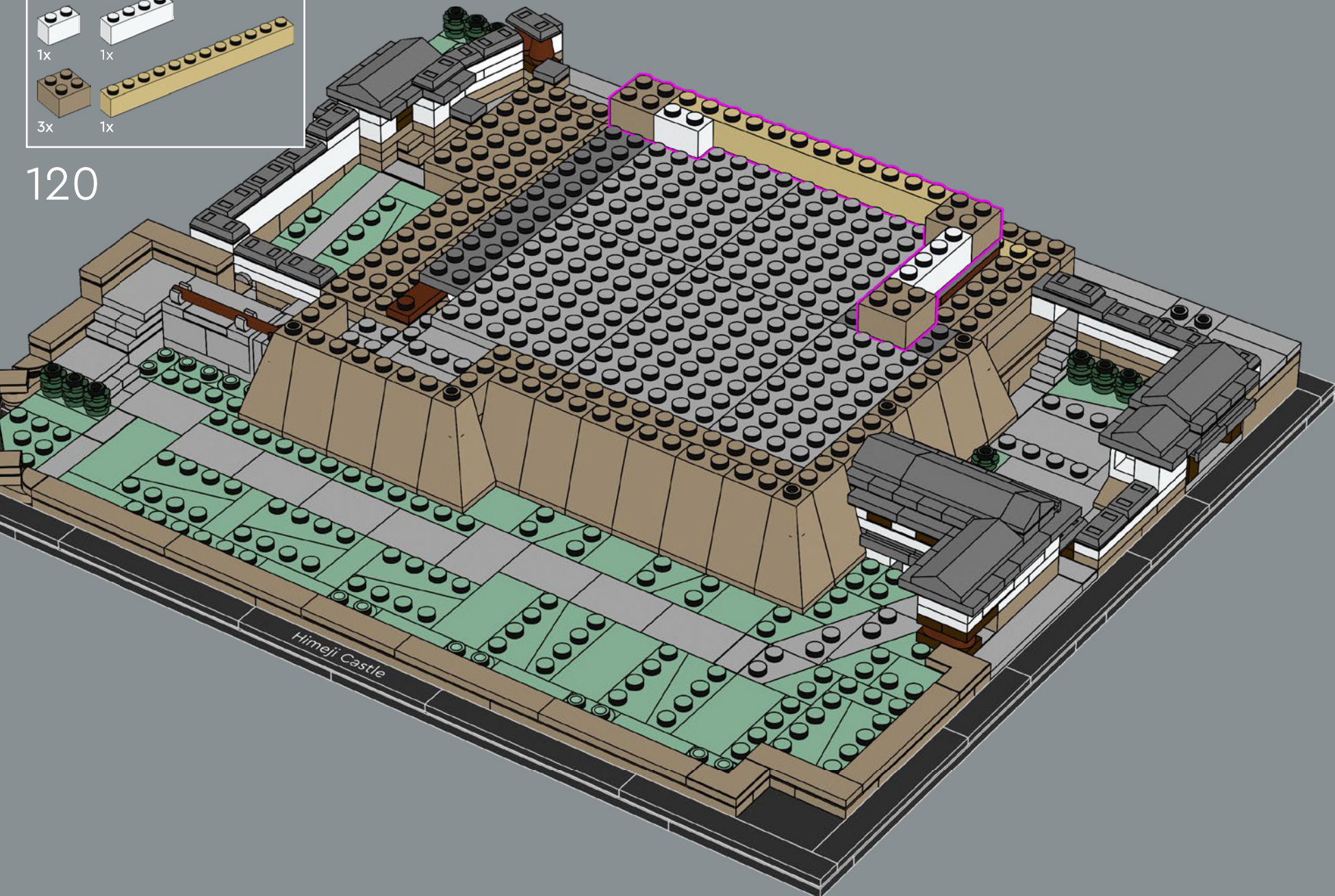

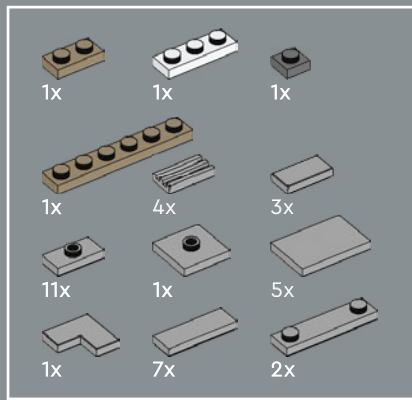

121

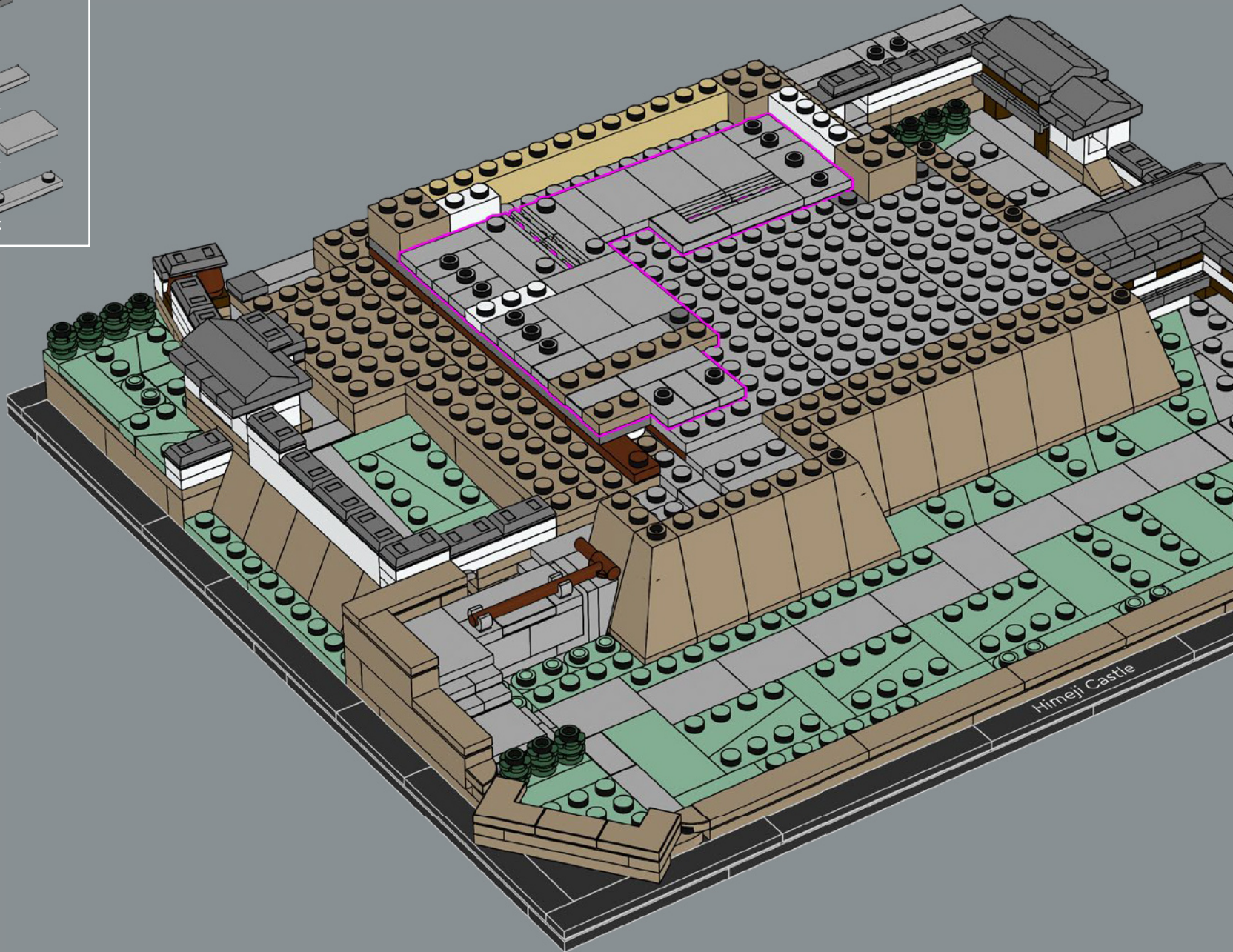

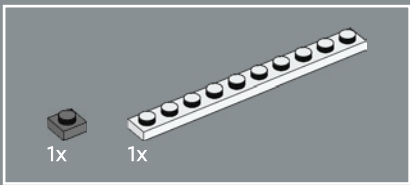

122

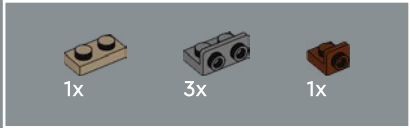
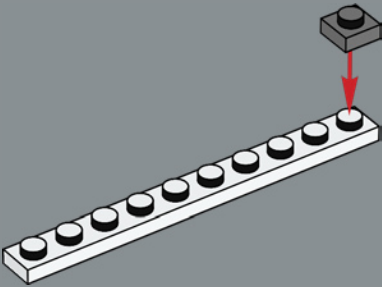

123

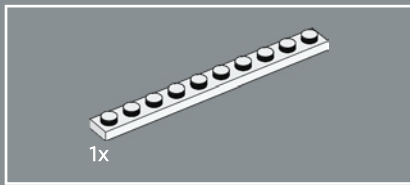
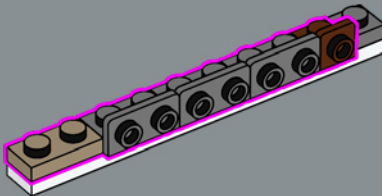

124

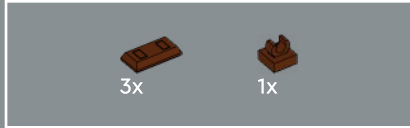
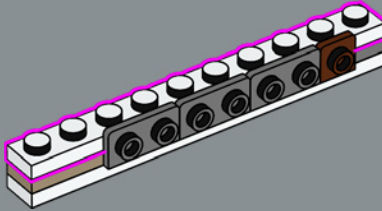

125

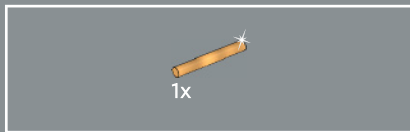
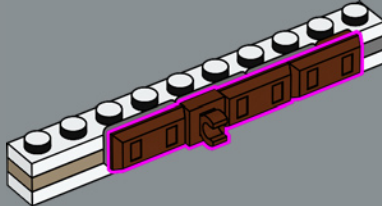

126

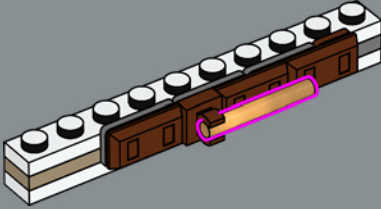

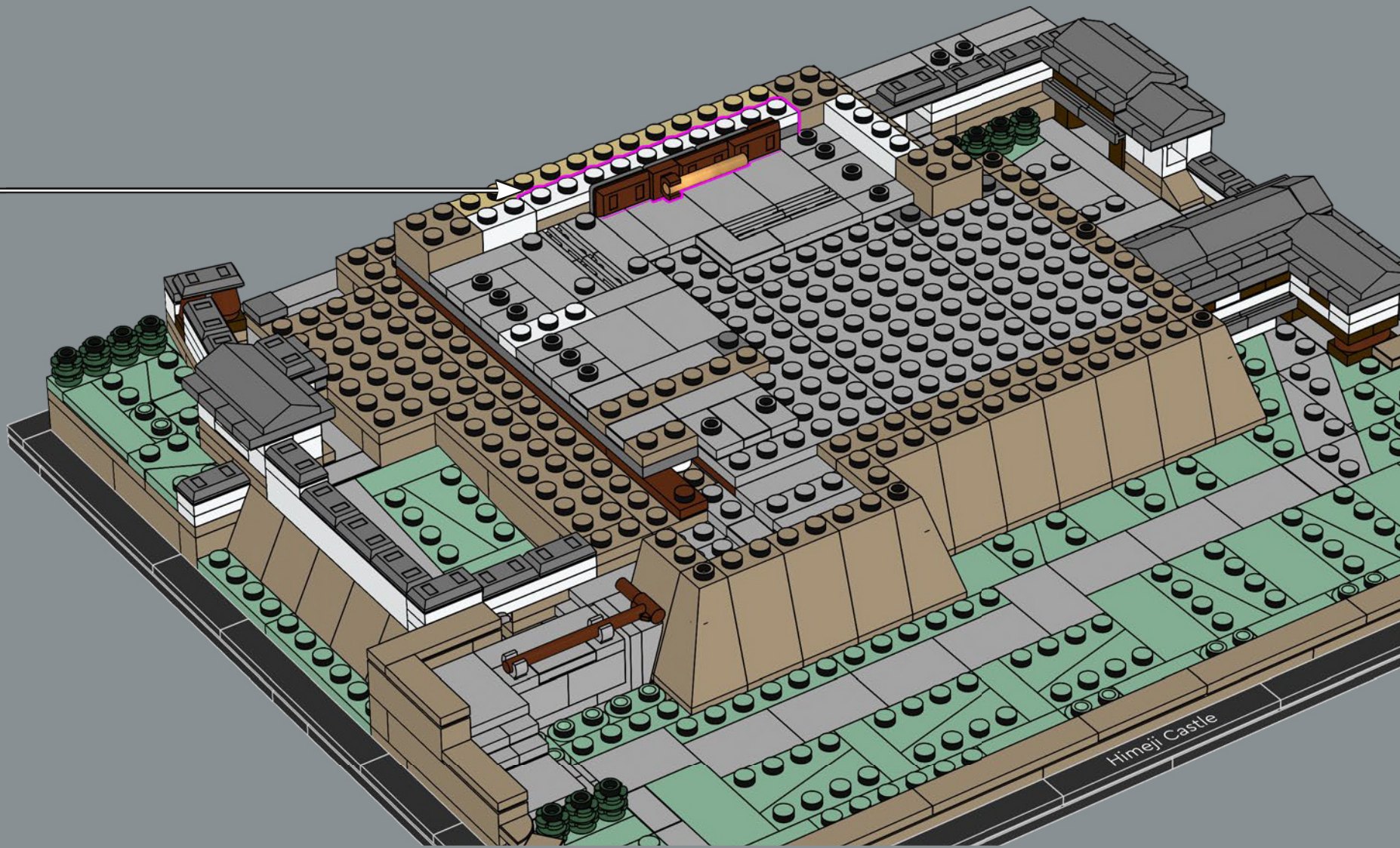

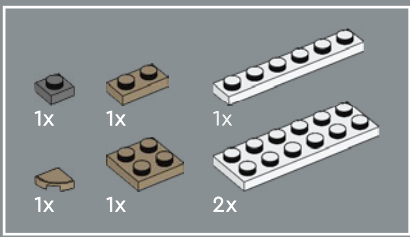

128

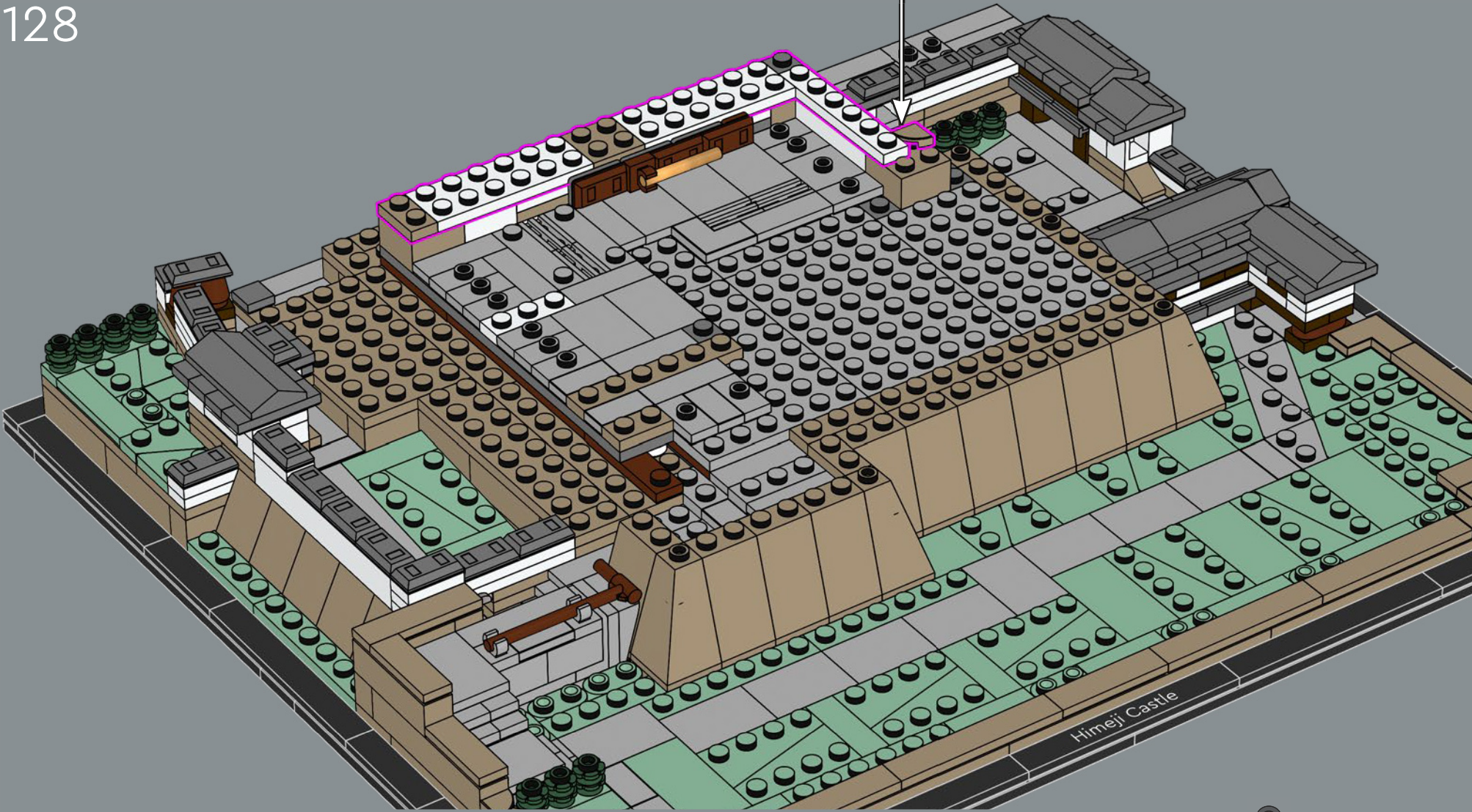

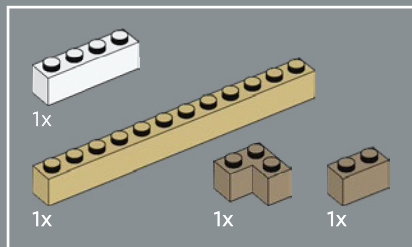

129

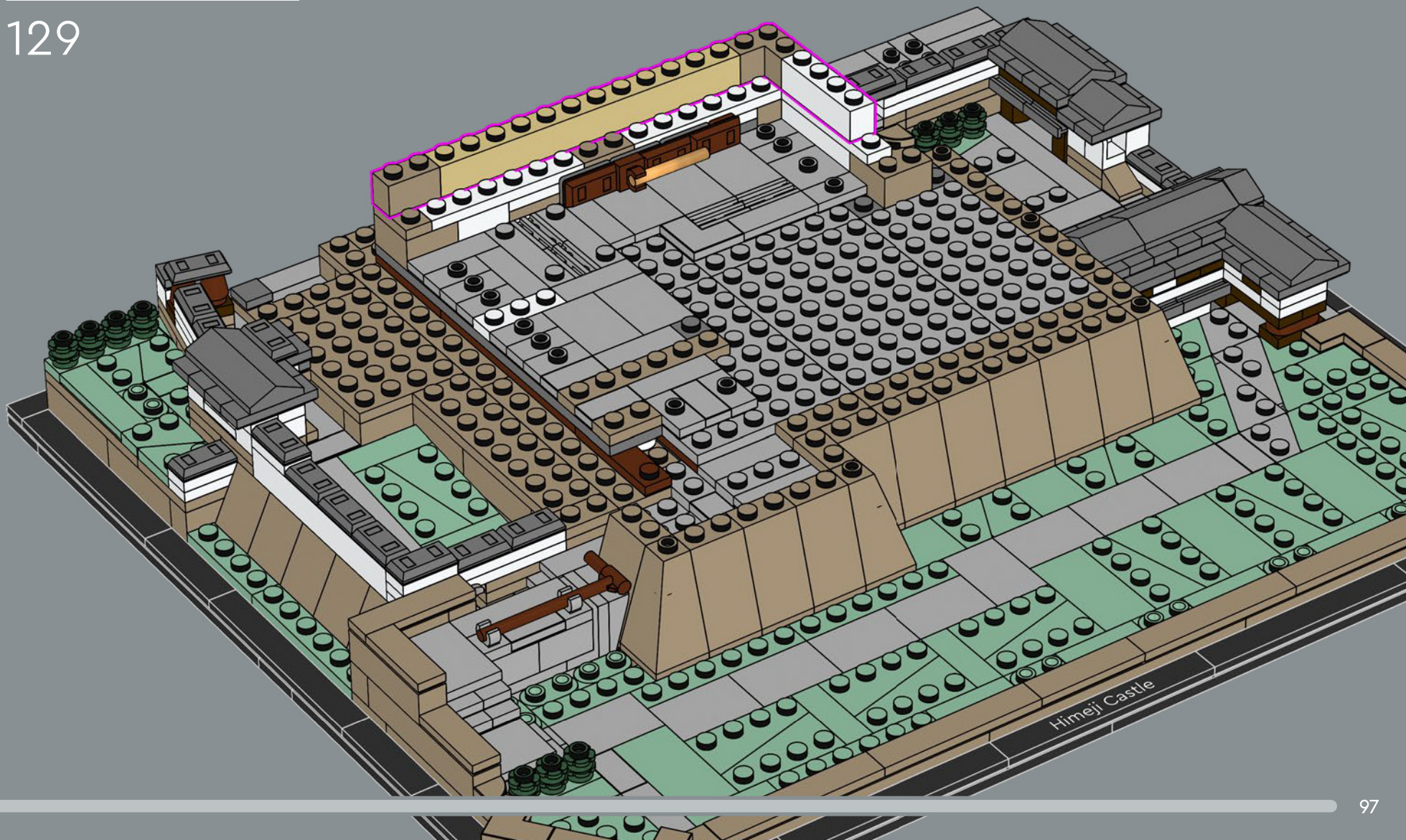

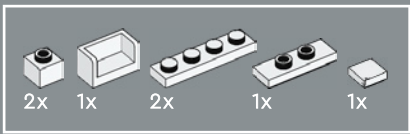

130

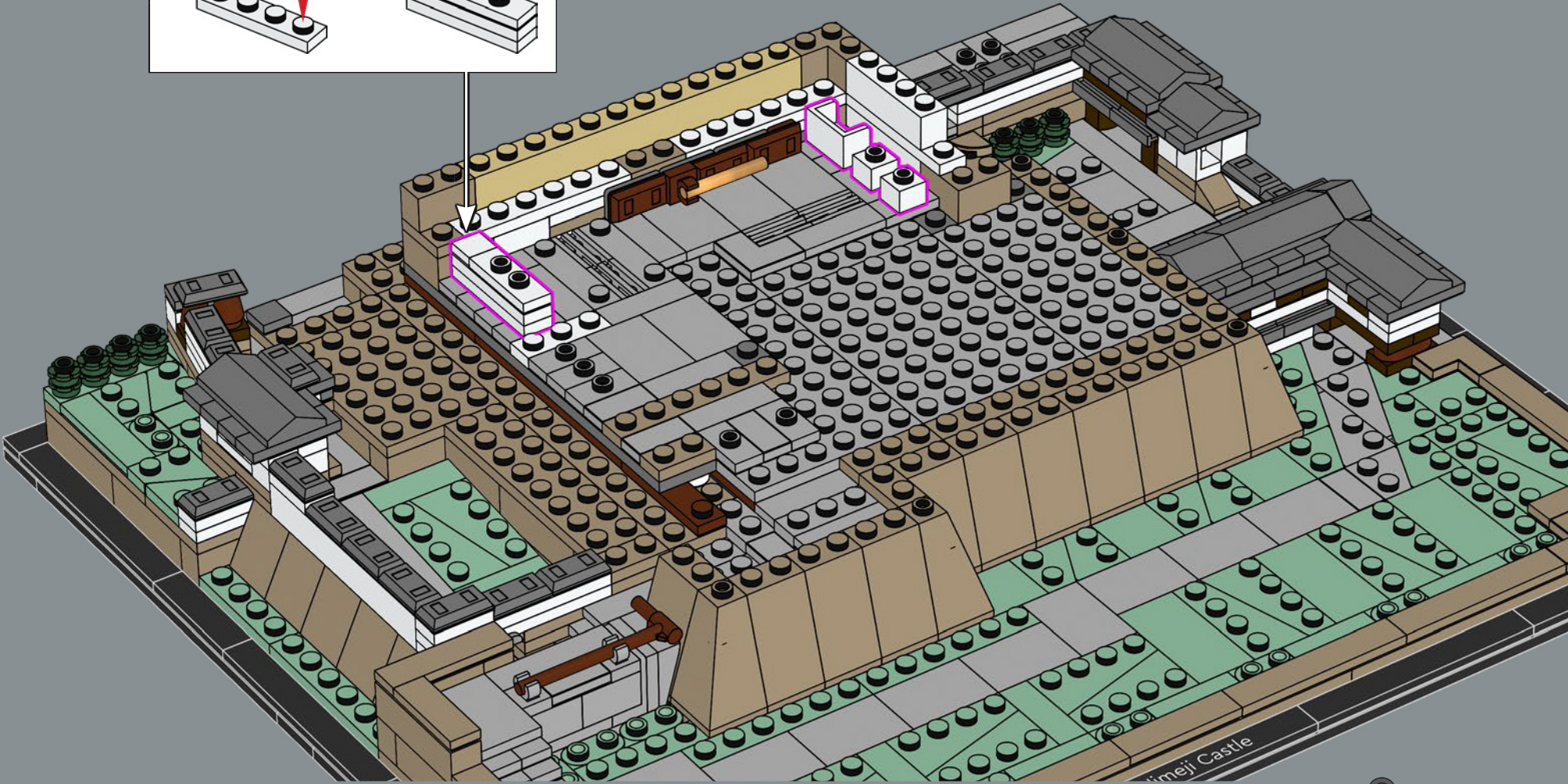
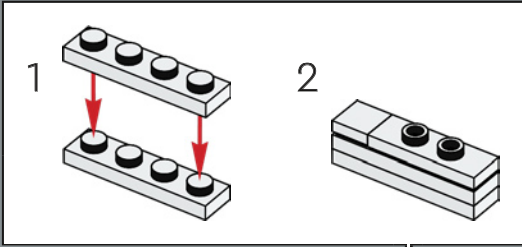

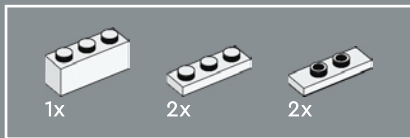

131

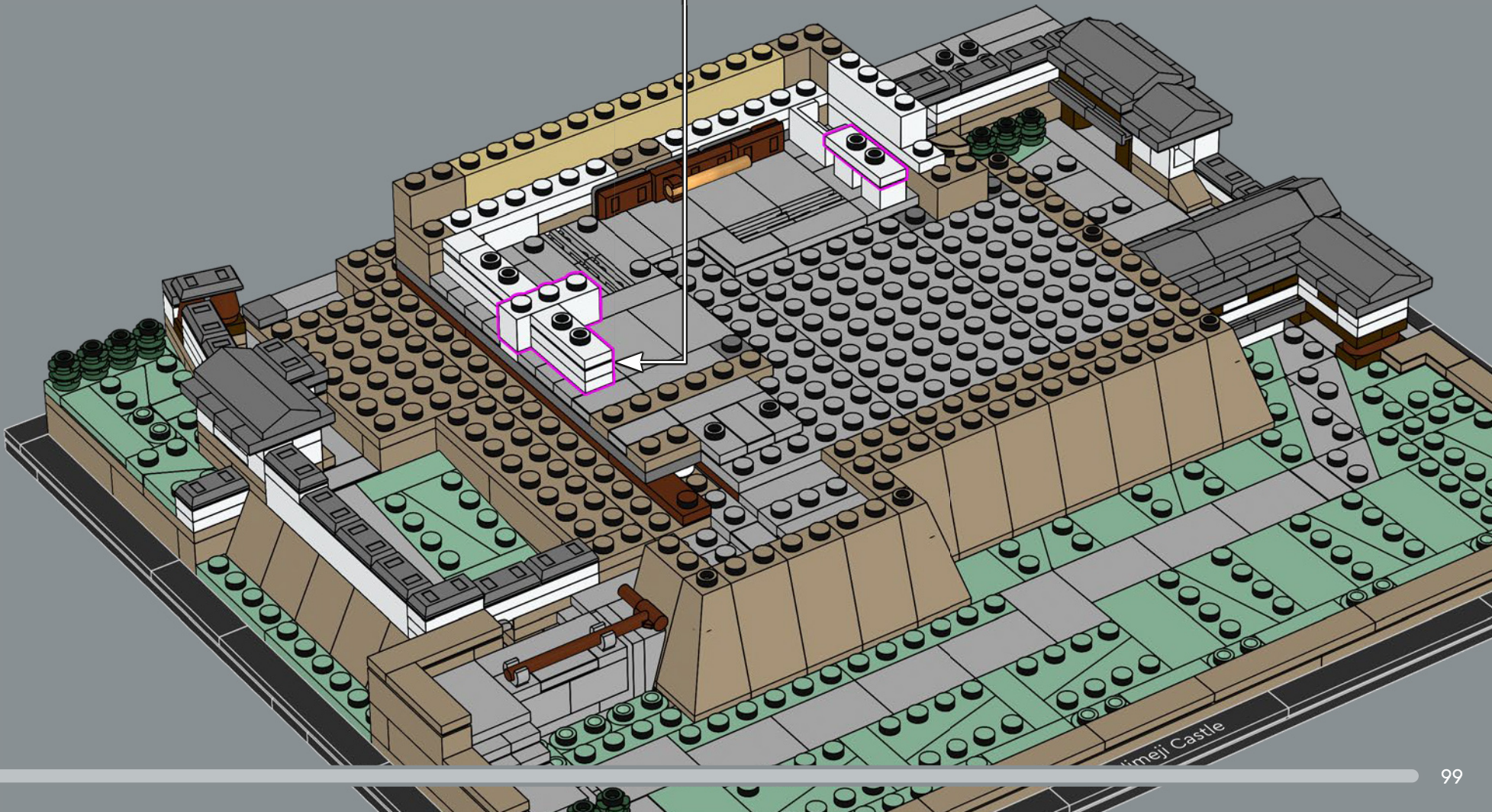
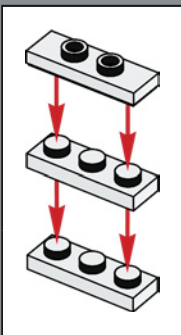

Timeji Castle

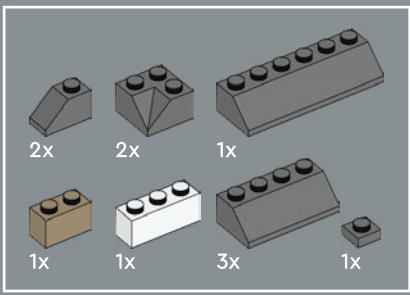

132

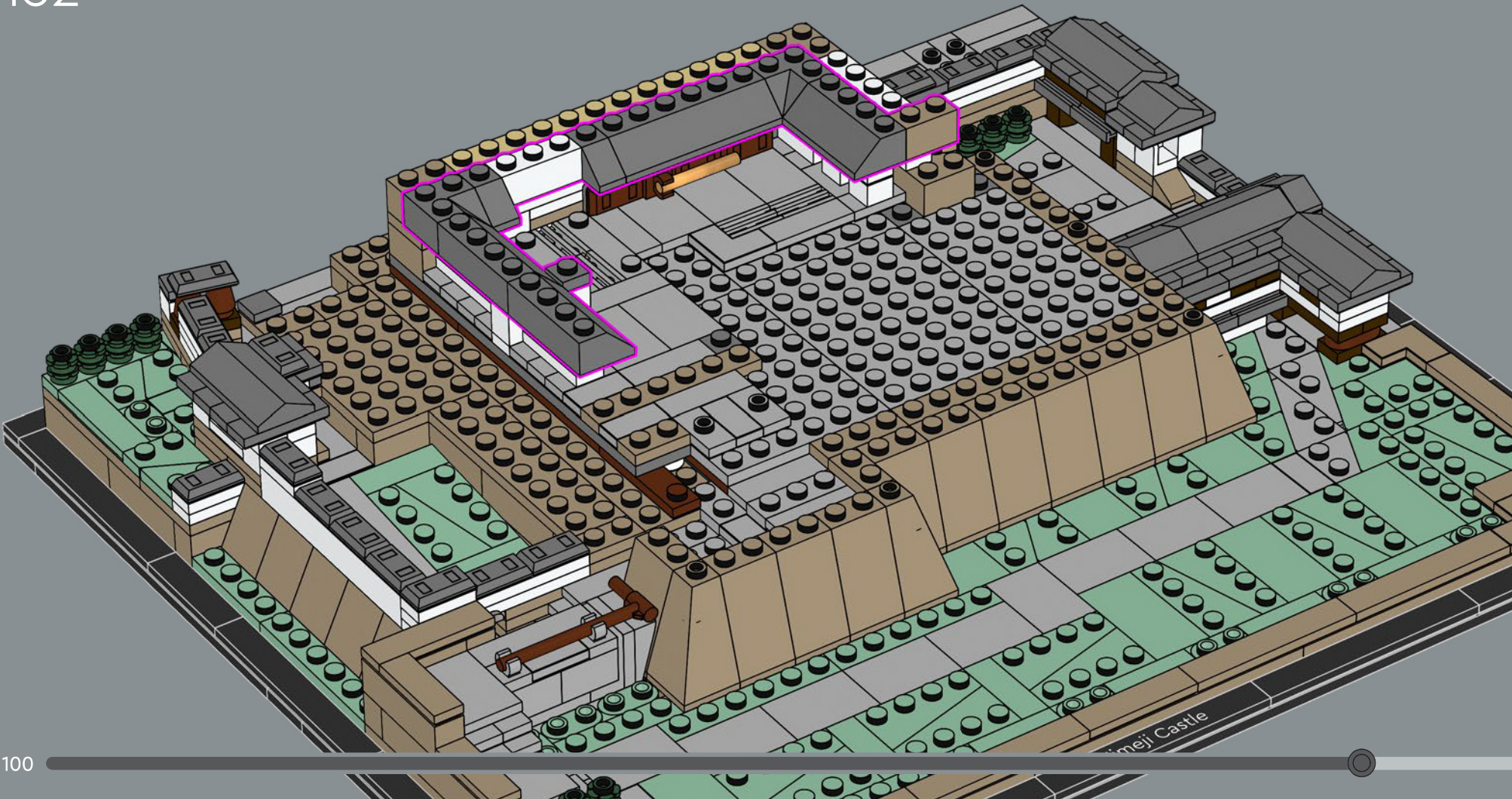

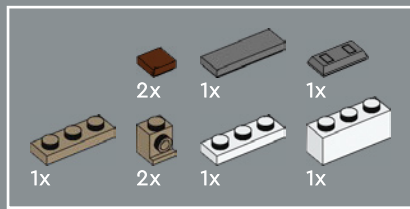

133

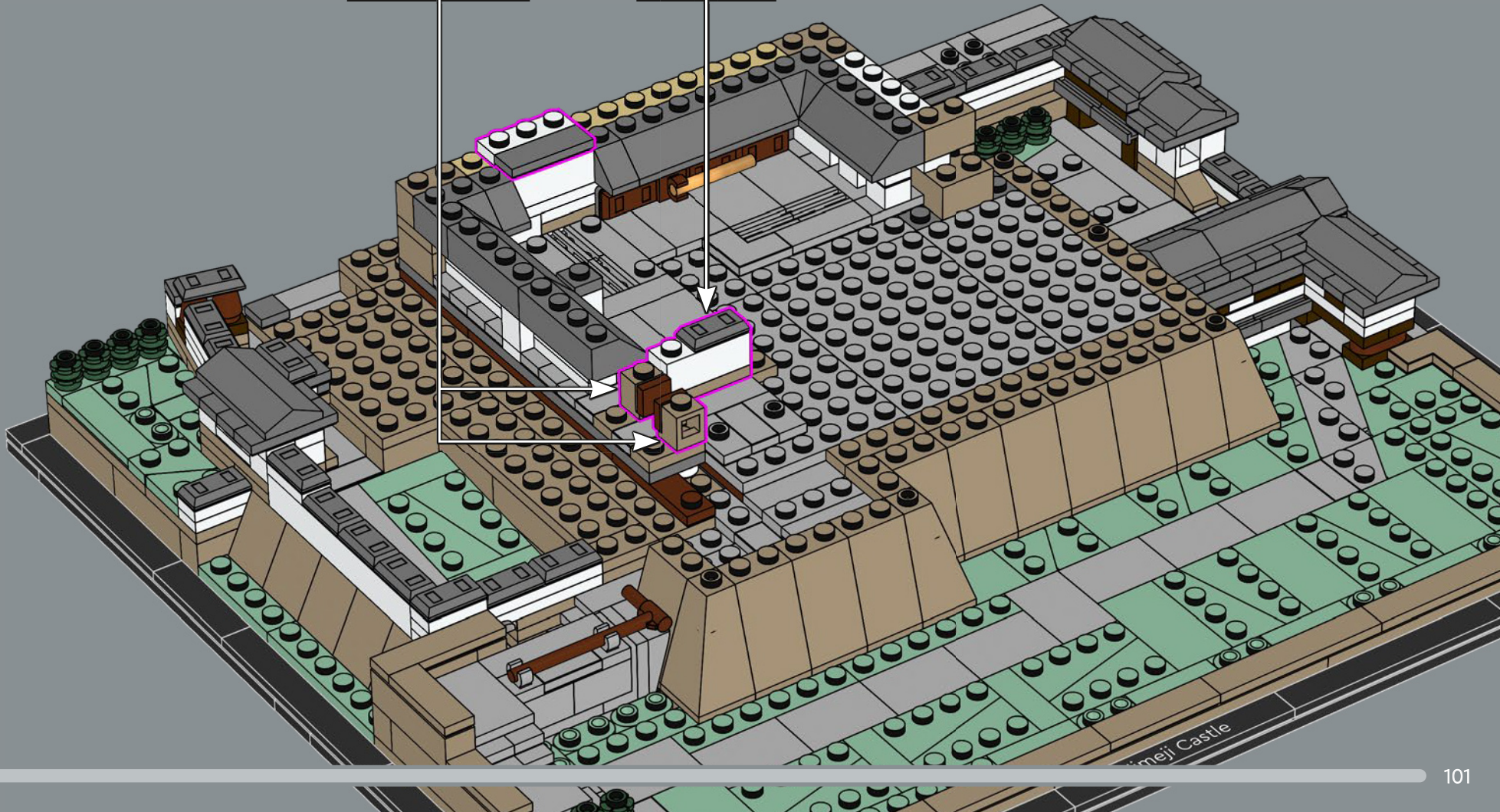
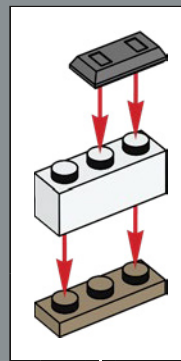
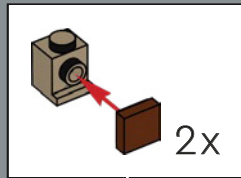

Meiji Castle

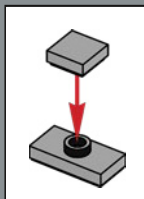
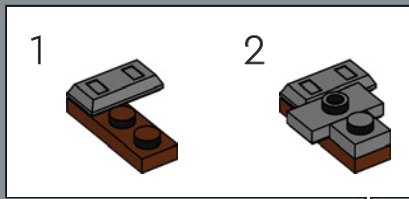
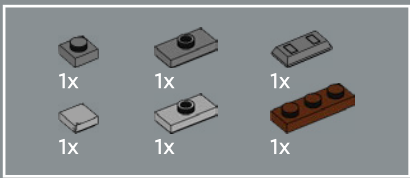

134

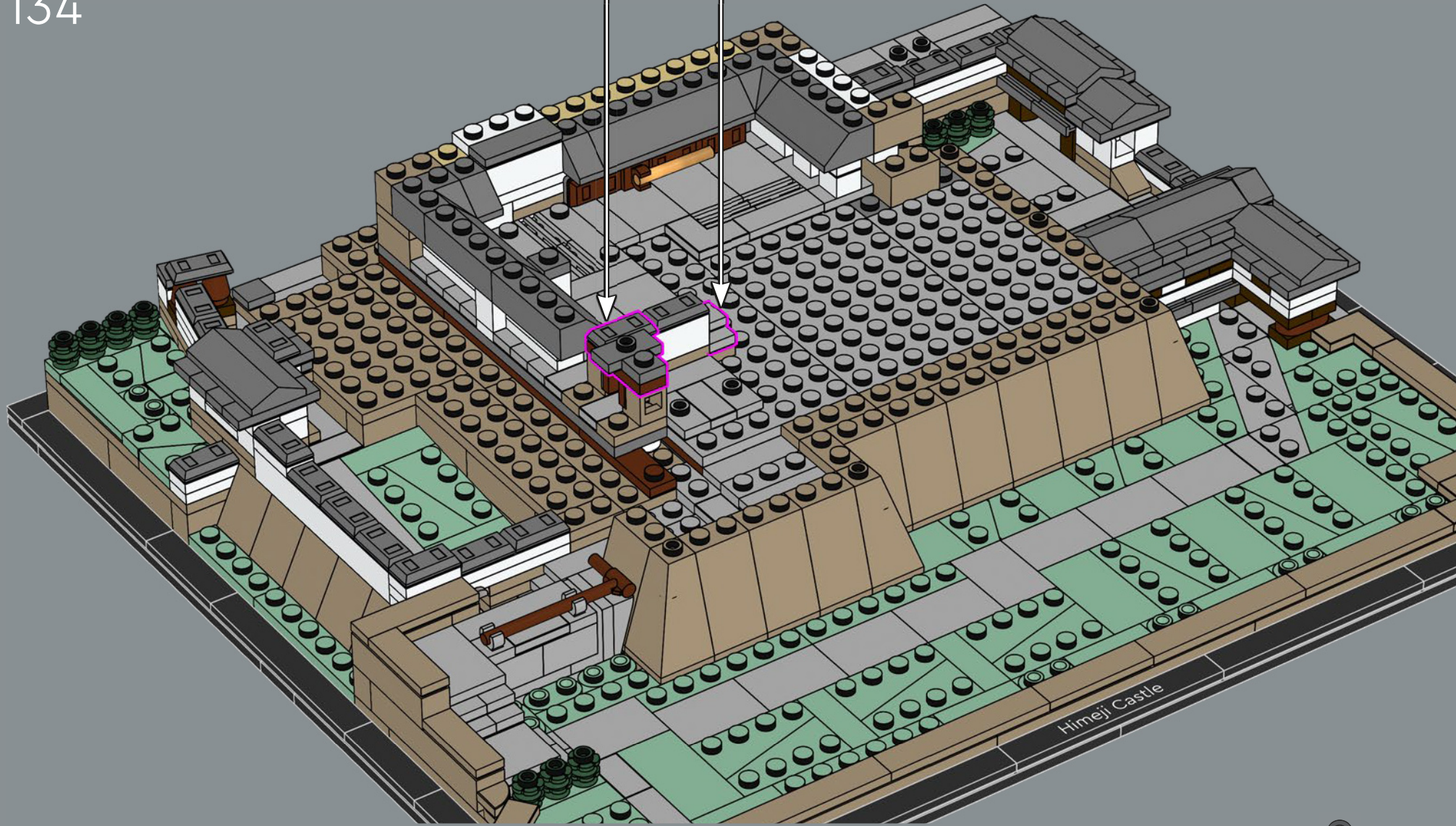

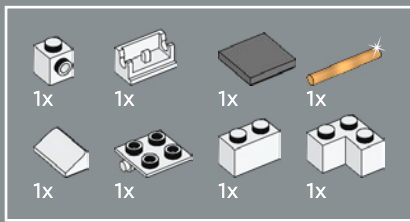

135

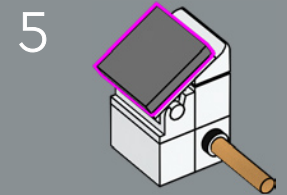
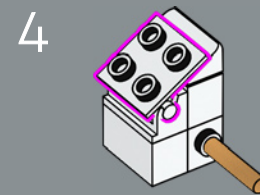
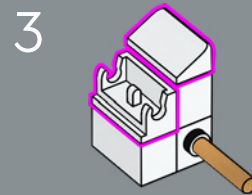
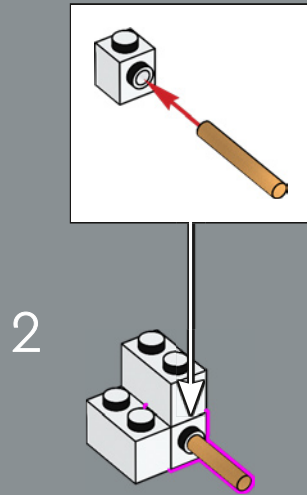
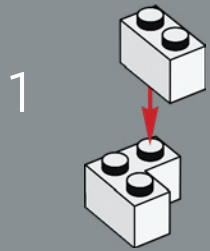

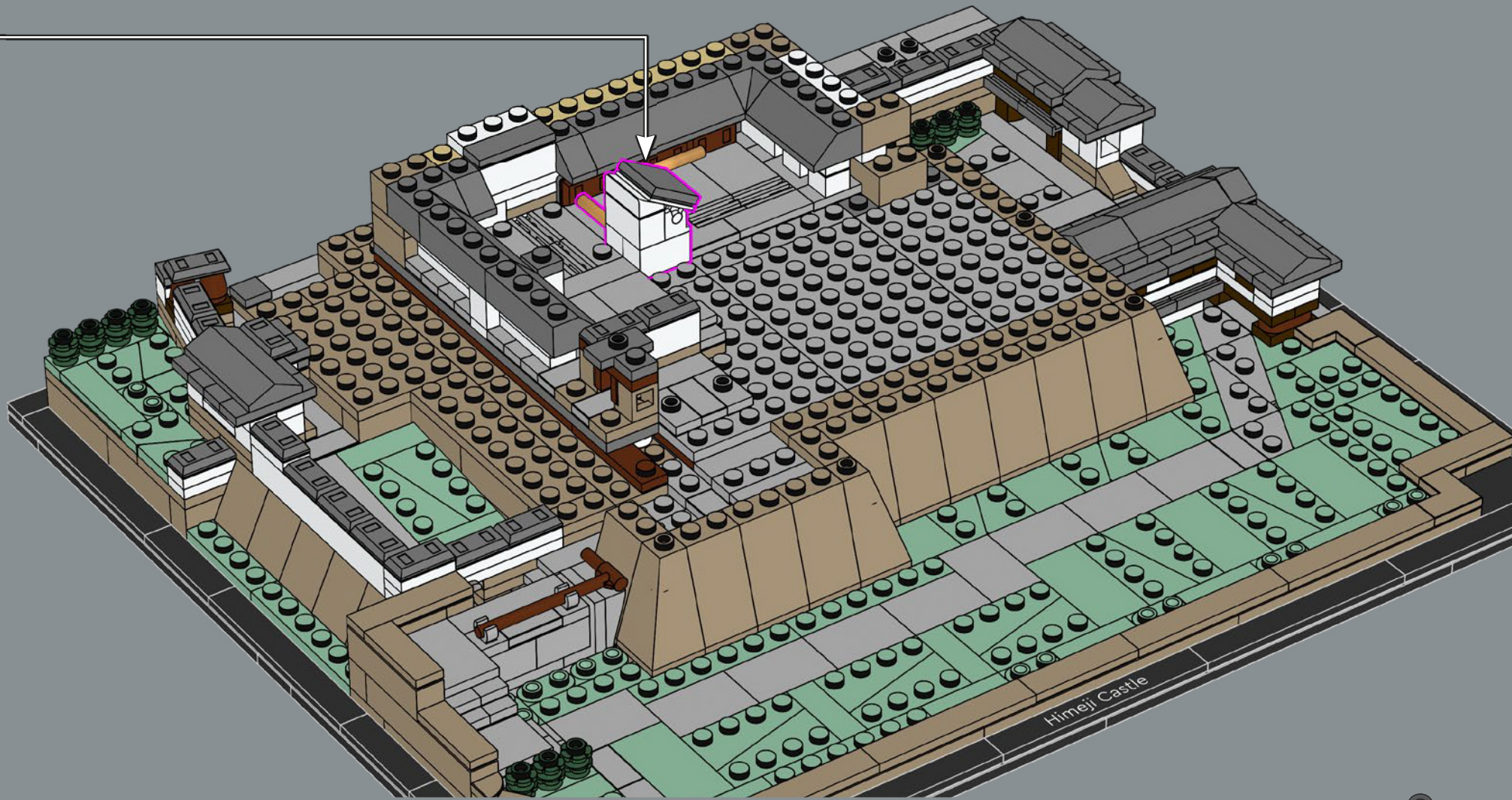

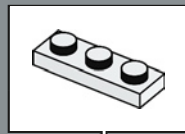
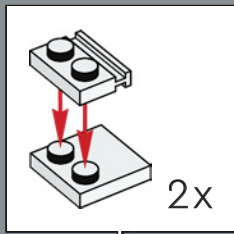
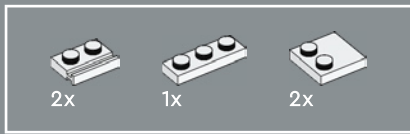

136

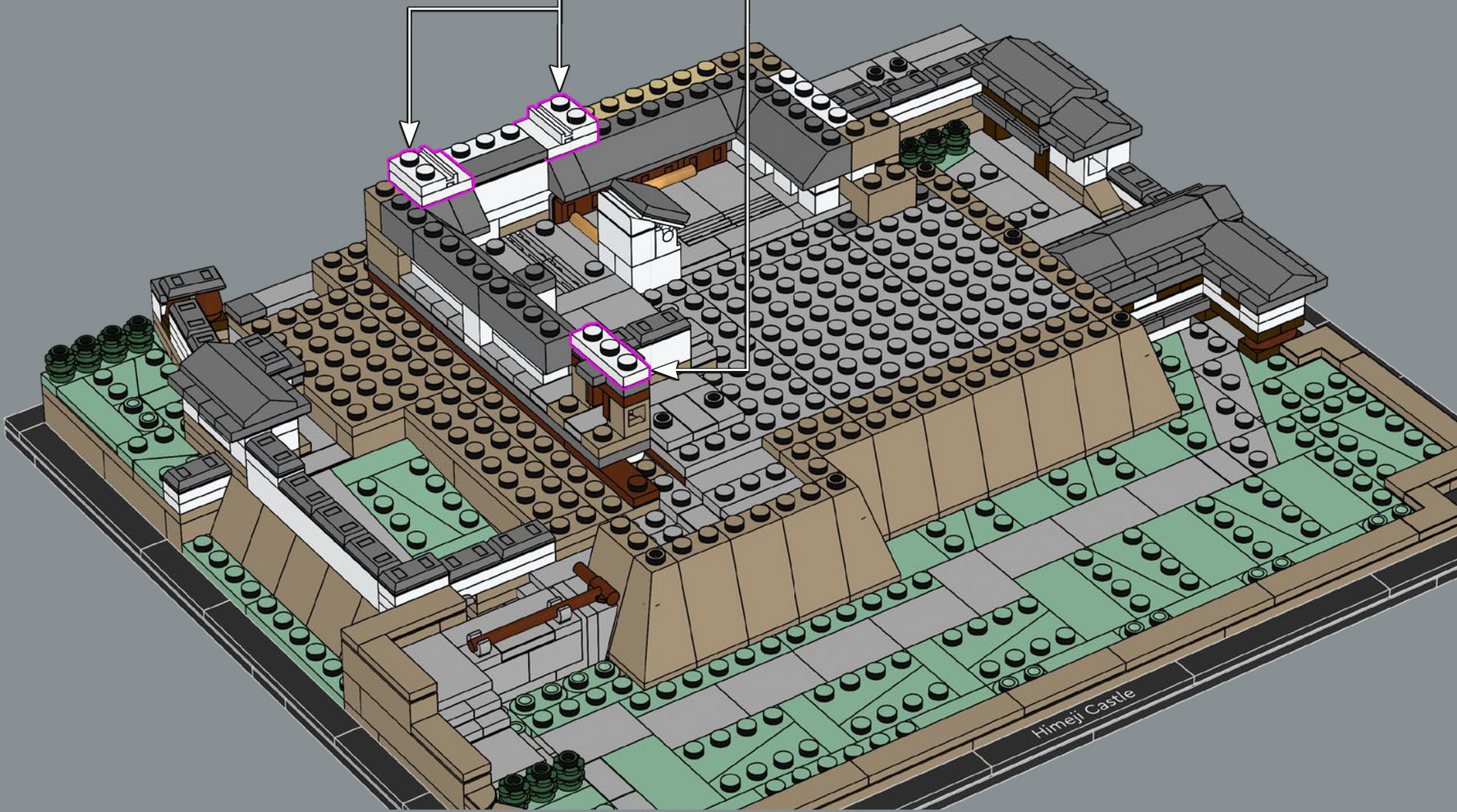

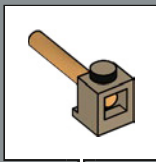
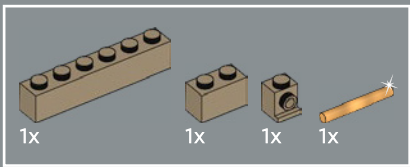

137

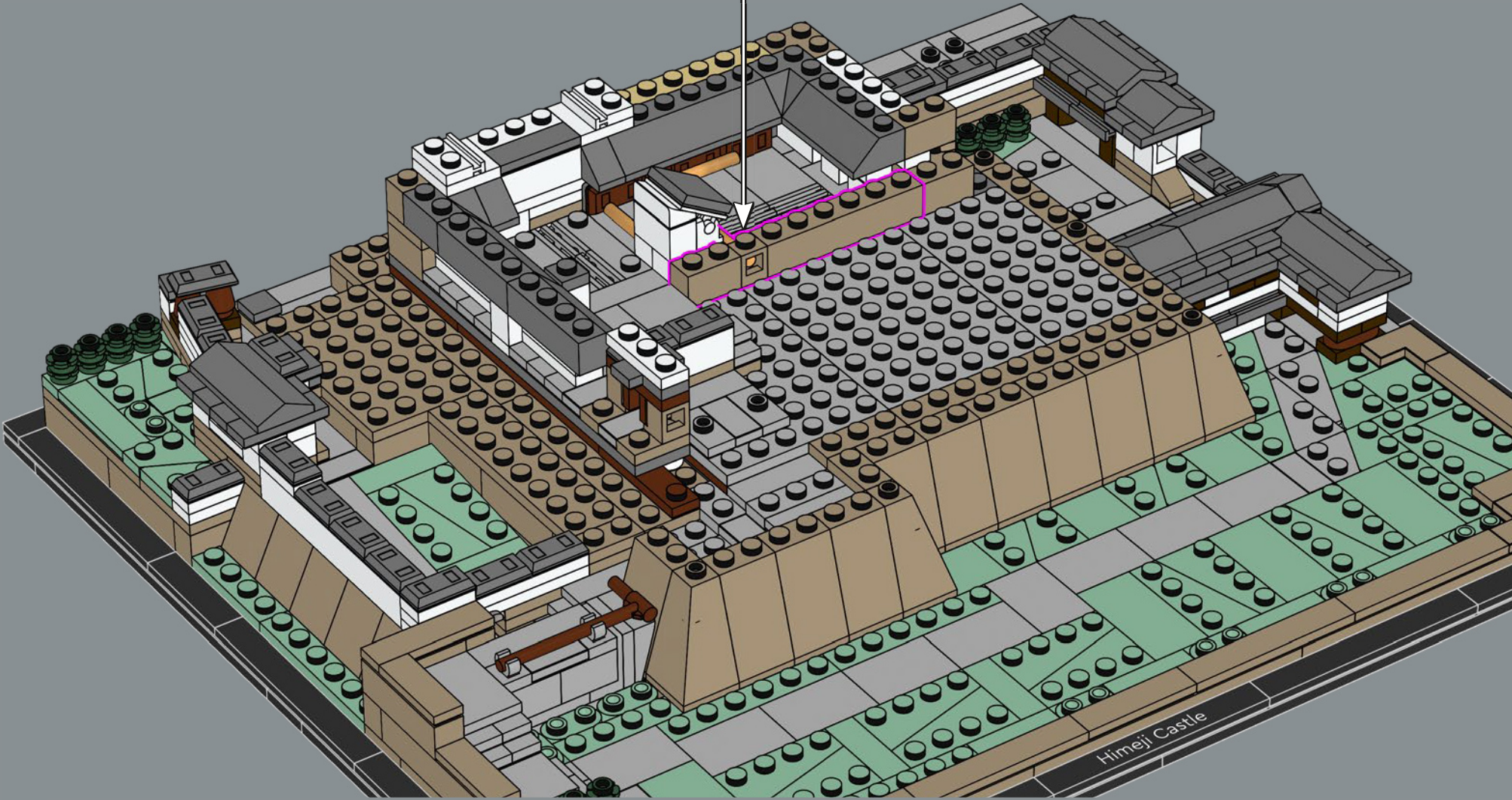

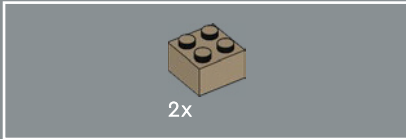
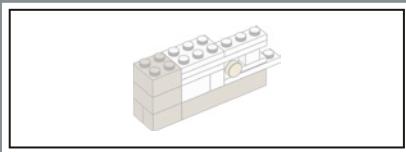

138

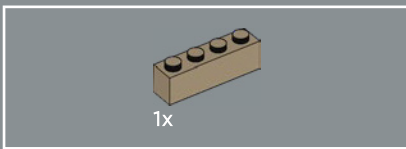
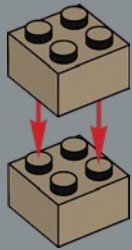

139

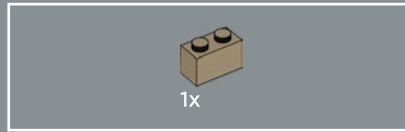
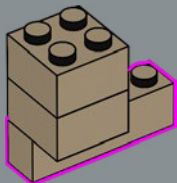

140

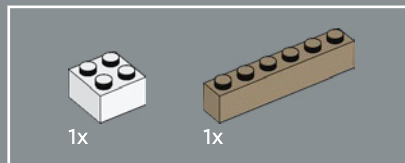
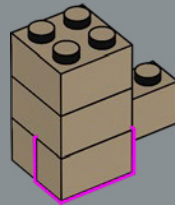

141

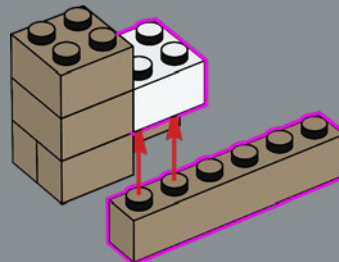

142

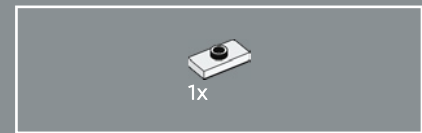
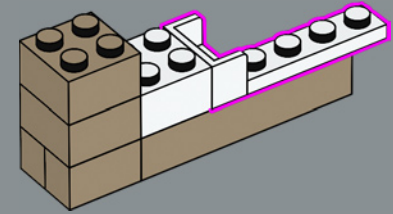

143

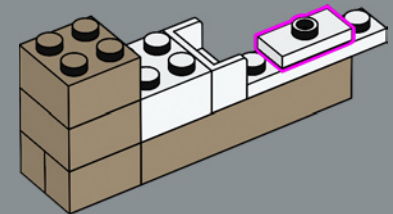

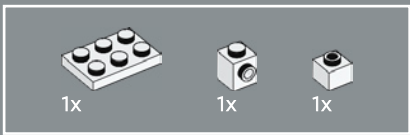

144

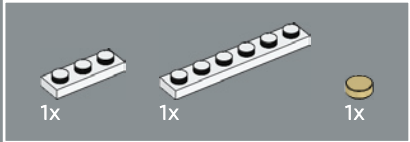
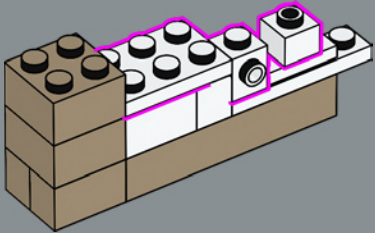

145

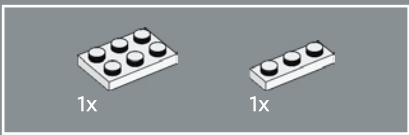
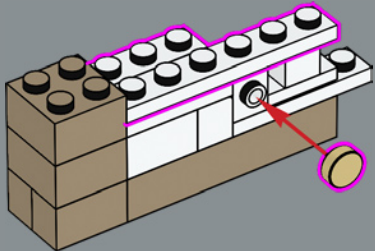

146

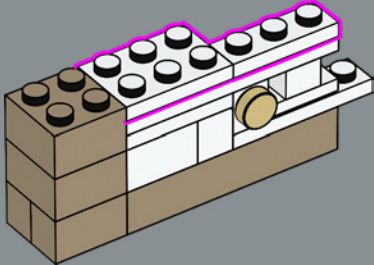

147

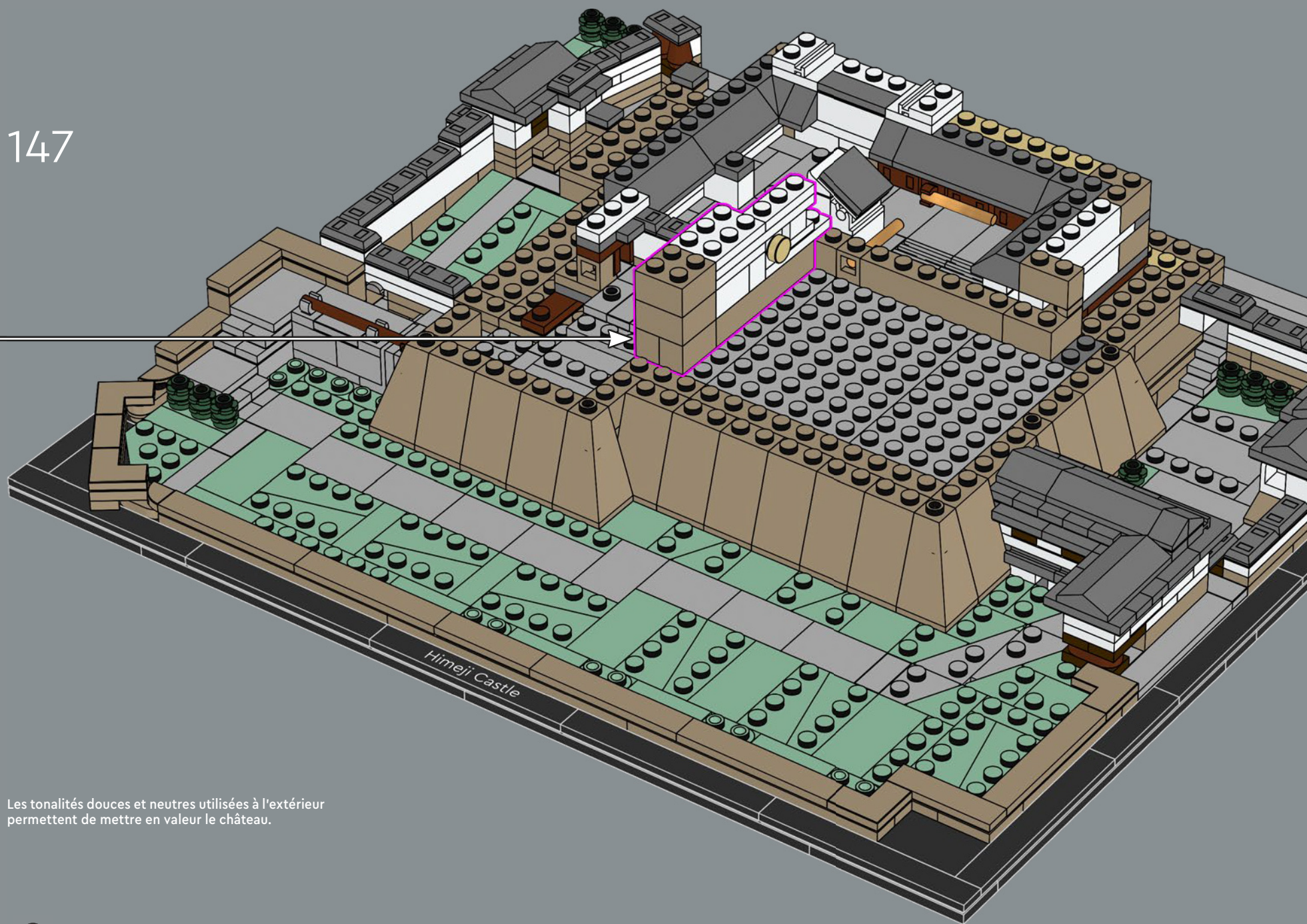

Les tonalités douces et neutres utilisées à l'extérieur permettent de mettre en valeur le château.

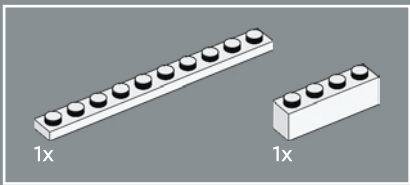

148

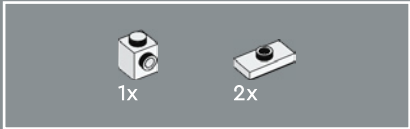
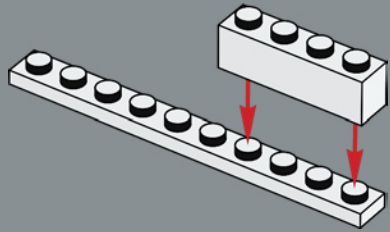

149

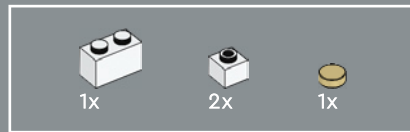
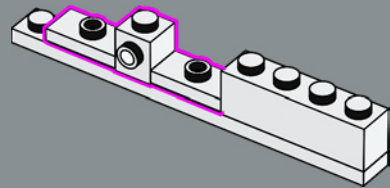

150

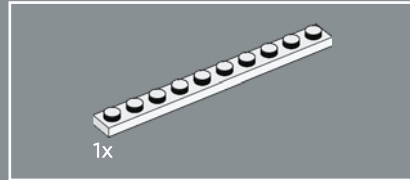
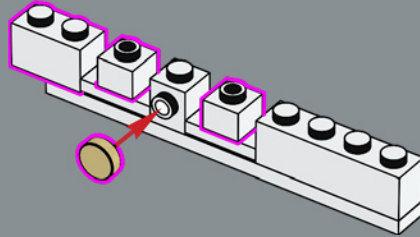

151

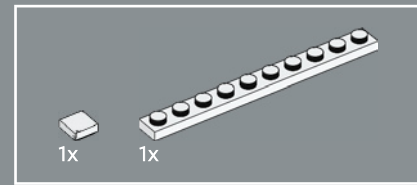
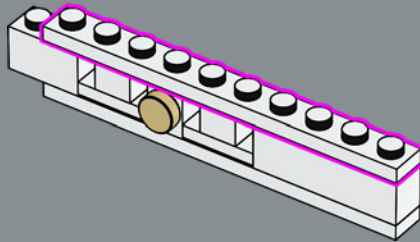

152

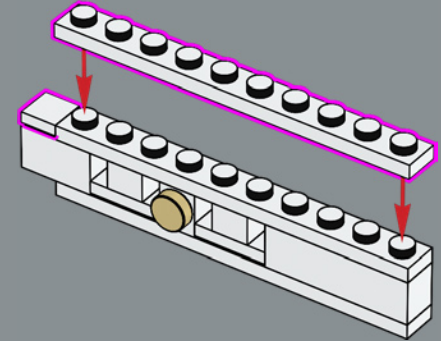

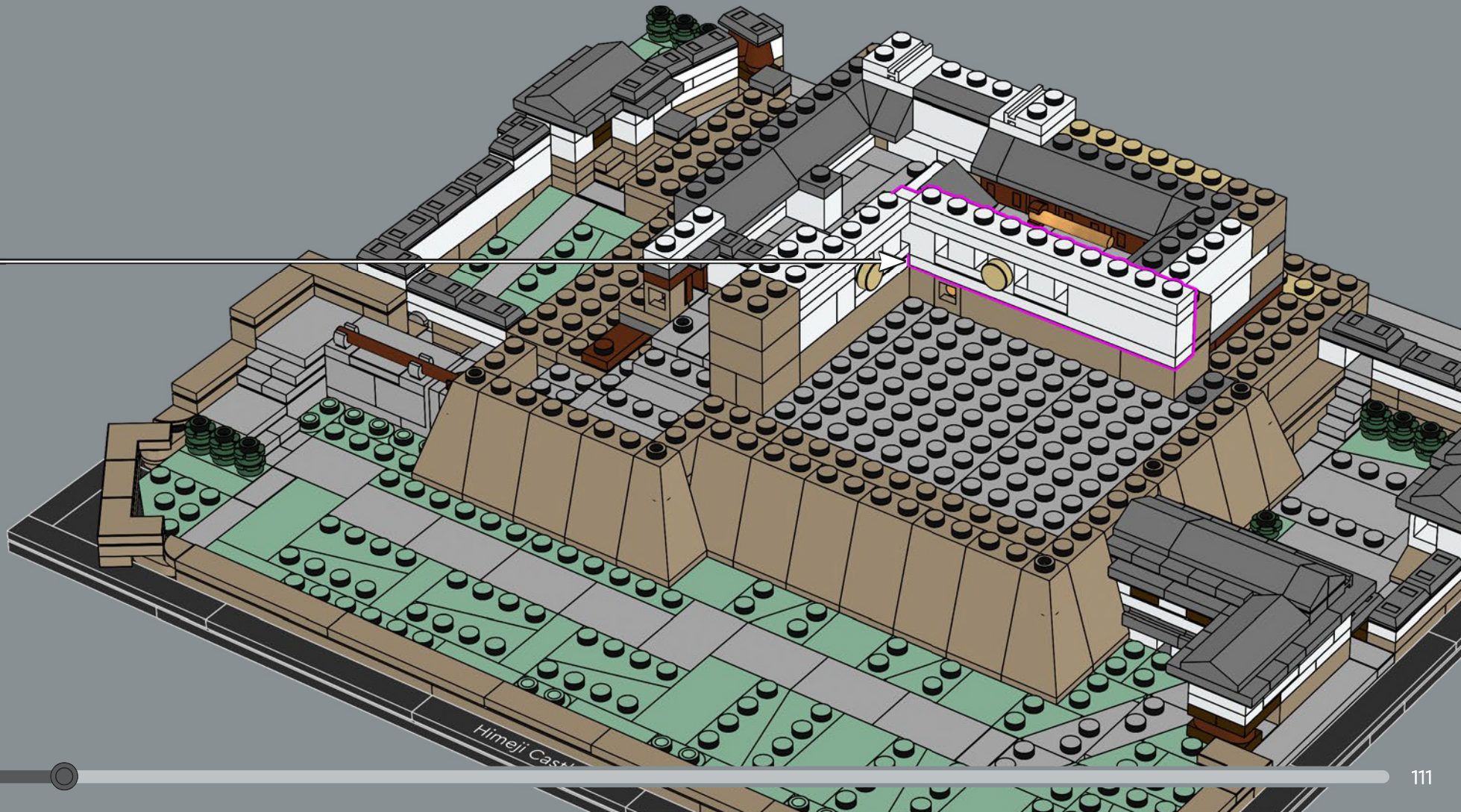

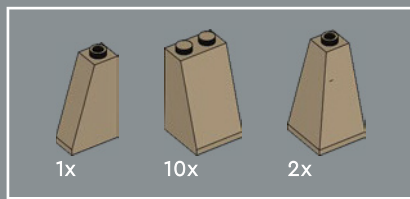

154

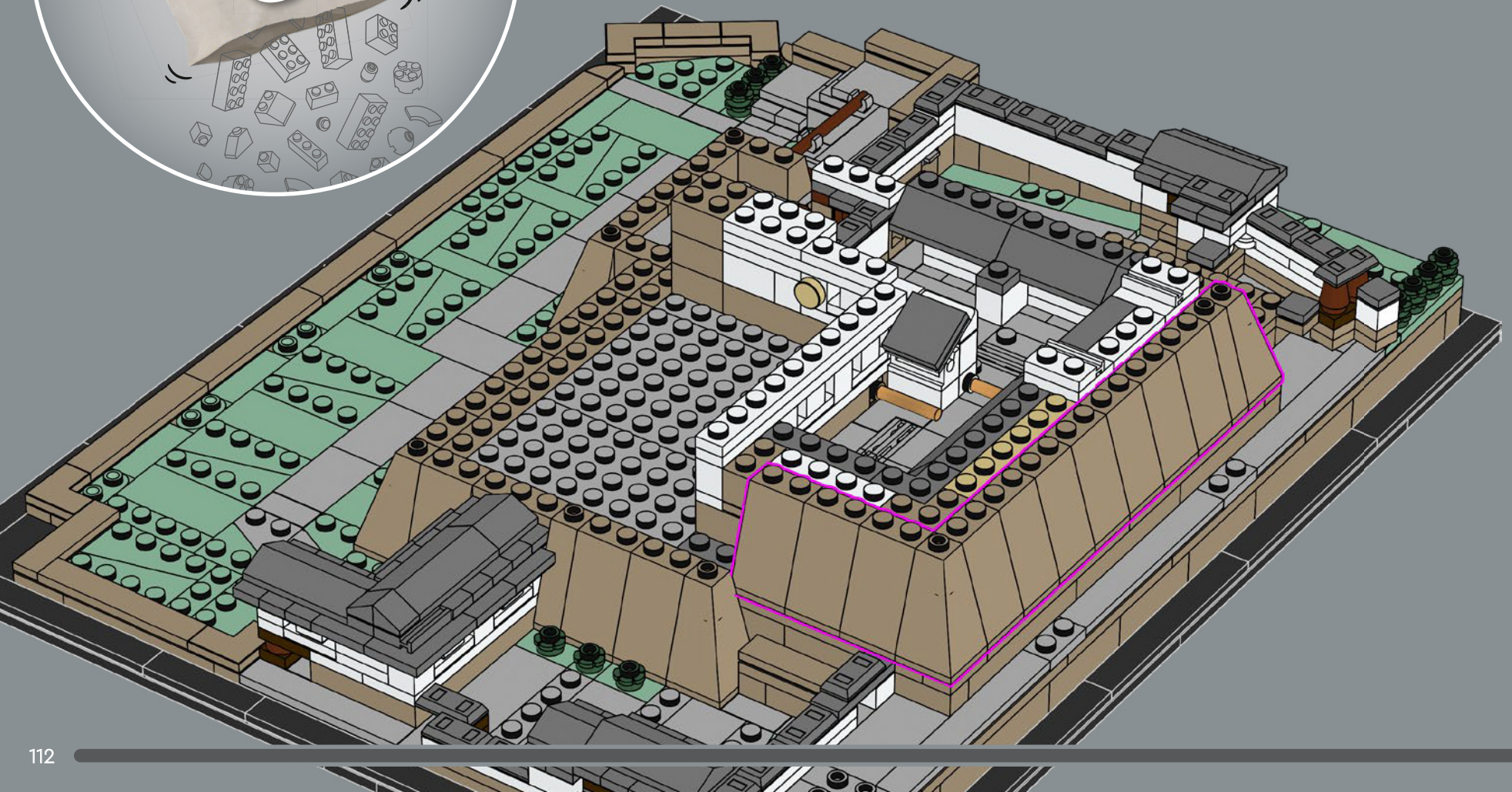

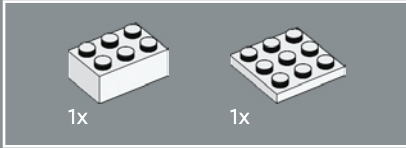

155

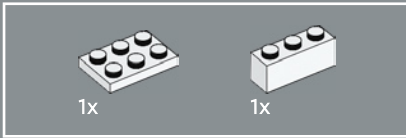
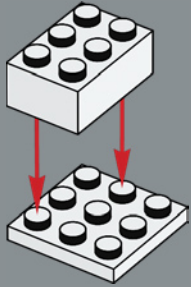

156

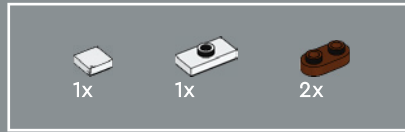
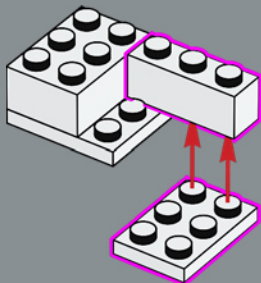

157

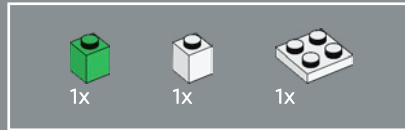
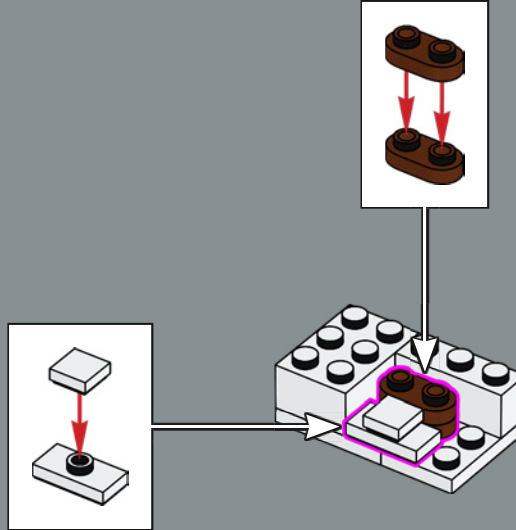

158

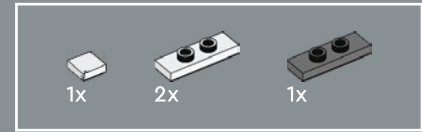
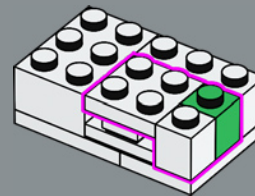

159

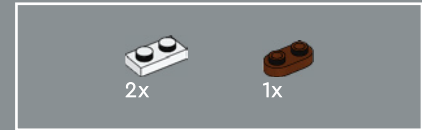
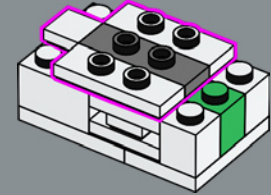

160

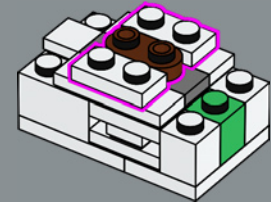

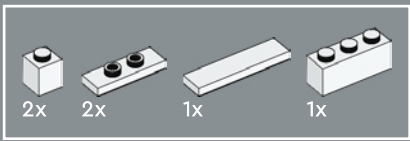

161

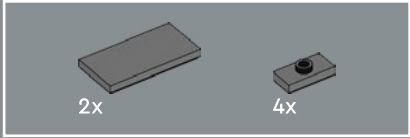
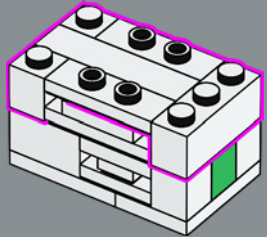

162

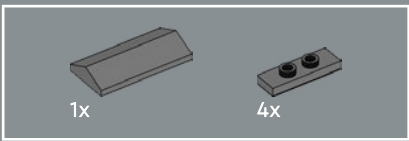
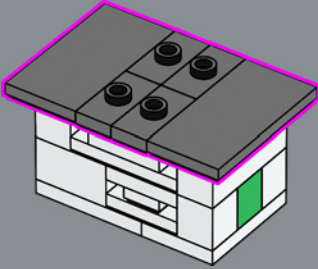

163

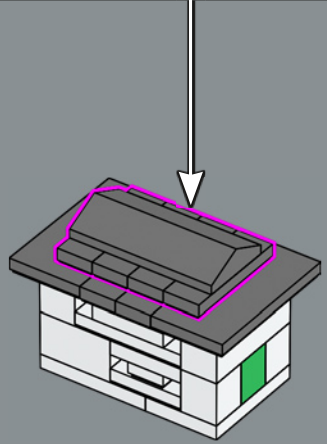
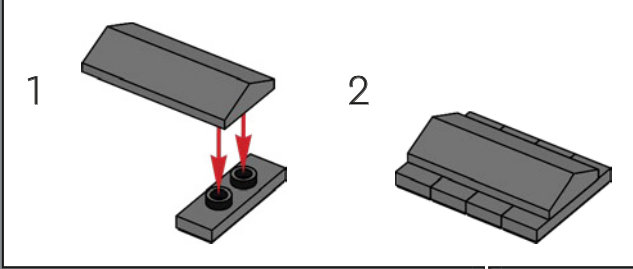

164

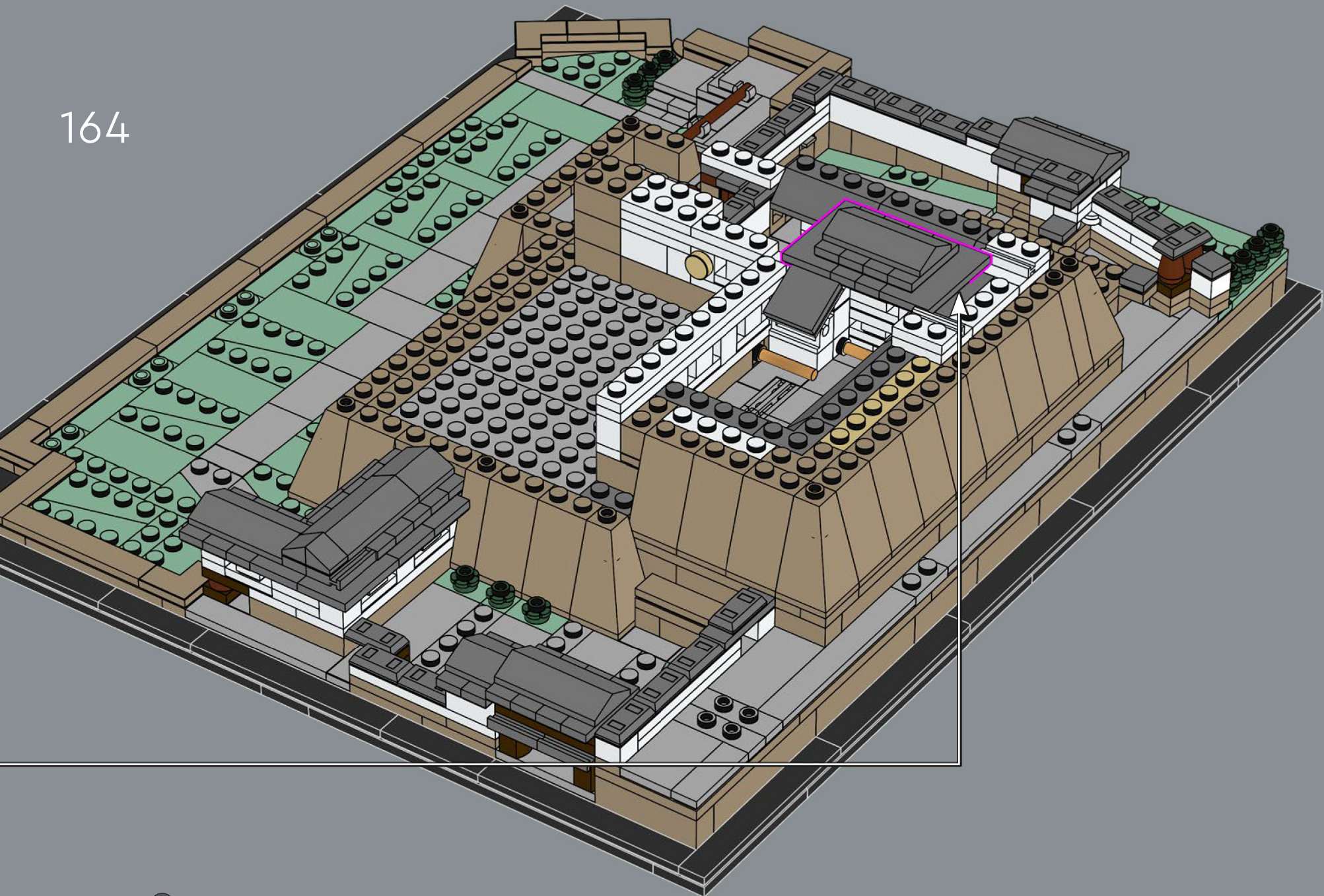

169

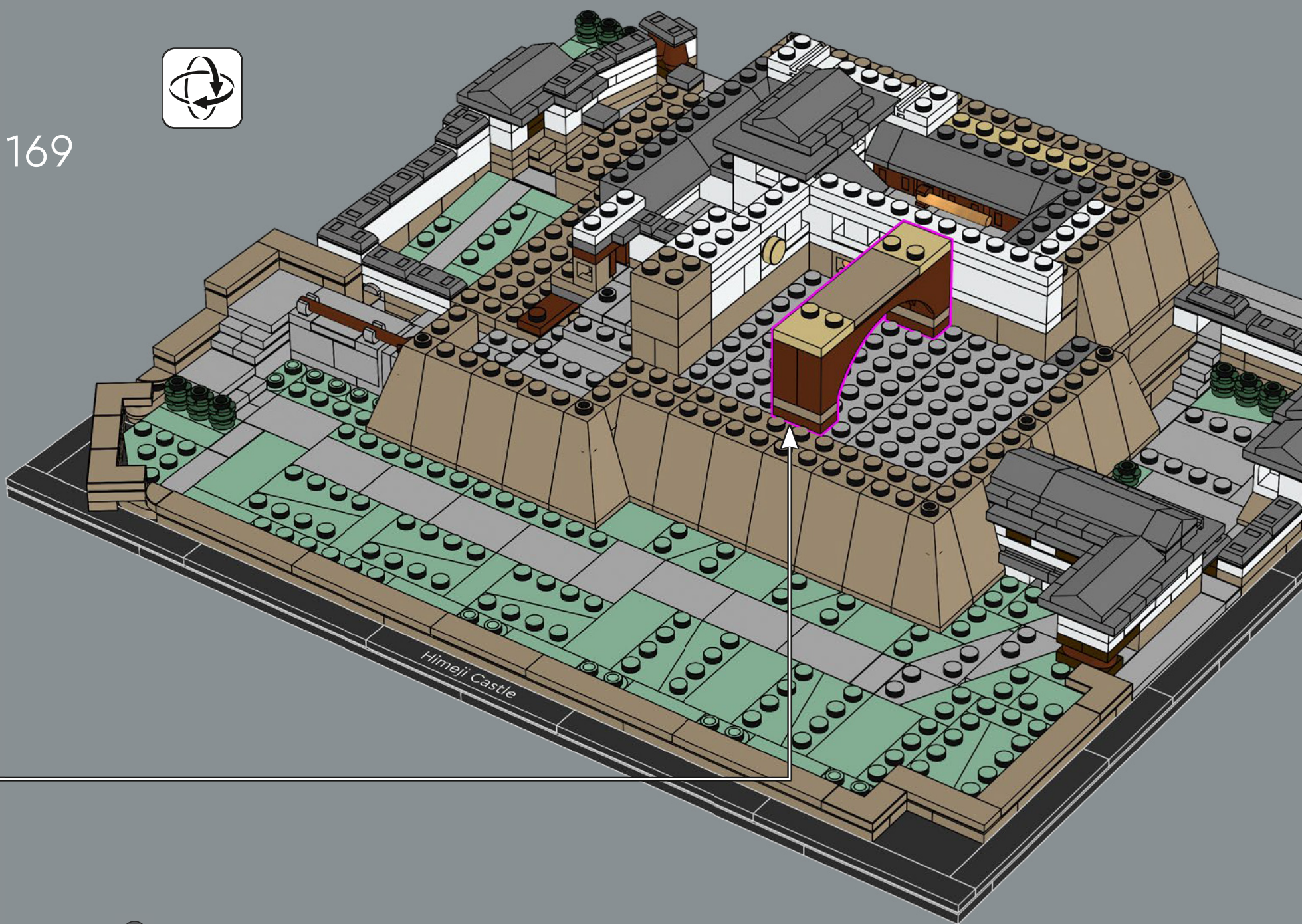

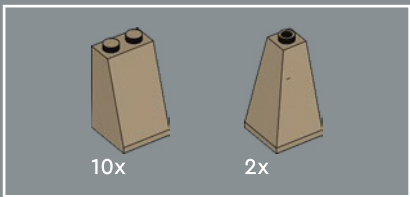

170

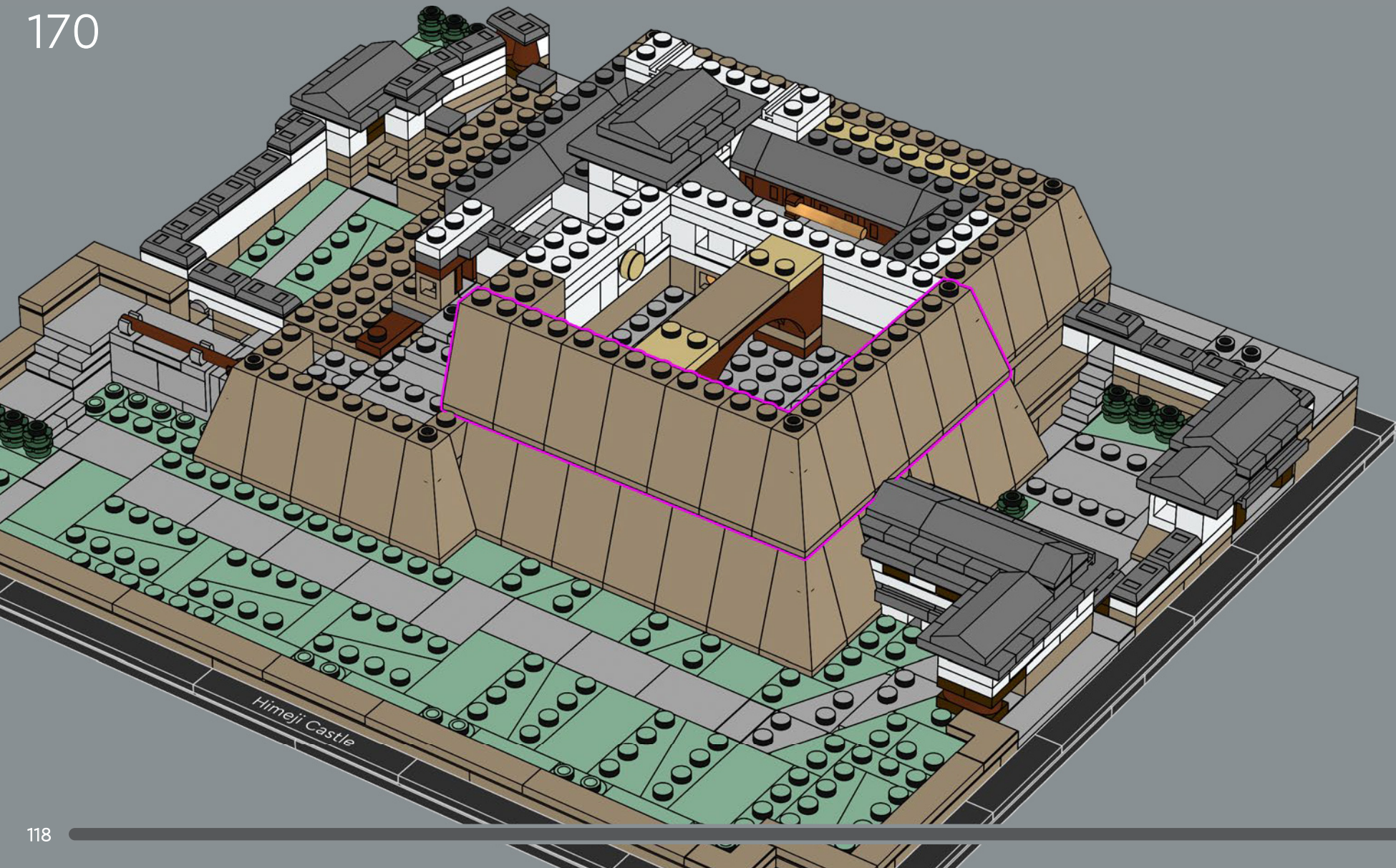

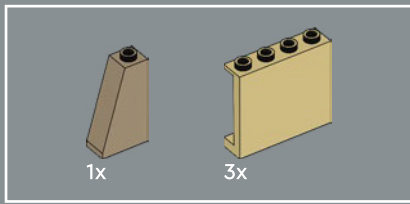

171



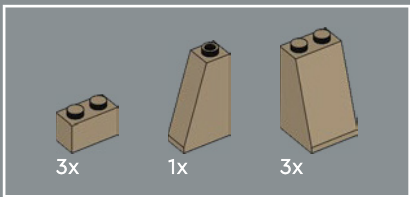

172

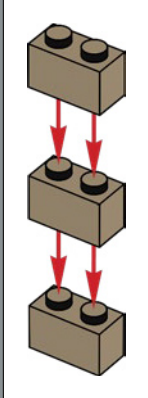

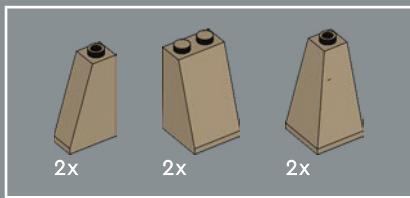

173



Himeji Castle

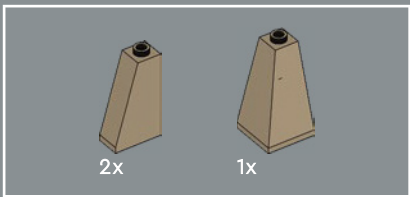

174

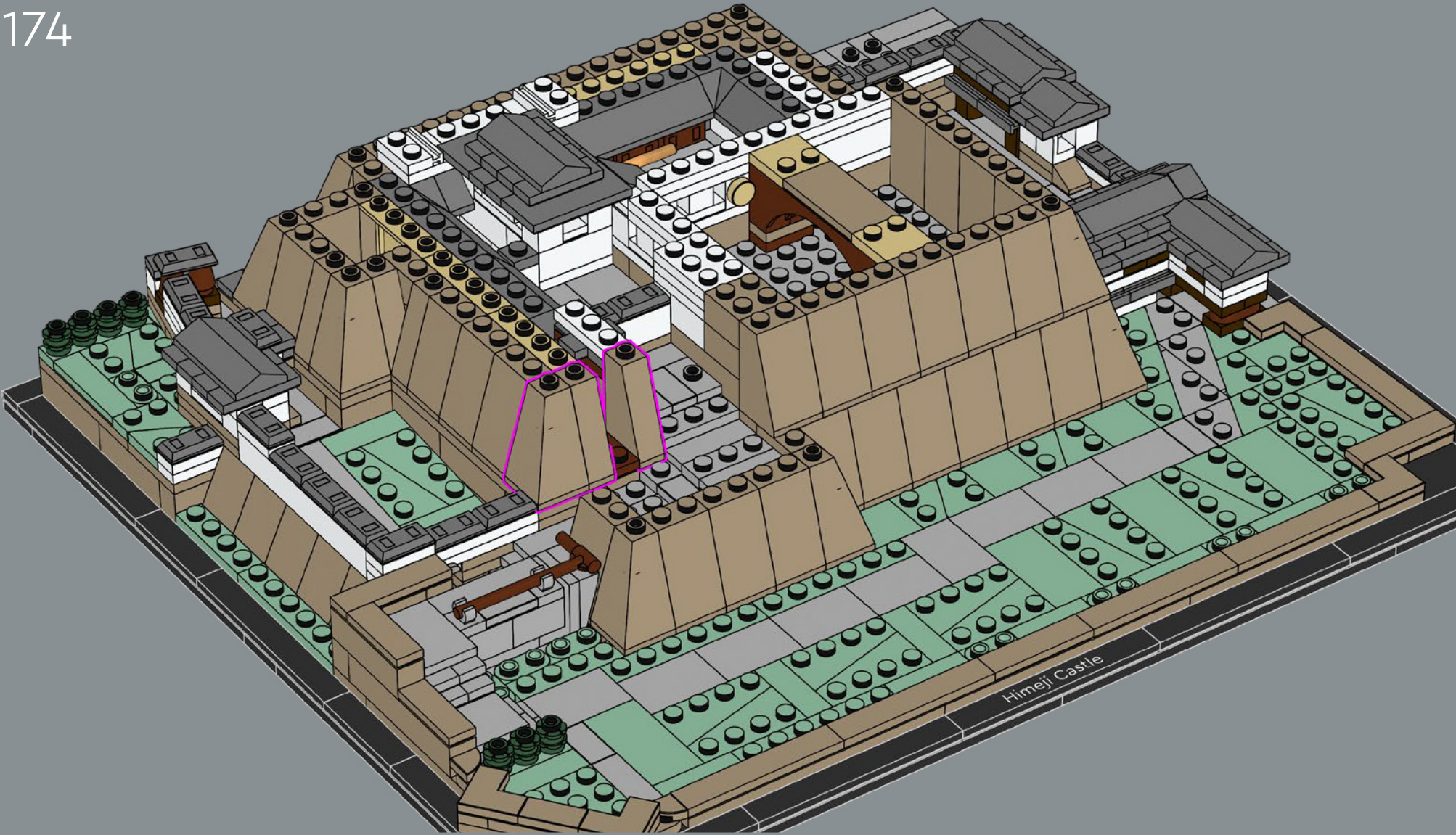

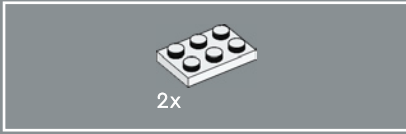
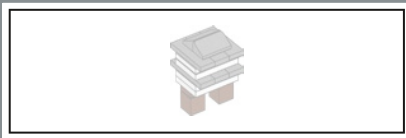

175

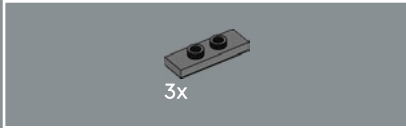
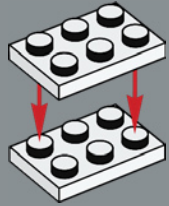

176

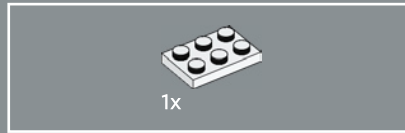
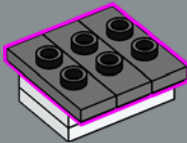

177

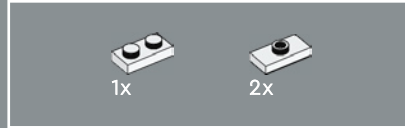
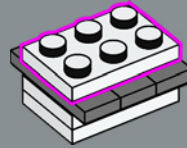

178

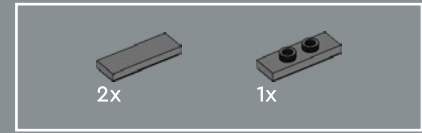
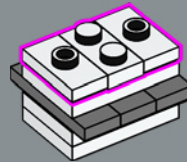

179

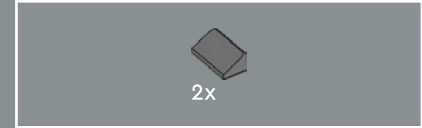
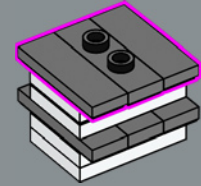

180

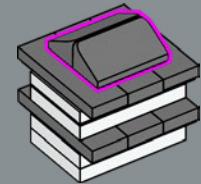

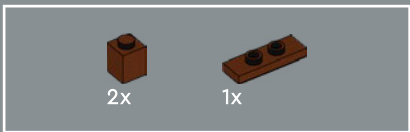

181

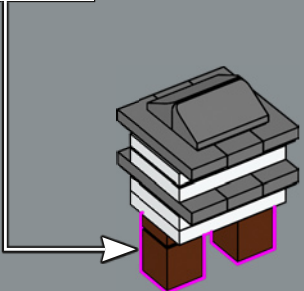
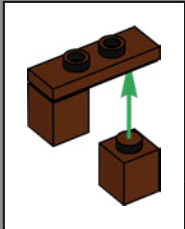

182



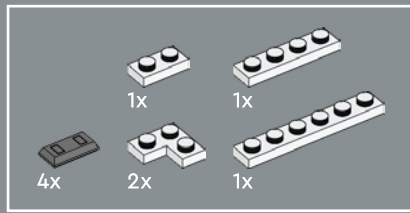

183

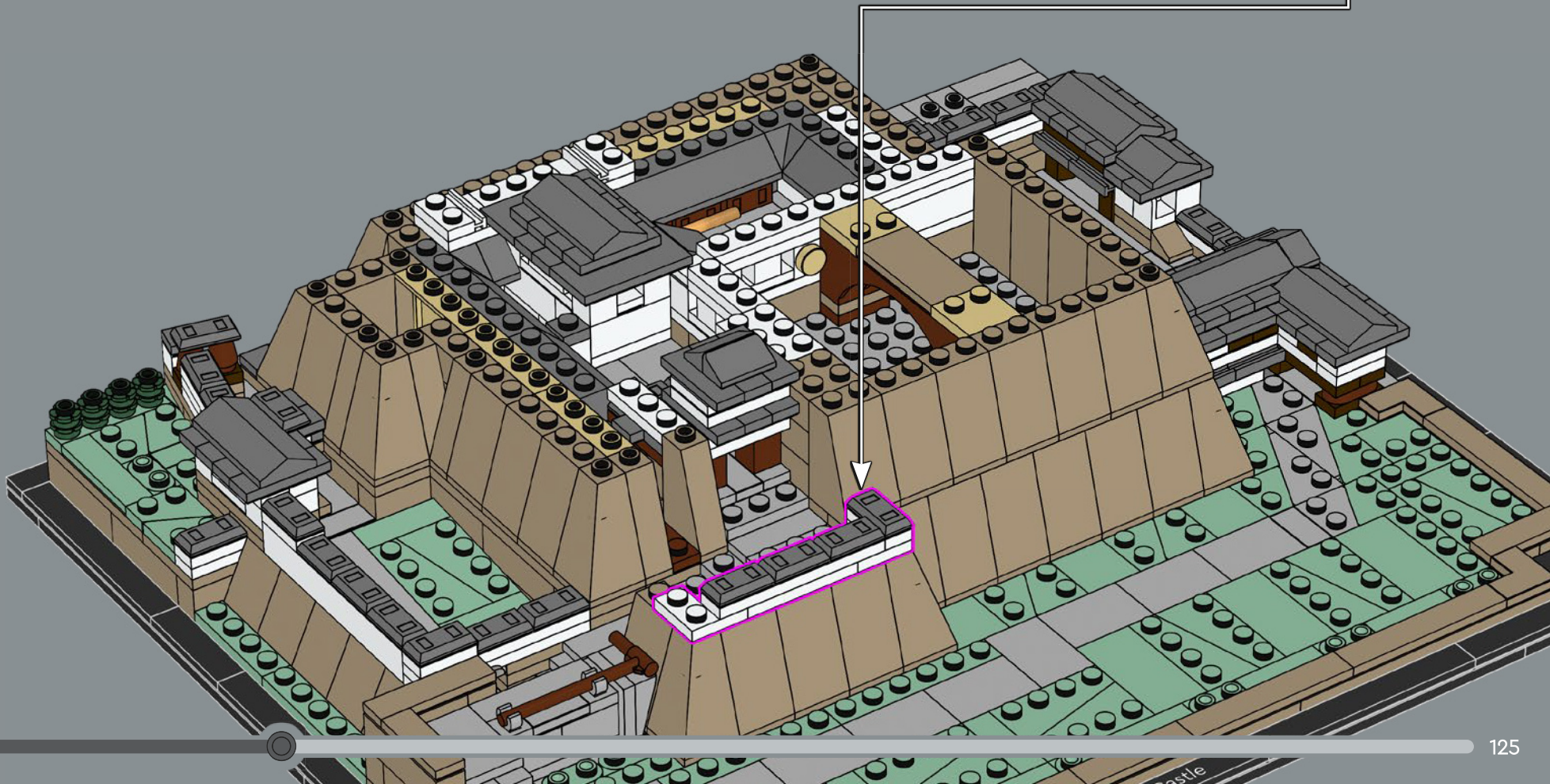
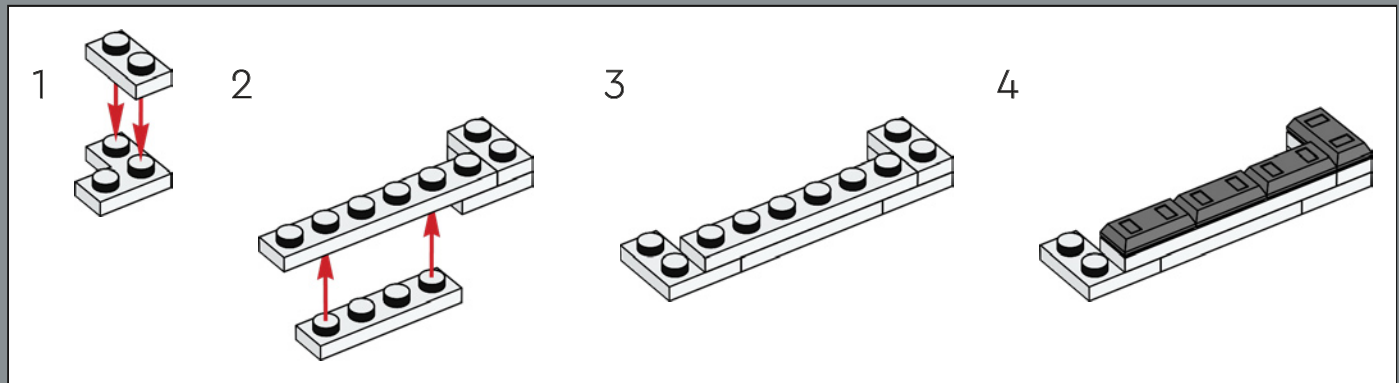

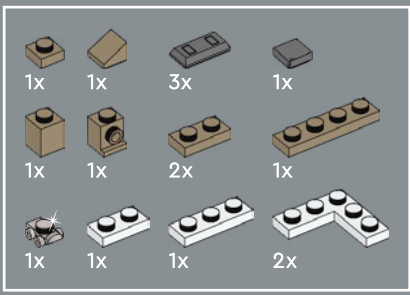

184

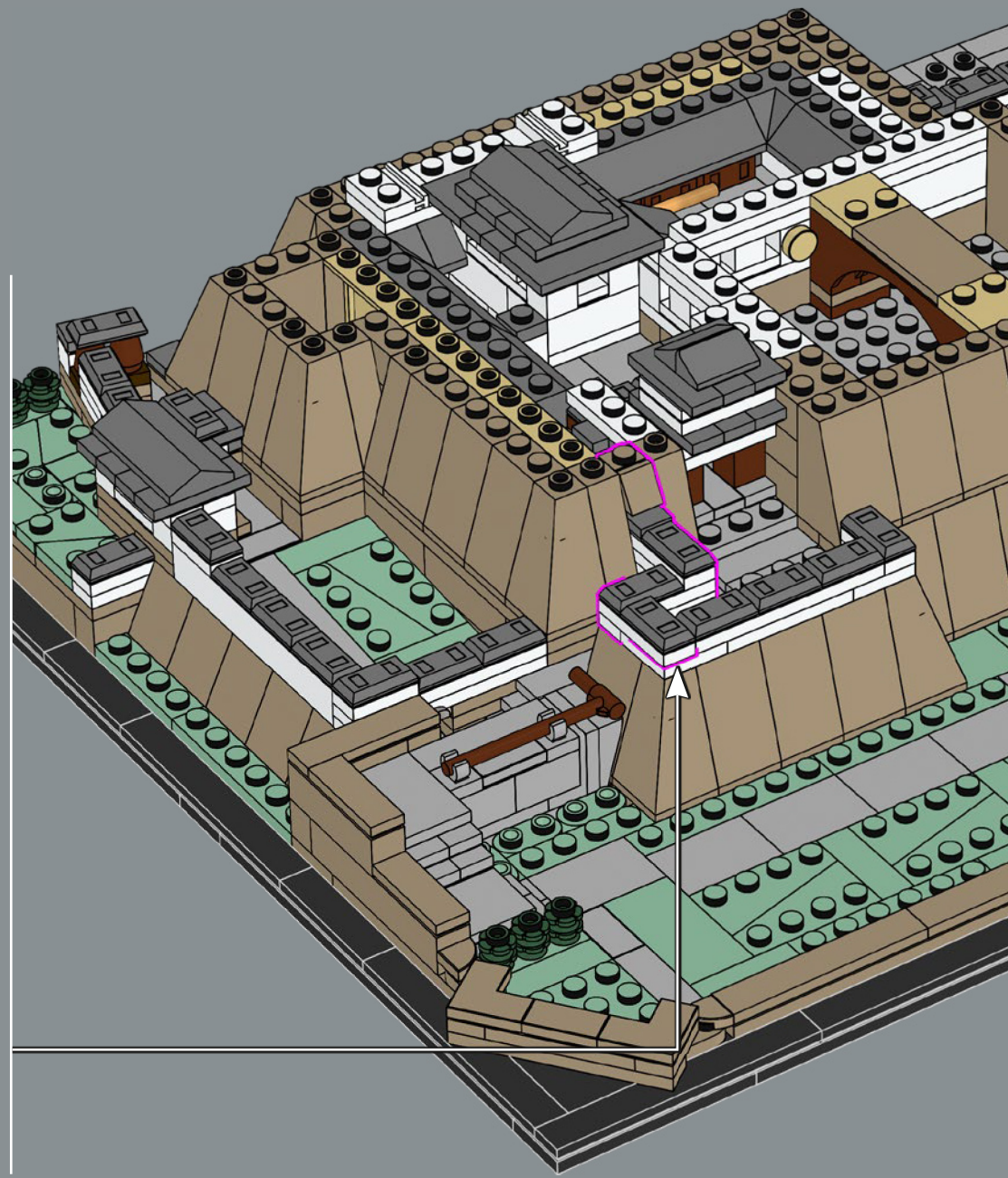
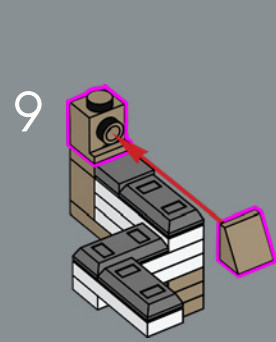
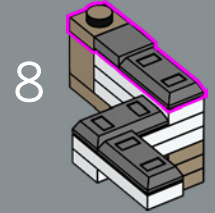
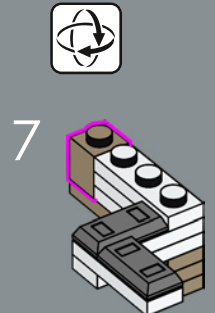
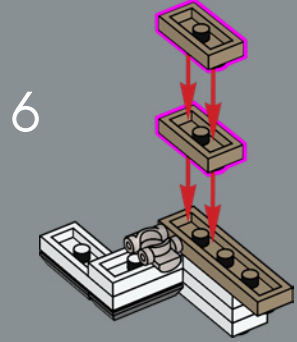
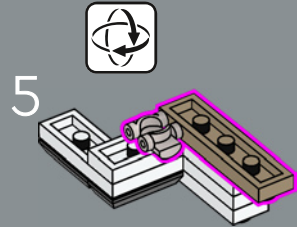
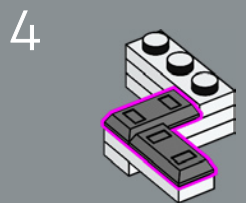
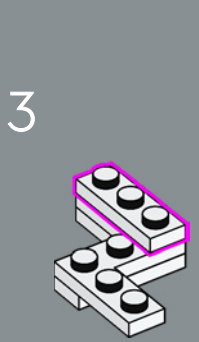
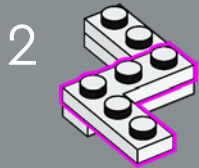
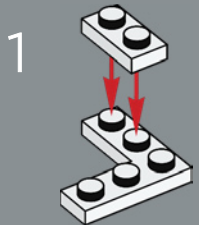

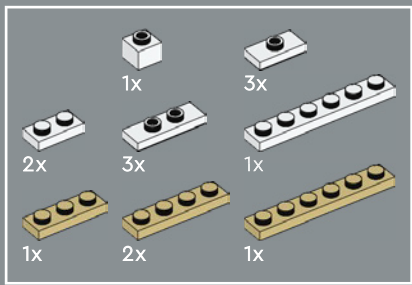

186

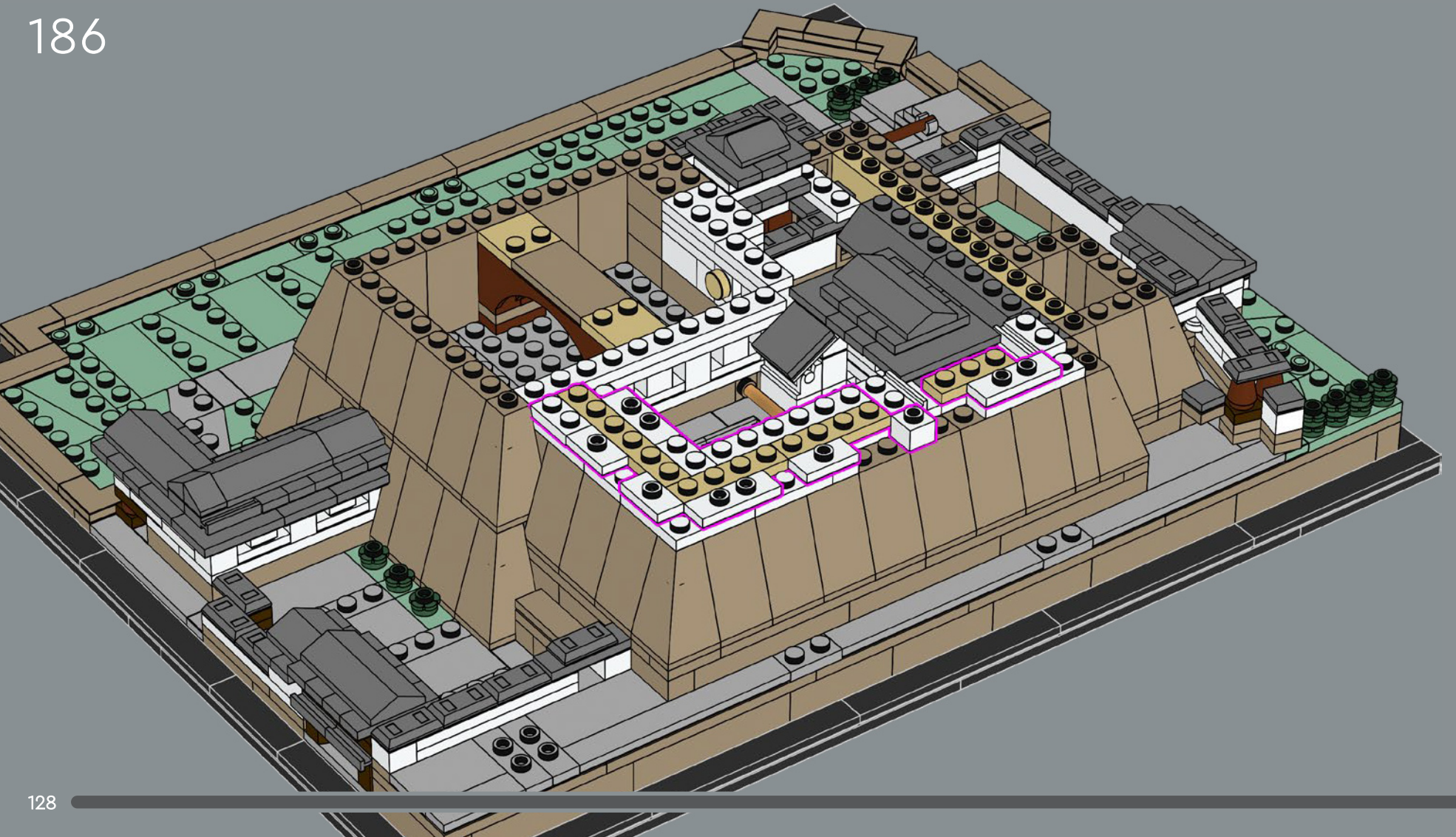

Au cours de la rénovation de 2009 à 2015, plusieurs côtés de l'échafaudage extérieur arboraient des dessins au trait du château. Ainsi, le monument emblématique restait visible dans le panorama d'Himeji.

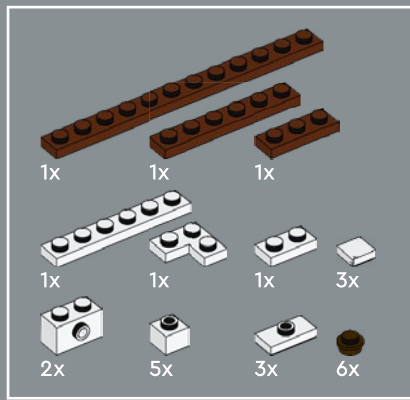

187



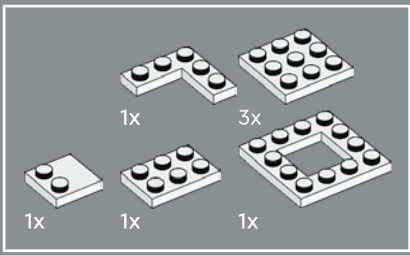

188

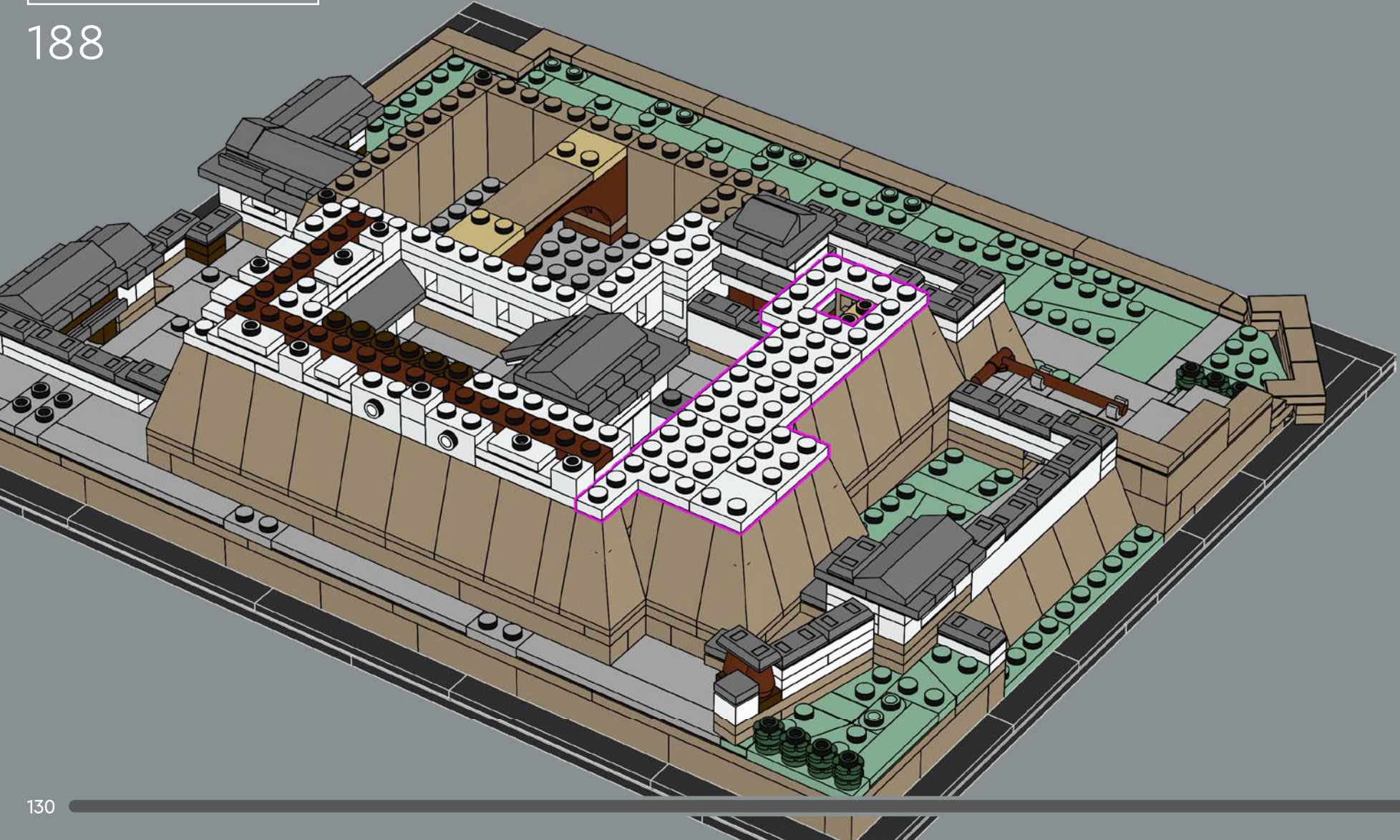

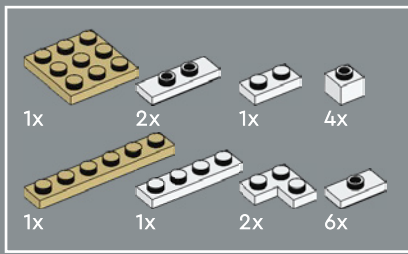

189



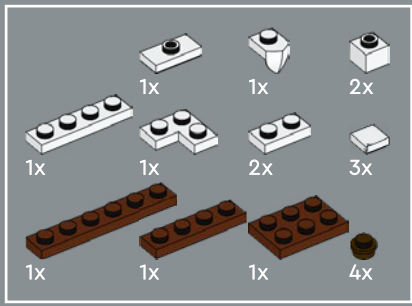

190



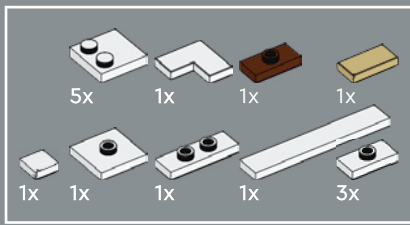

191

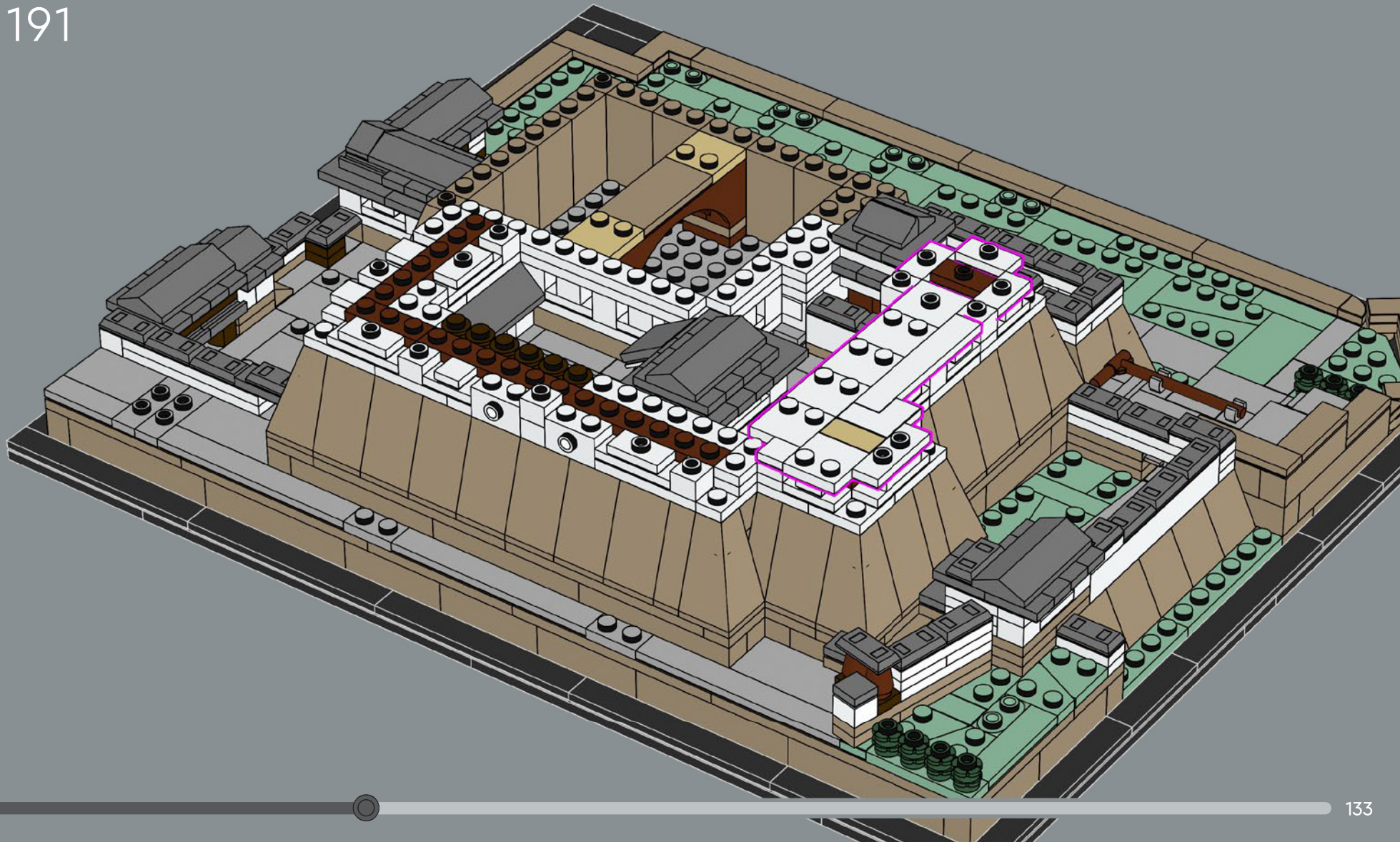

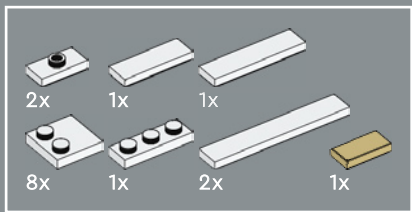

192

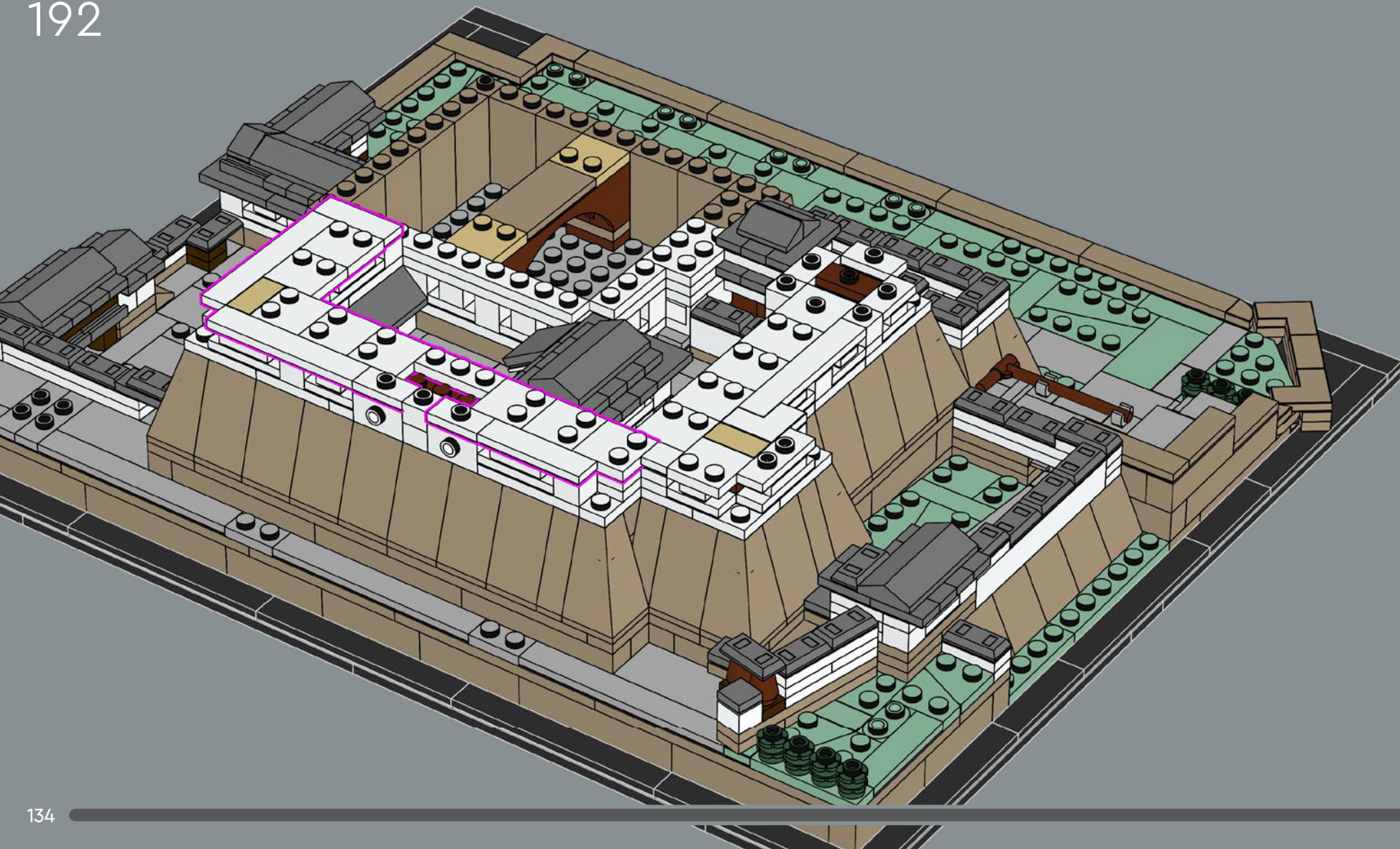

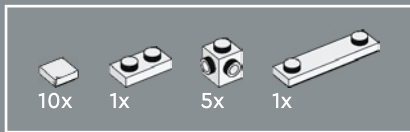

193

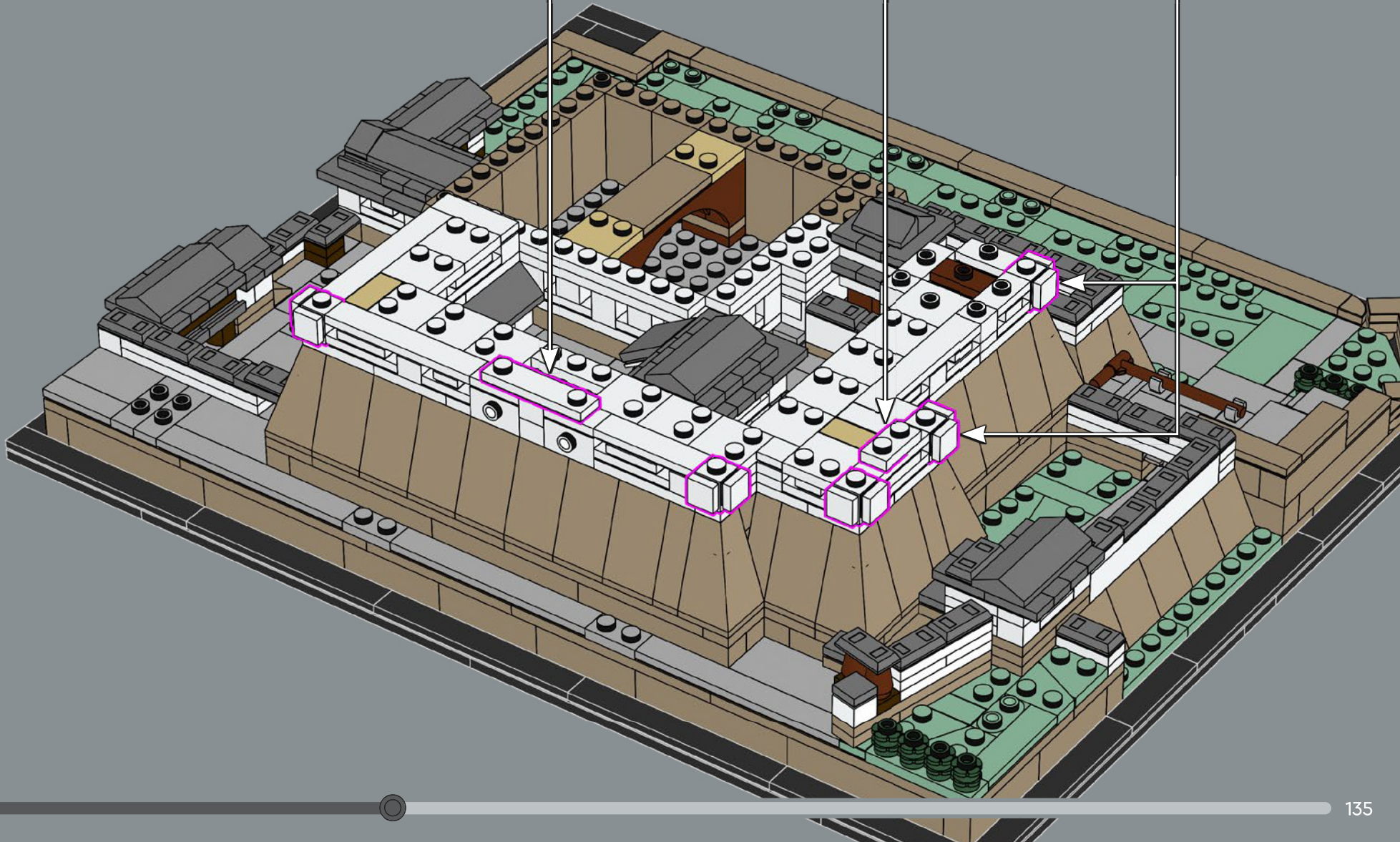
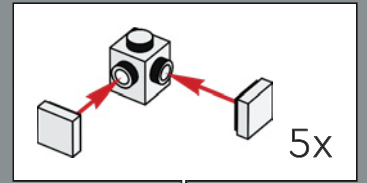
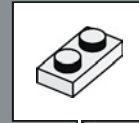
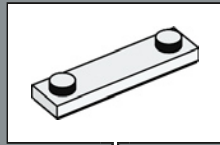

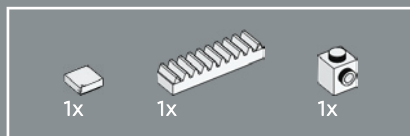

194

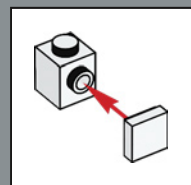
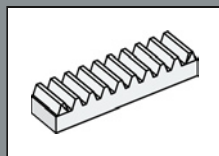

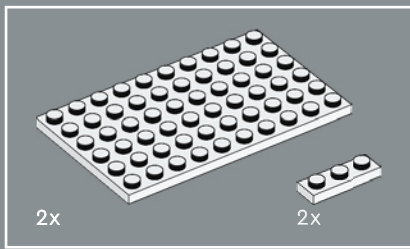

195

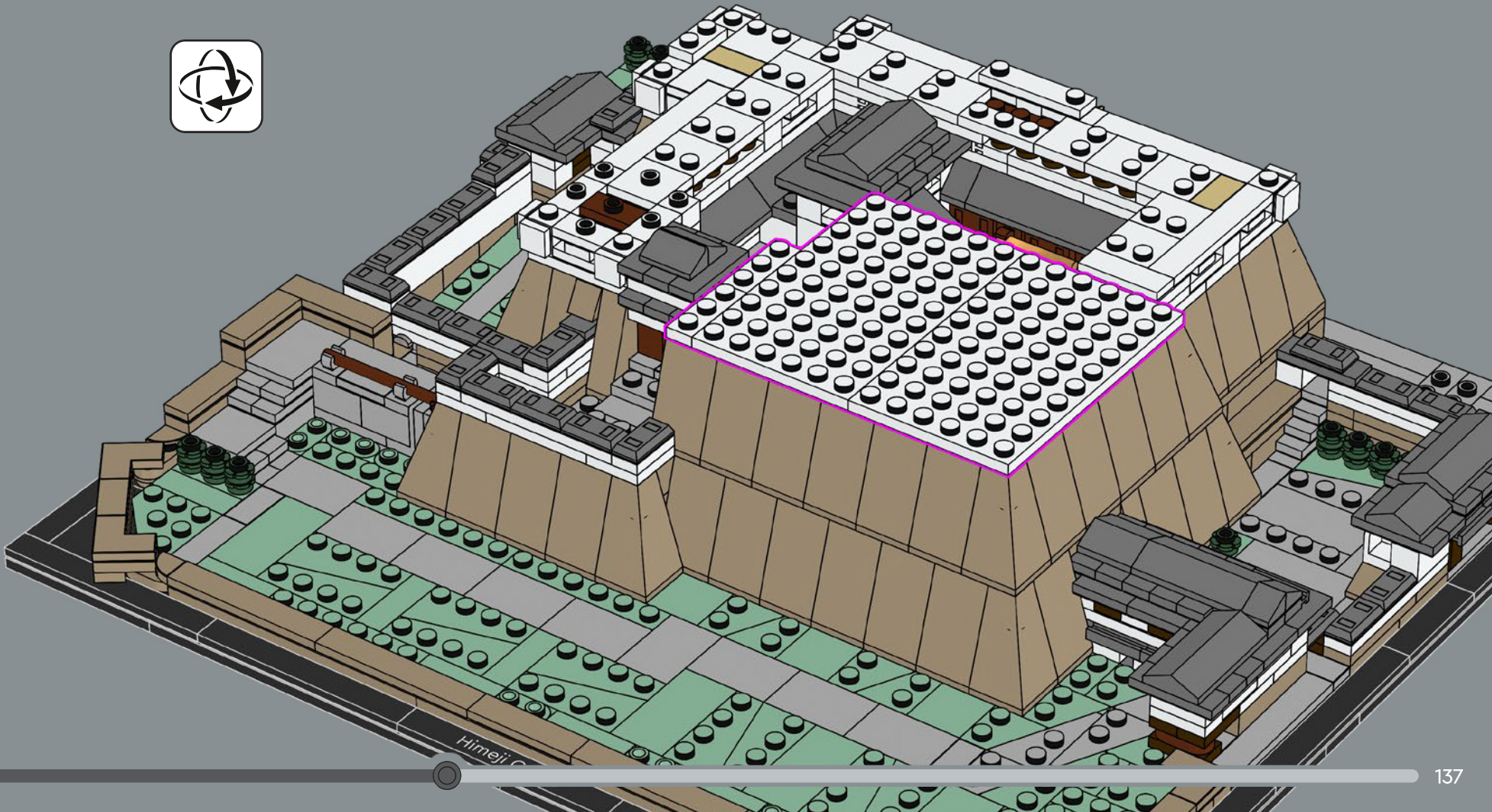

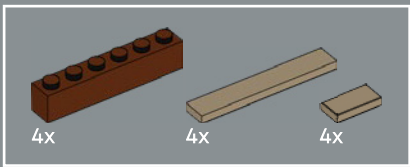

196

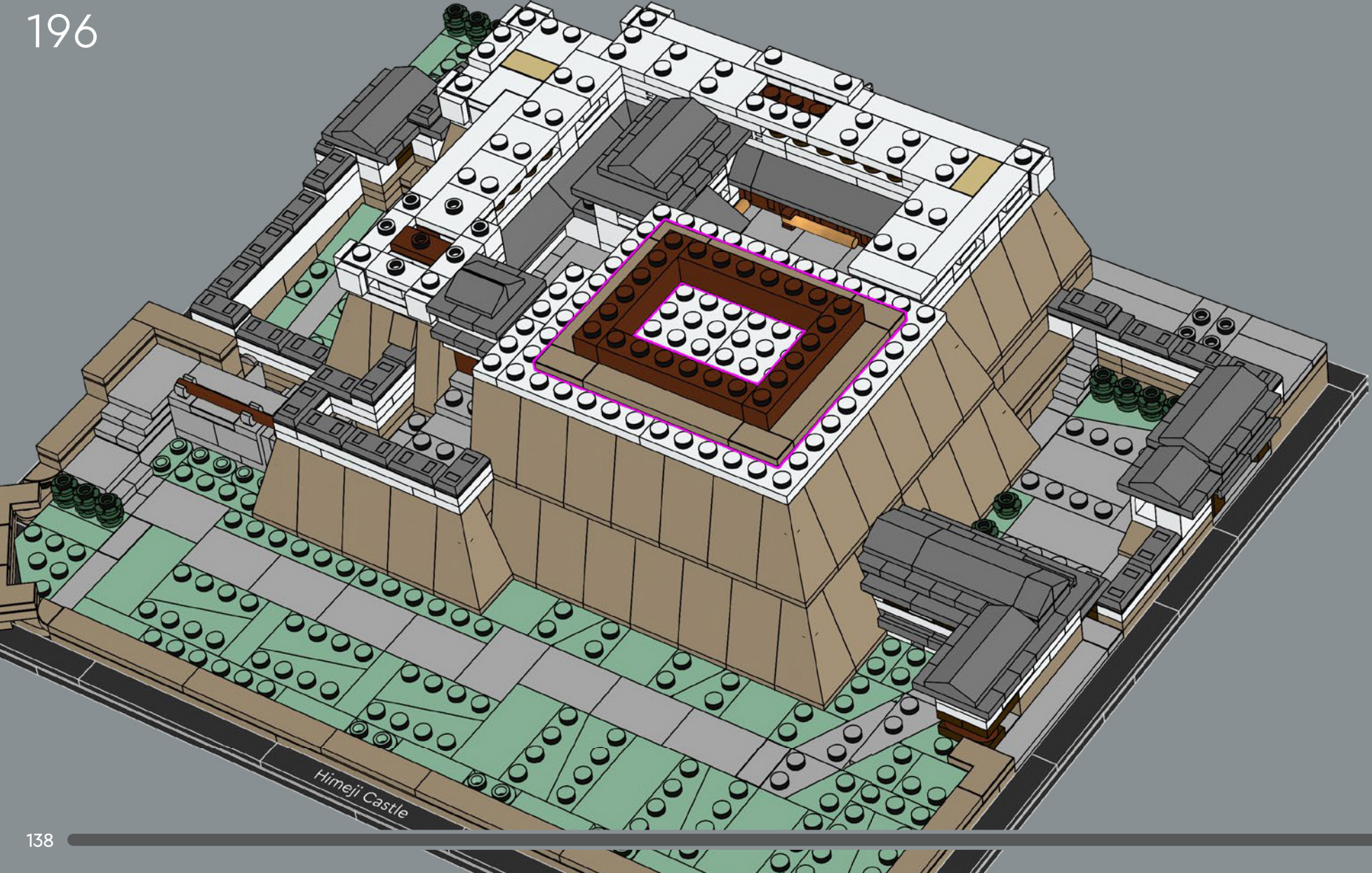

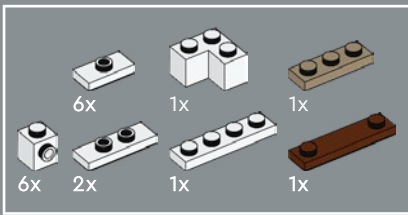

197

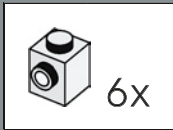
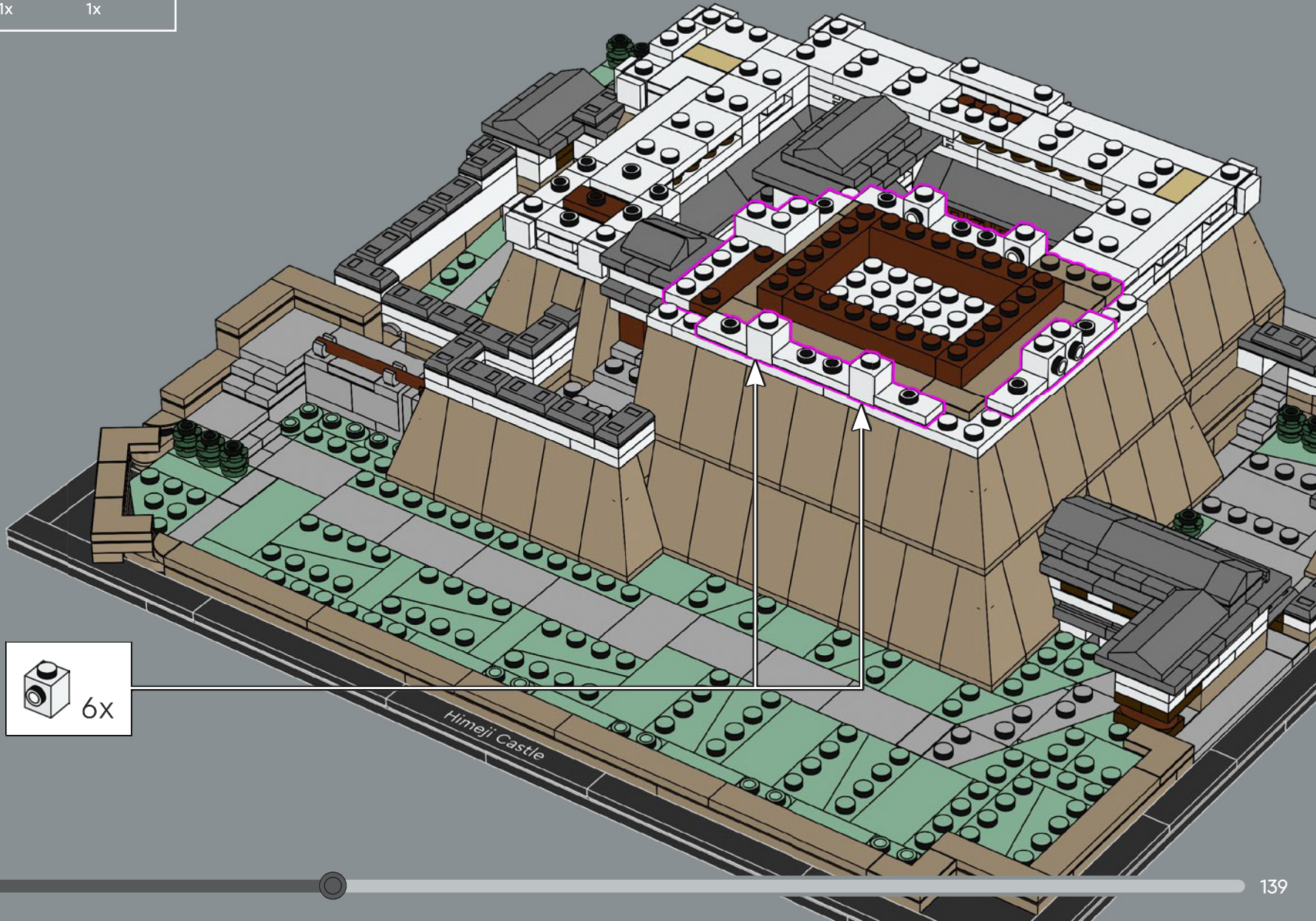

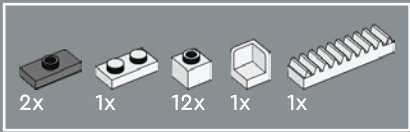

198

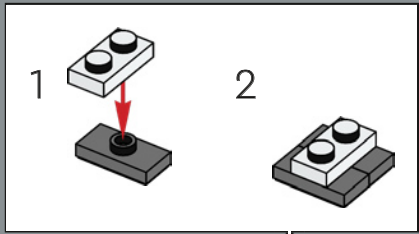

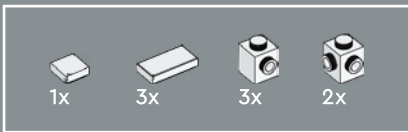

199

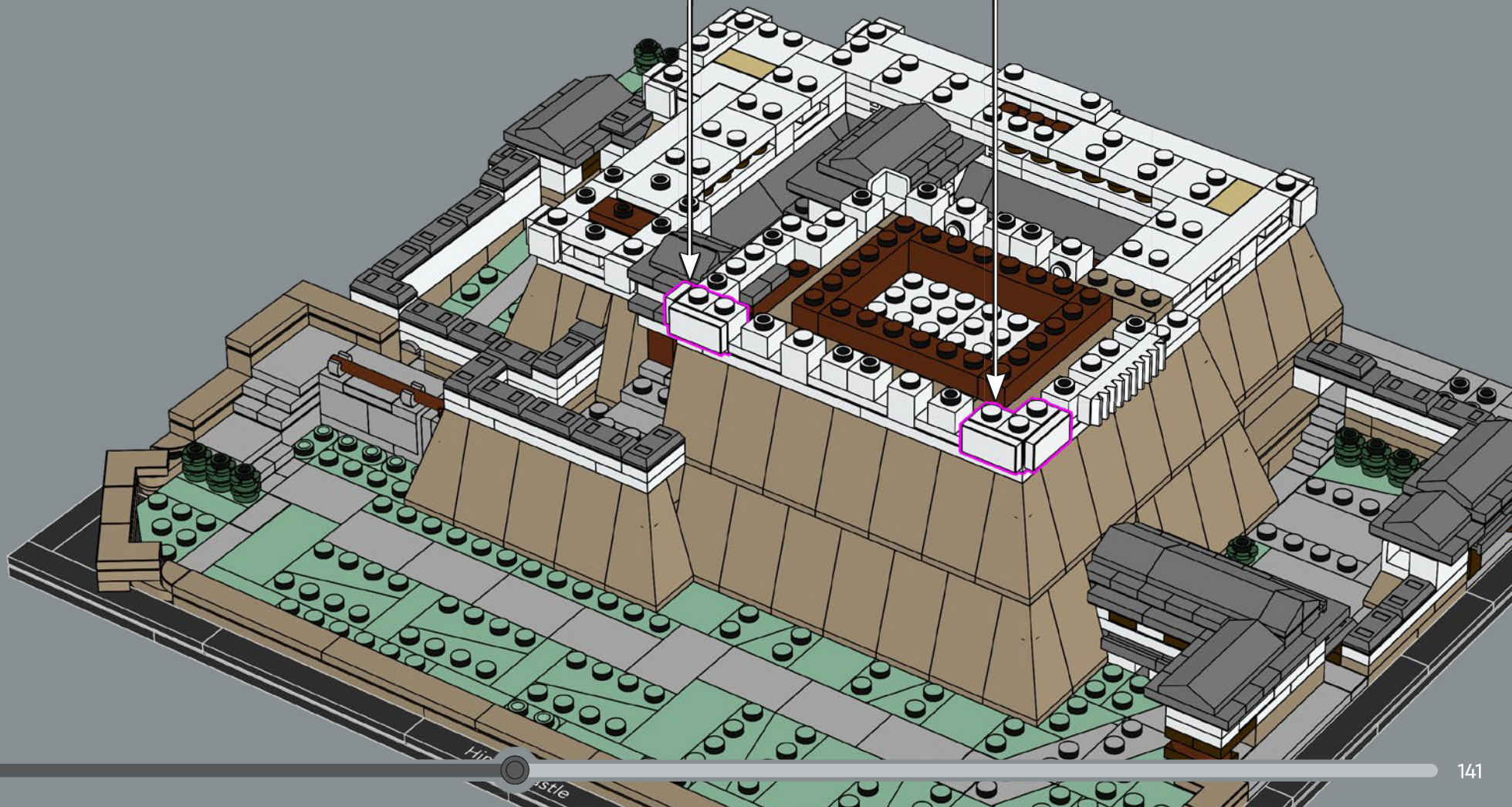
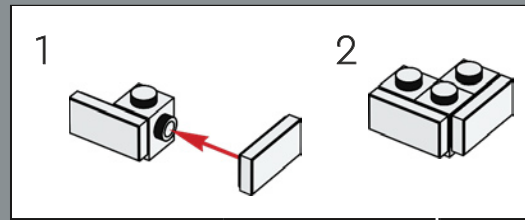
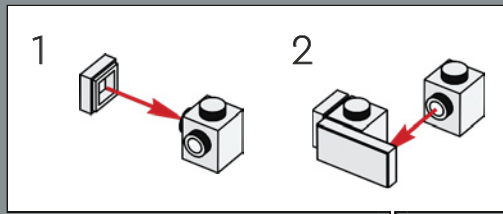

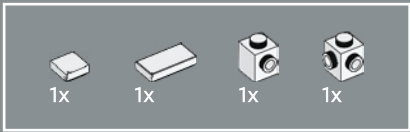

200

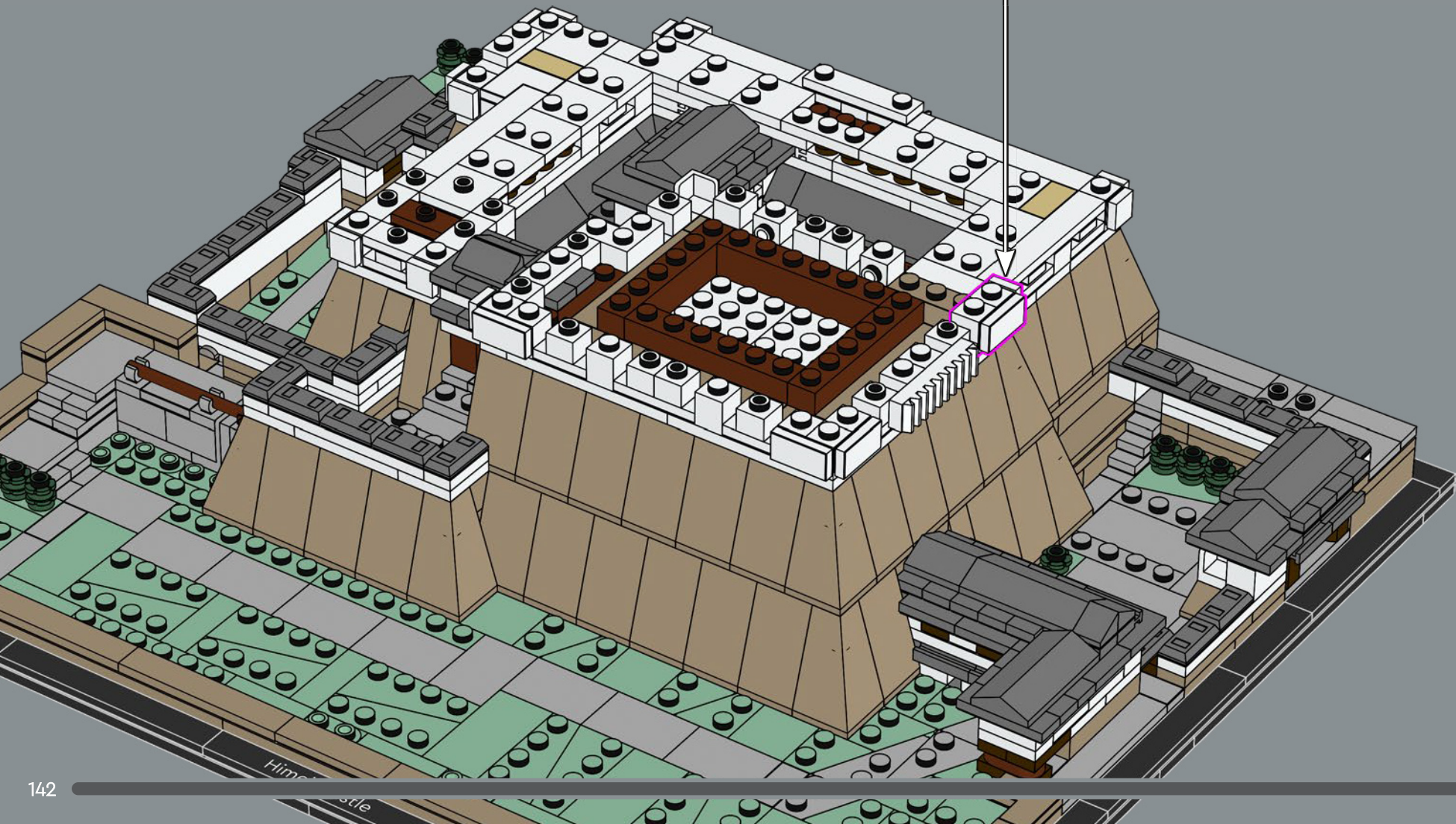
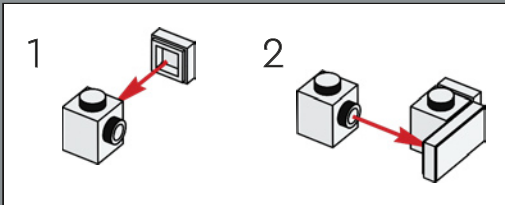

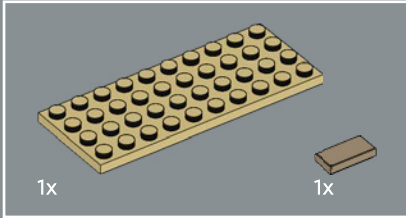
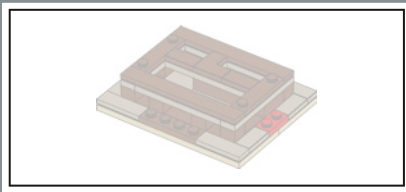

201

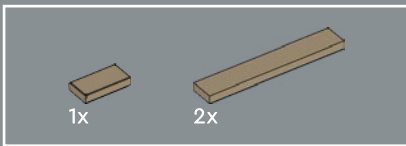
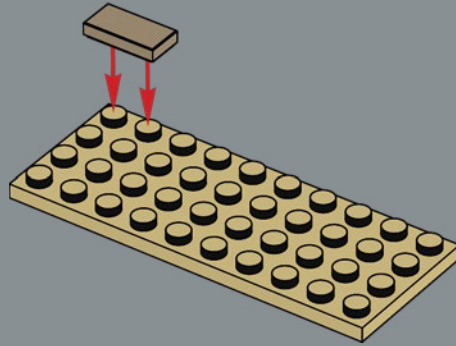

202

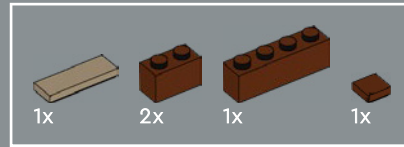
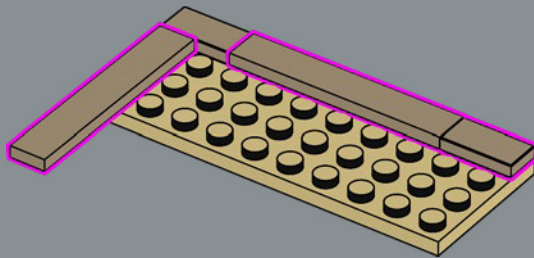

203

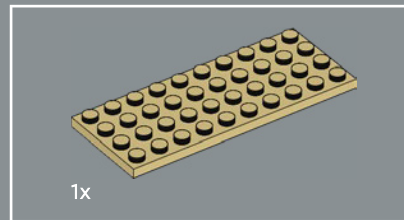
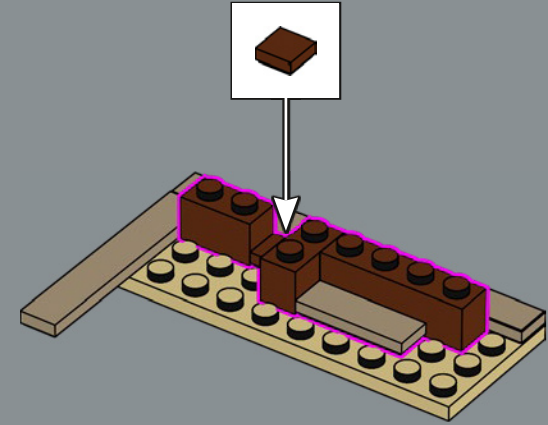

204

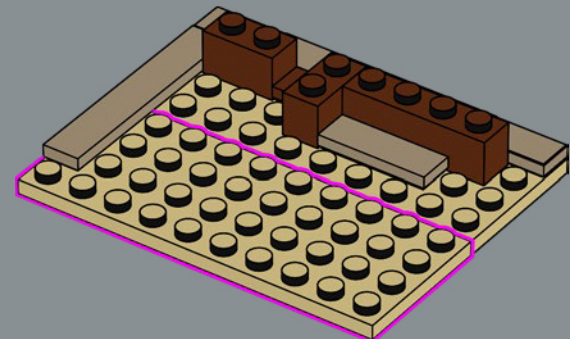

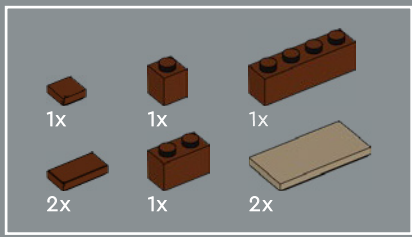

205

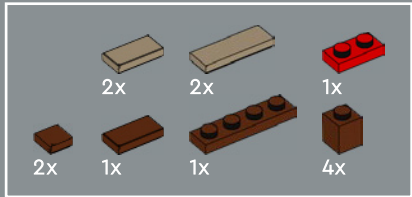
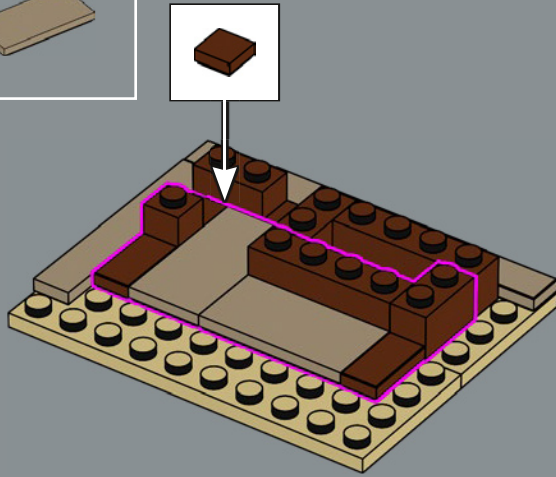

206

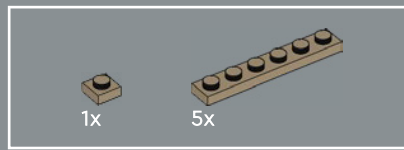
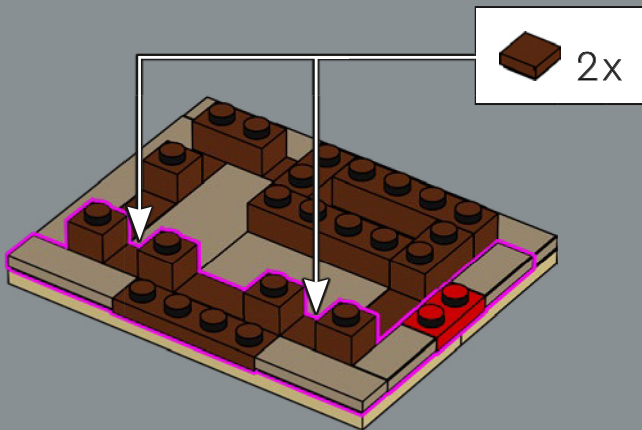

207

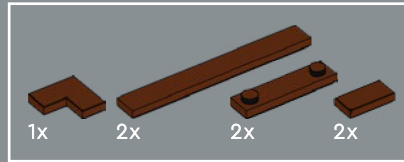
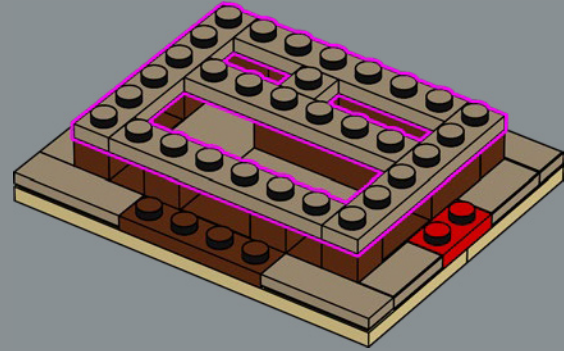

208

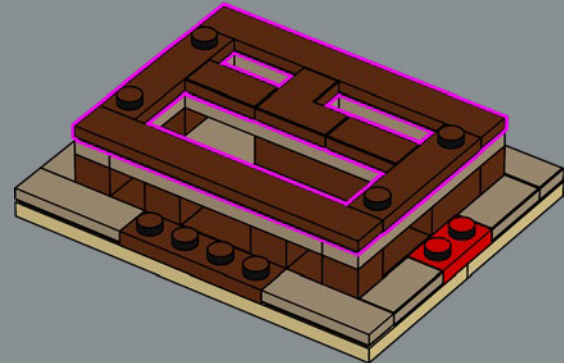

209

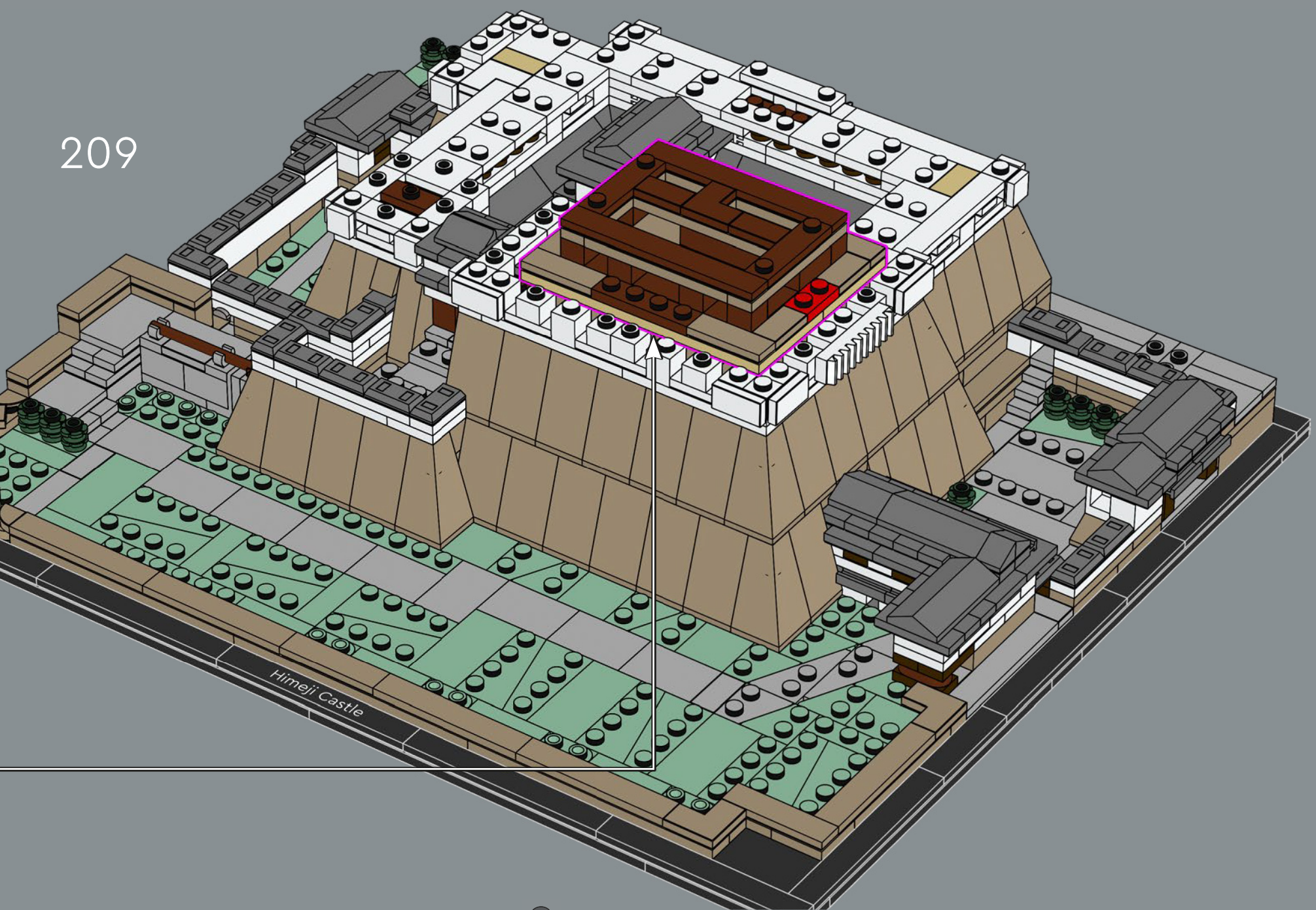

Himeji Castle

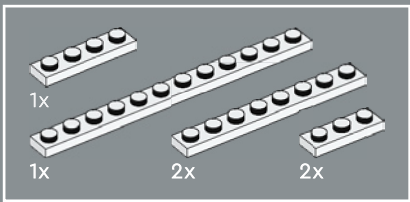

210

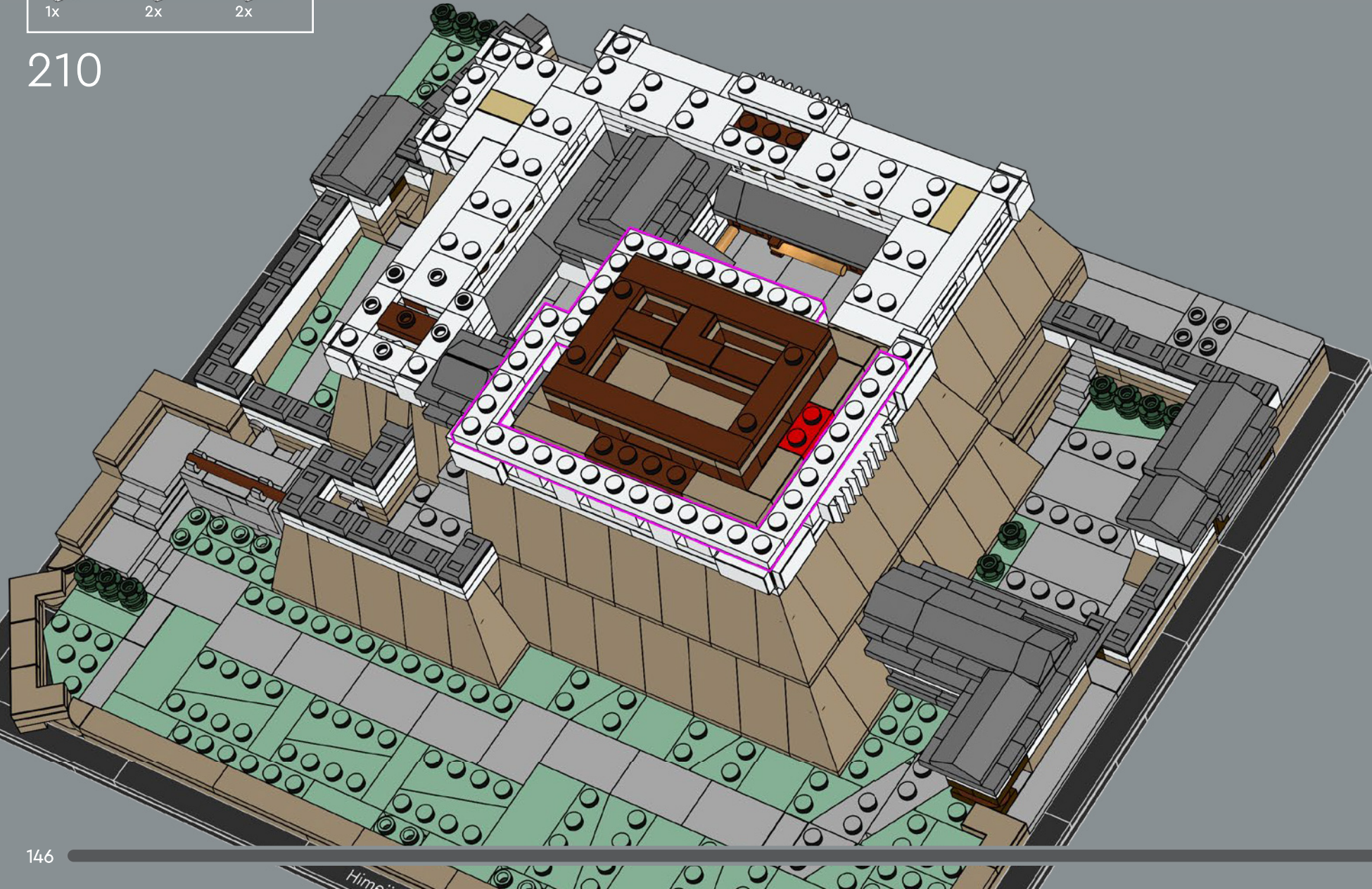

Bien que nous ayons dû respecter des angles de 90 degrés ou d'autres angles plus simples à reproduire, nous avons conservé certaines asymétries en hommage au château d'origine.

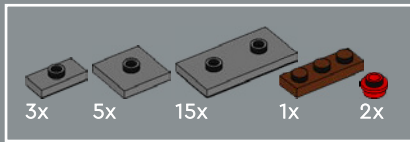

211

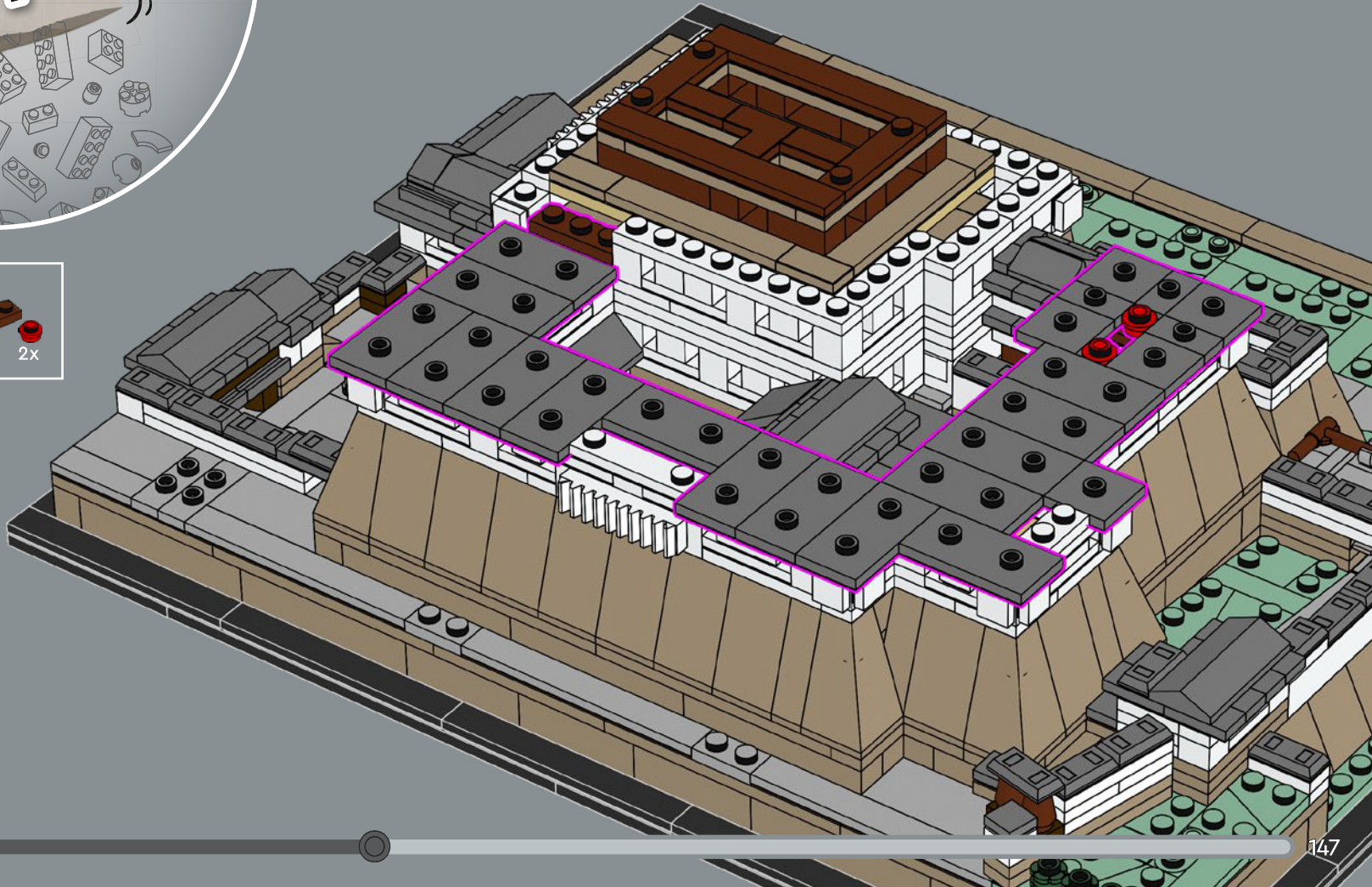

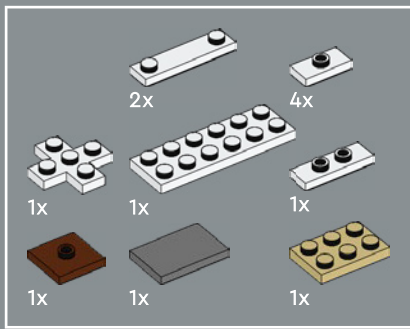

212

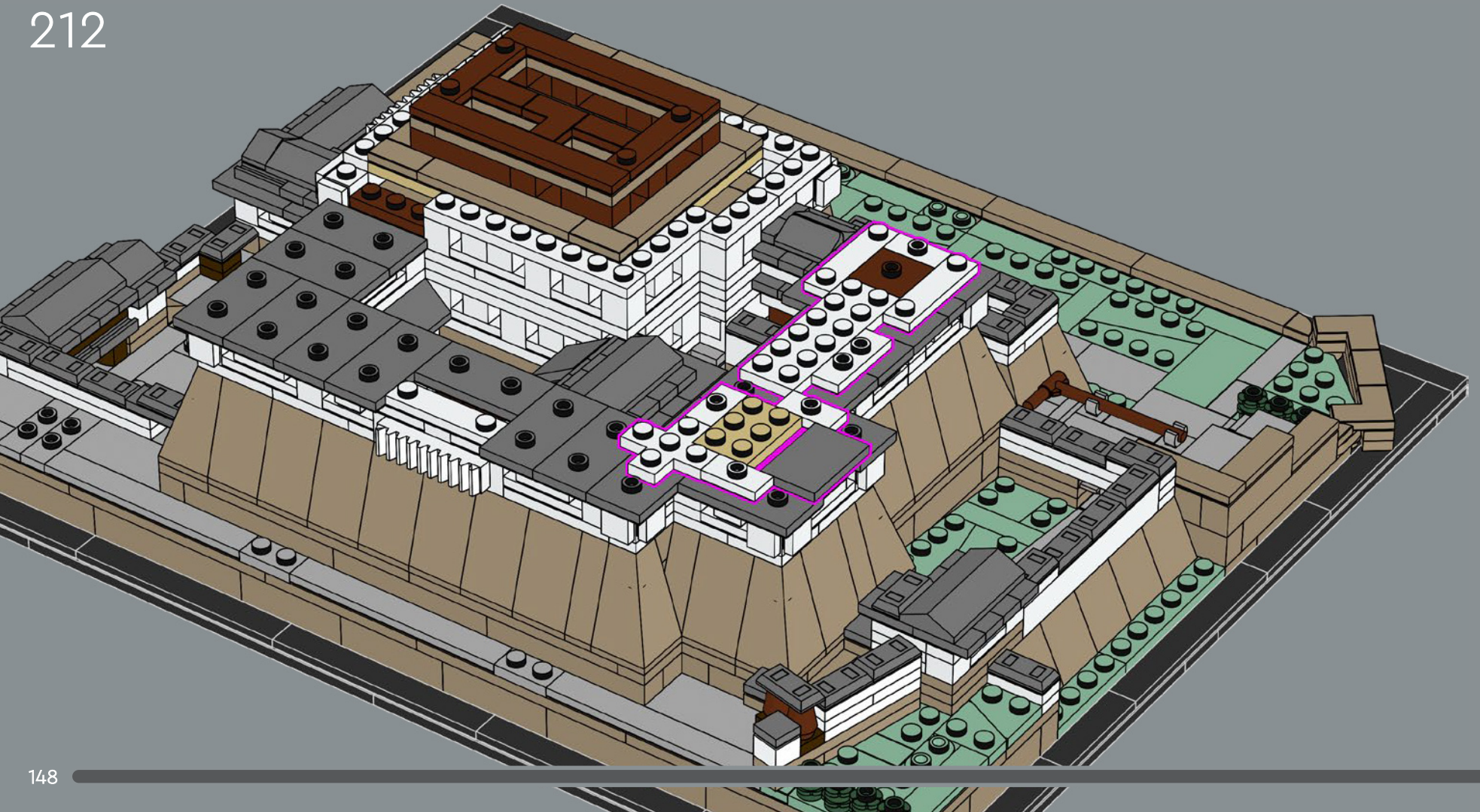

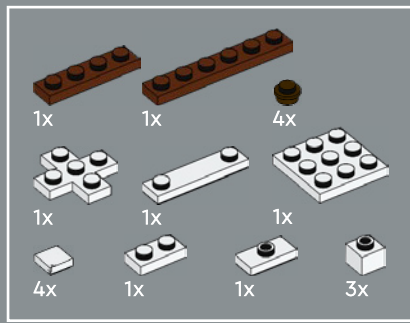

213

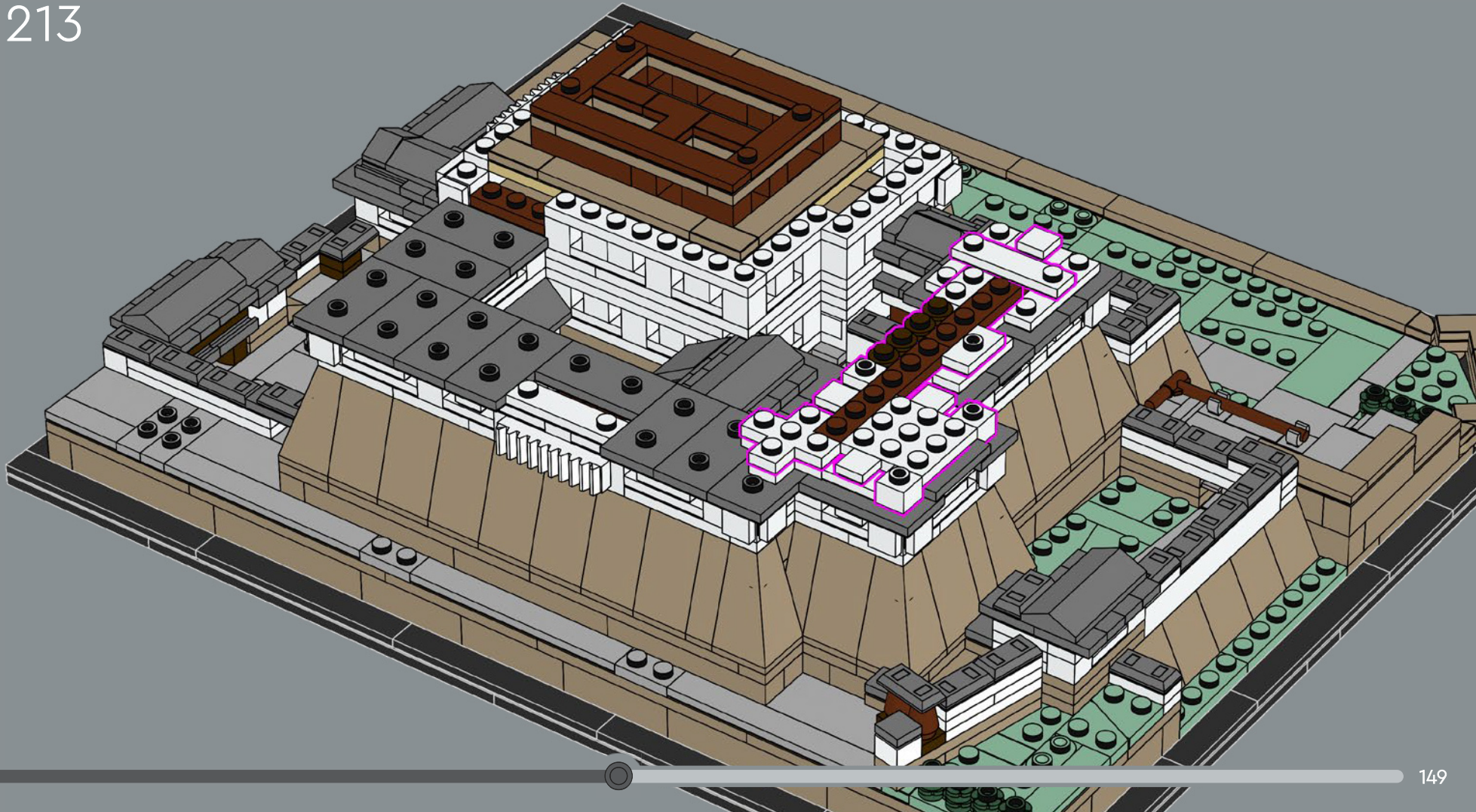

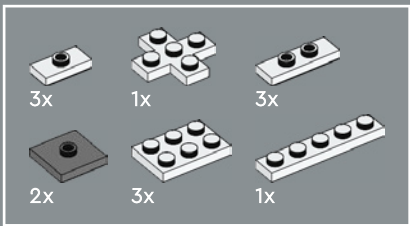

214

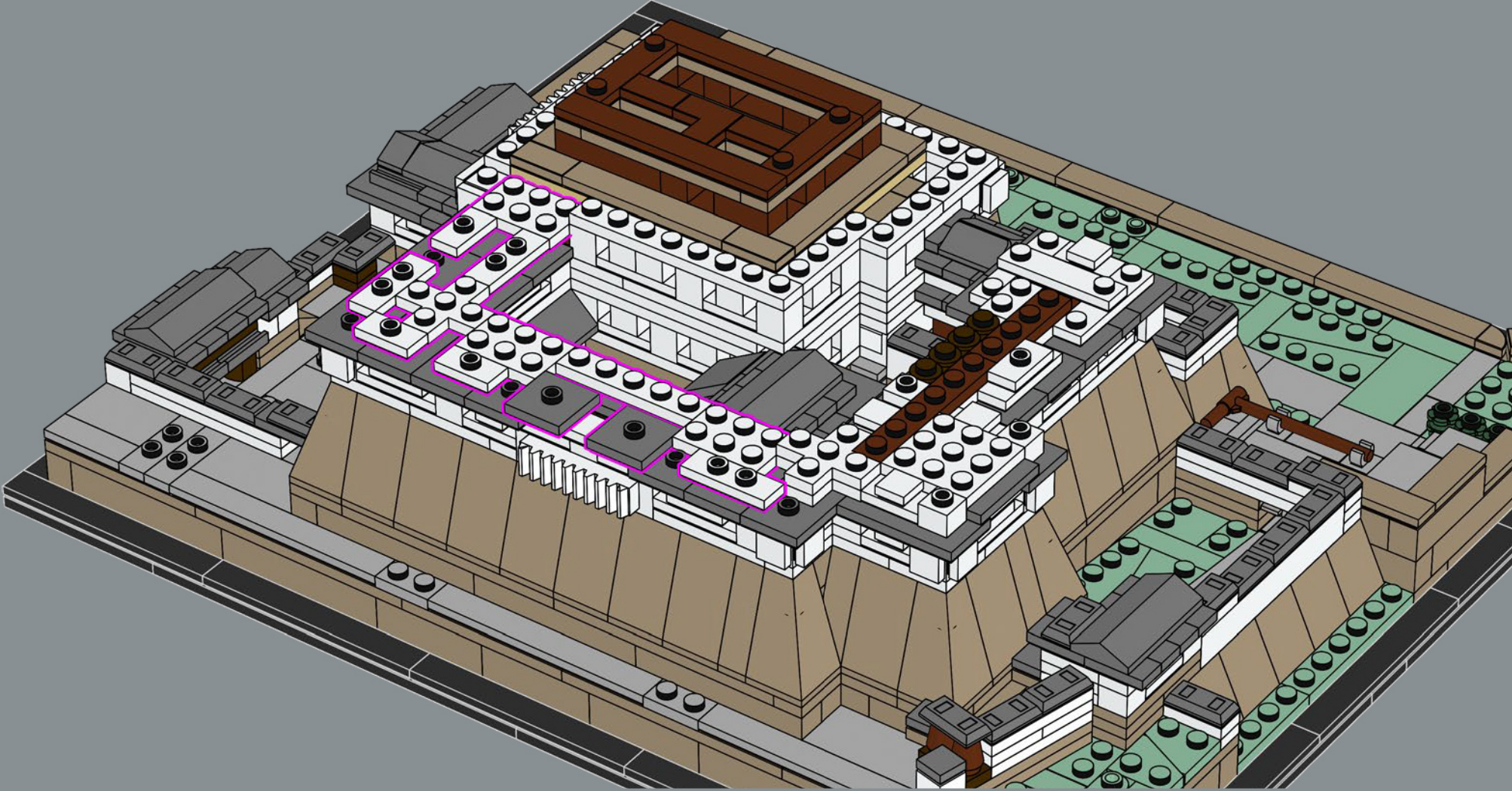

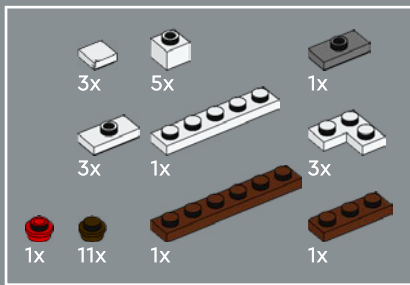

215

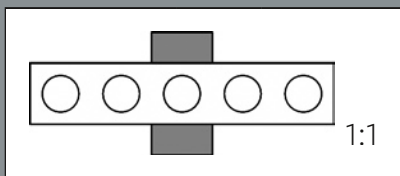
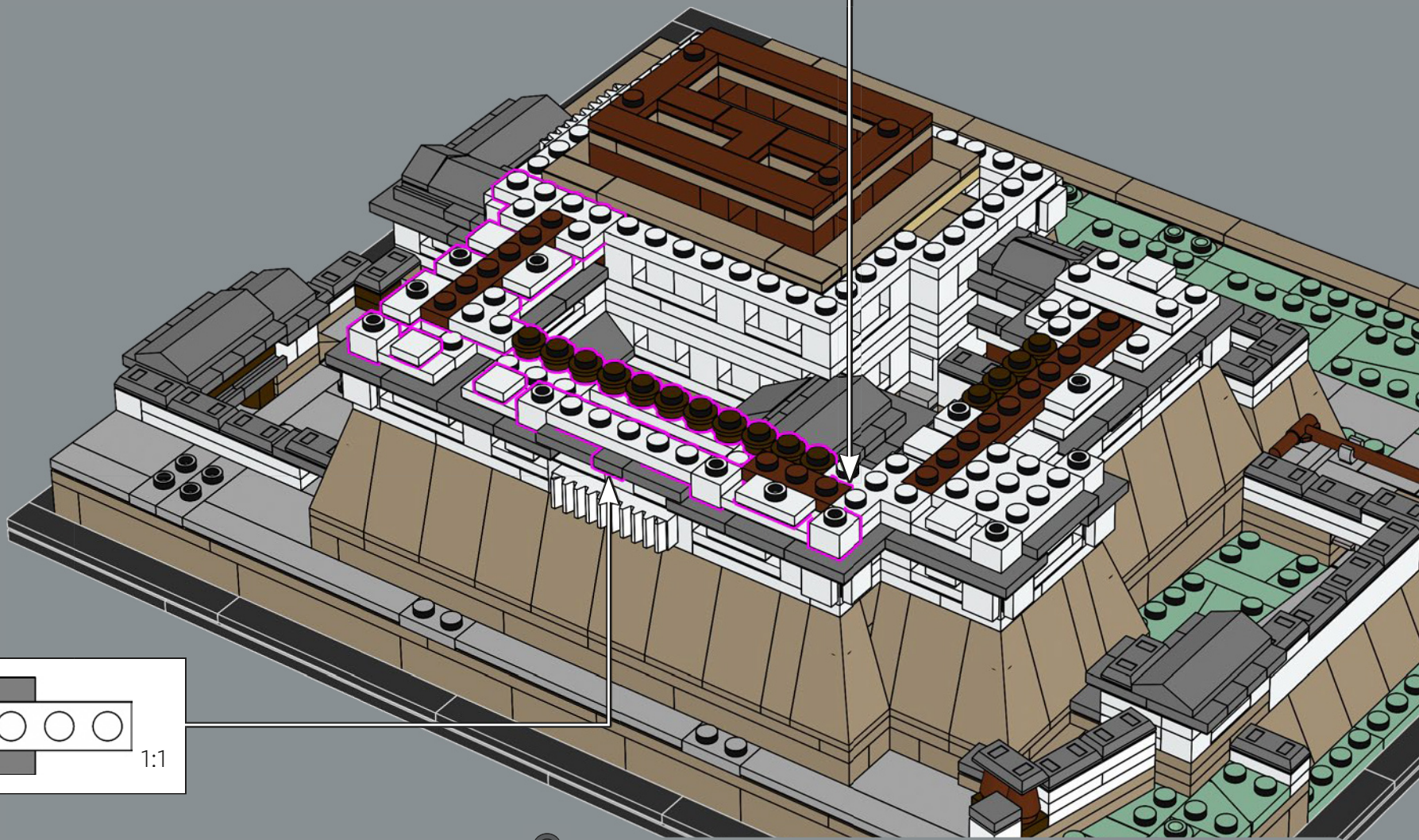
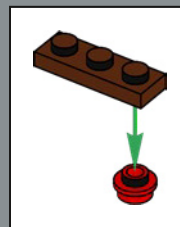

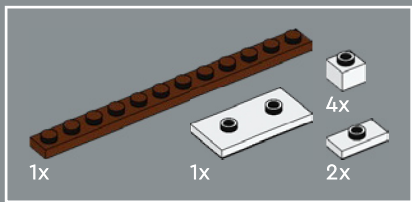

216

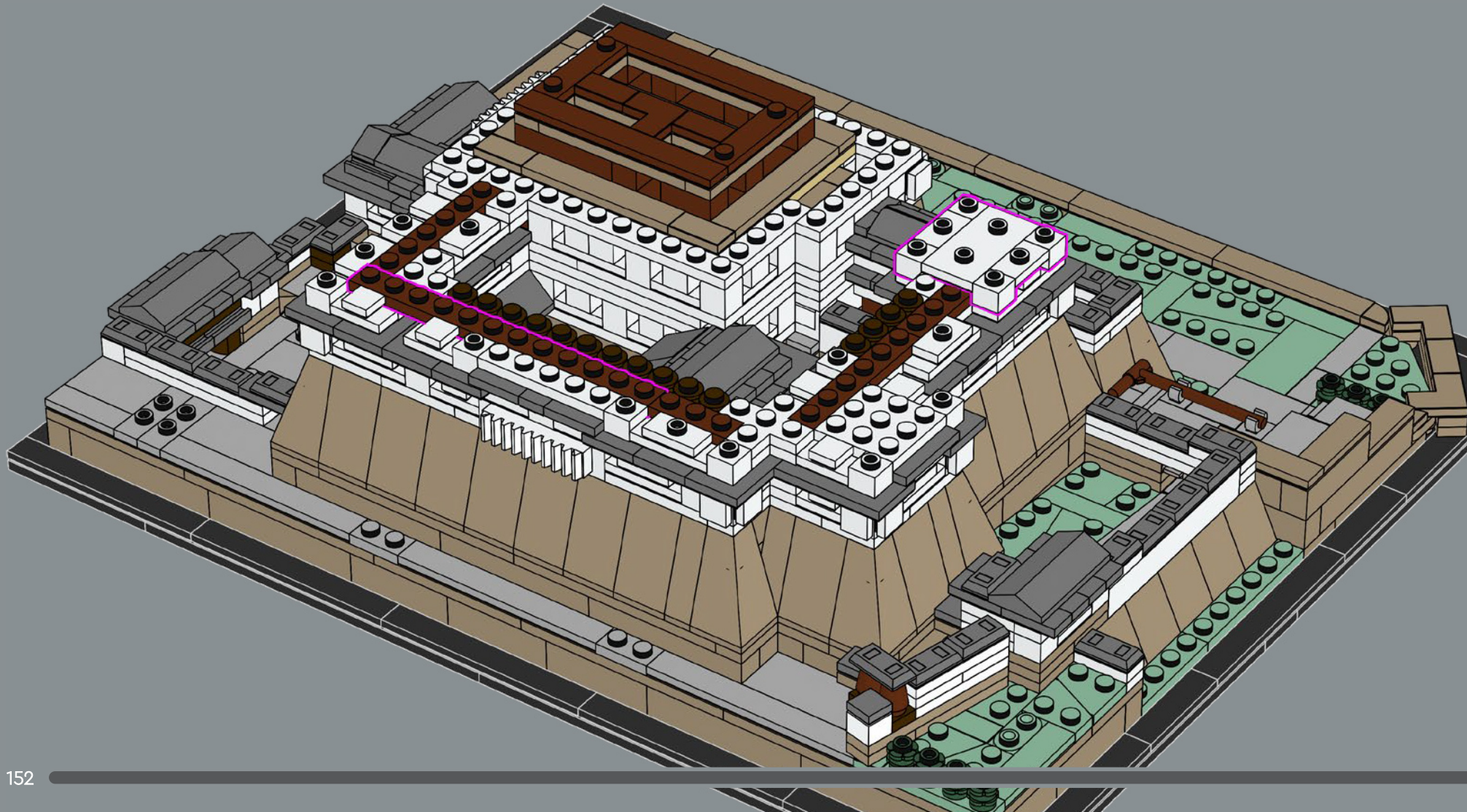

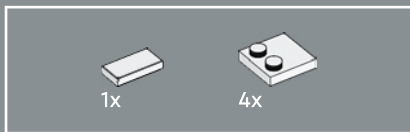

217

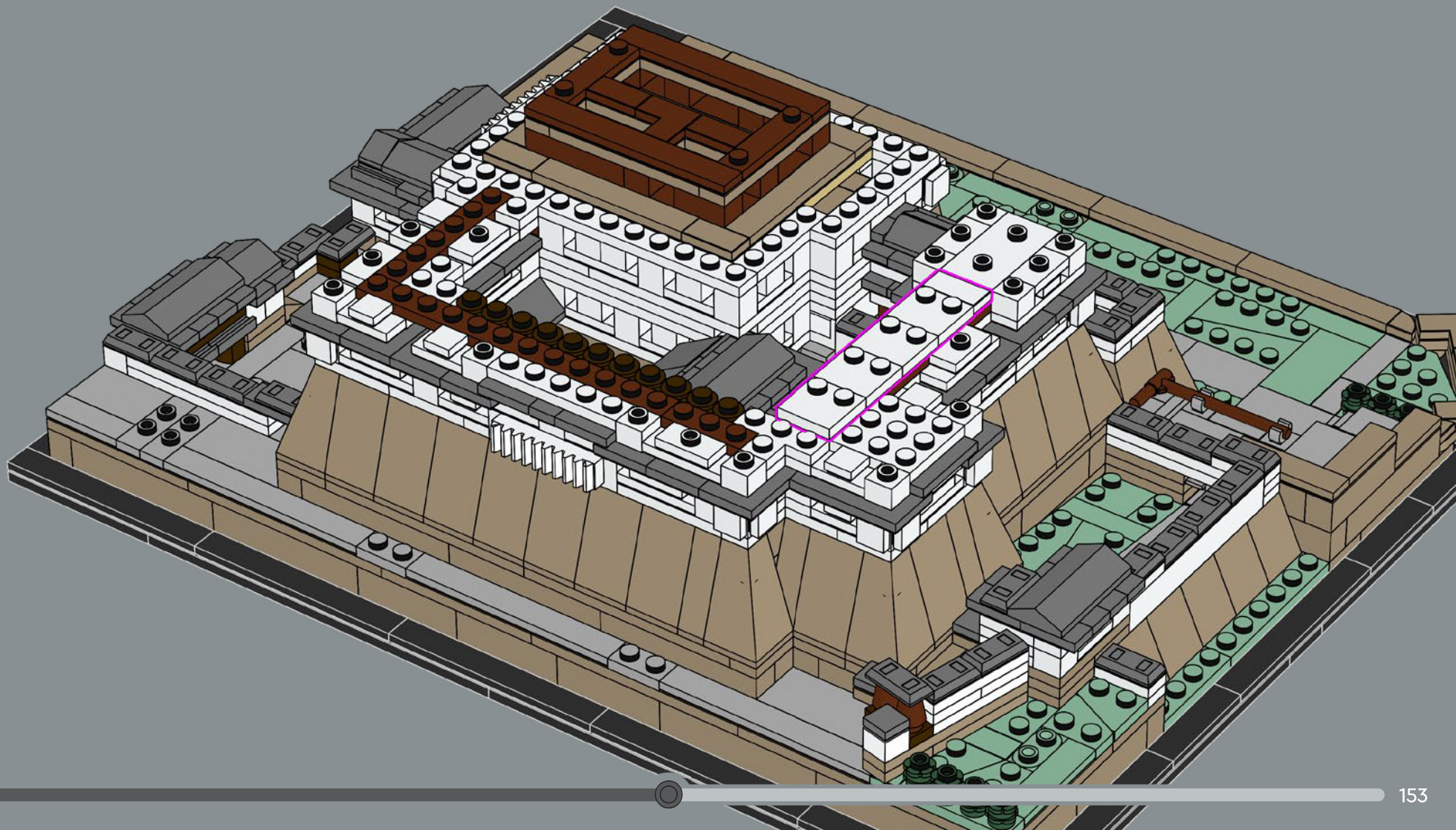

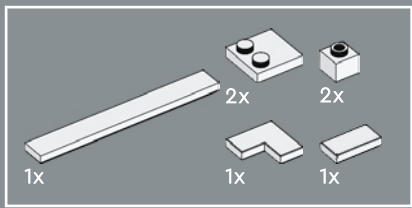

218

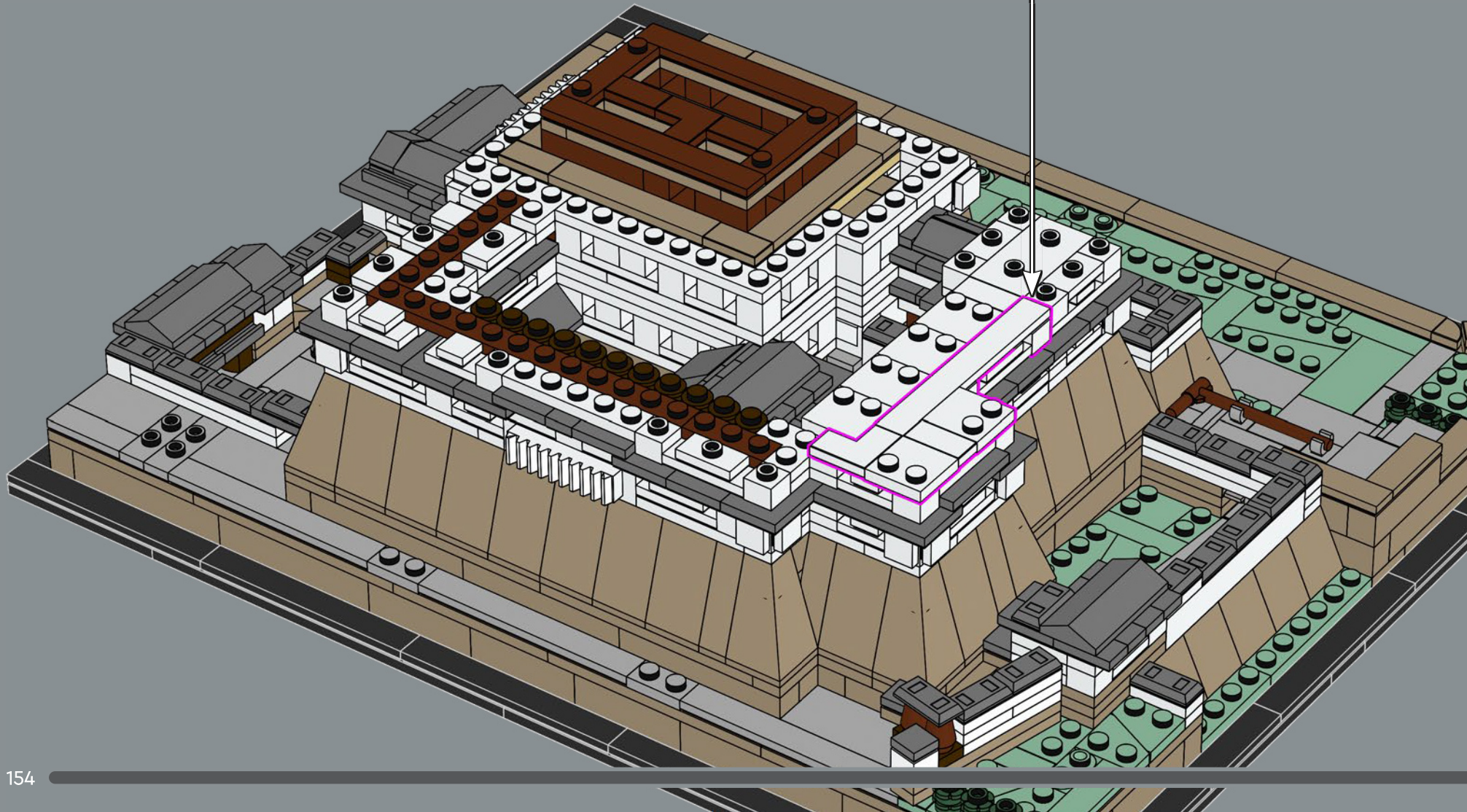
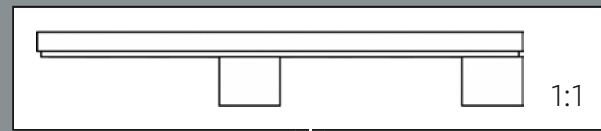

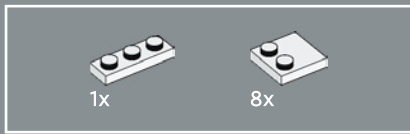

219

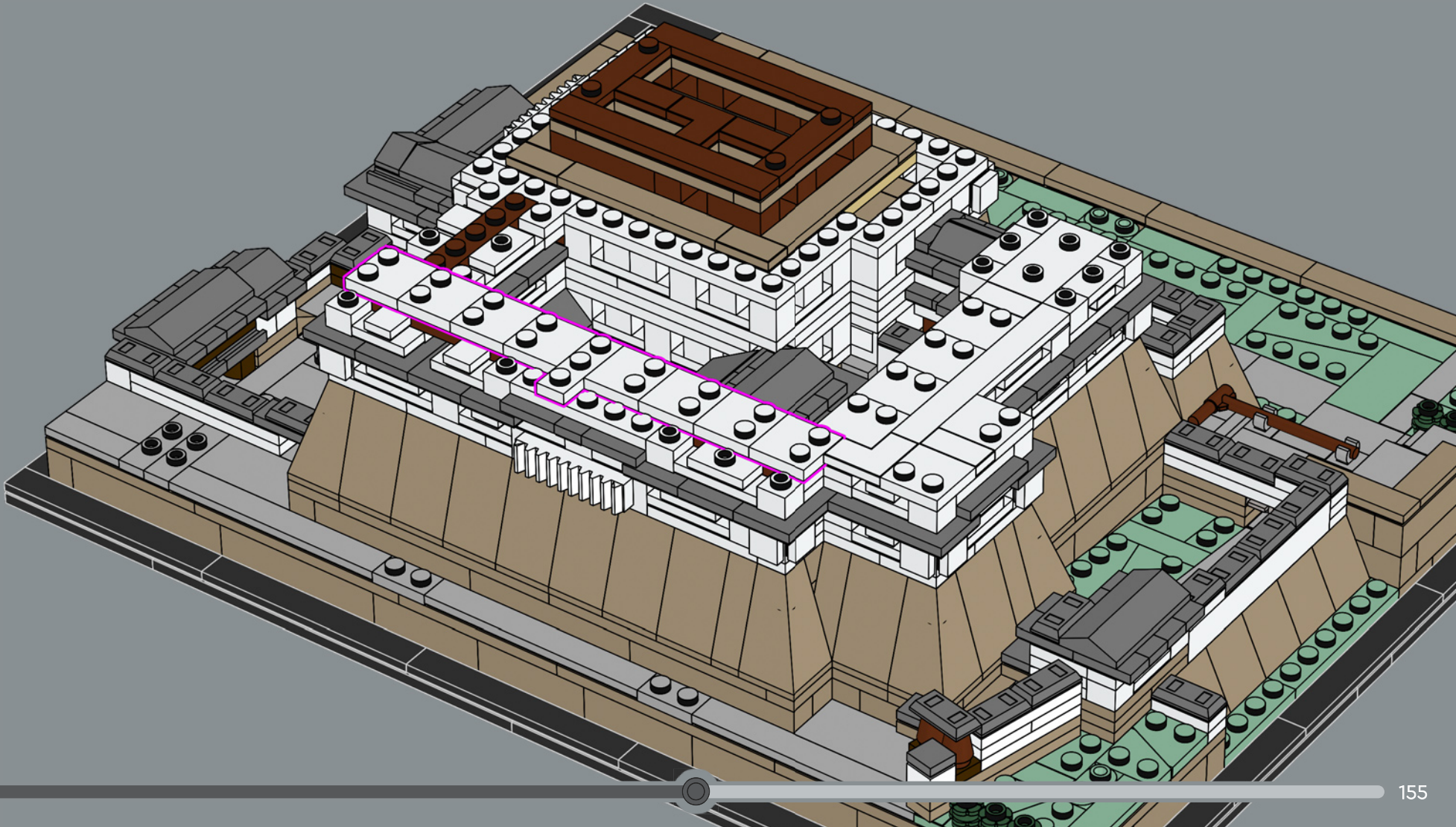

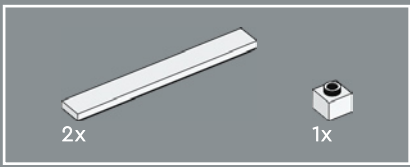

220

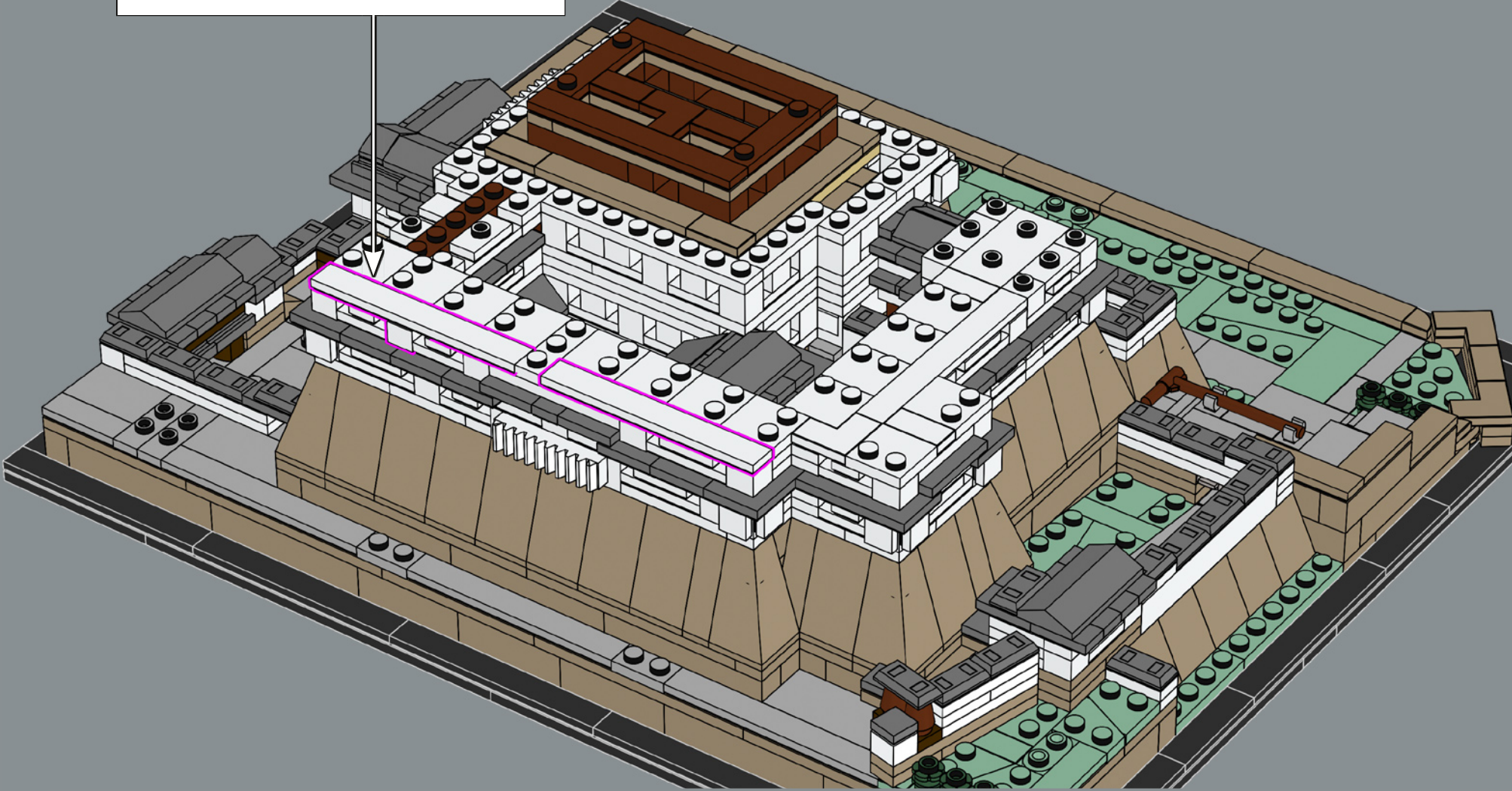
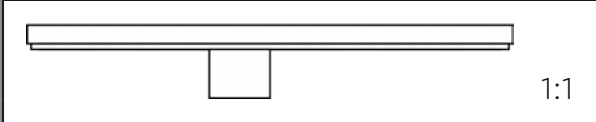

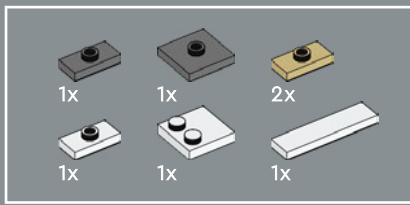

221

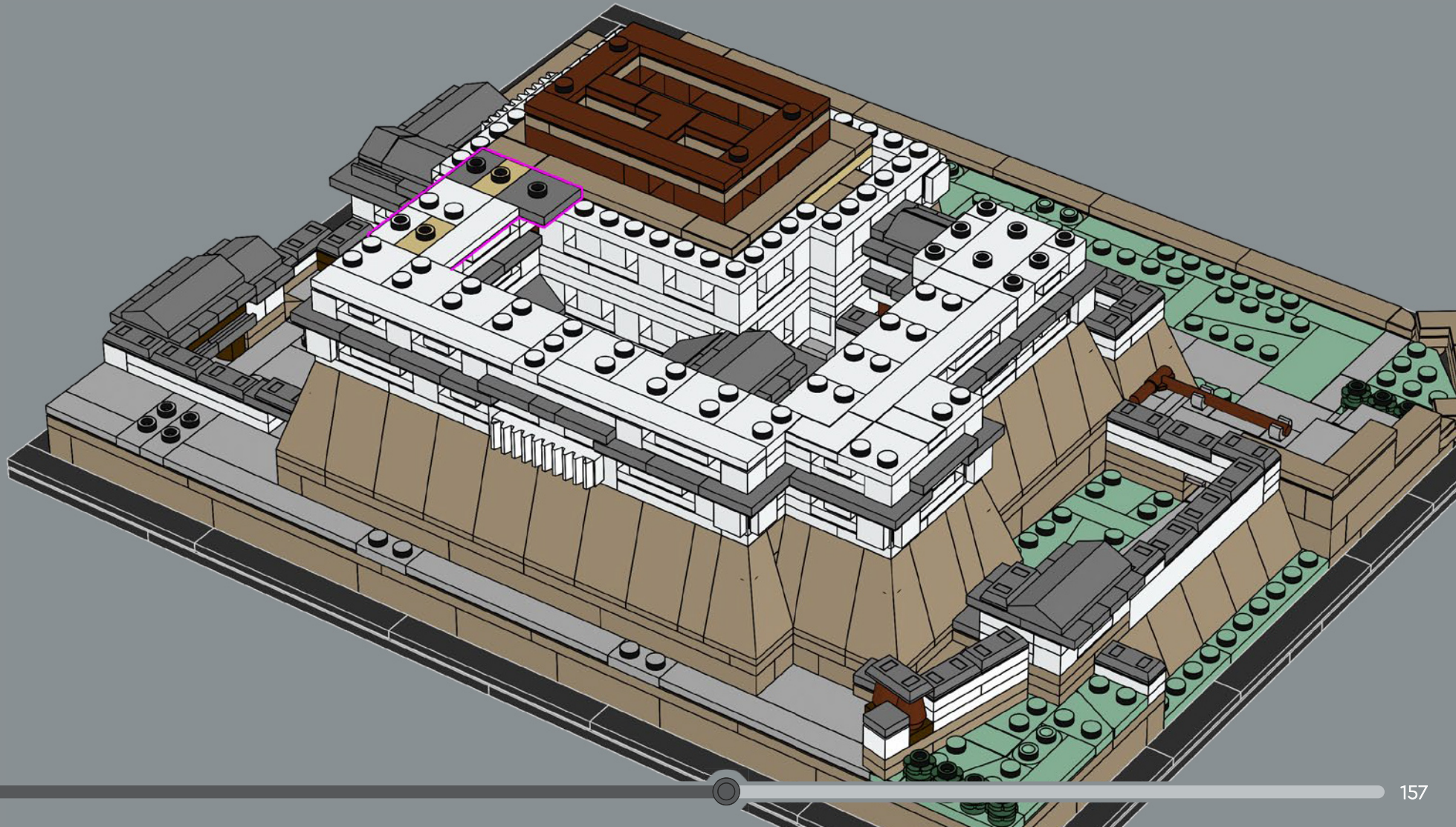

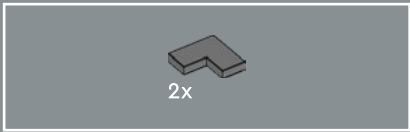

222

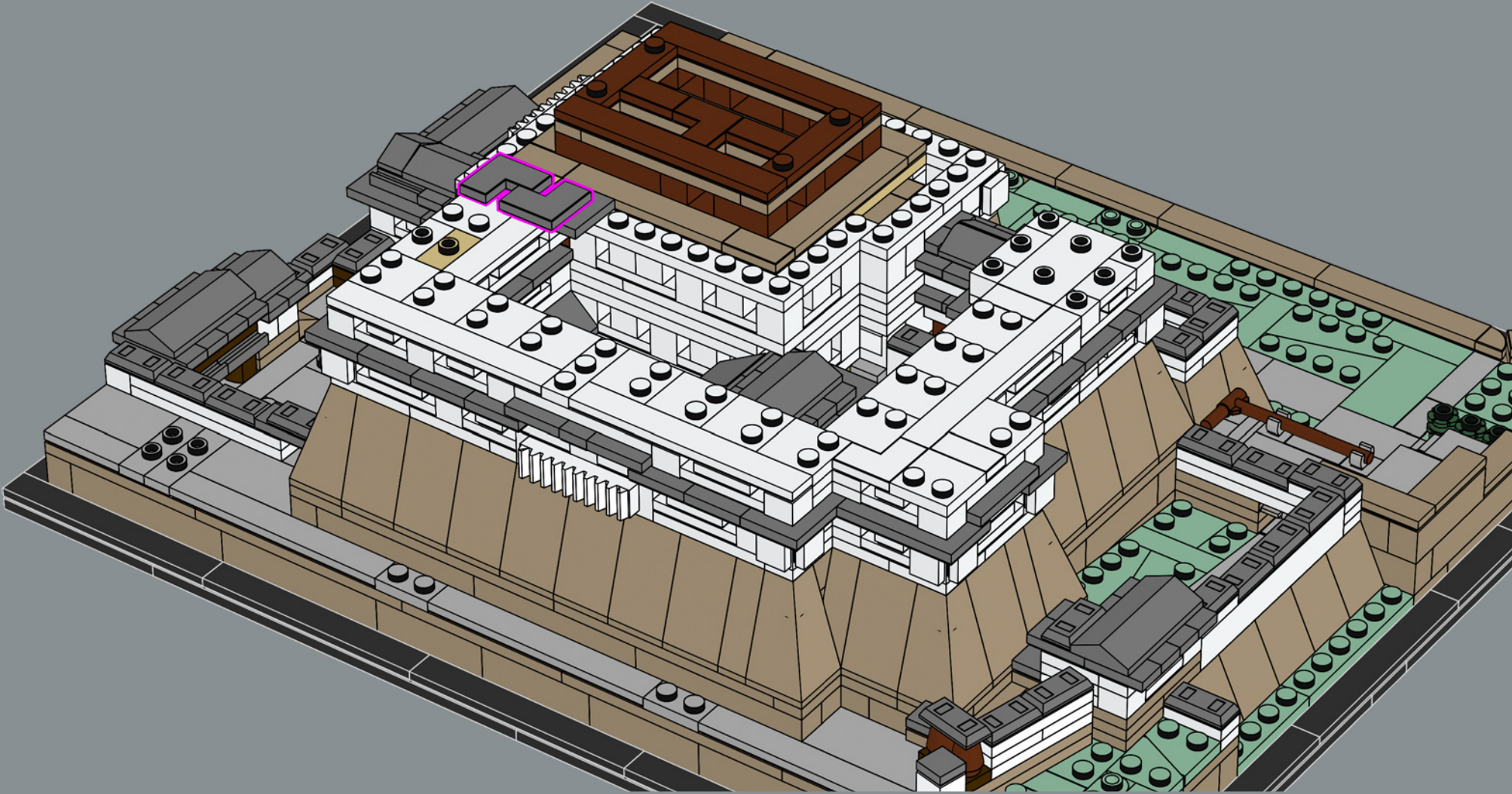

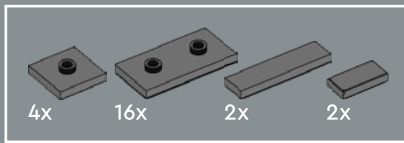

223

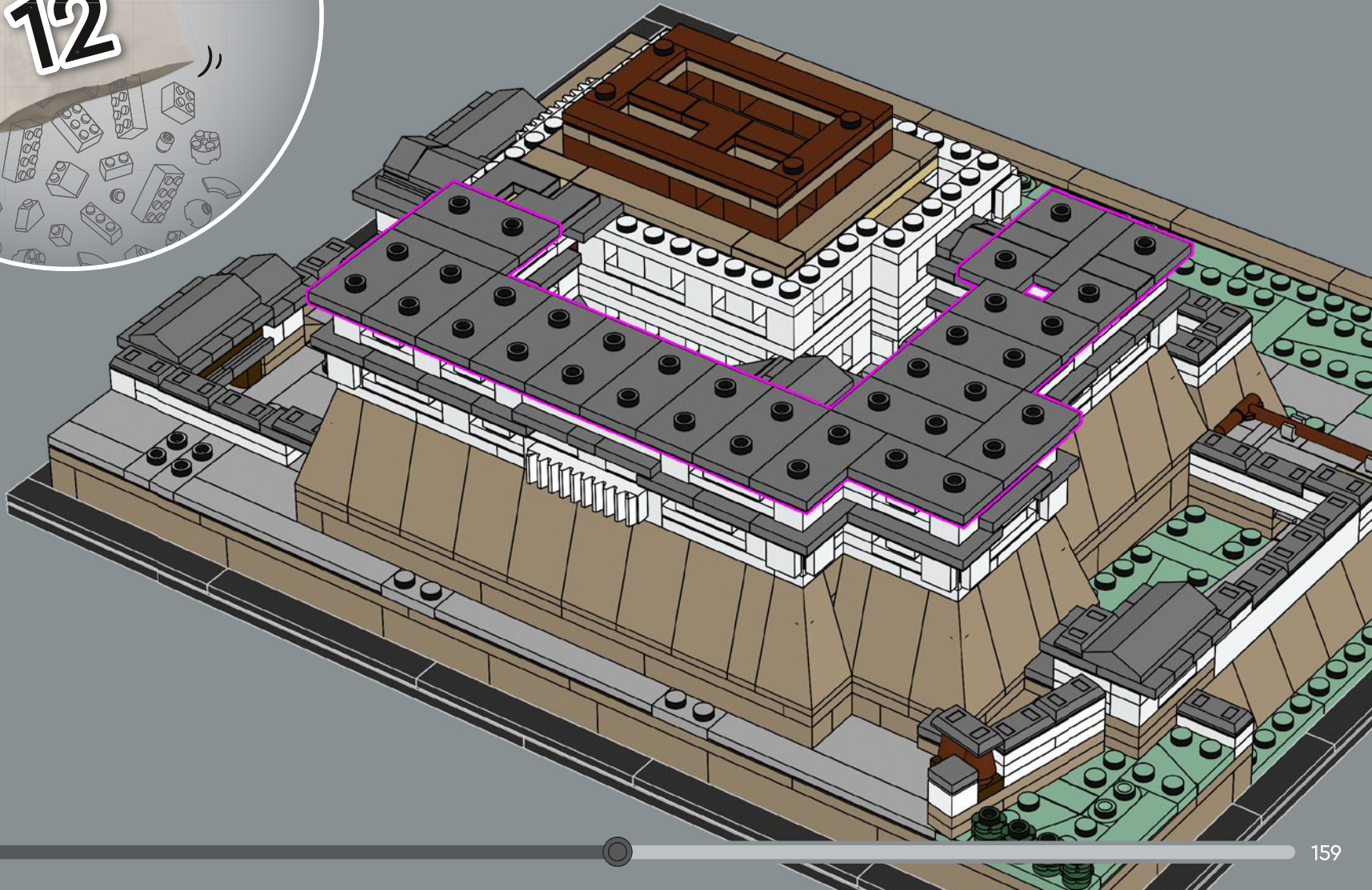

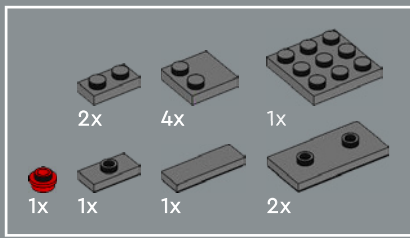

224

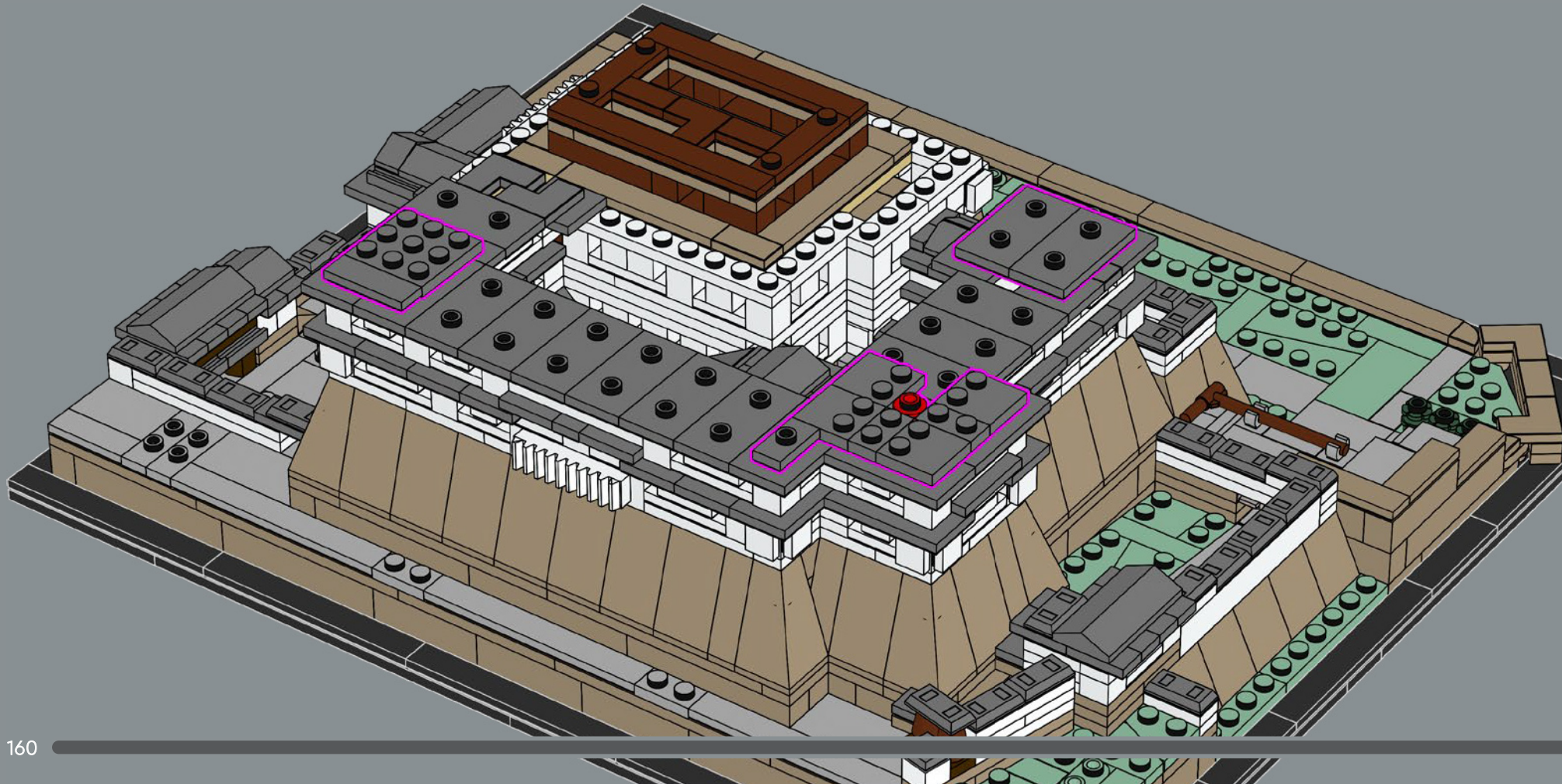

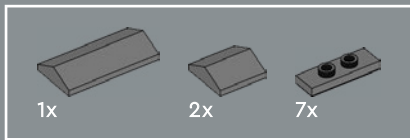

225

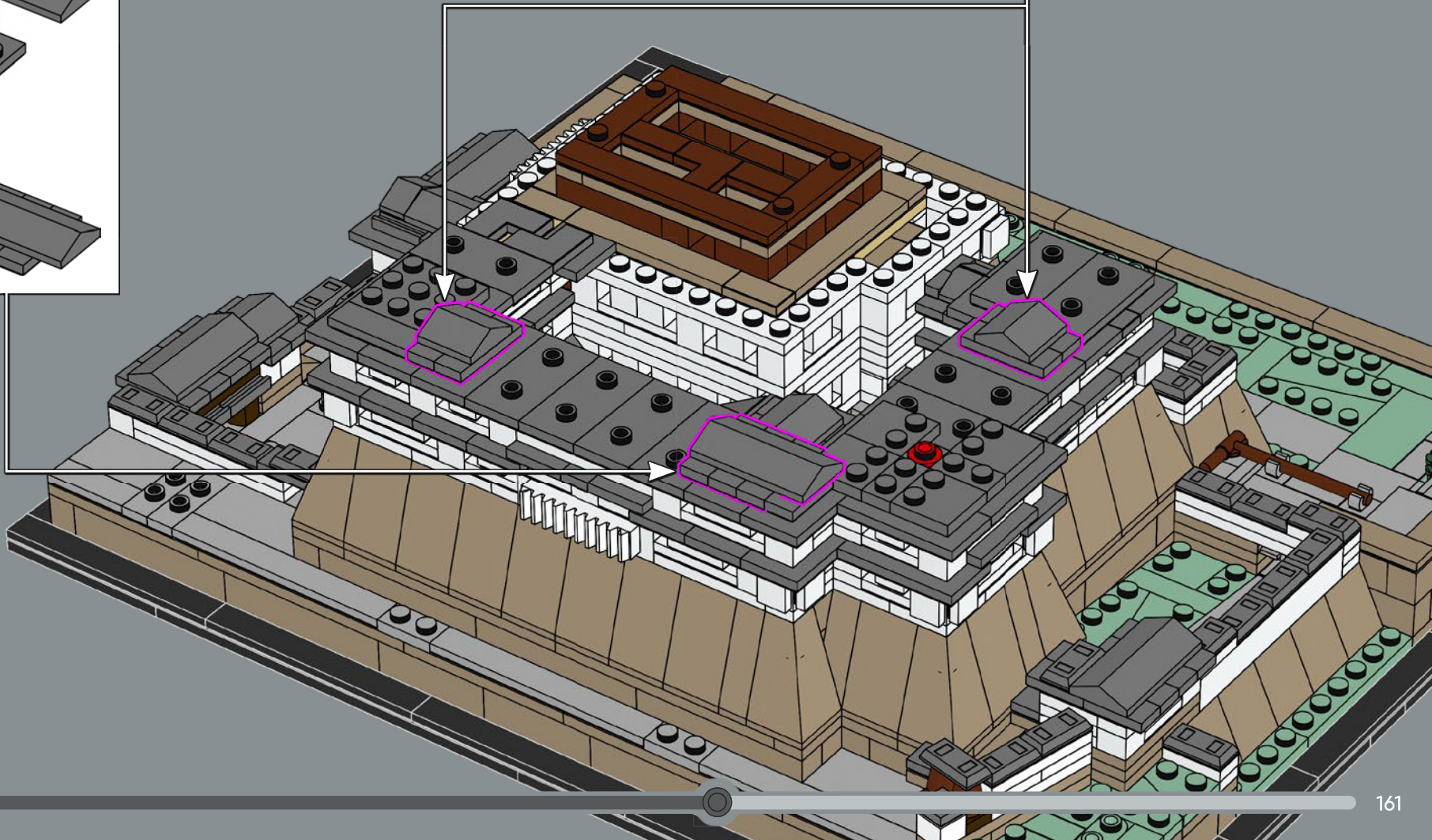
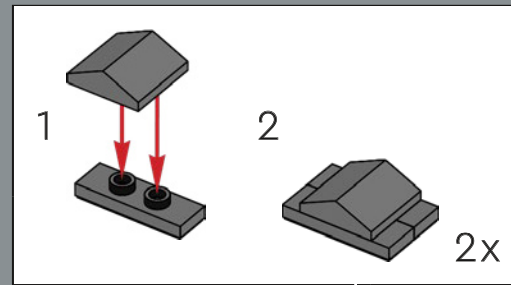
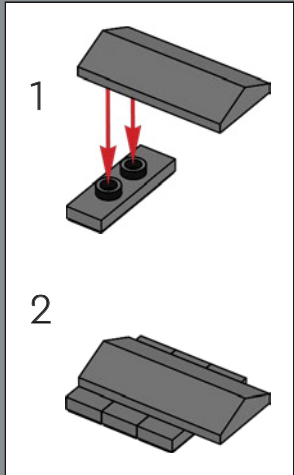

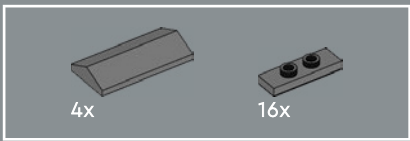

226

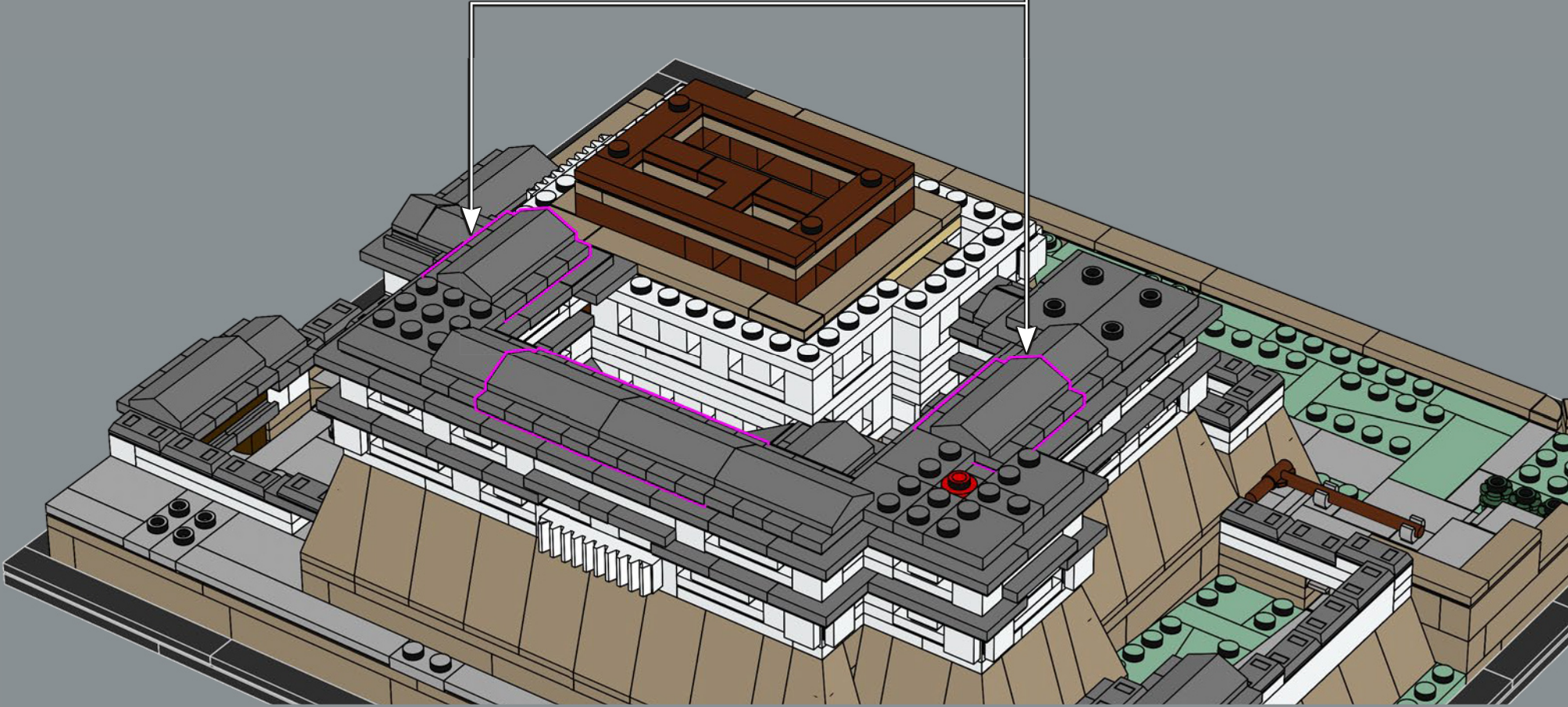
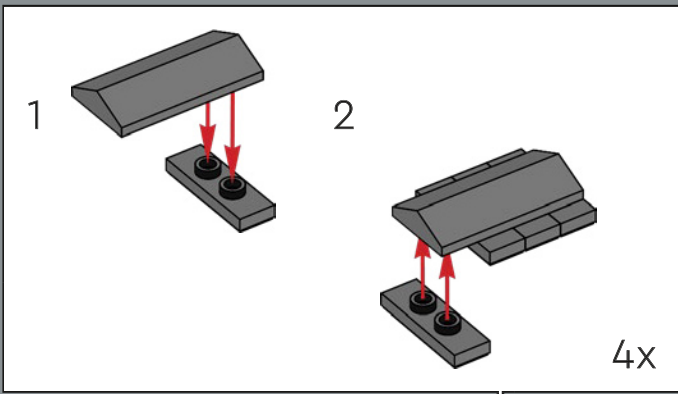

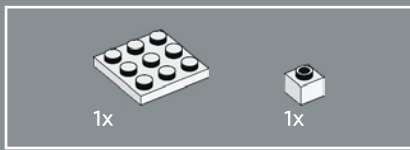

227

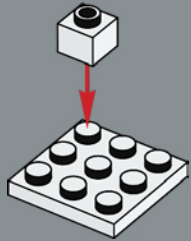

228

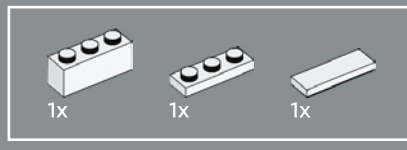
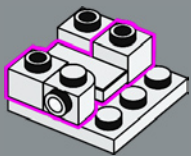

229

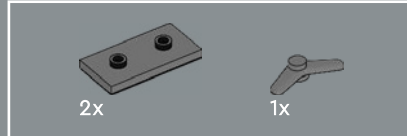
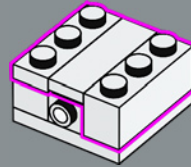

230

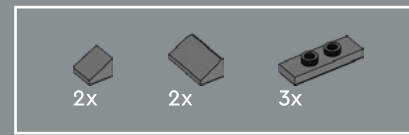
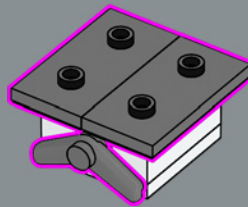

231

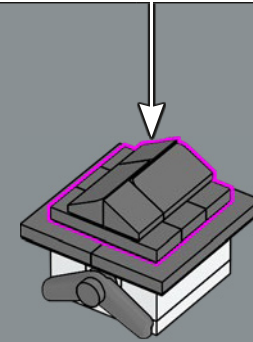
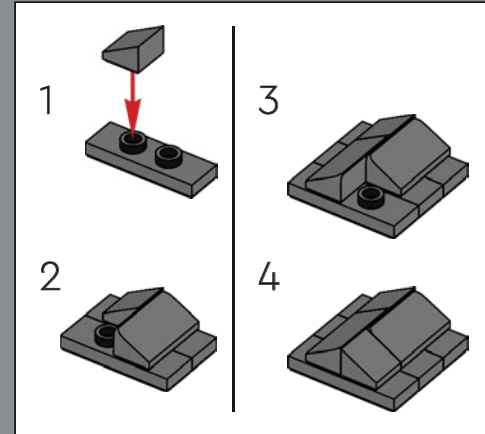

Après des années d'exposition, l'argile blanche sur le toit commence à se salir, changeant lentement l'apparence et la couleur du toit.

232

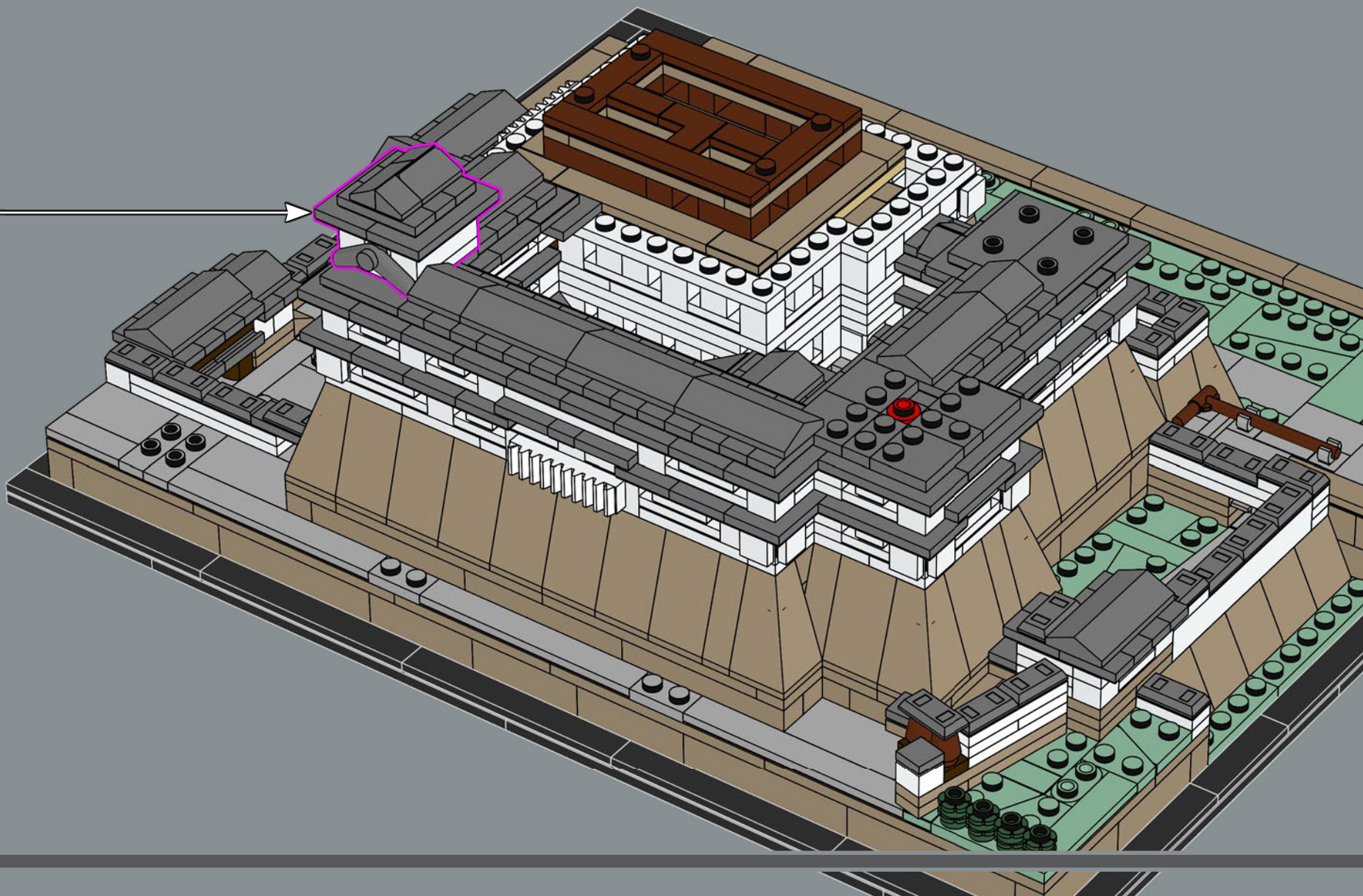

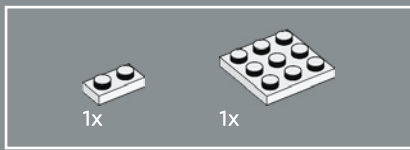

233

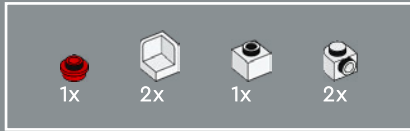
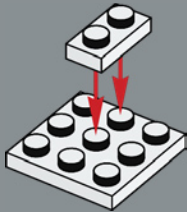

234

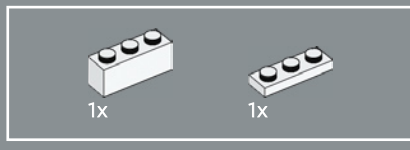
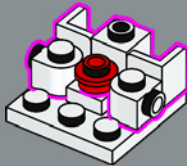

235

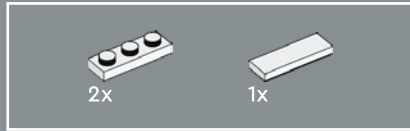
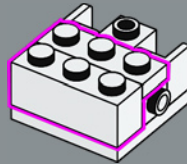

236

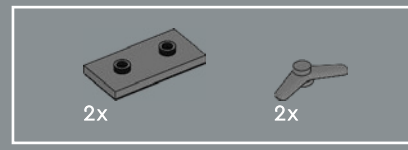
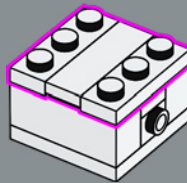

237

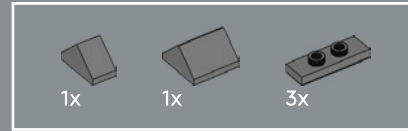
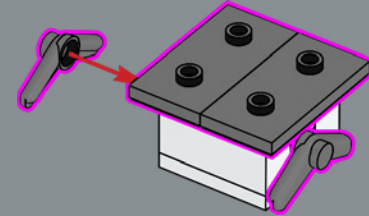

238

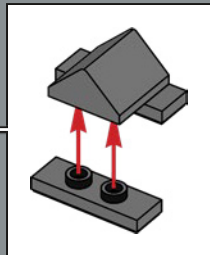
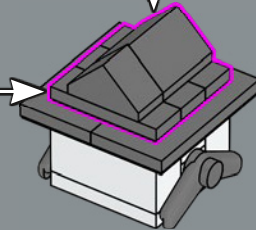
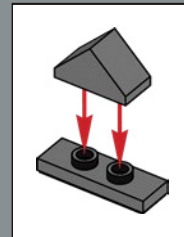

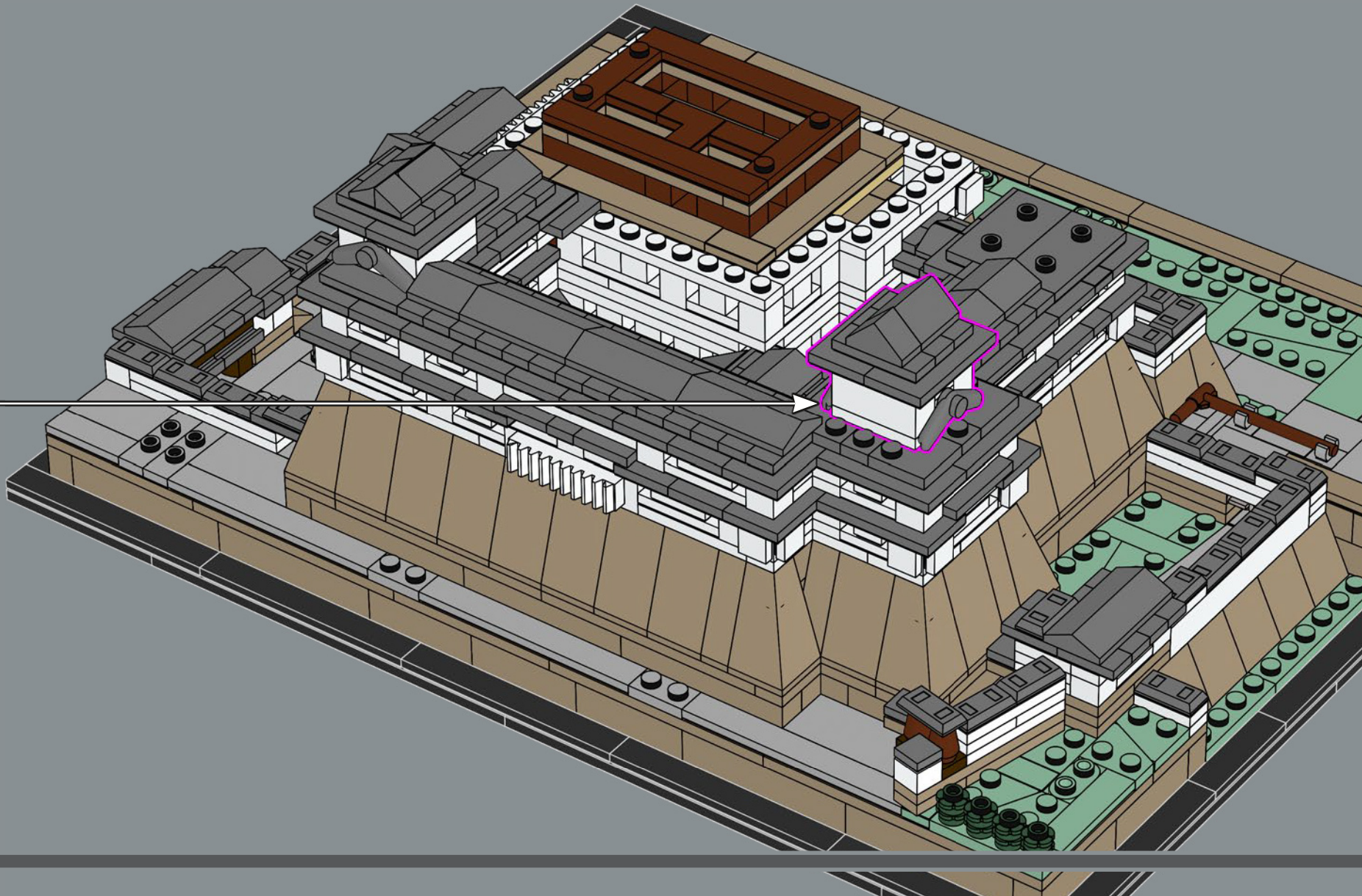



240

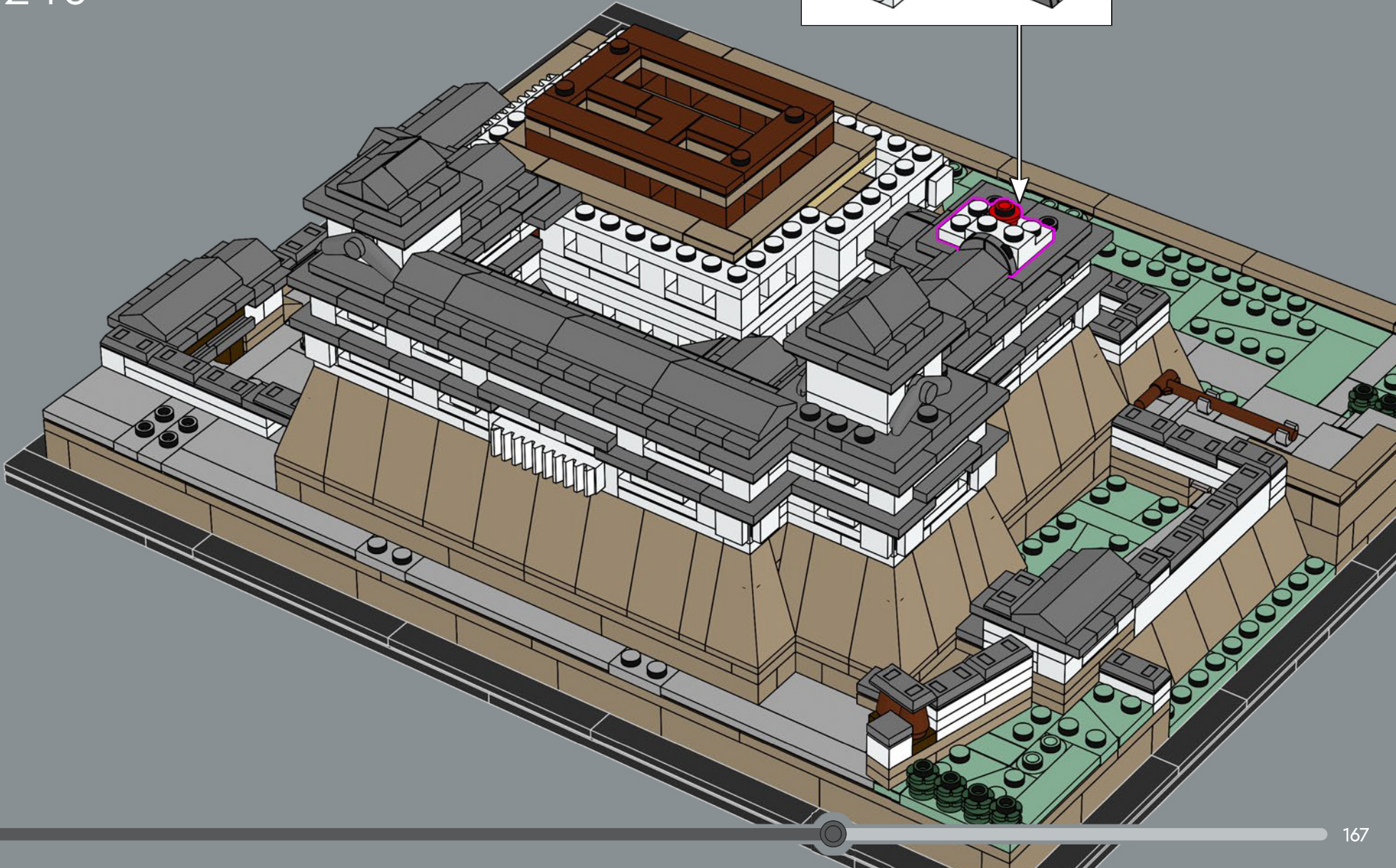
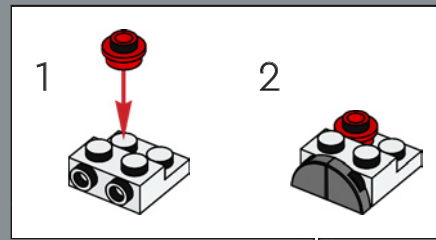

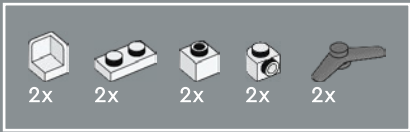

241

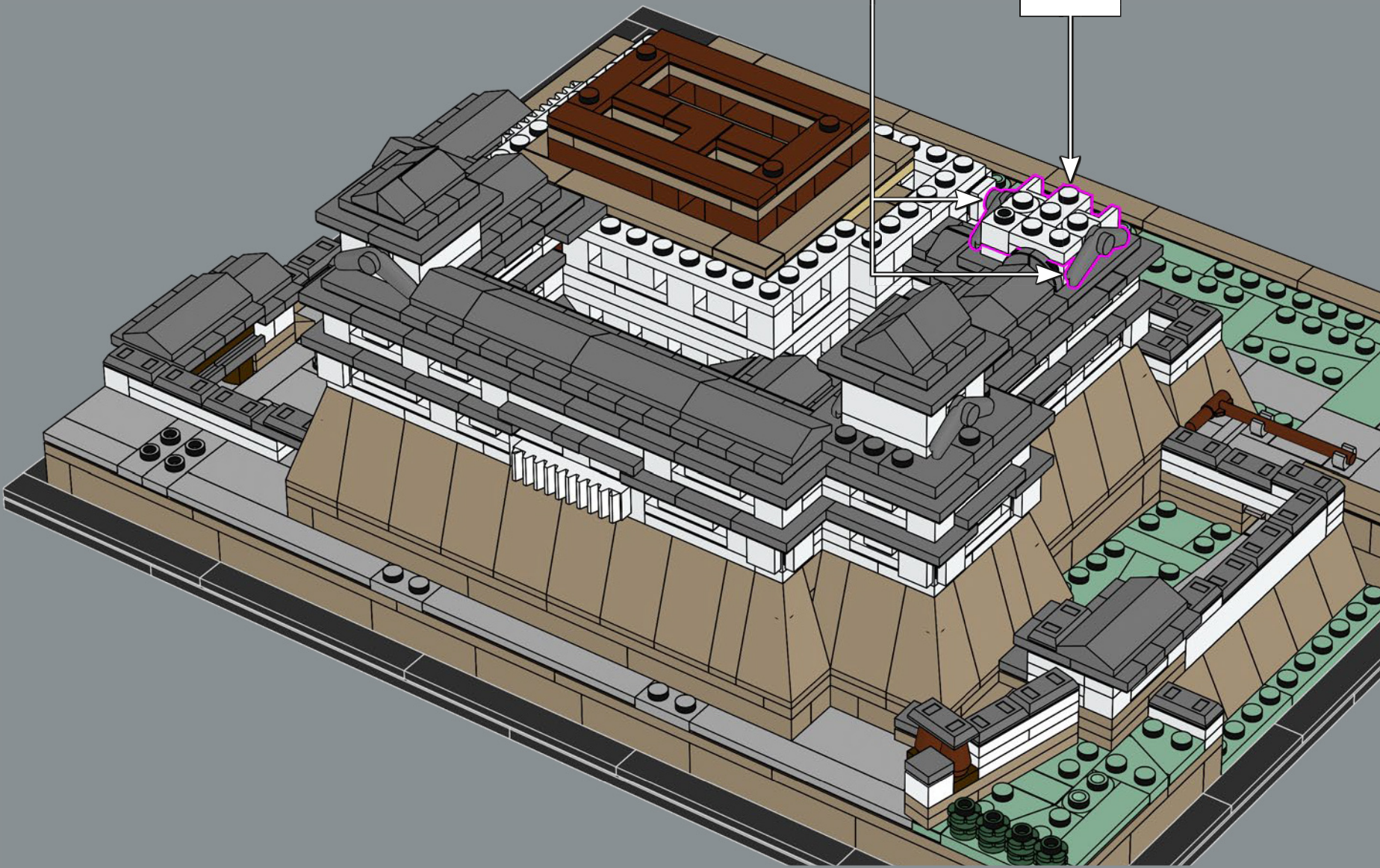
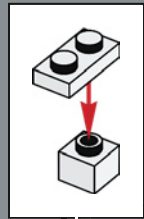
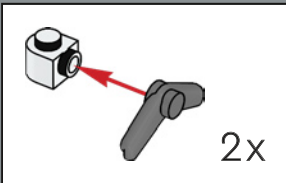

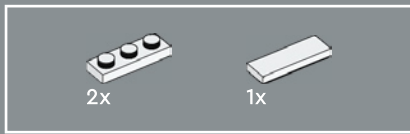

242

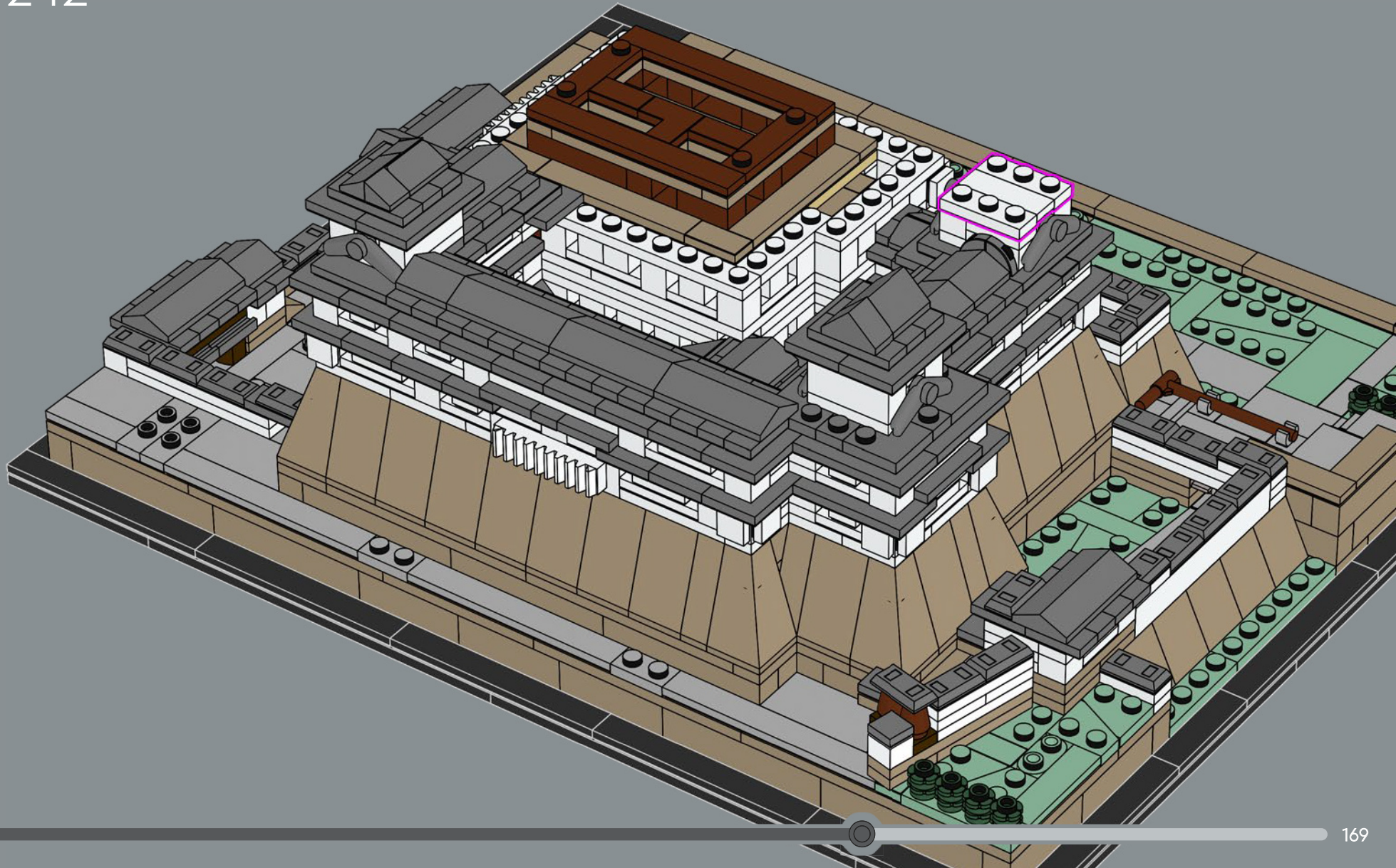

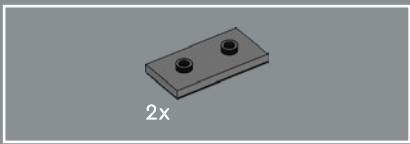

243

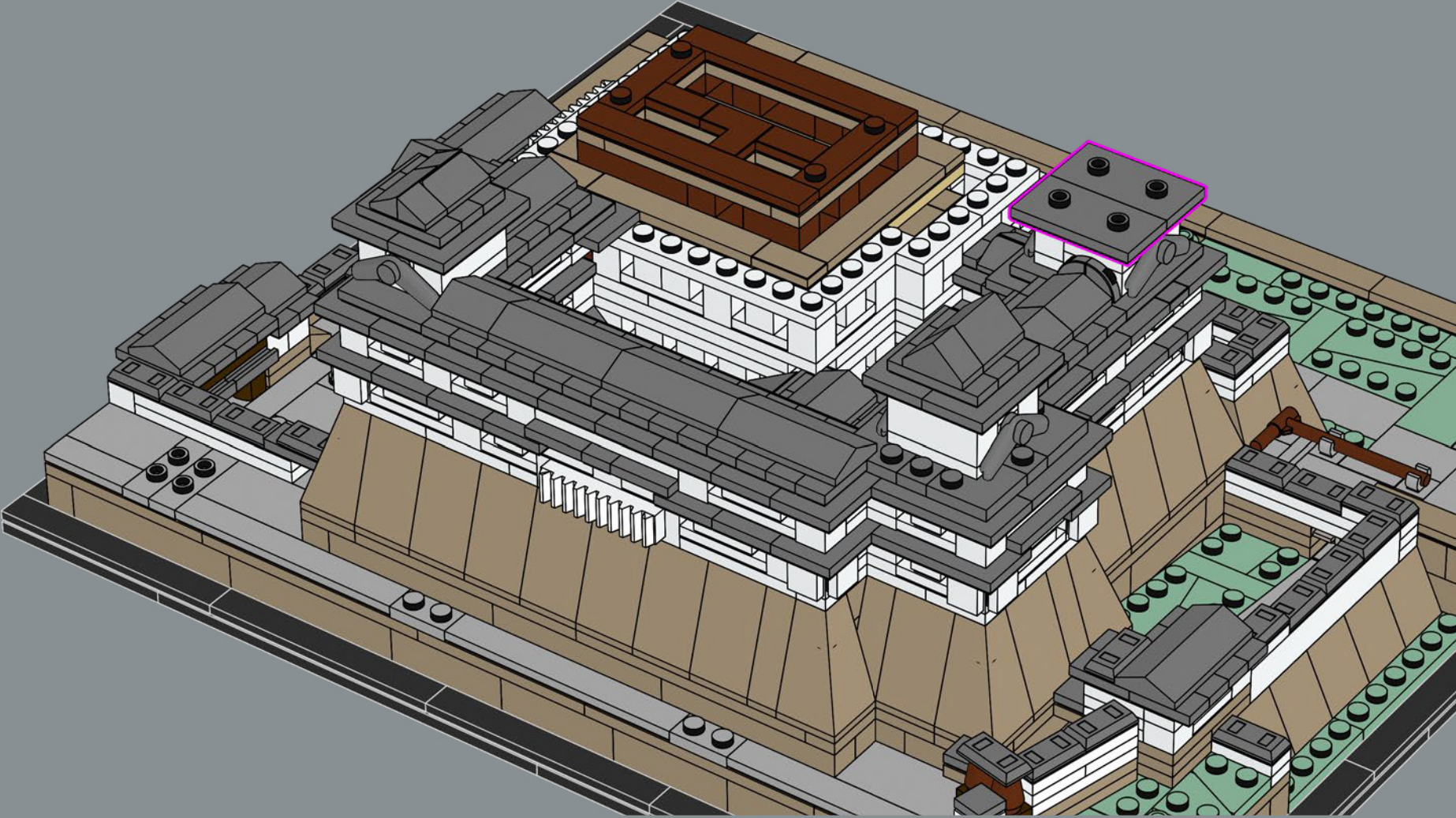

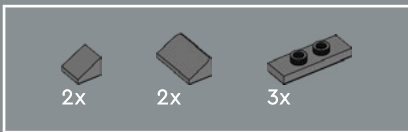

244

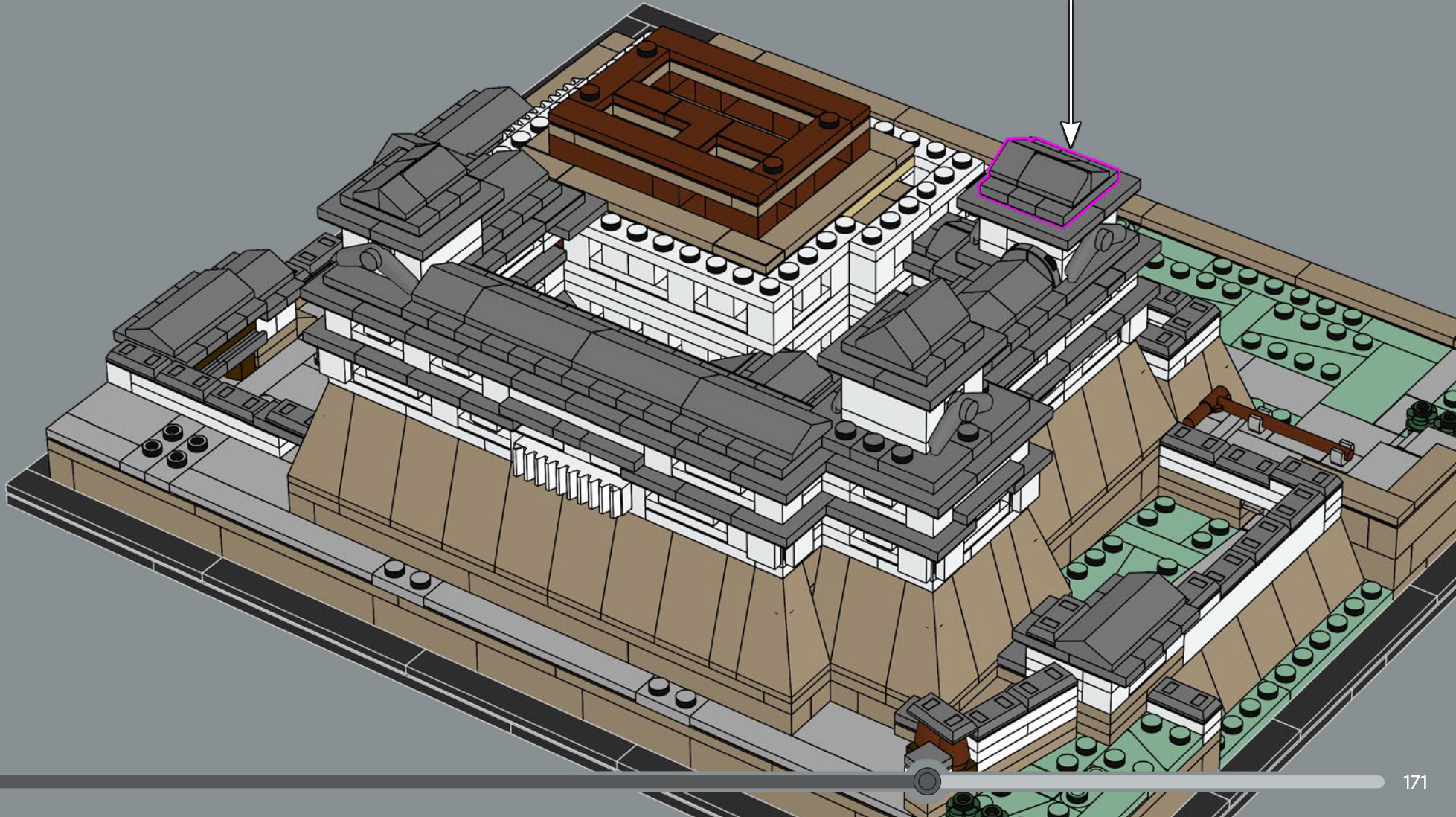
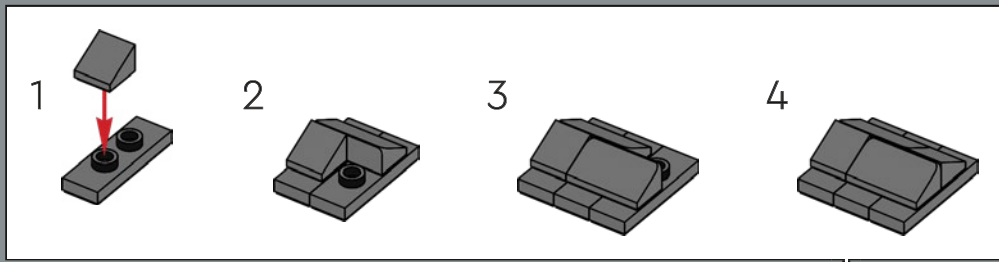

Le nouvel élément d'angle 2x2 incliné est le deuxième NOUVEL élément à être approuvé pour un set LEGO® Architecture. Le premier était un élément similaire de taille 3x3 du set Robie House 21010 (2011).

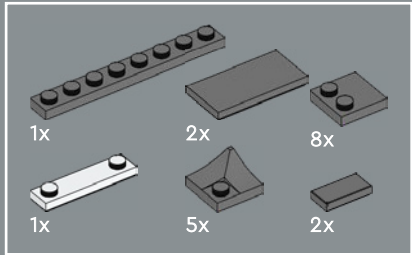

245

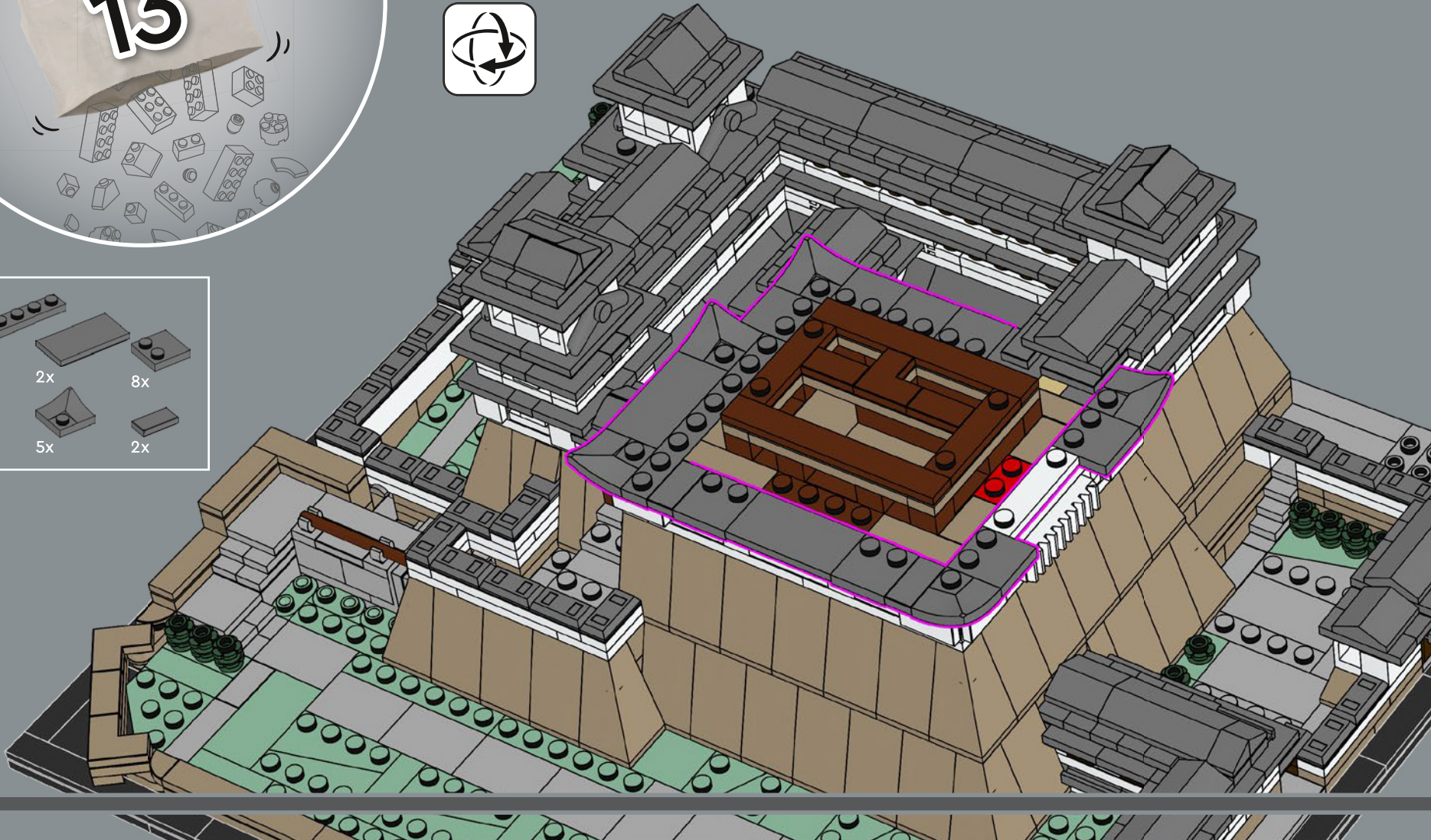

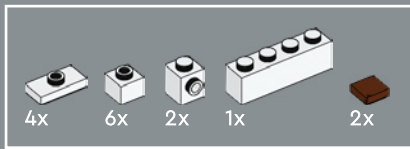

246

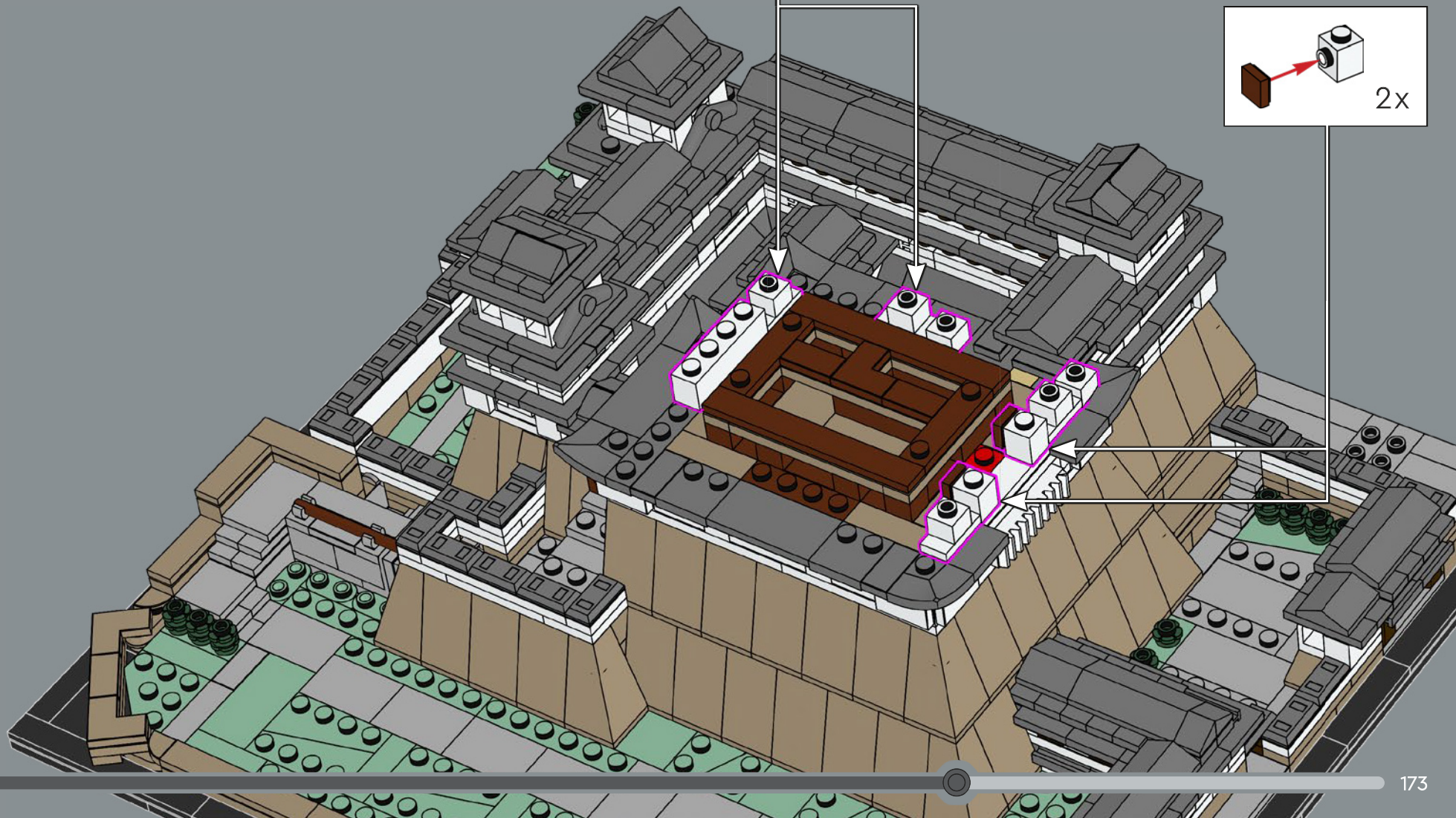
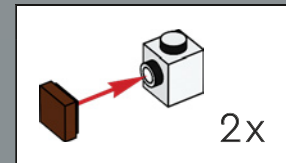
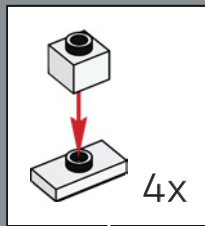

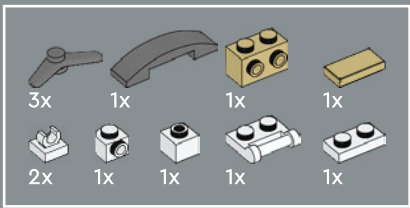

247

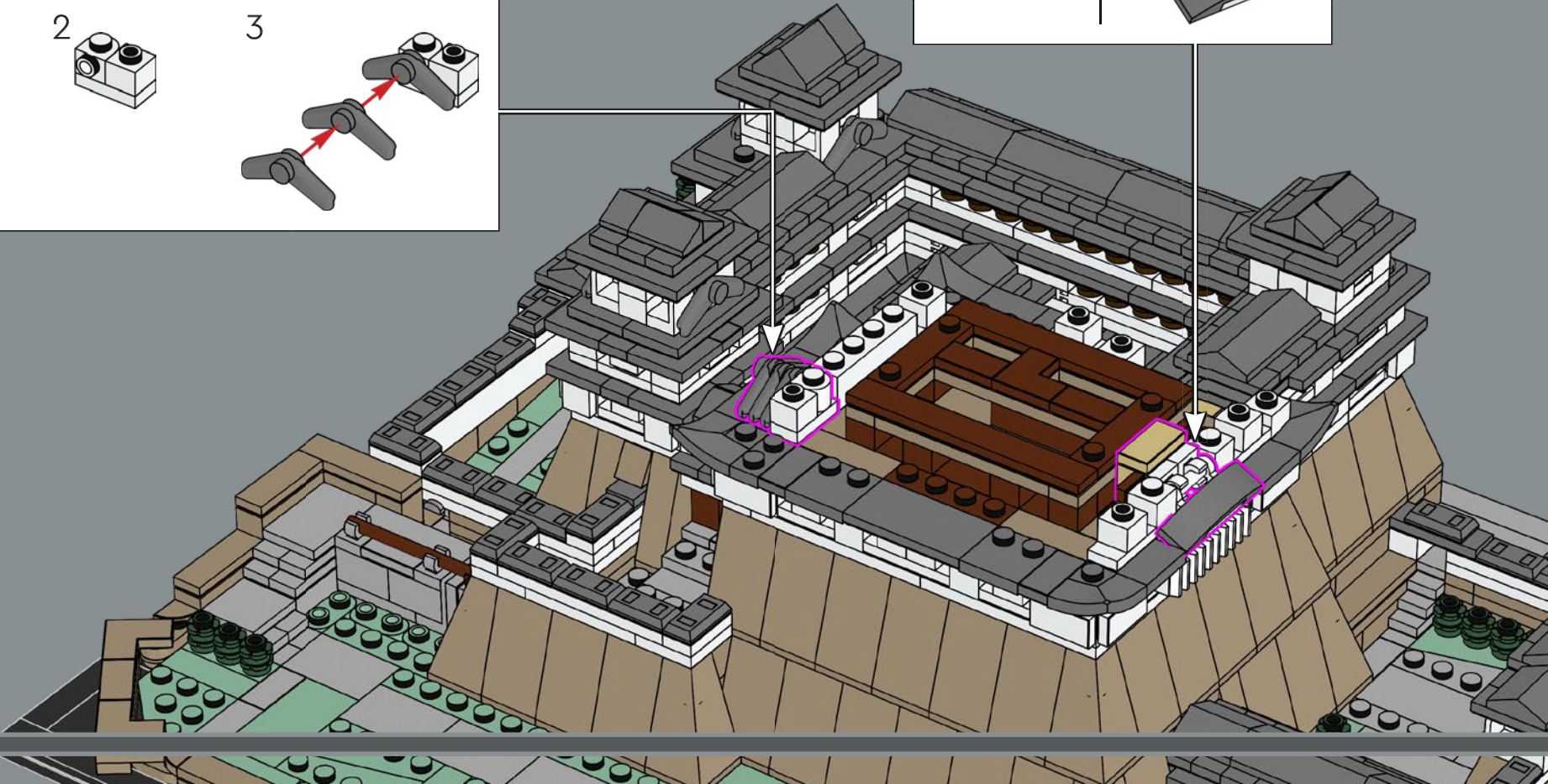
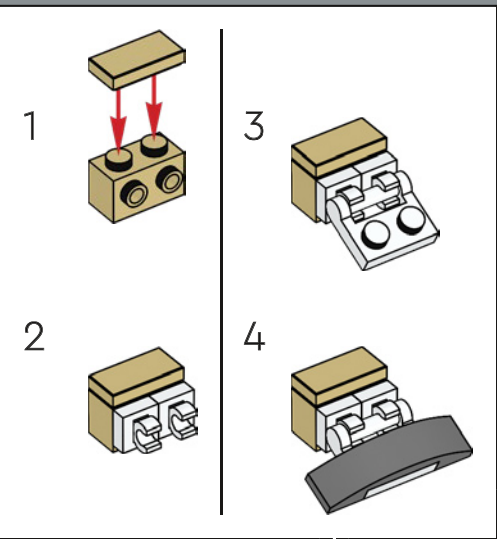
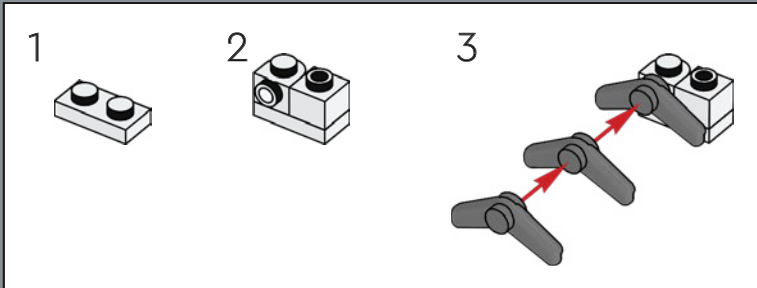

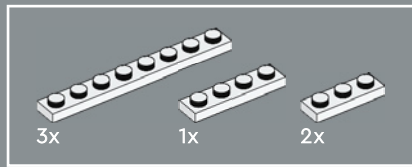

248

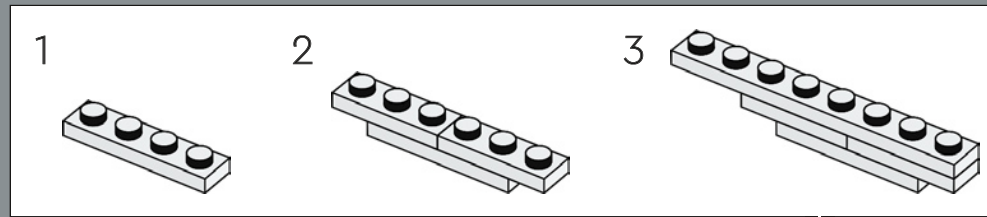

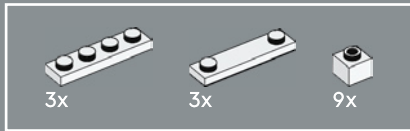
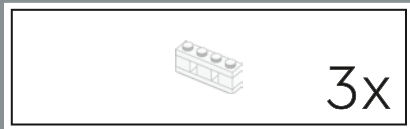

249

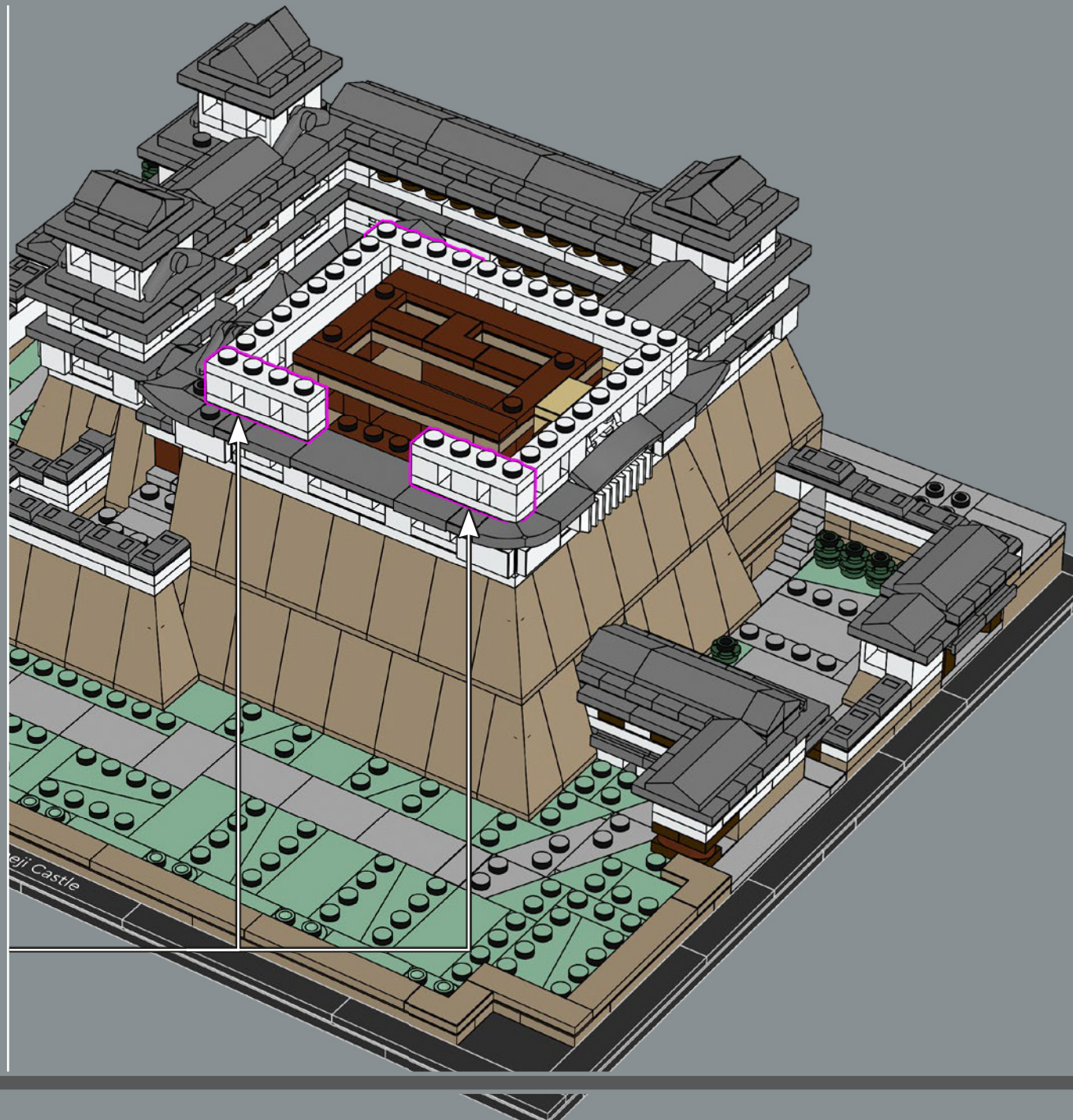
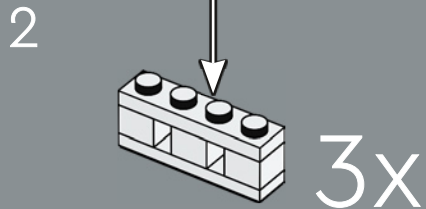
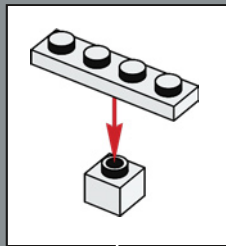
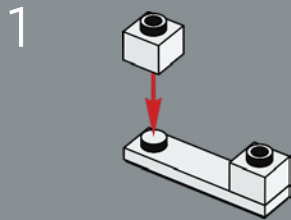

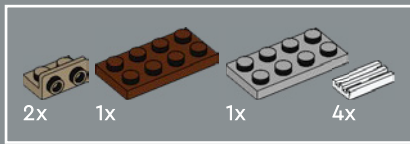

250

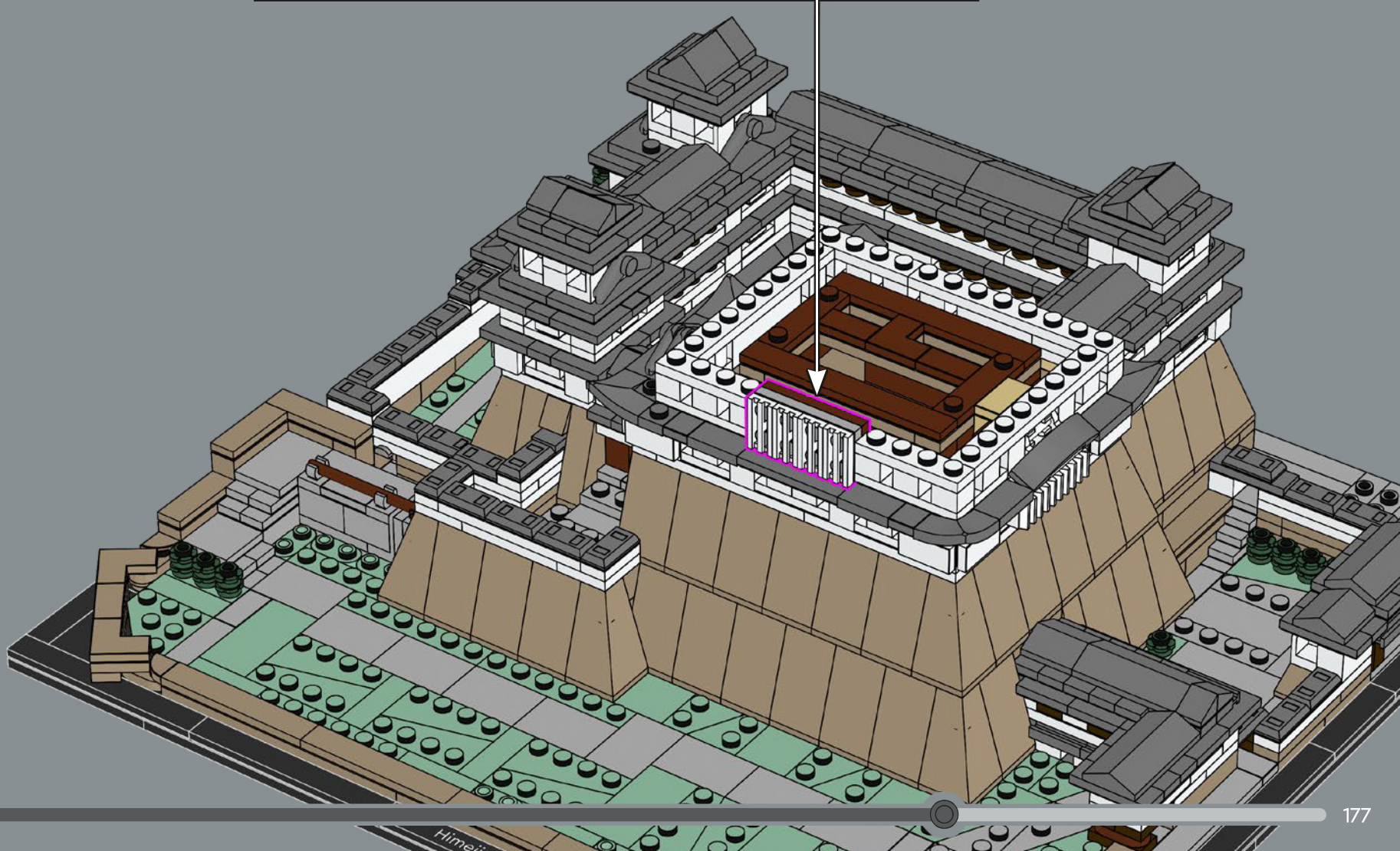
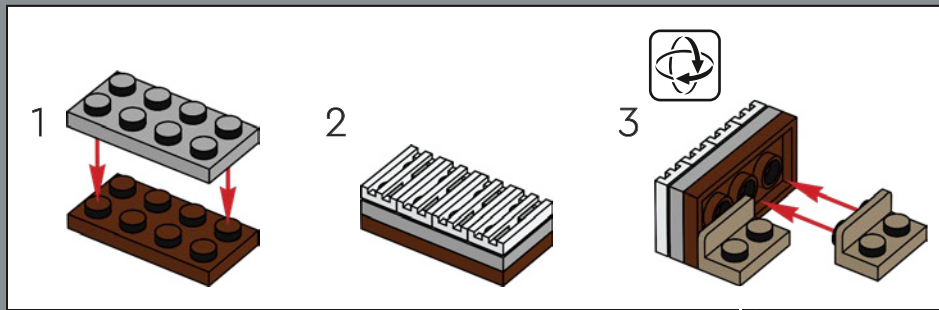

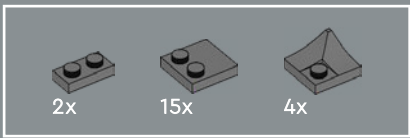

251



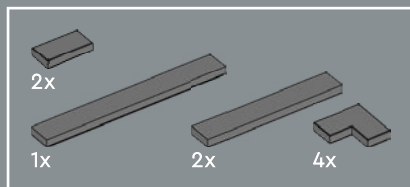

252

La partie supérieure de la structure peut être enlevée pour révéler certains éléments intérieurs, comme la zone du conseil, quasiment vide, pour montrer à quoi elle ressemblait pendant la rénovation de 2009 à 2015.

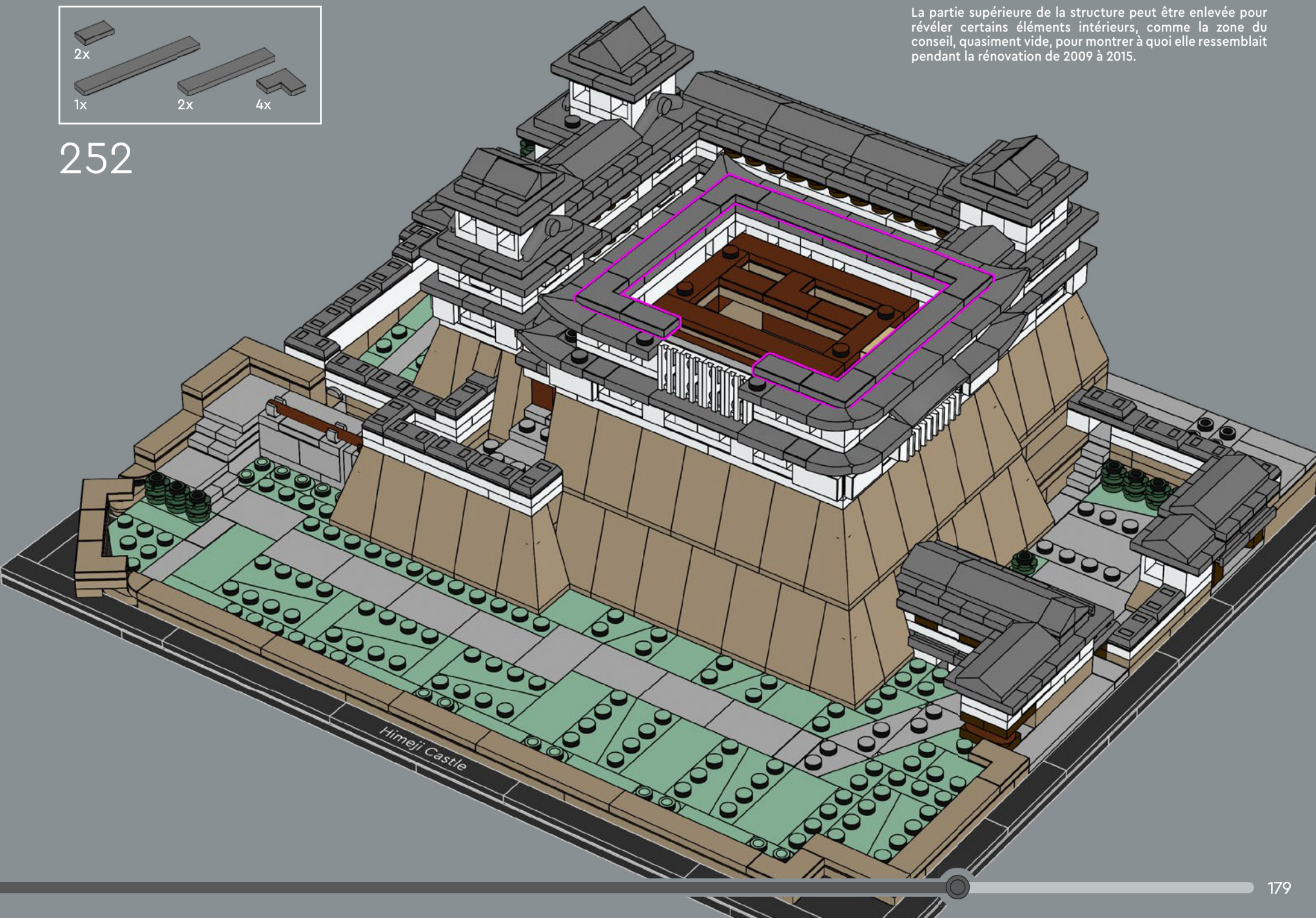

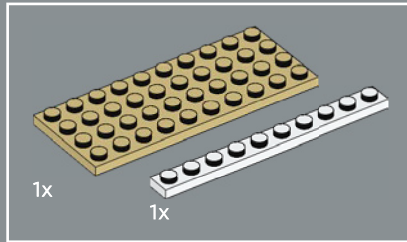
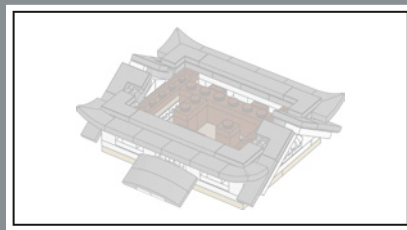

253

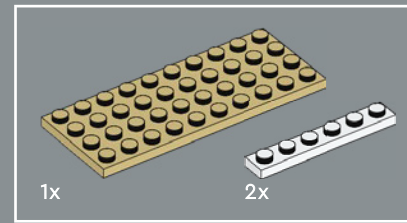
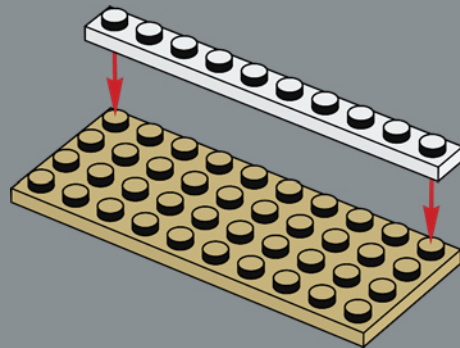

254

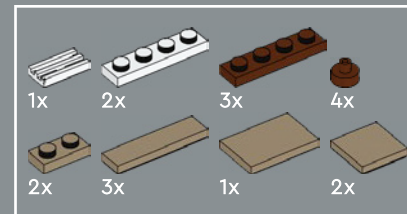
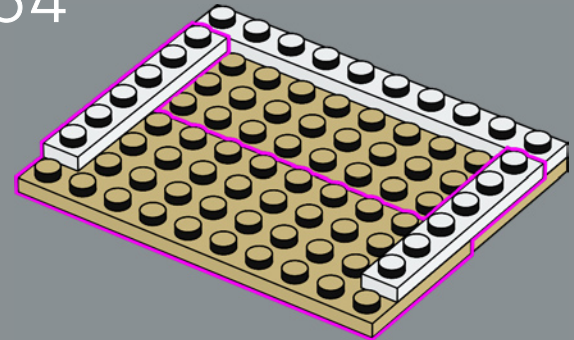

255

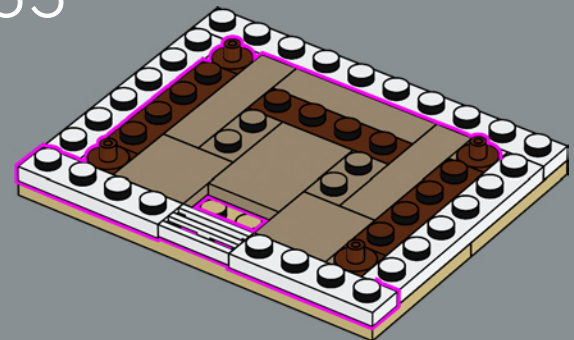

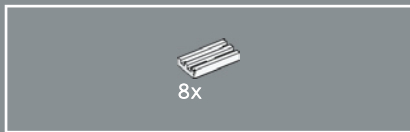

256

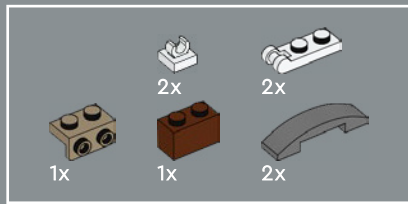
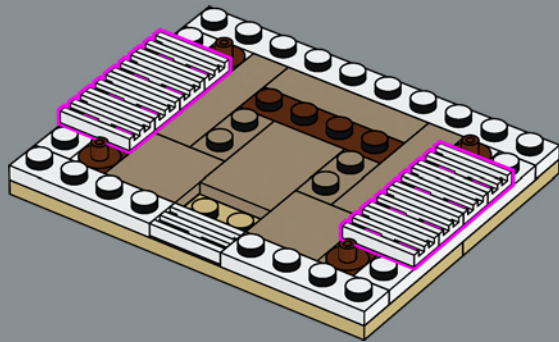

257

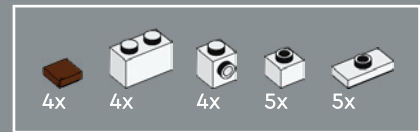
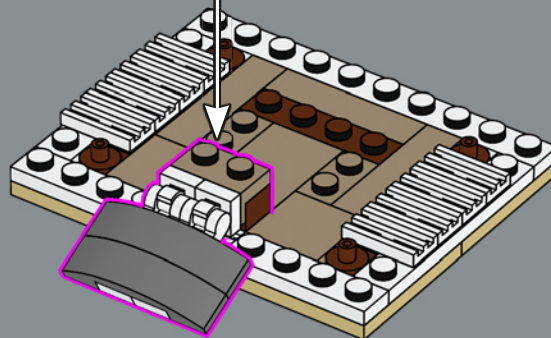
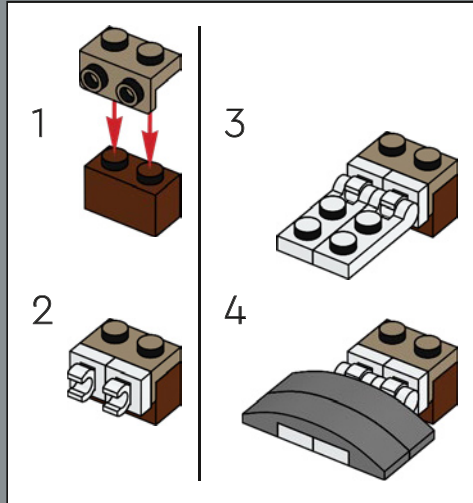

258

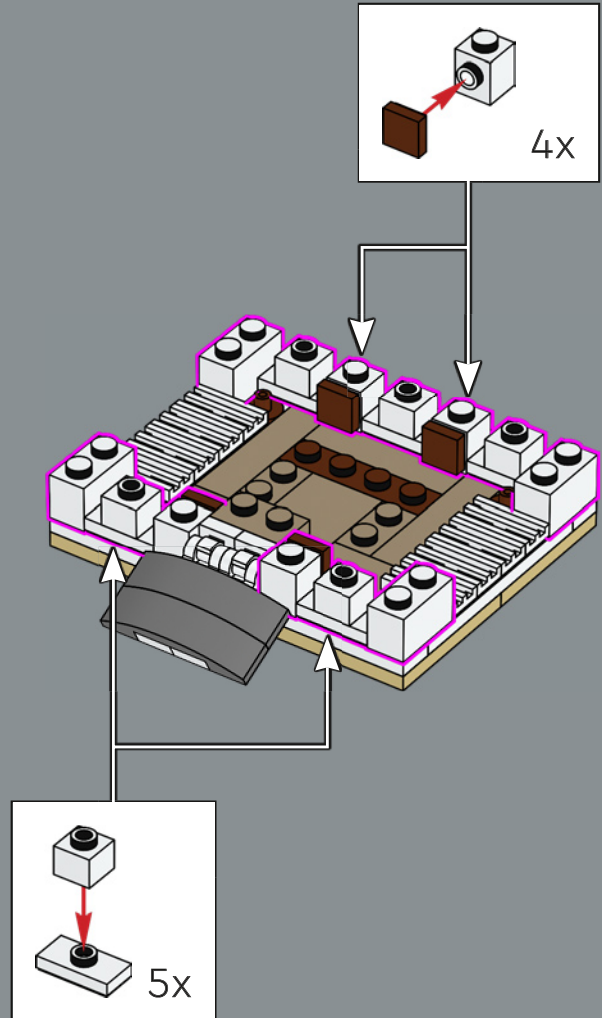

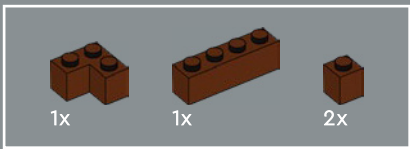

259

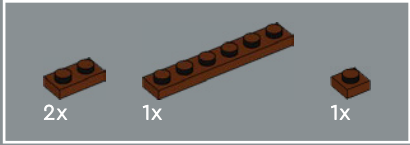
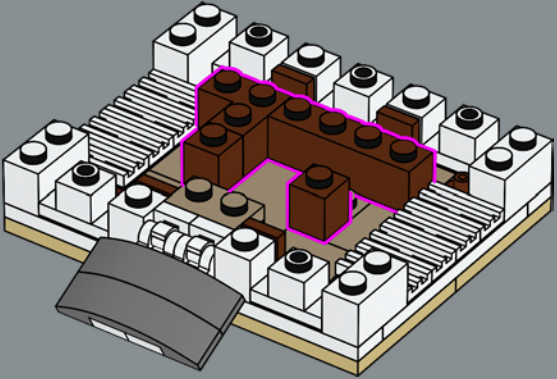

260

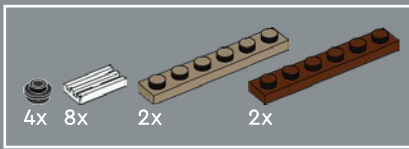
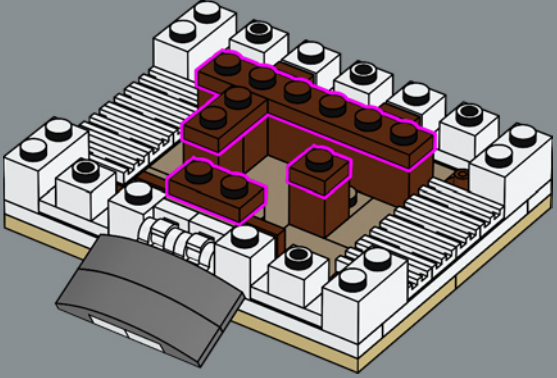

261

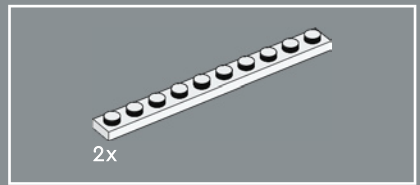
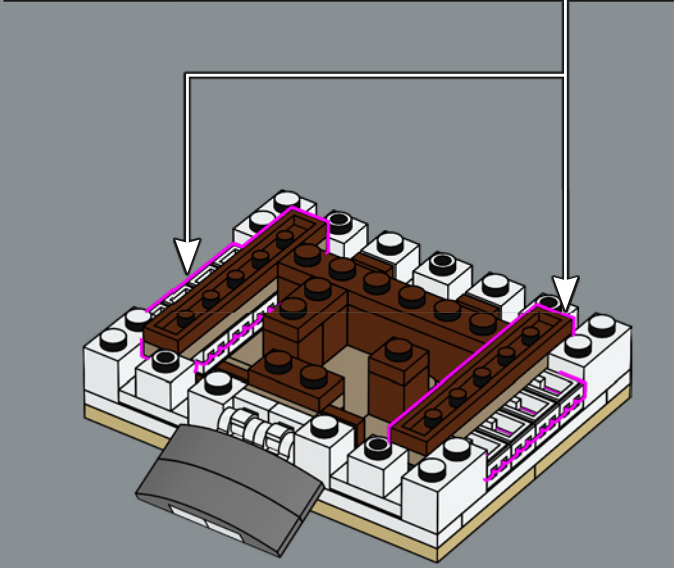
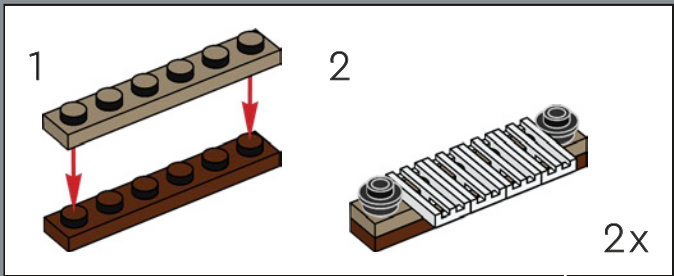

262

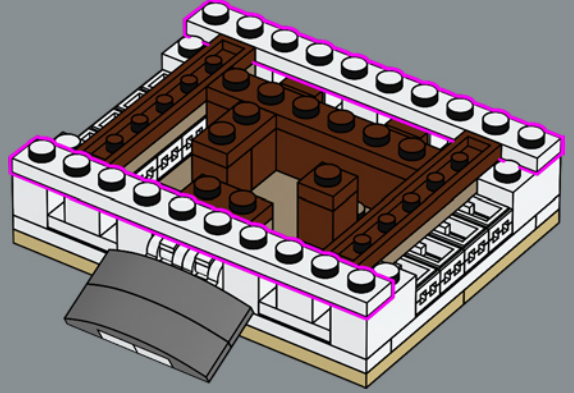

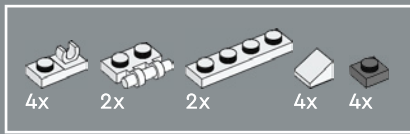

263

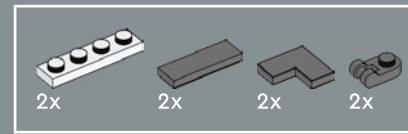
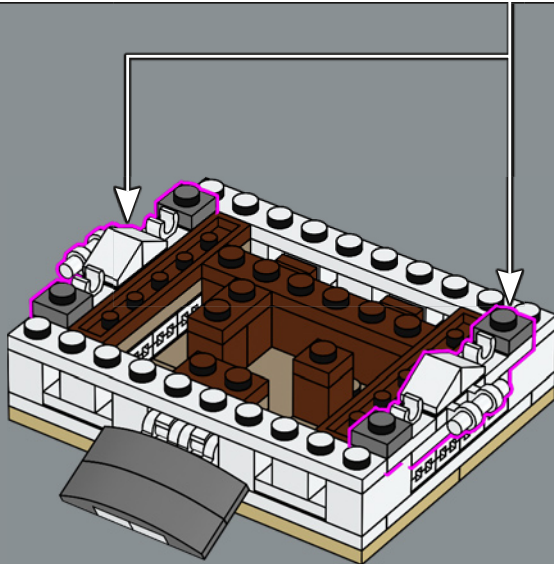
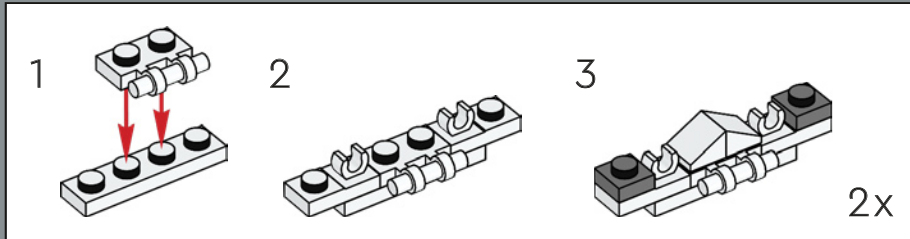

264

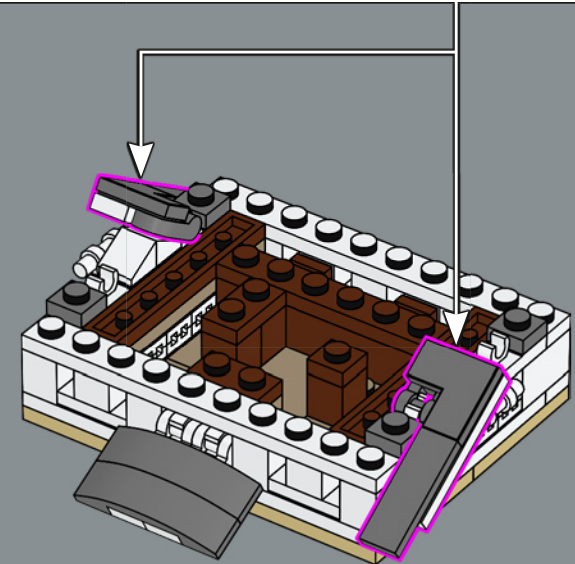
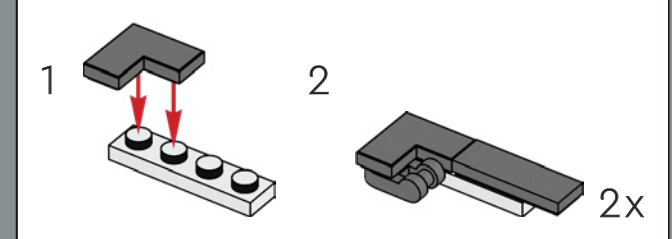

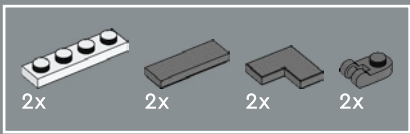

La configuration de chaque étage du donjon principal du château est unique et s'inspire des plans du château d'origine.

265

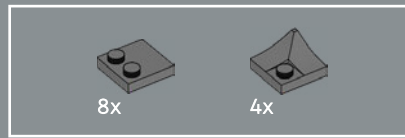
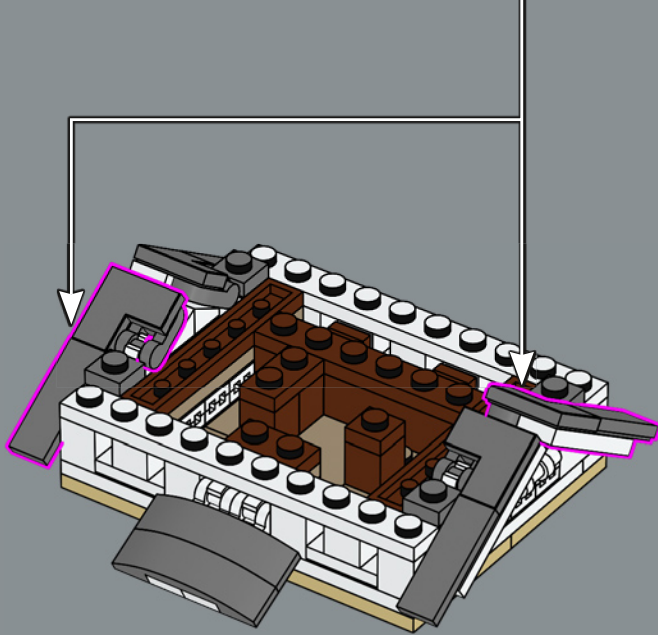
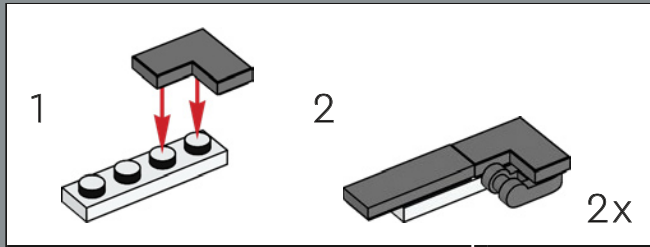

266

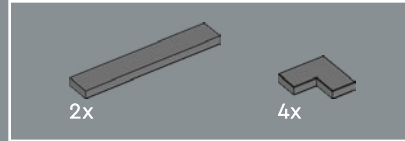
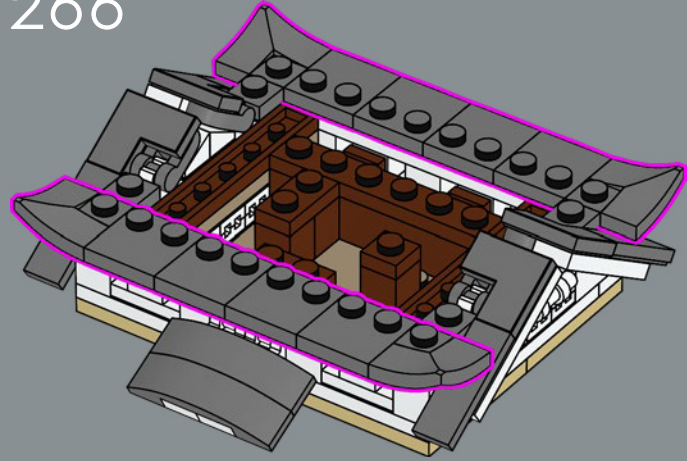

267

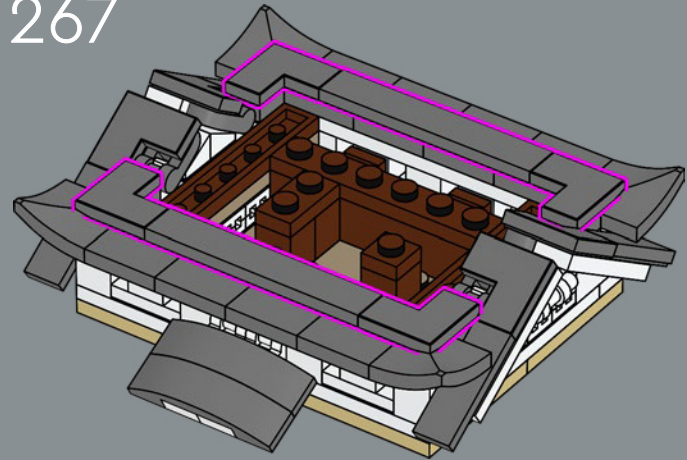

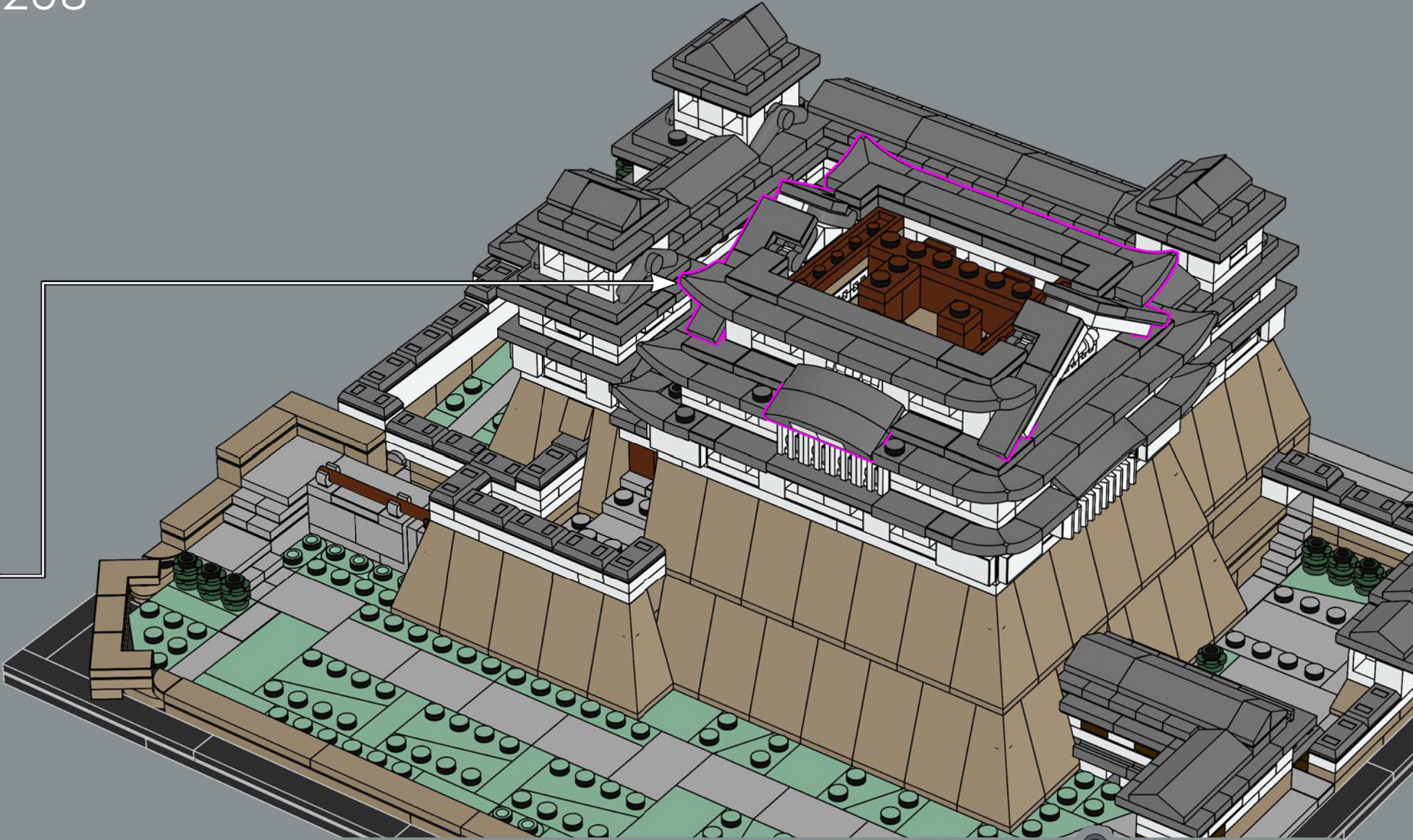

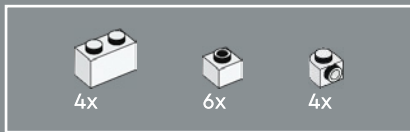

272

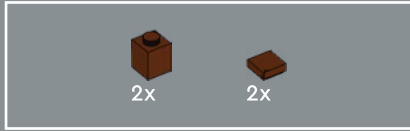
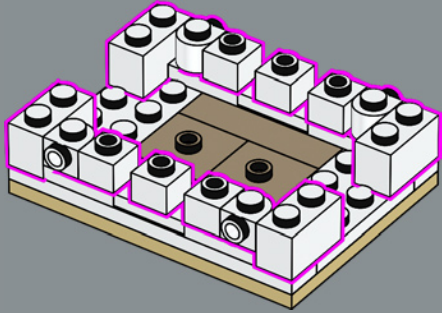

273

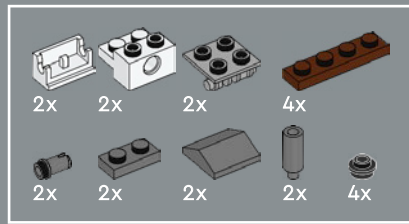
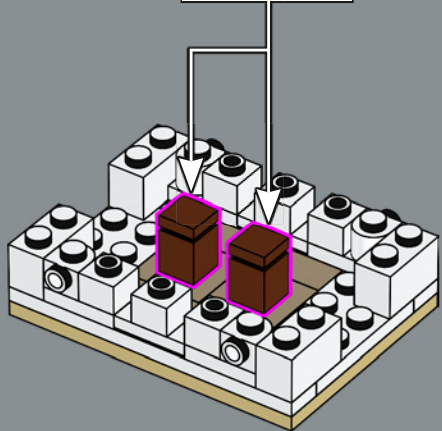
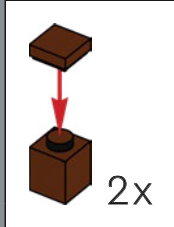

274

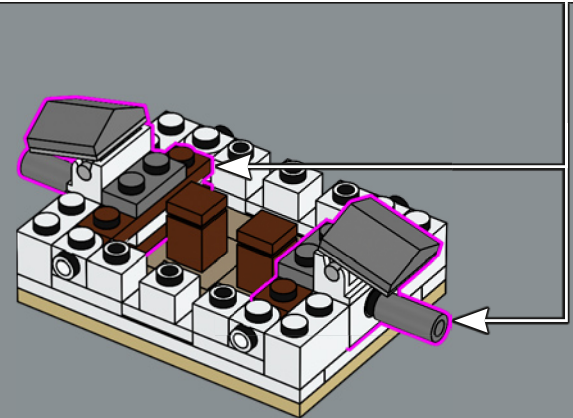
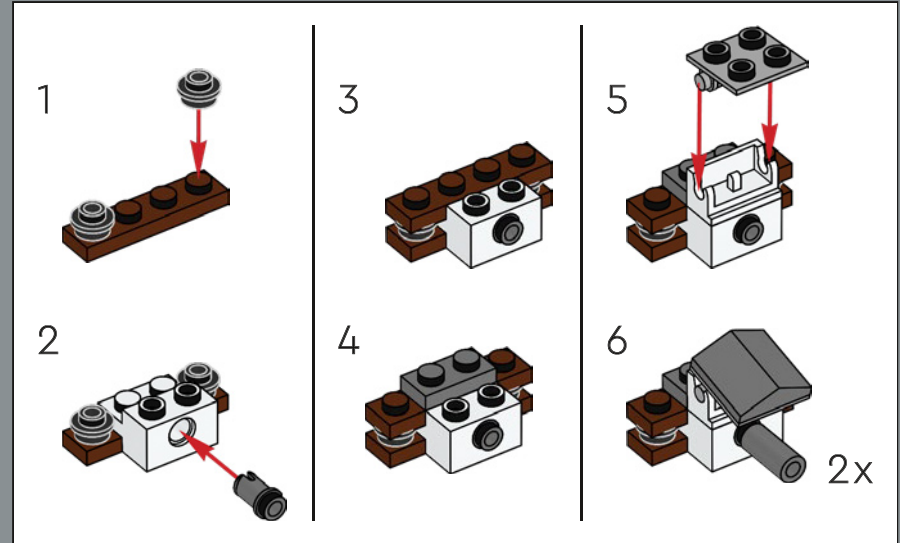

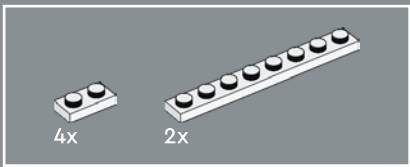

275

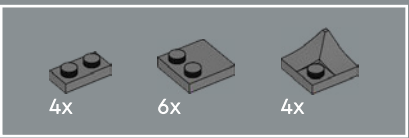
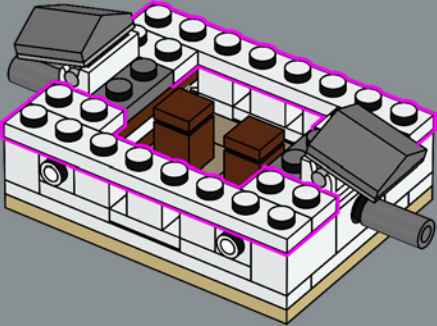

277

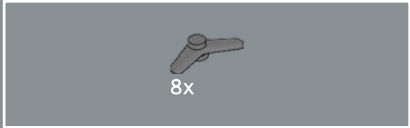
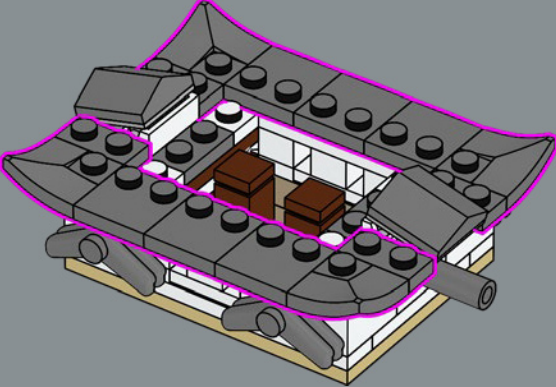

276

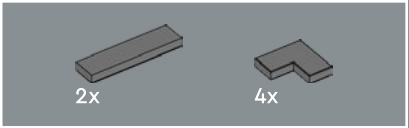
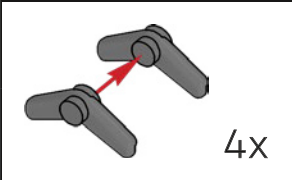
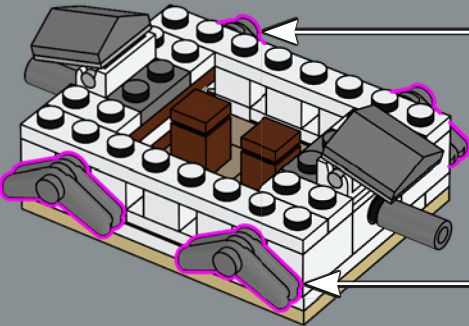

278

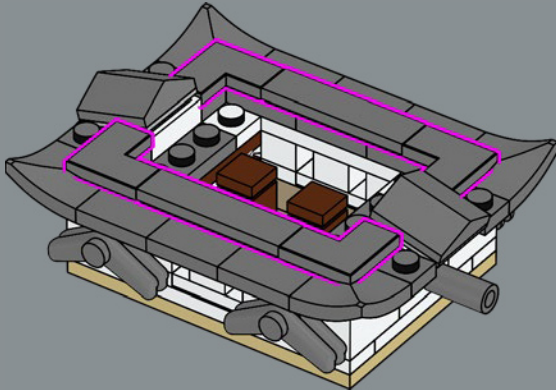

279

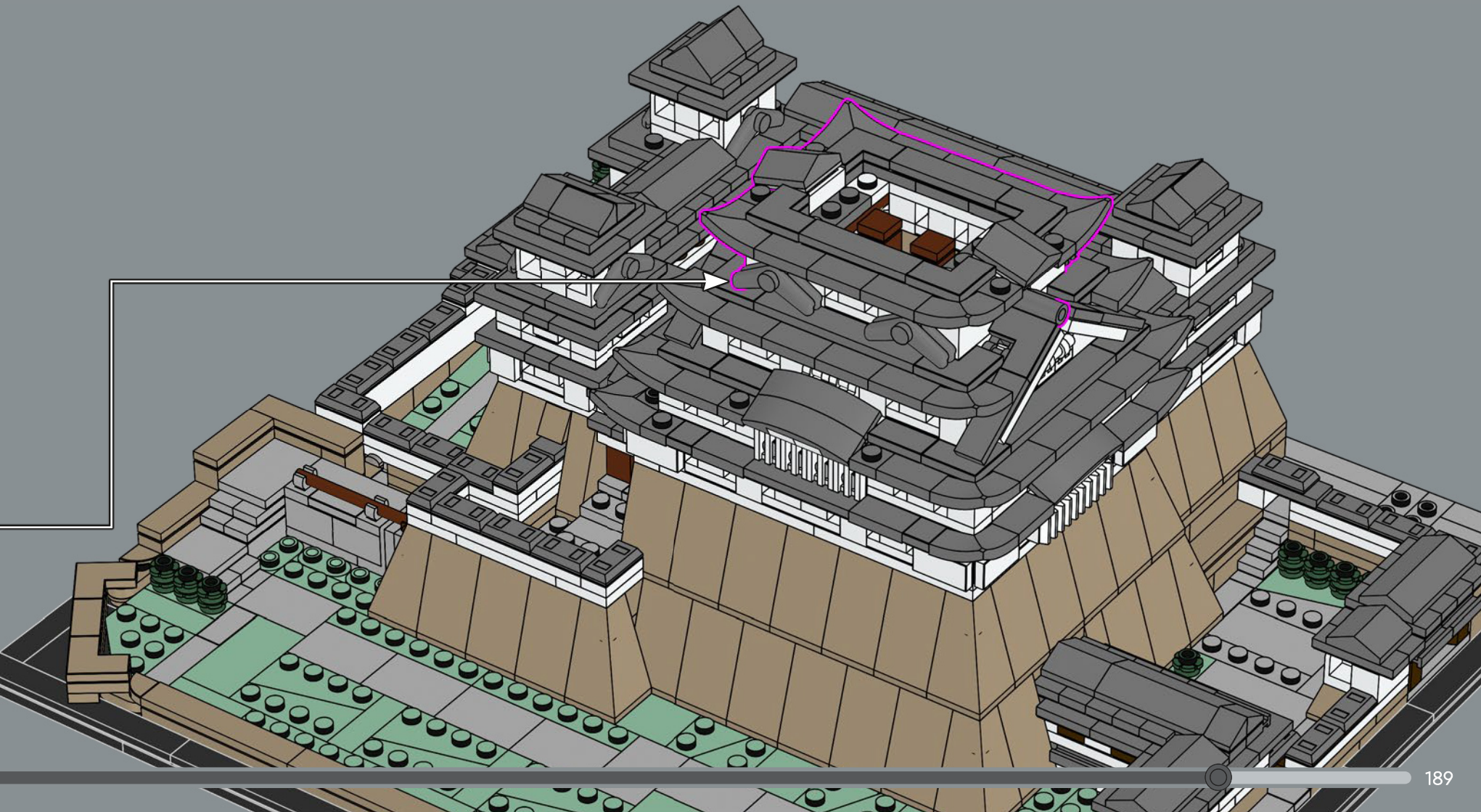

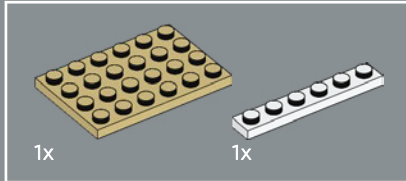
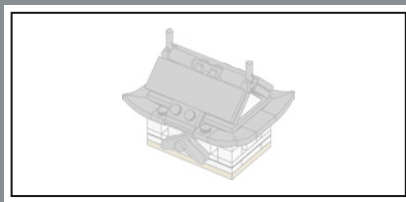

280

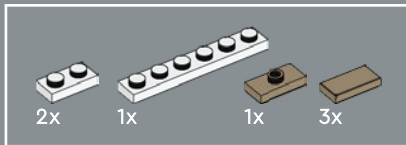
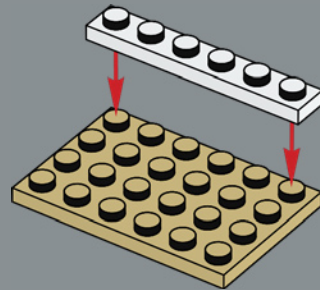

281

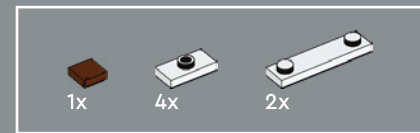
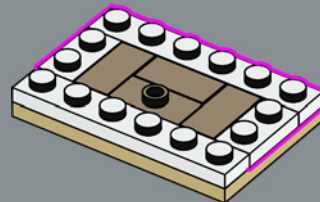

282

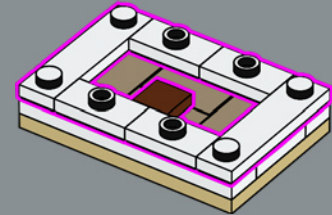

283

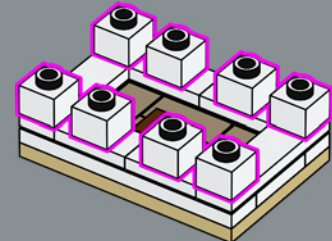

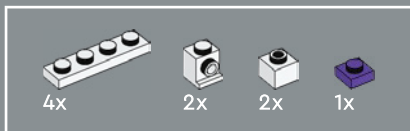

La tuile 1x1 violette située au dernier étage du donjon principal est un clin d'œil au petit temple sacré en bois recouvert d'un rideau violet que l'on trouve dans cette pièce du château.

284

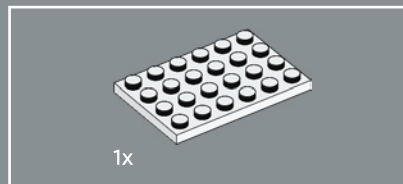
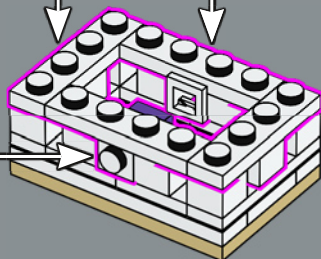
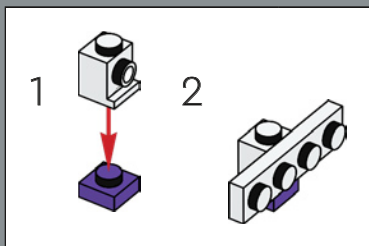
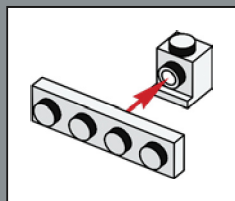
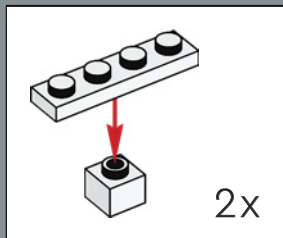

285

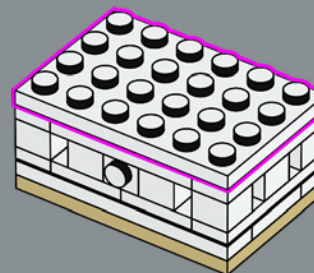

286

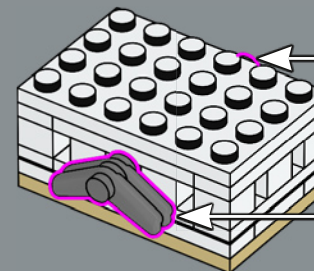
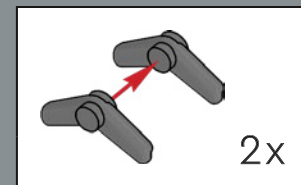

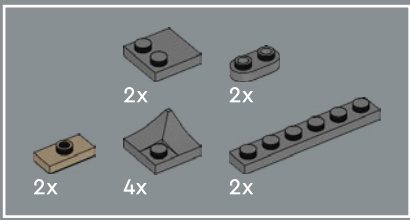

287

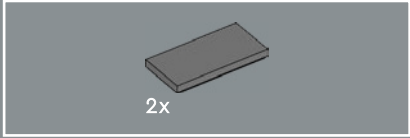
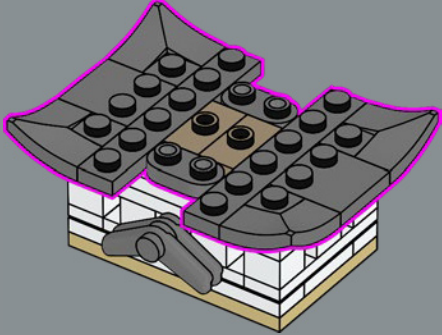

288

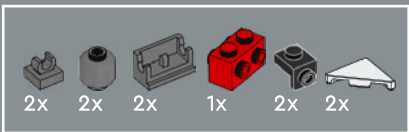
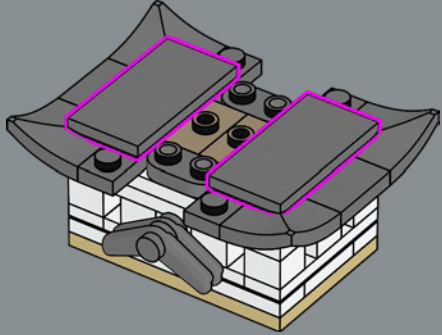

289

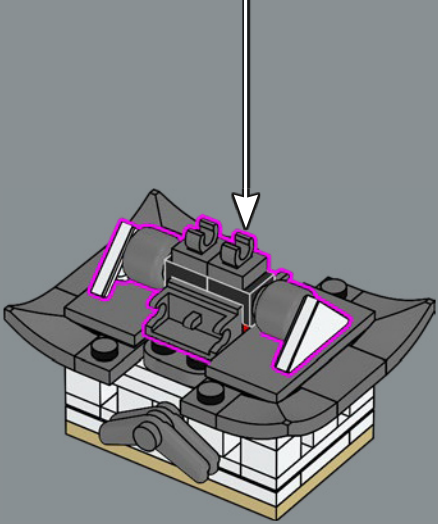
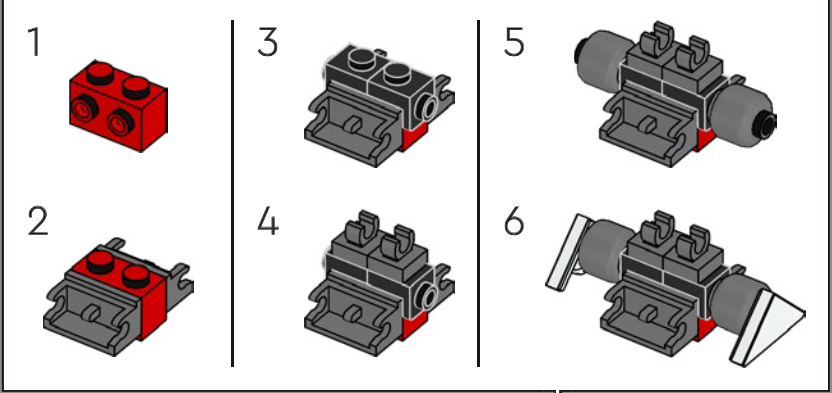

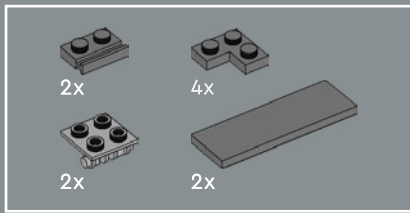

290

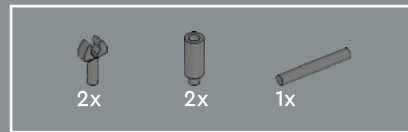
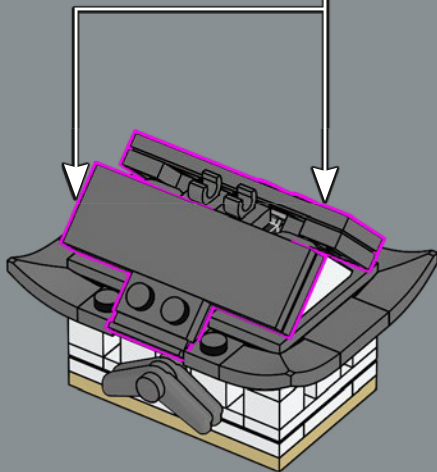
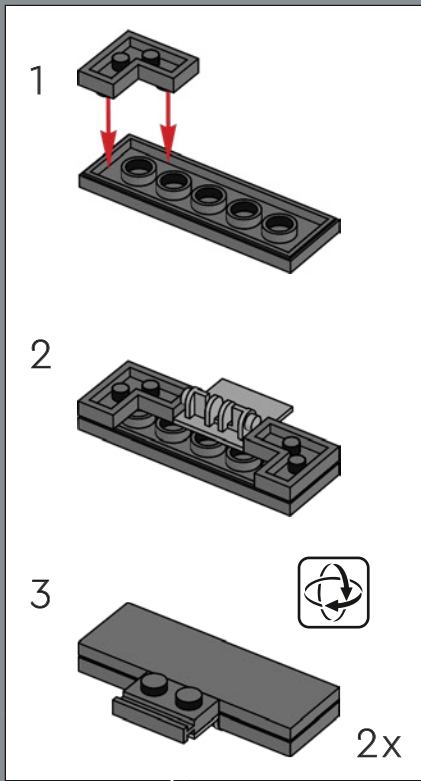

291

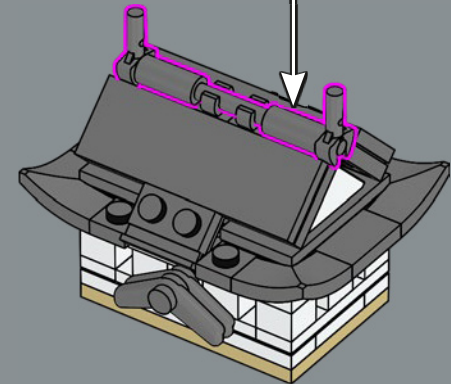
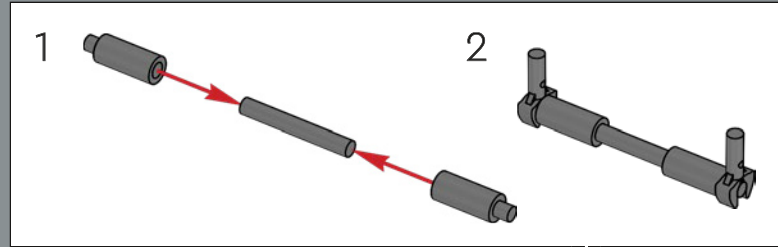

Les tuiles du donjon principal ont été remplacées lors de la rénovation de 2009 à 2015. Plus fines, les nouvelles tuiles pèsent chacune 0,75 kg de moins que les précédentes. Ainsi, le toit a été allégé de 45 tonnes !

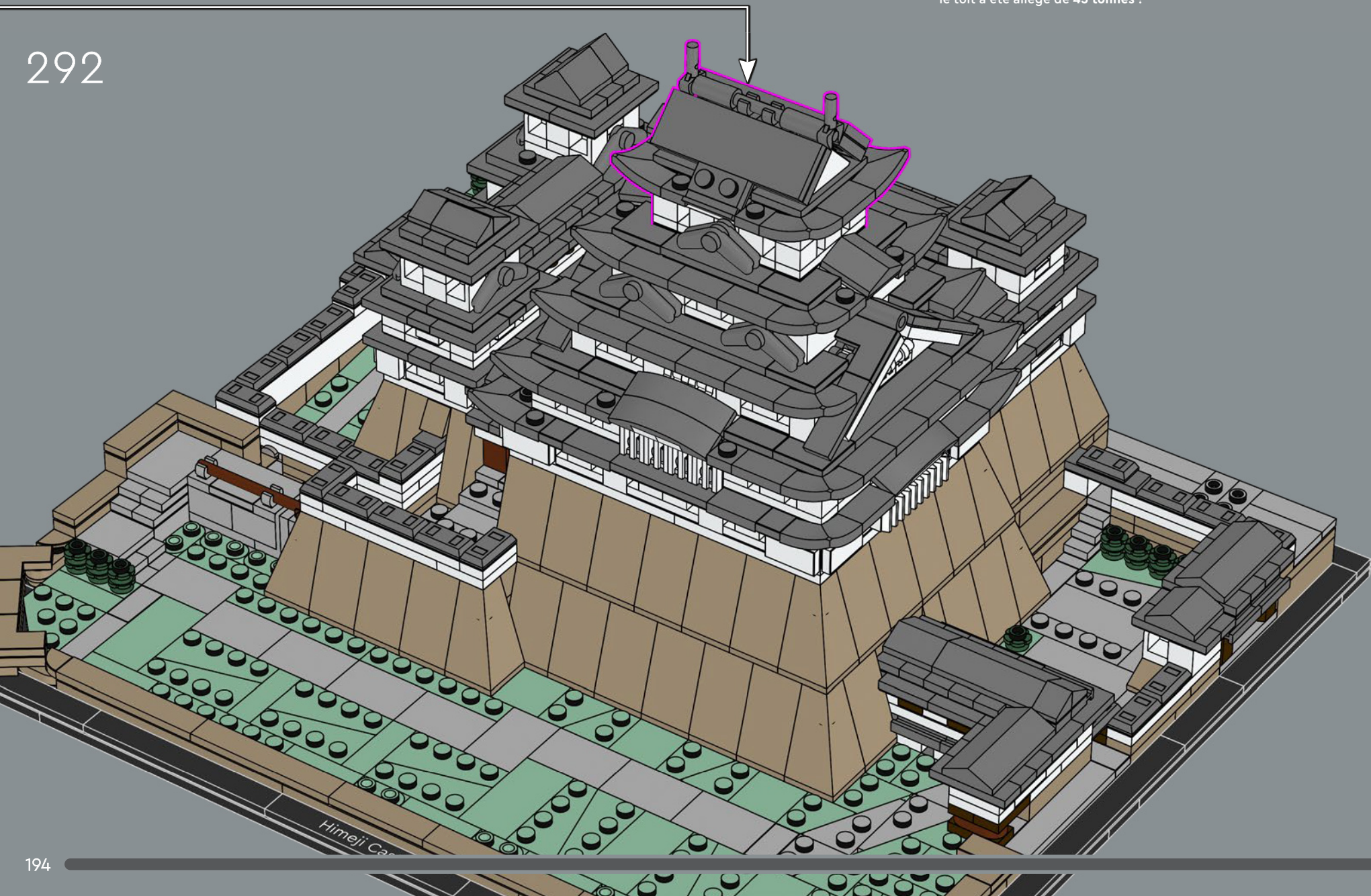



3x



3x

293

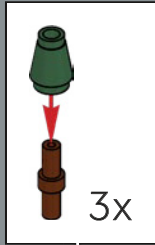

3x

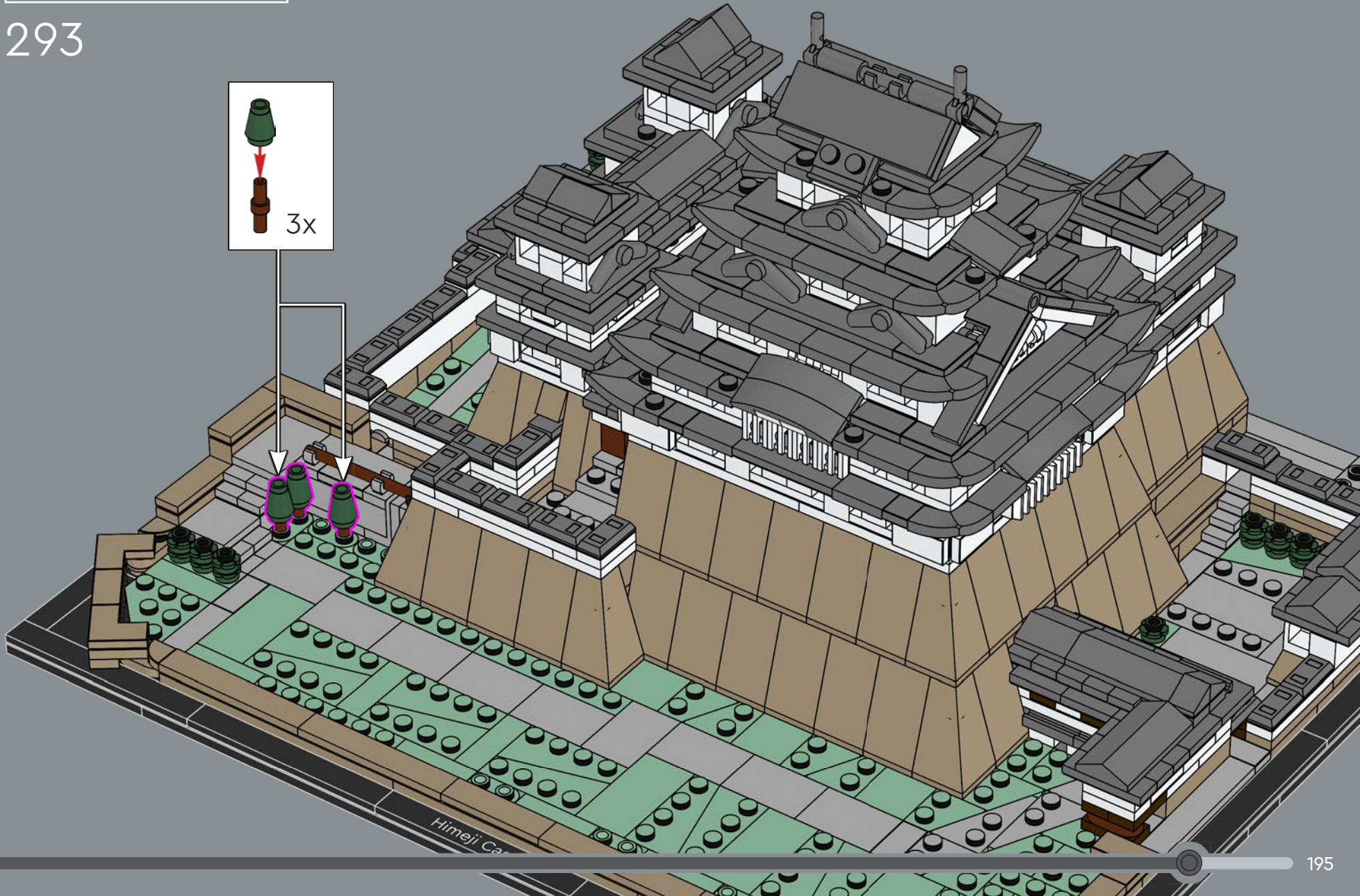



294

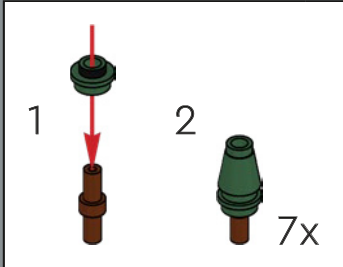

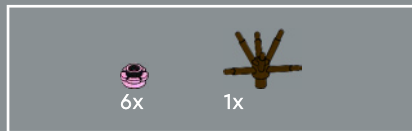

295

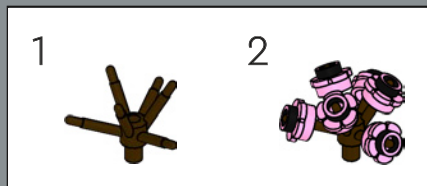

3x

296

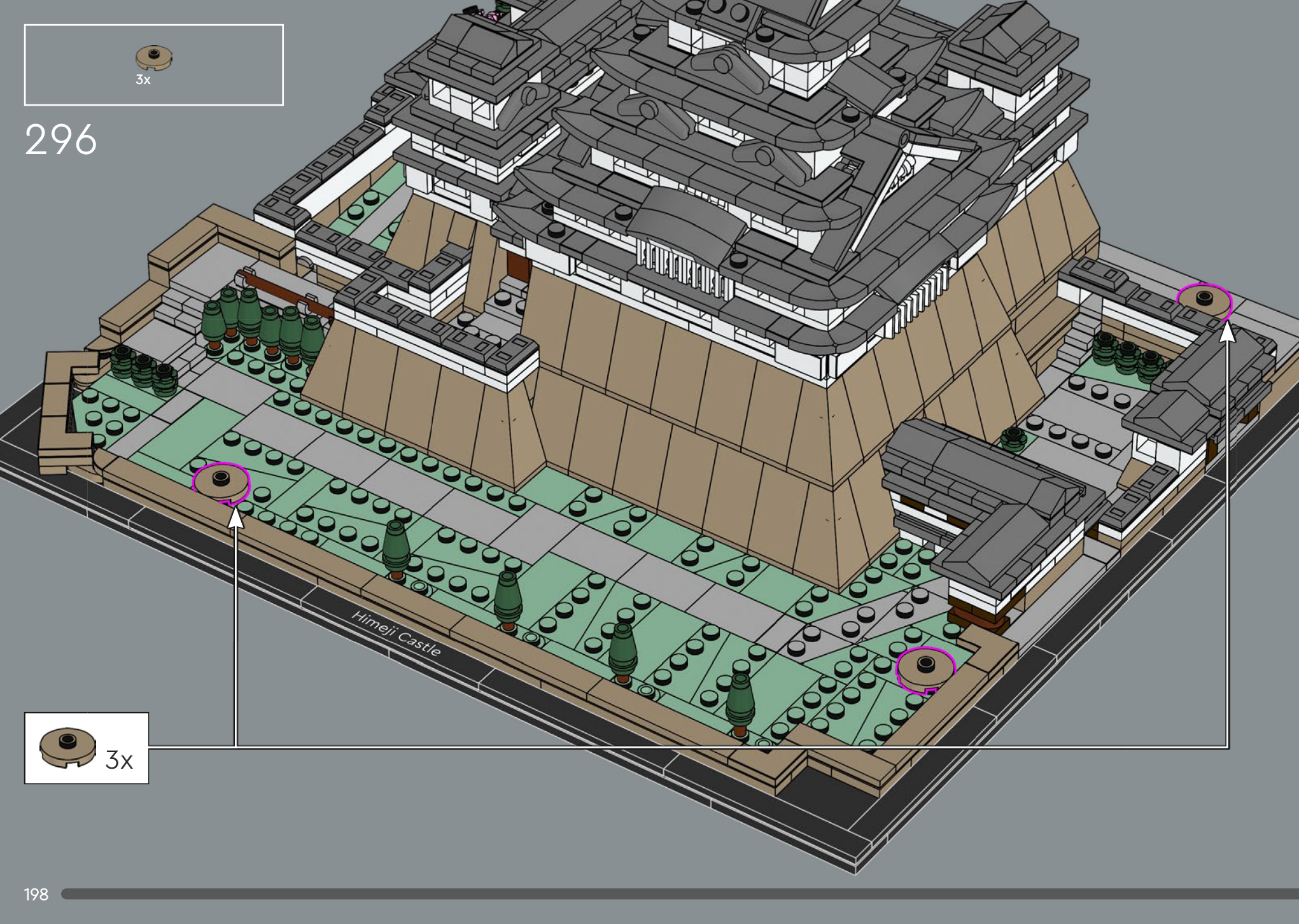

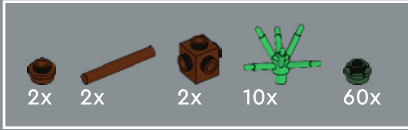
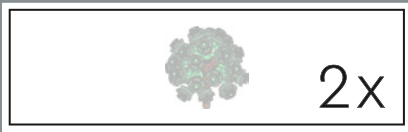

297

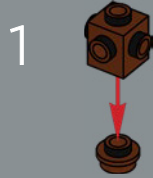
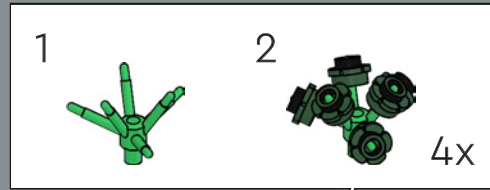
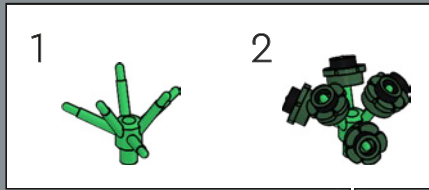



298

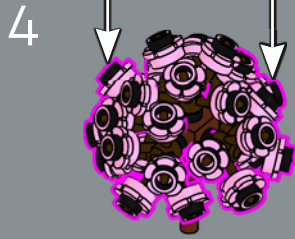
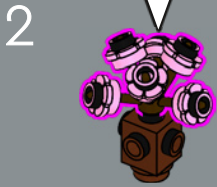
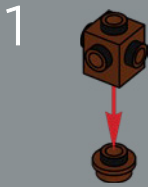
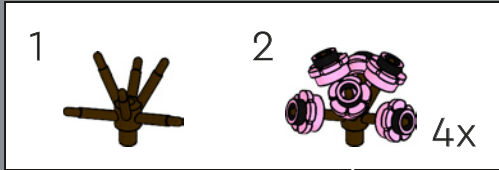
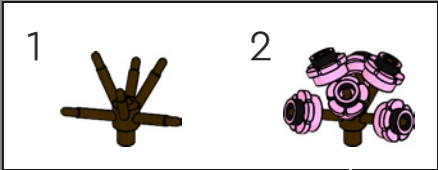



Himeji Castle



299

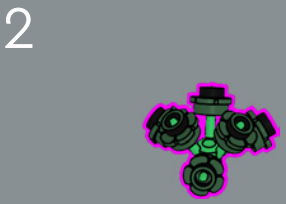
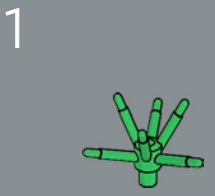
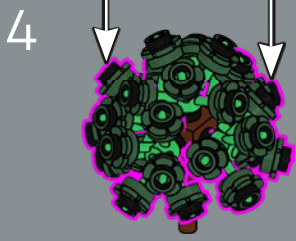
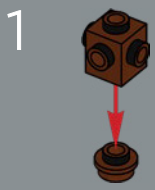
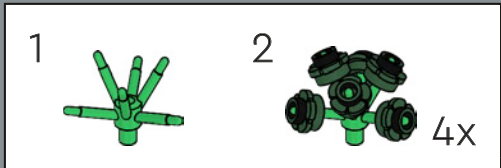
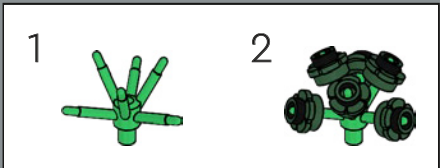

Le château d'Himeji est également connu sous le nom de château du Héron blanc, car il ressemble à l'oiseau majestueux prenant son envol.

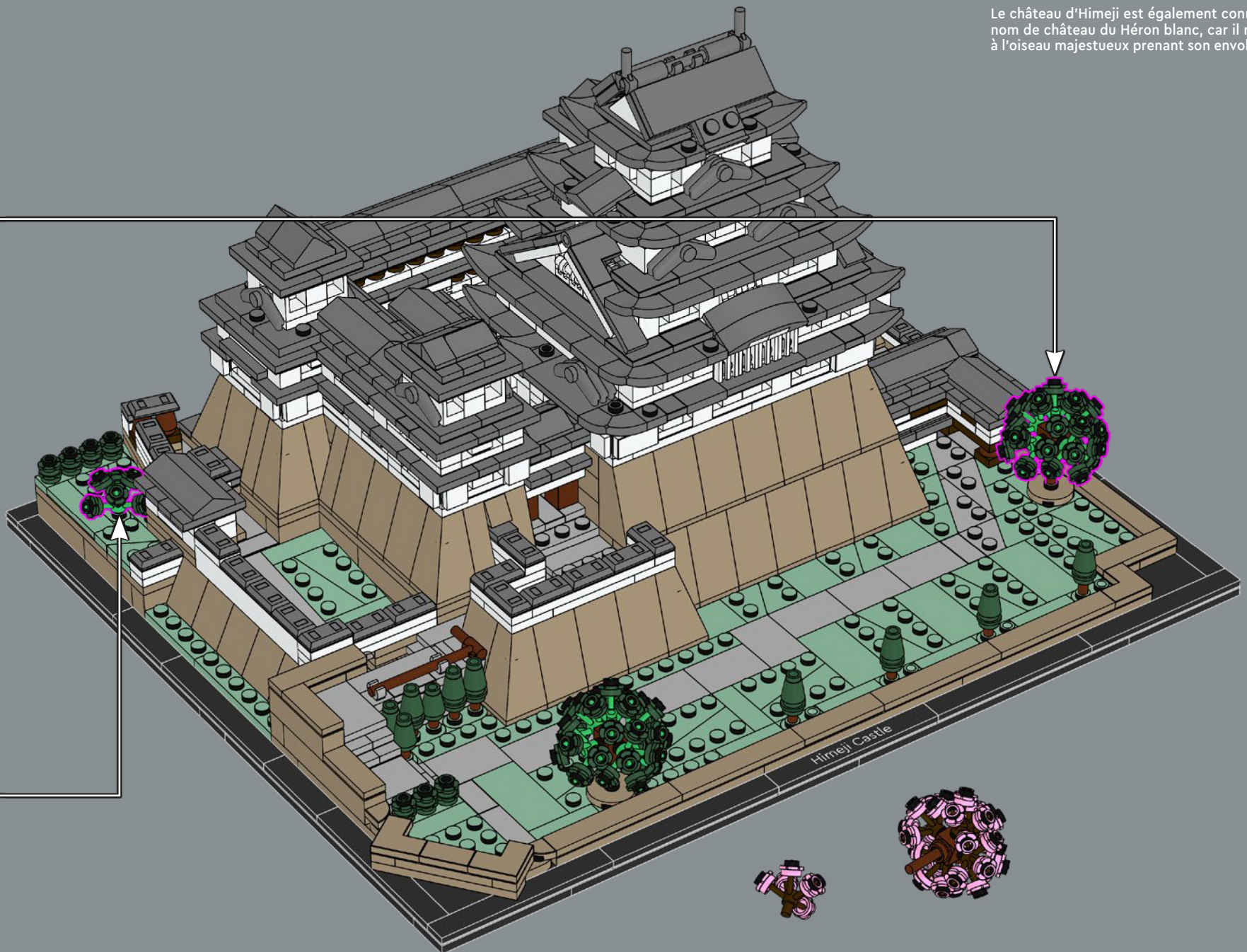

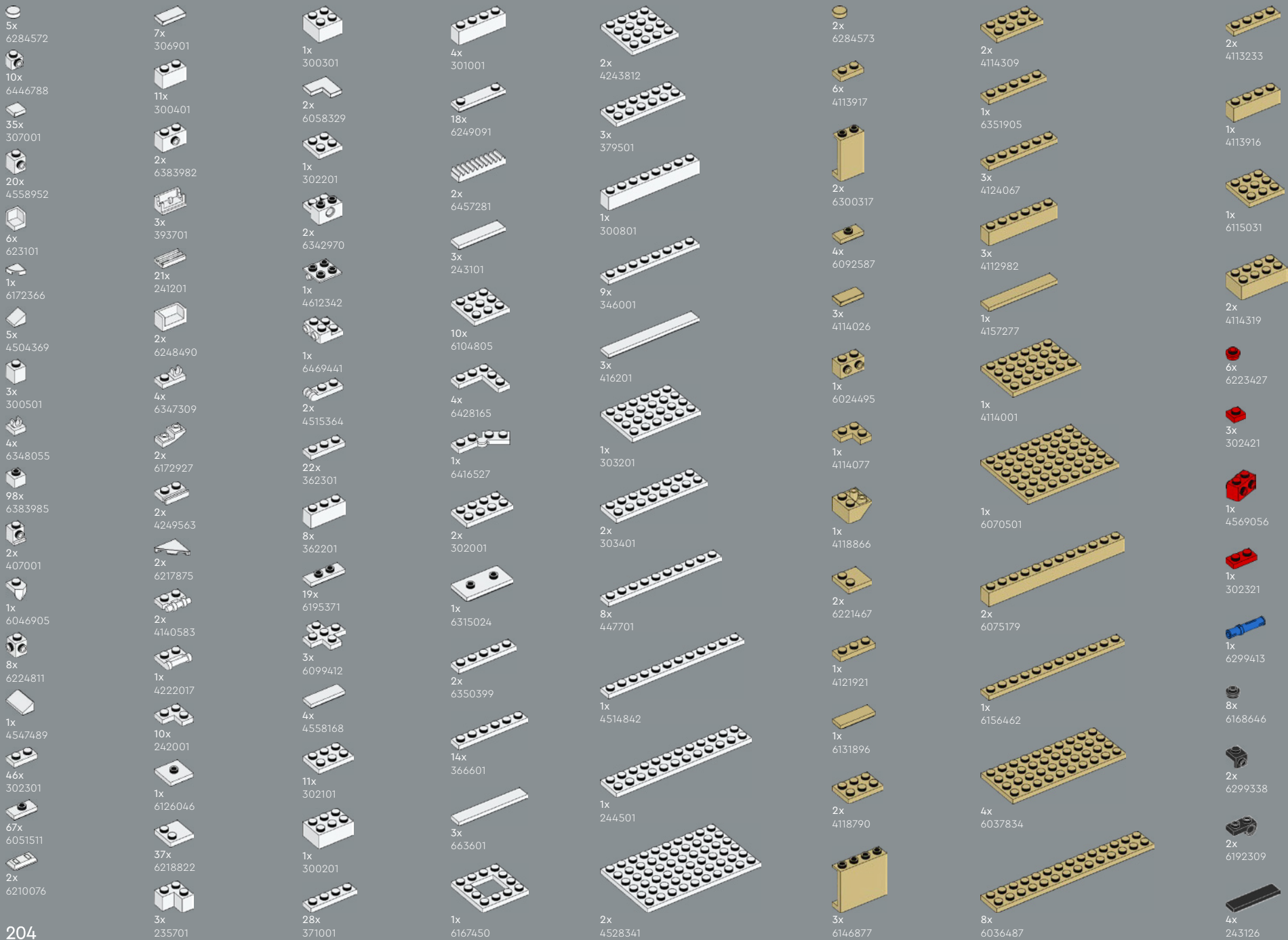



- 1x 6126082
- 1x 4211397
- 2x 4211349
- 1x 4211413
- 4x 4211881
- 1x 6438836
- 12x 4558169
- 12x 6211969
- 3x 4211429
- 16x 6171894
- 2x 4211356
- 5x 6257593
- 2x 4211445
- 5x 4560183
- 2x 4211395
- 1x 4211385
- 2x 4211549
- 4x 4211795
- 5x 4211481

- 1x 4211407
- 4x 4211408
- 6x 4211405
- 6x 4662161
- 4x 6058221
- 6x 6452882
- 1x 6252667
- 2x 6226792
- 1x 6223039
- 36x 6212501
- 4x 6388120
- 4x 4529240
- 2x 6439040
- 1x 4211407
- 4x 4211408
- 6x 4211405
- 4x 6058221
- 6x 6452882
- 1x 6252667
- 2x 6226792
- 1x 6223039
- 36x 6212501
- 4x 6388120
- 4x 4529240
- 2x 6439040

- 2x 6192569
- 2x 6395635
- 4x 4210848
- 9x 4210719
- 2x 6344022
- 6x 4504378
- 2x 6199549
- 2x 6221607
- 4x 6388119
- 1x 4226221
- 6x 4567887
- 29x 6331866
- 20x 6092572
- 12x 4211063
- 6x 4211052
- 2x 4211066
- 2x 4211135
- 2x 6395635
- 4x 4210848
- 9x 4210719
- 2x 6344022
- 6x 4504378
- 2x 6199549
- 2x 6221607
- 4x 6388119
- 1x 4226221
- 6x 4567887
- 29x 6331866
- 20x 6092572
- 12x 4211063
- 6x 4211052
- 2x 4211066
- 2x 4211135

- 3x 6000606
- 9x 4543086
- 20x 6446785
- 1x 6310596
- 12x 6126083
- 6x 6446786
- 1x 4211094
- 43x 6309059
- 2x 4210702
- 18x 6247784
- 1x 6232193
- 21x 6447212
- 4x 4210635
- 1x 4211055
- 60x 6343852
- 8x 4568734
- 3x 6000606
- 9x 4543086
- 20x 6446785
- 1x 6310596
- 12x 6126083
- 6x 6446786
- 1x 4211094
- 43x 6309059
- 2x 4210702
- 18x 6247784
- 1x 6232193
- 21x 6447212
- 4x 4210635
- 1x 4211055
- 60x 6343852
- 8x 4568734

- 1x 4211043
- 3x 6187008
- 4x 4211053
- 3x 4648256
- 2x 6039176
- 41x 6307616
- 6x 4560184
- 3x 4211127
- 10x 6189120
- 4x 4210651
- 2x 4211056
- 2x 6321746
- 1x 6230281
- 1x 4211043
- 3x 6187008
- 4x 4211053
- 3x 4648256
- 2x 6039176
- 41x 6307616
- 6x 4560184
- 3x 4211127
- 10x 6189120
- 4x 4210651
- 2x 4211056
- 2x 6321746
- 1x 6230281

- 2x 4210998
- 1x 4211008
- 1x 4210997
- 1x 4211061
- 2x 6133611
- 1x 6000970
- 1x 6231376
- 2x 6215447
- 3x 6093529
- 25x 6315780
- 3x 6259071
- 4x 6194729
- 3x 4519970
- 2x 4210998
- 1x 4211008
- 1x 4210997
- 1x 4211061
- 2x 6133611
- 1x 6000970
- 1x 6231376
- 2x 6215447
- 3x 6093529
- 25x 6315780
- 3x 6259071
- 4x 6194729
- 3x 4519970



[LEGO.com/service](https://www.LEGO.com/service)



YOU COULD WIN



YOU COULD WIN

Your feedback will help shape the future development of this product series.

Visit:

DU KÖNNTEST GEWINNEN

Dein Feedback trägt zur Weiterentwicklung dieser Produktreihe bei.

Geh auf:

VOUS POURRIEZ GAGNER

Vos commentaires nous aideront à concevoir les futurs produits de cette gamme.

Visitez :

POTRESTI VINCERE TU

La tua opinione ci aiuterà a migliorare la creazione futura di questa linea di prodotti.

Visita:

PUEDES GANAR

Tu opinión contribuirá al futuro de esta serie de productos.

Visita:

轻松获奖

您的反馈将有助于我们在今后改进本产品系列。

请访问:

[LEGO.com/productfeedback](https://www.lego.com/productfeedback)

You also have the chance to win a LEGO® set.

Terms and conditions apply.*

Außerdem hast du die Chance, ein LEGO® Set zu gewinnen.

Es gelten die Teilnahmebedingungen.*

Vous pourriez également gagner un ensemble LEGO®.

Des conditions s'appliquent.*

Hai anche la possibilità di vincere un set LEGO®.

Termini e condizioni sono applicabili.*

También tienes la oportunidad de ganar un set LEGO®.

Aplican términos y condiciones.*

您还有机会赢取乐高®套装。

条款和条件适用。*

*[LEGO.com/productfeedback-terms](https://www.lego.com/productfeedback-terms)

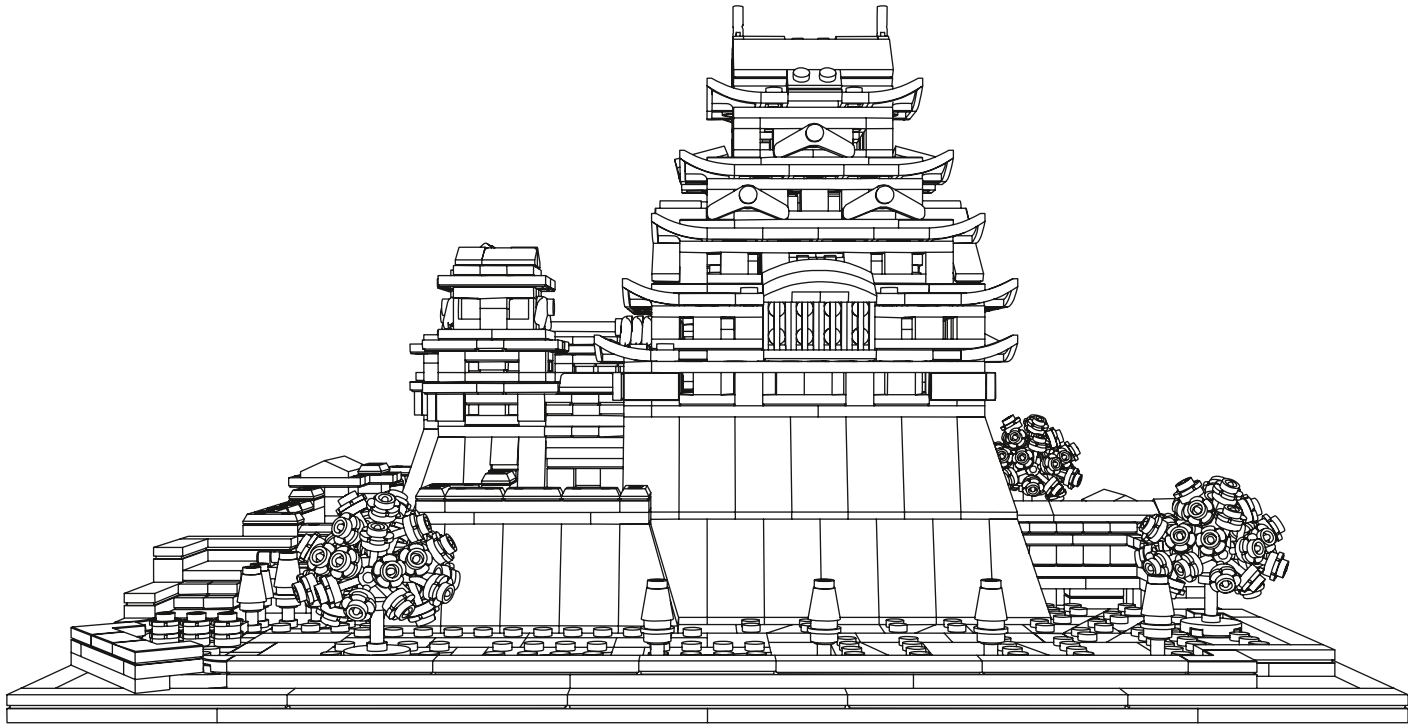

LEGO and the LEGO logo are trademarks of the LEGO Group. ©2023 The LEGO Group.

Adam Reed Tucker is the co-developer of the LEGO® Architecture product line.