



# MINECRAFT

21127





1

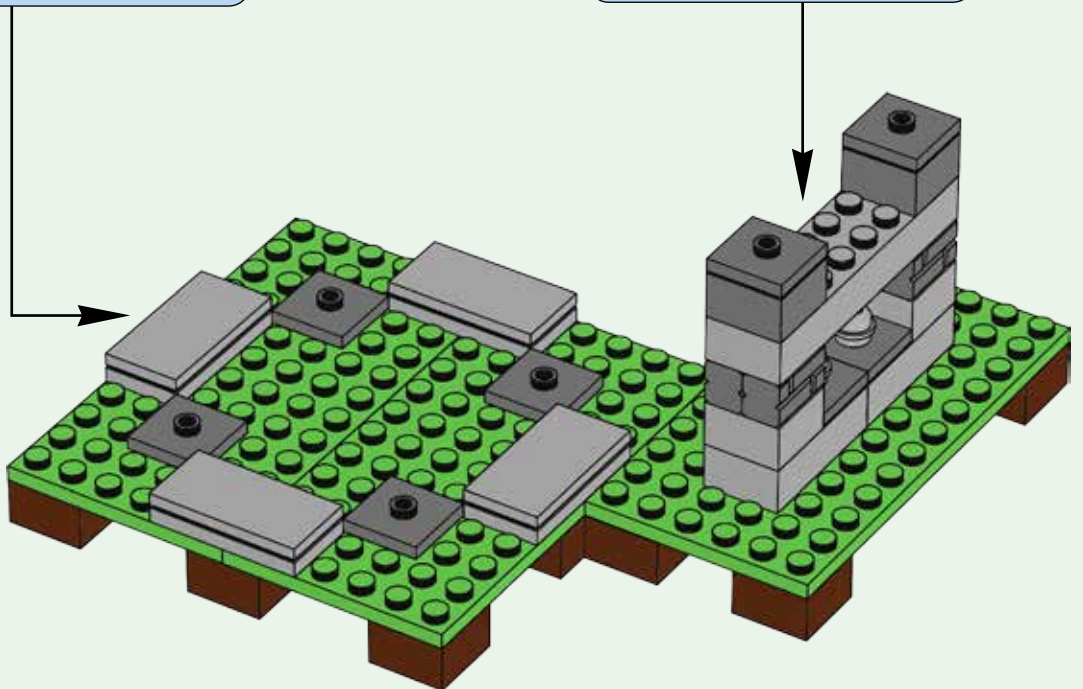
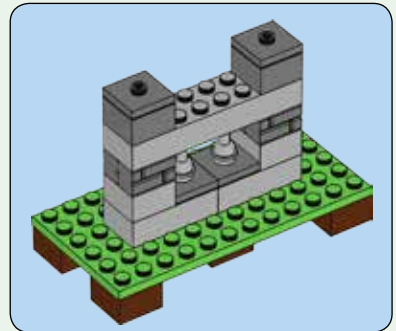
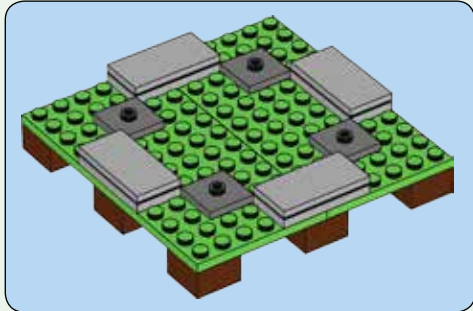

2

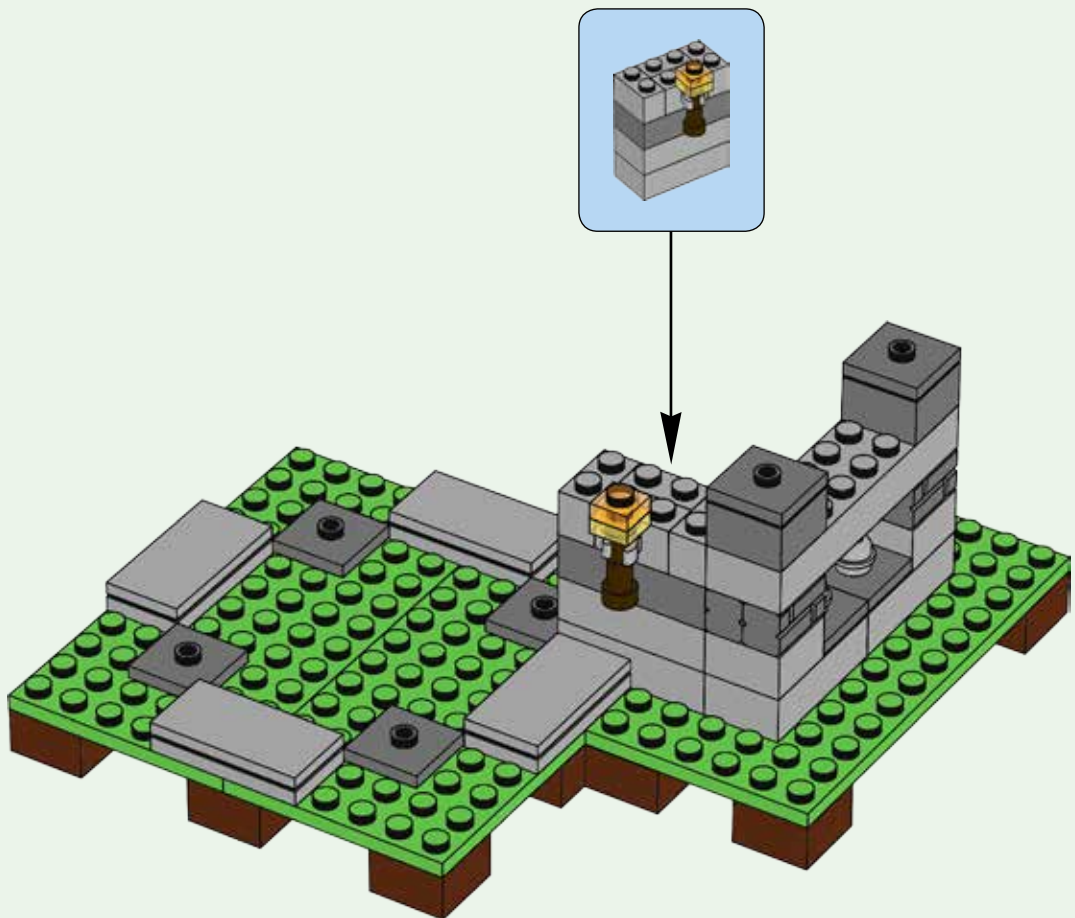

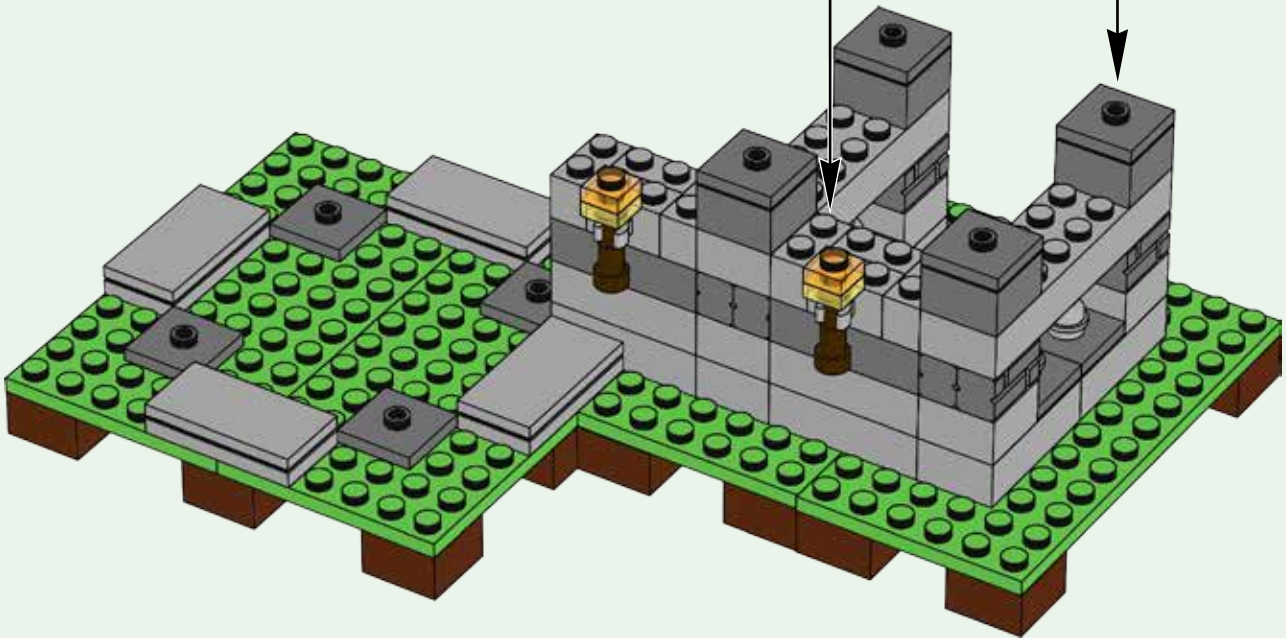
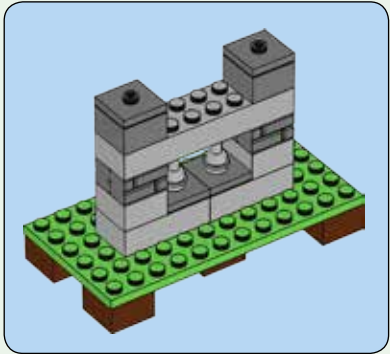

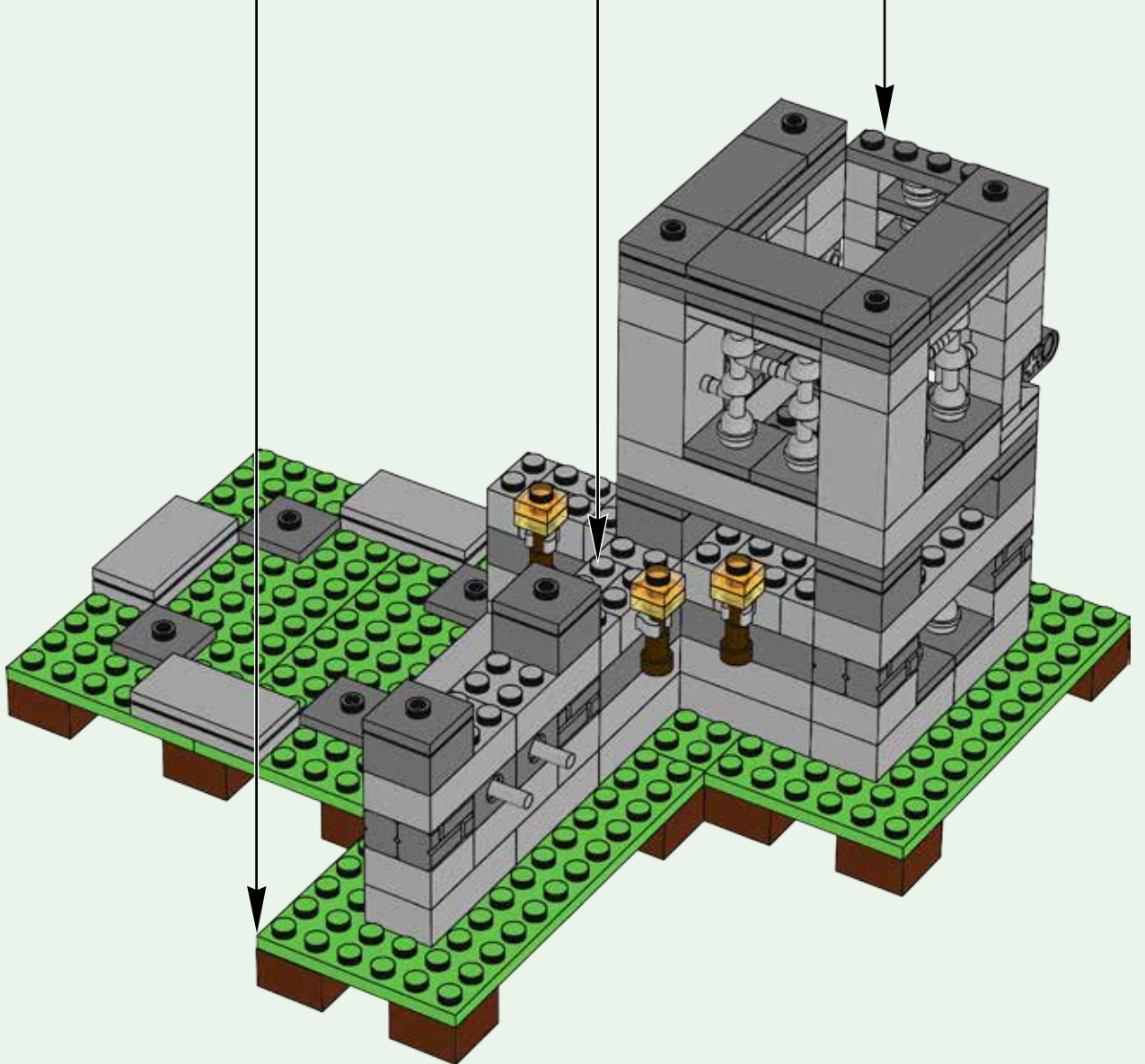
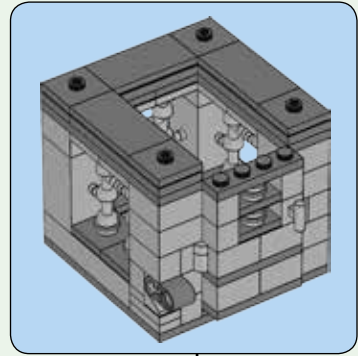
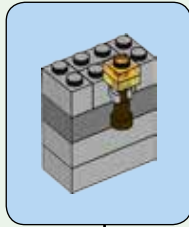
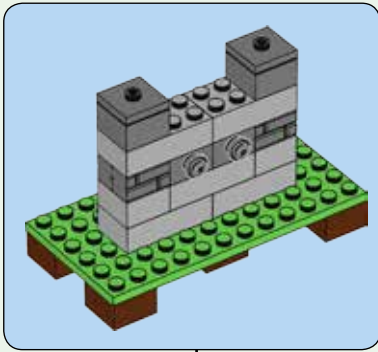

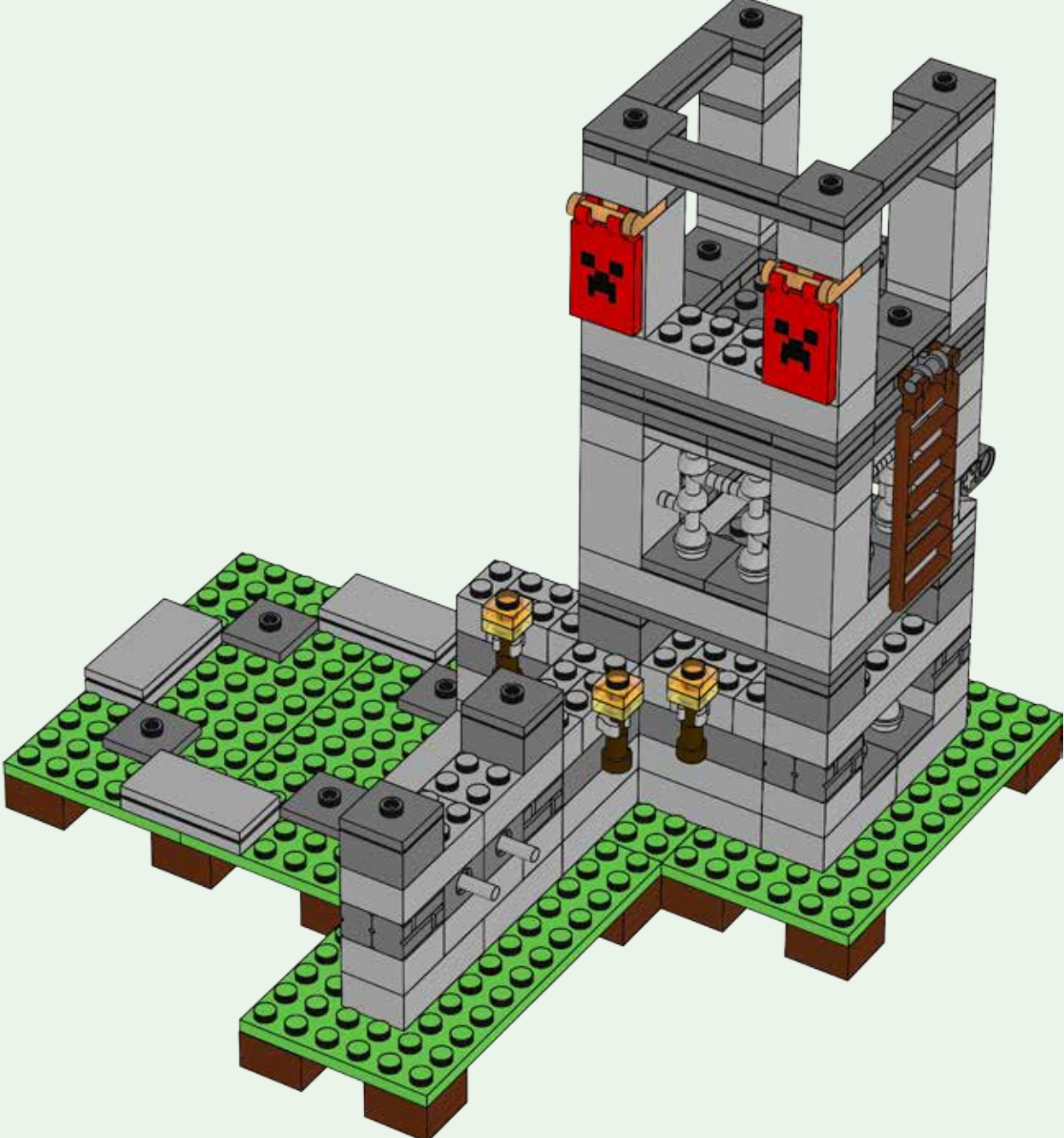
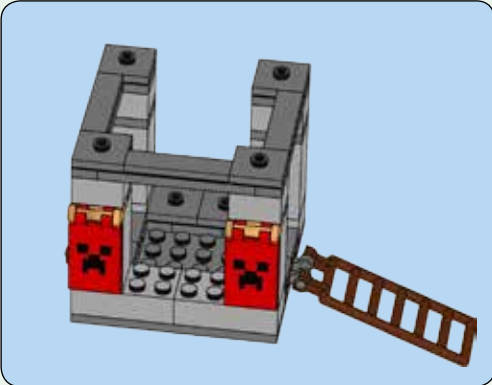

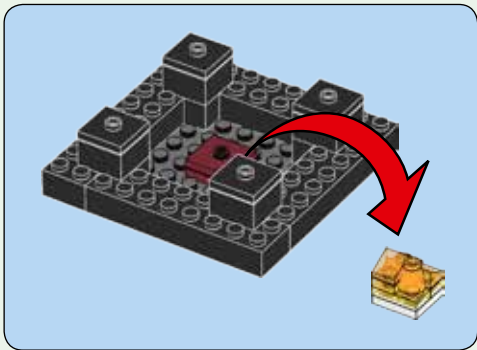

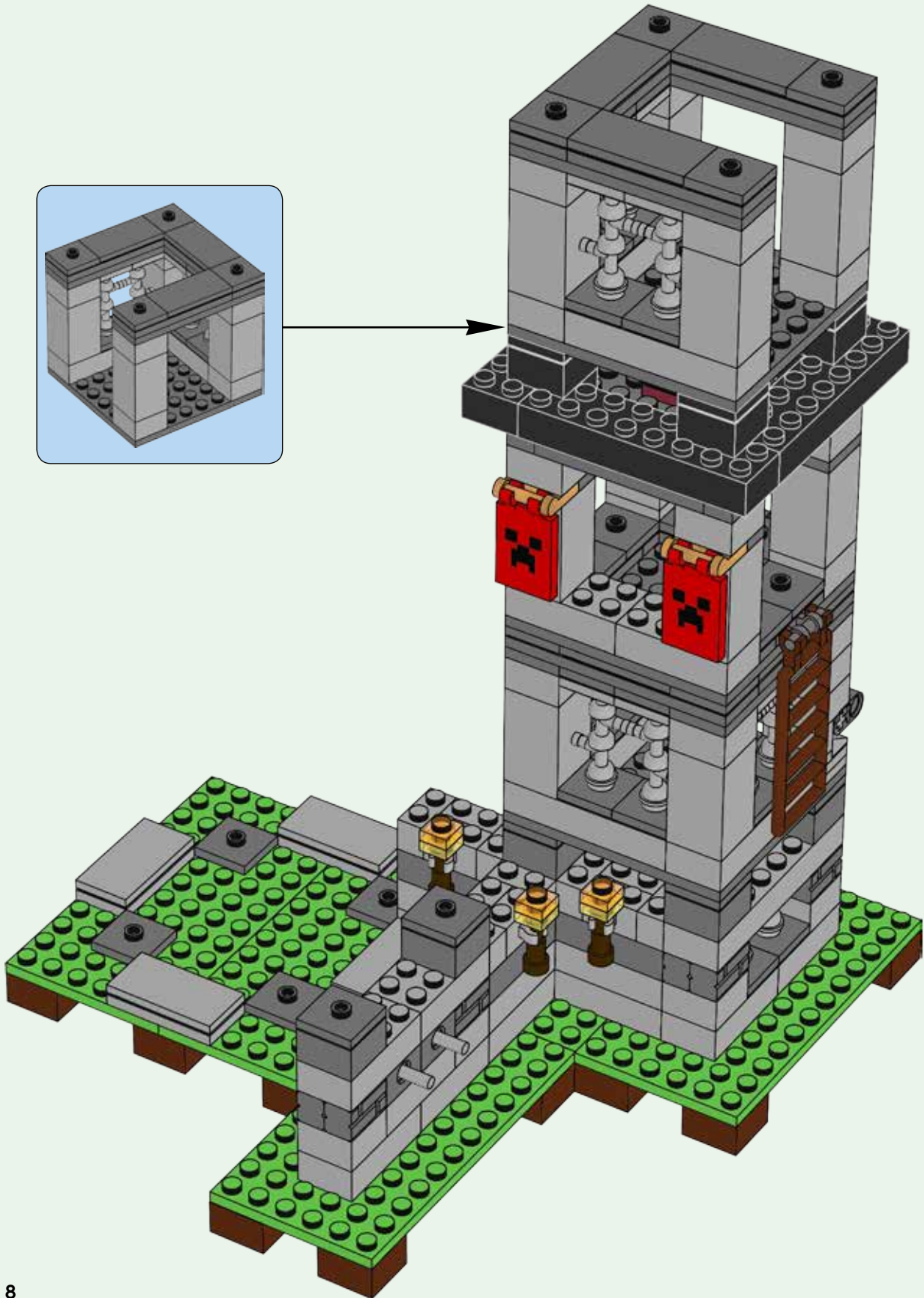



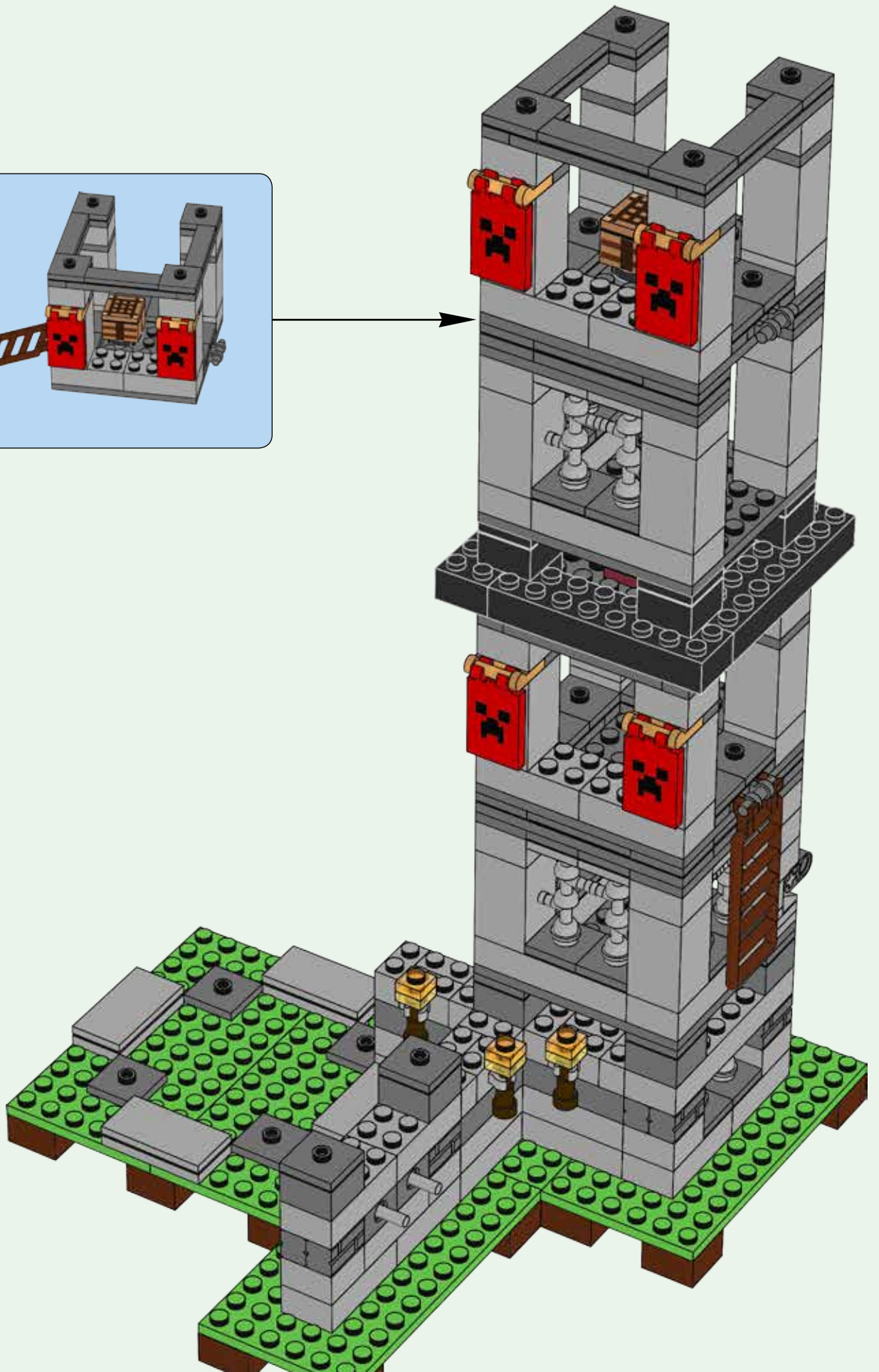
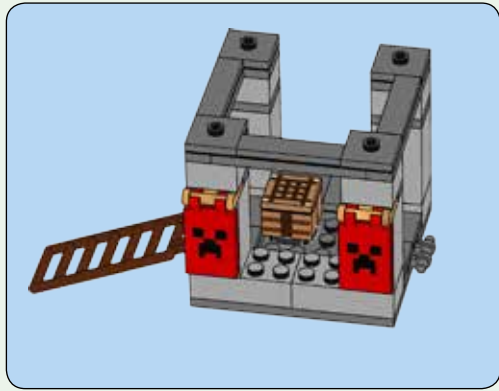

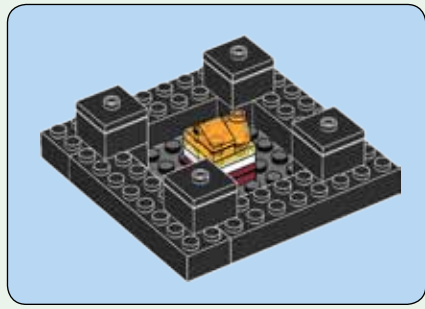

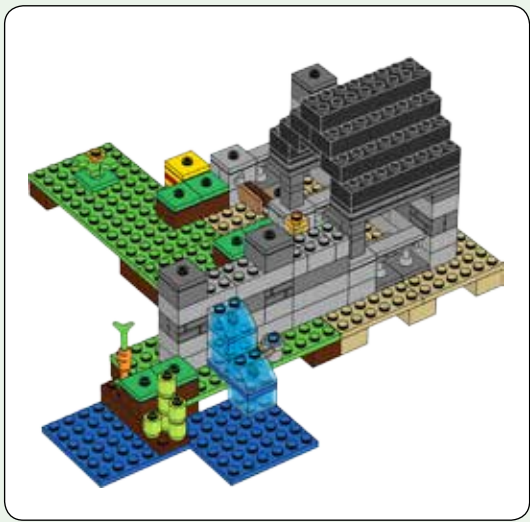

2

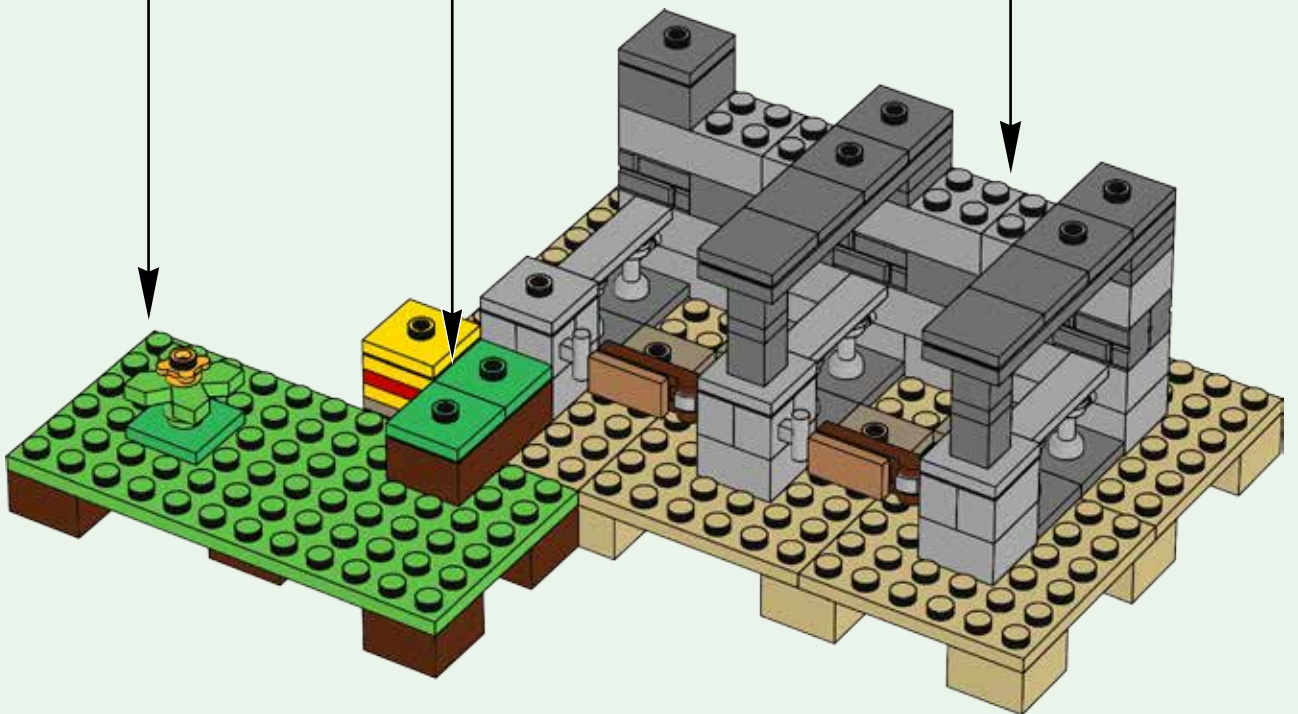
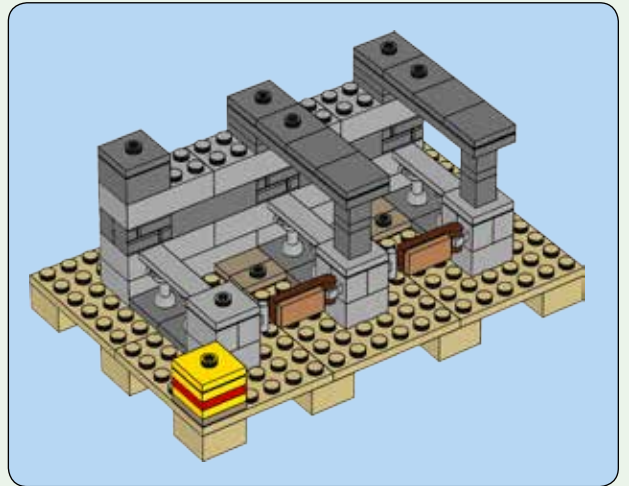

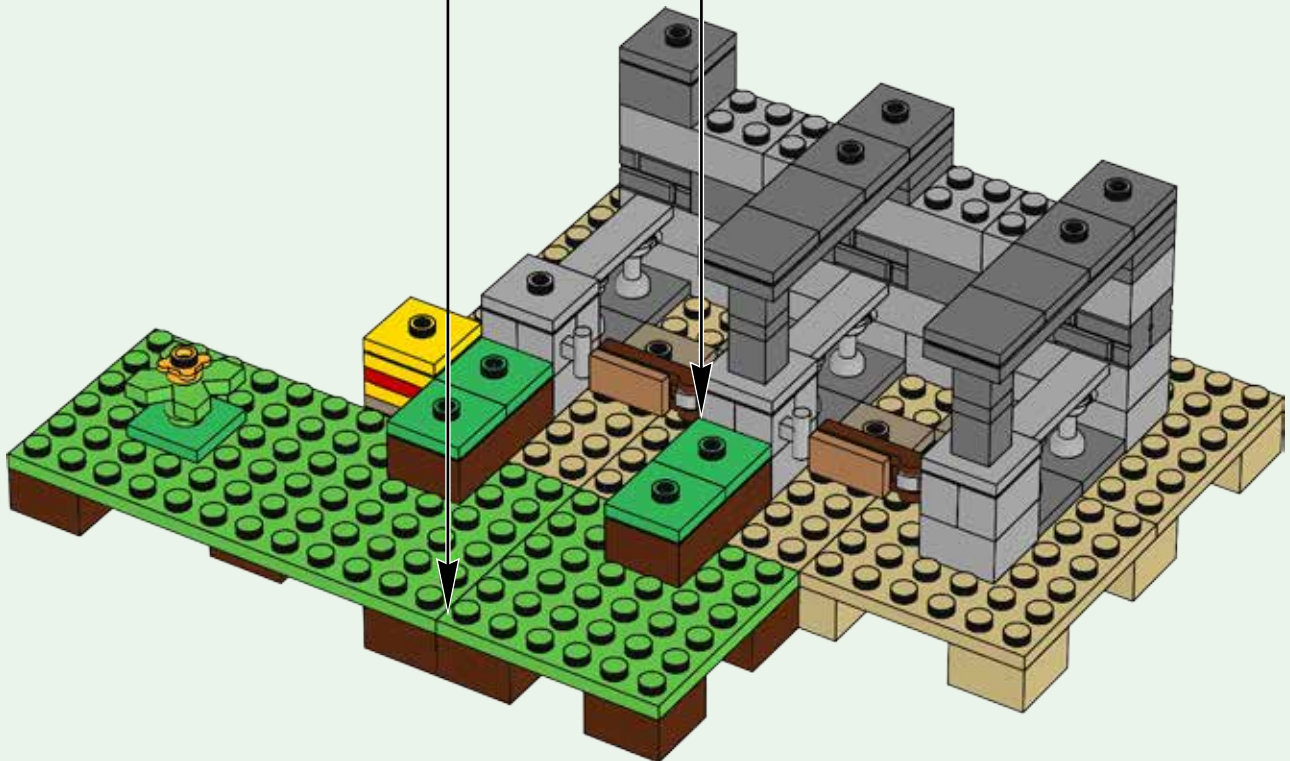
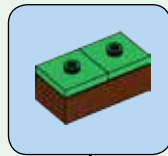
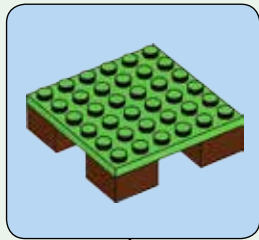

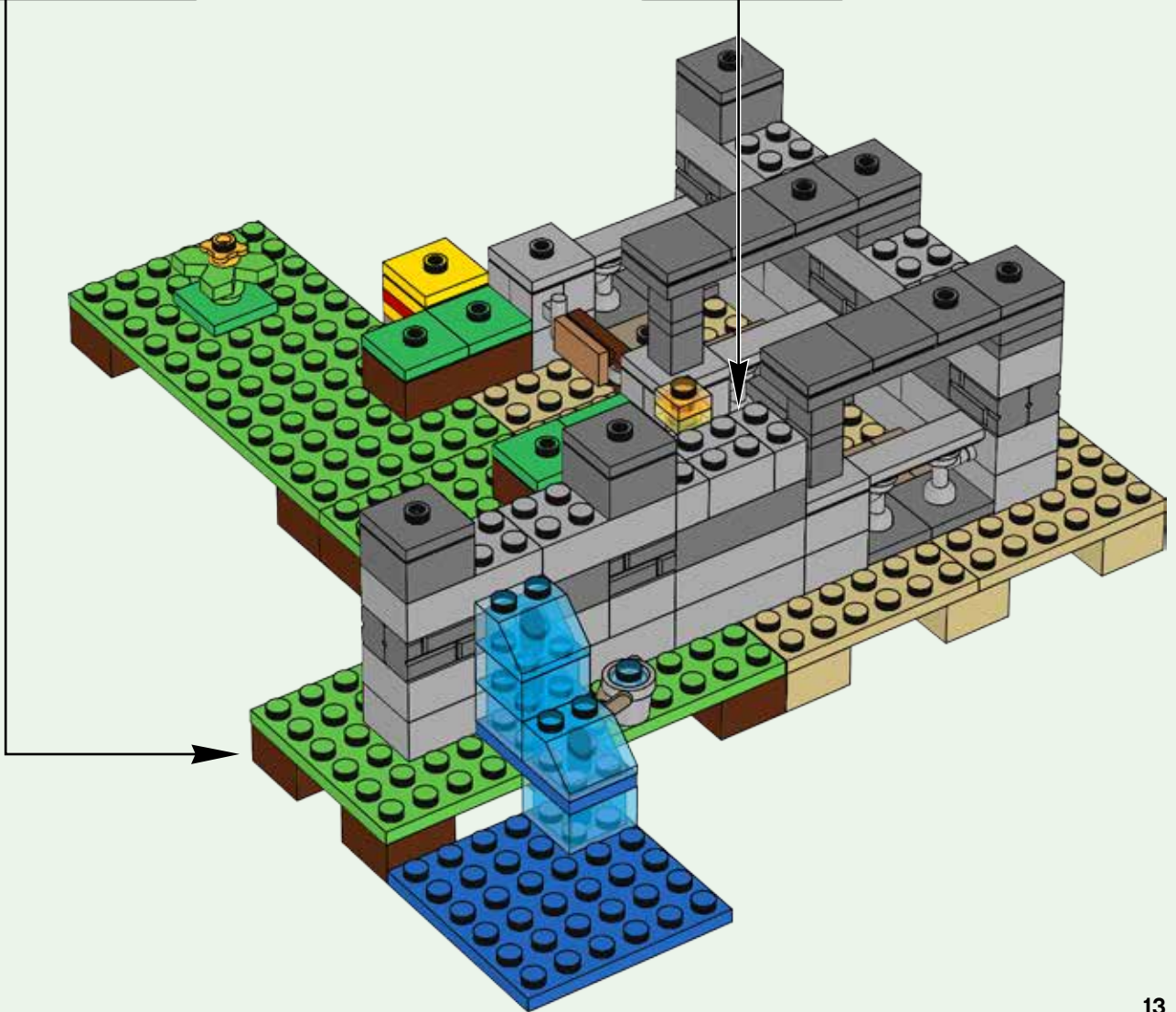
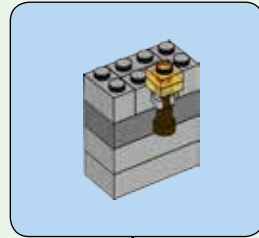
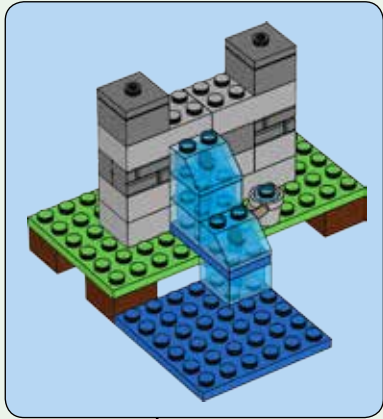

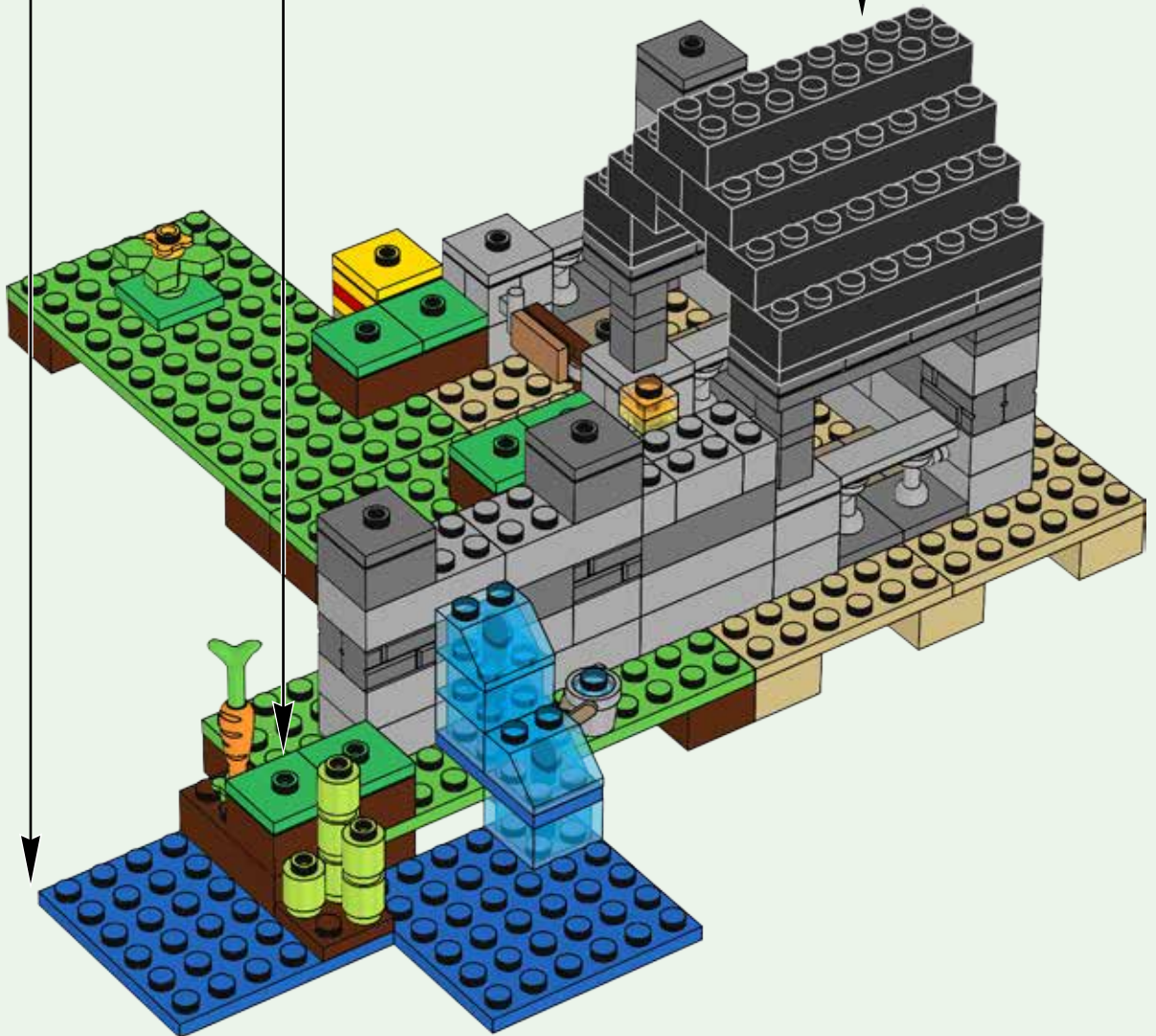
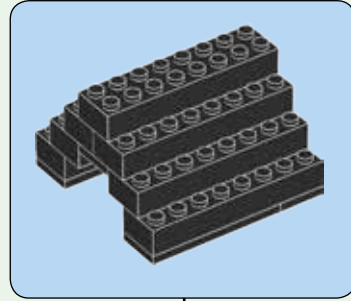
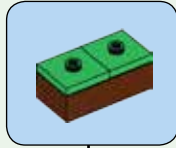



3

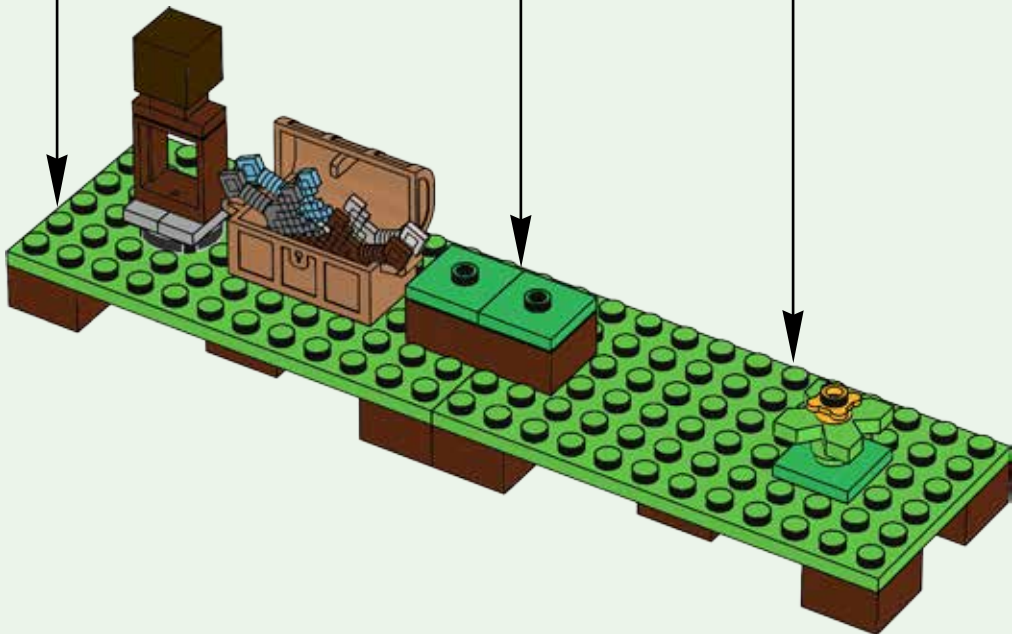
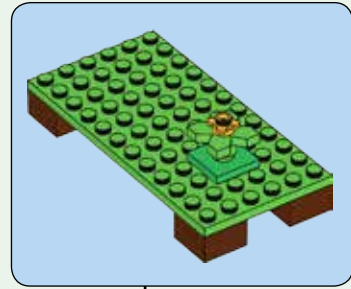

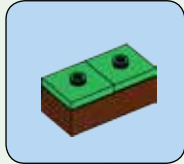
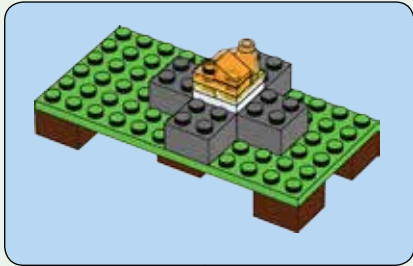



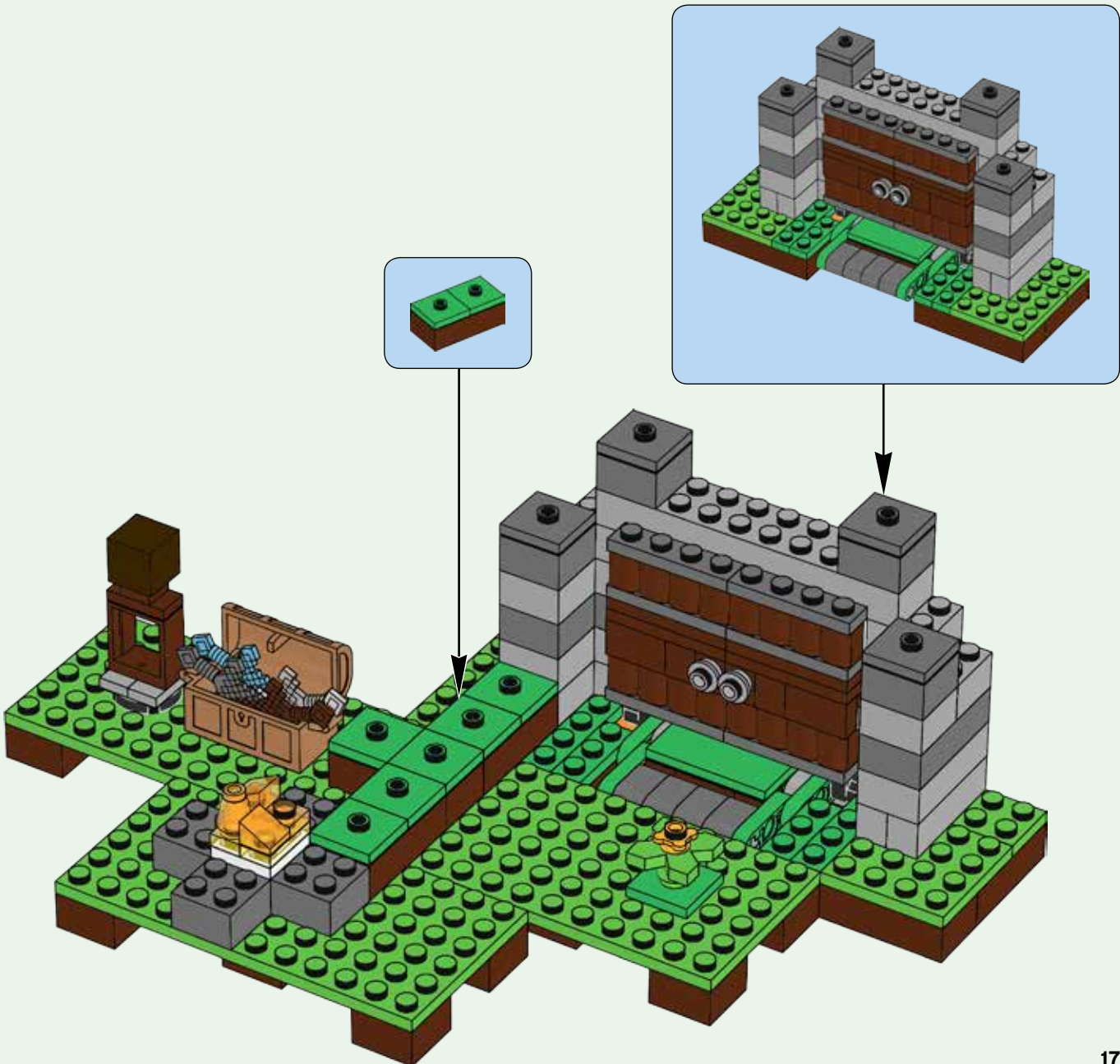



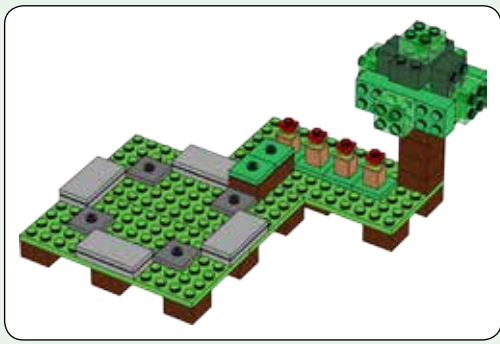

4

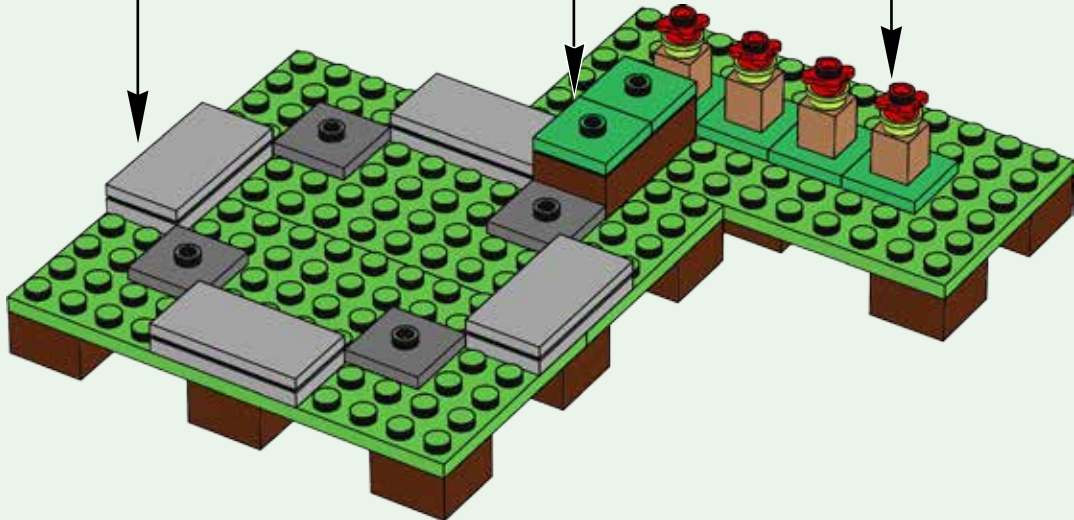
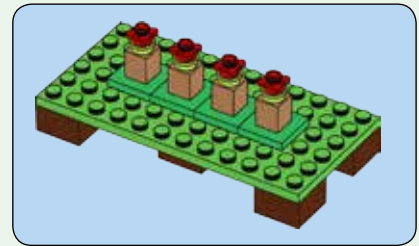
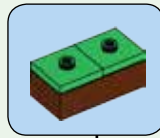
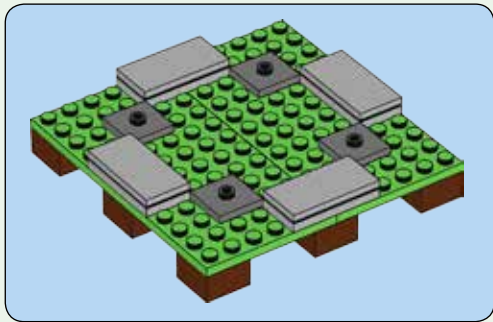

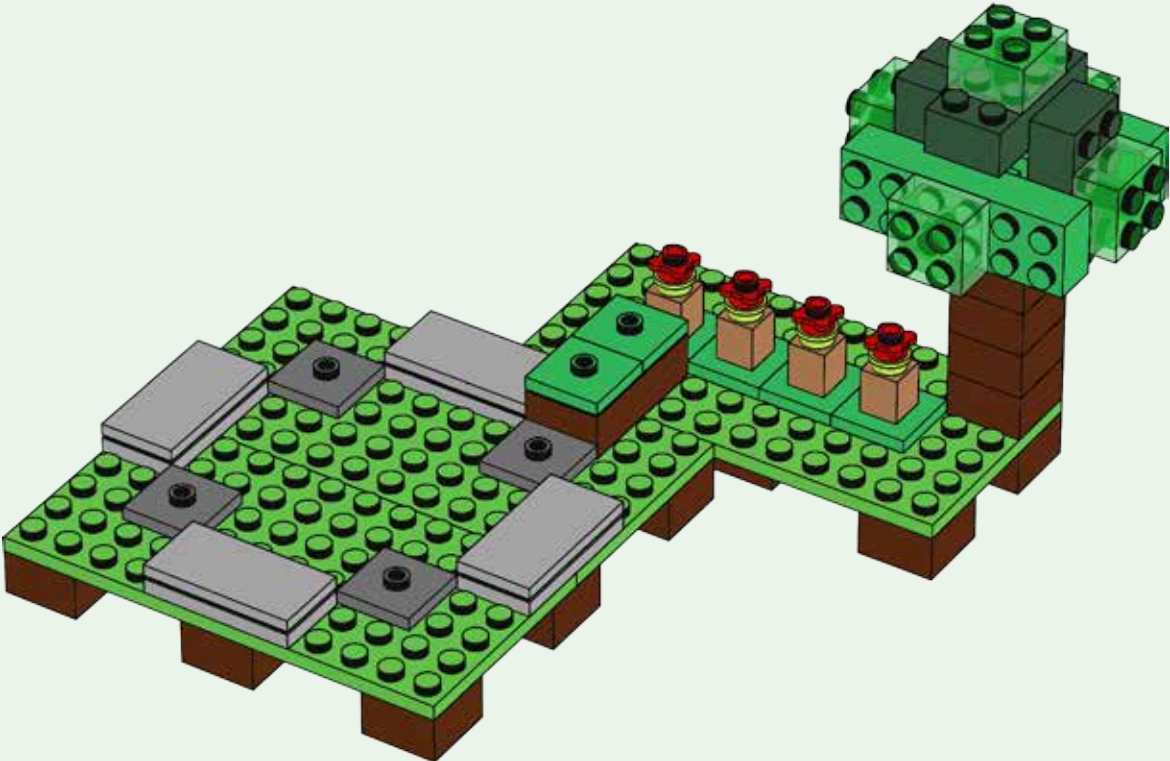
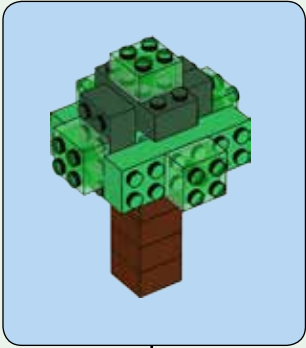

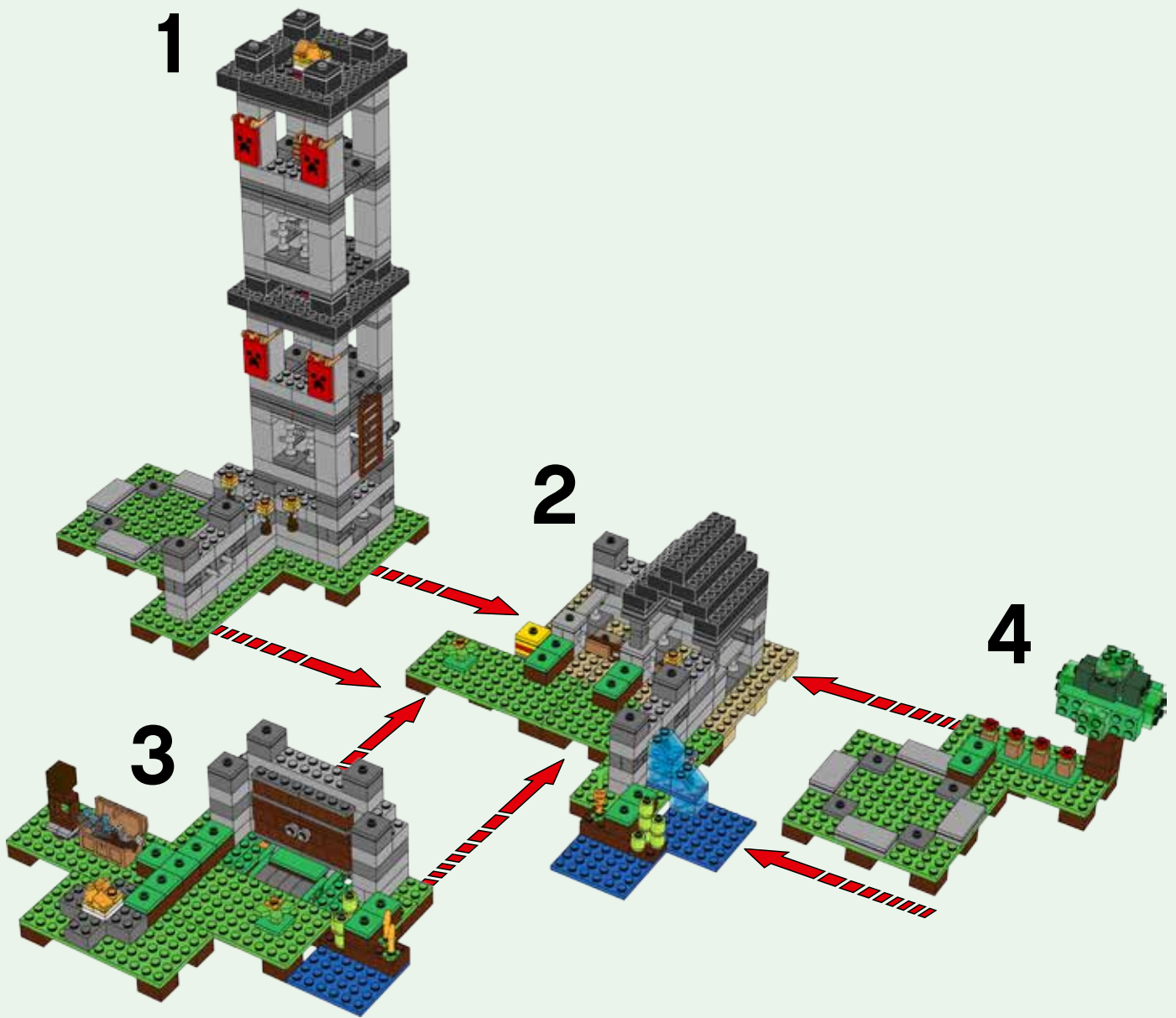

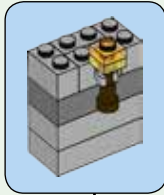
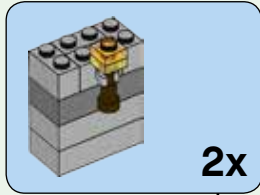

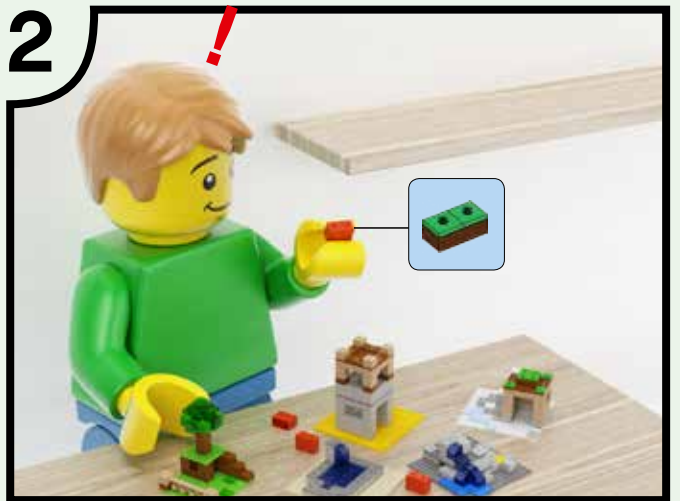
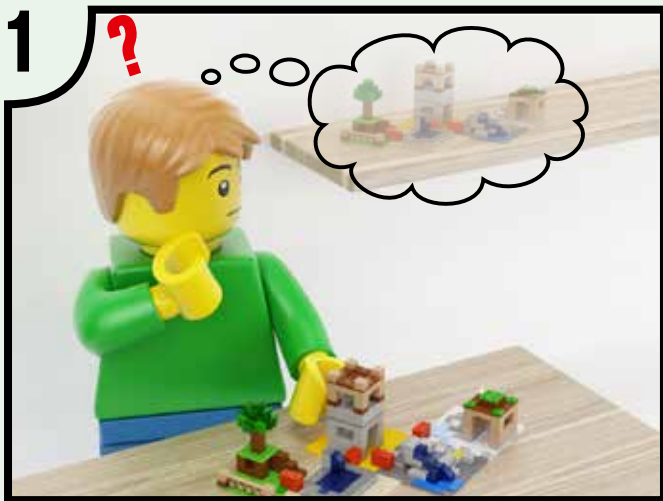

# LEGO **TECHNIC**



42044



42049



42045



42048

LEGO®  
Building  
Instructions



ANDROID APP ON  
Google play

Download on the  
App Store



Apple, the Apple logo, iPad, iPhone and iPod touch are trademarks of Apple Inc.  
Google Play is a trademark of Google Inc.

LEGO and the LEGO logo are trademarks of the LEGO Group.  
©2016 The LEGO Group. © 2016 Mojang AB and Mojang Synergies AB.  
MINECRAFT is a trademark or registered trademark of Mojang Synergies AB.  
6163763

 [LEGO.com/technic](http://LEGO.com/technic)