



MINECRAFT



21137





2x **LR 41** 1.5V

EN

Save this leaflet because it contains important information.

Important information about batteries

Never use different types of batteries together, or a combination of old and new batteries. Always remove the batteries if the product is not to be used for a long time or if the batteries have run down. Never use damaged batteries. Only use batteries of the type recommended, or a corresponding type. Insert the batteries so that the poles are correctly positioned. Rechargeable batteries must be recharged using the correct battery charger under the supervision of an adult. You cannot recharge batteries while they are still in the product, and you must never try to do so. Never attempt to recharge non-rechargeable batteries. Never short-circuit the battery holder.

DE

Wichtige Informationen zu Batterien

Benutzen Sie niemals unterschiedlich Arten von Batterien oder alte und neue gleichzeitig. Nehmen Sie stets die Batterien heraus, wenn mit dem Modell längere Zeit nicht gespielt wird oder wenn die Batterien leer sind. Verwenden Sie niemals beschädigte Batterien. Verwenden Sie ausschließlich empfohlene bzw. geeignete Batterien. Achten Sie beim Einsetzen der Batterien auf die richtige Polung. Wiederaufladbare Batterien sollten mit einem geeigneten Ladegerät aufgeladen werden - unter der Aufsicht eines Erwachsenen. Wiederaufladbare Batterien können und sollten niemals aufgeladen werden, während sie sich im Modell befinden. Versuchen Sie unter keinen Umständen, „normale“ Batterien wieder aufzuladen. Schließen Sie das Batteriefach niemals kurz.

FR

Informations importantes concernant les piles

Ne jamais utiliser un mélange de différents types de piles, ou de piles neuves et de piles anciennes ou déjà utilisées. Toujours retirer les piles si le produit n'est pas utilisé durant une période prolongée ou si les piles sont vides. Ne jamais utiliser de piles endommagées. Utiliser uniquement des piles du type recommandé ou d'un type équivalent. En insérant les piles, respecter scrupuleusement le sens d'orientation des pôles (+/-). Les piles rechargeables doivent être rechargées en utilisant un chargeur de piles adéquat et sous la surveillance d'un adulte. Il est impossible de recharger les piles quand elles sont installées dans le produit. Ne jamais tenter de le faire. Ne jamais essayer de recharger des piles non-rechargeables. Ne jamais court-circuiter le compartiment des piles.

IT

Salvare questo foglio perché contiene importanti informazioni.

Importanti informazioni sulle batterie

Non usare mai contemporaneamente e-mente batterie di tipo diverso o batterie nuove e usate insieme. Rimuovere sempre le batterie qualora il prodotto non venga utilizzato per periodi prolungati, oppure se le batterie sono esauste. Non utilizzare mai batterie danneggiate. Usare esclusivamente batterie del tipo raccomandato o un equivalente. Inserire le batterie avendo cura che la loro polarità sia corretta. Le batterie ricaricabili vanno ricaricate in un caricabatterie di tipo idoneo e con la supervisione di un adulto. Non è possibile e non bisogna mai tentare di ricaricare le batterie mentre queste sono inserite nel prodotto. Non tentare mai di ricaricare batterie non ricaricabili. Non cortocircuitare mai il portabatterie.

NL

Belangrijke informatie over batterijen

Gebruik nooit verschillende soorten of een combinatie van oude en nieuwe batterijen tegelijkertijd. Verwijder de batterijen altijd als je het product lange tijd niet wilt gebruiken of als batterijen leeg zijn. Gebruik nooit beschadigde batterijen. Gebruik uitsluitend batterijen van het aanbevolen type of een overeenkomstig type. Plaats de batterijen met de polen in de juiste richting. Oplaadbare batterijen moeten in een voor dit doel bestemde oplader en onder toezicht van een volwassene opnieuw worden opgeladen. Oplaadbare batterijen kunnen niet worden opgeladen terwijl ze zich nog in het product bevinden en dit mag ook nooit worden geprobeerd. Probeer nooit niet-oplaadbare batterijen opnieuw op te laden. Laat de batterijhouder nooit kortsluiten.

ES

Información importante acerca de las pilas

No use pilas de diferentes tipos ni pilas nuevas y antiguas para alimentar el producto. Extraiga las pilas del producto si este va a permanecer sin uso durante un período prolongado de tiempo o aquellas se han agotado. No use pilas dañadas. Use sólo pilas del tipo recomendado u otro equivalente. Inserte las pilas de modo que los polos queden situados en las posiciones correctas. La carga de pilas recargables debe tener lugar empleando un cargador apropiado y bajo la supervisión de un adulto. Las pilas recargables no se pueden cargar mientras permanecen insertadas en el producto; no intente hacerlo. No trate de cargar pilas no recargables. No cortocircuite el compartimento de las pilas.

DA

Vigtige oplysninger om batterier

Brug aldrig forskellige batterityper sammen eller en kombination af gamle og nye batterier. Fjern altid batterierne, hvis produktet ikke skal bruges i lang tid, eller hvis batterierne er flade. Brug aldrig beskadigede batterier. Brug kun den anbefalede type batterier eller en tilsvarende type. Sæt batterierne i, så polerne vender den rigtige vej. Genopladelige batterier skal oplades i den rigtige batterioplader. Batterierne skal sættes i opladeren under opsyn af en voksen. Batterierne kan ikke oplades, mens de stadig sidder i produktet, og man må aldrig forsøge at gøre det. Forsøg aldrig at oplade ikke-genopladelige batterier. Kortslut aldrig batteriholderen.

IS

Mikilvægar upplýsingar um rafhlöður

Aldrei skal nota mismunandi gerðir rafhláða samtímis, né nýjar og eldri rafhlöður samtímis. Ef ekki á að nota tækið í lengri tíma eða ef rafhlöðurnar eru orðnar tómar skal fjarlægja rafhlöðurnar. Aldrei skal nota rafhlöður sem hafa skemmt. Aðeins skal nota rafhlöður af þeirri gerð sem mælt er með, eða samsvarandi gerð. Setja skal rafhlöðurnar í þannig að +- og -skaut þeirra snúi rétt. Endurhláðanlegar rafhlöður skal endurhláða með réttu hleðslutæki undir eftirliti fullorðinna. Rafhlöður er ekki hægt að endurhláða á meðan þær eru enn í vörurnni og það má aldrei reyna að gera það. Aldrei skal reyna að endurhláða rafhlöður sem ekki eru endurhláðanlegar. Aldrei ætti að valda skammhlápi í rafhlöðuhólfinu.

FI

Tärkeää tietoa paristoista

Älä koskaan käytä erityyppisiä paristoja yhdessä. Älä myöskään käytä samassa laitteessa sekä vanhoja että uusia paristoja. Poista paristot tuotteesta aina, kun se on pitemmän aikaa käyttämättä, tai kun paristot ovat tyhjentyneet. Älä koskaan käytä viallisia paristoja. Käytä vain tuotteesta suositeltuja tai vastaaventyyppisiä paristoja. Aseta paristot siten, että navat osottavat oikeaan suuntaan. Ladattavat paristot on ladattava oikeanlaisella laturilla aikuisen valvonnassa. Ne on poistettava tuotteesta lataamisen ajaksi. Älä koskaan yritä ladata paristoja, joita ei ole tarkoitettu ladattaviksi. Älä koskaan aiheuta oikosulkua pariston kosketintien välillä.

SV

Viktig information om batterier

Använd aldrig olika sorters batterier samtidigt, och inte heller en kombination av gamla och nya batterier. Ta alltid ur batterierna om produkten inte ska användas under en längre tid eller om batterierna är slut. Använd aldrig skadade batterier. Använd bara batterier av den typ som rekommenderas, eller av en motsvarande typ. Sätt i batterierna så att polerna hamnar i rätt läge. Laddningsbara batterier måste laddas med rätt slags batteriladdare och under en vuxens överinseende. Du kan inte ladda batterierna medan de fortfarande sitter i produkten, och du får heller aldrig försöka göra det. Försök aldrig ladda icke laddningsbara batterier. Kortslut aldrig batteriutrymmets kontaktytor.

NO

Viktig informasjon om batterier

Bruk aldri ulike typer batterier sammen og heller aldri gamle og nye batterier sammen. Ta alltid ut batteriene hvis produktet ikke skal brukes på lang tid, eller hvis batteriene er brukt opp. Bruk aldri skadde batterier. Bruk kun anbefalt type batterier eller tilsvarende type. Sett inn batteriene med polene vendt riktig vei. Oppladbare batterier skal lades opp med riktig batterilader, under overoppsyn av en voksen. Det er ikke mulig å lade opp batteriene mens de fremdeles er i produktet, og du må aldri forsøke å gjøre det. Forsøk aldri å lade opp ikke-oppladbare batterier. Kortslett aldri batteriholderen.

PT

Guardar este folheto por conter informações importantes.

Informação importante sobre as pilhas

Nunca use diferentes tipos de pilhas em simultâneo, ou uma combinação de pilhas usadas e novas. Retire sempre as pilhas se o produto não for usado durante muito tempo ou se as pilhas já não tiverem carga. Nunca use pilhas danificadas. Use apenas pilhas do tipo recomendado ou de um tipo correspondente. Insira as pilhas de forma a que os pólos fiquem corretamente posicionados. As pilhas recarregáveis devem ser recarregadas com o carregador de pilhas correto e sob a supervisão de um adulto. Não pode recarregar as pilhas enquanto as mesmas se encontram colocadas no produto e nunca deve tentar fazê-lo. Nunca tente recarregar pilhas não recarregáveis. Nunca deixe o compartimento das pilhas entrar em curto-circuito.

EL

Σημαντικές πληροφορίες για τις μπαταρίες

Μην χρησιμοποιείτε ποτέ διαφορετικούς τύπους μπαταριών μαζί και μην συνδυάζετε παλιές και καινούργιες μπαταρίες. Αφαιρέιτε πάντα τις μπαταρίες αν δεν σκοπεύετε να χρησιμοποιήσετε το προϊόν για αρκετό καιρό ή αν οι μπαταρίες έχουν αδειάσει. Ποτέ μην χρησιμοποιείτε μπαταρίες που έχουν φθορές. Χρησιμοποιείτε μόνο μπαταρίες του συνιστώμενου τύπου ή κάποιου αντίστοιχου τύπου. Τοποθετήστε τις μπαταρίες με τους πόλους στη σωστή θέση. Οι επαναφορτιζόμενες μπαταρίες πρέπει να επαναφορτίζονται χρησιμοποιώντας το σωστό φορτιστή μπαταριών υπό την επίβλεψη ενήλικου. Δεν μπορείτε να επαναφορτίσετε τις μπαταρίες όταν αυτές βρίσκονται μέσα στο προϊόν και δεν πρέπει ποτέ να δοκιμάσετε κάτι τέτοιο. Μην επιχειρήσετε ποτέ να επαναφορτίσετε μη επαναφορτιζόμενες μπαταρίες. Ποτέ μην βραχυκυκλώνετε τη θήκη των μπαταριών.

JA

電池取扱いに関する重要事項

異なるタイプの電池や古い電池を混ぜて使用しないでください。商品を長時間使用しないときや電池が切れたときは、電池を必ず取り外してください。不具合のある電池は絶対に使用しないでください。推奨されているタイプまたは対応しているタイプの電池を必ず使用してください。電極を確認して電池を正しい向きに入れてください。充電式電池は、保護者に見てもらった上で適切な充電器を使って充電してください。電池を商品の中に入れてまま充電することは絶対に避けてください。充電式ではない電池は絶対に充電しないでください。電池ホルダをショートさせないでください。

ZH

该包装含重要信息应保留。

关于电池的重要信息

请勿同时使用不同类型的电池，或把新旧程度不同的电池混合使用。如果产品将有很长时间不会使用，或者电池已经没电，请注意取出电池。切勿使用已破损的电池。务必仅使用推荐类型或兼容类型的电池。装入电池时请注意正负极。如果使用充电电池，务必在成人监护下使用正确的电池充电器进行充电。电池仍在产品中时不可进行充电，请勿强行尝试充电。请勿尝试给非充电电池充电。切勿对电池仓进行短路连接。

KO

배터리 사용 시 주의사항

다른 종류의 배터리를 함께 사용하거나, 새 전지와 오래된 전지를 혼용하지 마세요. 배터리가 방전되었거나 장기간 제품을 작동하지 않을 때에는 반드시 배터리를 분리하세요. 파손된 배터리는 사용하지 마세요. 레고에서 권장하는 유형의 배터리만 사용하세요. 양극과 음극의 위치를 잘 맞춰서 넣으세요. 어른의 감독에 따라 지정된 충전기에 충전지를 충전해야 합니다. 충전지를 제품에 넣은 상태로 충전하면 안 됩니다. 일반 배터리는 충전해서 사용할 수 없습니다. 배터리 홀더의 접촉부에 배터리를 정확히 끼워서 사용하세요.

RU

Необходимая информация об элементах питания

Ни в коем случае не используйте одновременно элементы питания различных типов, а также элементы питания с разным сроком годности. В обязательном порядке внимайтите элементы питания из терминалов в случае, если вы не пользуетесь прибором в течение долгого времени, либо в случае, если в элементах питания закончился заряд. Ни в коем случае не используйте поврежденные элементы питания. Используйте только рекомендуемые элементы питания либо элементы питания соответствующего типа. Установите элементы питания, соблюдая указанную полярность. Аккумуляторные элементы питания должны подзаряжаться в соответствующем зарядном устройстве под наблюдением взрослого. Ни в коем случае не пытайтесь подзаряжать элементы питания, находящиеся в приборе. Ни в коем случае не пытайтесь подзаряжать неперезаряжаемые элементы питания. Ни в коем случае не пытайтесь замкнуть полюса в устройстве для элементов питания.

PL

Ważne informacje dotyczące baterii

Nigdy nie należy stosować razem różnych rodzajów baterii ani stosować równocześnie starych i nowych baterii. Jeżeli produkt nie jest używany przez dłuższy czas lub jeżeli baterie się wyczerpały, należy wyjąć z baterie. Nigdy nie należy stosować uszkodzonych baterii. Należy stosować wyłącznie zalecany rodzaj baterii lub rodzaj mu odpowiadający. Przy wkładaniu baterii należy zwrócić uwagę na właściwe położenie biegunów. Baterie akumulatorowe należy ładować w odpowiedniej ładowarce pod nadzorem osoby dorosłej. Nie można naładować baterii bez wyjęcia ich z produktu i nigdy nie należy tego próbować. Nigdy nie należy próbować ładowania baterii jednorazowych. Nigdy nie należy doprowadzać do zwarcia w gnieździe baterii.

CZ

Důležitá informace o bateriích

Nikdy nepoužívejte najednou různé typy baterií nebo kombinaci starých a nových baterií. Nebude-li se výrobek delší dobu používat nebo jsou-li baterie vybité, vždy je vyjměte z výrobku. Nikdy nepoužívejte poškozené baterie. Používejte pouze doporučené nebo odpovídající typy baterií. Baterie instalujte se správnou orientací pólů. Nabíjitelné baterie musí být nabitý ve vhodné nabíječce pod dohledem dospělé osoby. Nabíjitelné baterie nelze nabíjet, jsou-li umístěny ve výrobku, a nesmíte se o to ani pokoušet. Nikdy se nesnažte nabíjet baterie, které nejsou nabíjitelné. Nikdy neskratujte kontakty v prostoru pro baterie.

SK

Dôležitá informácia o batériách

Nikdy nepoužívajte naraz odlišné typy batérií ani nekombinujte staré batérie s novými. Batérie vždy vyberte, ak sa výrobok nebude dlhšie používať, alebo ak sa batérie vybili. Nikdy nepoužívajte poškodené batérie. Používajte jen odporúčané alebo zodpovedajúce typy batérií. Batérie vkladajte so správnou orientáciou pólov. Nabíjateľné batérie sa musia nabíjať vo vhodnej nabíjačke pod dozorom dospelej osoby. Nabíjateľné batérie sa nesmú nabíjať, ak sú umiestnené vo výrobku, a nesmiete sa o to ani pokúšať. Nikdy sa nesnažte nabíjať batérie, ktoré nie sú nabíjateľné. Nikdy neskratujte kontakty v priestore pre batérie.

HU

Fontos tudnivalók az elemekről

Soha ne használjon különböző típusú elemeket, illetve ne használjon vegyesen új és használt elemeket. Mindig távolítsa el az elemeket, ha a készüléket előre láthatóan hosszabb ideig nem fogják használni, vagy ha az elemek lemerültek. Soha ne használjon megrongálódott elemeket. Csak az ajánlott típusú, vagy annak megfelelő elemet használjon. Az elemeket helyesen helyezze be, a polaritásuknak megfelelően. Az akkumulátorokat csak a megfelelő akkumulátor- töltővel szabad feltölteni, felnőtt felügyelete mellett. Az akkumulá- torokat nem lehet feltölteni, ha azok a készülékben vannak. Ezt meg sem szabad próbálni. Soha ne próbálja meg feltölteni a nem tölthető elemeket. Soha ne hozzon létre rövidzárlatot az elemtartó kivezetéssein.

UA

Необхідна інформація про батареїки

Ніколи не використовуйте одночасно батареїки різних типів або батареїки з різним терміном придатності. Обов'язково вилучайте батареїки з приладу, якщо довго не користуєтесь ним, або якщо в батареїках вже скінчився заряд. Ніколи не використовуйте пошкоджені батареїки. Використовуйте батареїки лише рекомендованого або відповідного типу. Вставляйте батареїки, враховуючи задану полярність. Акумуляторні батареїки повинні заряджатись у відповідному зарядному приладі під наглядом дорослого. В будь-якому випадку не намагайтесь підзарядити батареїки, що знаходяться в приладі. В будь-якому випадку не намагайтесь підзарядити батареїки, що не підлягають підзарядці. В будь-якому випадку не намагайтесь зробити коротке замикання в приладі для батареїк.

HR

Važne obavijesti o bateriji

Nikada nemoj koristiti različite vrste baterija zajedno, isto tako ni kombinaciju starih i novih baterija. Uvijek izvadi baterije ako dugo nećeš koristiti proizvod ili ako su one potrošene. Nikada nemoj koristiti oštećene baterije. Koristi samo preporučenu vrstu ili odgovarajuću vrstu baterija. Umetni baterije pažeci da dobro okreneš polove. Akumulatorske se baterije moraju puniti uz pomoć propisanog punjača i uz nadzor odrasle osobe. Baterije se ne smiju puniti dok su još u proizvodu i to nikada nemoj pokušavati. Nikada ne pokušavaj puniti baterije koje nisu predviđene za punjenje. Nikada ne izlazivaj kratki spoj u držaču baterija.

SR

Важне информације о батеријама

Никада не користите различите типове батерија заједно нити комбинацију старих и нових батерија. Увек извадите батерије уколико производ нећете дуже време користити или уколико су батерије празне. Никада не користите оштећене батерије. Употребљавајте само препоручени тип батерија или одговарајућу замену. Ставите батерије тако да су у полови правилно позиционисани. Батерије на пуњење се морају пунити одговарајућим пуњачем под надзором одраслог лица. Није могуће пунити батерије док су у производу и никад не покушавајте да радите то. Никада не покушавајте да пуните батерије које не могу да се пуне. Никада не изазивајте кратак spoj у кулишту за батерије.

MK

Важни информации за батериите

Никогаш не користете различни типови батерији заедно или комбинација од стари и нови батерији. Секогаш отстранувајте ги батериите доколку не го користите производ до подолог време или доколку се потрошиле. Никогаш не користете оштетени батерији. Користете ги само препорачаните батерији или батерији од соодветен тип. Вметнете ги батериите така што точно ќе ги наместите половите. Батериите на полнење мора да се полнат со соодветниот полнач под надзор на возрасно лице. Не може да ги полните батериите додека сè уште се наоѓаат во производ и никогаш не смеете да го правите тоа. Никогаш не обидувајте се да ги полните батериите за еднократна употреба. Никогаш не предизвикувајте краток spoj на држачот за батерији.

SL

Pomembne informacije o baterijah

Nikoli ne uporabljajte skupaj različnih baterij ali kombinacije starih in novih baterij. Vedno odstranite baterije, če izdelka dlje časa ne boste uporabljali ali če so iztrošene. Nikoli ne uporabljajte poškodovanih baterij. Uporabljajte le baterije priporočeneга ali ustreznega tipa. Baterije vstavite tako, da so njihovi poli pravilno obrnjeni. Akumulatorske baterije je treba polniti s pravim polnilnikom pod nadzorom odrasle osebe. Akumulatorskih baterij ni mogoče polniti, dokler so še v izdelku. Tega tudi ne smete poskušati. Nikoli ne poskušajte polniti baterij, ki niso akumulatorske. Pazite, da ležišč za baterije ne boste spravili v kratek stik.

RO

Informații importante despre baterii

Nu folosiți niciodată împreună tipuri diferite de baterii, sau o combinație de baterii vechi și noi. Îndepărtați întotdeauna bateriile dacă produsul nu este folosit timp îndelungat sau dacă bateriile s-au epuizat. Nu folosiți niciodată baterii deteriorate. Folosiți numai baterii de tipul recomandat, sau un tip corespunzător. Introduceți bateriile astfel ca poliți să fie poziționați corect. Bateriile reincărcabile trebuie reincărcate utilizând încărcătorul corect sub supravegherea unui adult. Nu puteți reincărca bateriile în timp ce acestea sunt încă în produs, și niciodată nu trebuie să încercați să faceți acest lucru. Nu încercați niciodată să reincărcați baterii nereîncărcabile. Nu scurtcircuiți niciodată suportul bateriei.

BG

Важна информация за батериите

Никога не използвайте едновременно различни типове батерии или комбинация от стари и нови батерии. Винаги изваждайте батериите, ако izdelieto няма да се използва продължително време или ако батериите са се изтозили. Никога не използвайте повредени батерии. Използвайте само батерии от препоръчвания тип или съответстващ на него тип. Поставете батериите така, че полюсите да са разположени правилно. Аккумуляторните батерии трябва да се зареждат с подходящо зареждащо устройство под надзора на възрастни. Батериите не могат да се зареждат, докато са поставени в izdelieto, затова никога не опитвайте да правите това. Никога не опитвайте да зареждате батерии, които не са аккумулятори. Никога не свързвайте на късо контактите на отделението за батериите.

LV

Svarīga informācija par baterijām

Nekad vienlaikus nelietojiet dažādu tipu, kā arī vecas un jaunas baterijas. Vienmēr izņemiet baterijas, ja tās ir izlādējušas vai ja produkts ilgāku laiku netiek lietots. Nekad nelietojiet bojātas baterijas. Lietojiet tikai ieteiktām tipa vai atbilstoša tipa baterijas. Ievietojot baterijas, ievērojiet pareizo polaritāti. Uzlādējamu bateriju lādēšanai izmantojiet atbilstošu bateriju lādētāju; uzlāde jāveic pieaugušo uzraudzībā. Baterijas nevar uzlādēt nekad nedrīkst mēģināt uzlādēt, kamēr tās ievietotas produktā. Nekad nemēģiniet uzlādēt baterijas, kas nav uzlādējamas. Nepieļaujiet issavienojumu bateriju nodalījumā.

ET

Oluline teave patareide kohta

Ära kunagi kasuta koos erinevat tüüpi patareisid, samuti vanu ja uusi patareisid. Kui märguasja ei kasutata pika aja jooksul, võta patarei sellest välja. Ära kunagi kasuta kahjustatud patareisid. Kasuta ainult ettenähtud tüüpi või nendega samaväärsed patareisid. Pane patareid märguasja sisse nii, et pluss- ja miinusklemmi asend oleks õige. Akusid tuleb laadida ainult neile ettenähtud akulaadijaga abil täiskasvanu järelevalve all. Akusid ei saa laadida sel ajal, kui need on märguasja sees. Ära kunagi püua ni teha. Ära kunagi proovi akulaadijaga laadida tavalisi patareisid. Patareipesa klemmide vahel ei tohi tekkida lühist.

LT

Svarbi informacija apie elementus

Vienu metu nenaudokite skirtingų elementų, taip pat su naujais elementais nenaudokite senų. Jei nenaudosite gaminio ilgesnį laiką arba jei elementai išsekę, visuomet išimkite juos iš gaminio. Niekada nenaudokite pažeistų elementų. Naudokite tik rekomenduojamo arba atitinkamo tipo elementus. Elementus galima įkrauti tik tinkamu krovikliu ir prižiūrint suaugusiesiems. Jokių būdu negalima, ir niekuomet nebandykite, įkrauti elementų neišėjus jų iš gaminio. Niekada nebandykite įkrauti vienkartinių elementų. Saugokitės, kad elementų įdėjkle nesukeltumėte trumpojo jungimo.

TR

Piller hakkında önemli bilgiler

Hiçbir zaman farklı tipte pilleri ya da eski pillerle yeni pilleri bir arada kullanmayın. Ürün uzun süre kullanılmayacaksa ya da piller bitmişse, pilleri ürünün içinden çıkarın. Hiçbir zaman zedelemmiş piller kullanmayın. Sadece önerilen tipte piller ya da bunların dengi olan piller kullanın. Pilleri kutularını doğru konumda olacak şekilde yerleştirin. Şarj edilebilen pilleri doğru pil şarj aletini kullanarak, bir yetişkinin denetiminde şarj edin. Şarj edilebilen pilleri, pil ürünün içindeyken şarj edemezsiniz bunu hiçbir zaman yapmaya çalışmayın. Hiçbir zaman, şarj edilebilir olmayan pilleri şarj etmeye çalışmayın. Hiçbir zaman pil kutusuna kısa devre yaptırmayın.

AR

معلومات مهمة عن البطاريات

يُحظَر استخدام أنواع مختلفة من

البطاريات معًا أو مزيج من البطاريات

القديمة والجديدة. احرص دائمًا على

نزع البطاريات في حال عدم استخدام

المنتج لفترة طويلة أو إذا نفدت طاقة

البطاريات. تجنب استخدام البطاريات

التالفة. لا تستخدم إلا نوع البطاريات

الموصى به أو نوع متماثل. قم بتربكيب

البطاريات بحيث تكون الأقطاب في

موضعها الصحيح. يجب إعادة شحن

البطاريات القابلة لإعادة الشحن

باستخدام شاحن البطاريات المناسب

وذلك تحت إشراف شخص بالغ. لا يمكنك

إعادة شحن البطاريات وهي لا تزال داخل

المنتج. ويجب ألا تجرب فعل ذلك. يُحظَر

إعادة شحن البطاريات غير القابلة لإعادة

الشحن. تجنب إحداث دائرة قصر في حامل

البطارية.

ID

Informasi penting tentang baterai

Jangan gunakan baterai yang jenisnya berlainan, atau mencampur baterai lama dan baterai baru. Lepas baterai jika produk tidak akan digunakan untuk waktu lama atau jika baterai sudah lemah. Jangan gunakan baterai yang rusak. Gunakan jenis baterai yang dianjurkan atau yang sejenis. Masukkan baterai dengan posisi kutub yang tepat. Baterai isi ulang harus diisi ulang dengan charger baterai yang sesuai dan di bawah pengawasan orang dewasa. Anda tidak dapat mengisi ulang baterai saat masih terpasang di dalam produk, dan jangan pernah coba melakukannya. Jangan pernah coba mengisi ulang baterai biasa. Jangan pernah membuat arus pendek pada dudukan baterai.

MS

Maklumat penting tentang bateri

Jangan guna jenis bateri yang berbeza bersama-sama, atau gabungan bateri baharu dan lama. Tanggalkan bateri jika produk tidak akan digunakan untuk tempoh masa yang lama atau jika bateri telah kehabisan kuasa. Jangan guna bateri yang rosak. Hanya guna jenis bateri yang disyorkan, atau jenis yang berkaitan. Selitkan bateri supaya supaya paksi berada pada kedudukan yang betul. Bateri yang boleh dicaskan semula perlu dicas semula menggunakan pengcas bateri yang betul bawah pengawasan orang dewasa. Anda tidak boleh mengcas bateri semasa bateri masih berada pada produk, dan anda jangan cuba berbuat demikian. Jangan cuba untuk mengcas semula bateri yang tidak boleh dicaskan semula. Jangan pintas litar pemegang bateri.



EN	Protect the environment by not disposing of this product with your household waste (2012/19/EU). Check with your local authority for recycling advice and facilities.
DE	Schützen Sie die Umwelt und entsorgen Sie dieses Produkt nicht mit Ihrem Hausmüll (2012/19/EU). Informationen zu Recycling-Möglichkeiten erhalten Sie bei den örtlichen Behörden.
FR	Protégez l'environnement : ne jetez pas ce produit avec vos autres déchets ménagers (Directive européenne 2012/19/UE). Contactez les autorités locales pour obtenir des informations sur le recyclage et connaître les points de collecte.
IT	Proteggi l'ambiente! Non smaltire questo prodotto con i rifiuti domestici (2012/19/UE). Per consulenza sul riciclaggio dei rifiuti e le strutture di riciclaggio, rivolgersi alle proprie autorità locali.
NL	Bescherm het milieu: gooi dit product niet samen met het andere huisvuil weg (2012/19/EU). Raadpleeg de plaatselijke instanties voor locaties van milieustations en advies over hergebruik.
ES	Proteja el medio ambiente no deshaciéndose de este producto junto con sus residuos domésticos (2012/19/UE). Solicite a su autoridad local consejos e información sobre instalaciones de reciclado.
DA	Beskyt miljøet! Smid ikke dette produkt ud sammen med husholdningsaffaldet (2012/19/EU). Få vejledning om genbrug og genbrugsstationer hos din kommune.
IS	Stuðlið að verndun umhverfis með því að farga þessari vöru ekki með heimilissorpi (2012/19/ESB). Leiðið upplýsinga um endurvinnslu- og förgunarstaði hjá staðaryfirvöldum.
FI	Tämä tuote on hävitettävä ympäristönsuojelun vuoksi asianmukaisesti talousjätteistä erillään (2012/19/EU). Tietoja keräyspisteiden sijainnista saa kunnan tai kaupungin teknisestä virastosta.
SV	Skydda miljön genom att inte kasta denna produkt bland ditt hushållsavfall (2012/19/EU). Kontakta din kommun för frågor om återvinning och miljöstationer.
NO	Beskytt miljøet. Ikke kast dette produktet i husholdningsavfallet (2012/19/EU). Kontakt kommunen for veiledning om gjenbruk og miljøstasjoner.
PT	Proteja o ambiente não eliminando este produto com o seu lixo doméstico (2012/19/UE). Consulte as autoridades locais para informação sobre reciclagem e sistemas de recolha.
EL	Προστατέψτε το περιβάλλον. Μην πετάτε αυτό το προϊόν μαζί με τα συνηθισμένα οικιακά απορρίμματα (2012/19/ΕΕ). Επικοινωνήστε με τις τοπικές αρχές σχετικά με συμβουλές και εγκαταστάσεις ανακύκλωσης.
JA	環境保護のため、本製品は家庭ごみとは別に処分してください(2012/19/EU)。リサイクルに関する指示や施設については、お住まいの地方自治体にお問い合わせください。
ZH	注意保护环境，请勿将本产品与家庭垃圾一起丢弃处理(2012/19/EU)。请咨询您当地相关部门，了解回收设施与回收建议
KO	환경 보호를 위해 이 제품을 생활폐기물과 함께 버리지 마십시오(2012/19/EU)。재활용 방법 및 시설에 관한 사항은 현지 관계 당국에 문의하십시오。
RU	Защитите окружающую среду, не утилизируйте этот продукт вместе с бытовым мусором (директива 2012/19/EU)。Осведомитесь о местных органах власти о правилах вторичной переработки и утилизации таких отходов。
PL	Chroń środowisko — nie wyrzucaj tego produktu razem z odpadami z gospodarstwa domowego (2012/19/EU)。W celu uzyskania informacji dotyczących recyklingu i miejsc składowania zużytego sprzętu należy się skontaktować z lokalnymi władzami。
CZ	Nevyhazujte tento produkt do domácího odpadu, chráňte životní prostředí (2012/19/EU)。Zjistěte si prosím u místních úřadů možnosti recyklace a dostupná zařízení。
SK	Nevyhádzajte tento produkt do domáceho odpadu, chráňte životné prostredie (2012/19/EU)。Zistite si prosím na miestnych úradoch možnosti recyklácie a dostupné zariadenia。
HU	Környezetét óvja, ha ettől a terméktől nem a háztartási hulladékkal együtt válik meg (2012/19/EU)。Érdeklődjék a lakóhelyéhez közel eső hatóságnál az újrahazsnosítás módjáról és lehetőségeiről。
UA	Допоможіть захистити довкілля: не утилізуйте цей виріб разом із побутовим сміттям (2012/19/EU)。Вказівки з утилізації та відомості про пункти прийому з'ясуєте в місцевих компетентних органах。
HR	Zaštítite okoliš tako da ovaj proizvod ne odložite u otpad zajedno s kućanskim otpadom (2012/19/EU)。Od lokalnih vlasti zatražite savjet ili informacije o pogonima za recikliranje。
SR	Zaštítite životnu sredinu tako što nećete odlagati ovaj proizvod sa kućnim otpadom (2012/19/EU)。Обратите се локалној овлашћеној служби да бисте добили савете о рециклирању и сазнали о објектима за рециклажу。
MK	Zaštítite ja oколната така што нема да се ослободите од производот со домашниот отпад (2012/19/EU)。Консултирајте се со локалните власти за да дознаете за советите и објектите за рециклирање。
SL	Zaščítite okolje! Okolje varujte tako, da tega izdelka ne zavržete skupaj z gospodinjiskimi odpadki (2012/19/EU)。Pri krajevni upravi preverite, kakšne možnosti in kateri obrati za recikliranje obstajajo v vaši okolici。
RO	Protejați mediul înconjurător și nu vă debarasați de acest produs împreună cu deșeurile menajere (2012/19/UE)。Consultați autoritățile locale pentru îndrumări și facilități de reciclare。
BG	Zaštítite oколната среда и не изхвърляйте този продукт заедно с битовите си отпадъци (2012/19/EC)。Свържете се с местните власти относно съвети и съоръжения за рециклиране。
LV	Lai saudzētu vidi, neizmetiet šio produkto su butinēmis atliekomiem (2012/19/ES)。Vērsieties vietējās varas iestādēs, lai noskaidrotu, kur un kā tas nododams pārstrādei。
ET	Keskonda saate kaitsta nii, et ei kõrvalda seda toodet koos olmejäätmetega (2012/19/EL)。Nõuandeid toote taaskasutusse võtmise ja ümbertöötlemispunktide kohta saate asjaomaselt kohalikult asutuselt。
LT	Saugokite aplinką: neišmeskite šio produkto su buitinėmis atliekomis (2012/19/ES)。Patarimų, kaip ir kur rūšiuoti šiukšles, teiraukitės vietos valdžios įstaigose。
TR	Bu ürünü, evsel atıklarla birlikte atmayarak çevreyi koruyun (2012/19/EU)。Geri dönüşüm tavsiyeleri ve tesisler hakkında bilgi için yerel yönetimle iletişime kurun。
AR	استشر السلطة المحلية للحصول على ساهم في حماية البيئة عن طريق عدم التخلص من هذا المنتج مع الخلفات المنزلية استشر السلطة المحلية للحصول على (2012/19/EU)
ID	Jagalah lingkungan dengan tidak membuang produk ini bersama sampah rumah tangga Anda (2012/19/EU)。Periksa peraturan pemerintah setempat tentang saran dan fasilitas daur ulang。
MS	Lindungi persekitaran dengan tidak melupuskan produk ini bersama dengan sisa isi rumah anda (2012/19/EU)。Rujuk pihak berkuasa tempatan anda bagi nasihat dan kemudahan kitar semula。



MINECRAFT

WWW.MINECRAFT.NET

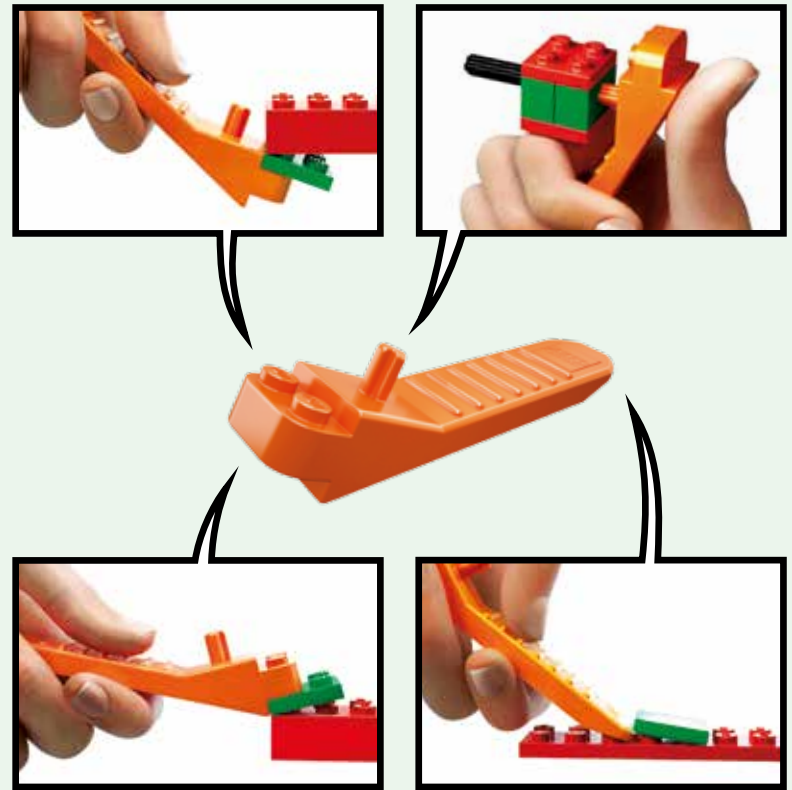
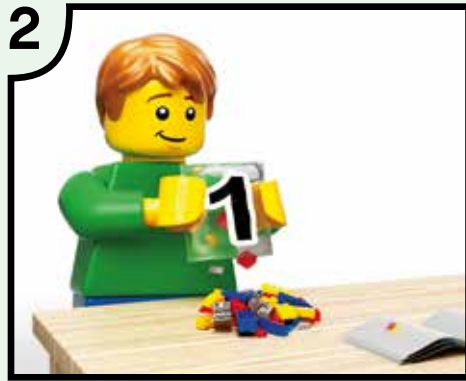

LEGO.com/brickseparator

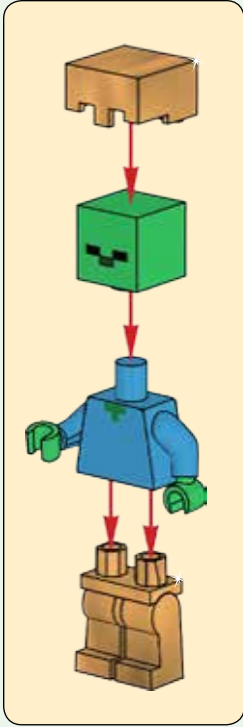
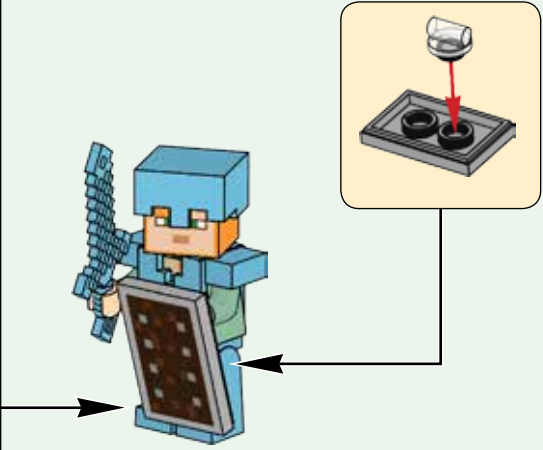
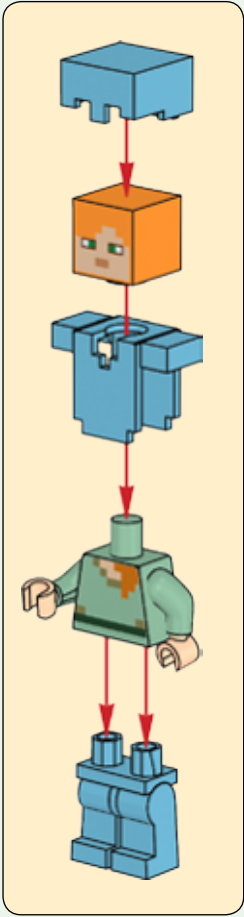
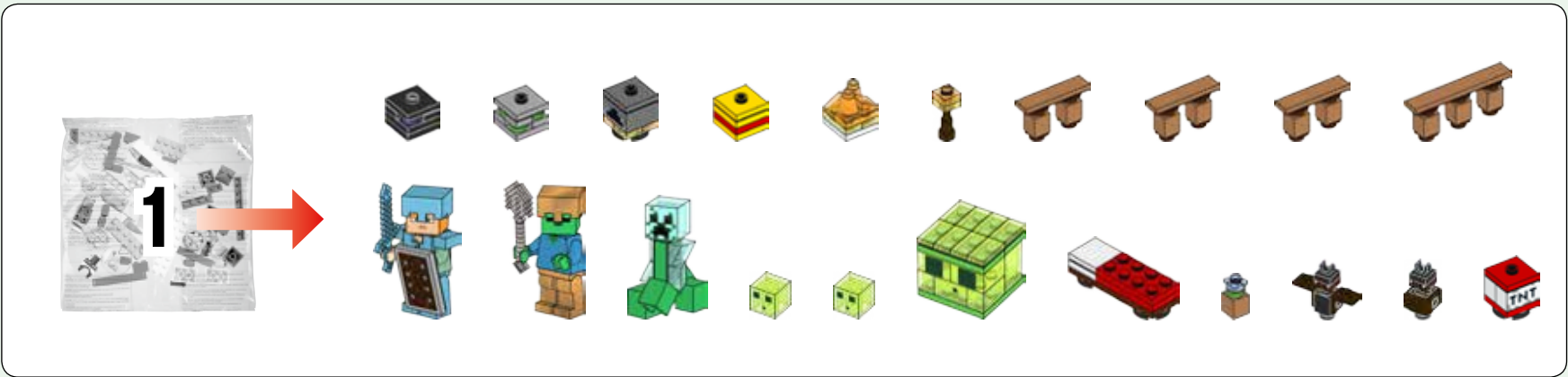

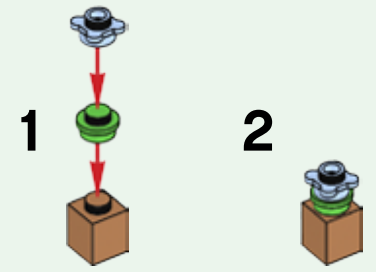
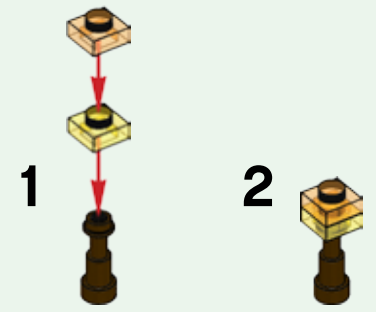
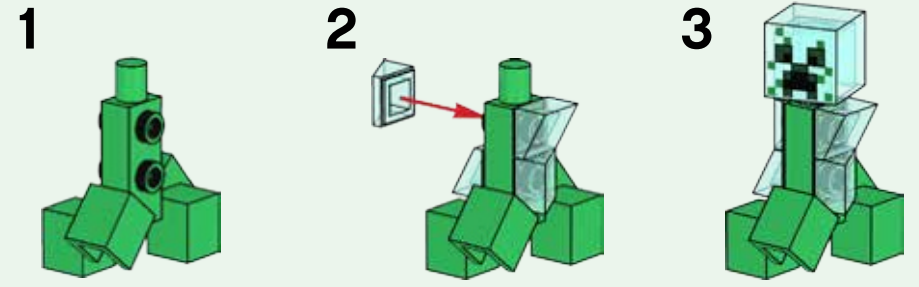
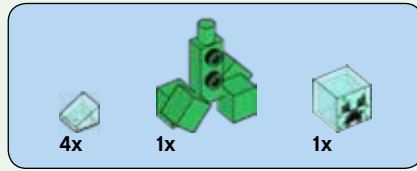
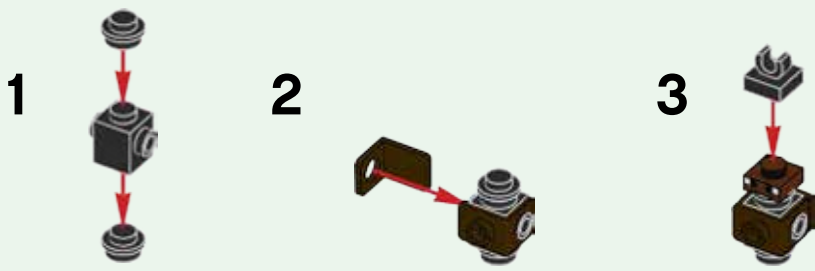

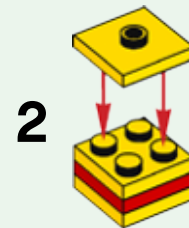
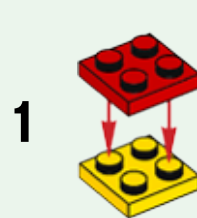
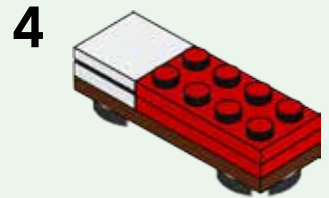
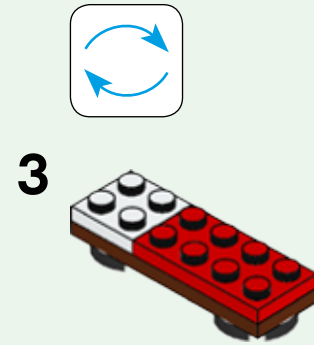
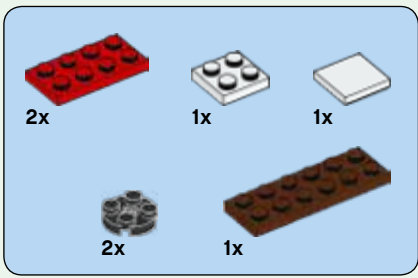

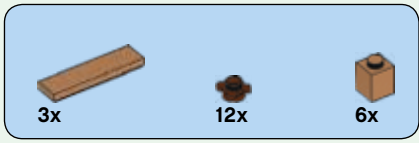

1



2

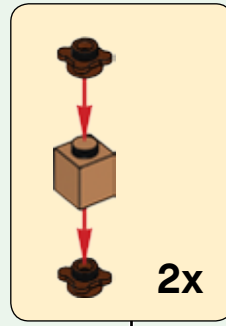
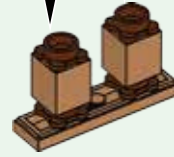

3



3x

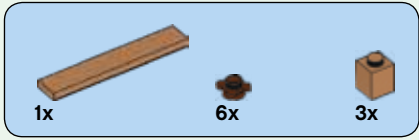

1

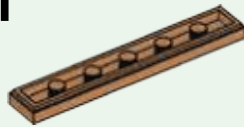

2

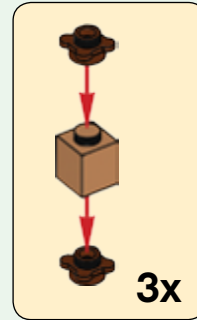
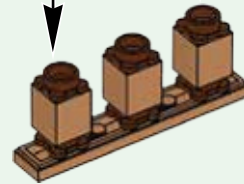

3





1



2



3



4

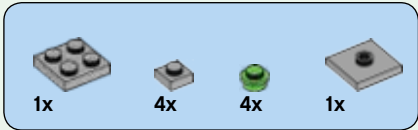

1



2

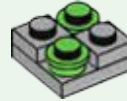

3



4

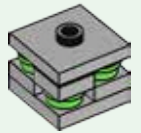

1



2



3

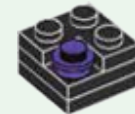

4



1



2

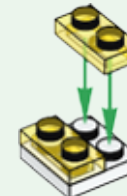

3



4



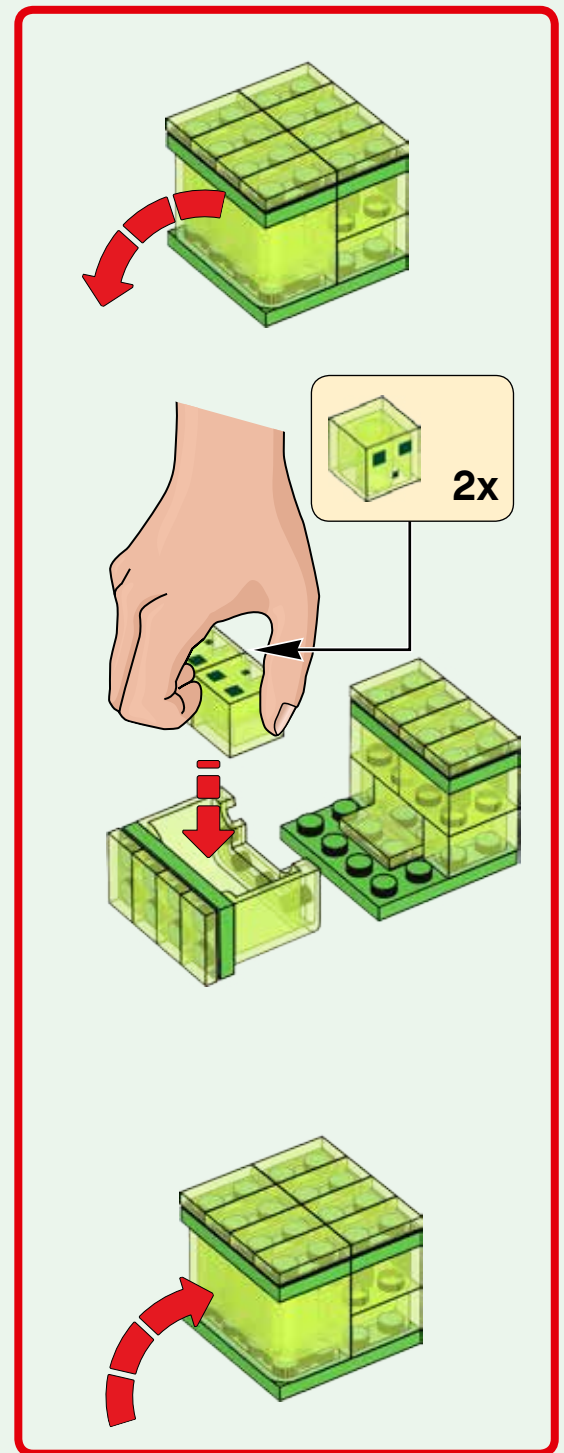
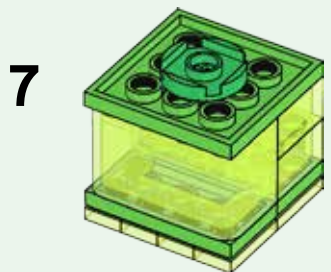
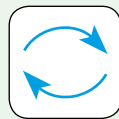
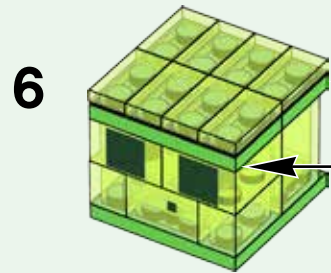
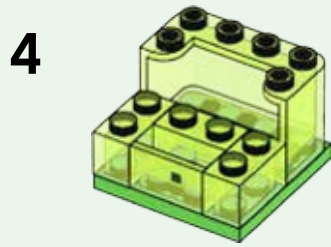
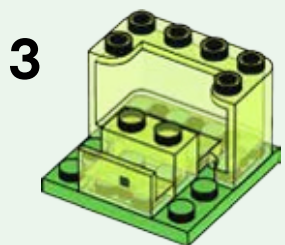
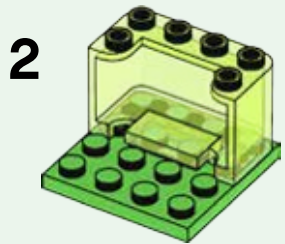
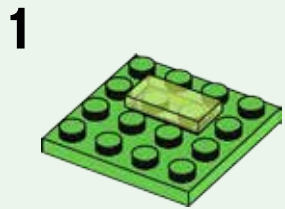
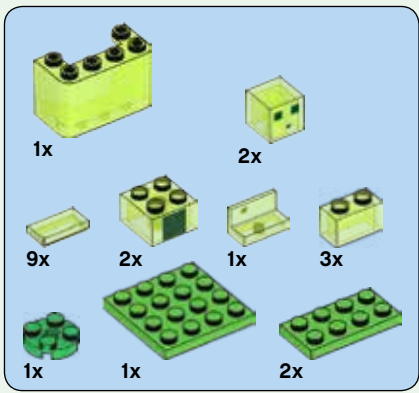

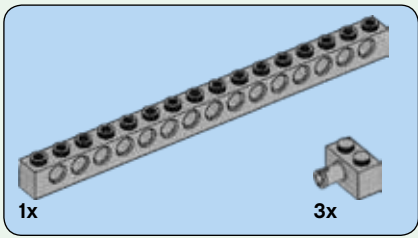
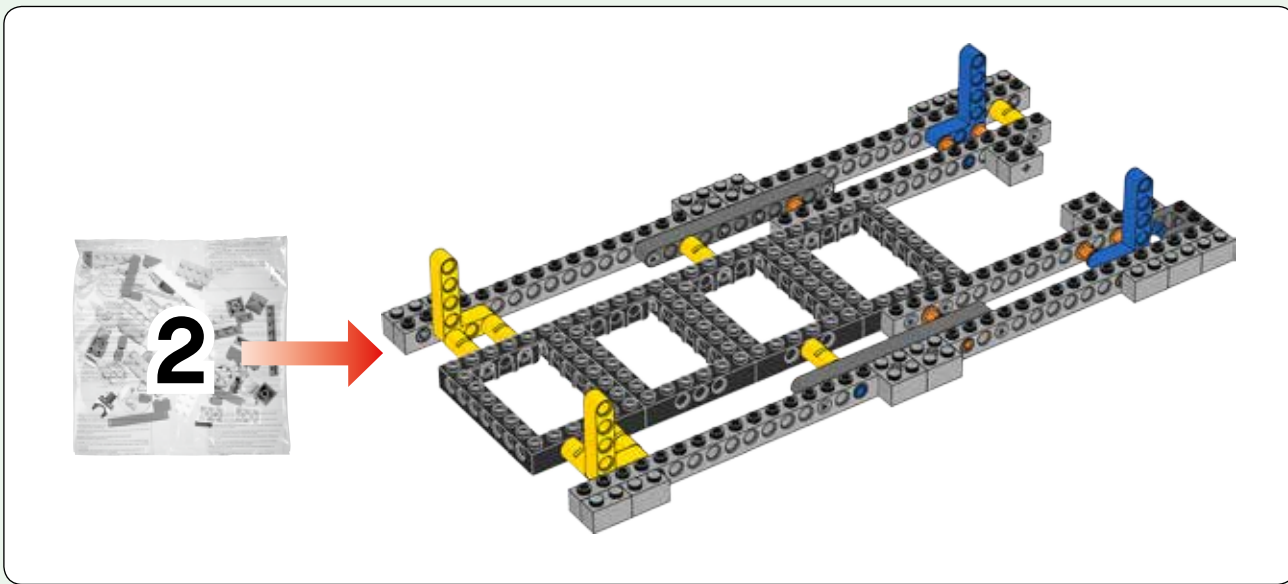

1

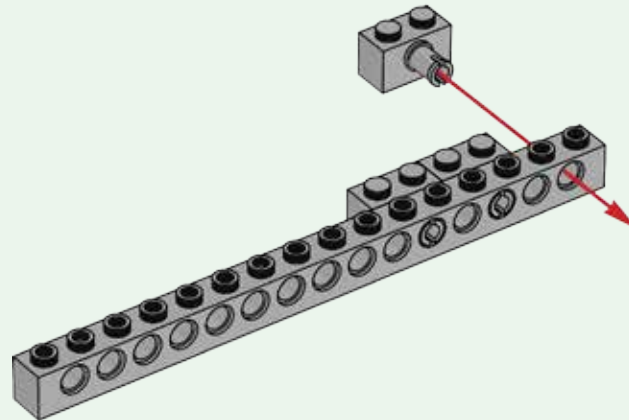



2

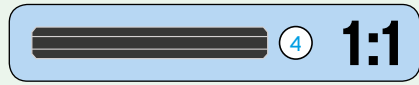
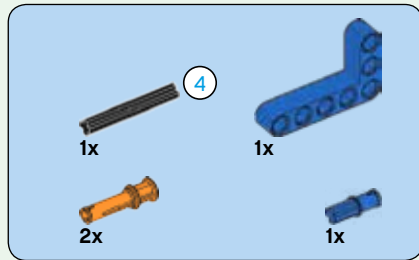
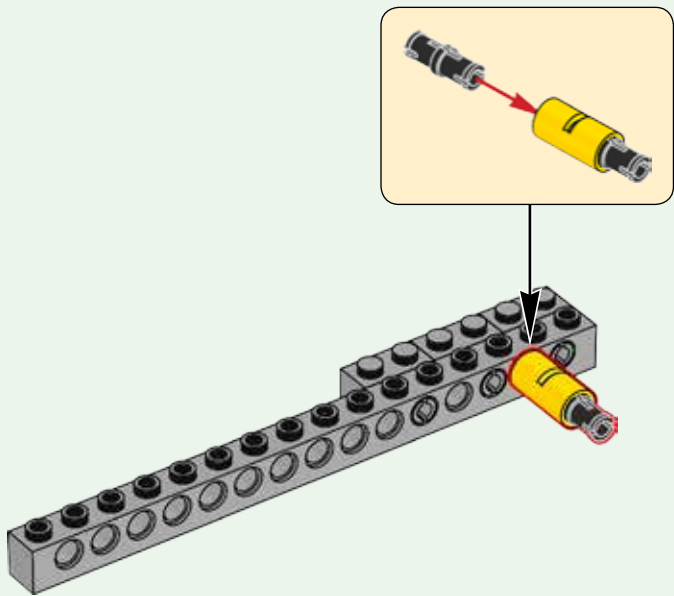

3

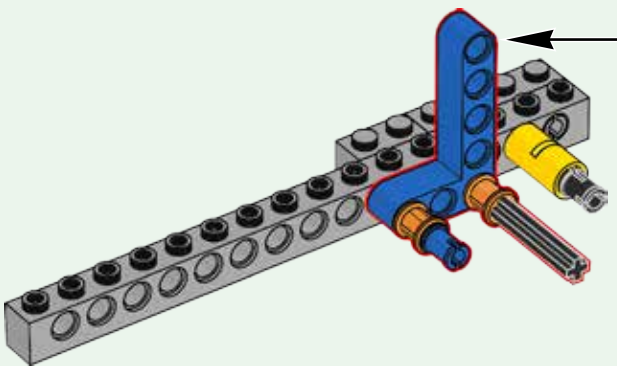
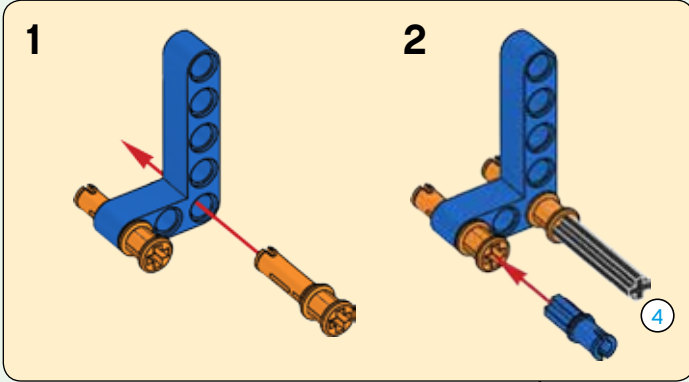

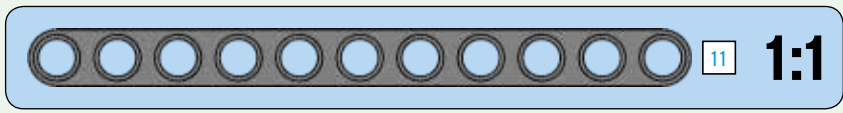
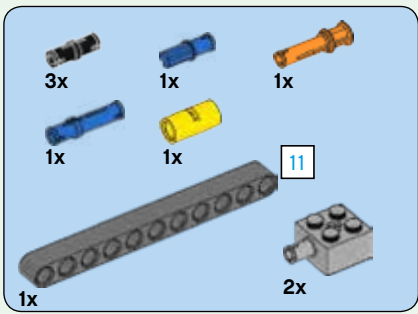

4

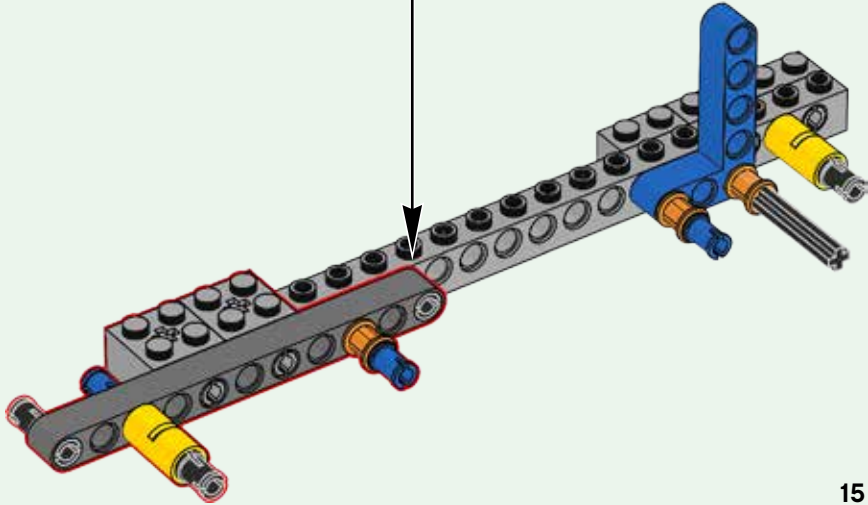
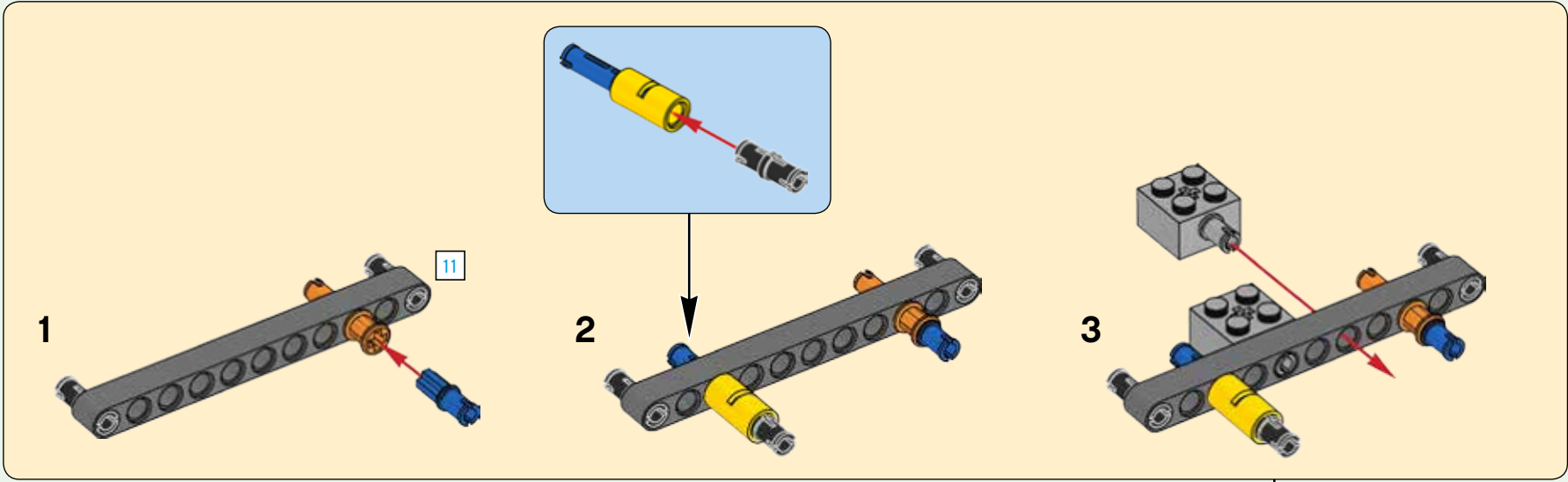

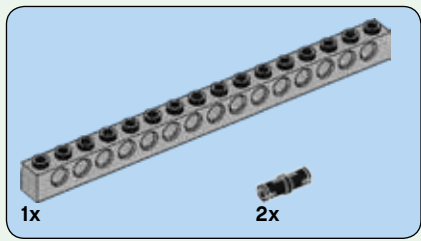

5

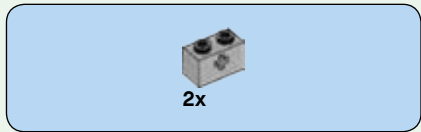
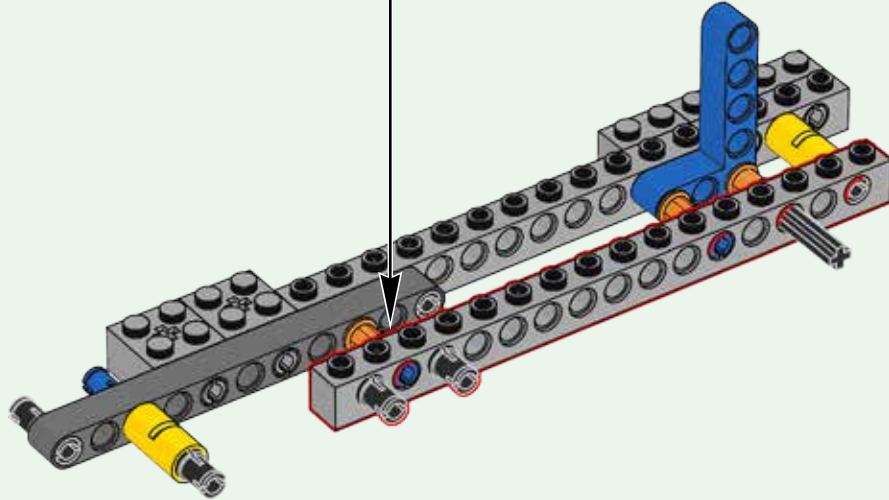
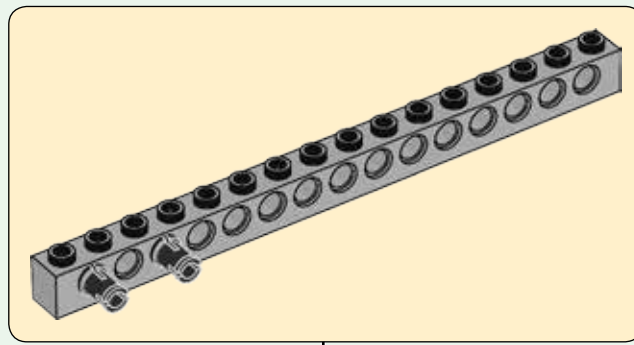

6

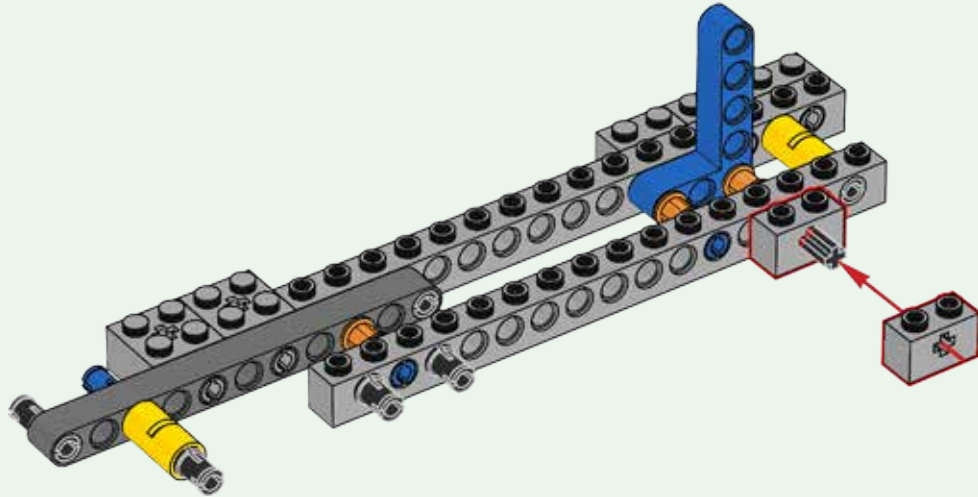

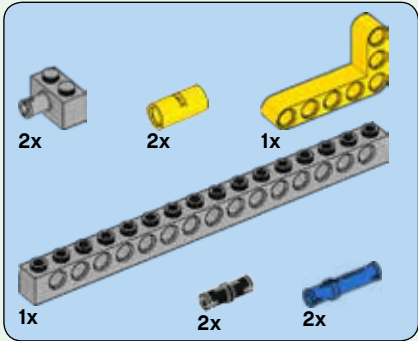
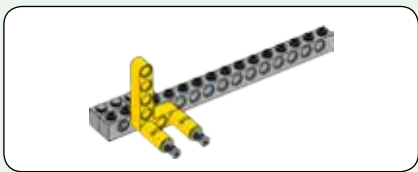

7

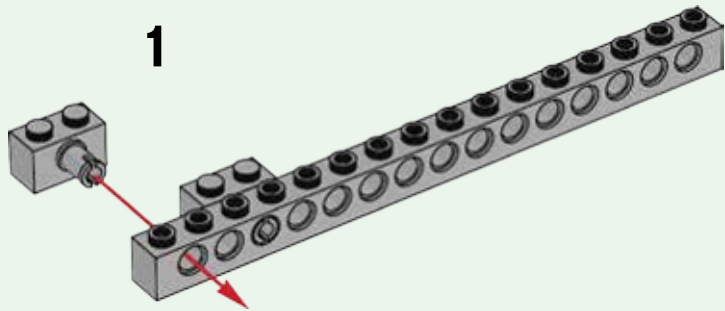

1

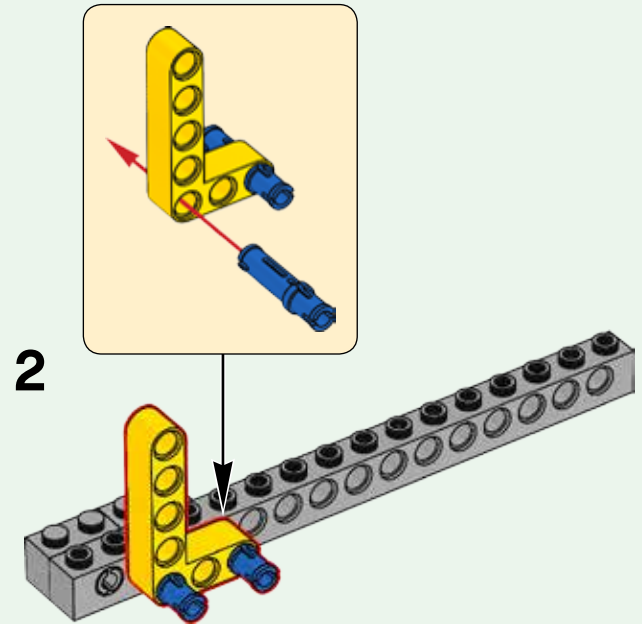

2

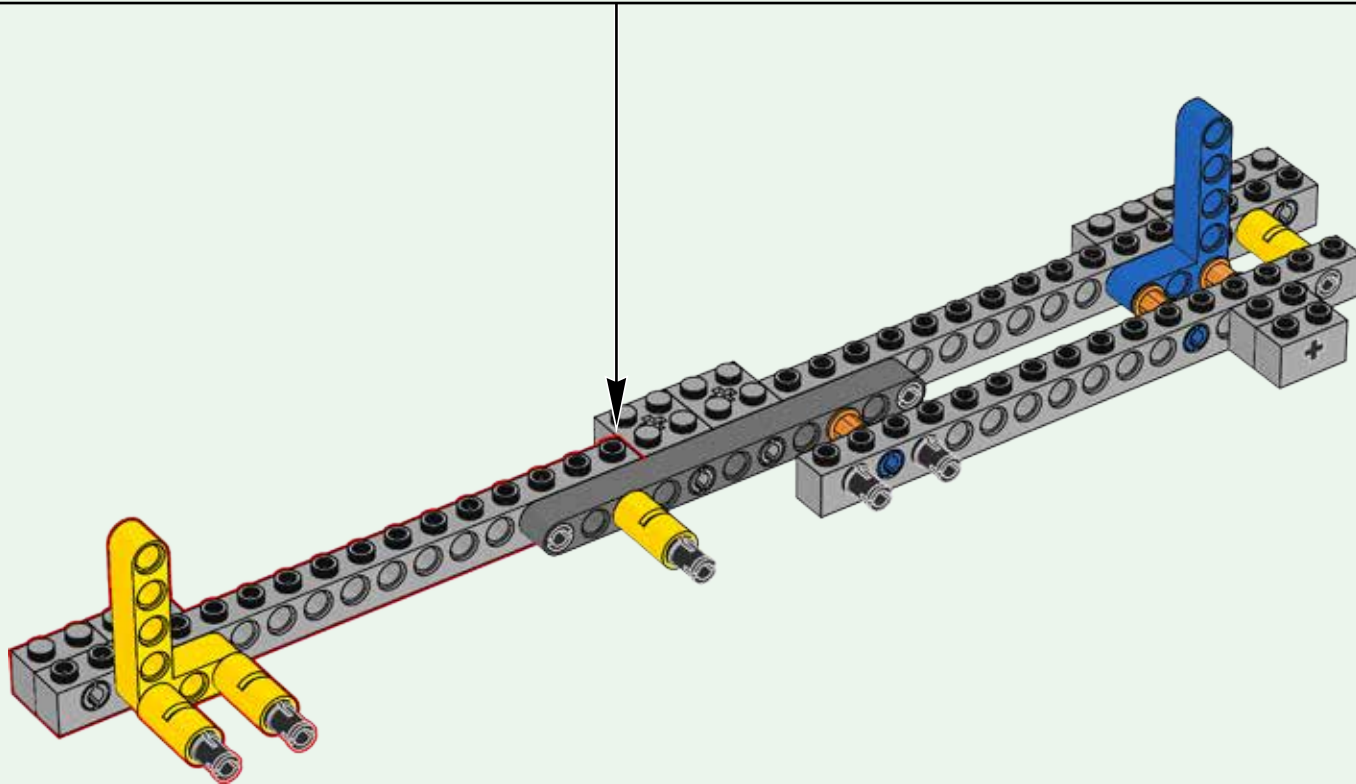
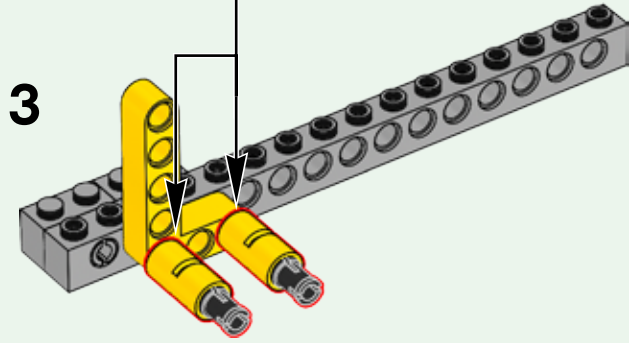
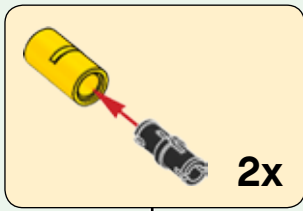

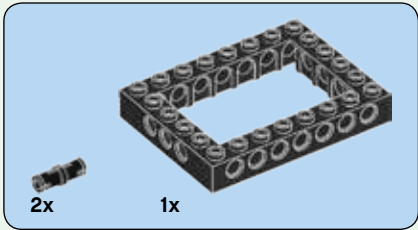
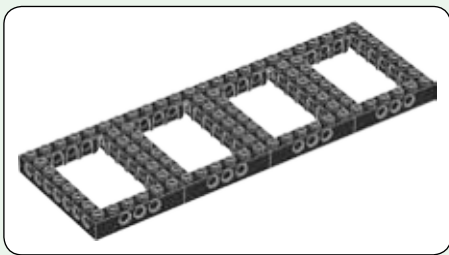

8

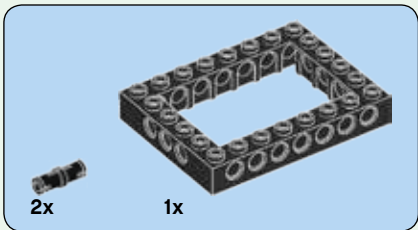
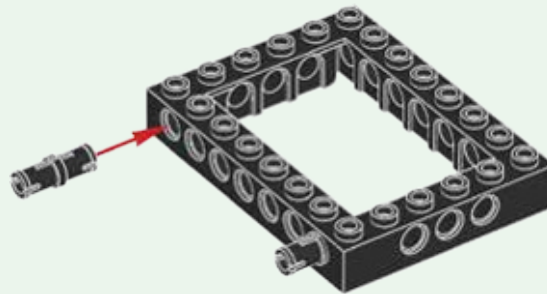

9

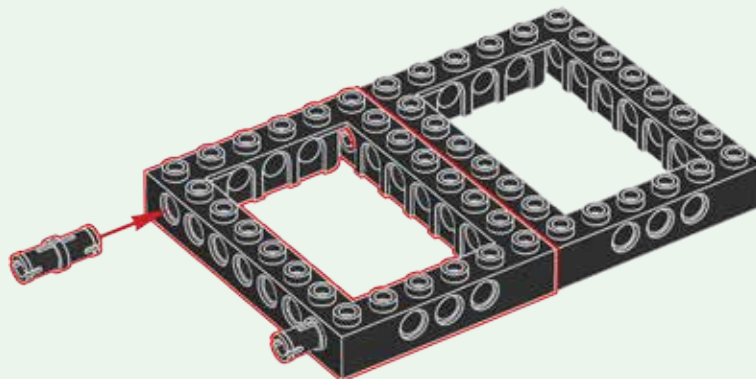

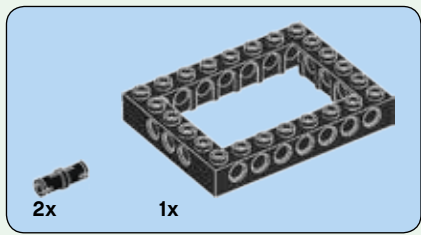

10

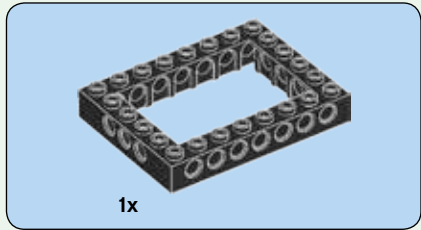
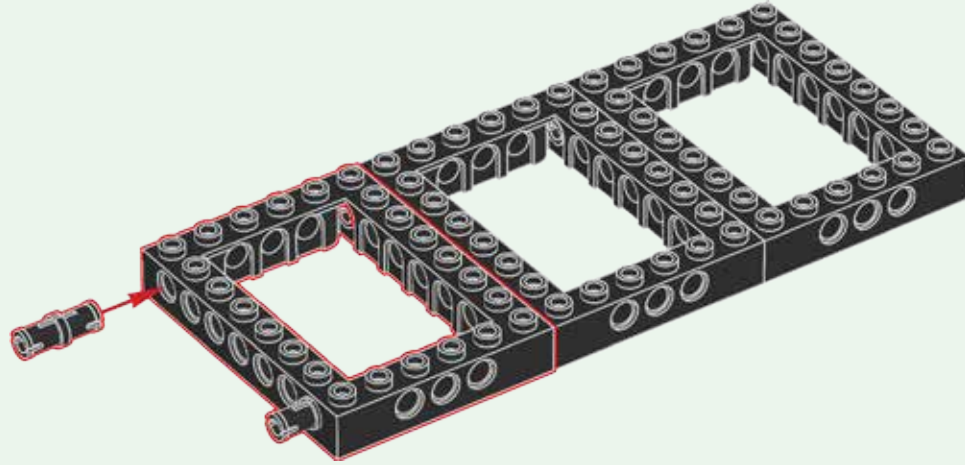

11

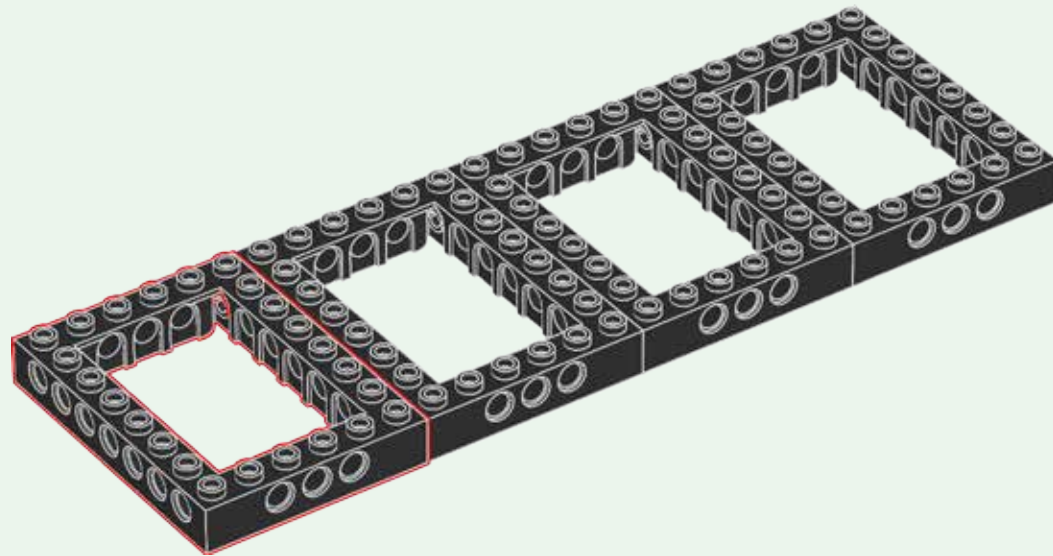

12

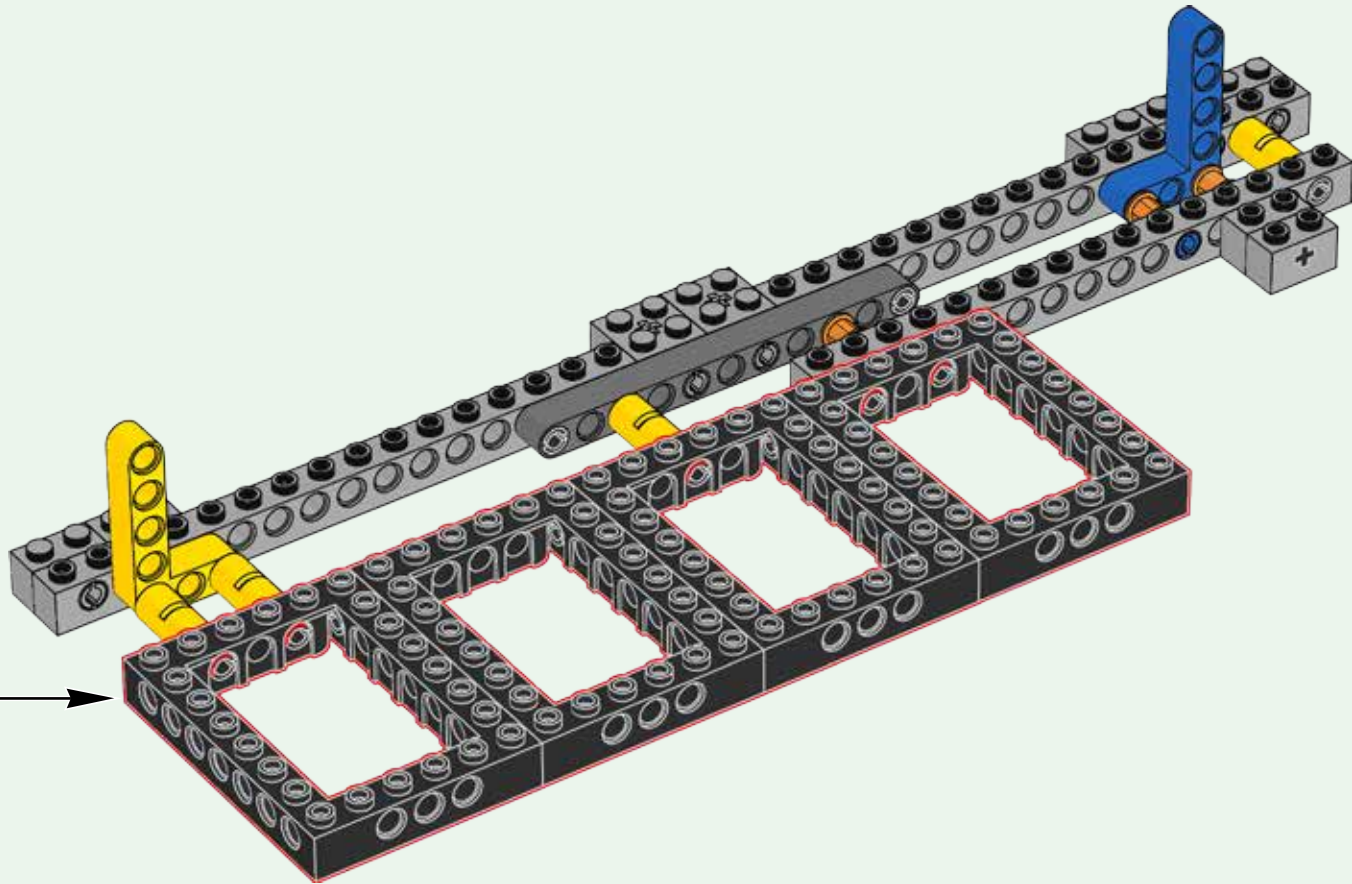

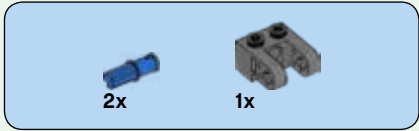
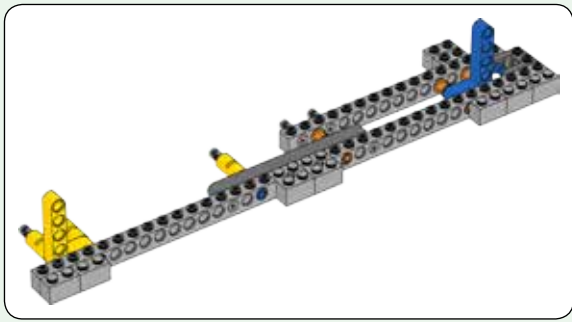

13

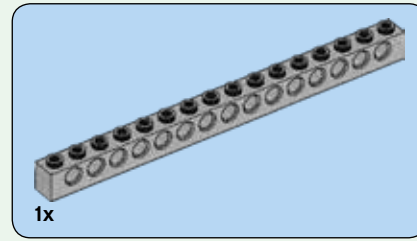
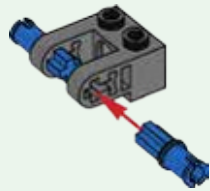

14

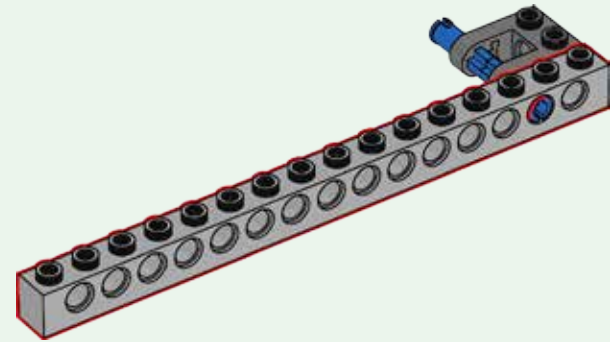



15

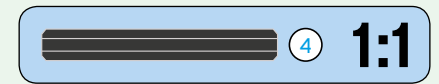
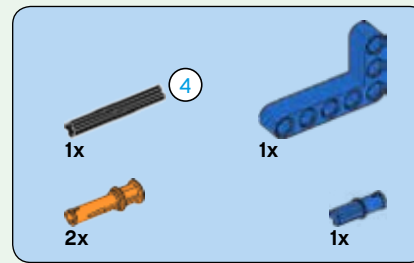
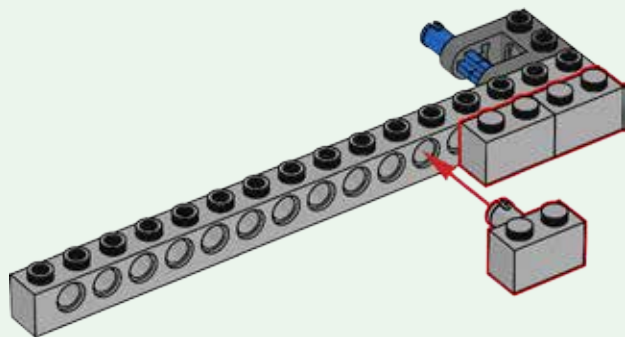

16

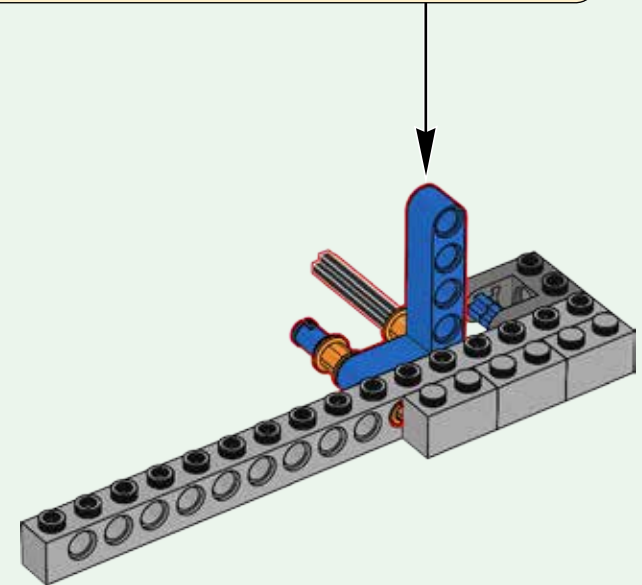
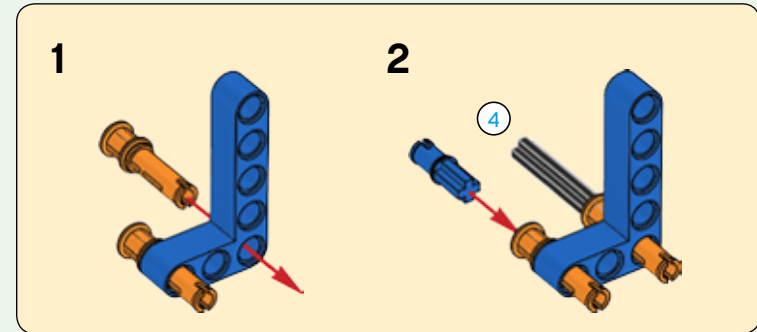

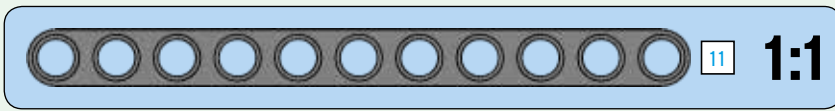
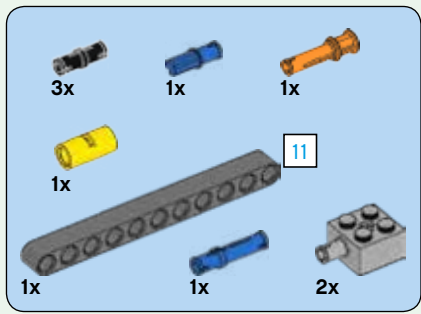

17

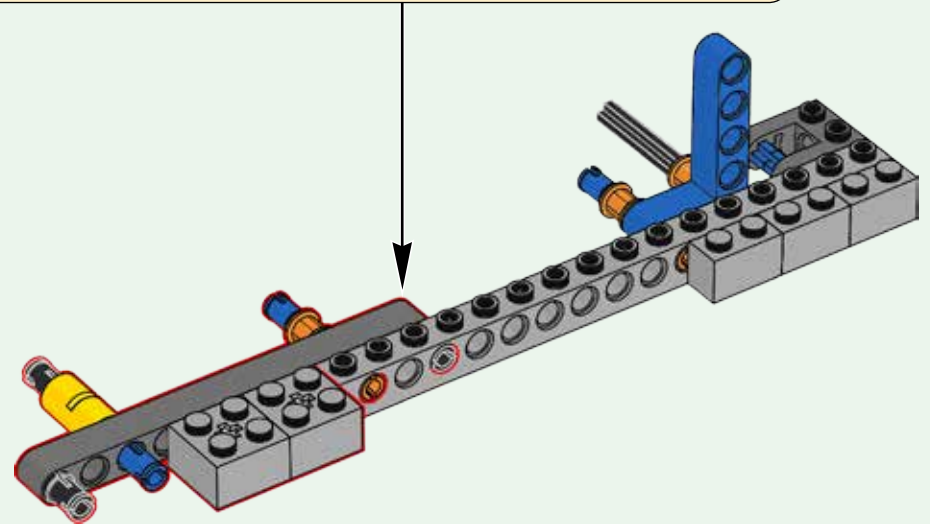
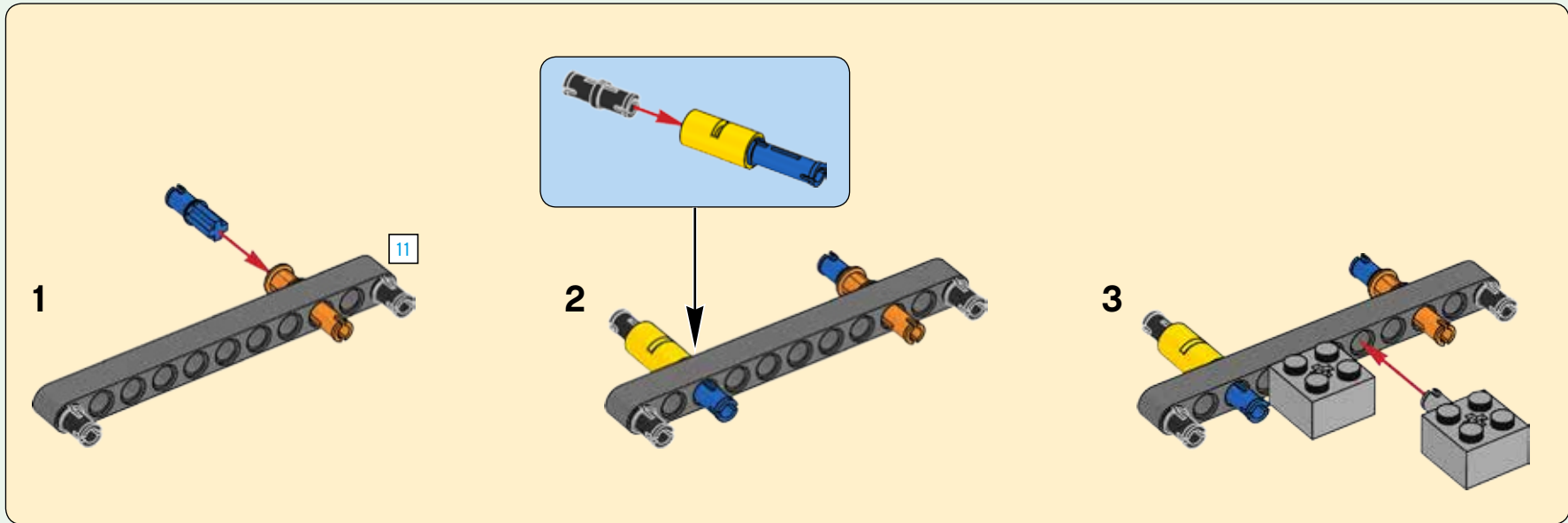

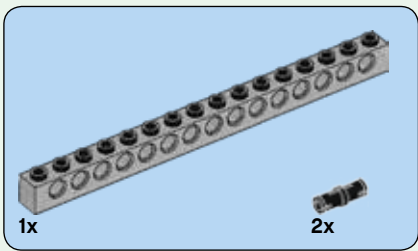

18

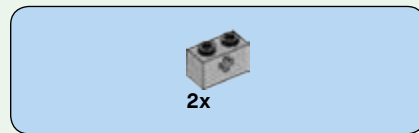
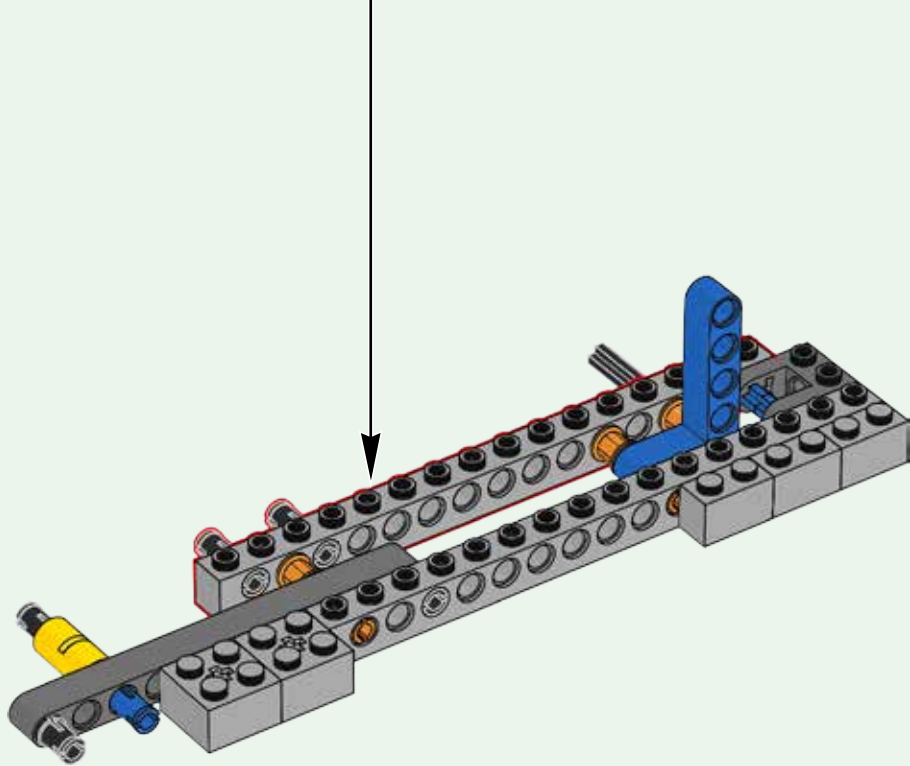
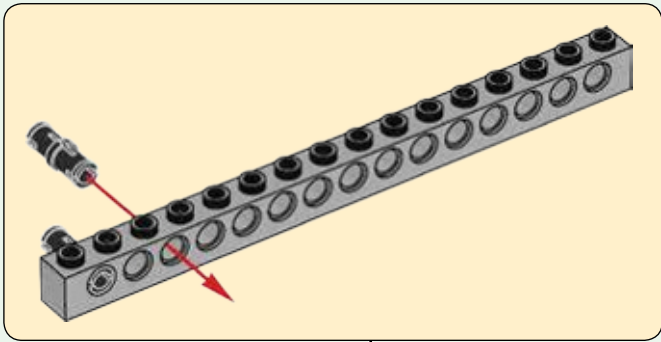

19

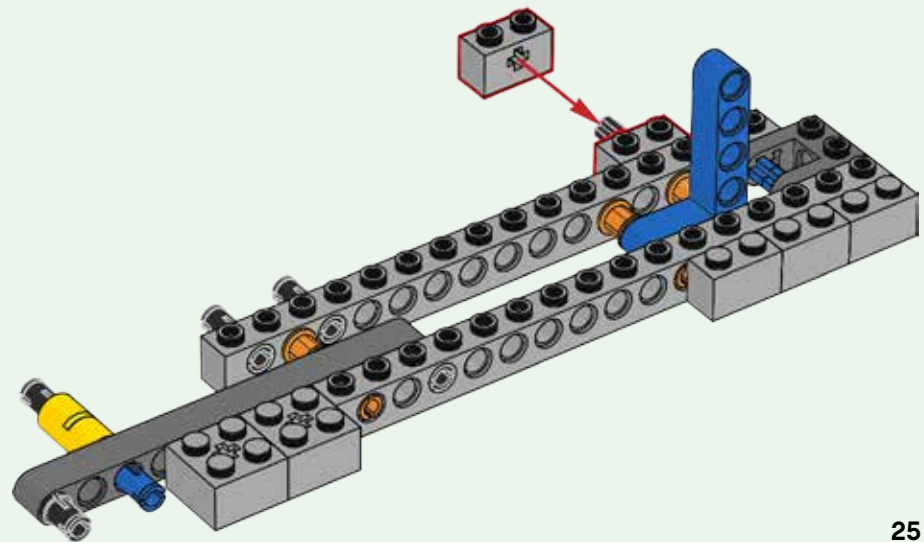

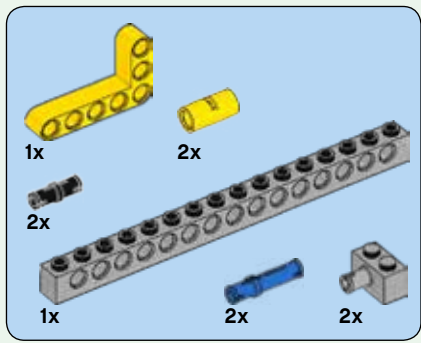

20

1

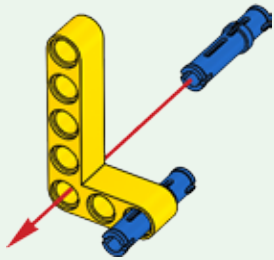

2

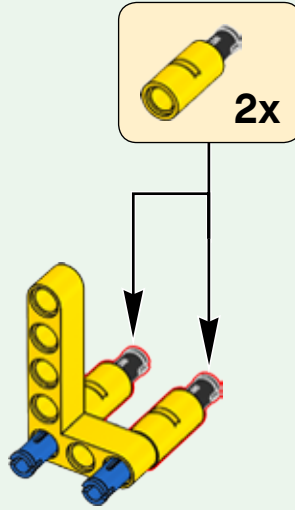

3

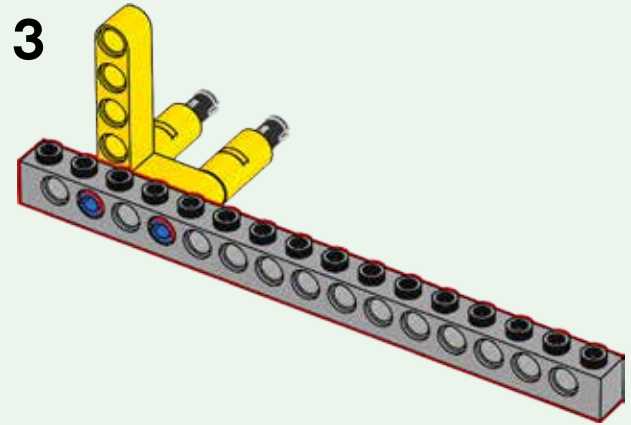

4

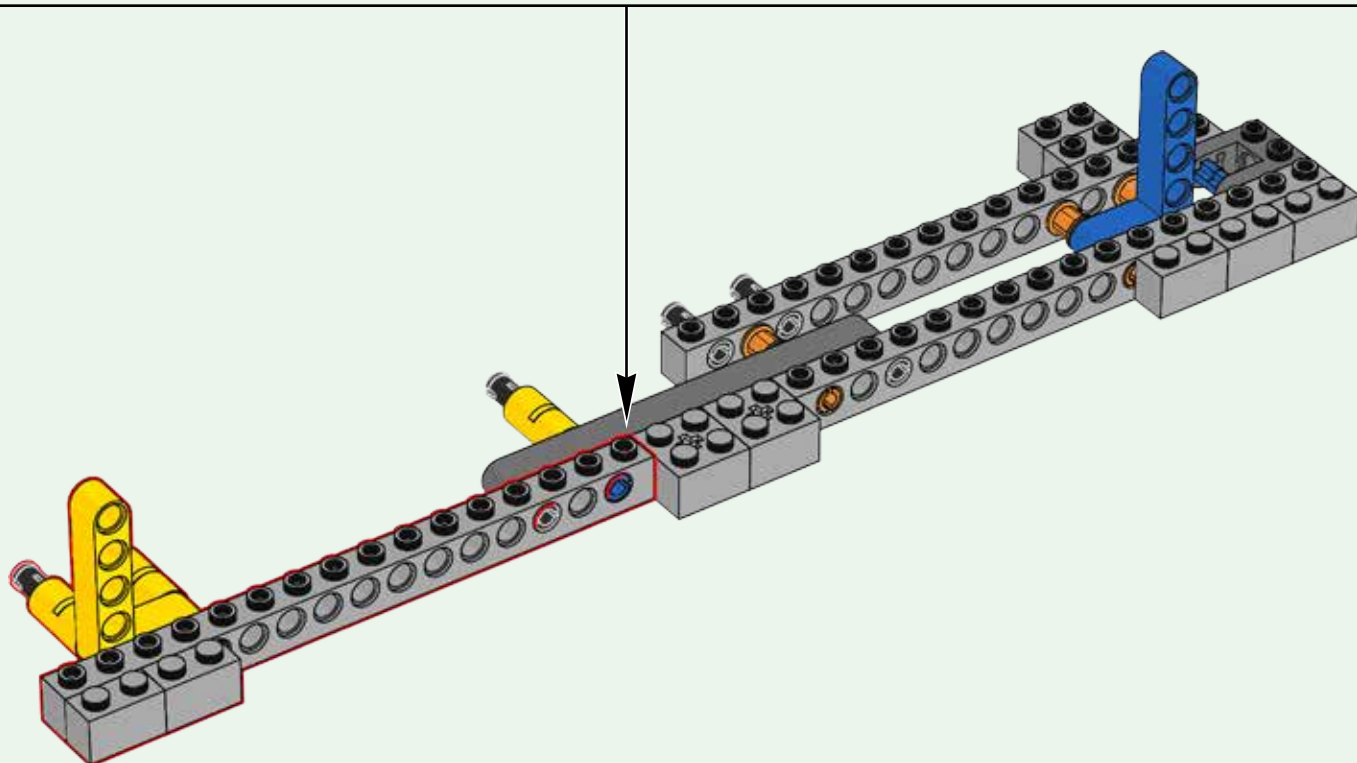
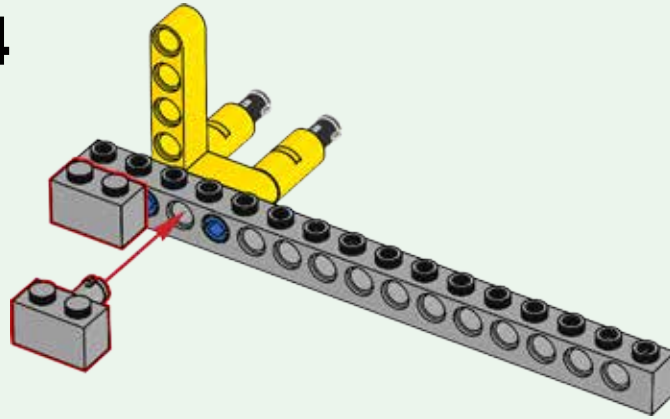

21

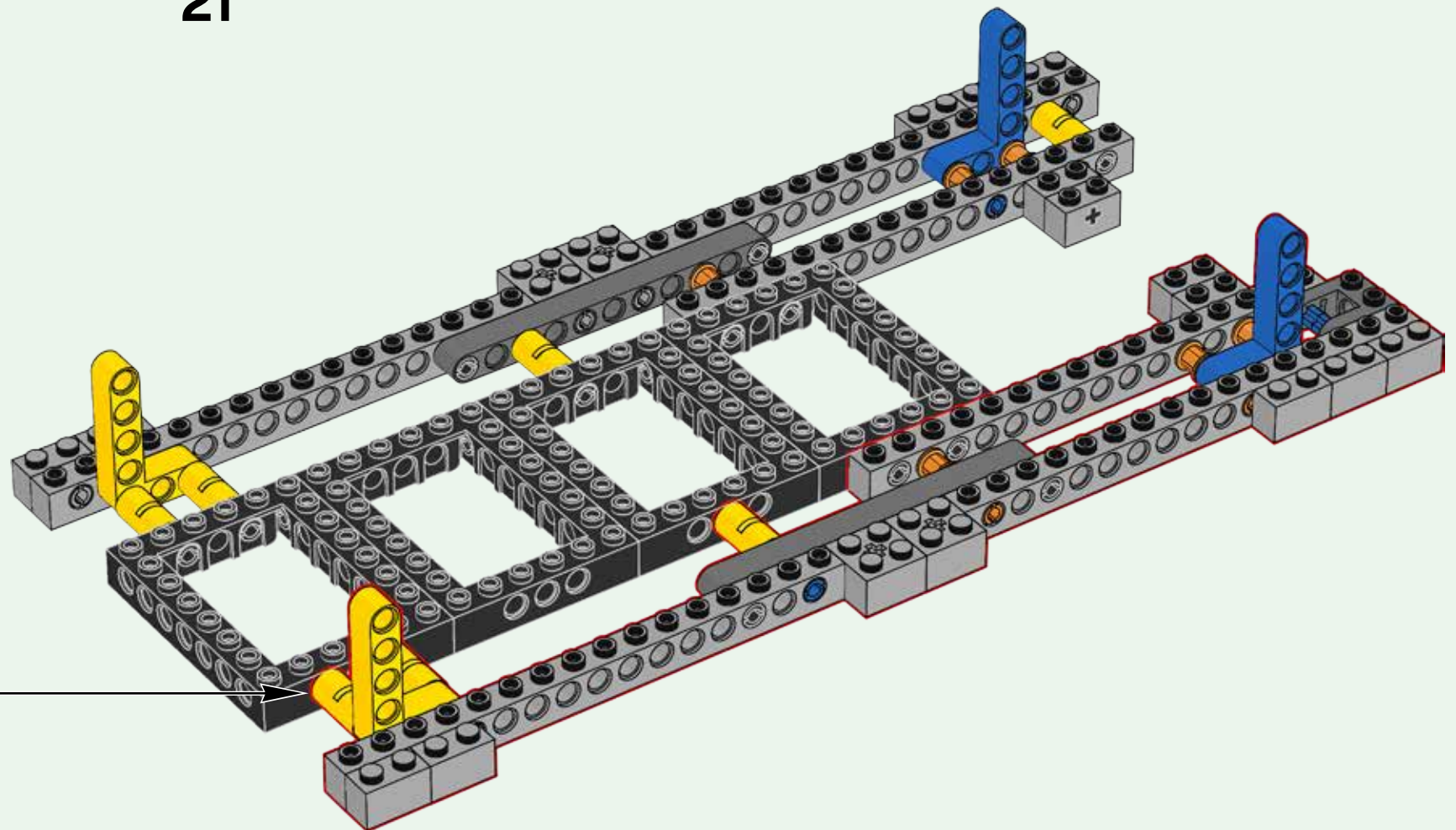

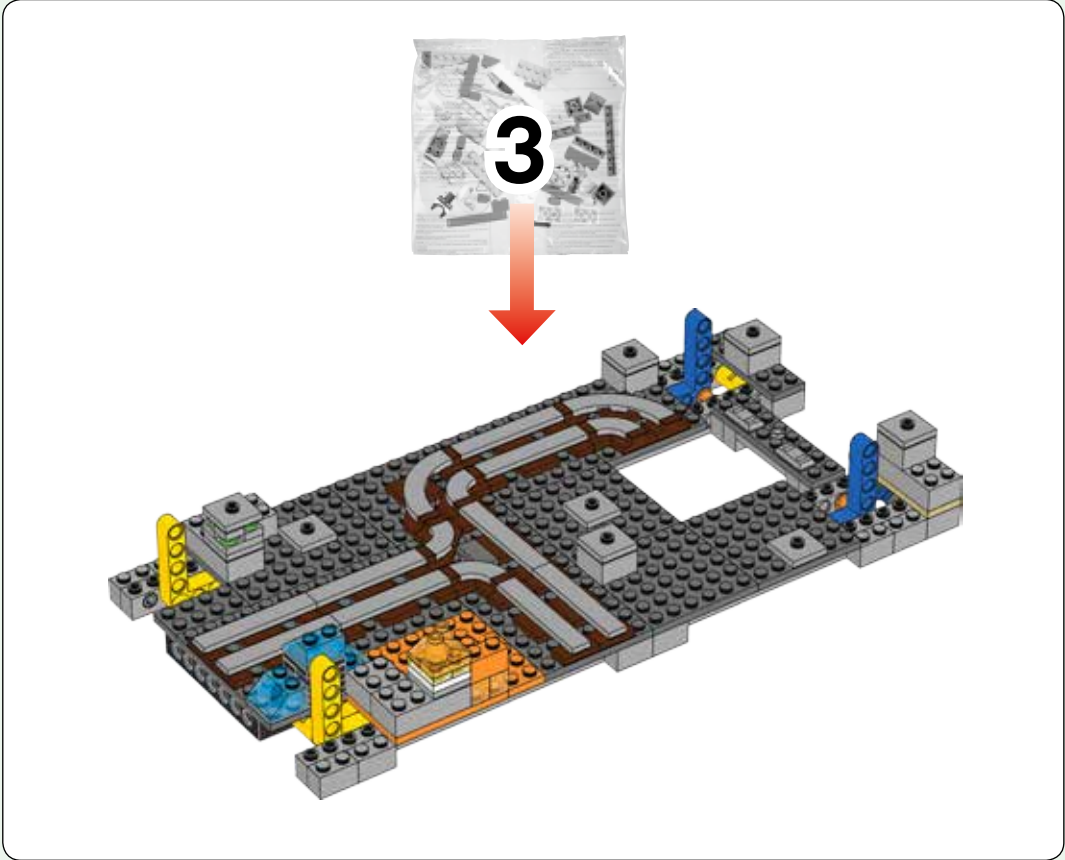

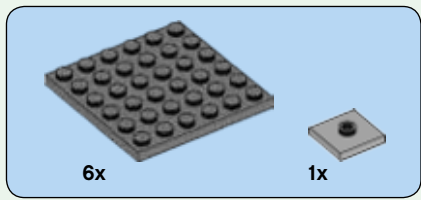

22

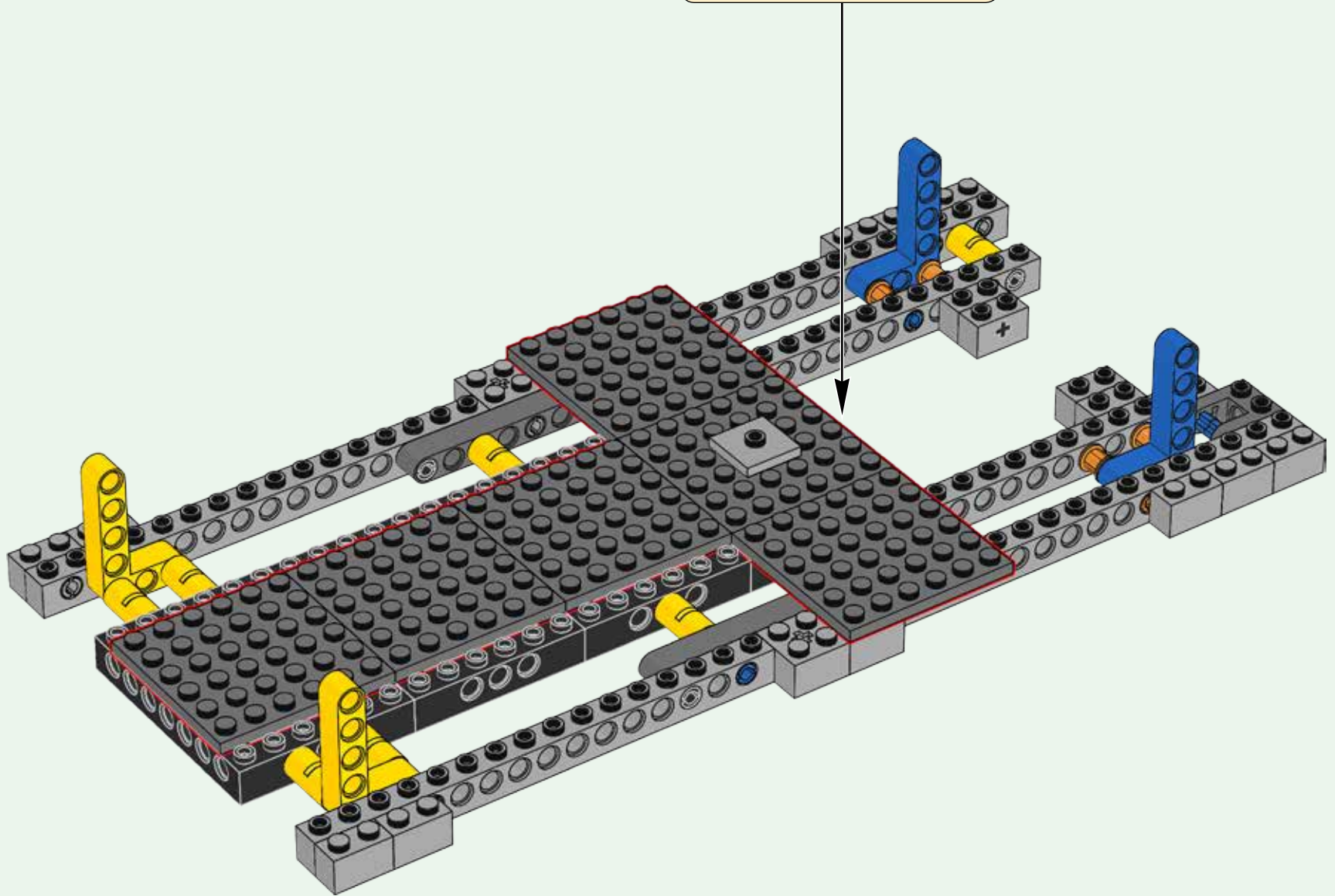
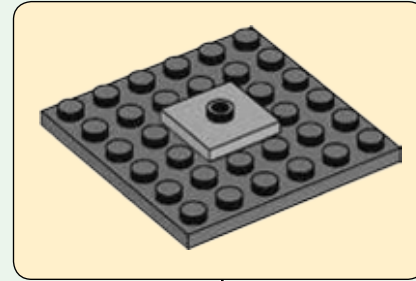

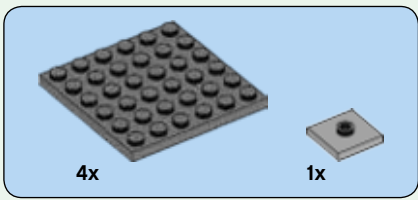

23

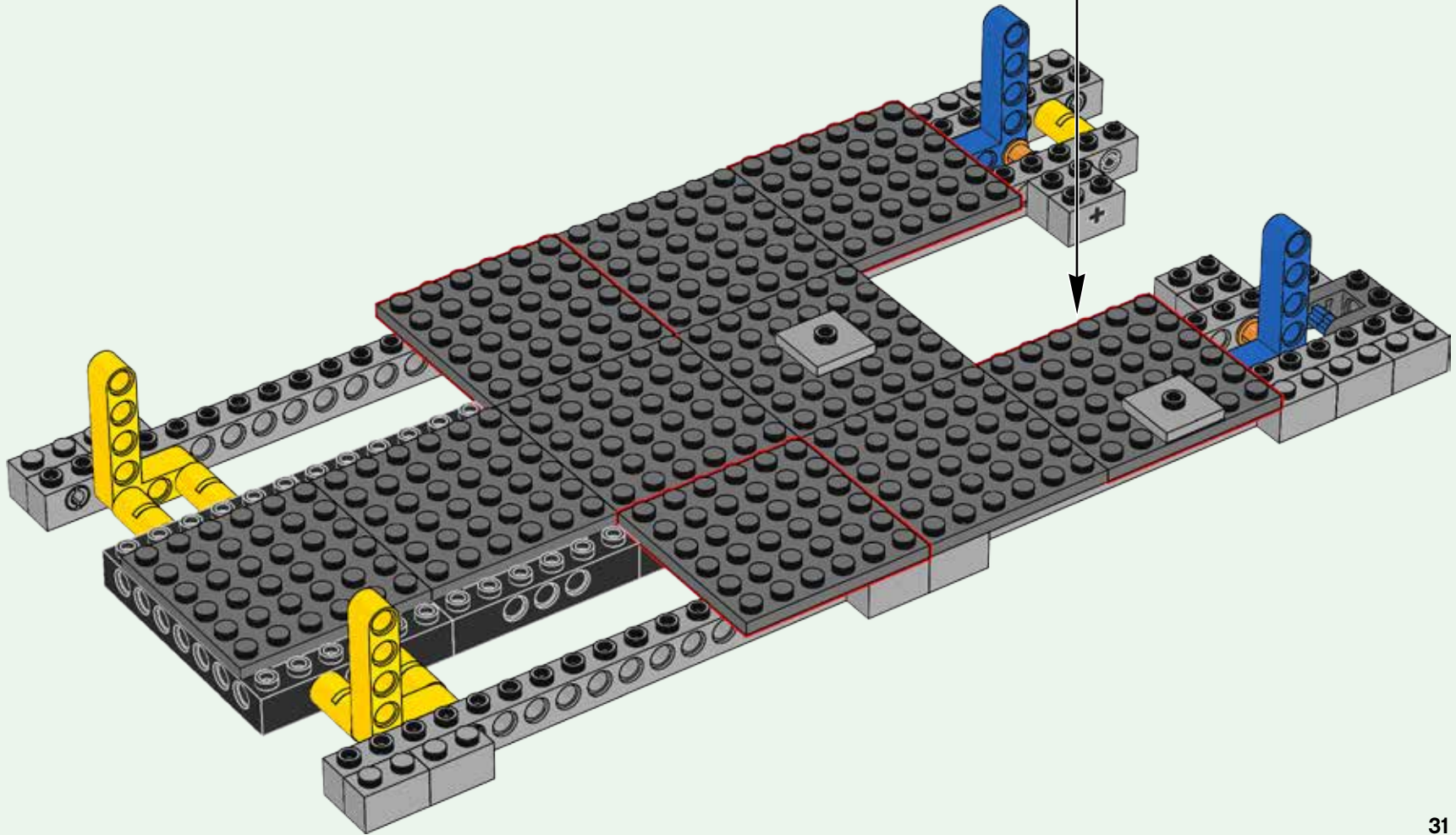
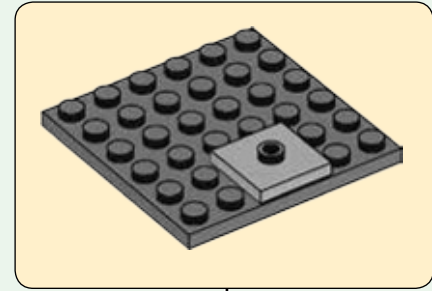

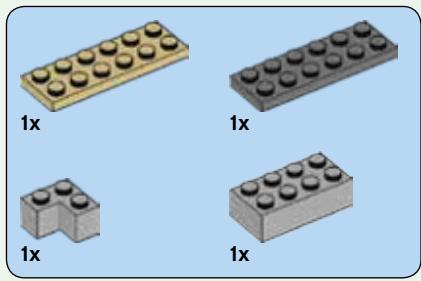

24

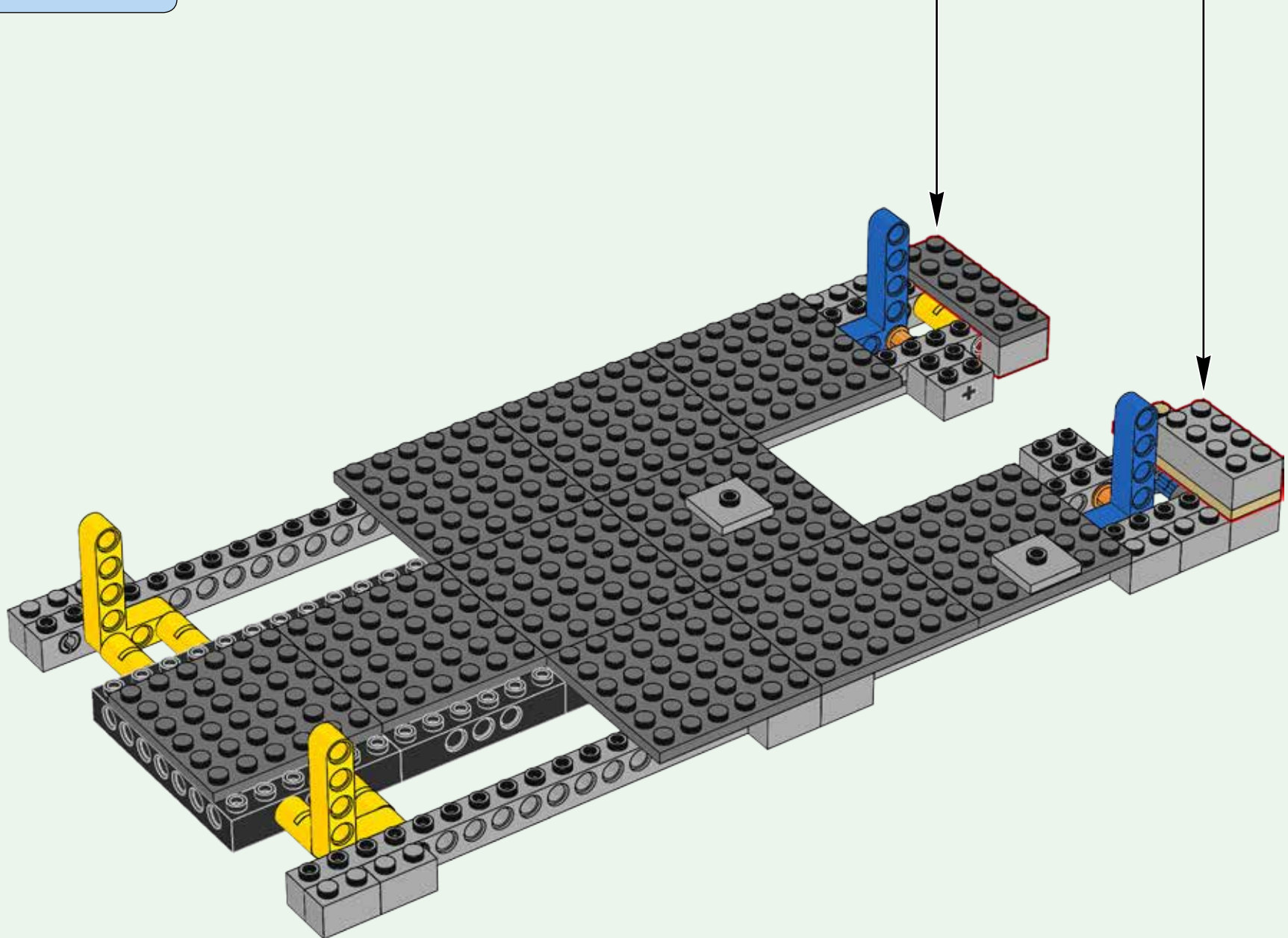
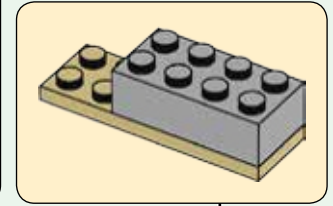
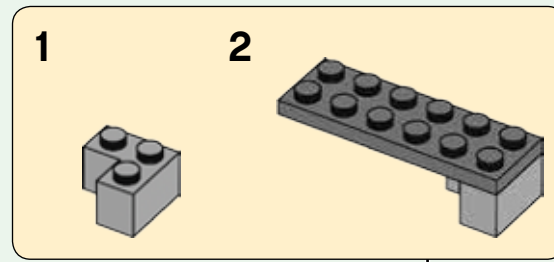

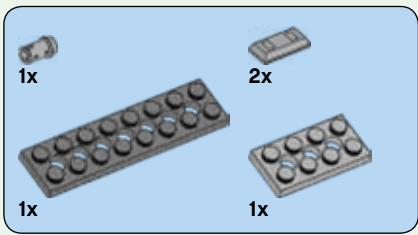

25

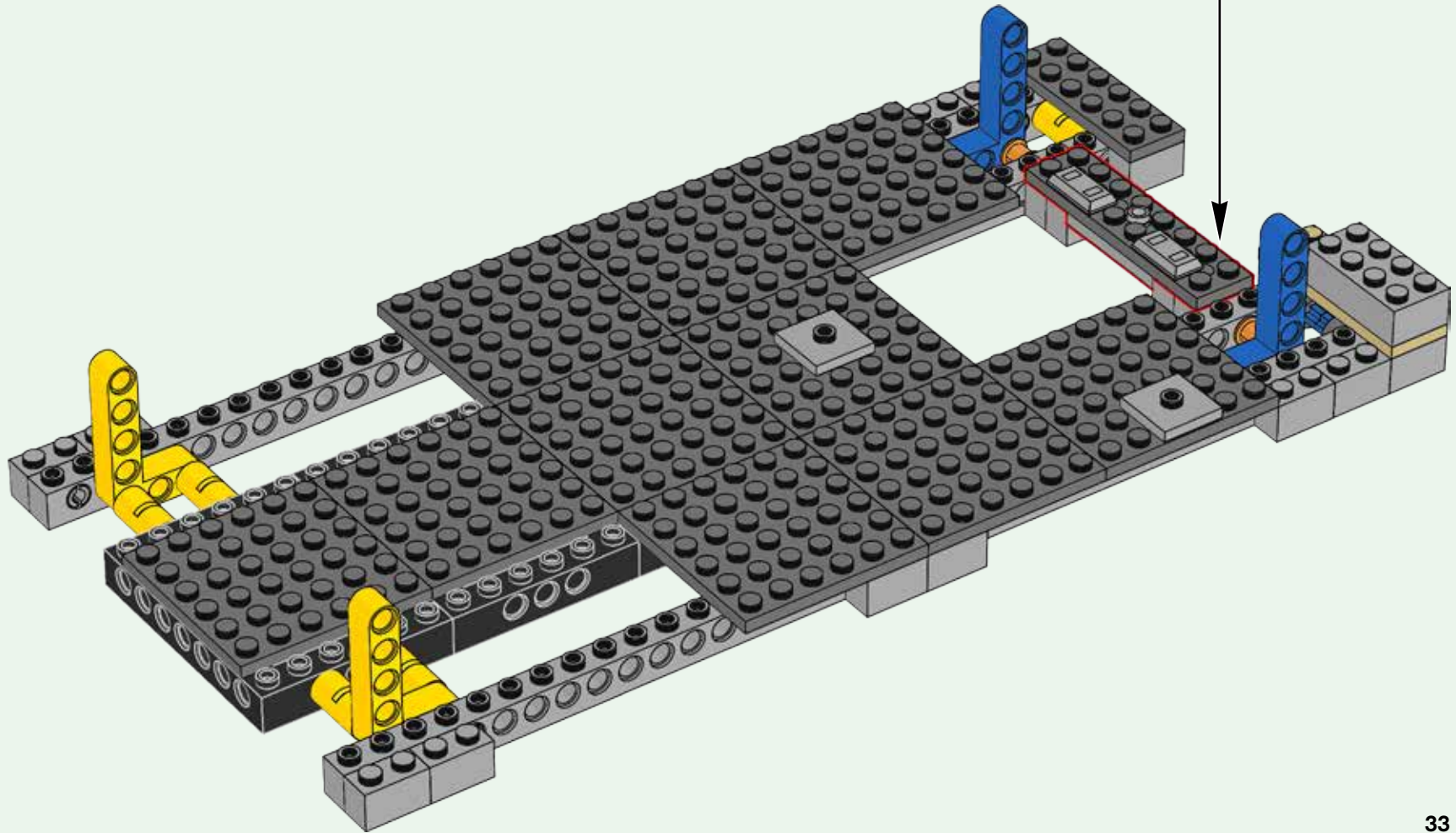
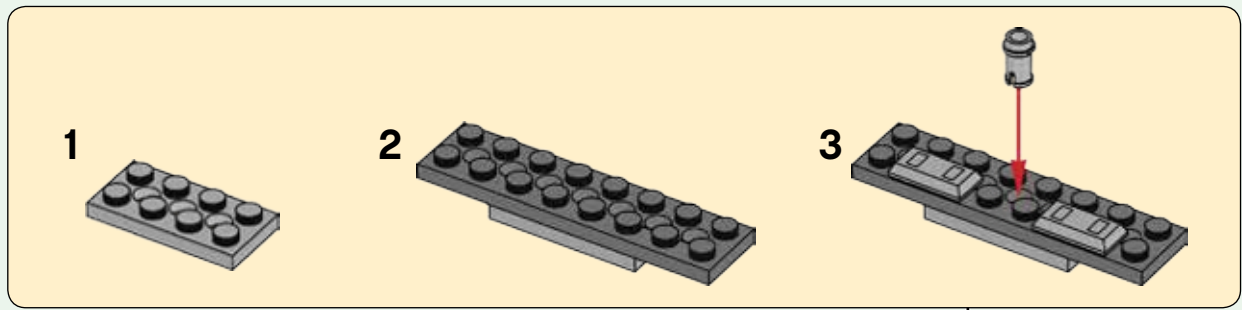

1x 4x

26

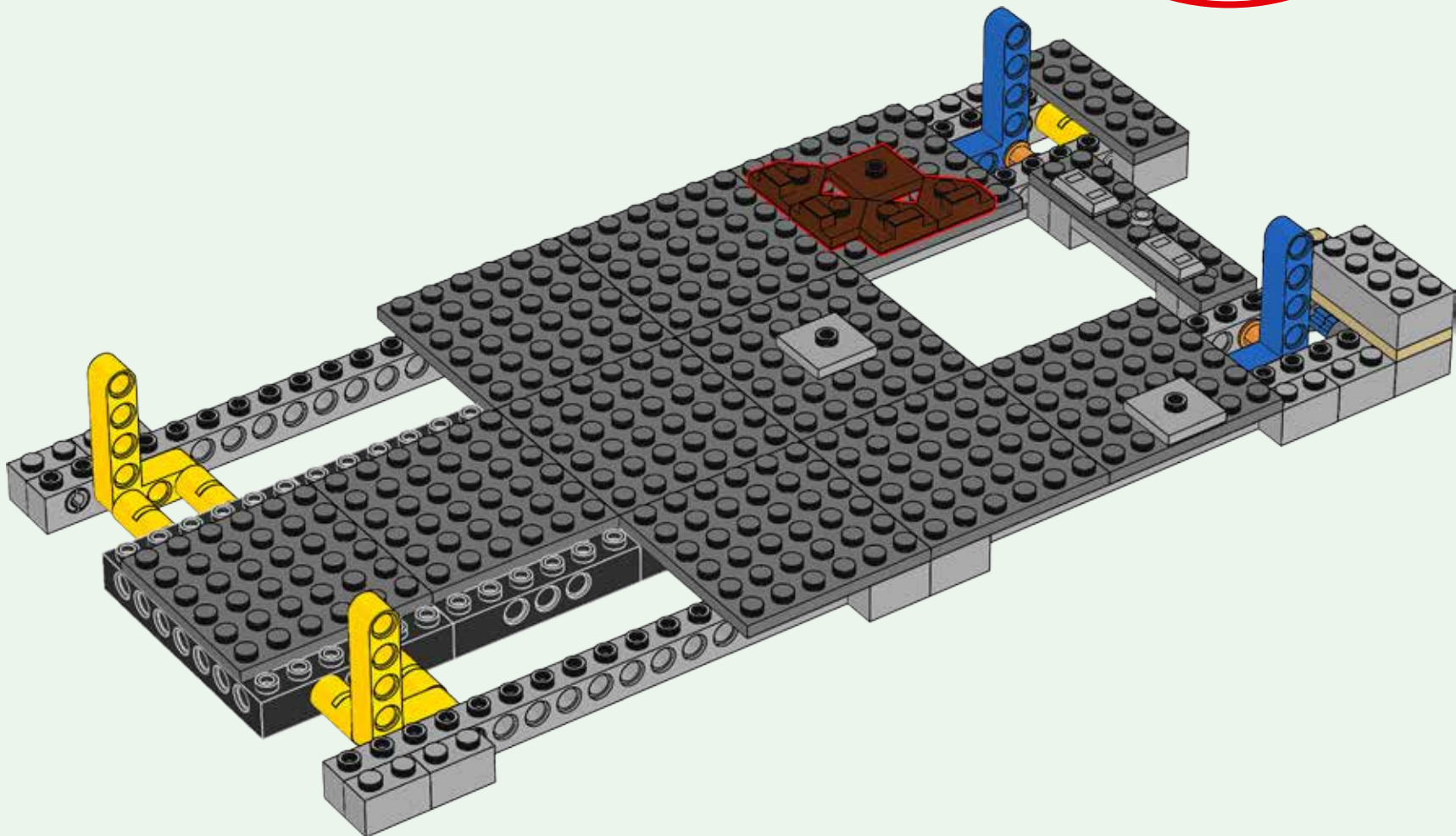
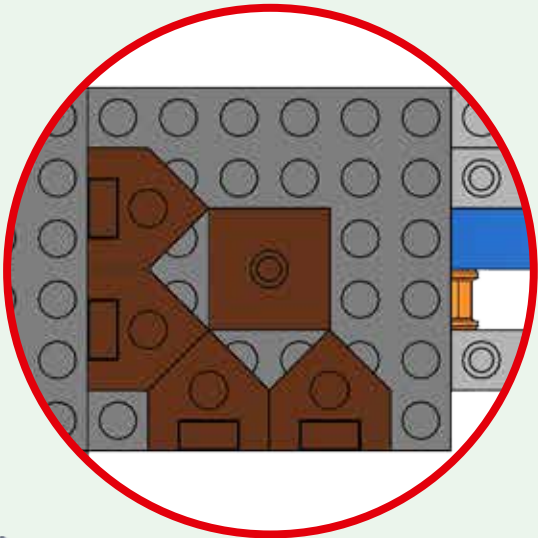



27

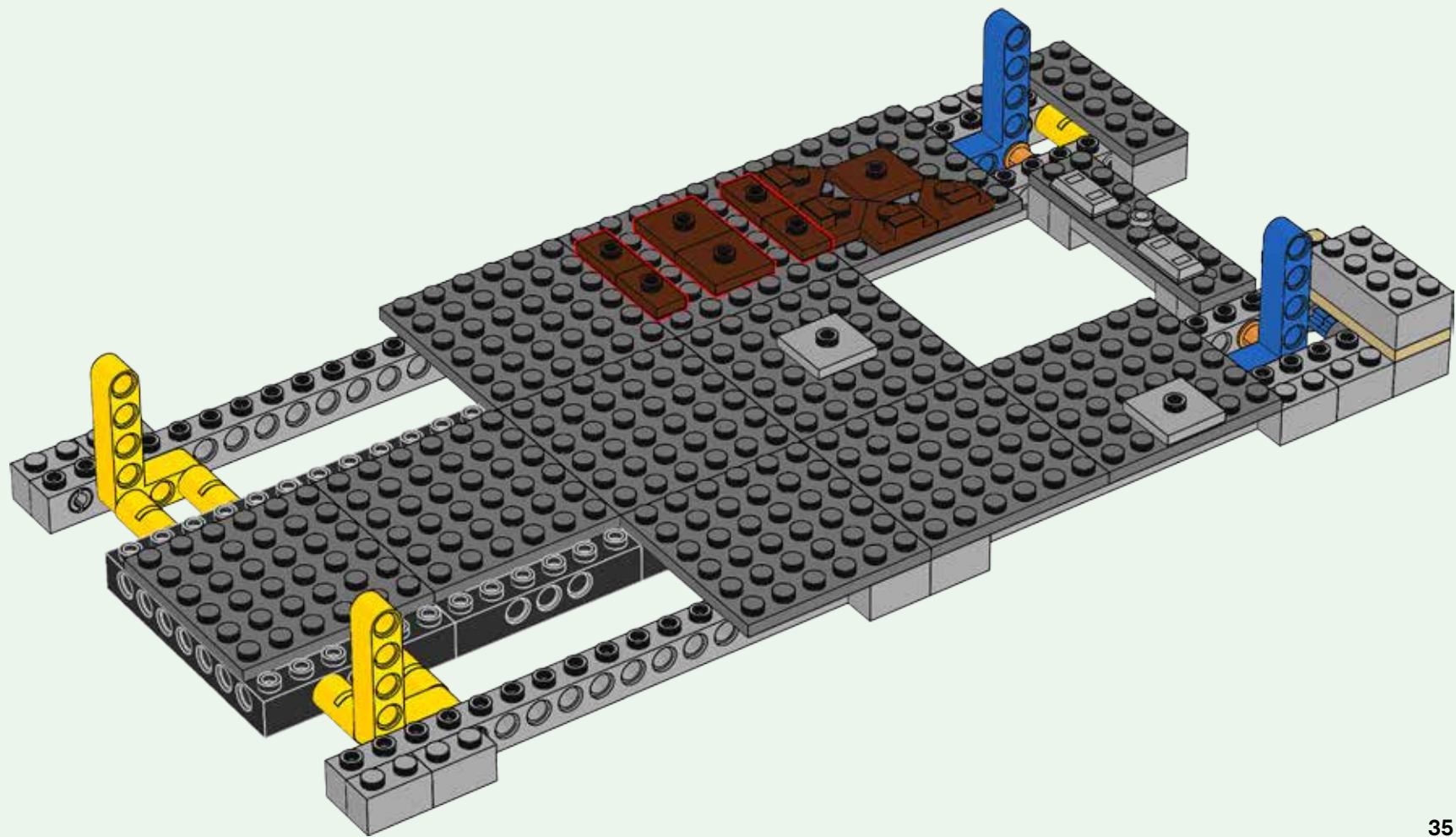

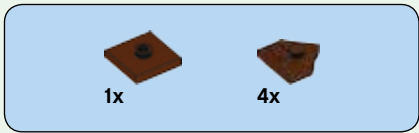

28

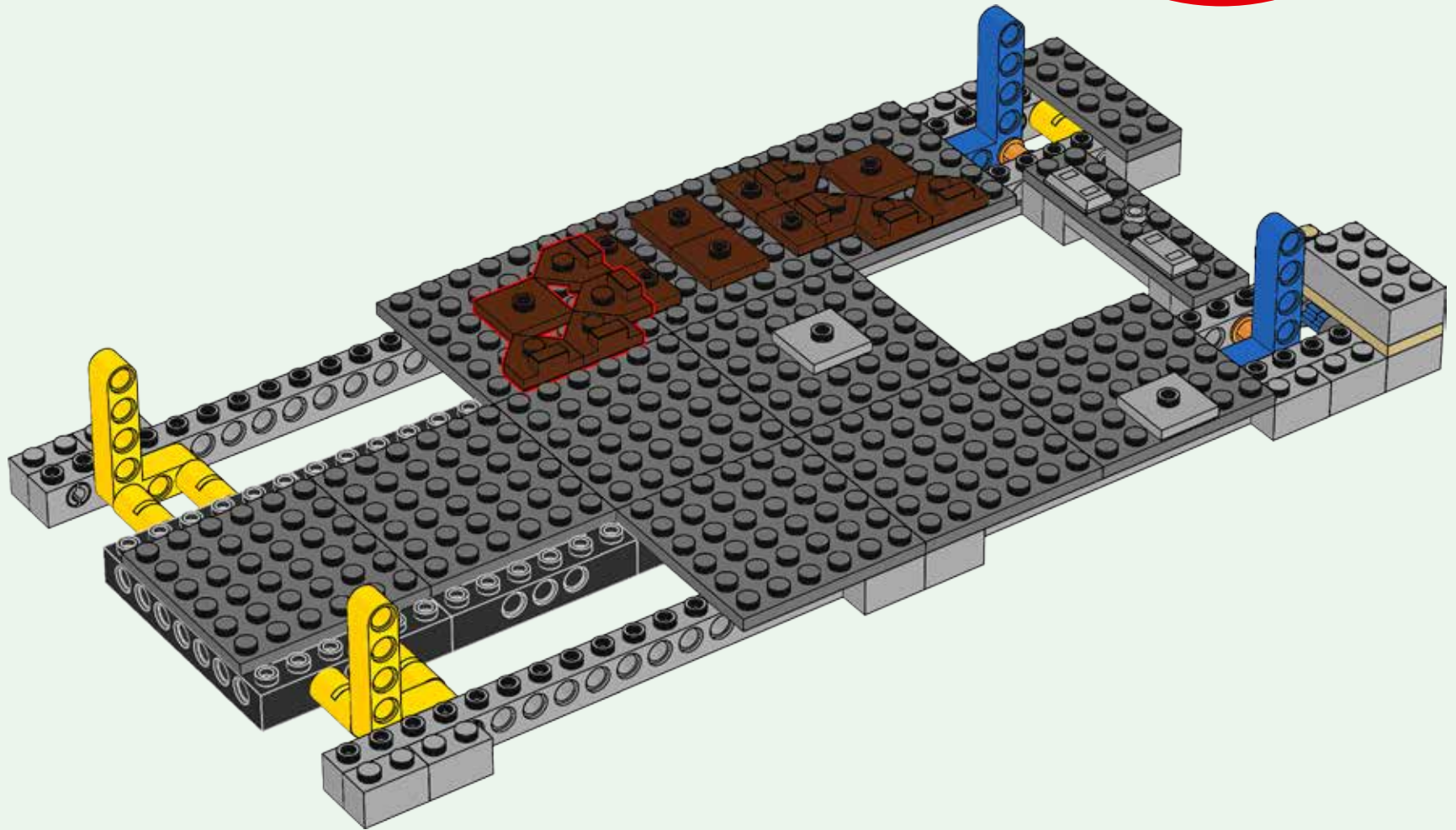
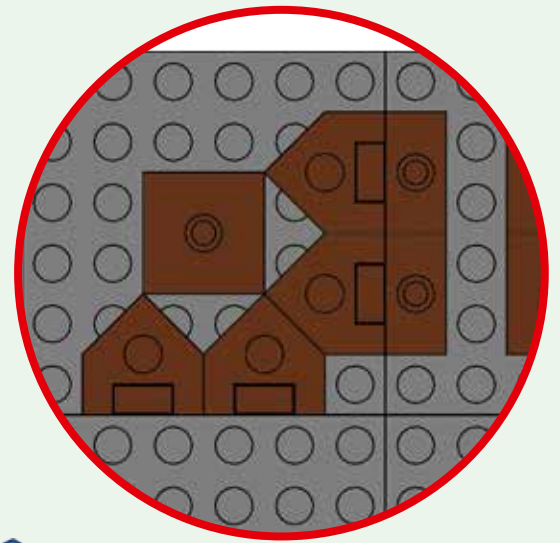

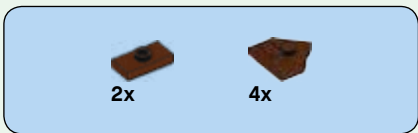

29

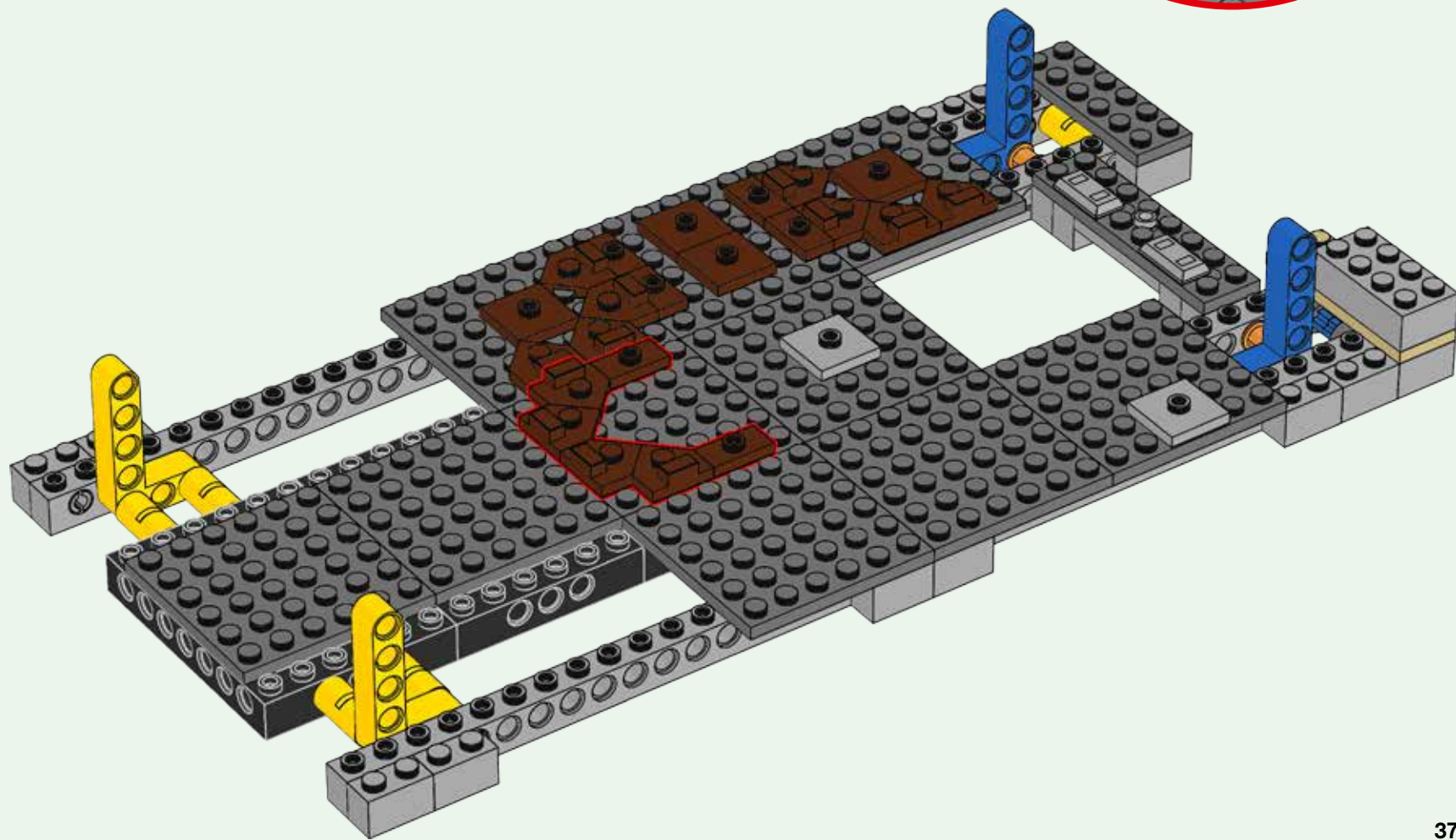
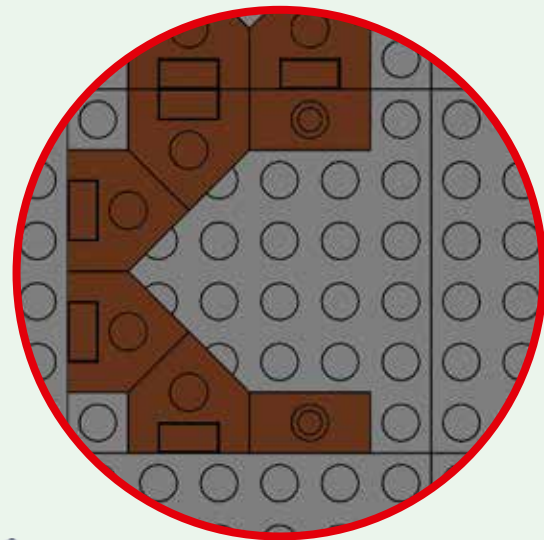



30

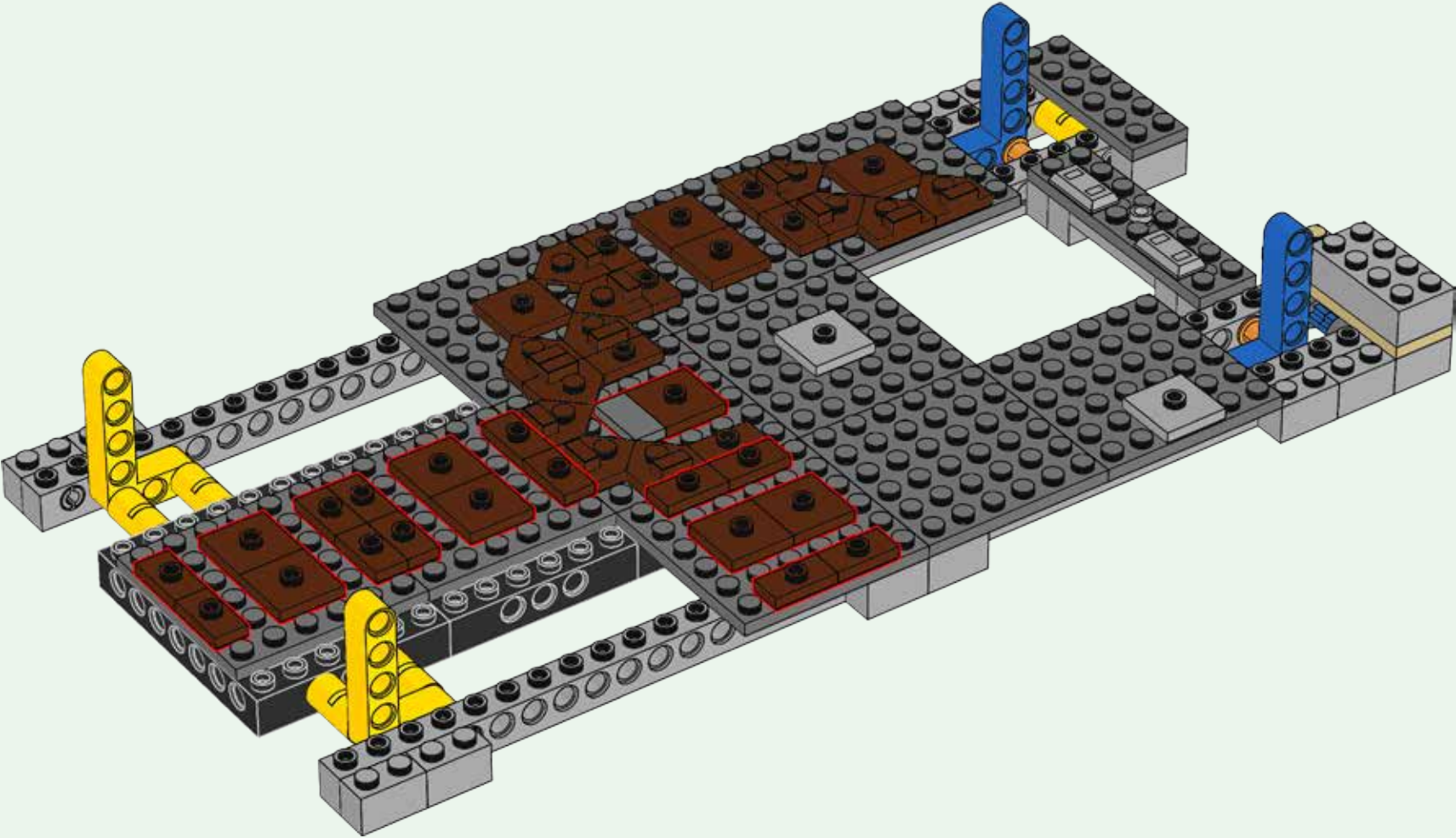

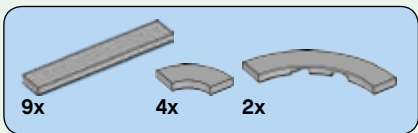

31

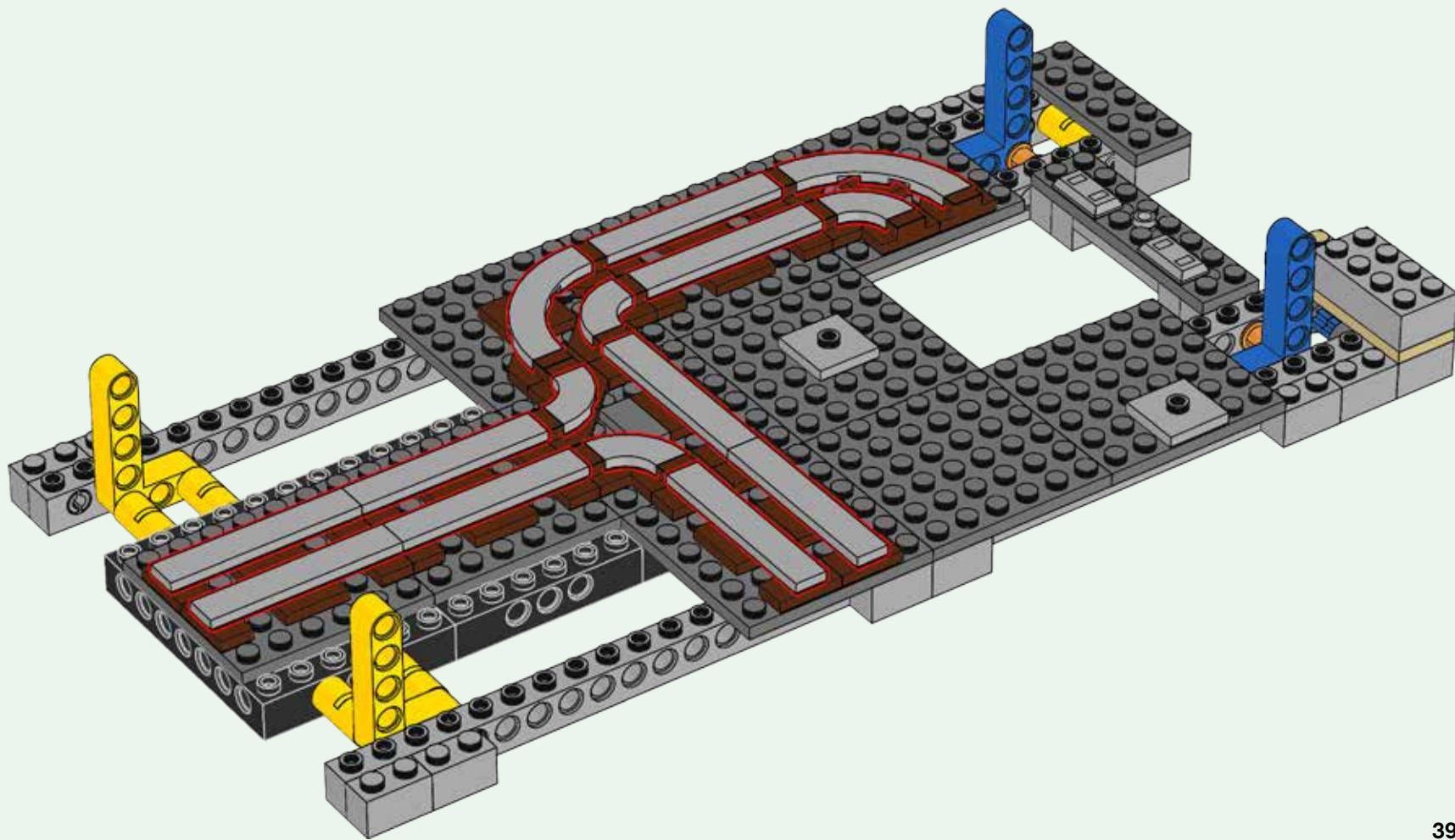

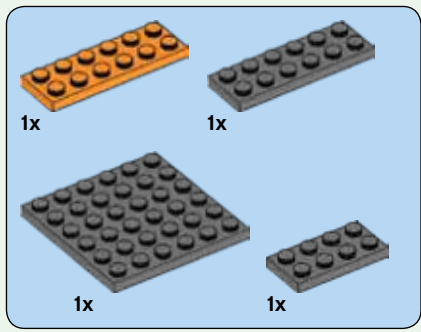

32

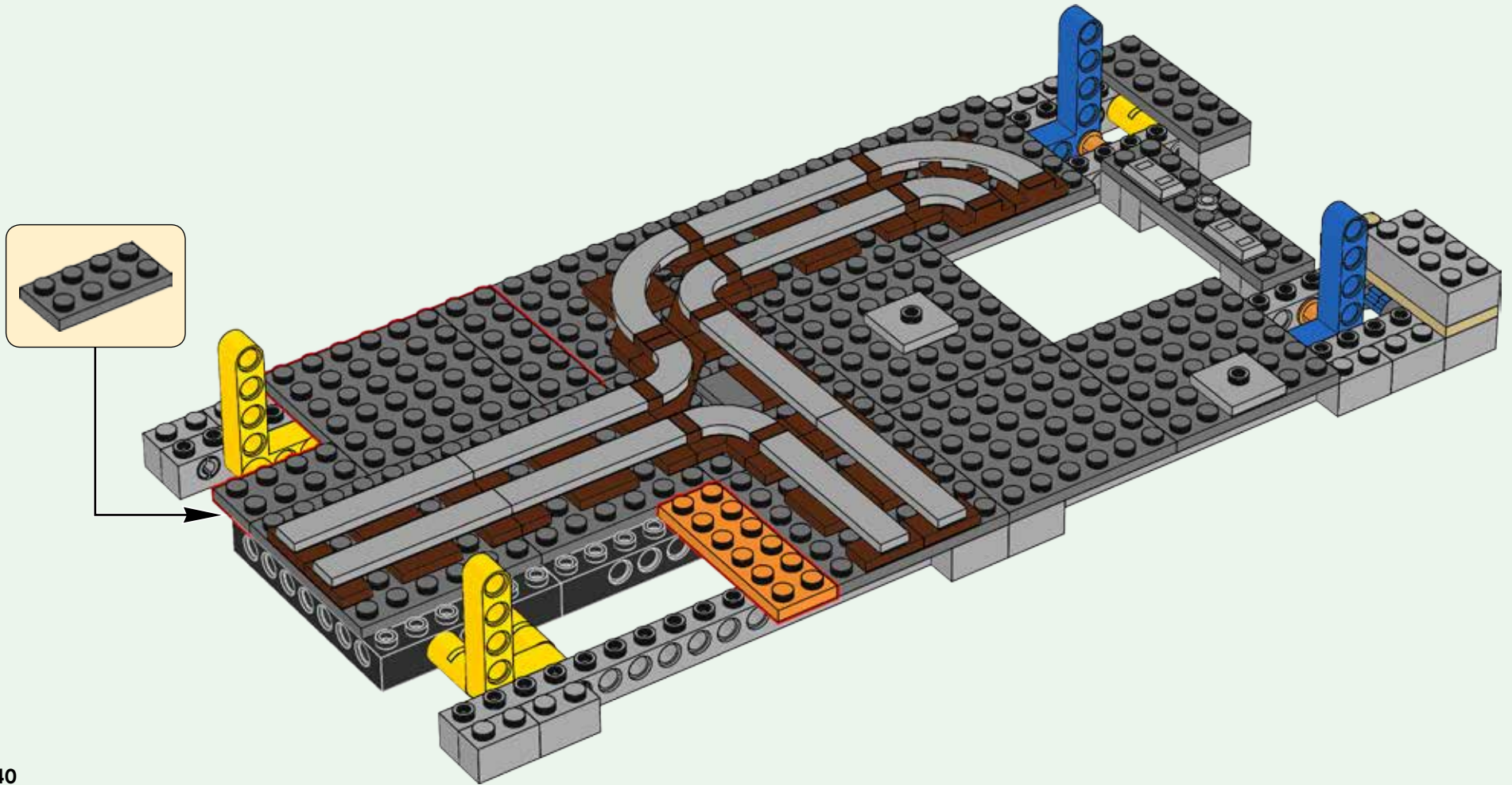

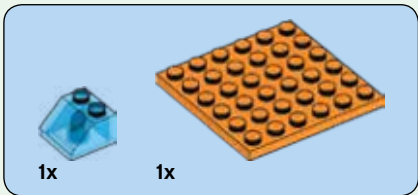
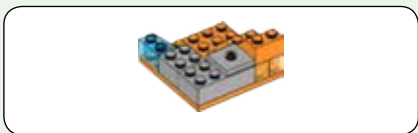

33

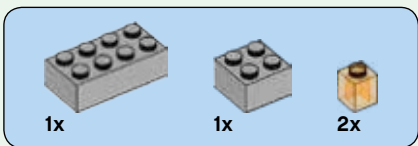

34



35



36

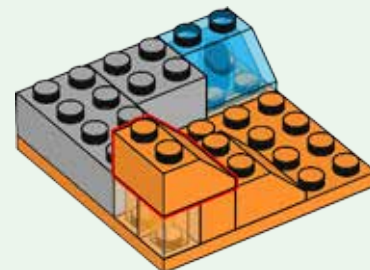

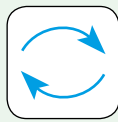

37

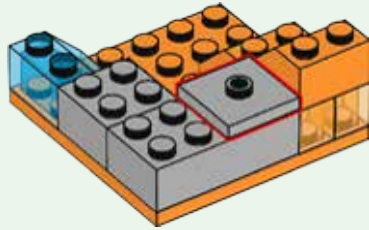

38

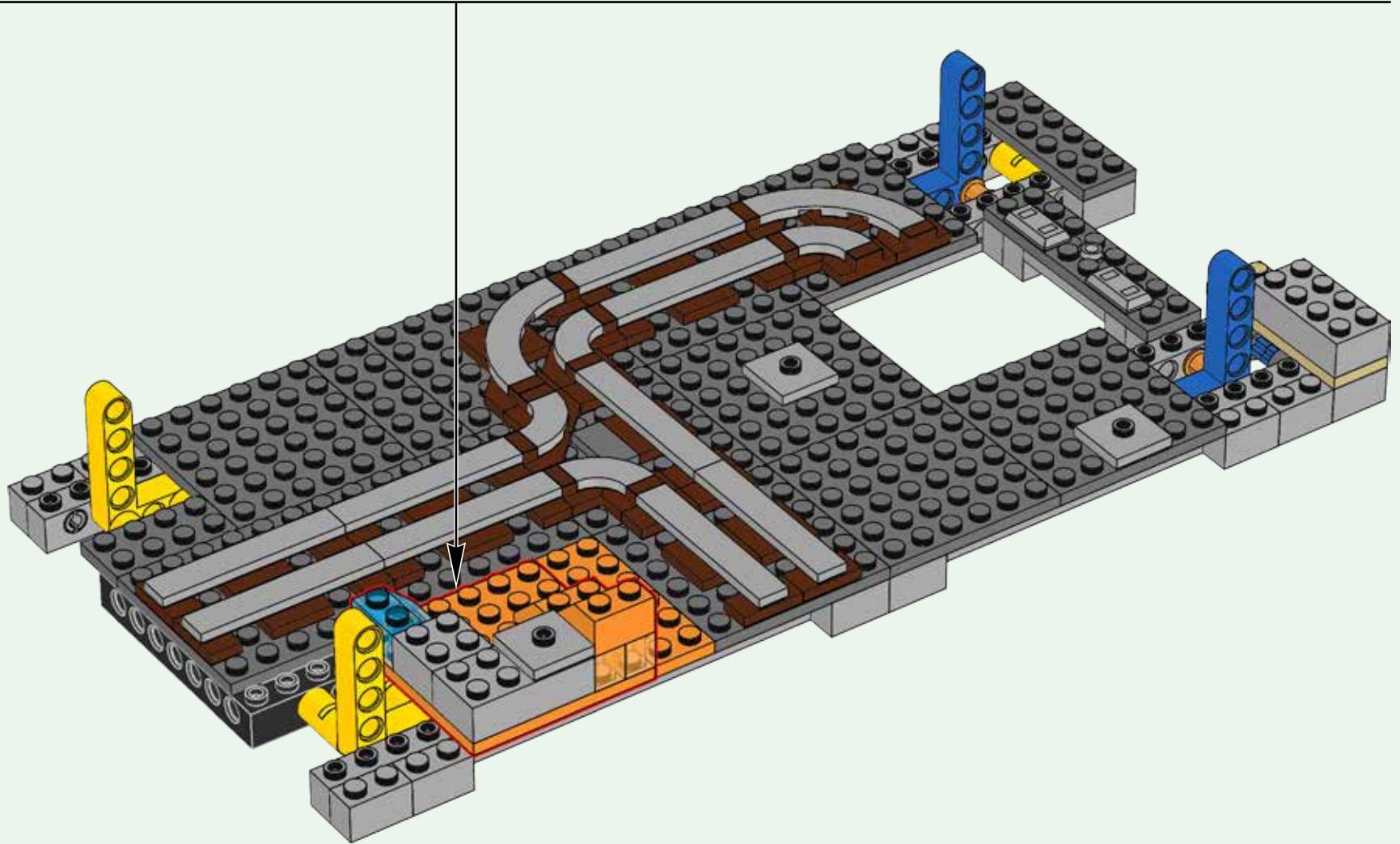



39

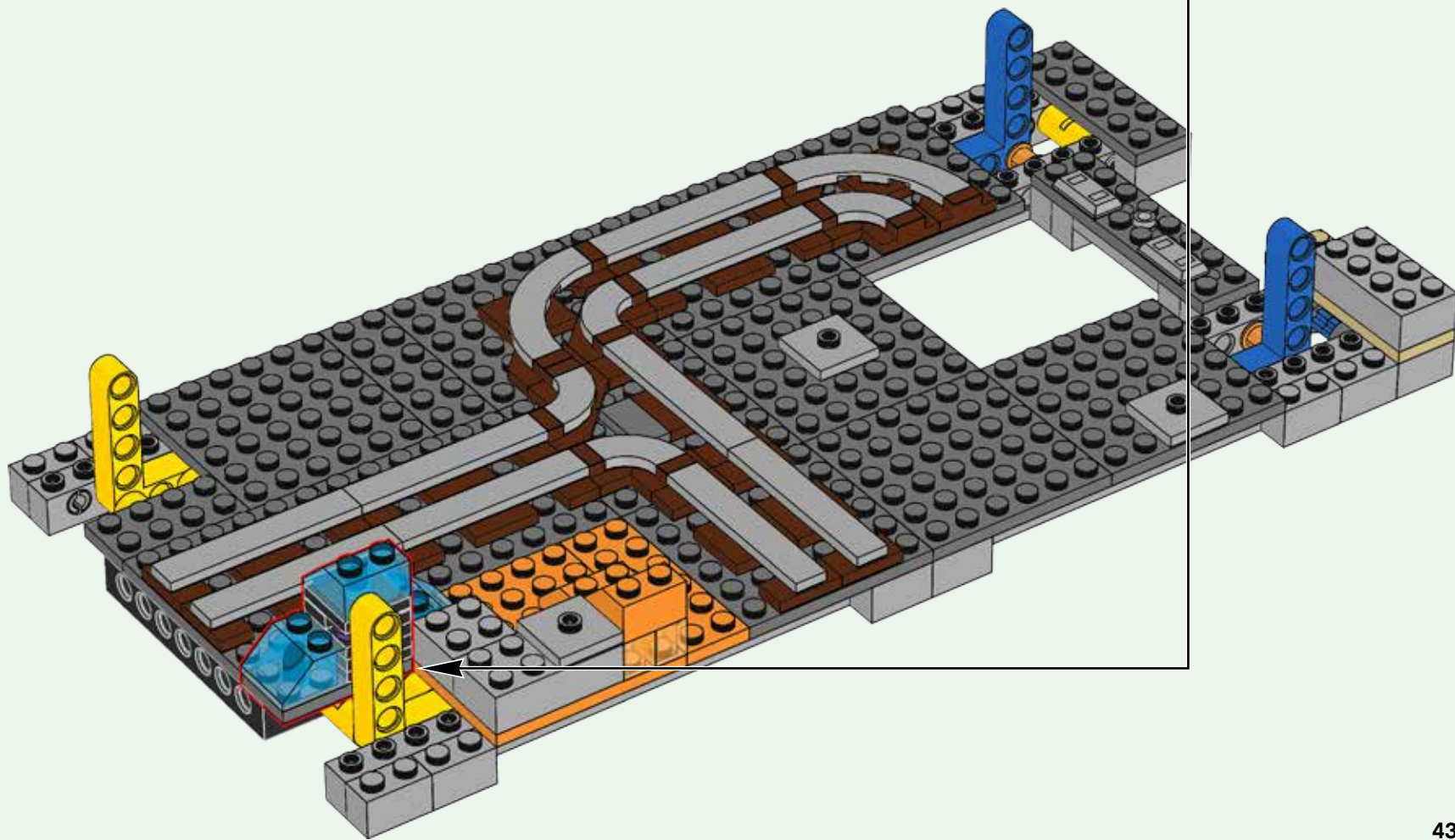

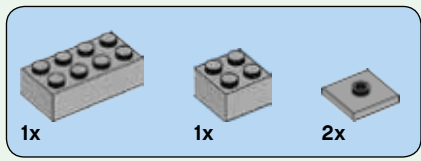

40

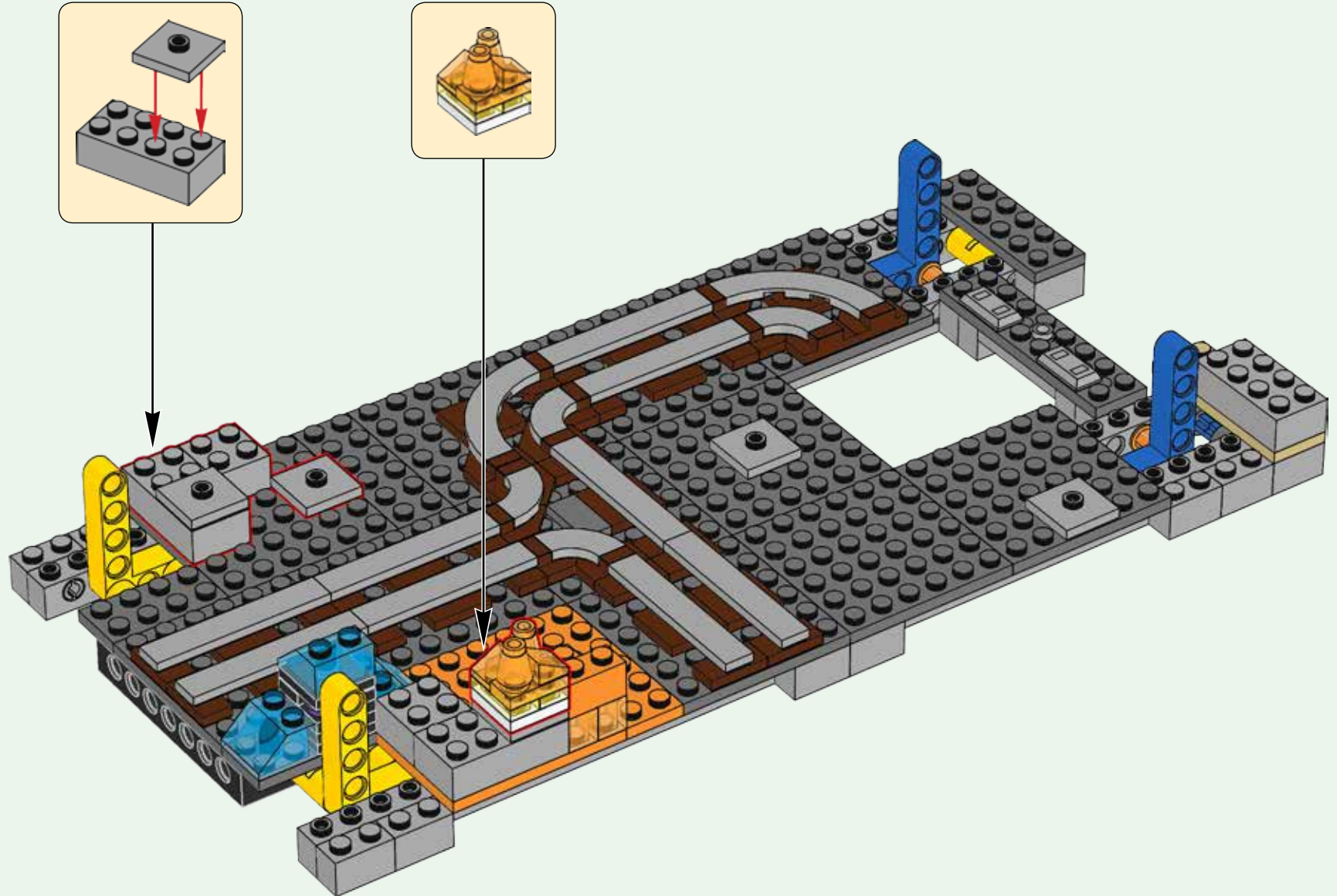

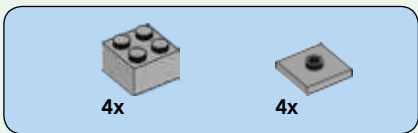

41

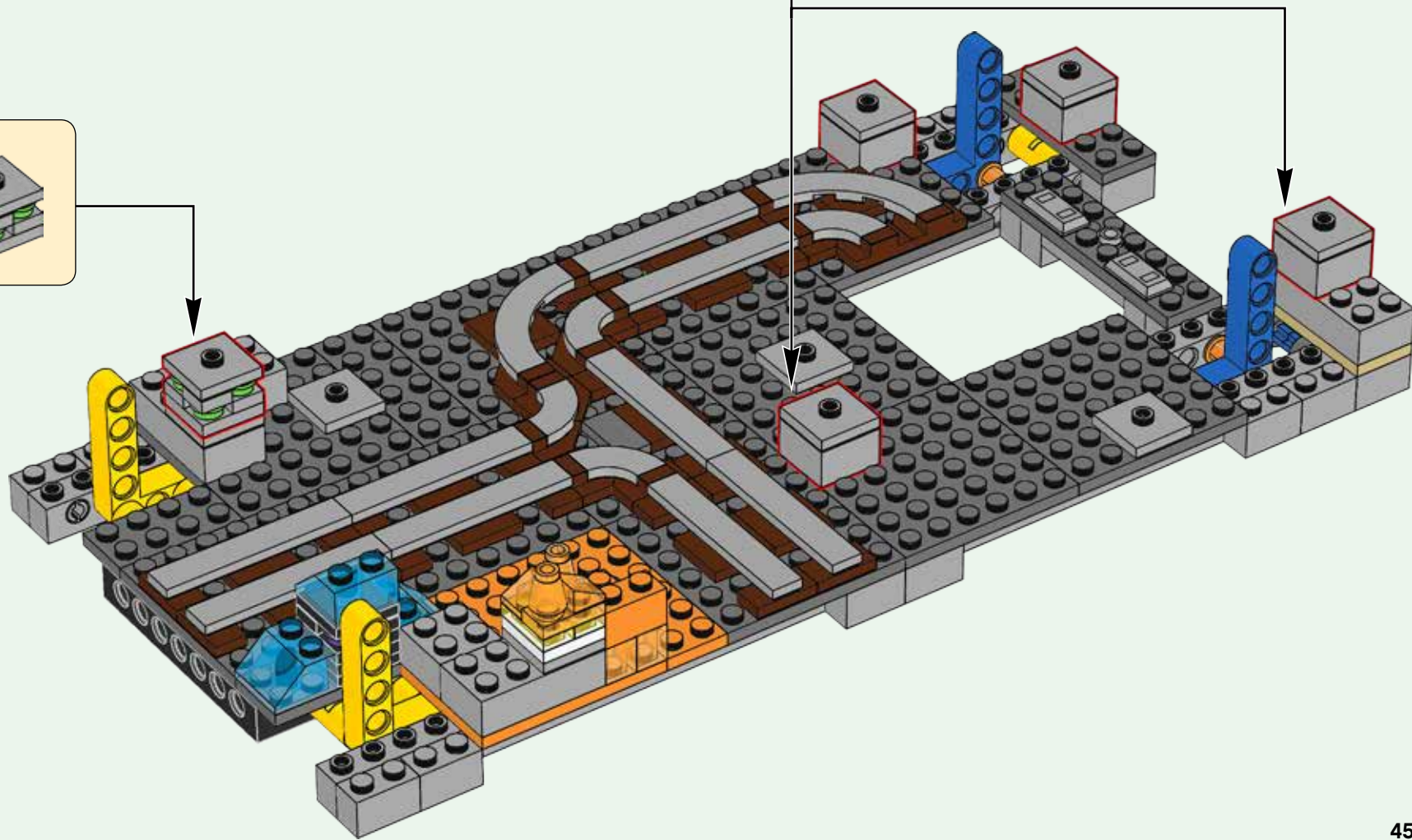
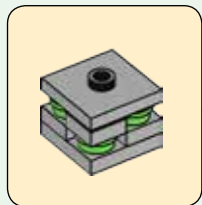
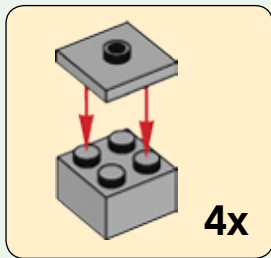



4

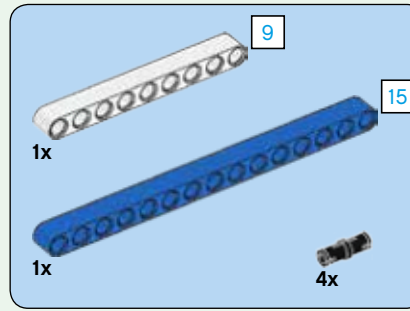
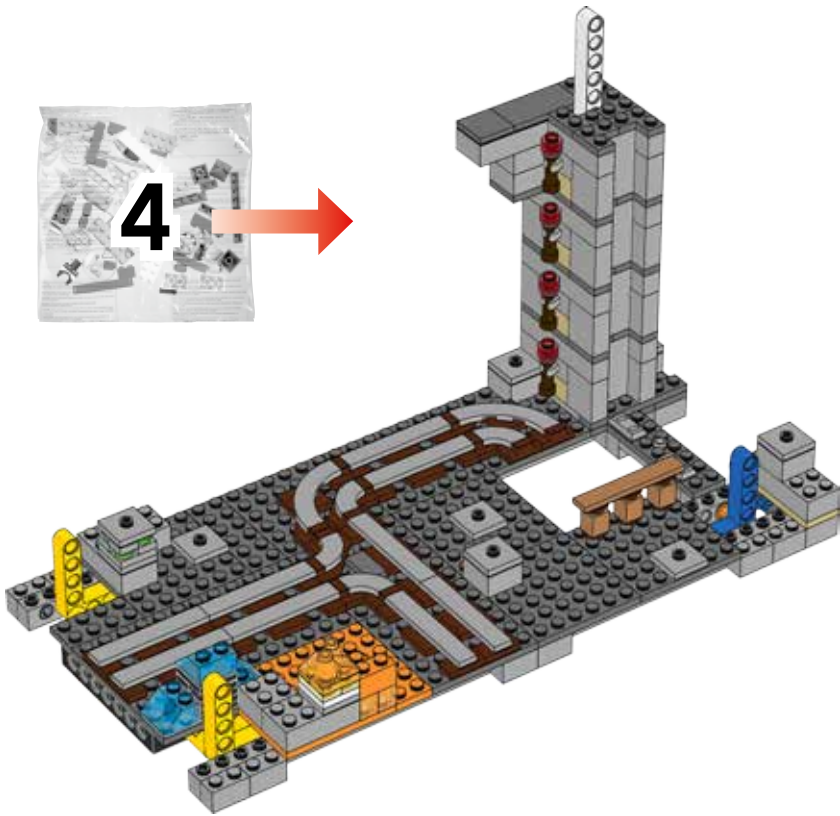

42

1

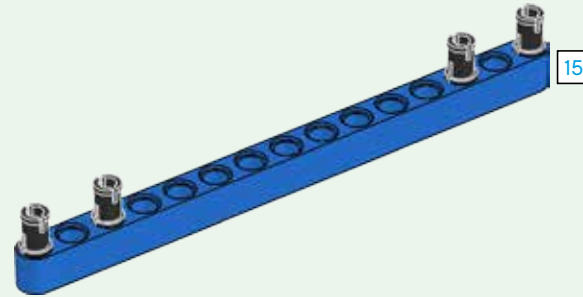

2

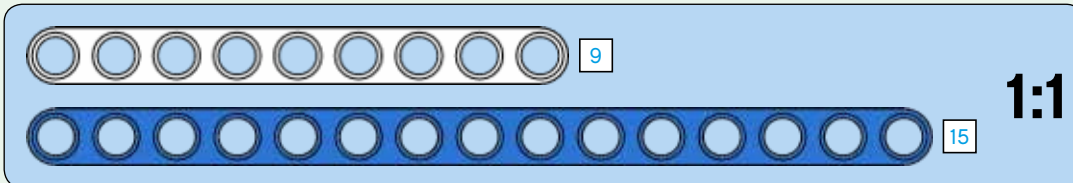
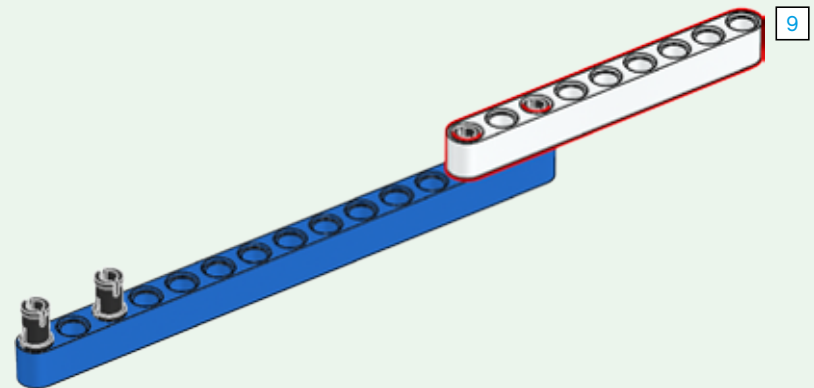

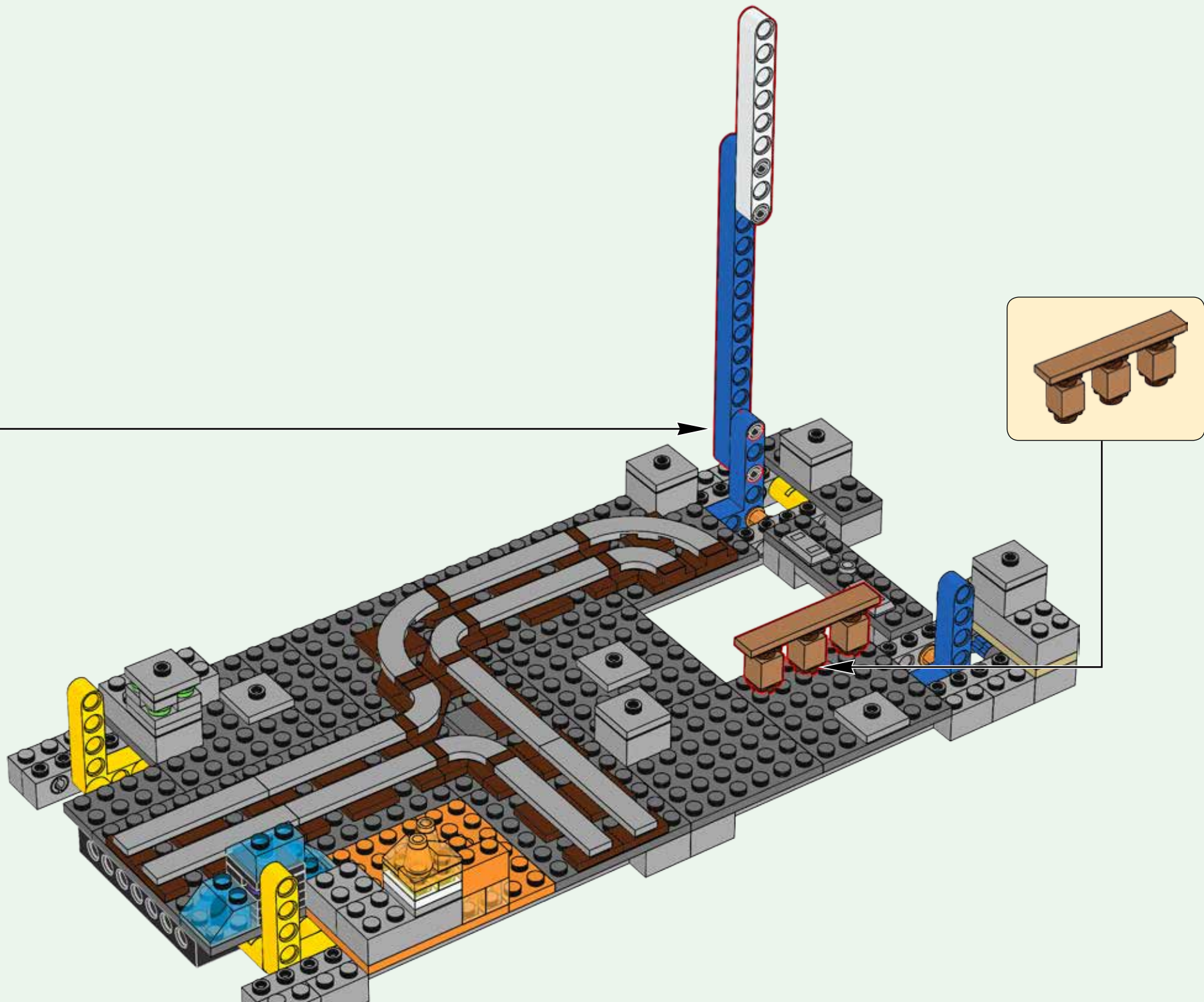

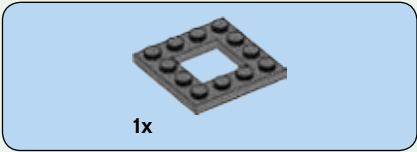
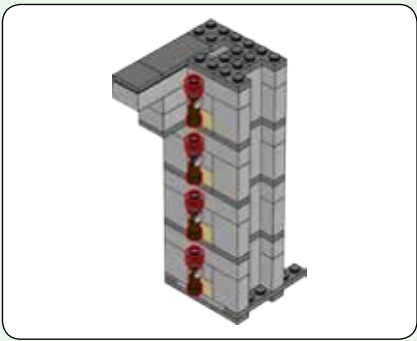

43

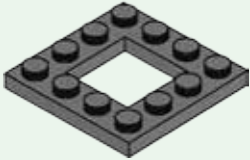

44

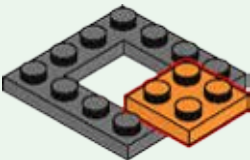

45

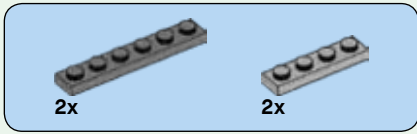
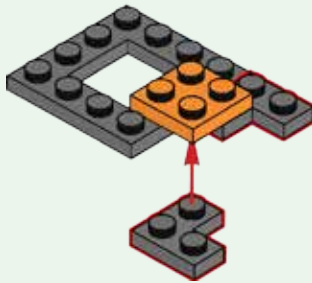

46

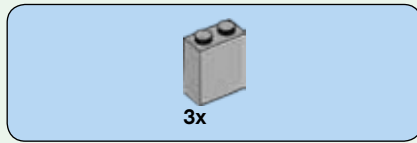
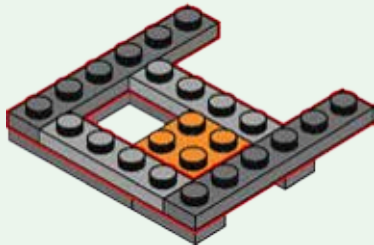

47

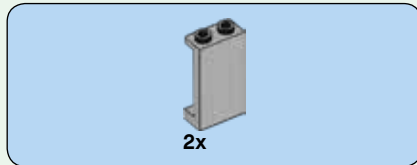
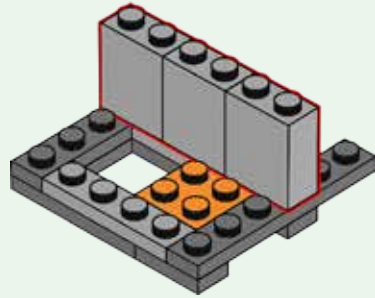

48

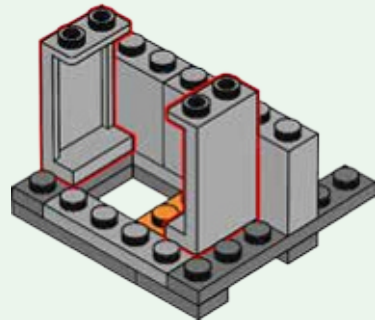

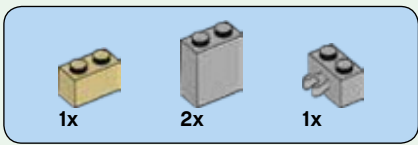

49

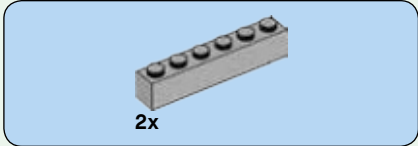
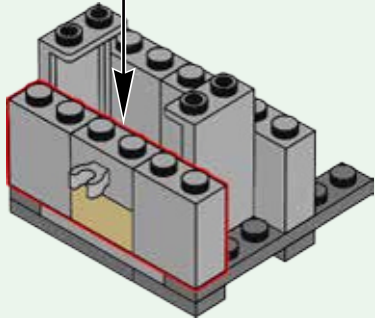
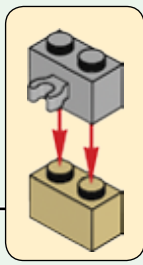

50

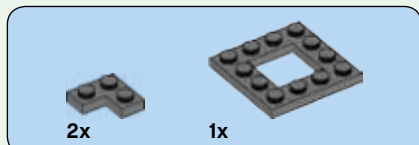
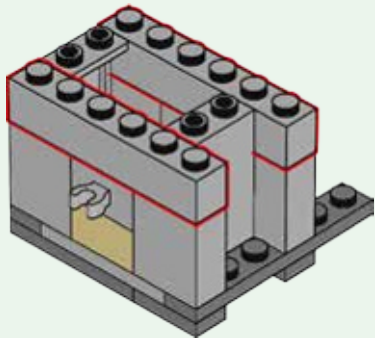

51

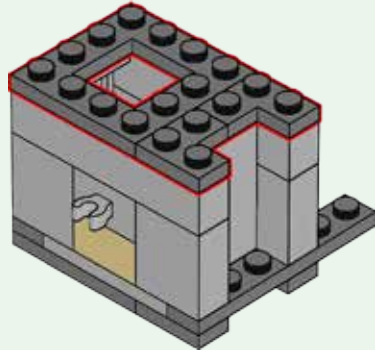

52

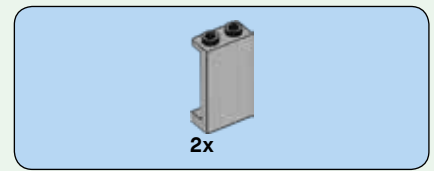
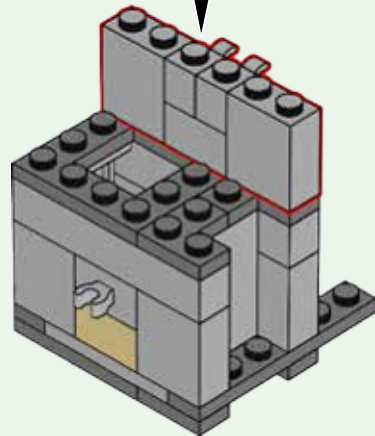
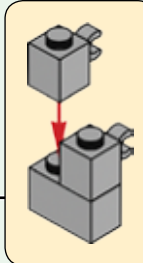

53

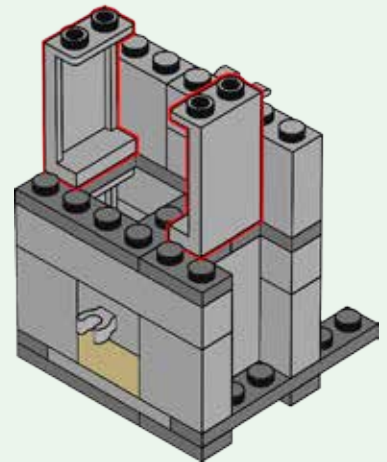

54

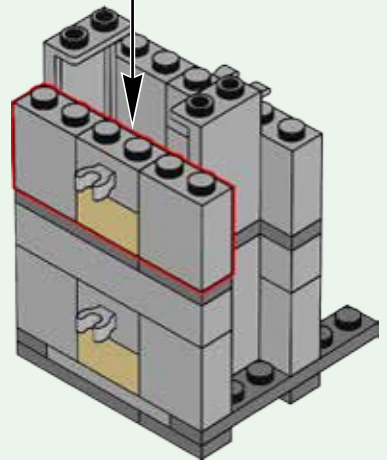
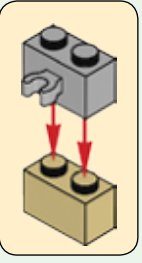

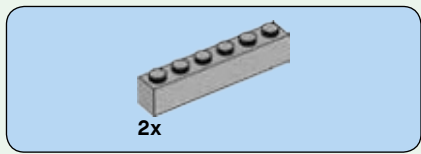

55

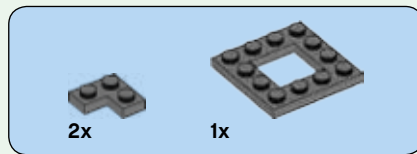
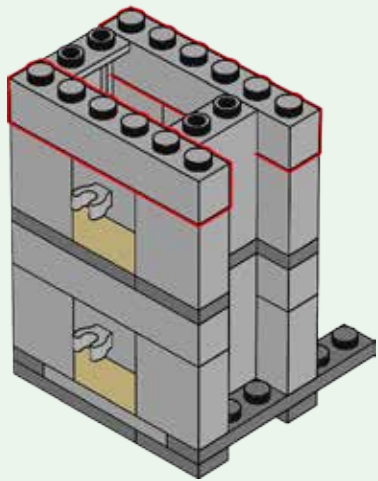

56

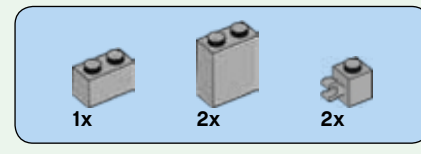
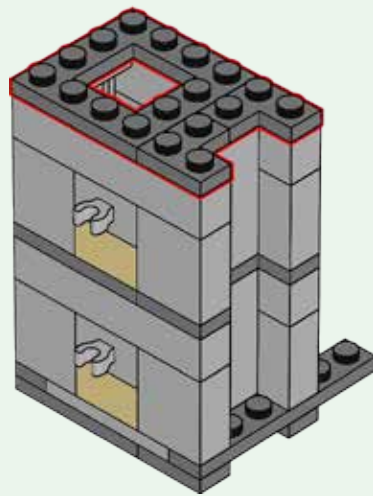

57

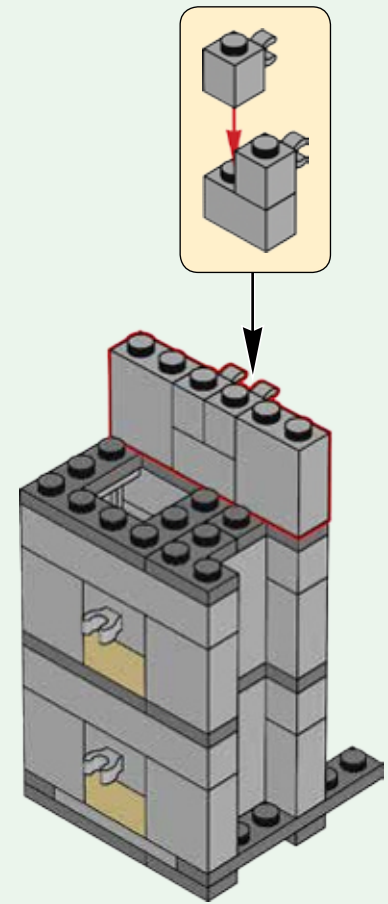

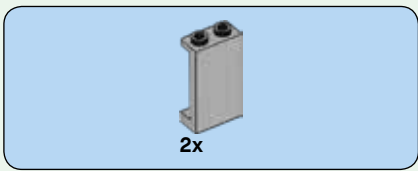

58

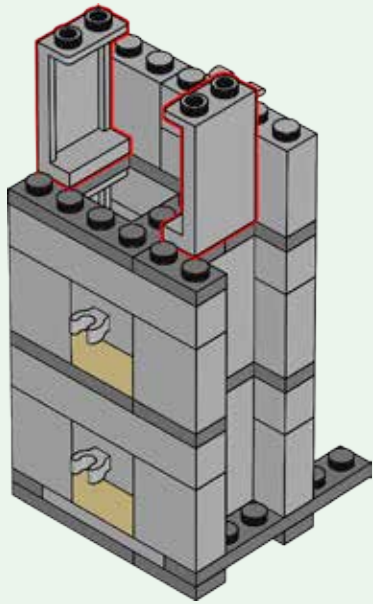

59

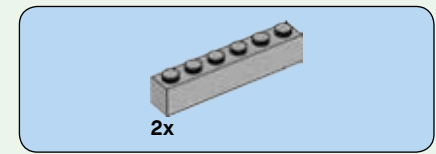
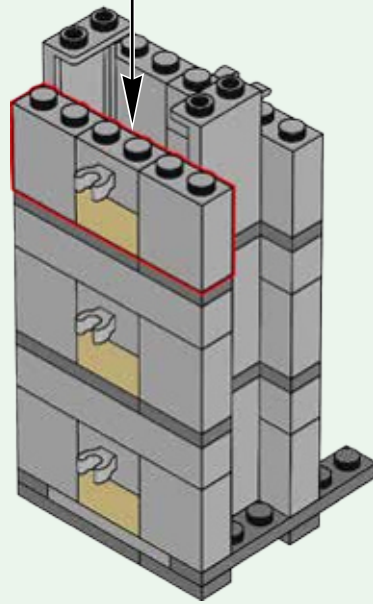
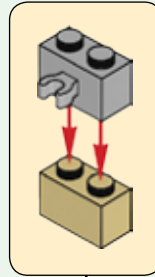

60

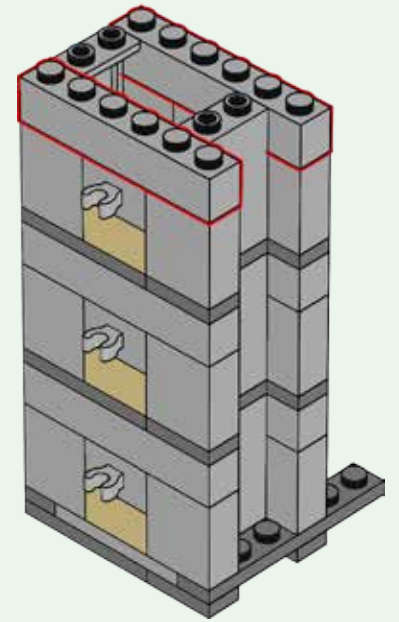

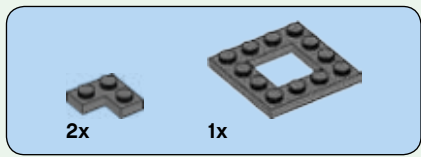

61

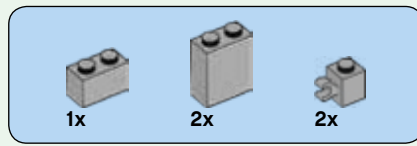
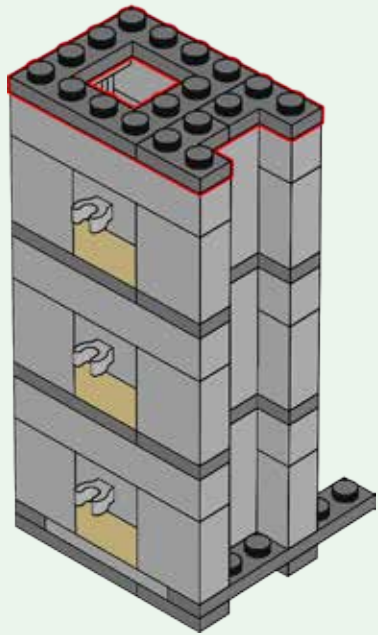

62

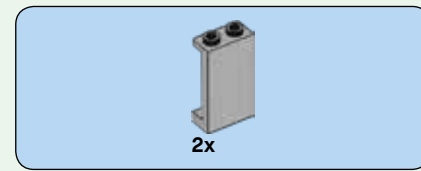
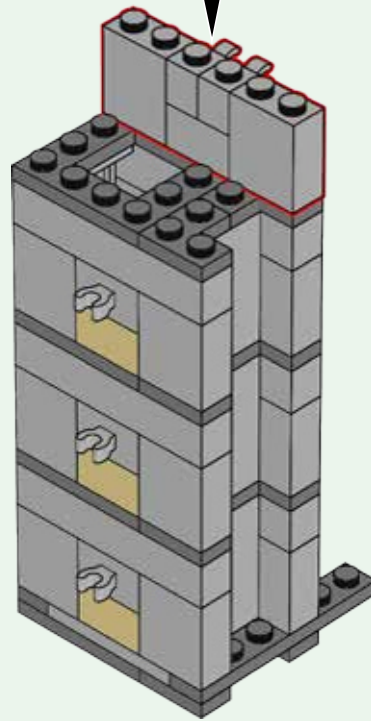
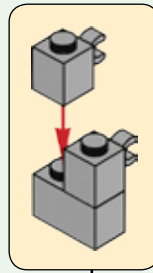

63

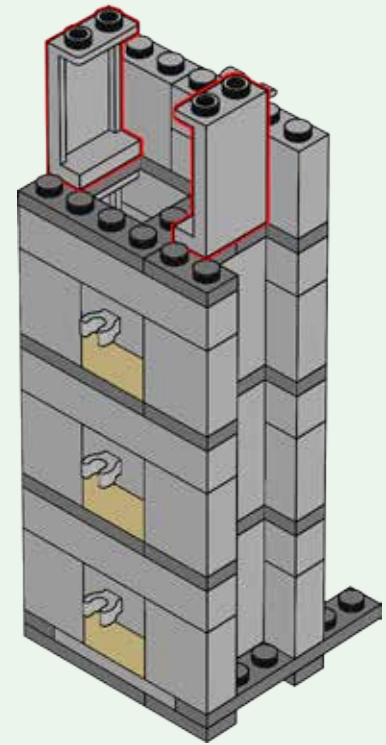

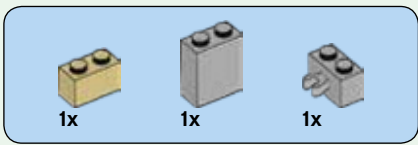

64

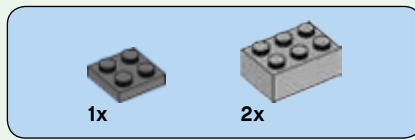
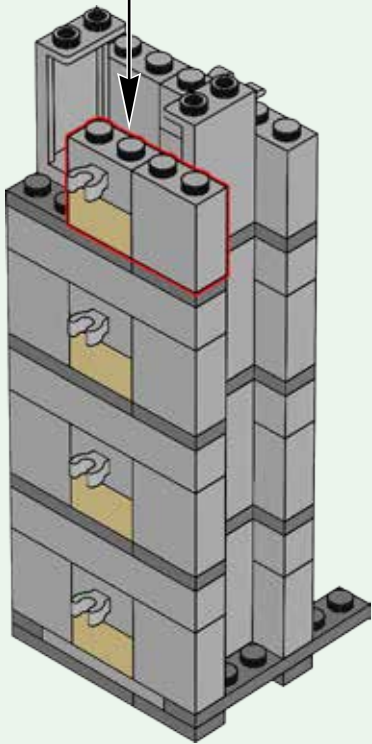
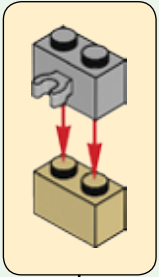

65

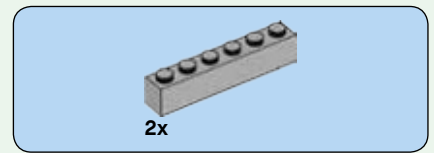
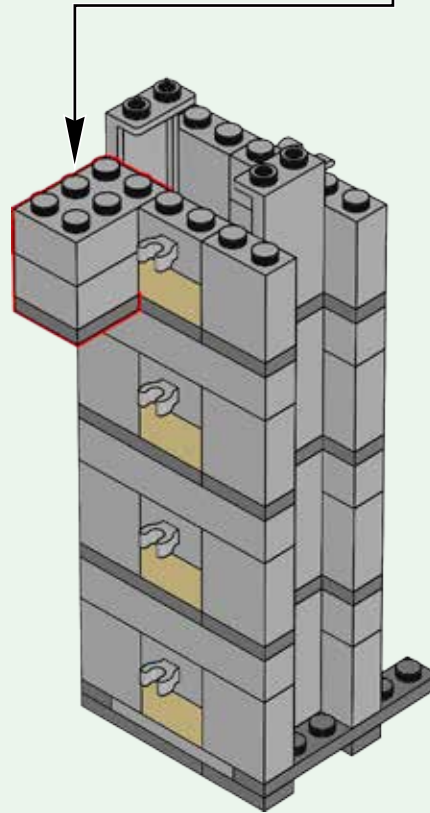
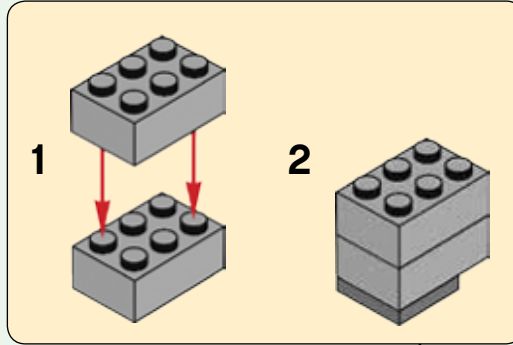

66

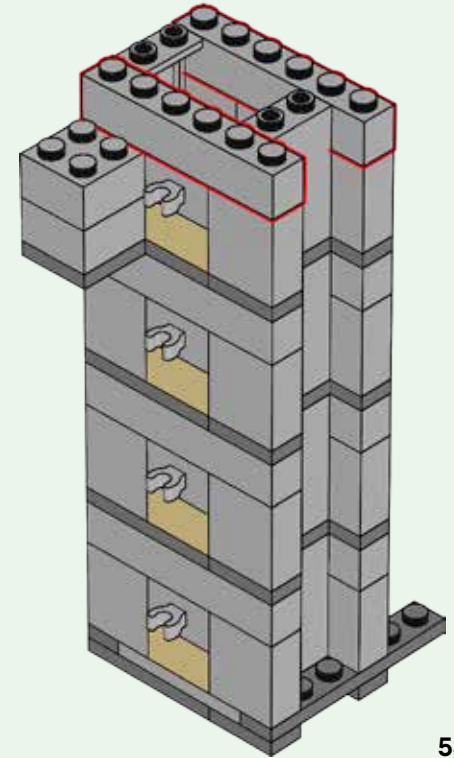

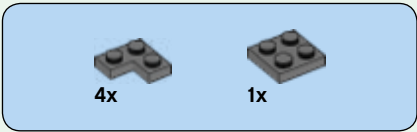

67

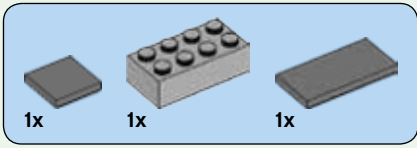
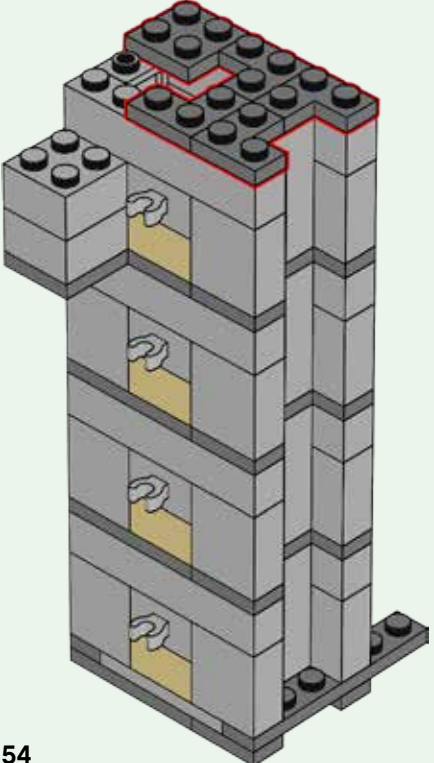

68

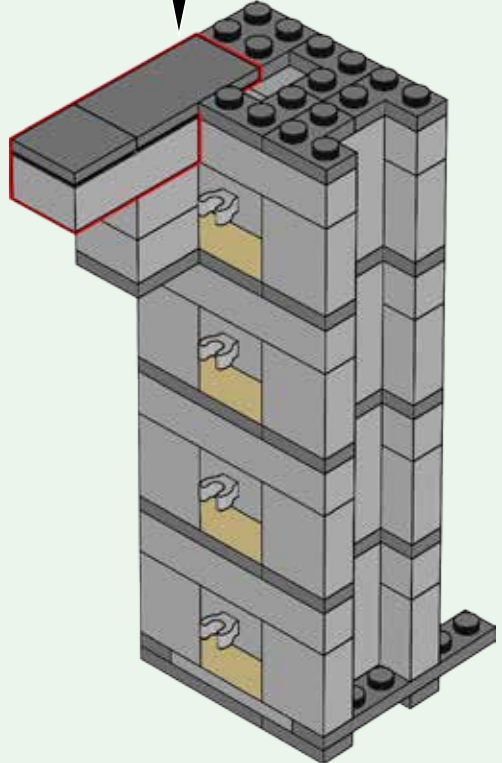
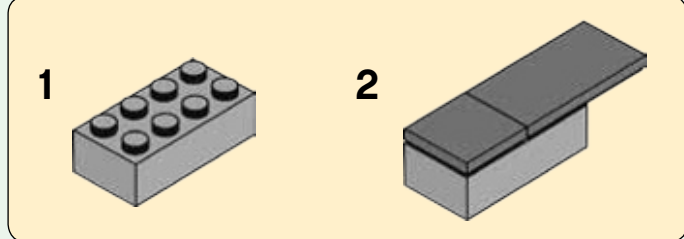

69

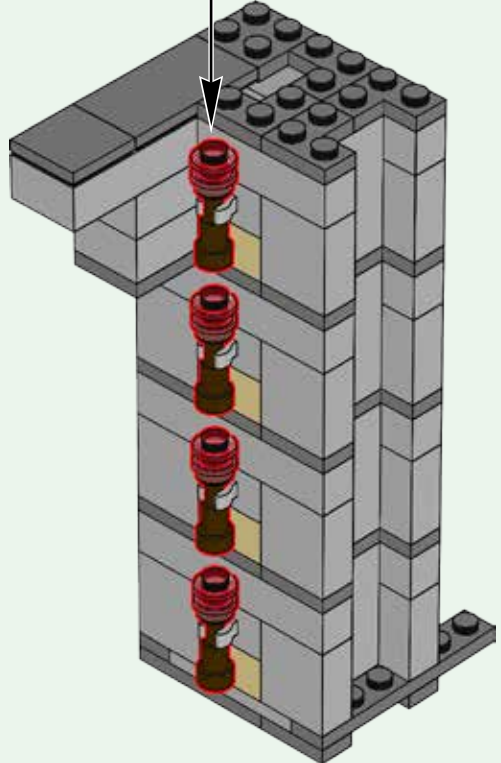

70

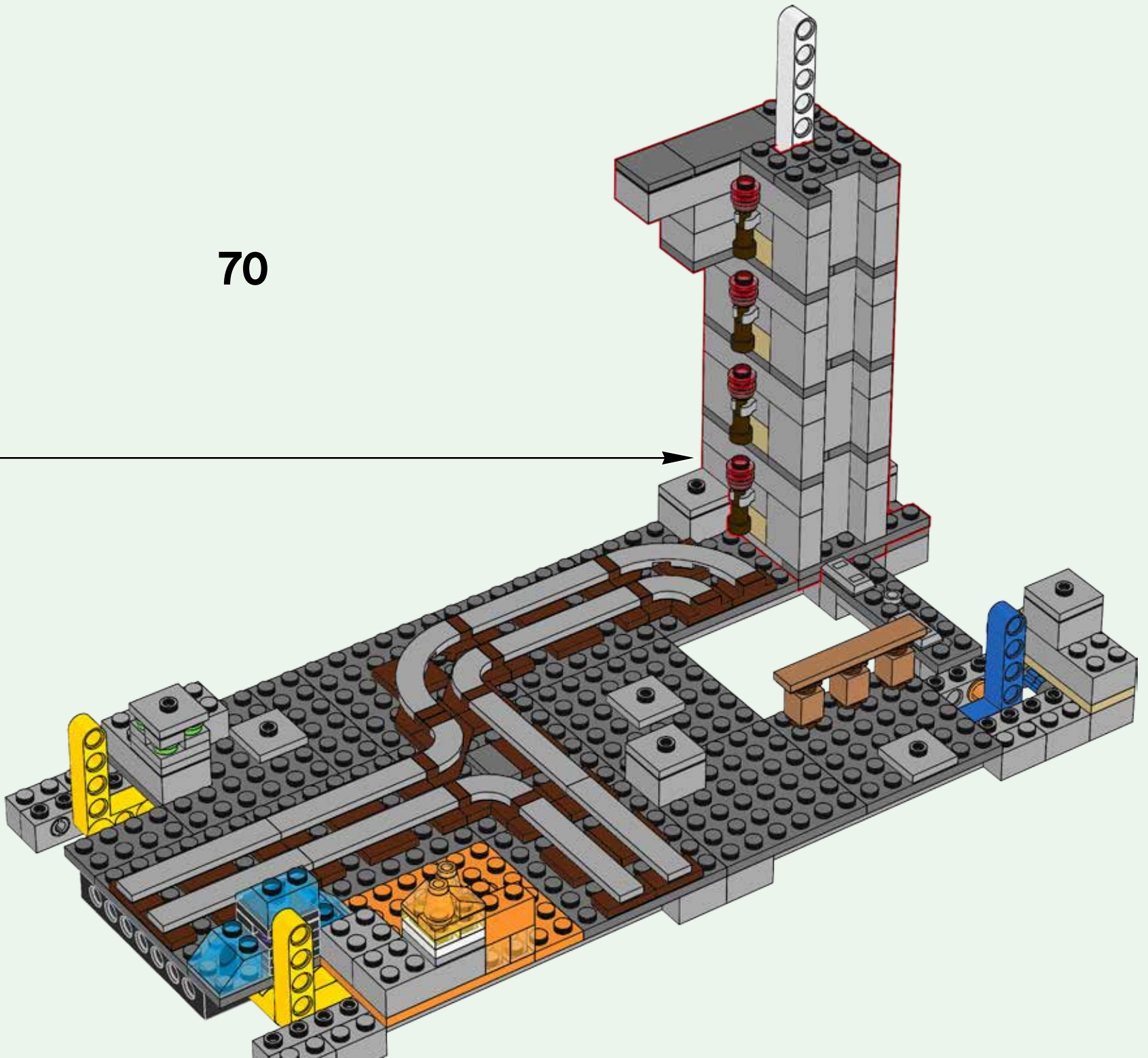

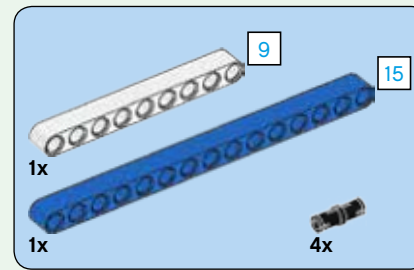
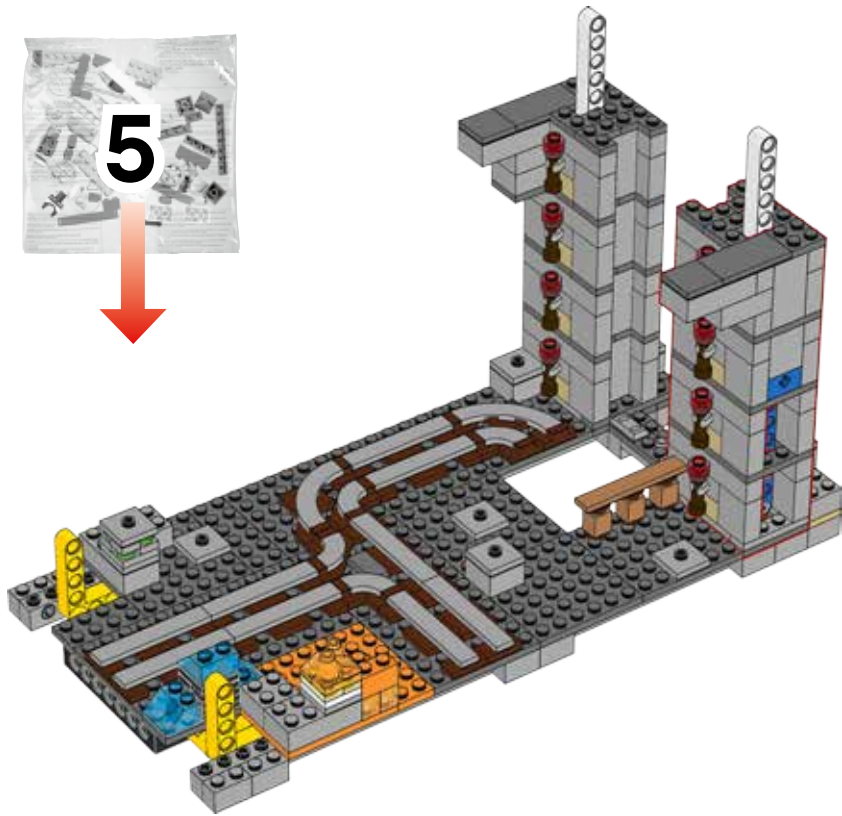

71

1

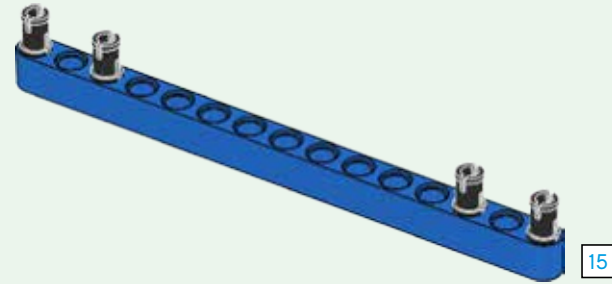

2

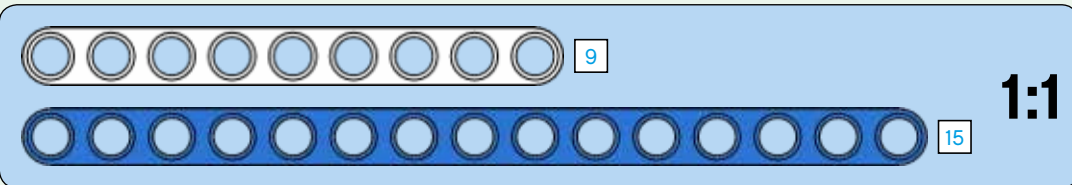
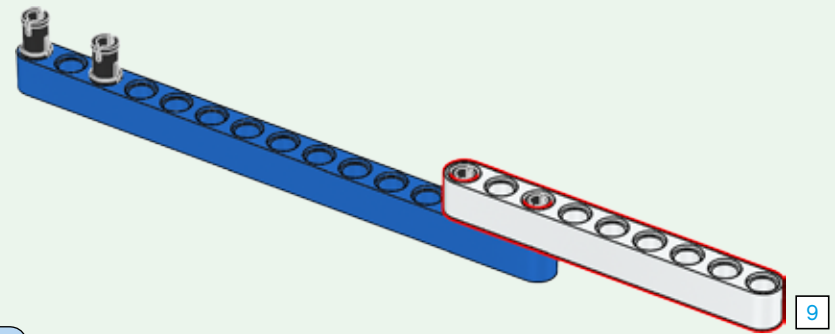

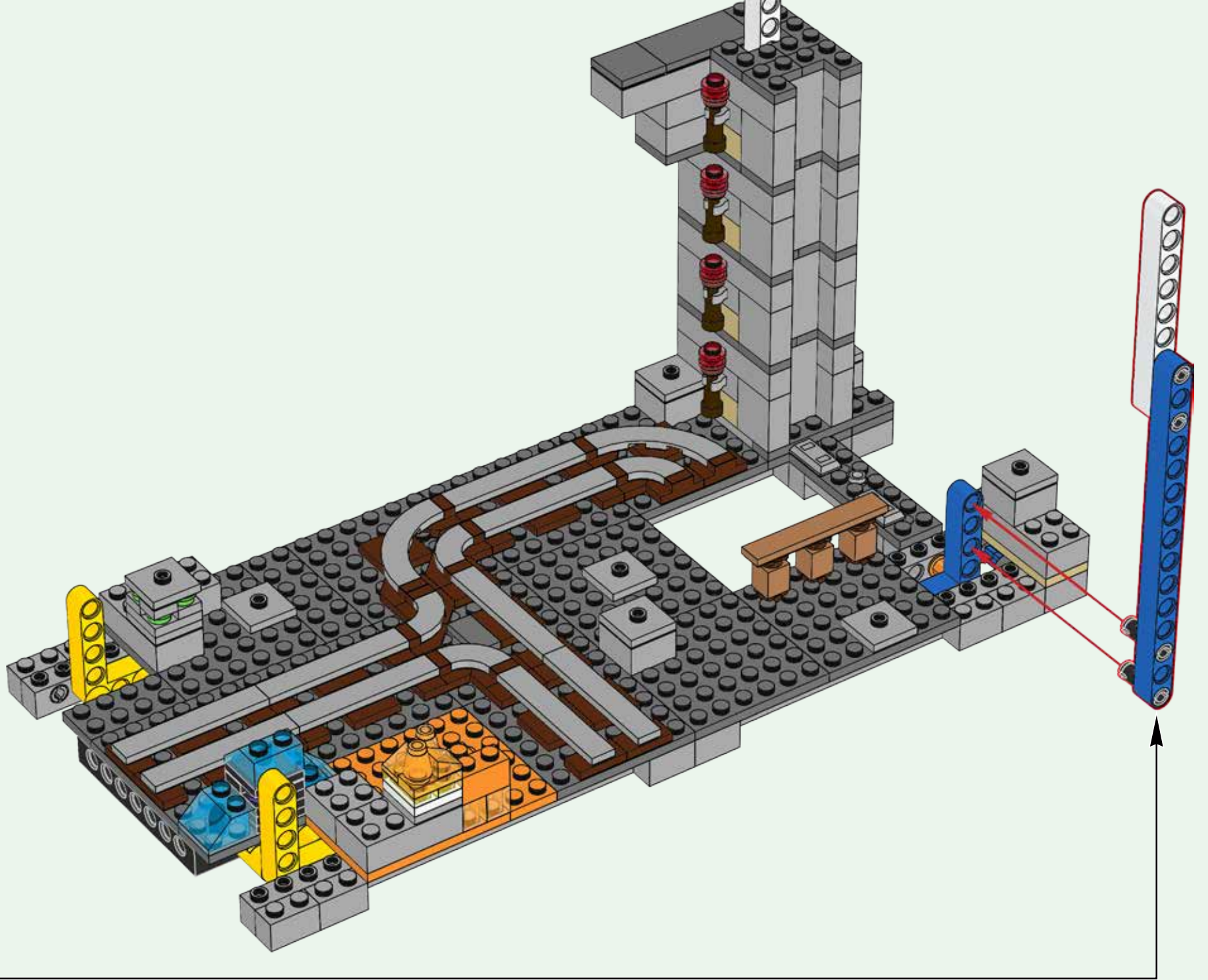

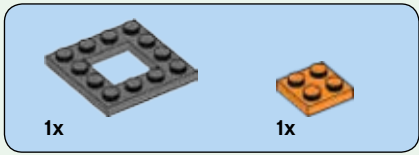
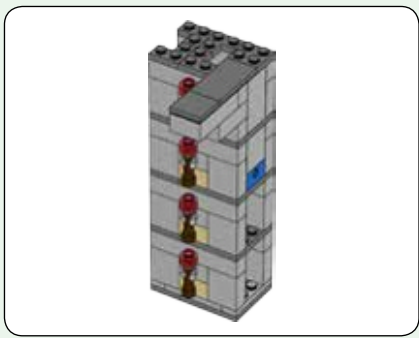

72

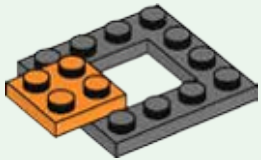

73

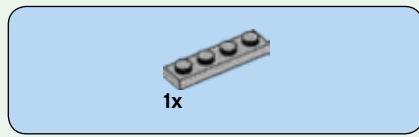
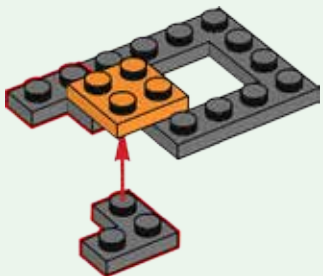

74

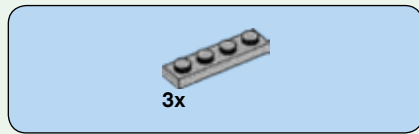
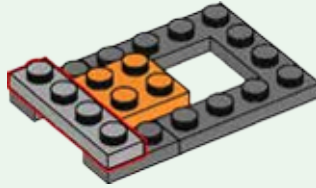

75

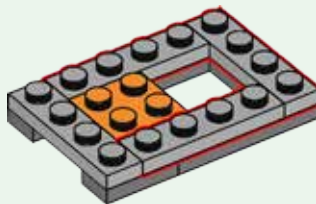

76

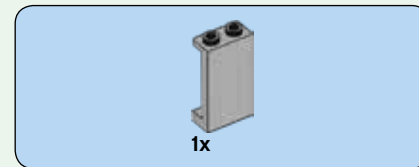
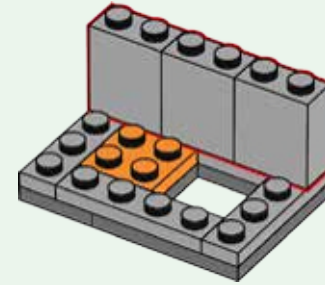

77

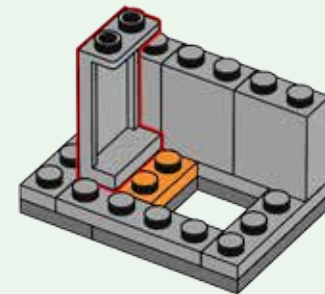

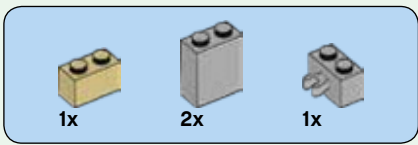

78

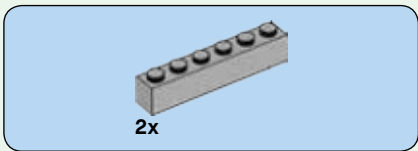
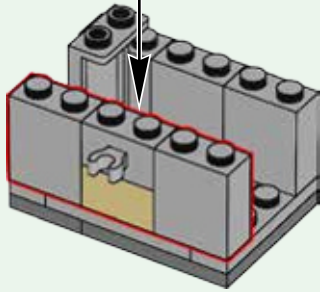
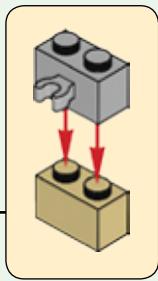

79

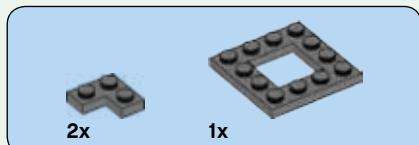
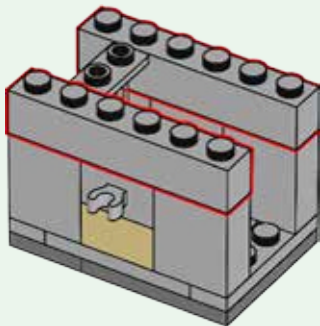

80

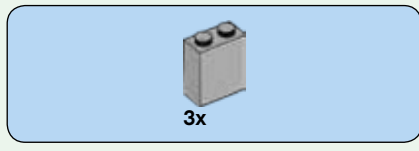
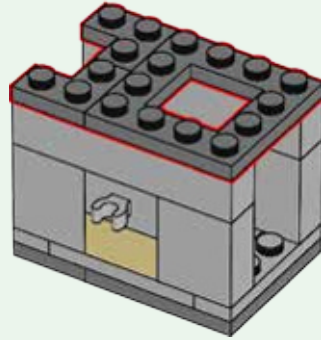

81

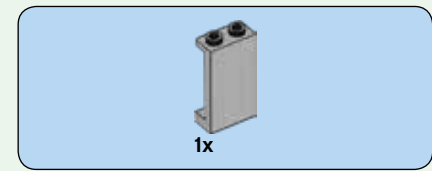
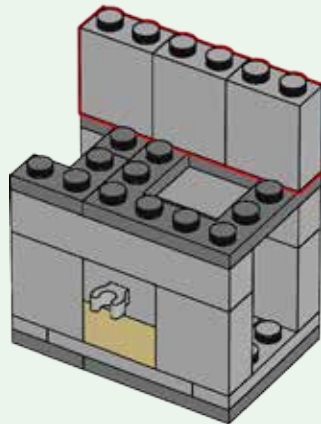

82

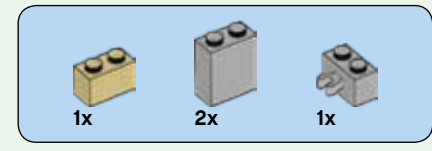
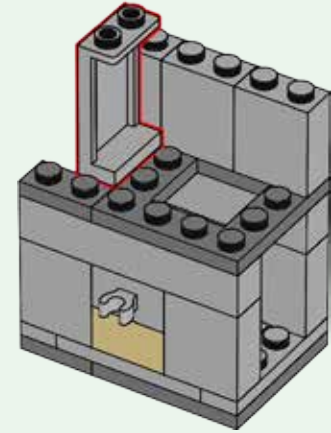

83

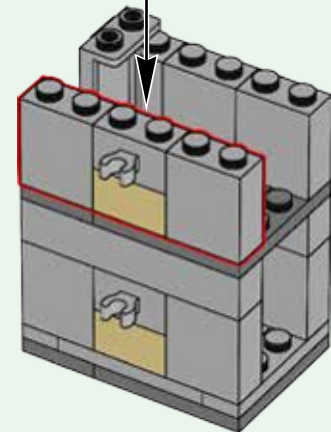
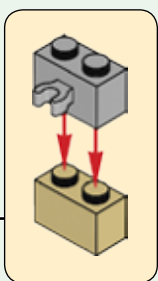

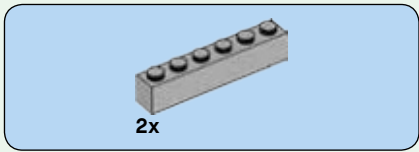

84

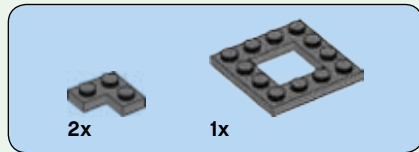
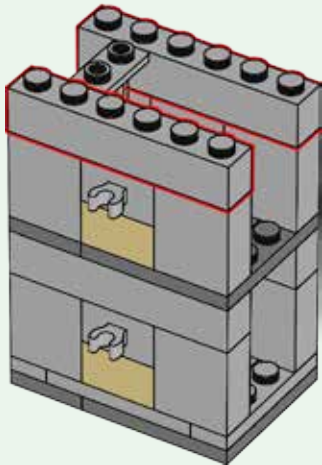

85

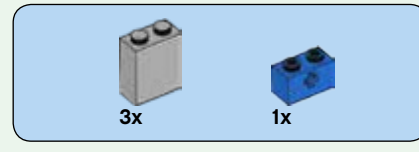
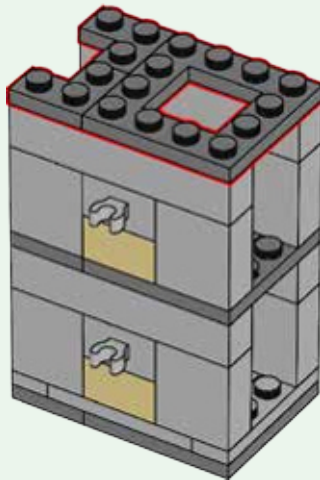

86

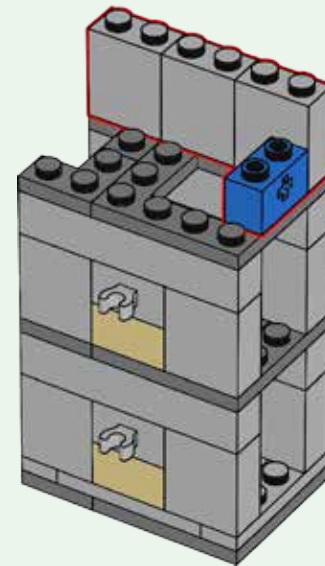

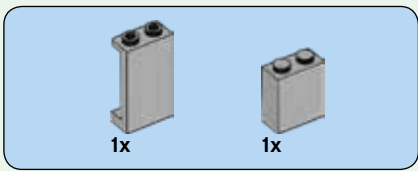

87

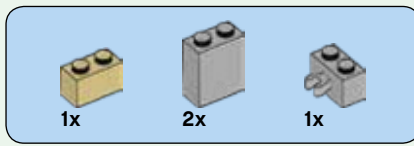
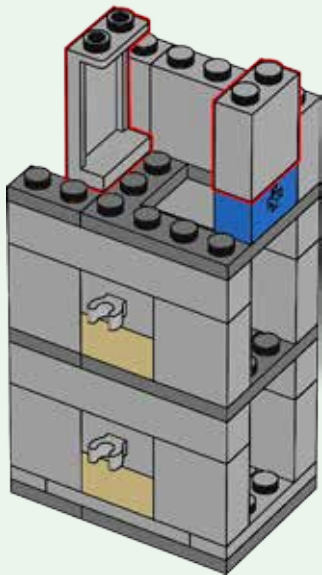

88

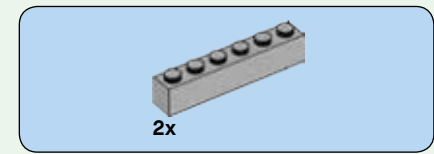
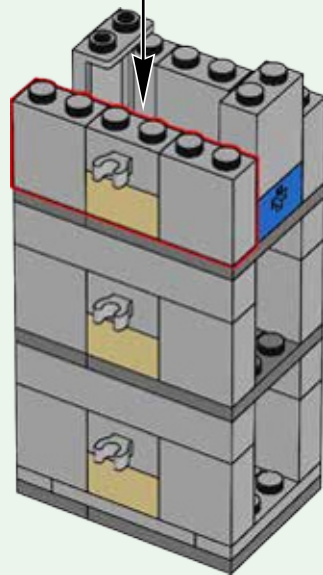
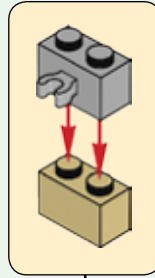

89

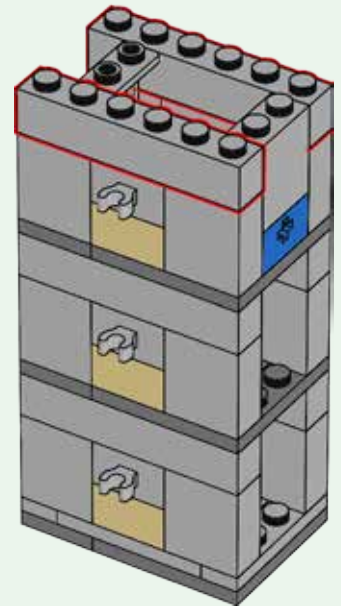

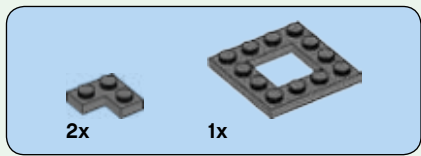

90

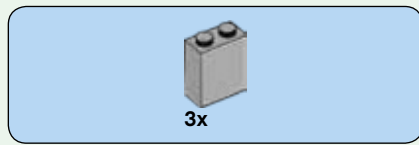
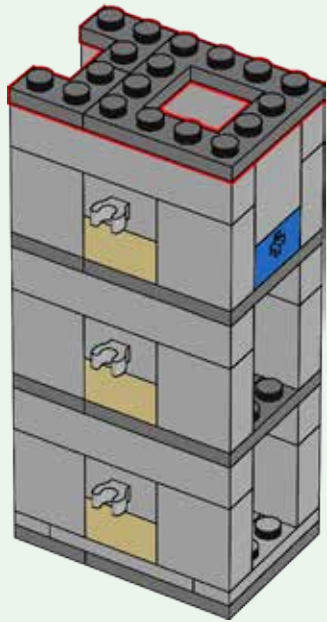

91

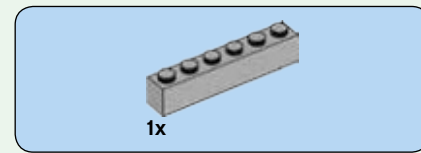
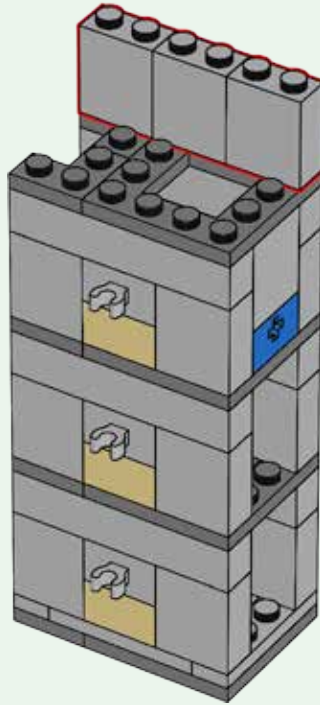

92

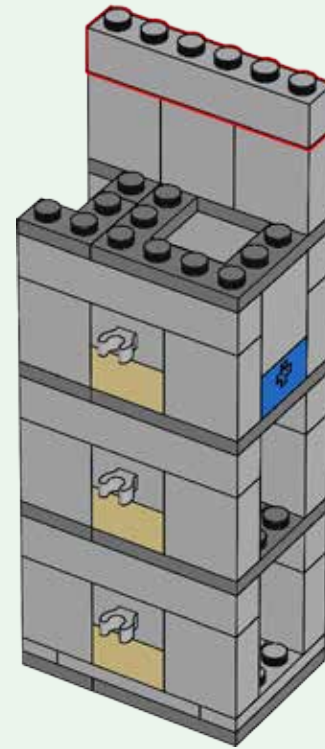

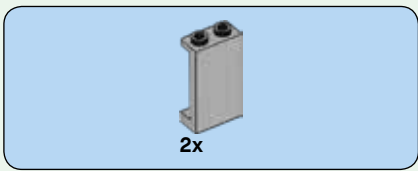

93

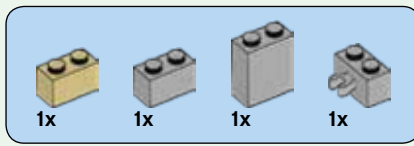
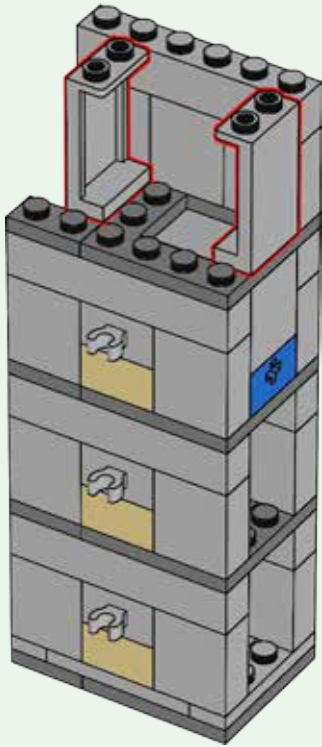

94

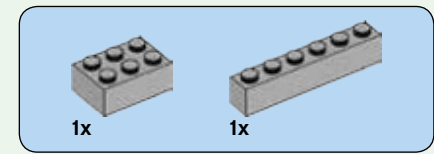
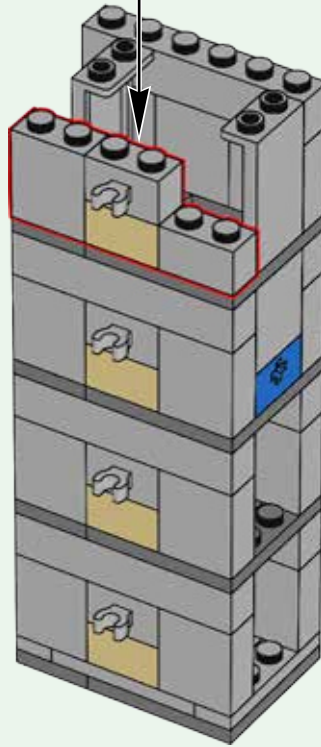
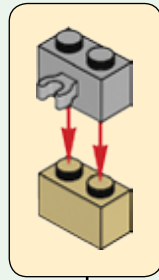

95

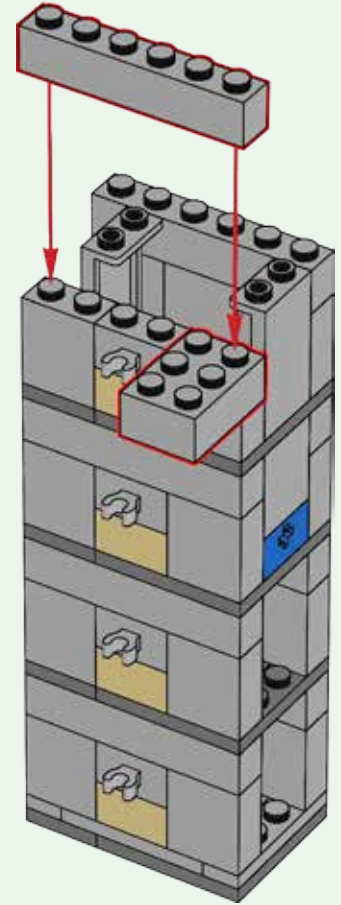

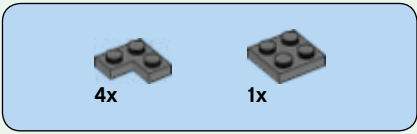

96

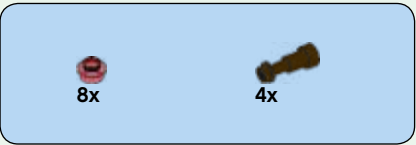
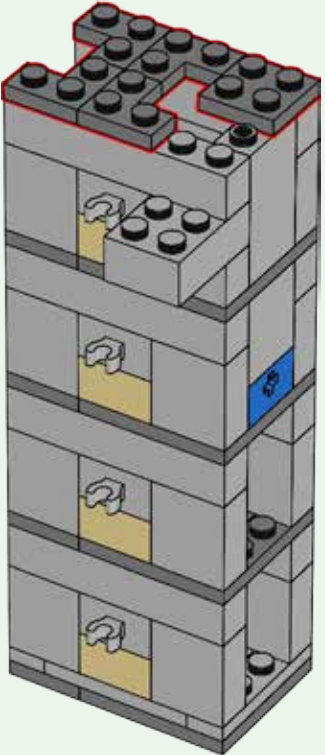

97

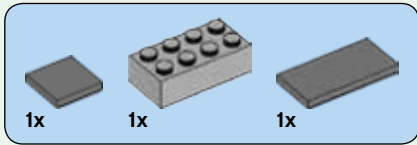
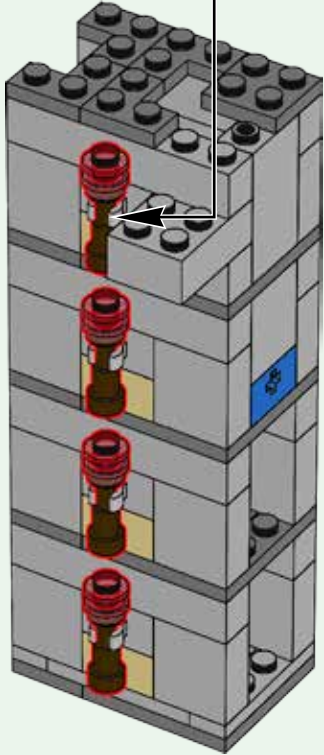
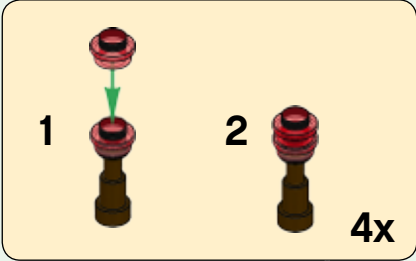

98

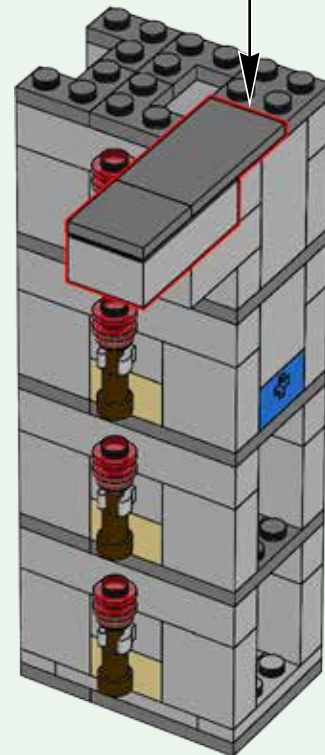
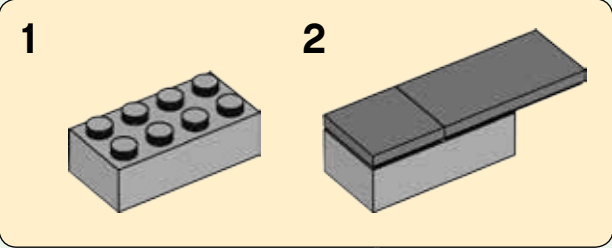

99

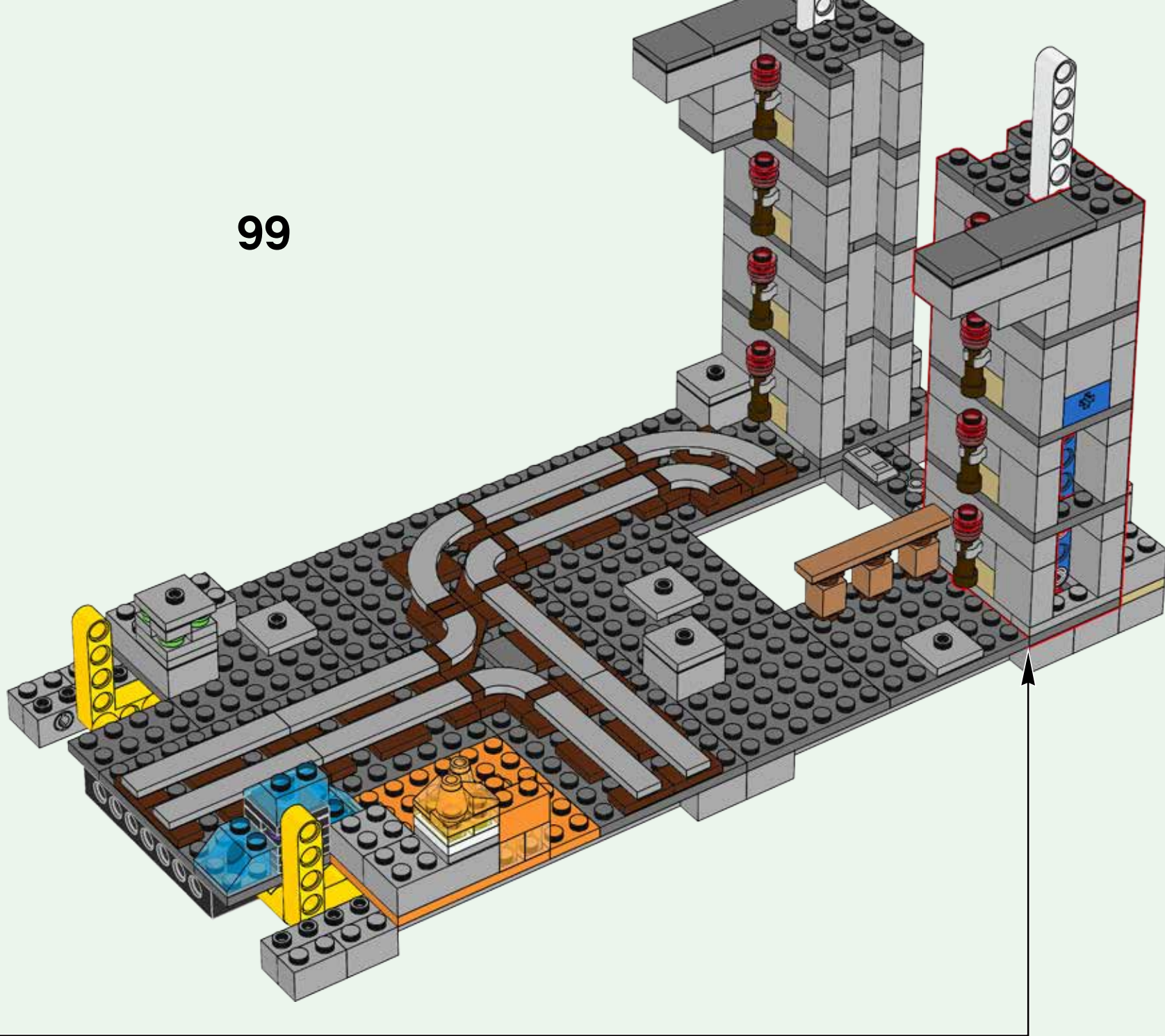



6

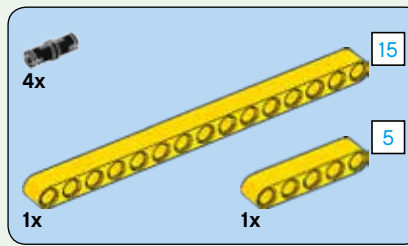
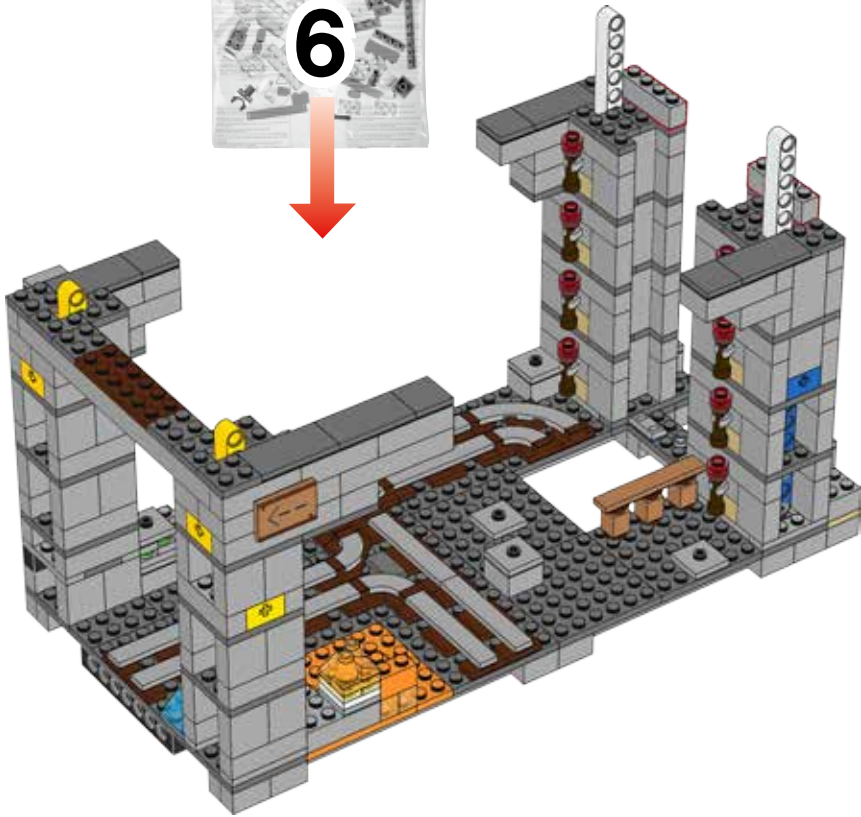

100

1

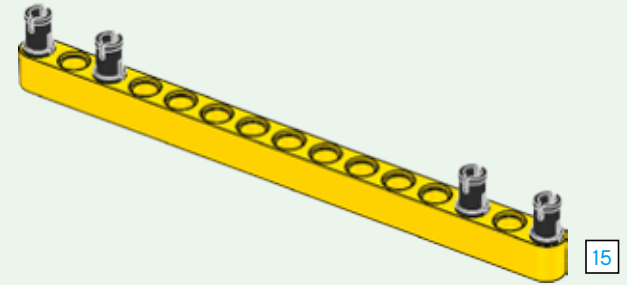

2

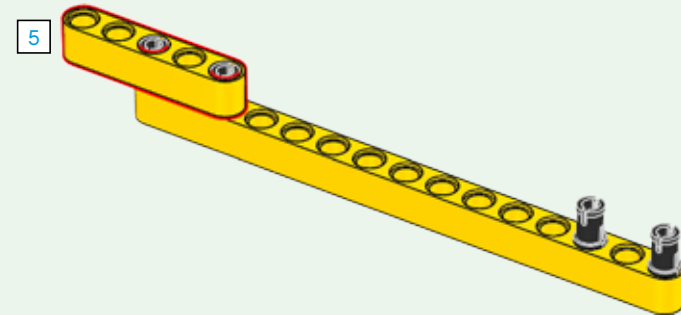

1:1

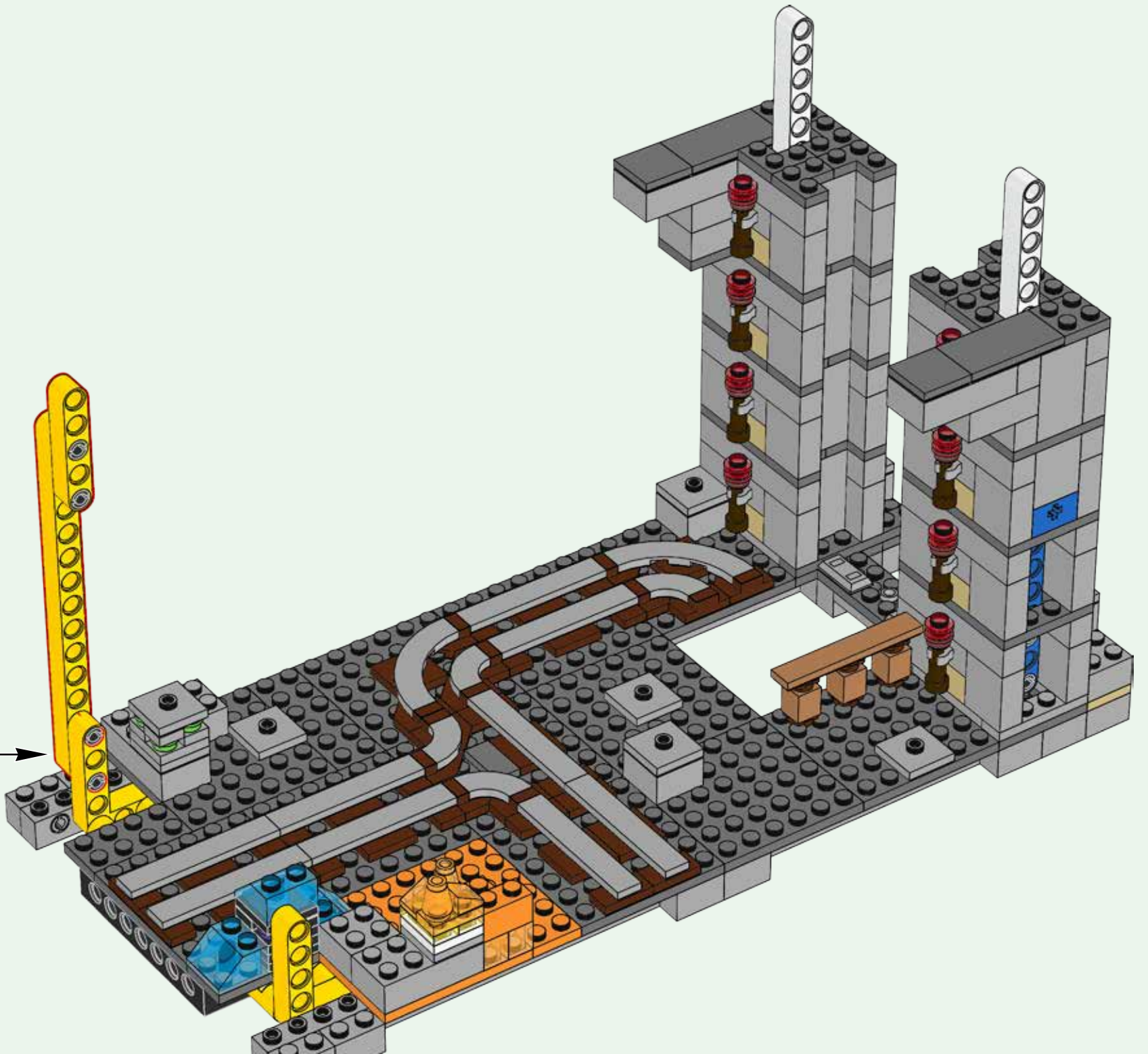

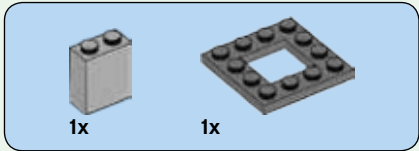
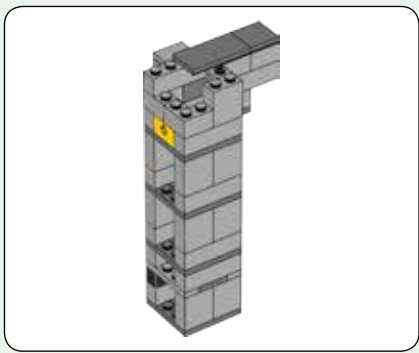

101

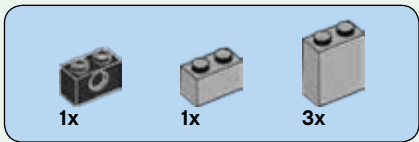
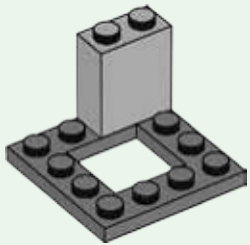

102

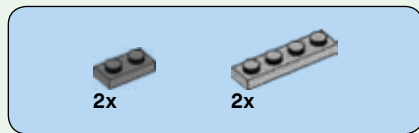
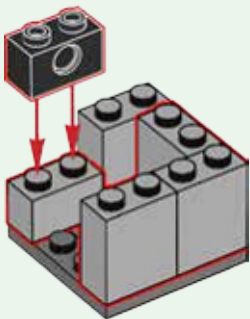

103

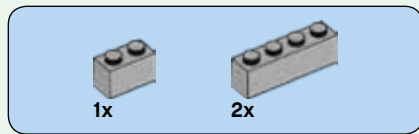
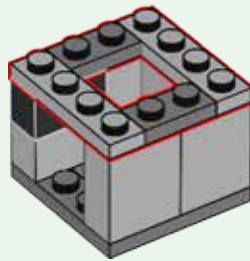

104

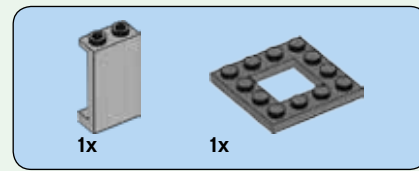
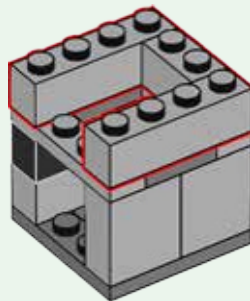

105

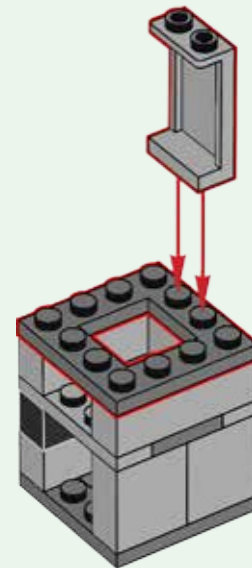

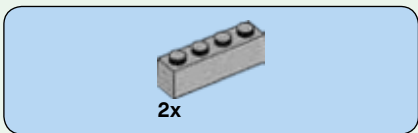

106

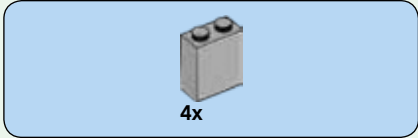
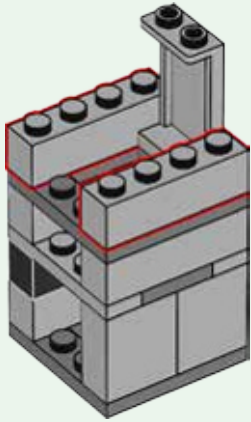

107

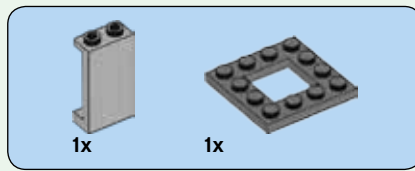
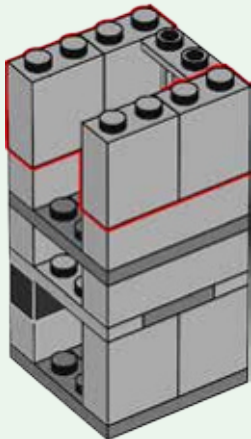

108

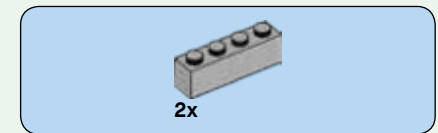
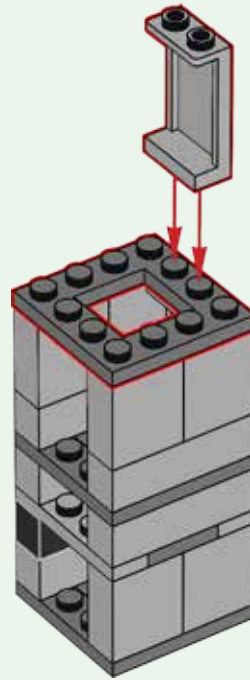

109

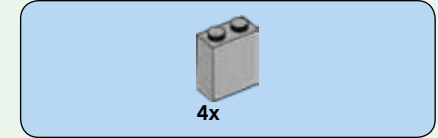
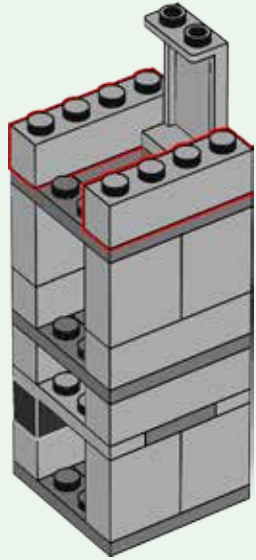

110

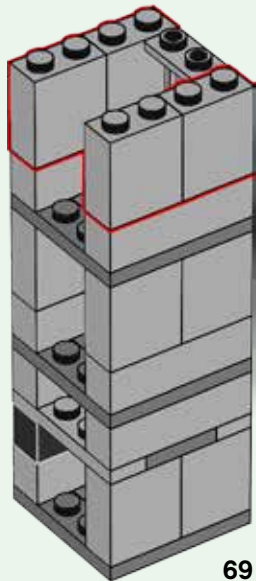

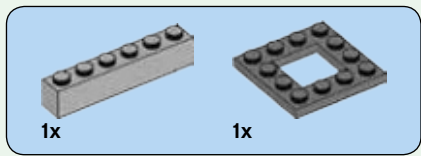

111

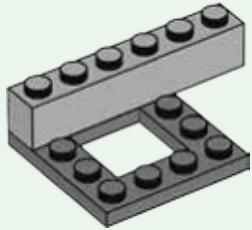

112

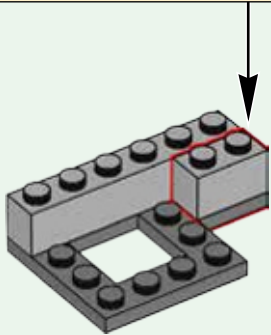
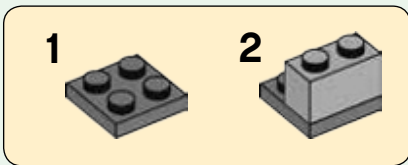

113

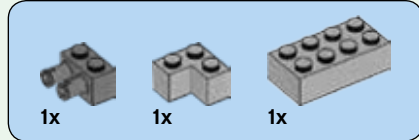
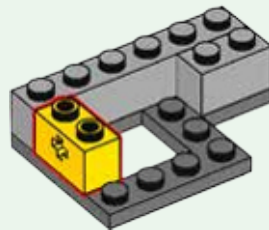

114

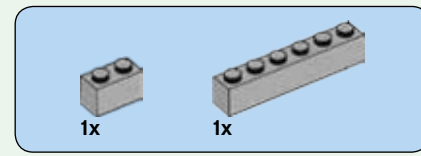
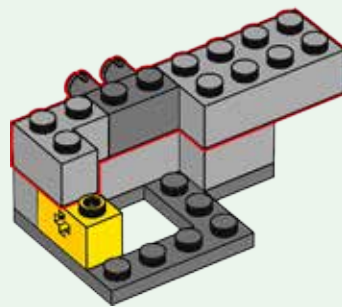

115

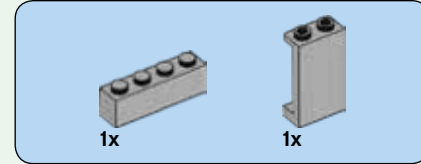
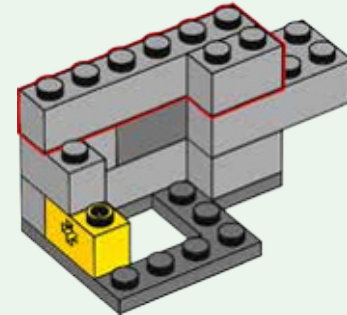

116

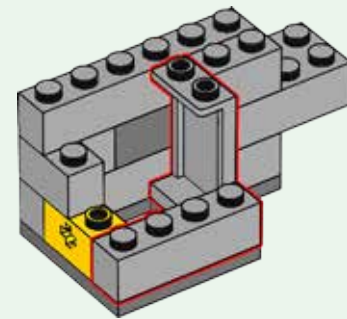

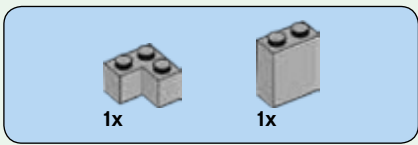

117

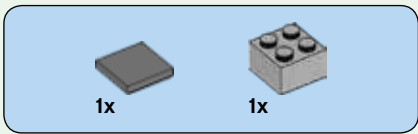
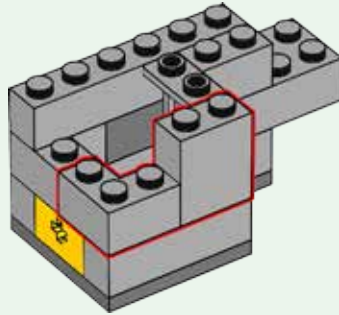

118

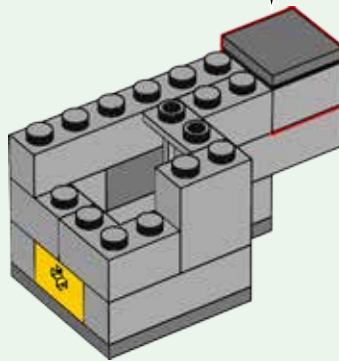
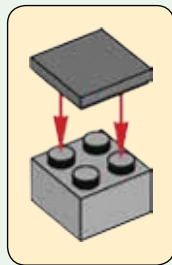

119

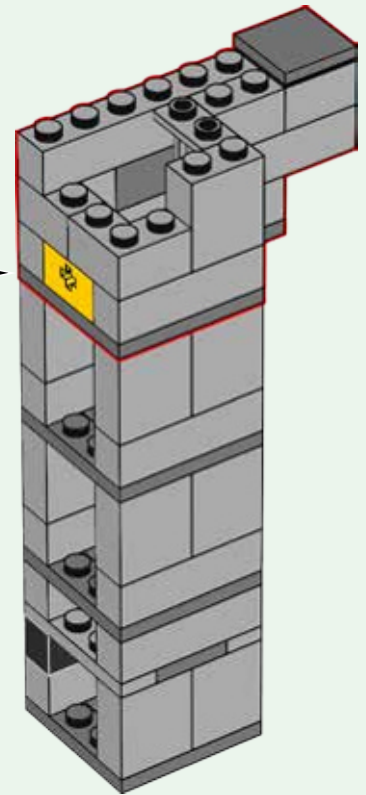

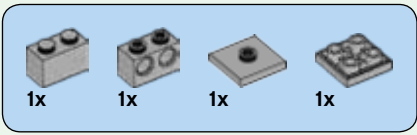

120

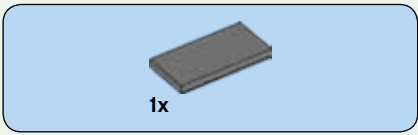
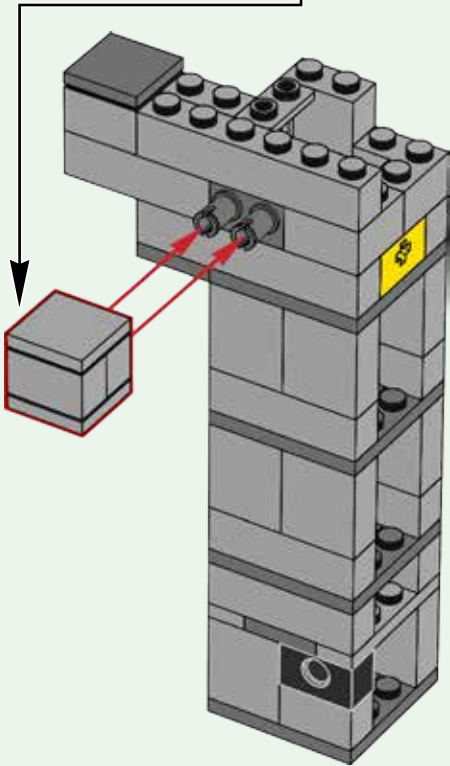
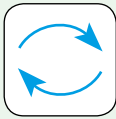
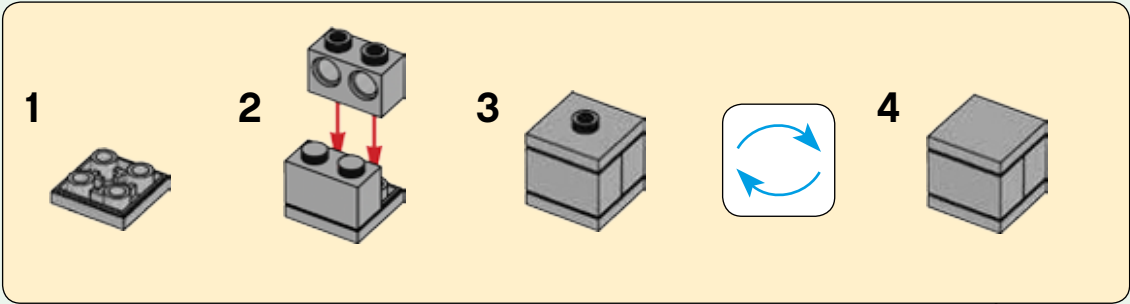

121

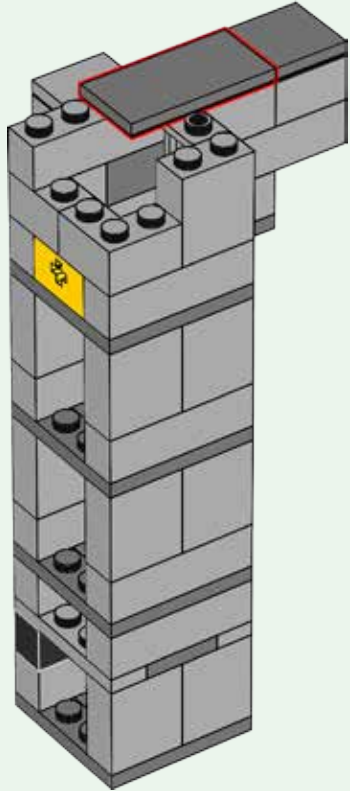
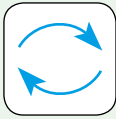

122

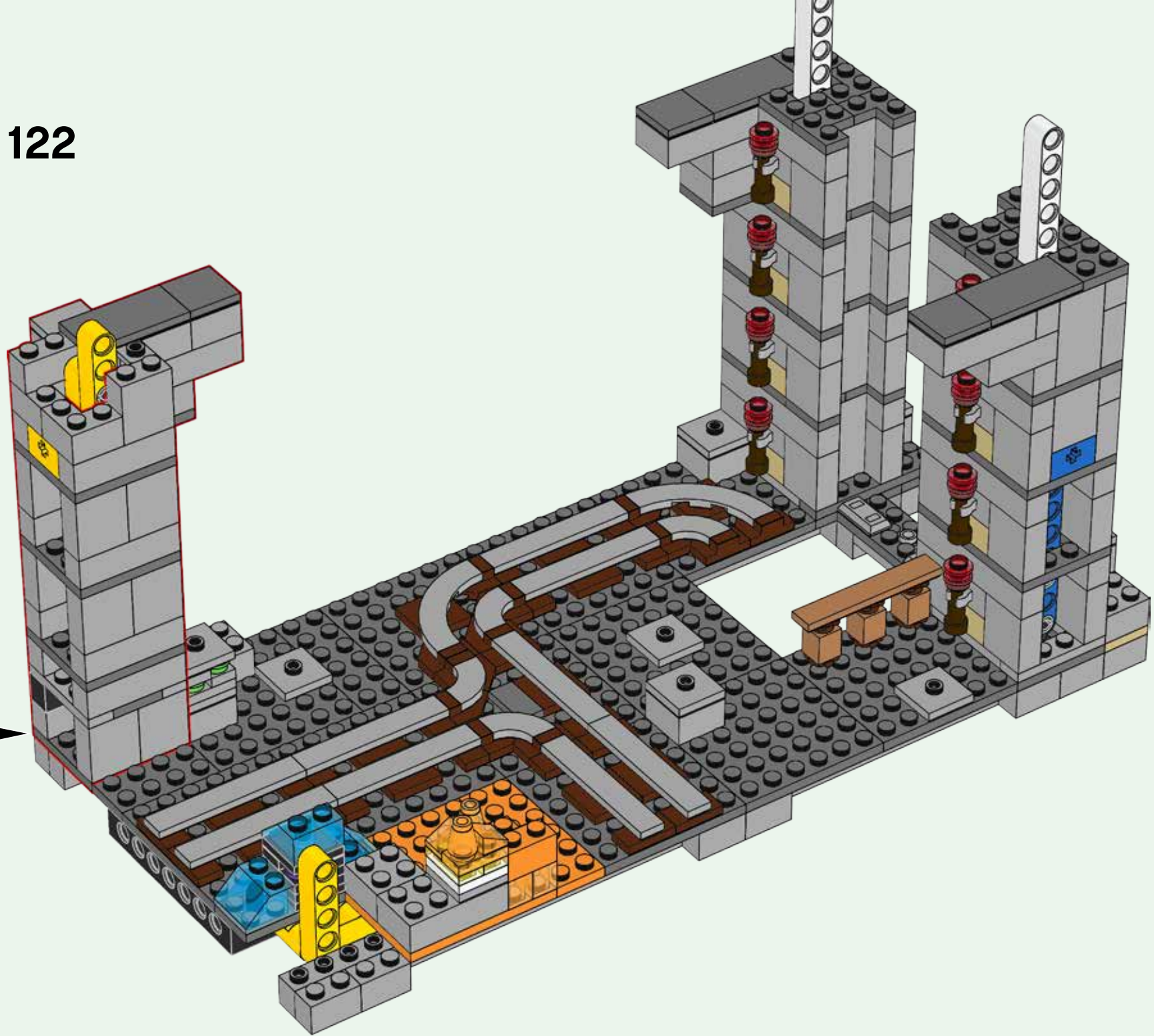

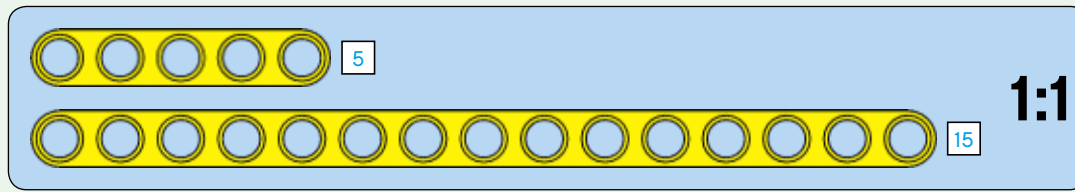
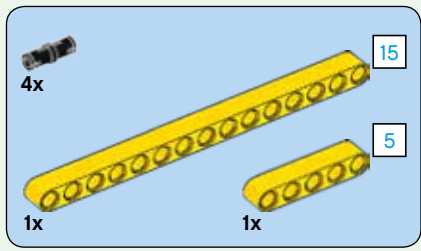

123

1

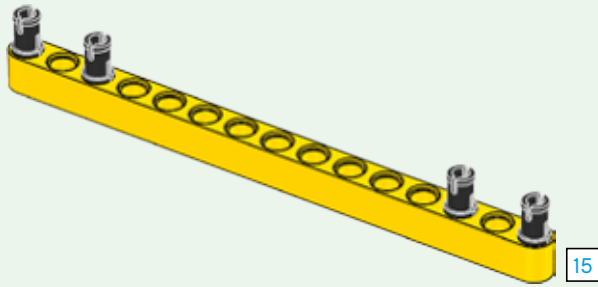

2

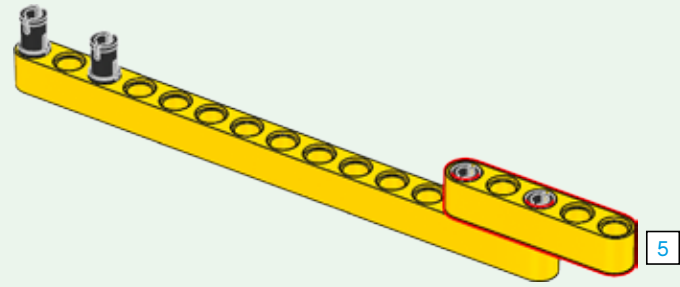

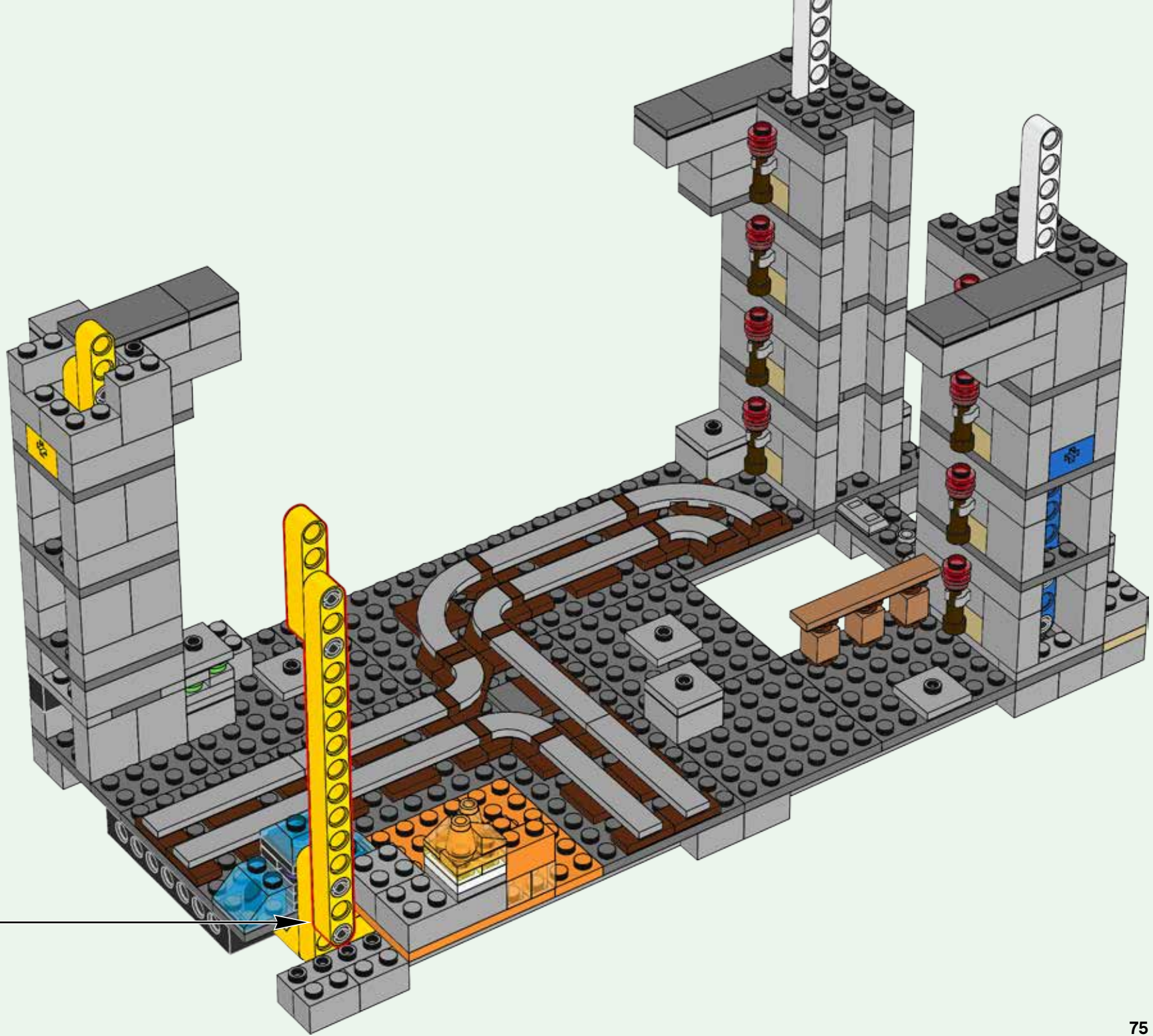

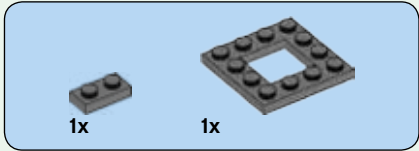
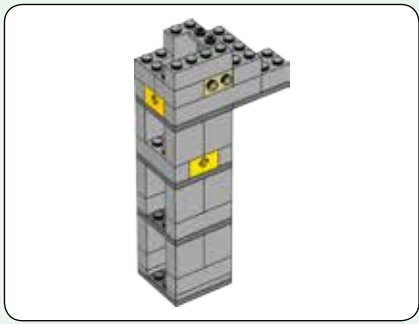

124

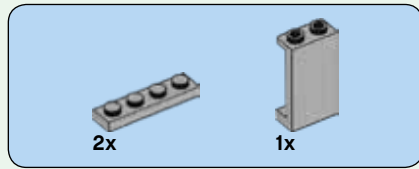
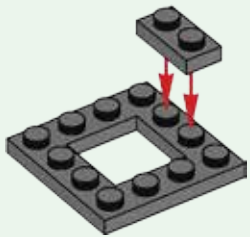

125

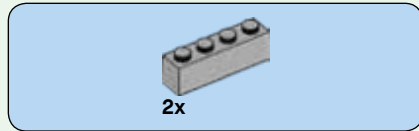
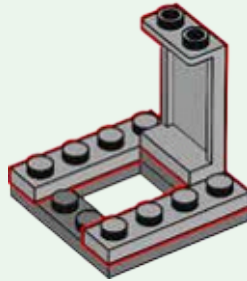

126

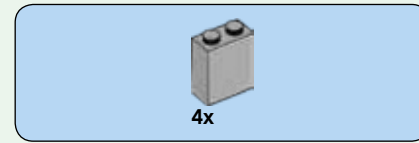
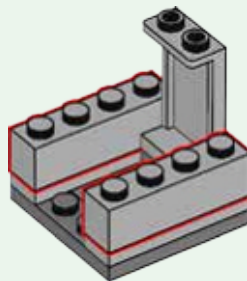

127

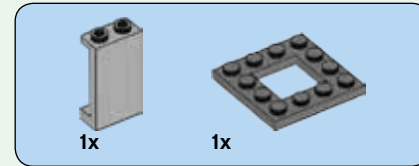
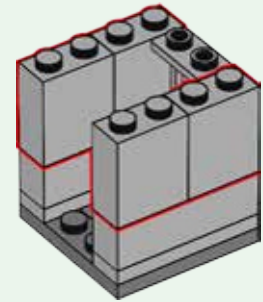

128

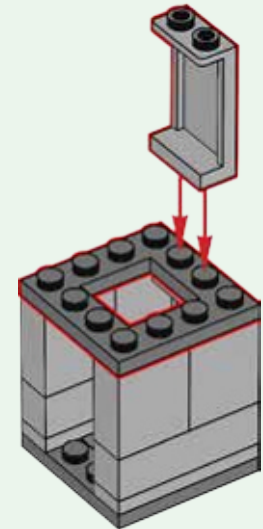

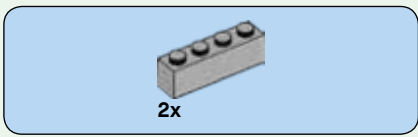

129

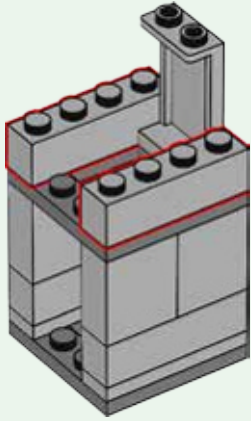

130

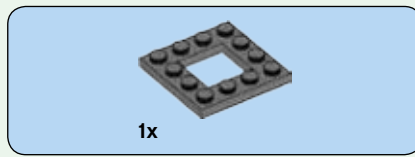
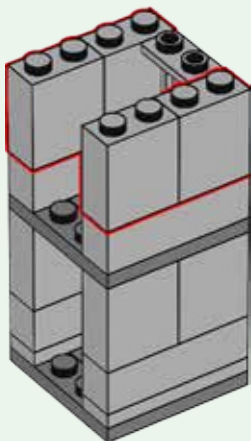

131

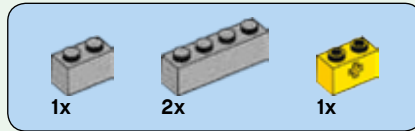
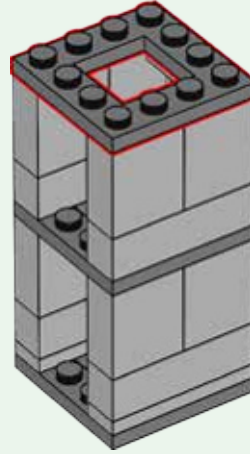

132

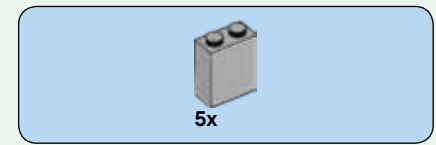
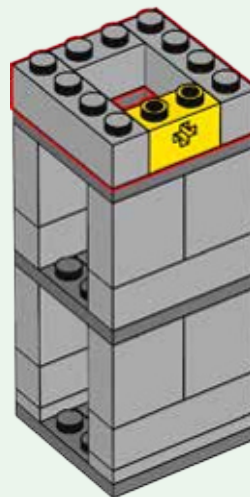

133

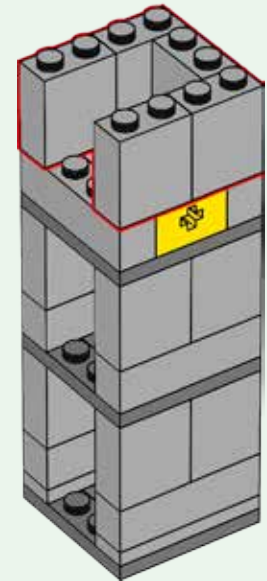

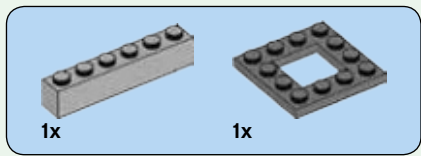

134

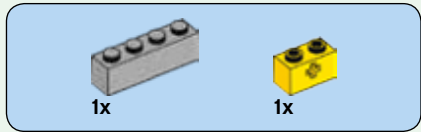
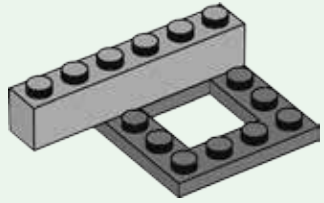

135

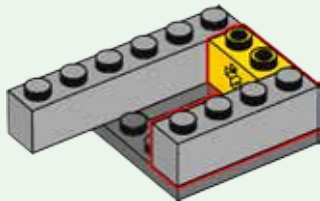

136

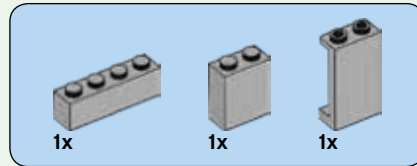
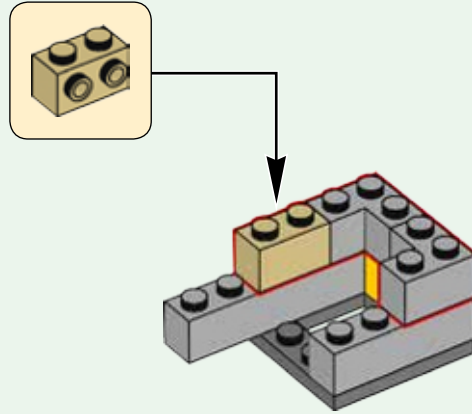

137

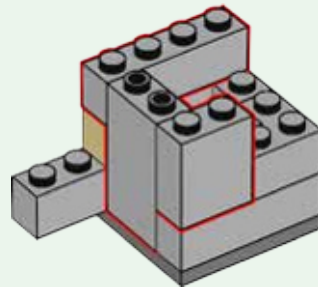

138

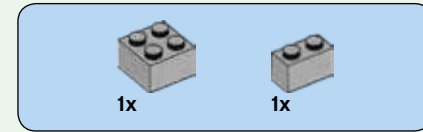
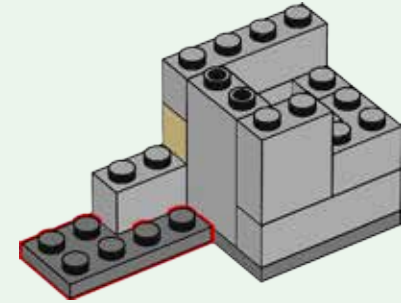

139

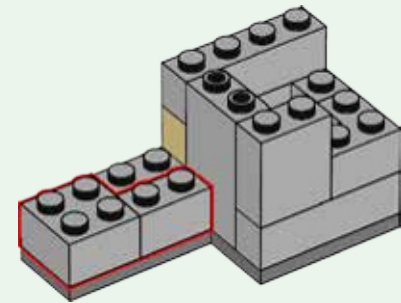

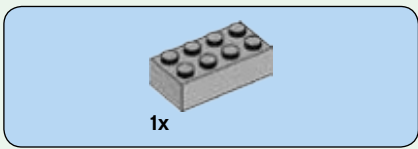

140

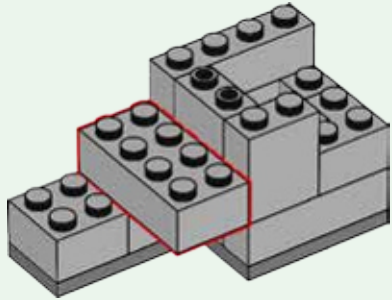

141

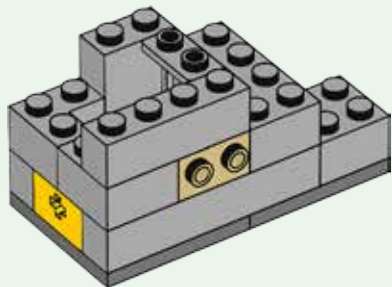
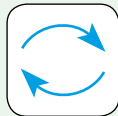

142

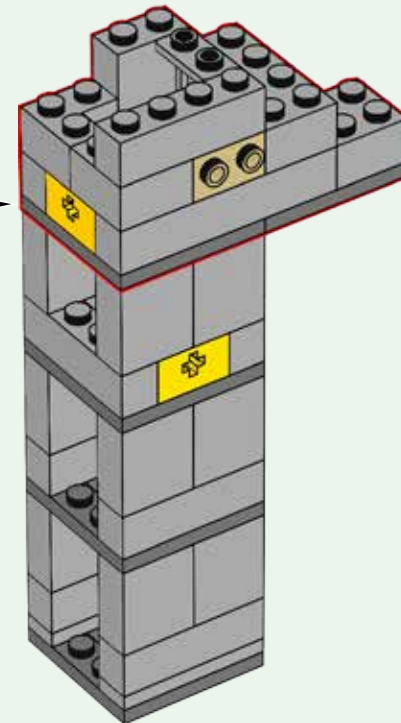

143

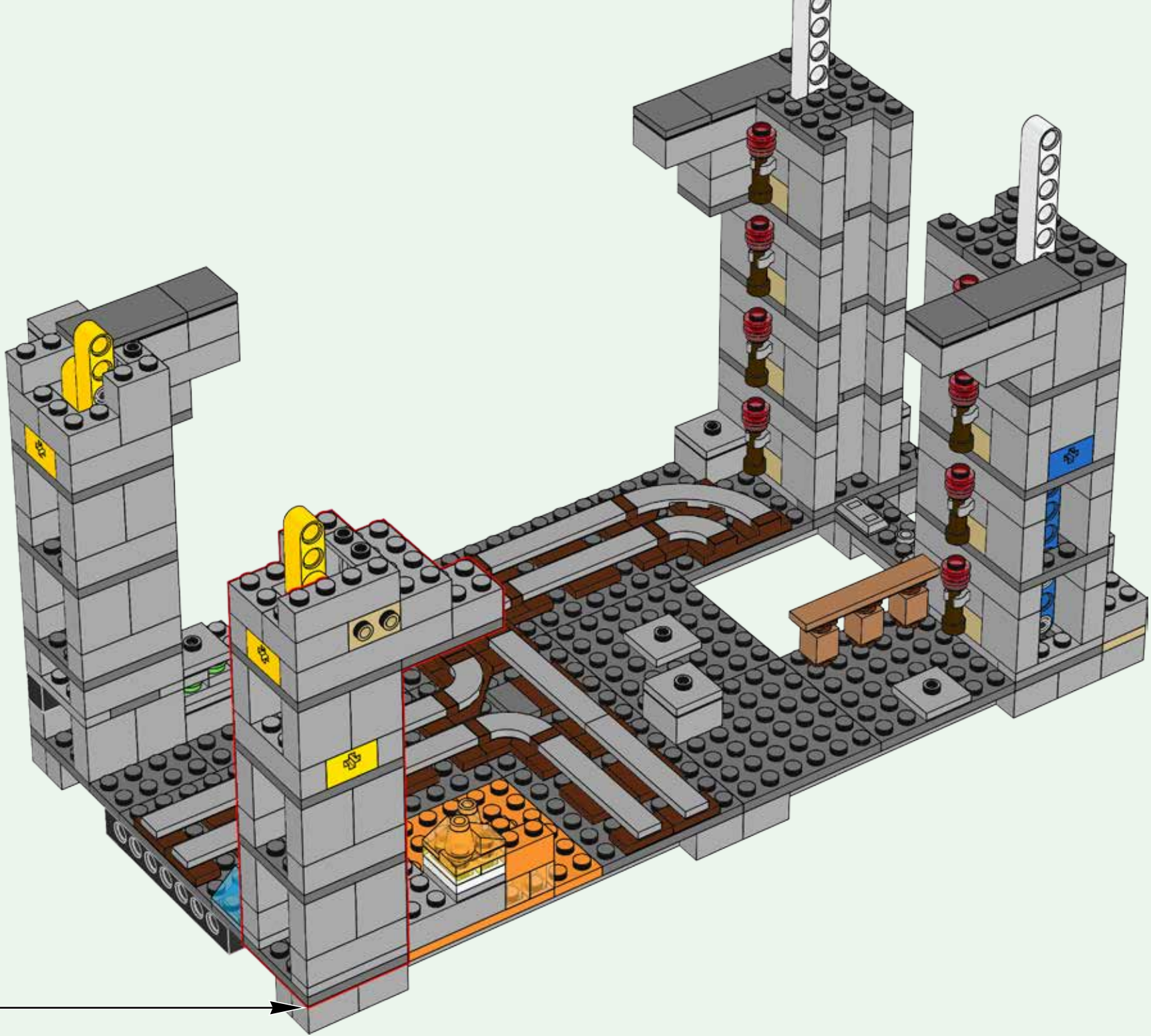

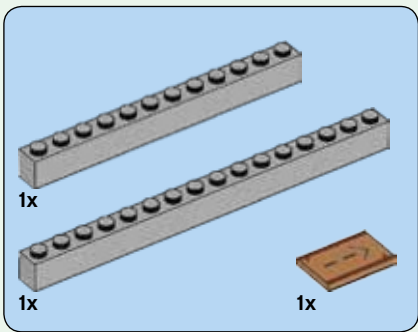

144

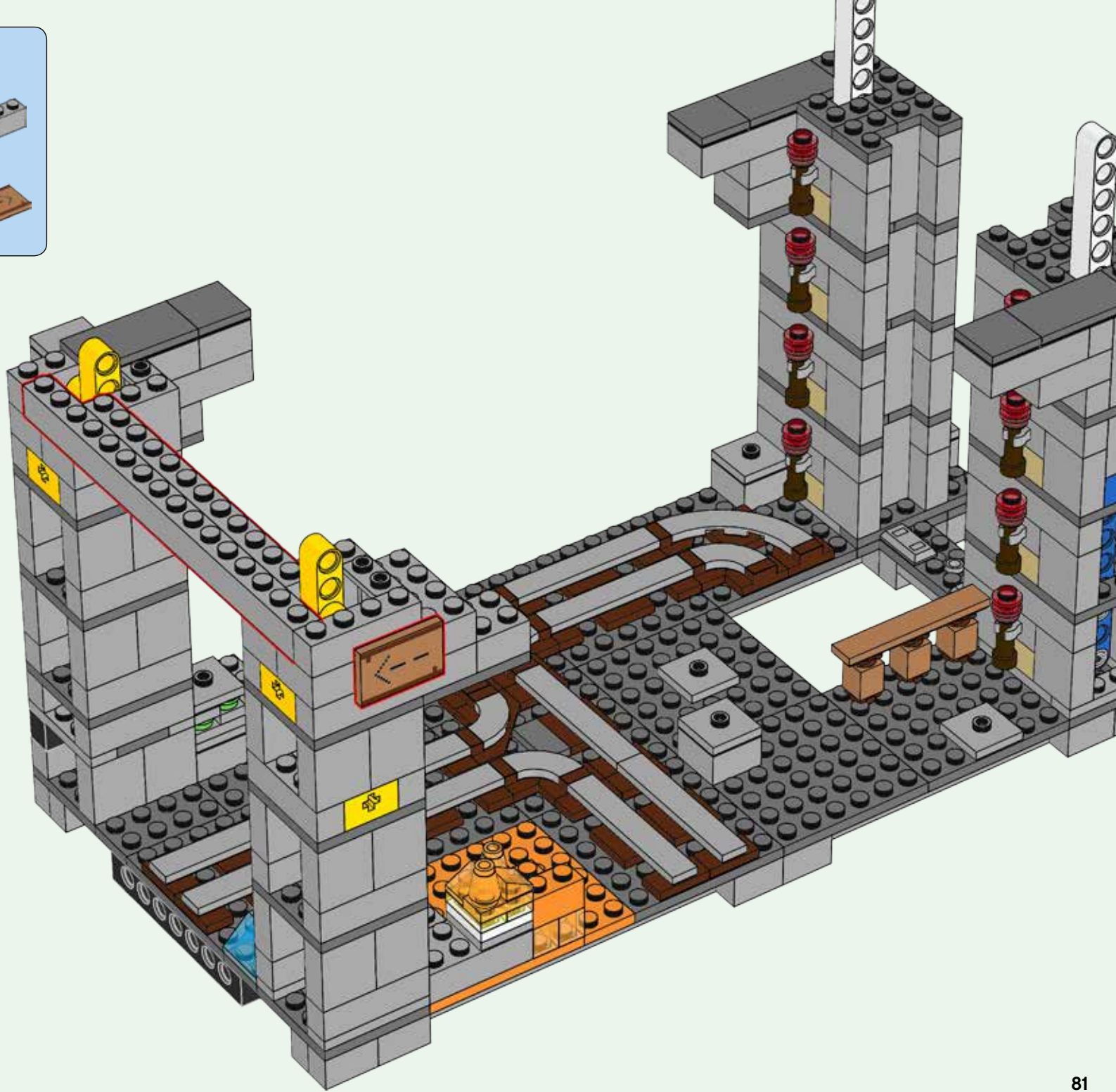

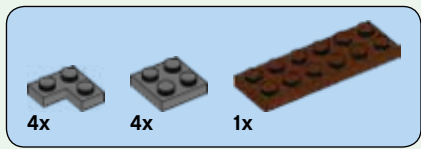

145

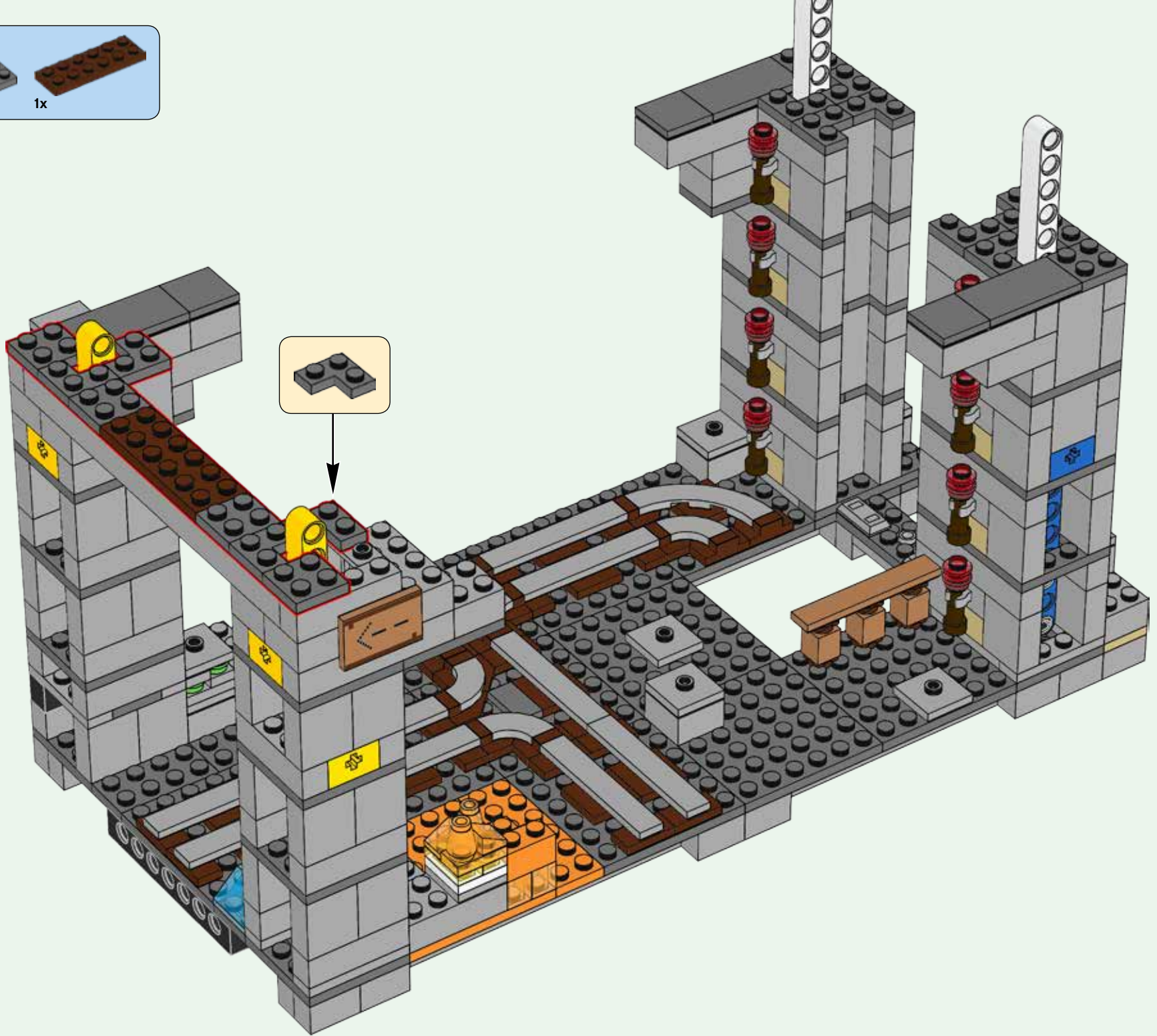

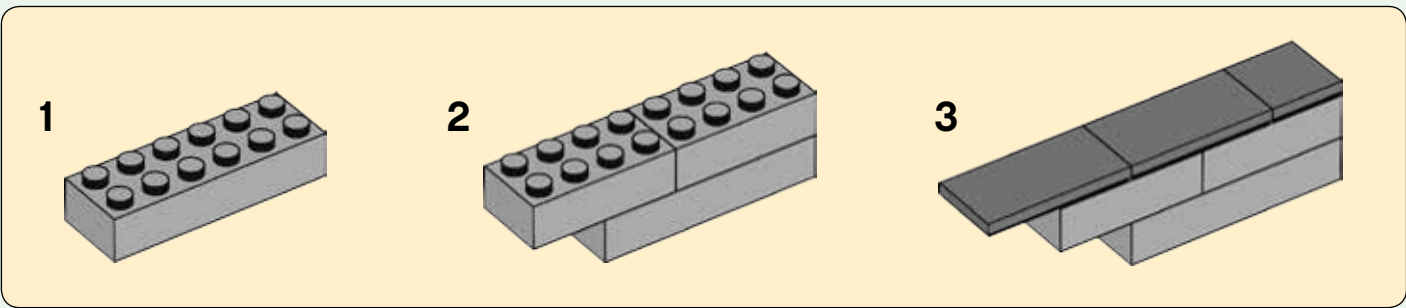
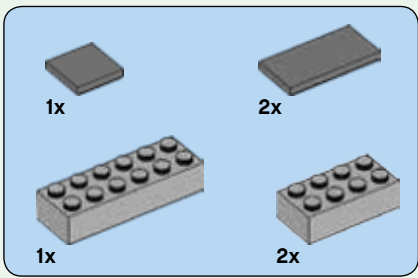

146

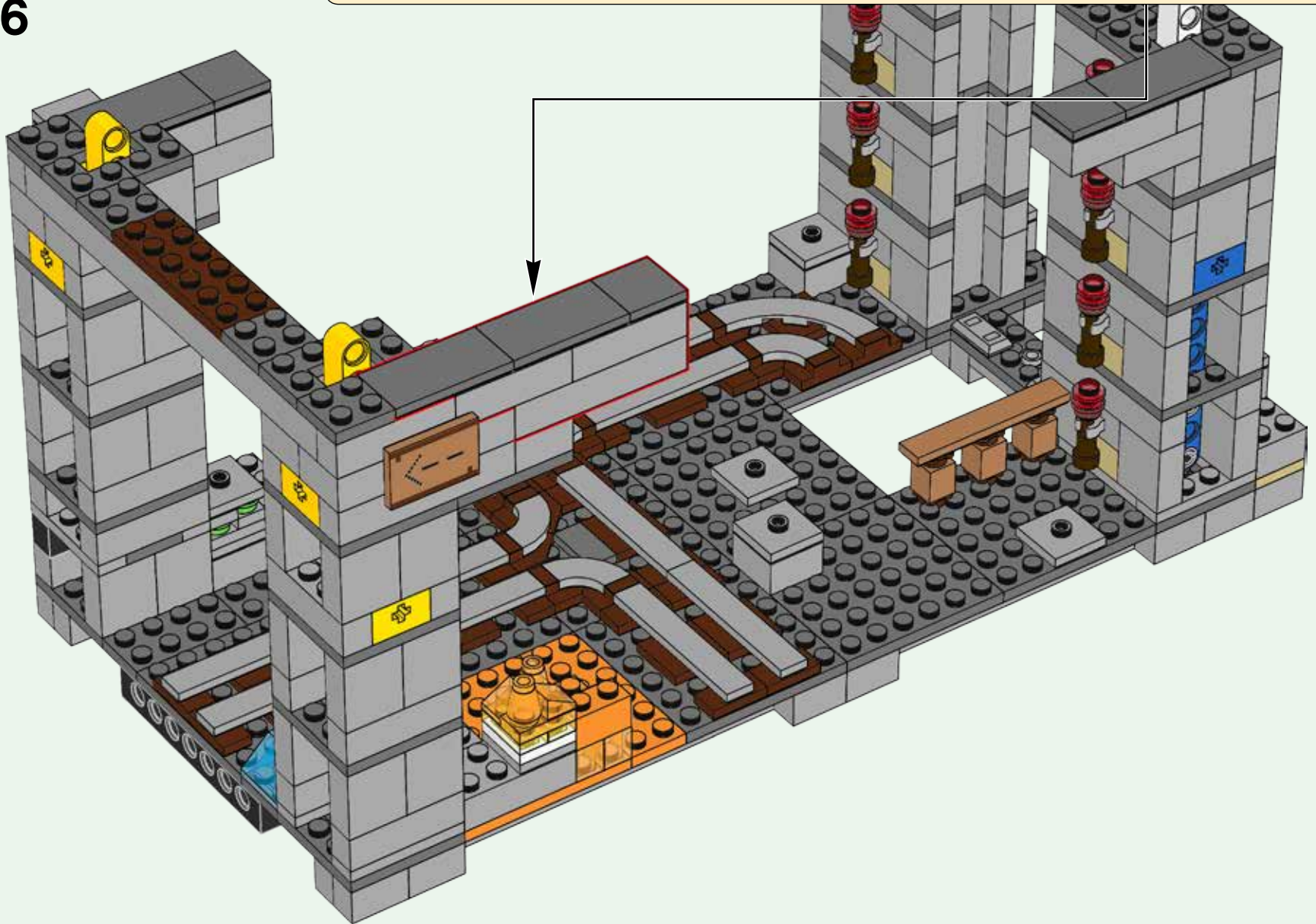

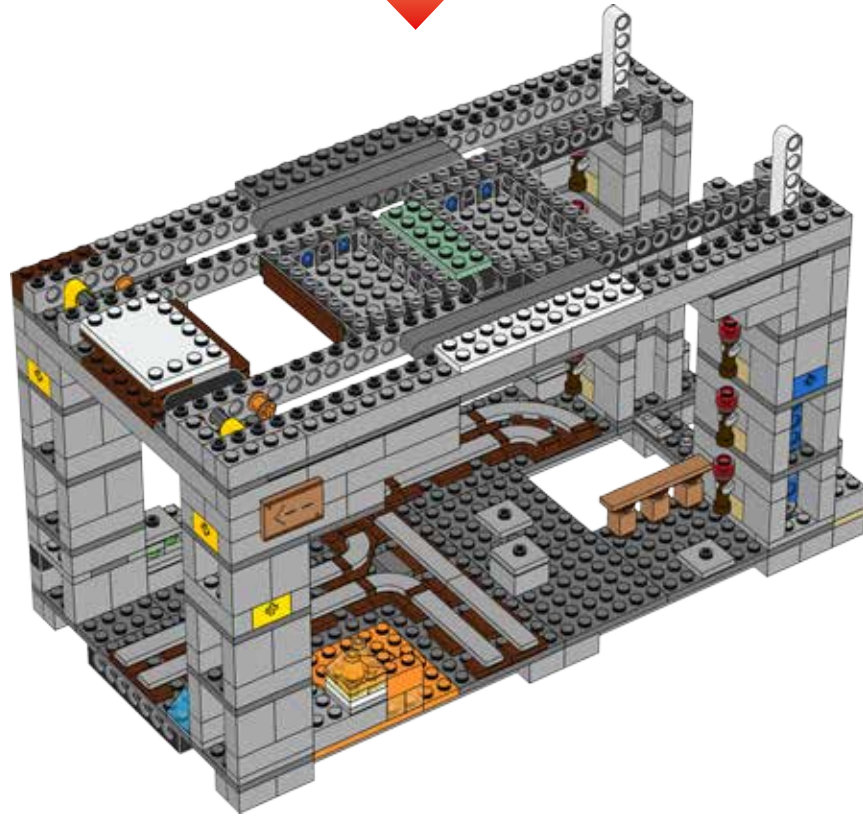

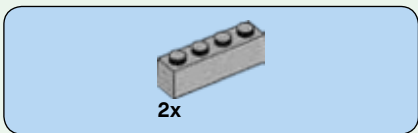

147

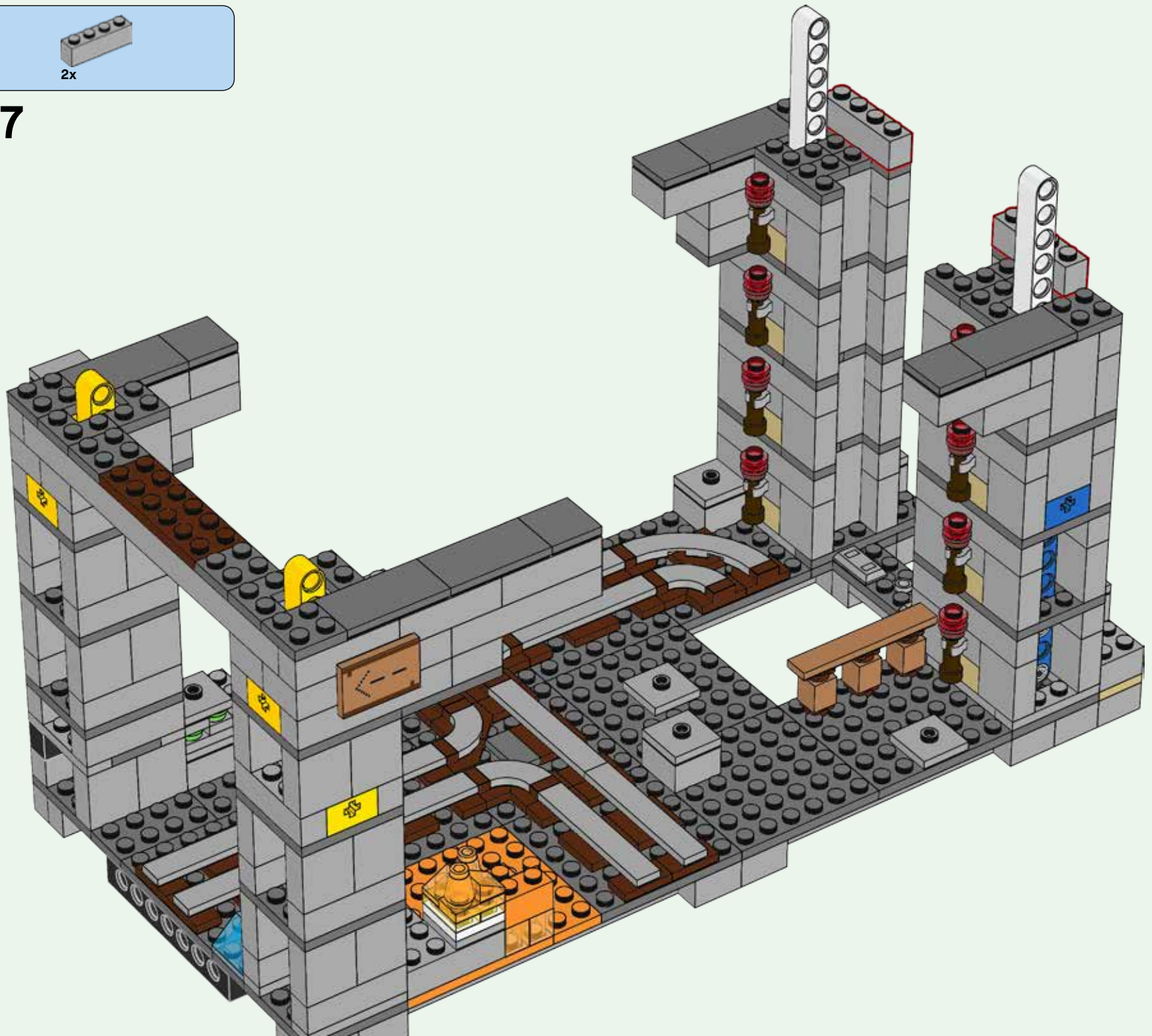

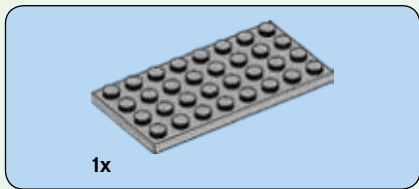
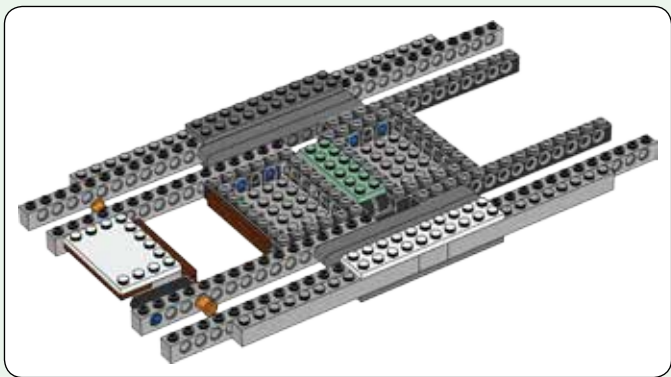

148

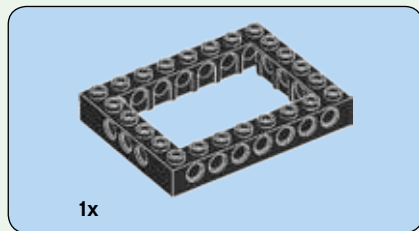
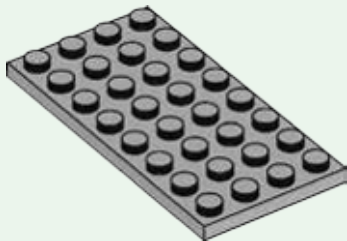

149

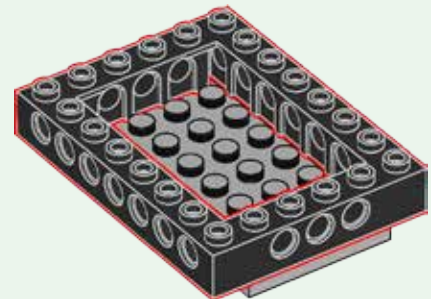

150

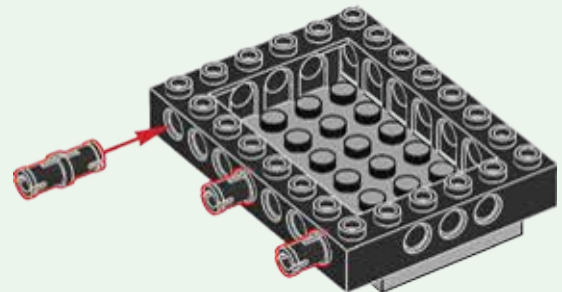

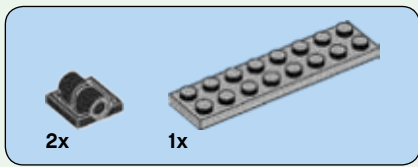

151

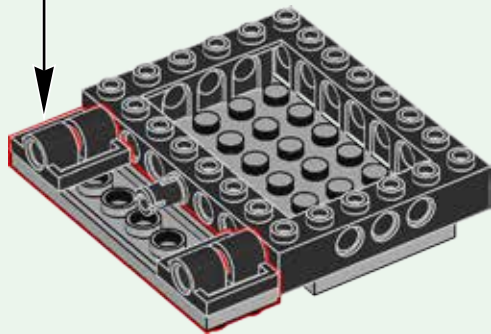
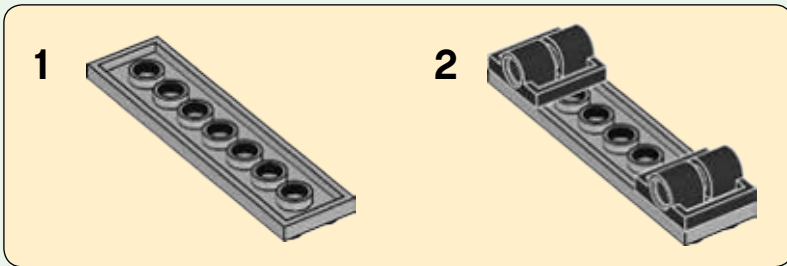

152

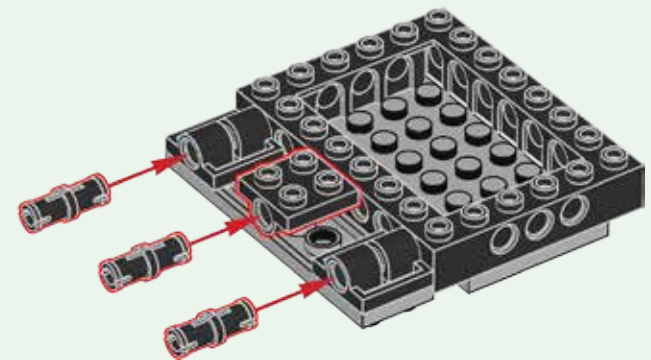

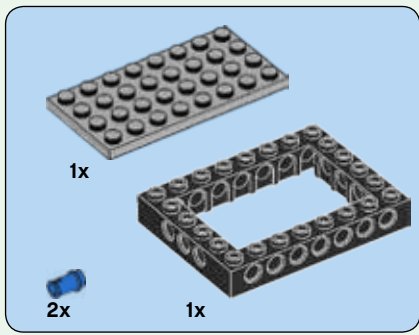

153

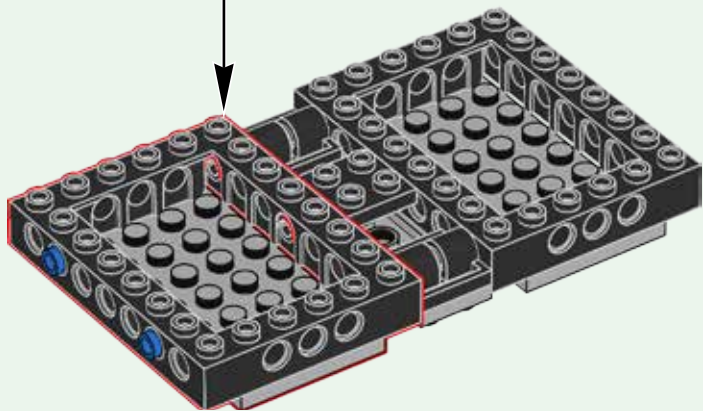
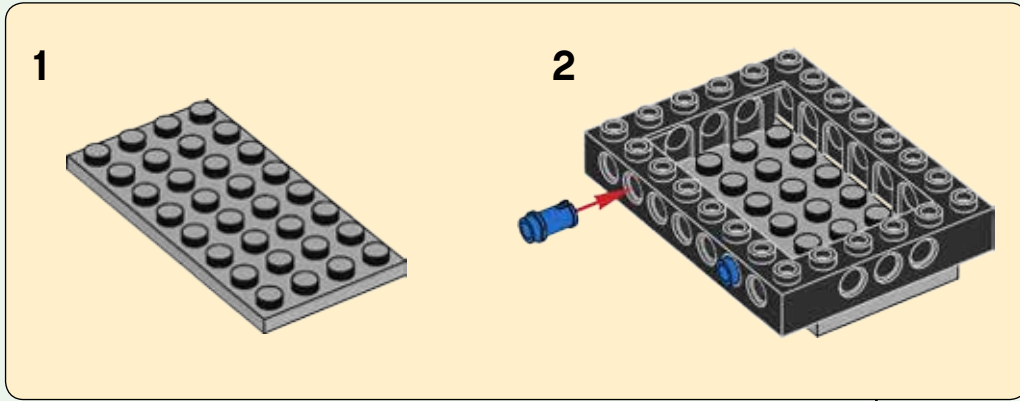

154

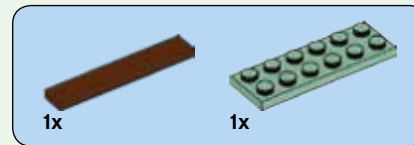
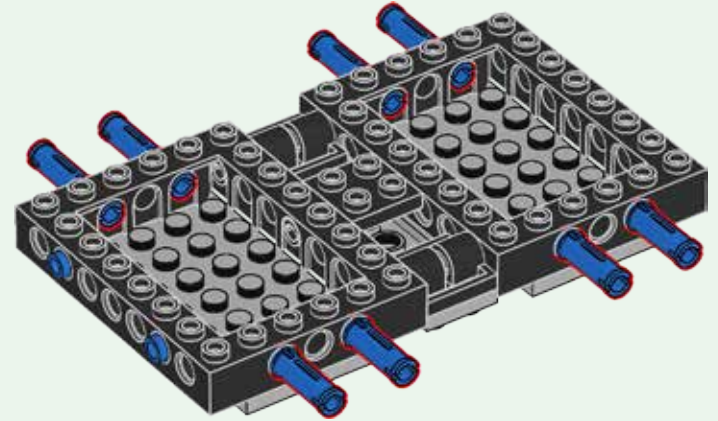

155

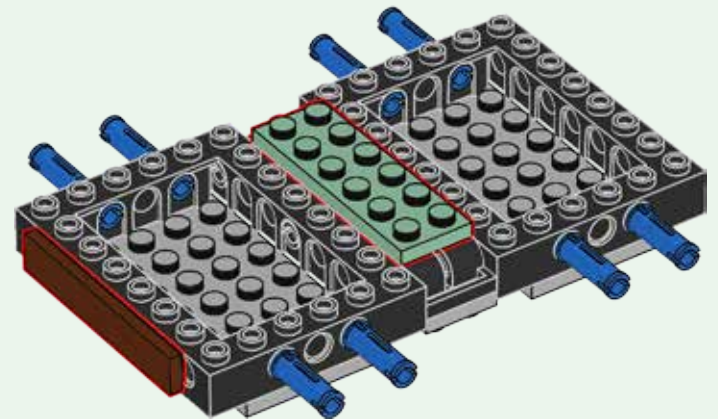

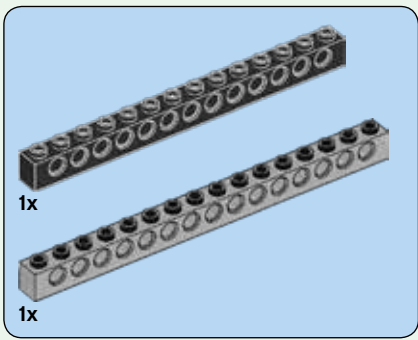

156

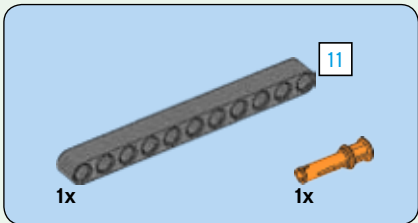
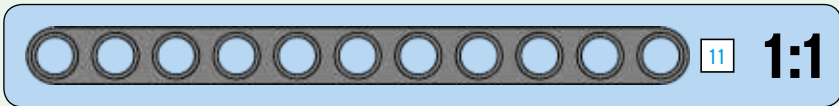
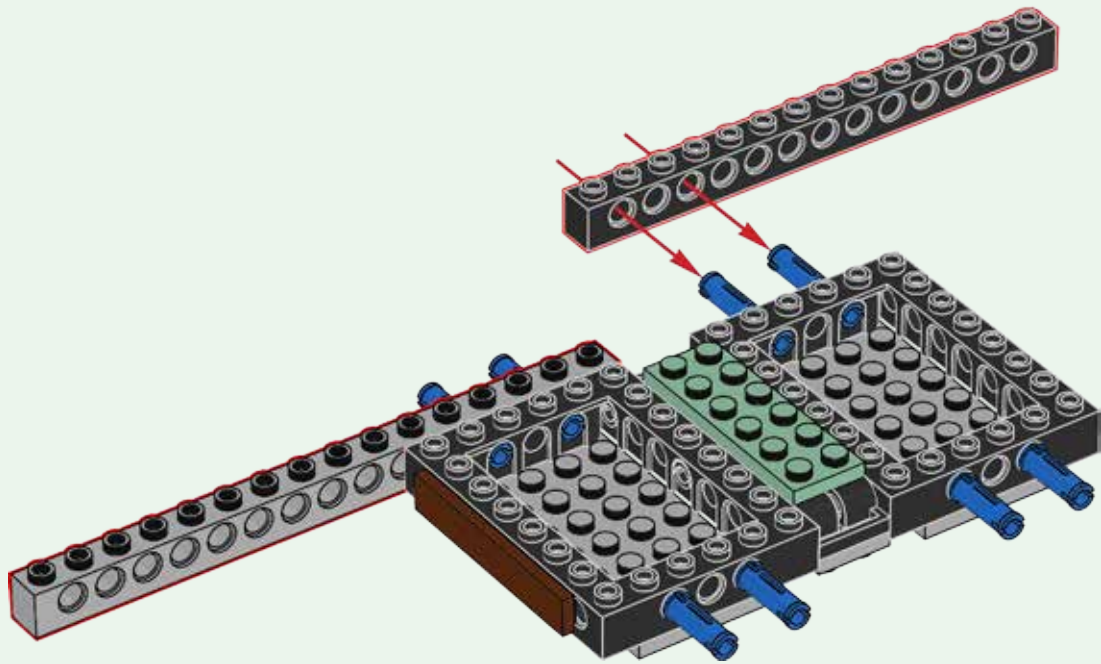

157

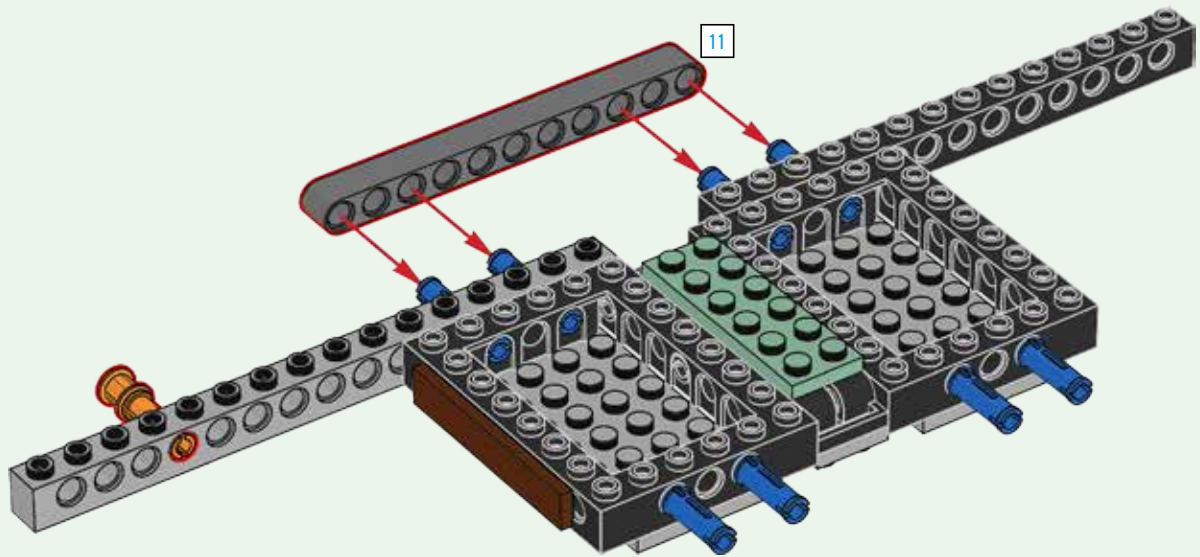

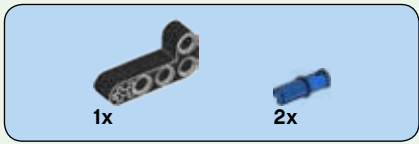

158

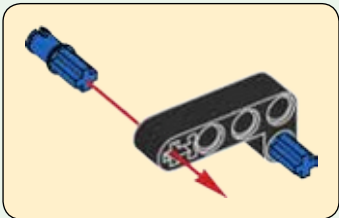
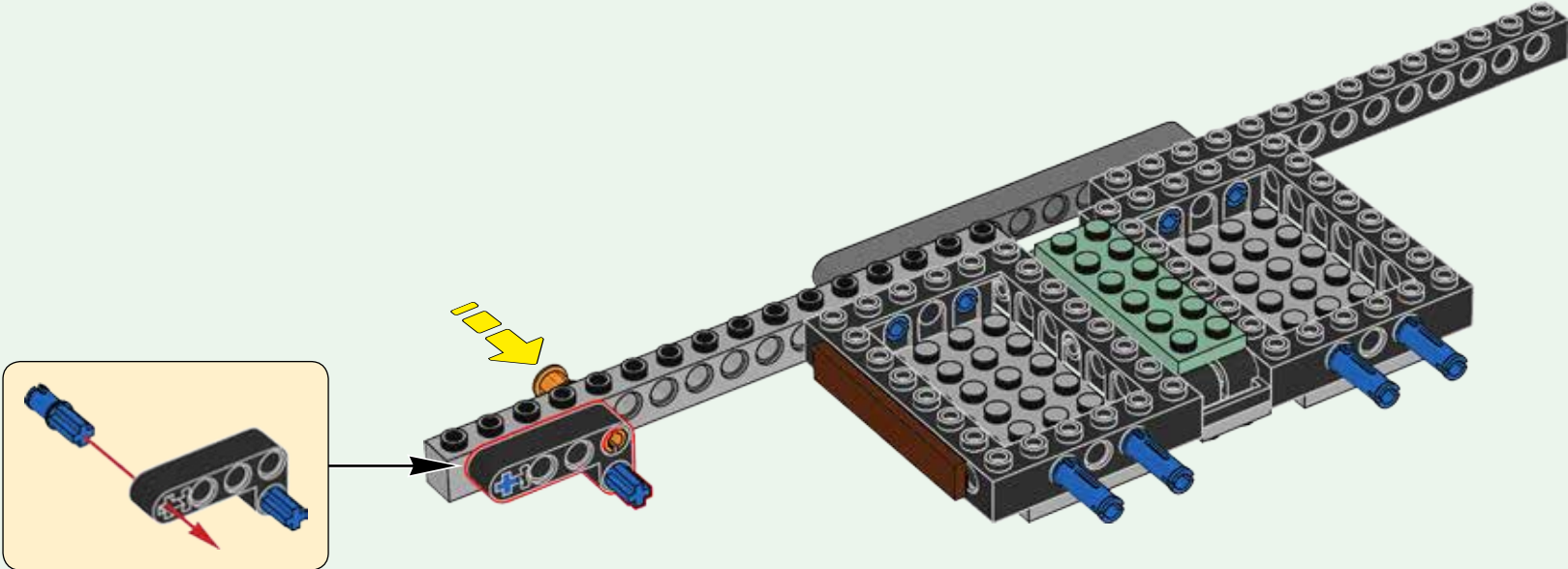

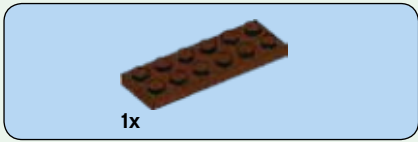
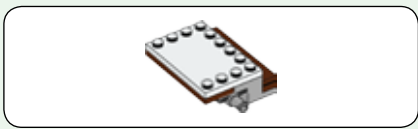

159

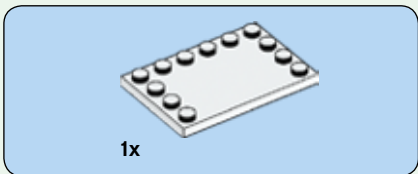

160

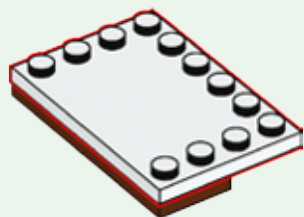

3x

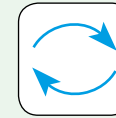

161

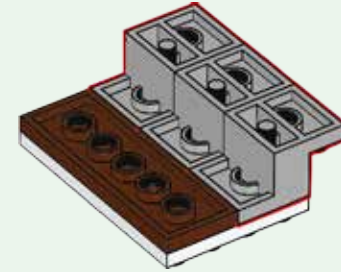

162

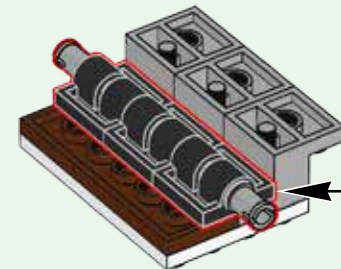
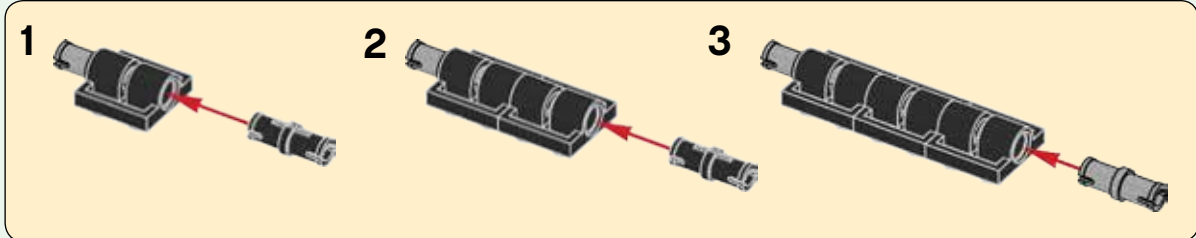

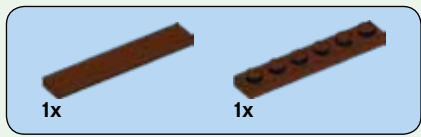

163

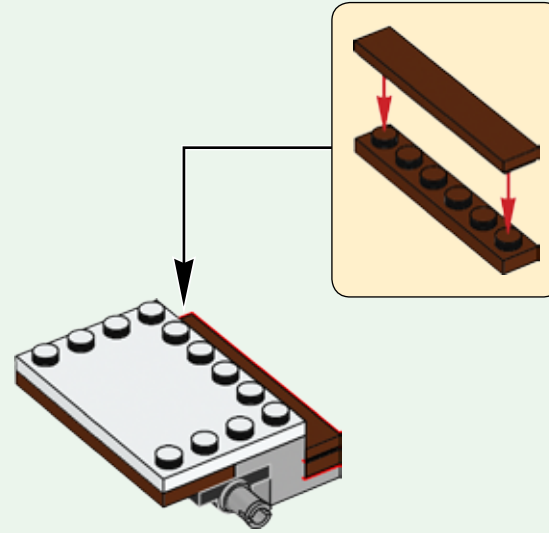
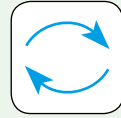

164

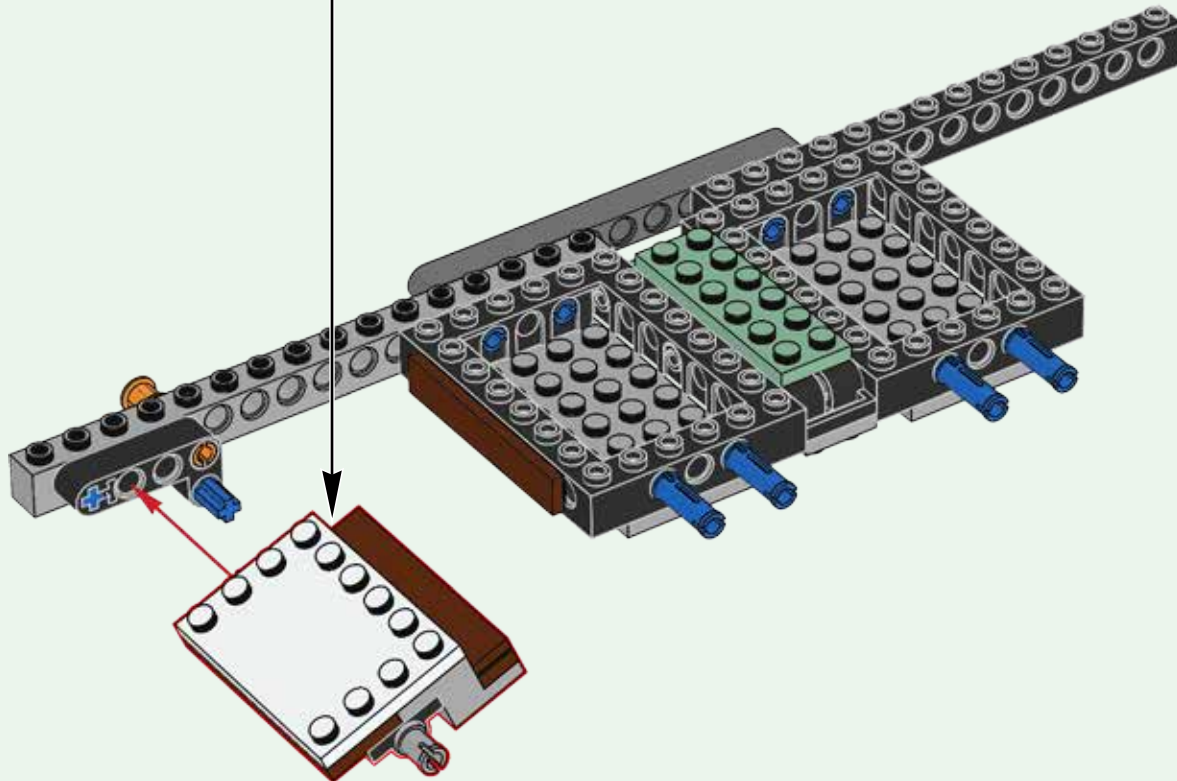

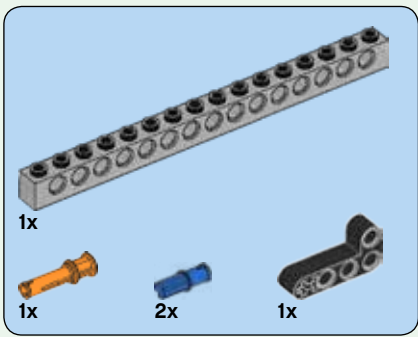

165

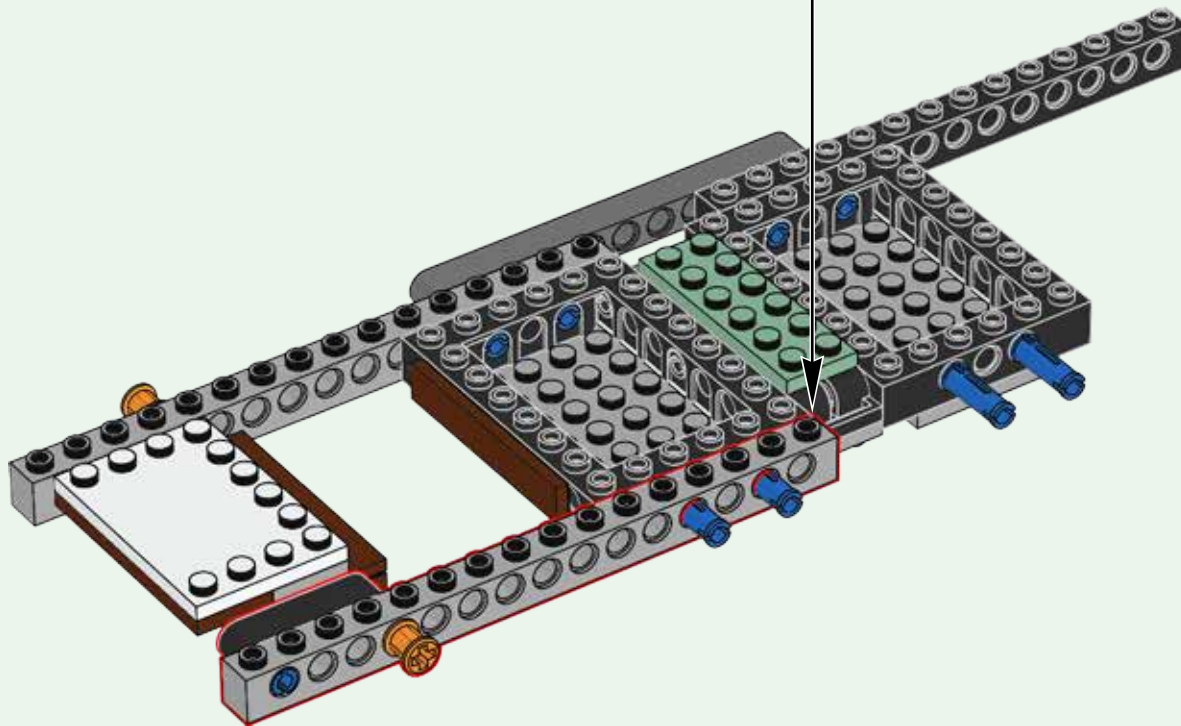
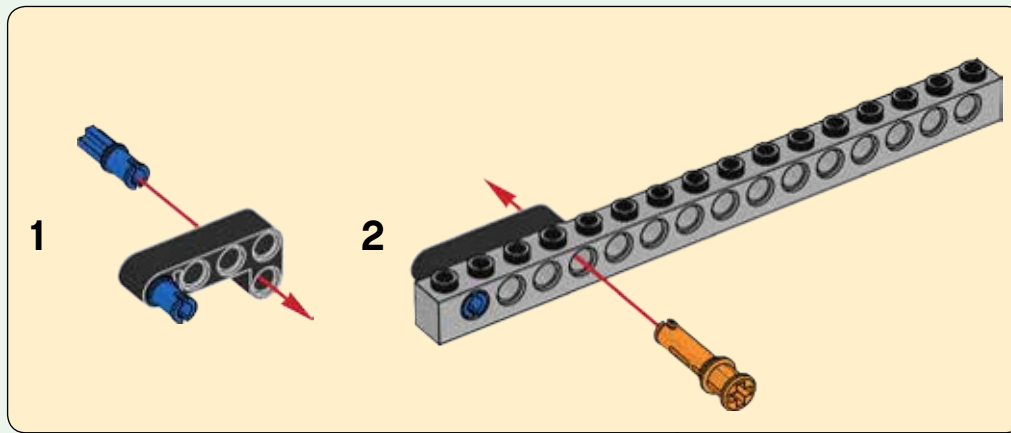

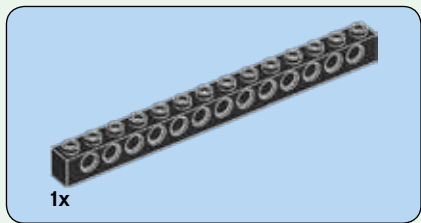

166

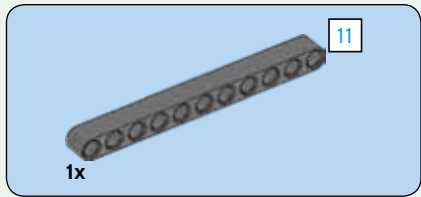
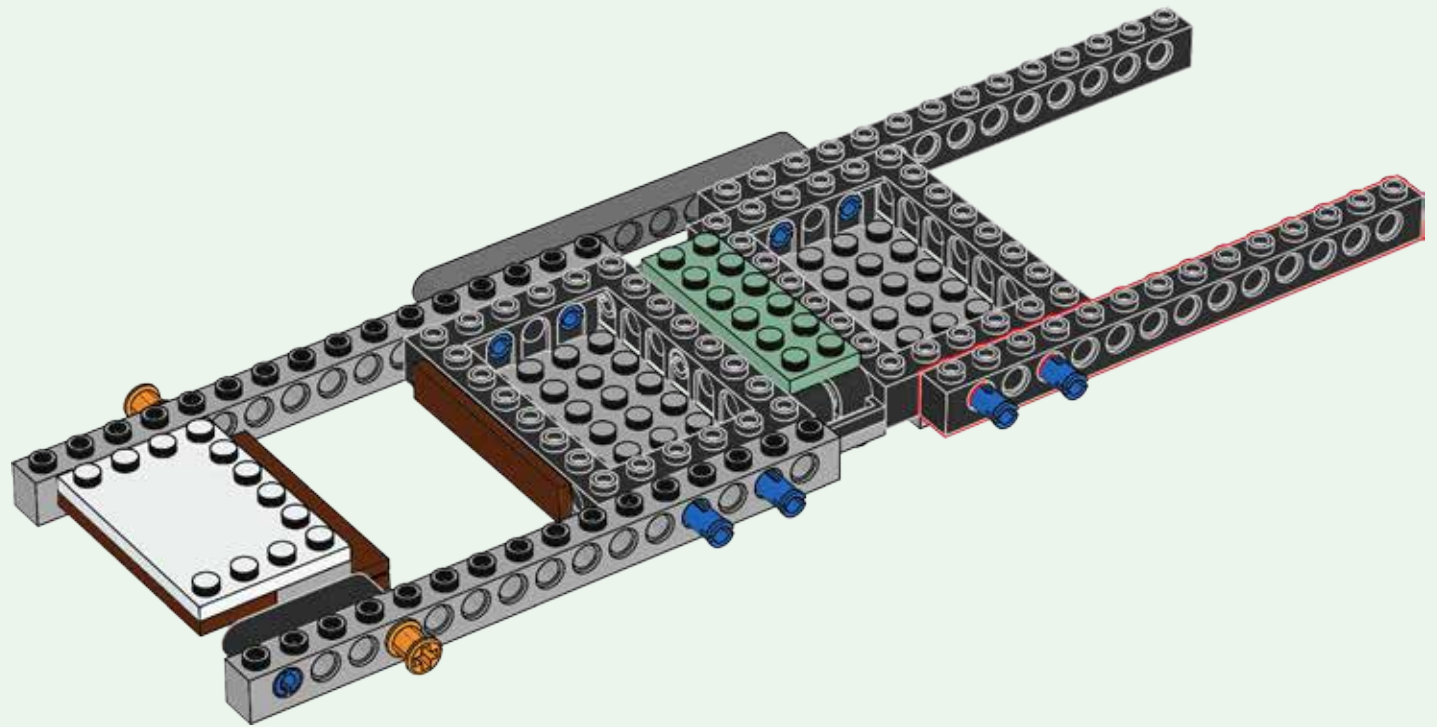

167

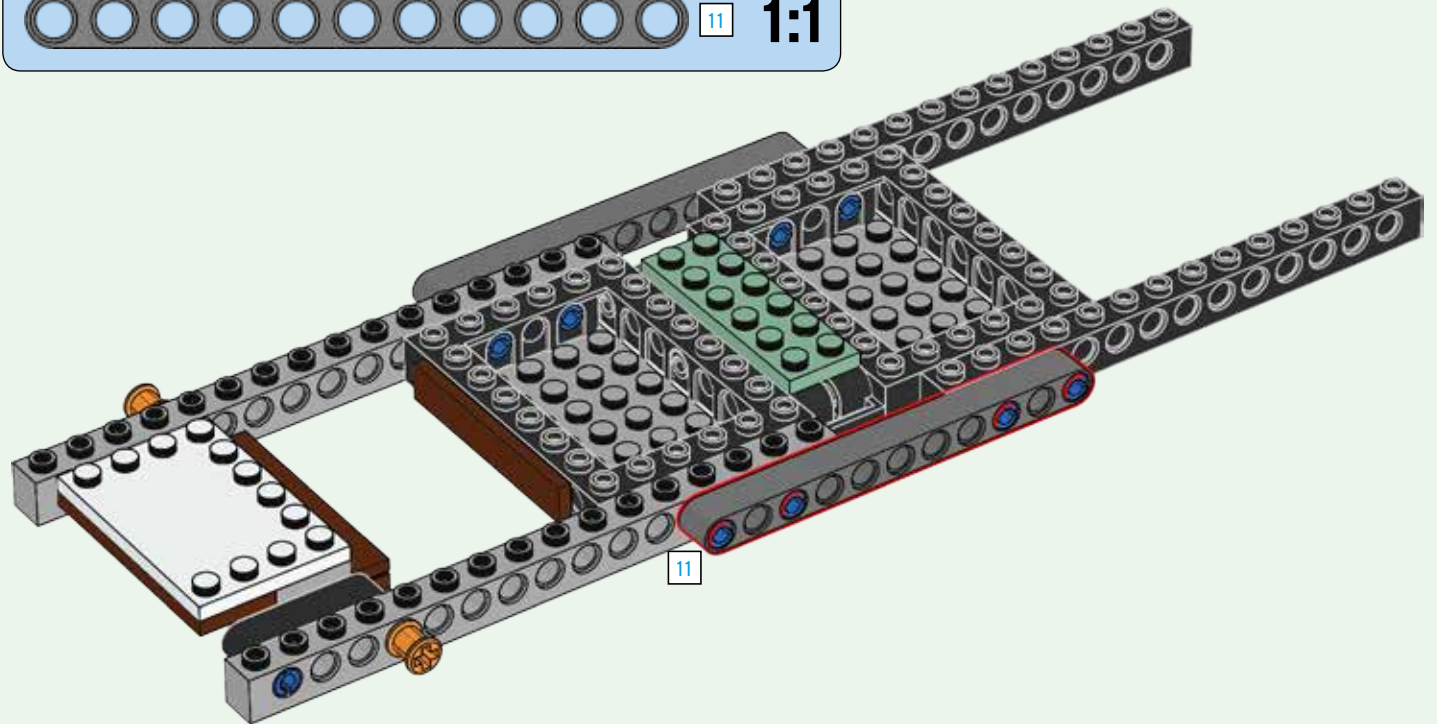
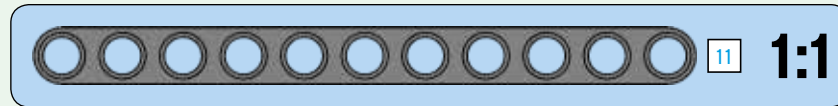

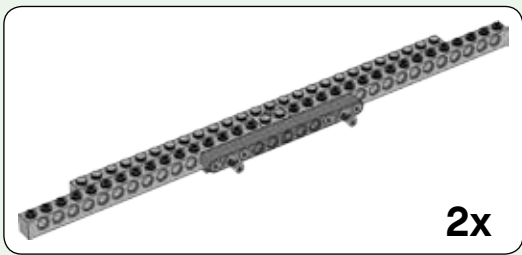

2x

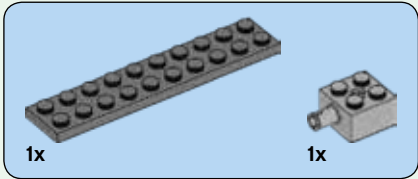

1x

1x

168

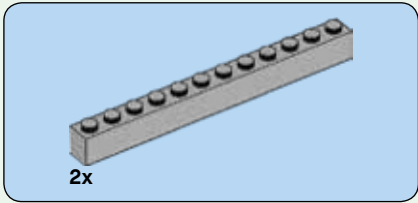
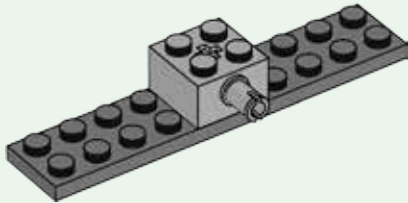

2x

169

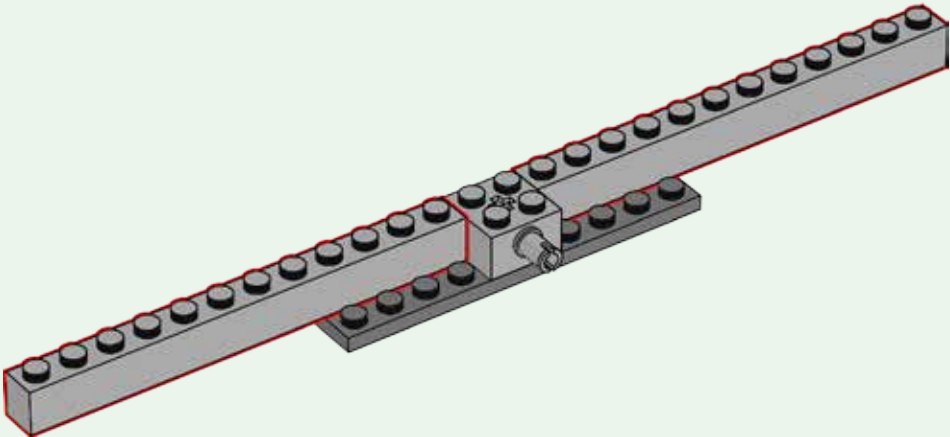

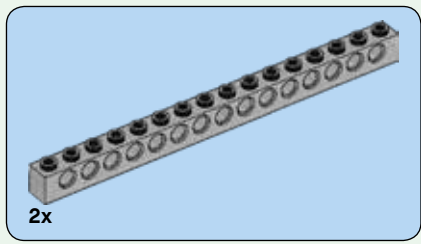

170

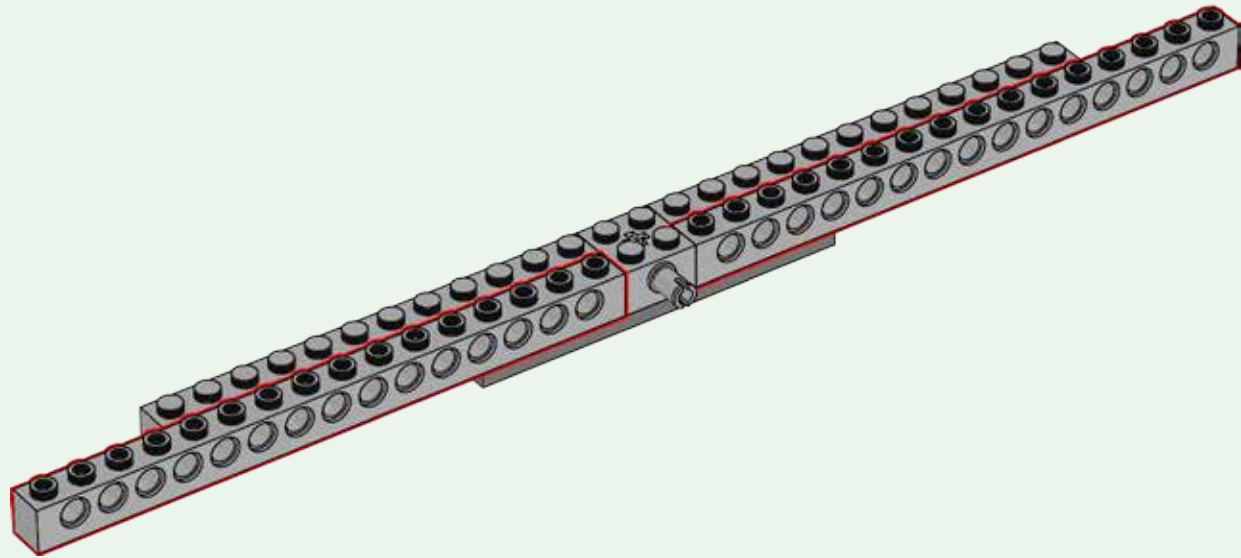

171



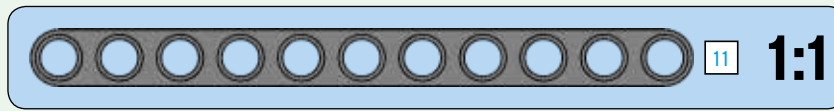
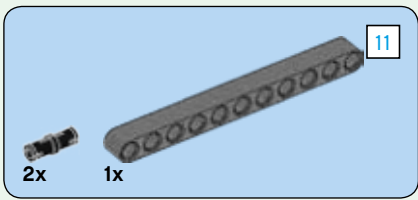

172

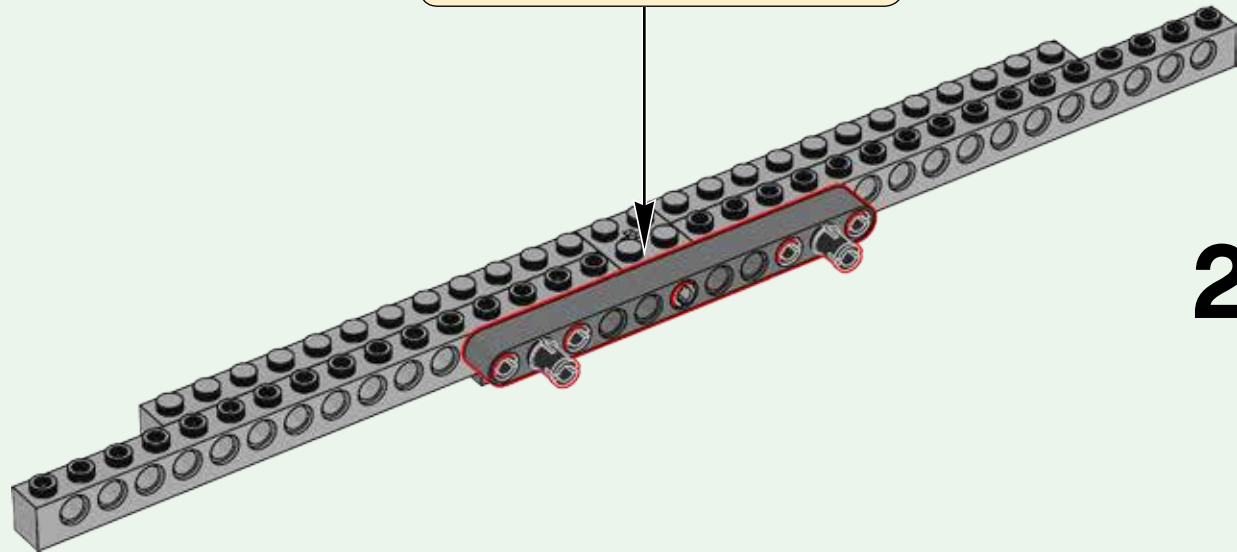
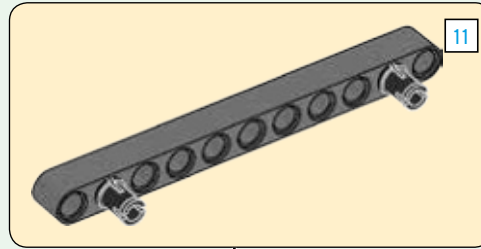

173

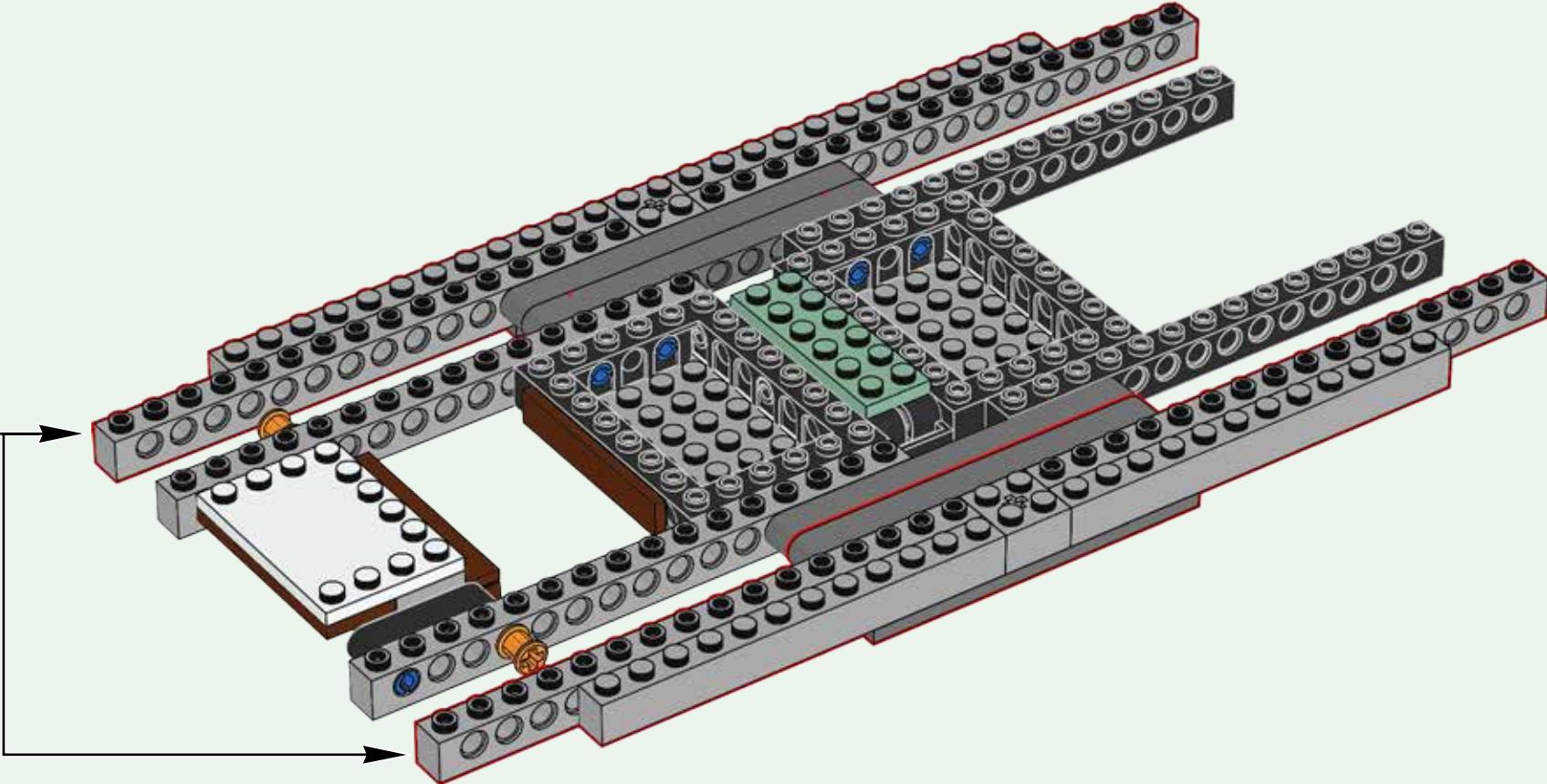

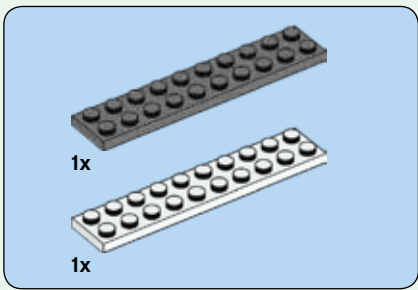

174

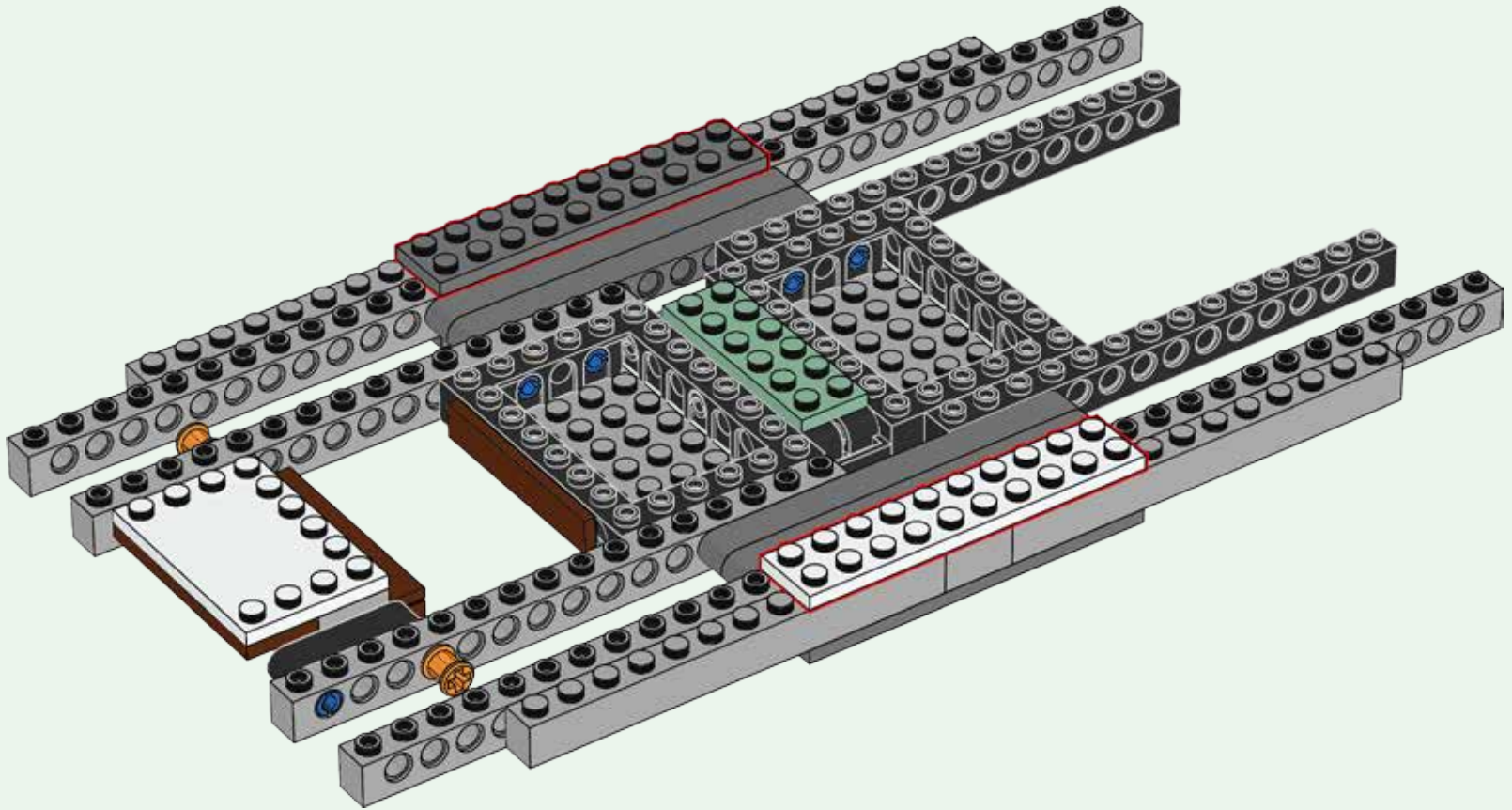

175

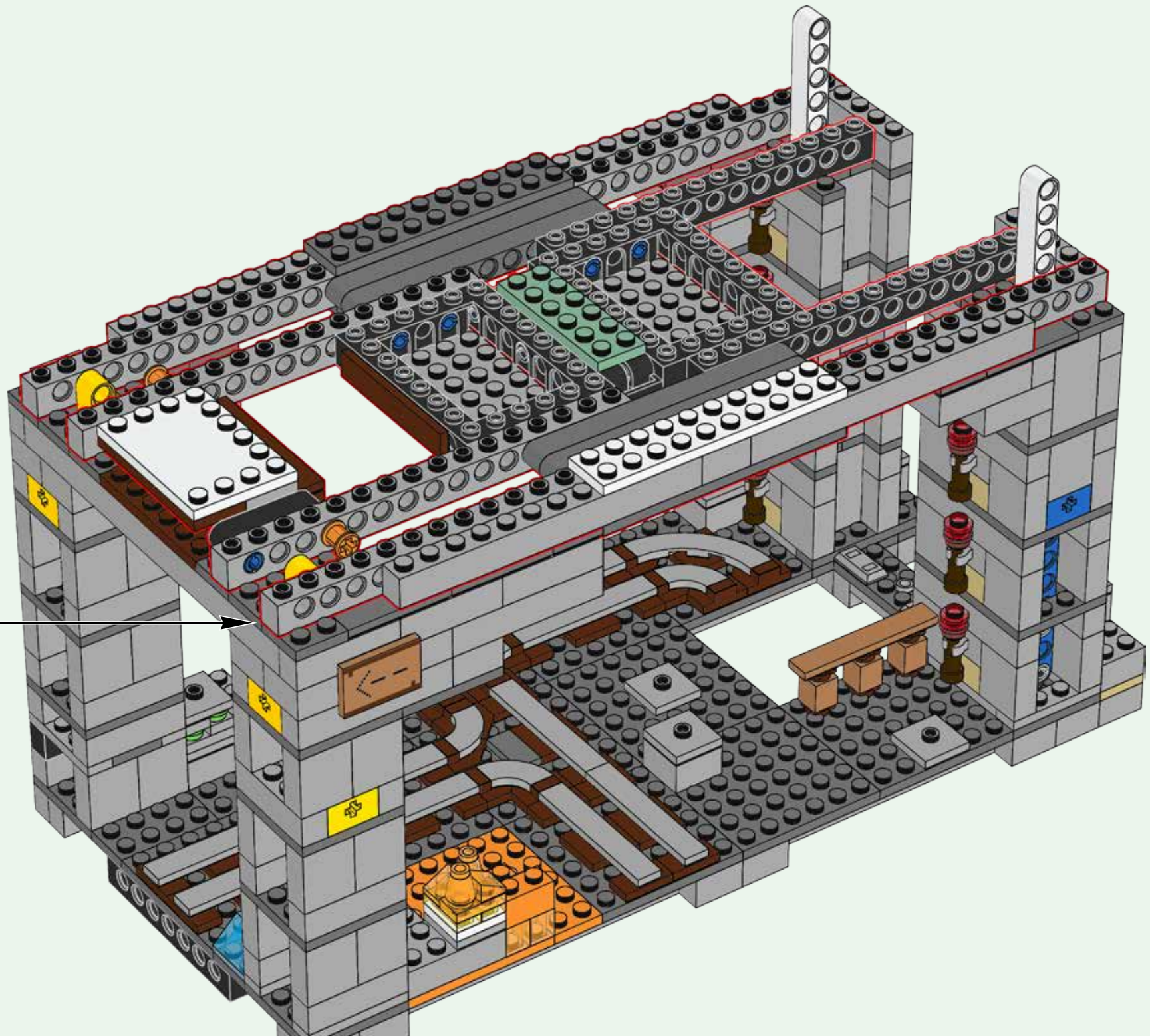

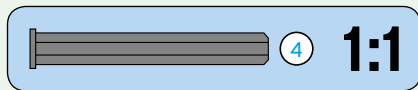
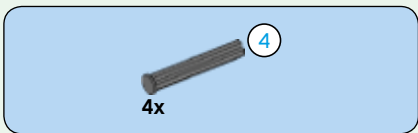

176

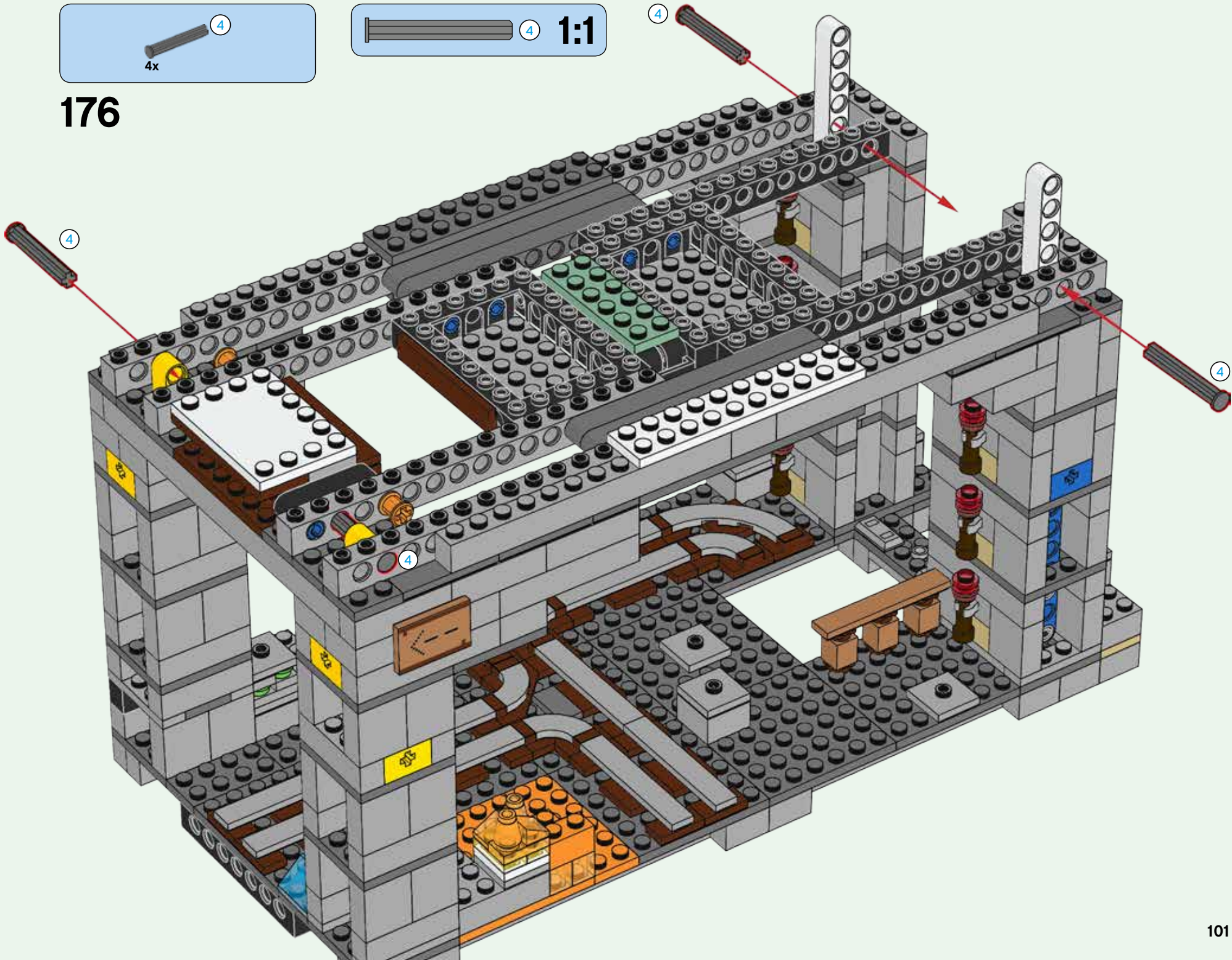

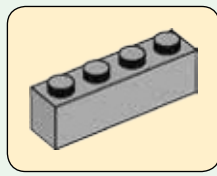
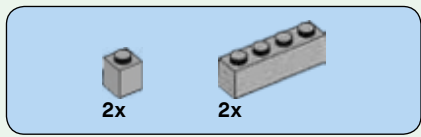

177





178



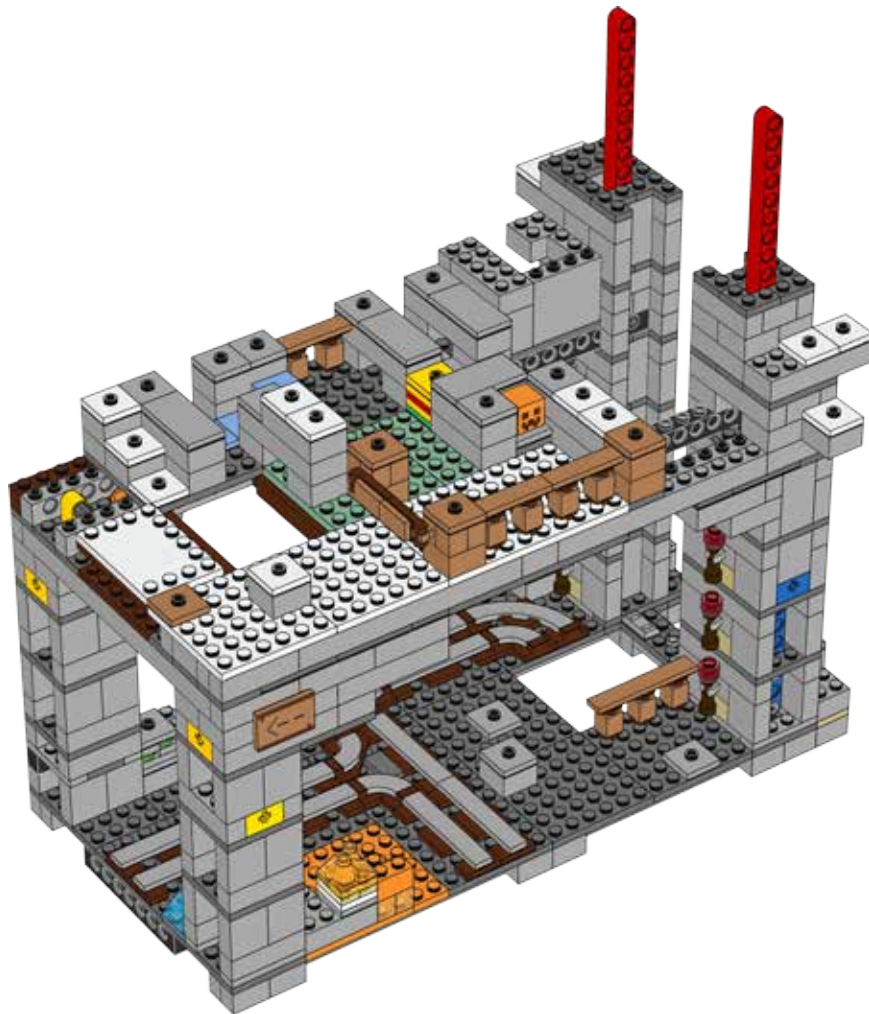

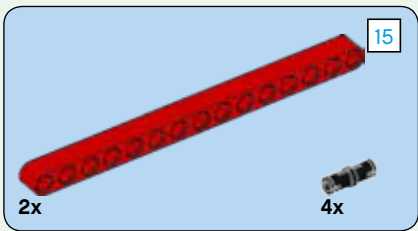

179

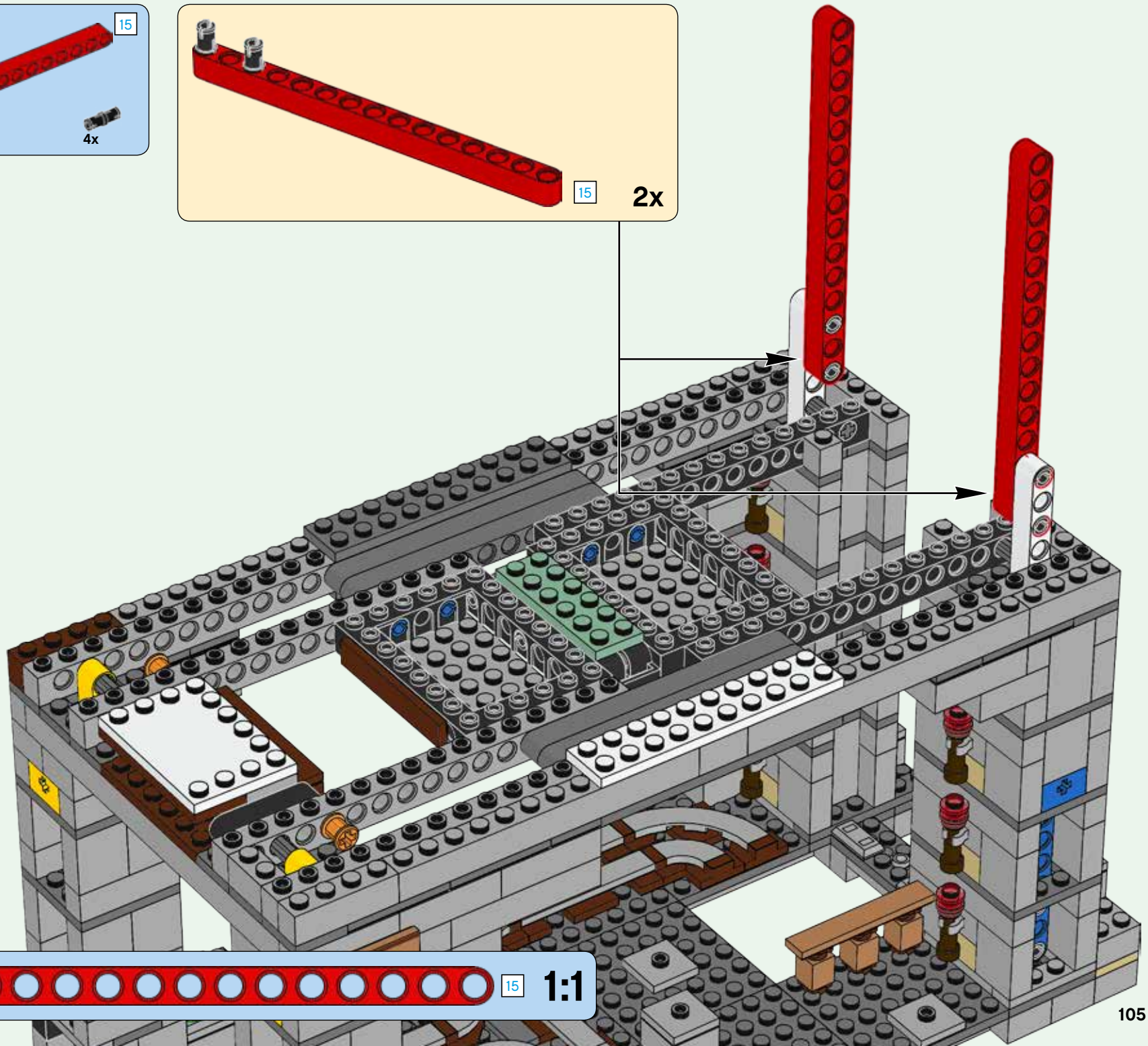
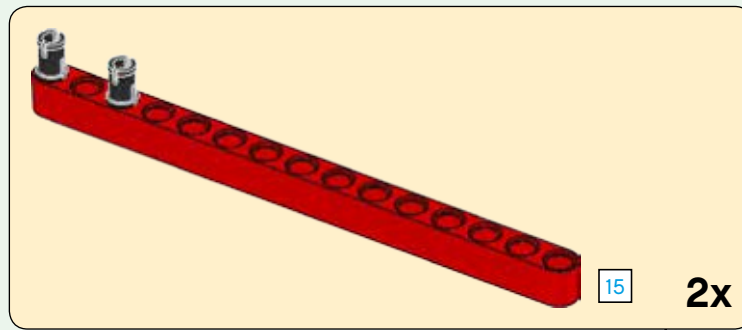

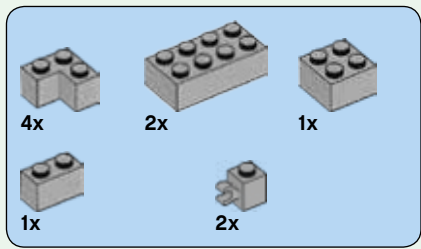

180

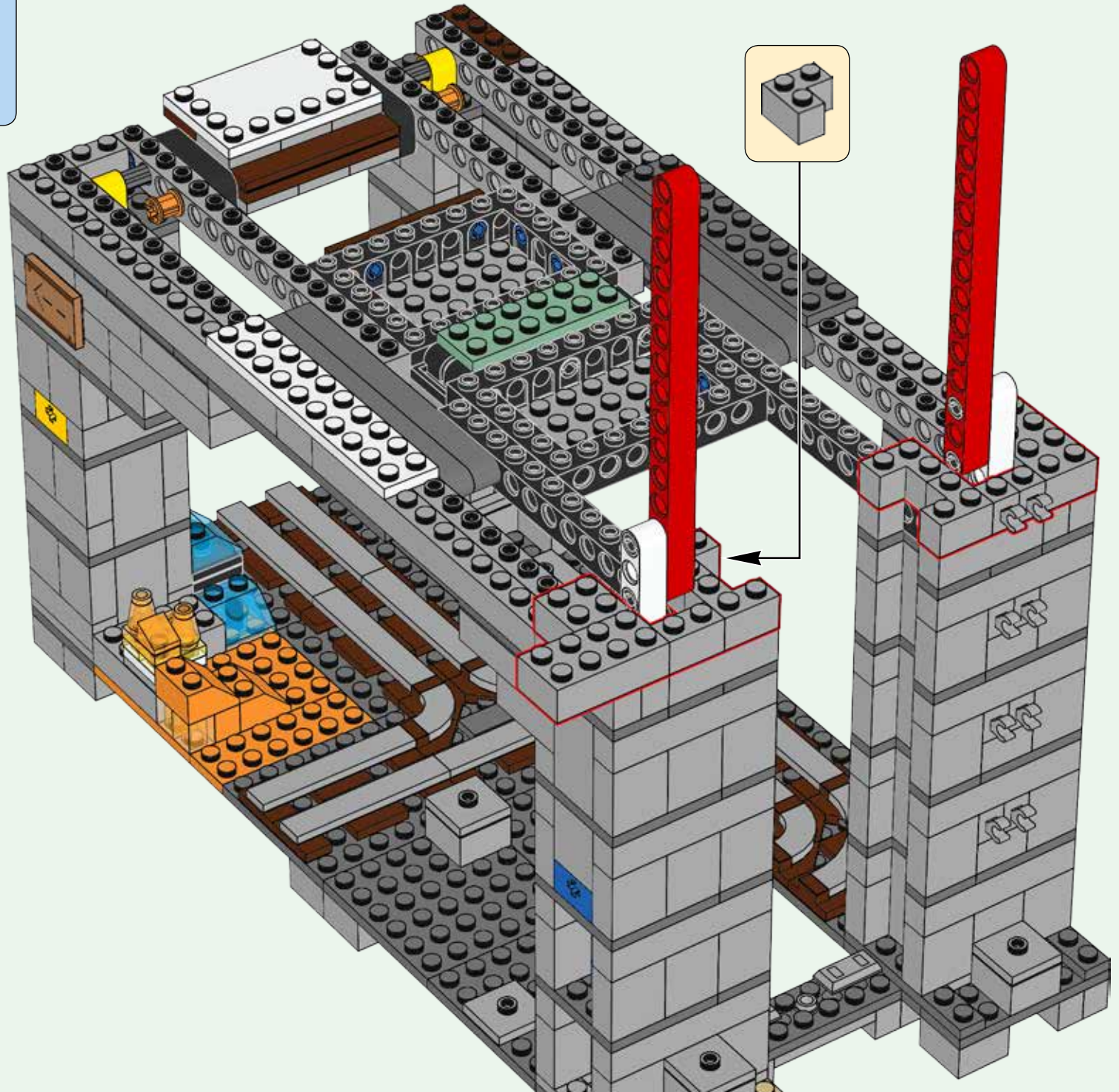

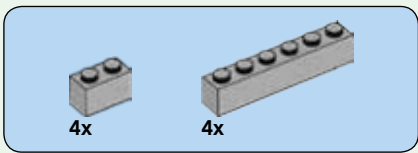

181

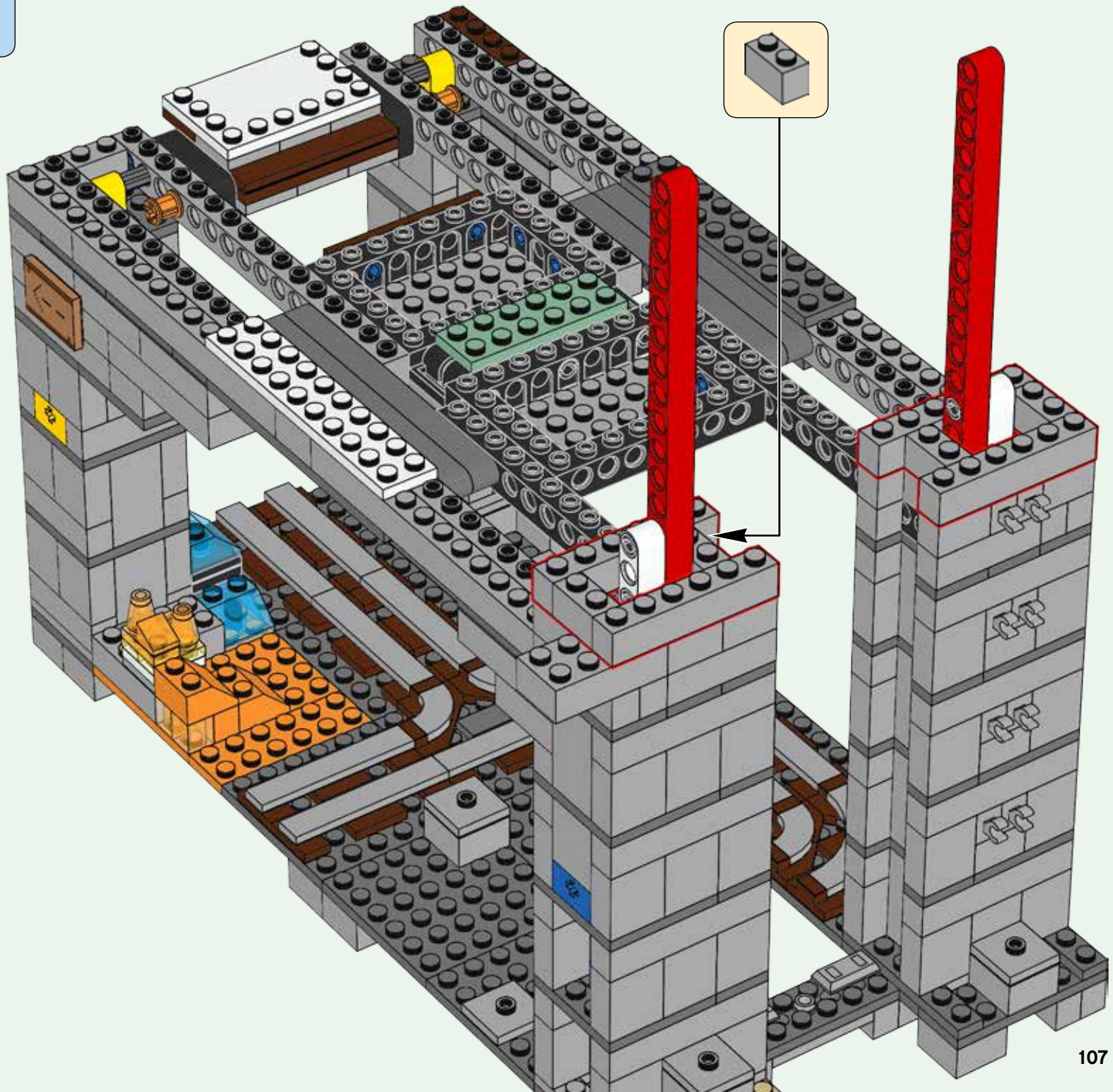

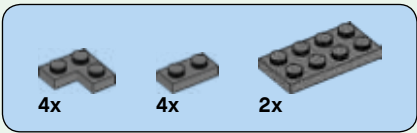

182

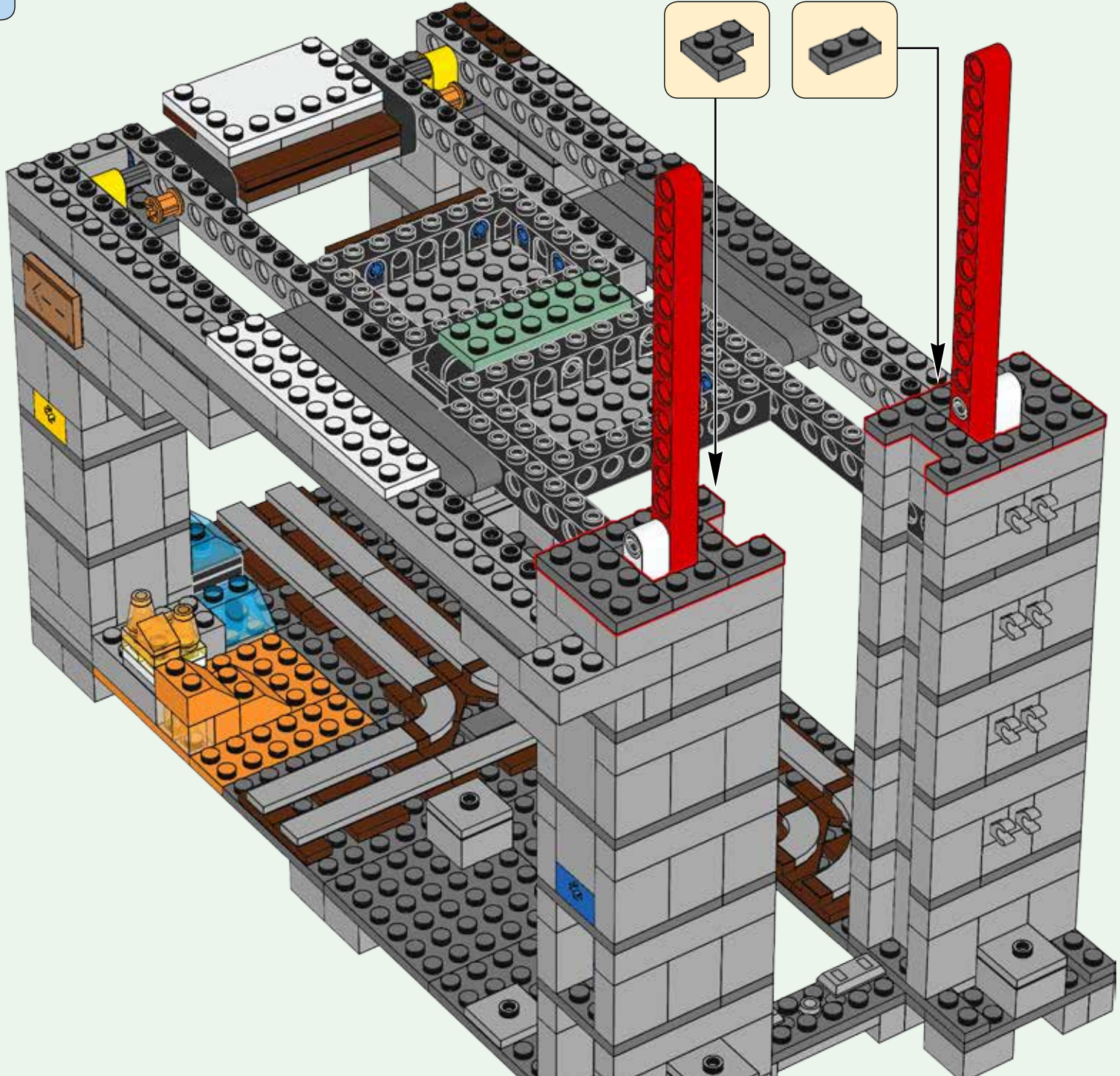

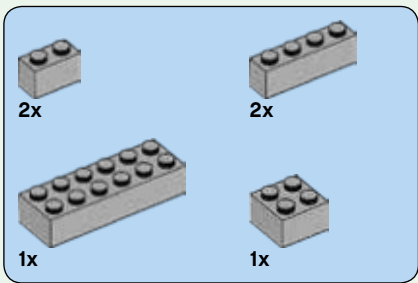

183

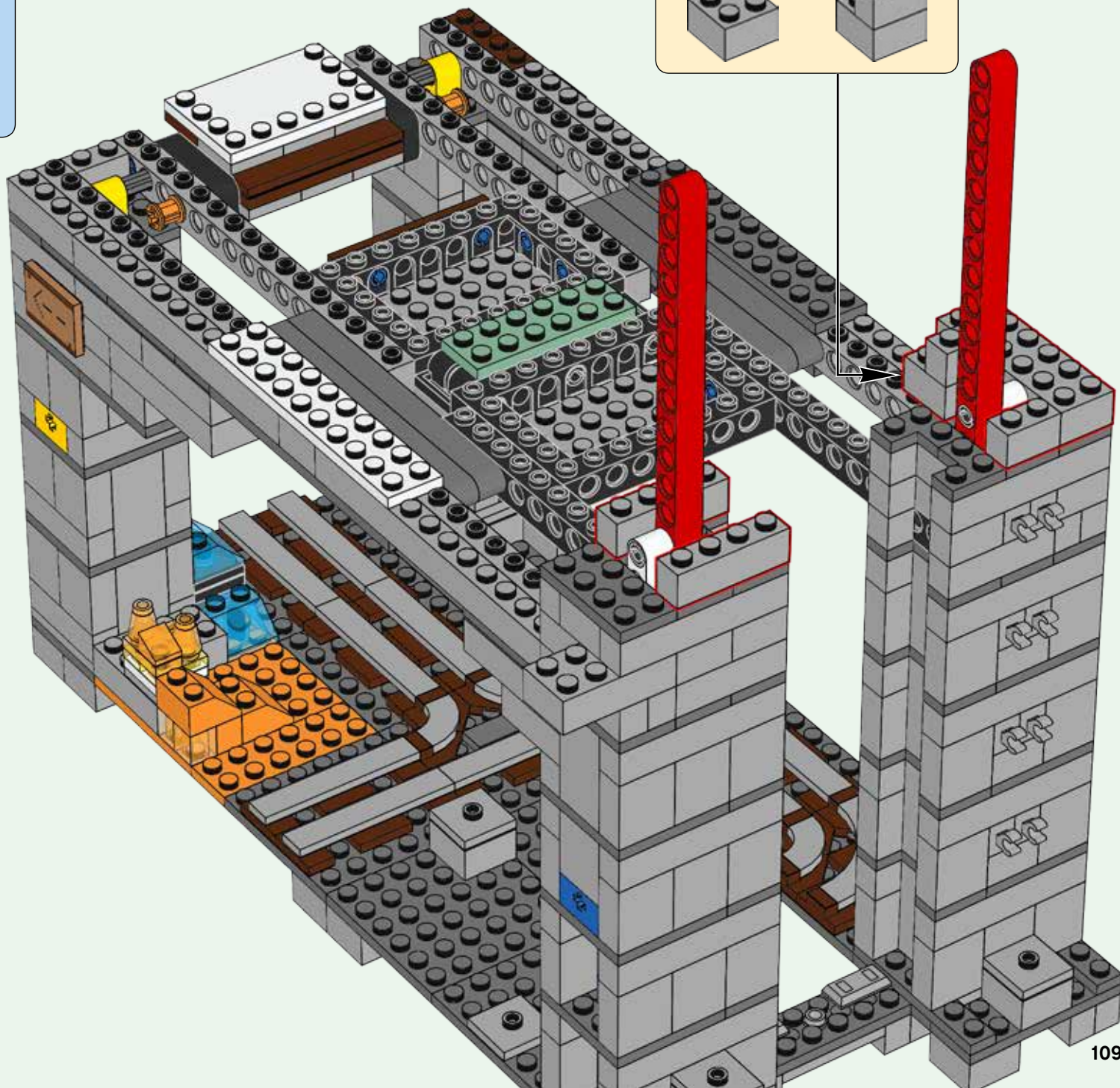
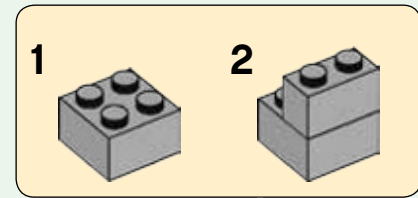

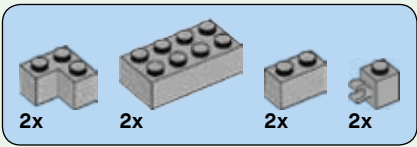

184

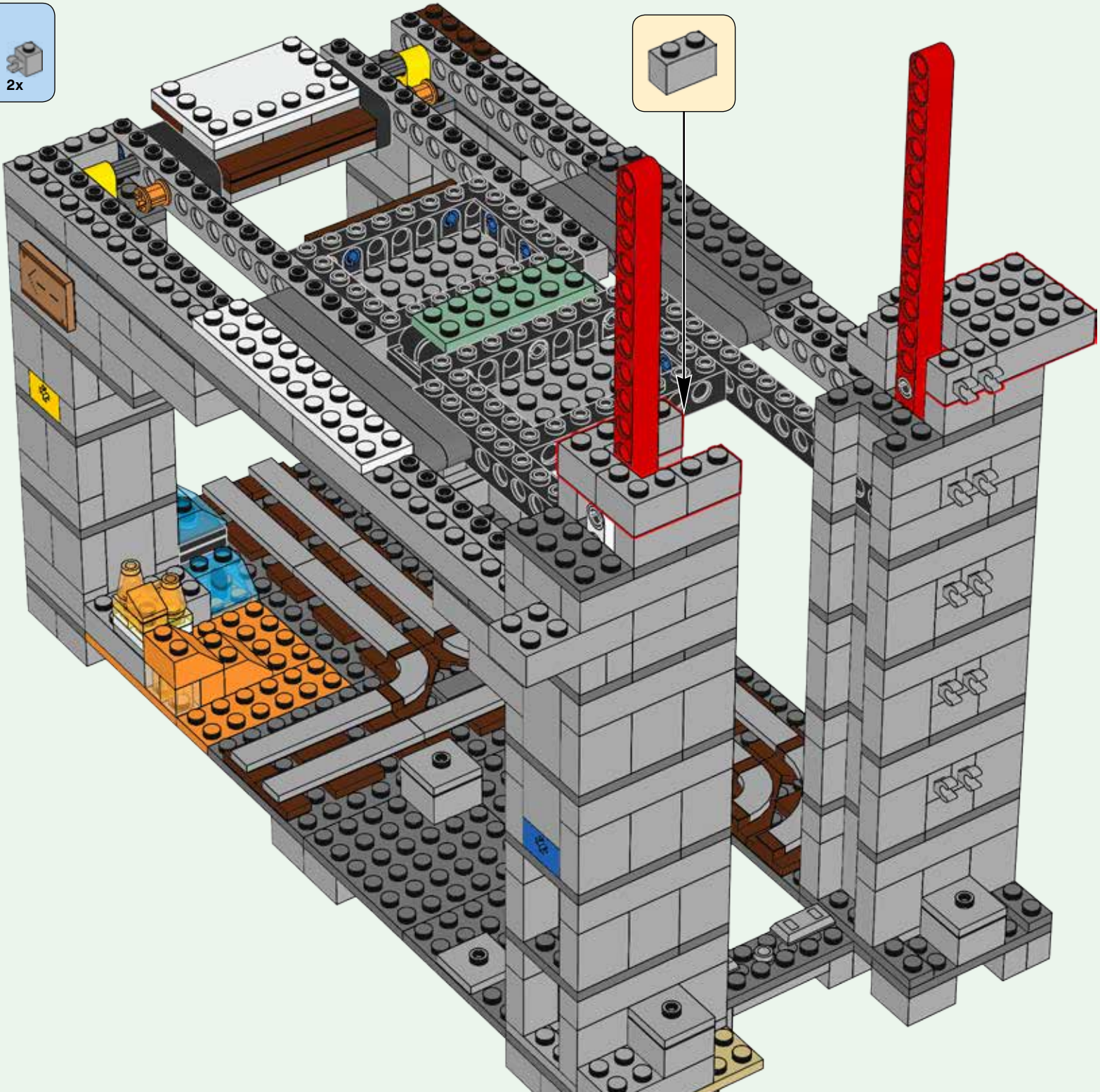

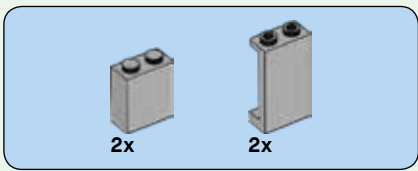

185

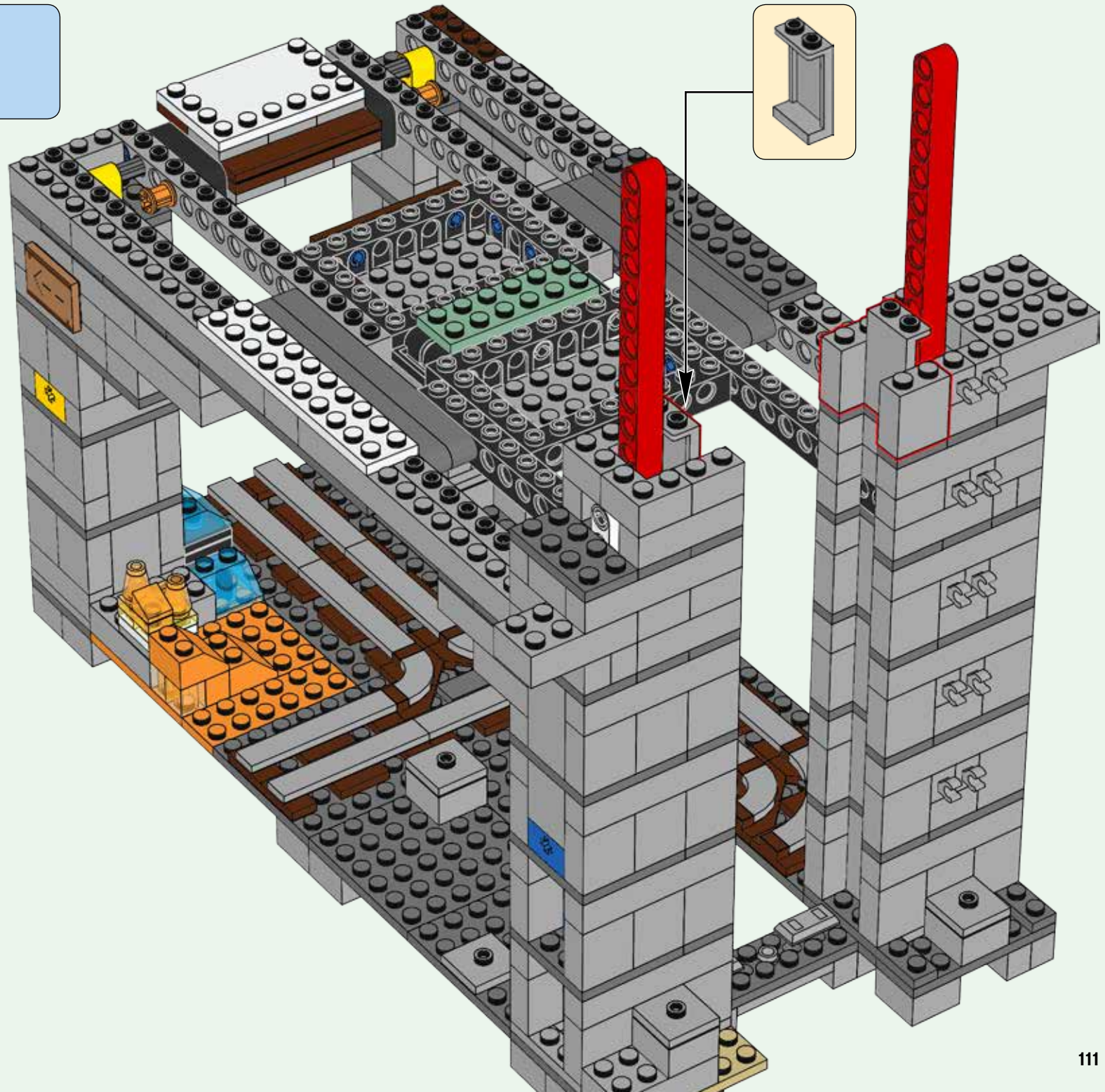

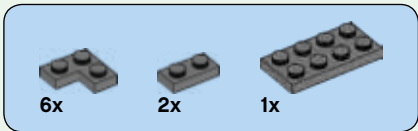

187

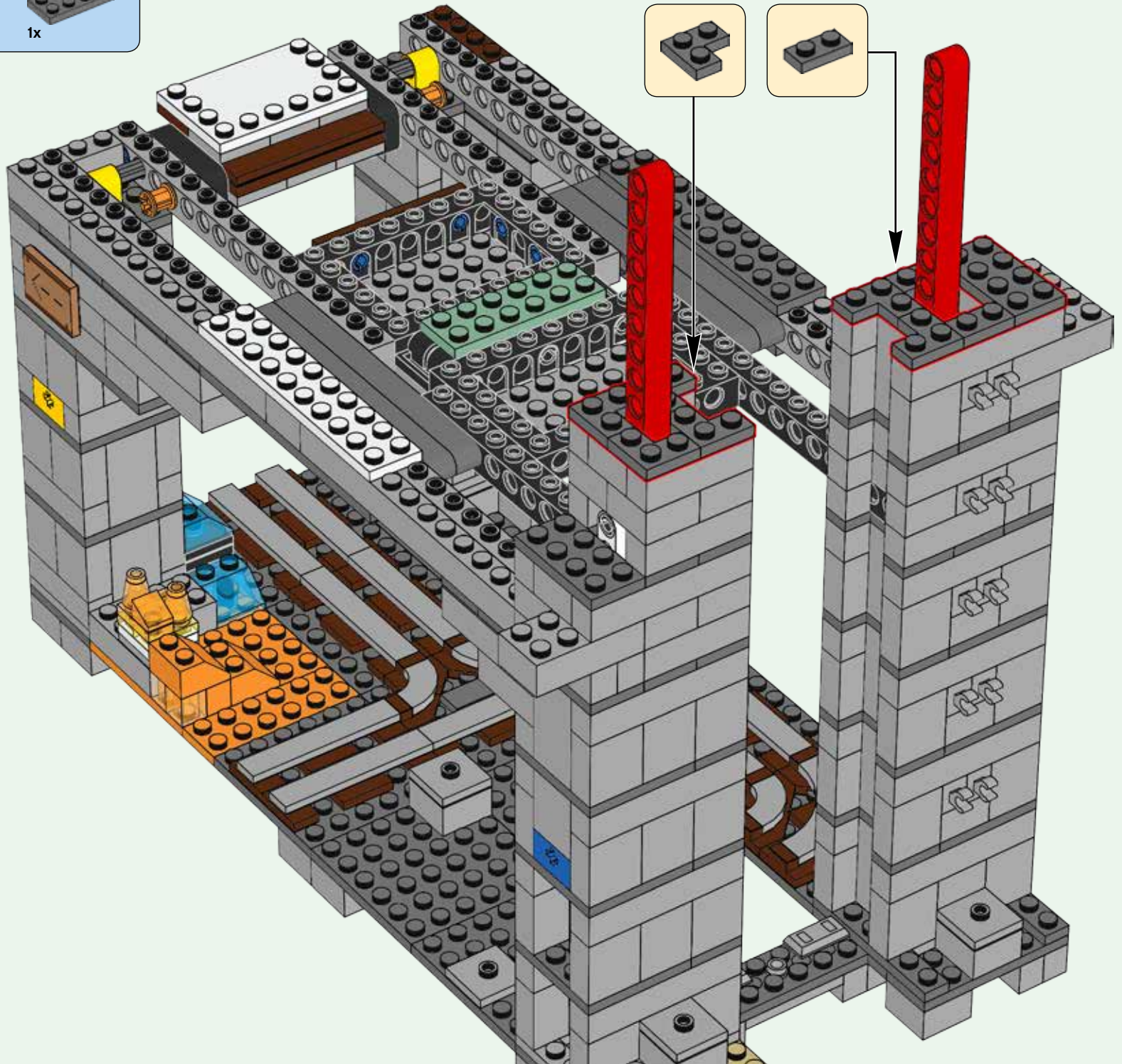

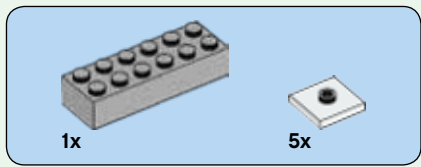

188

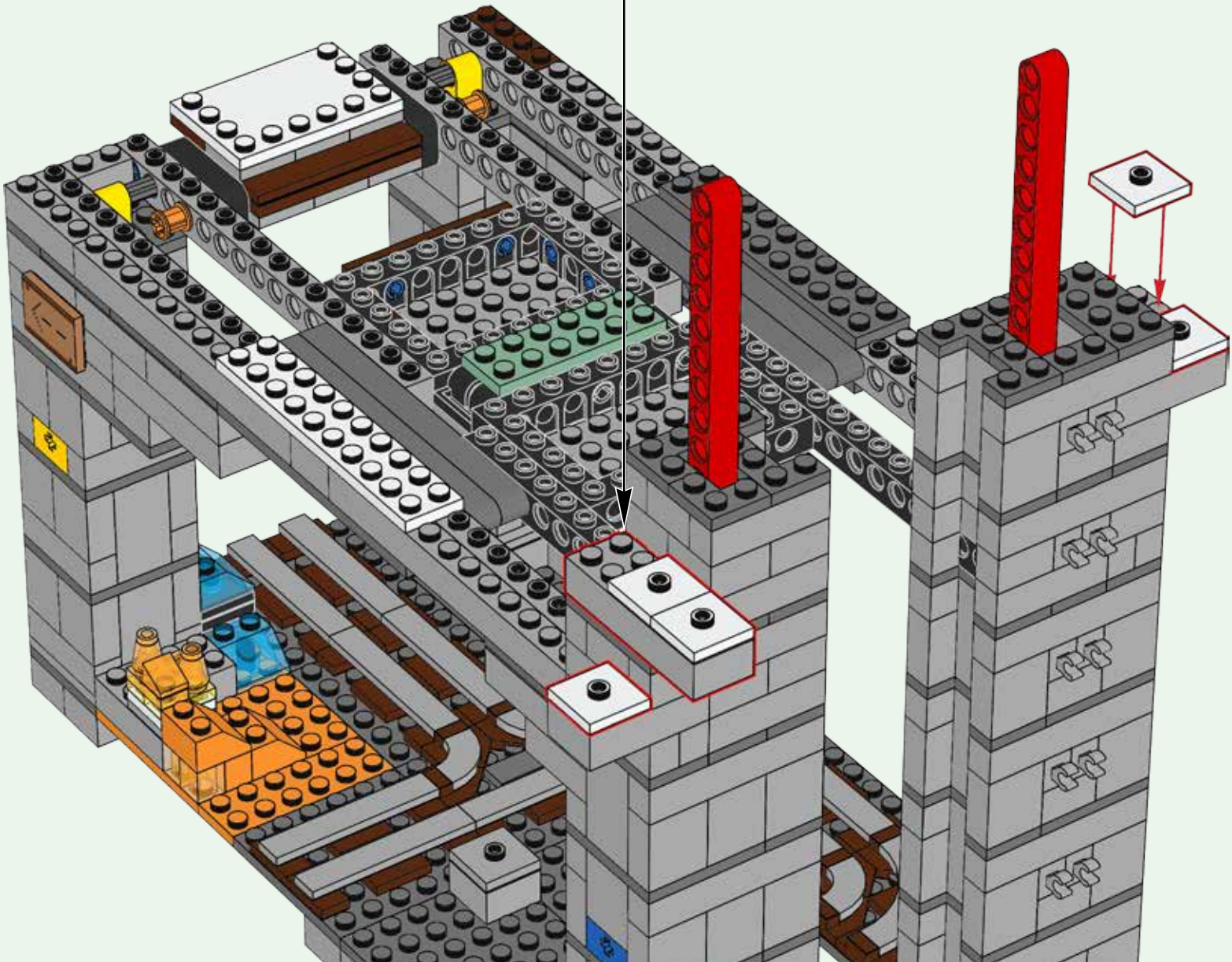
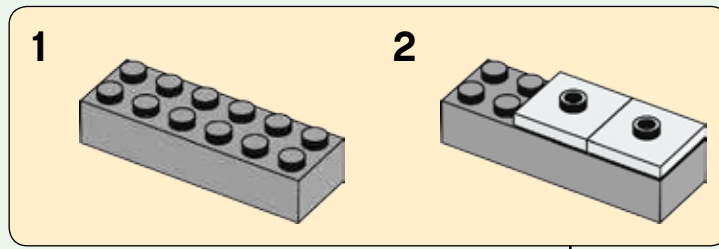

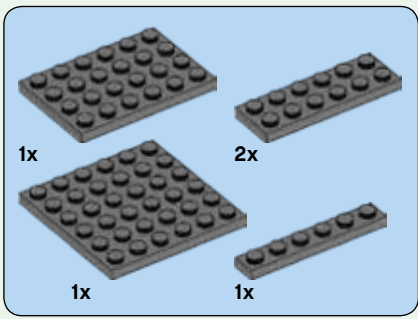

189

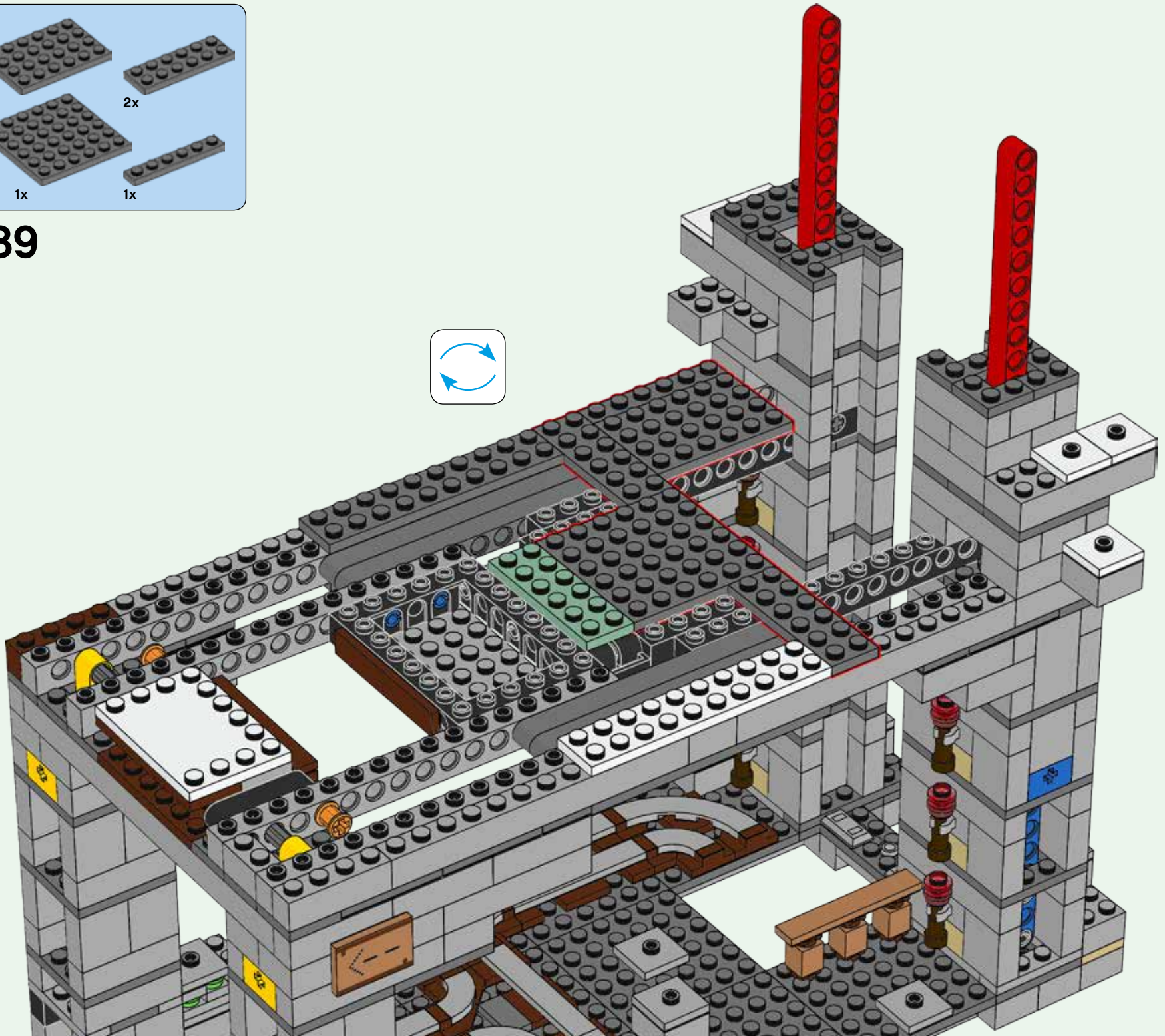
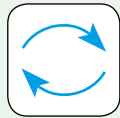

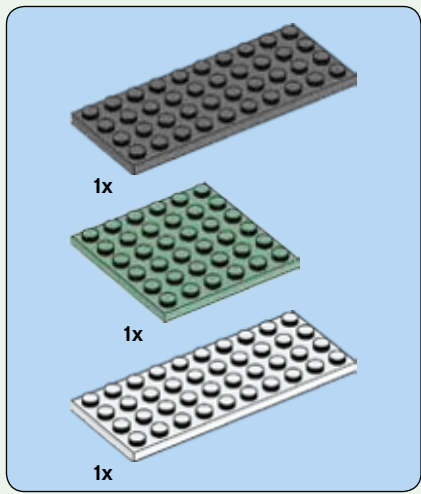

190

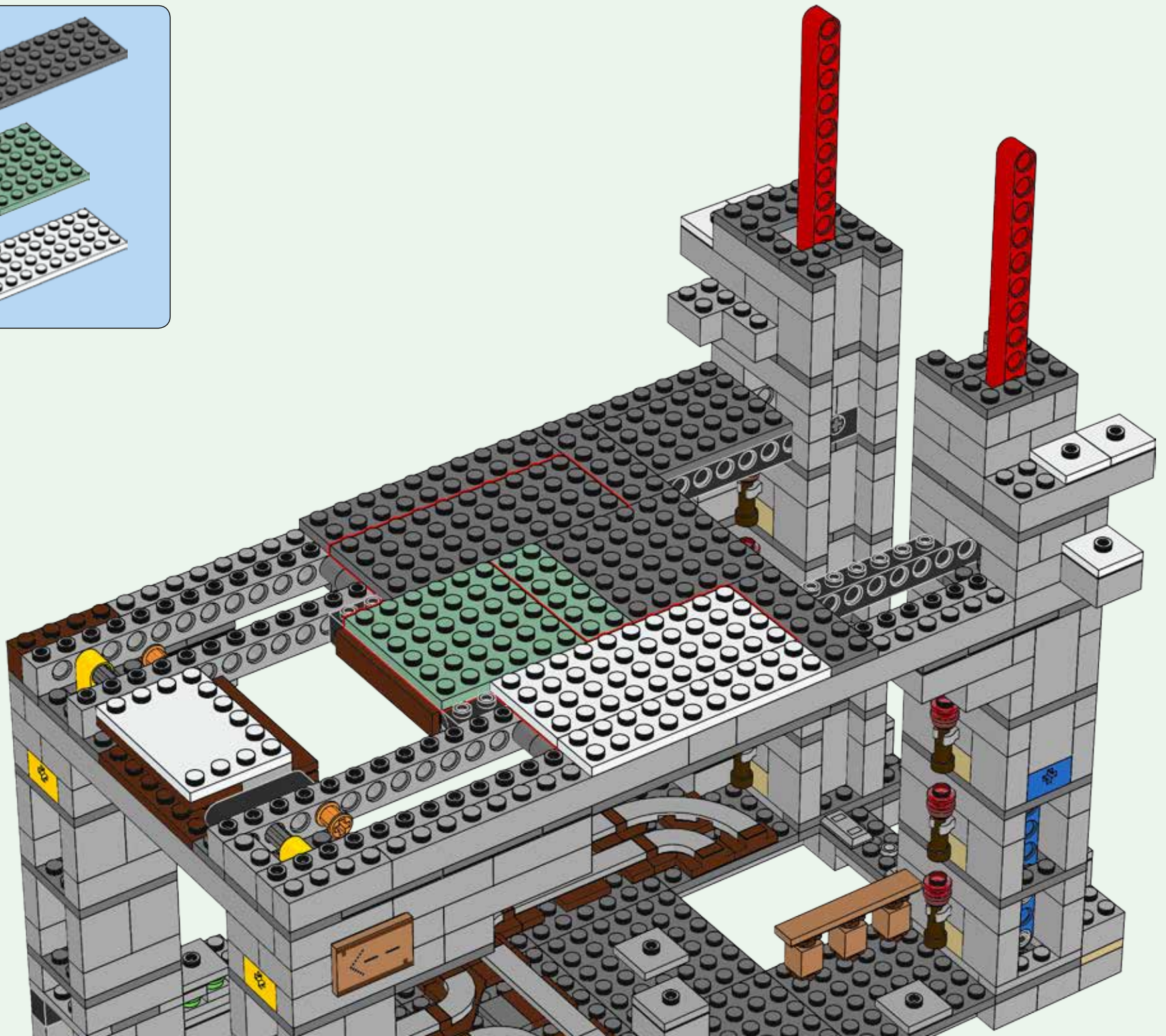

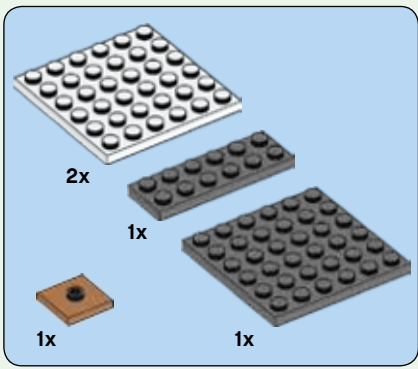

191

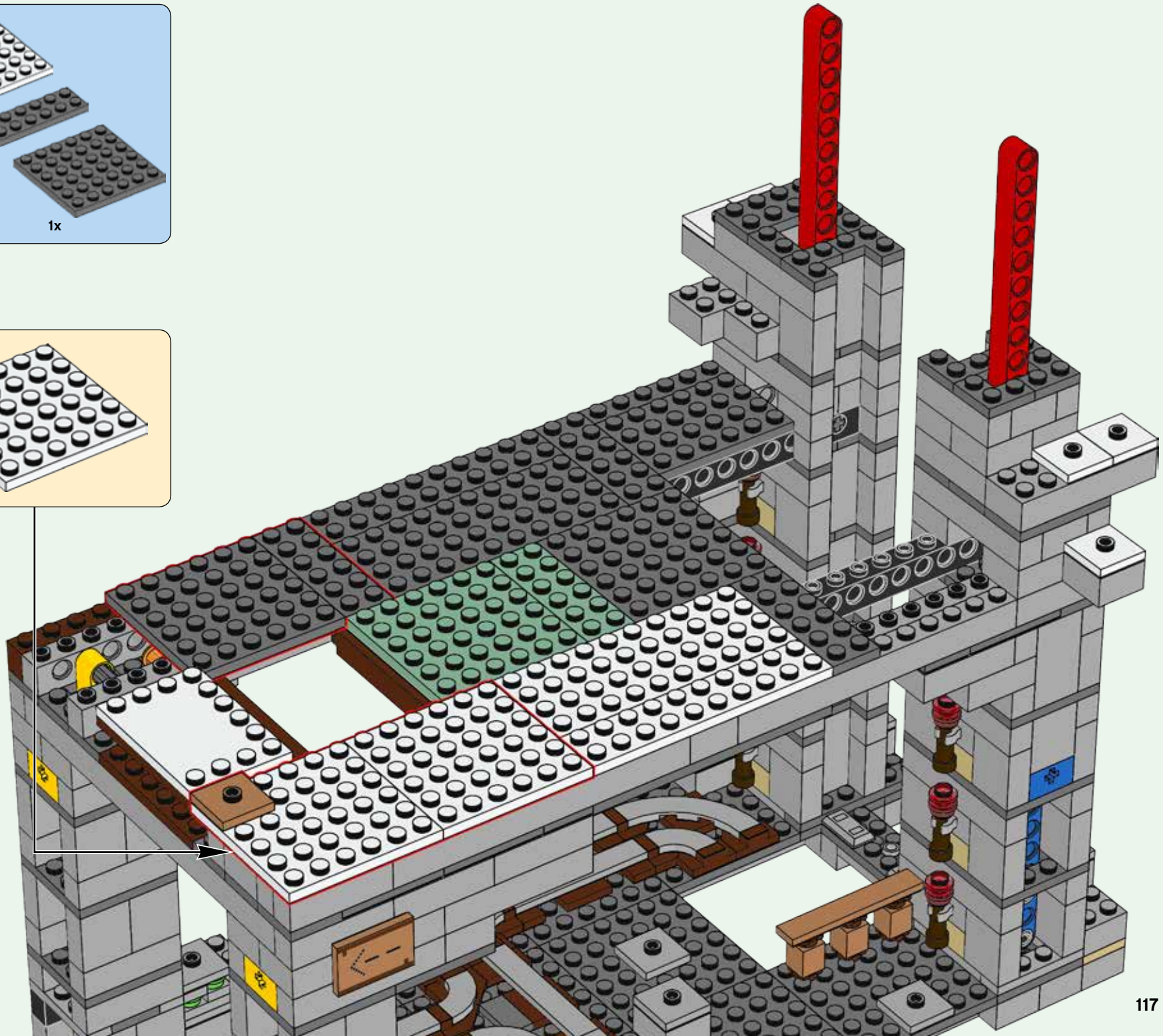
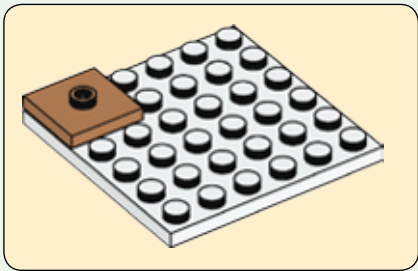

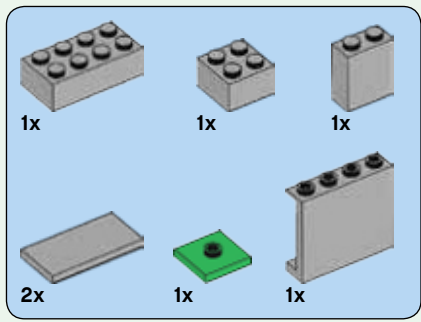

192

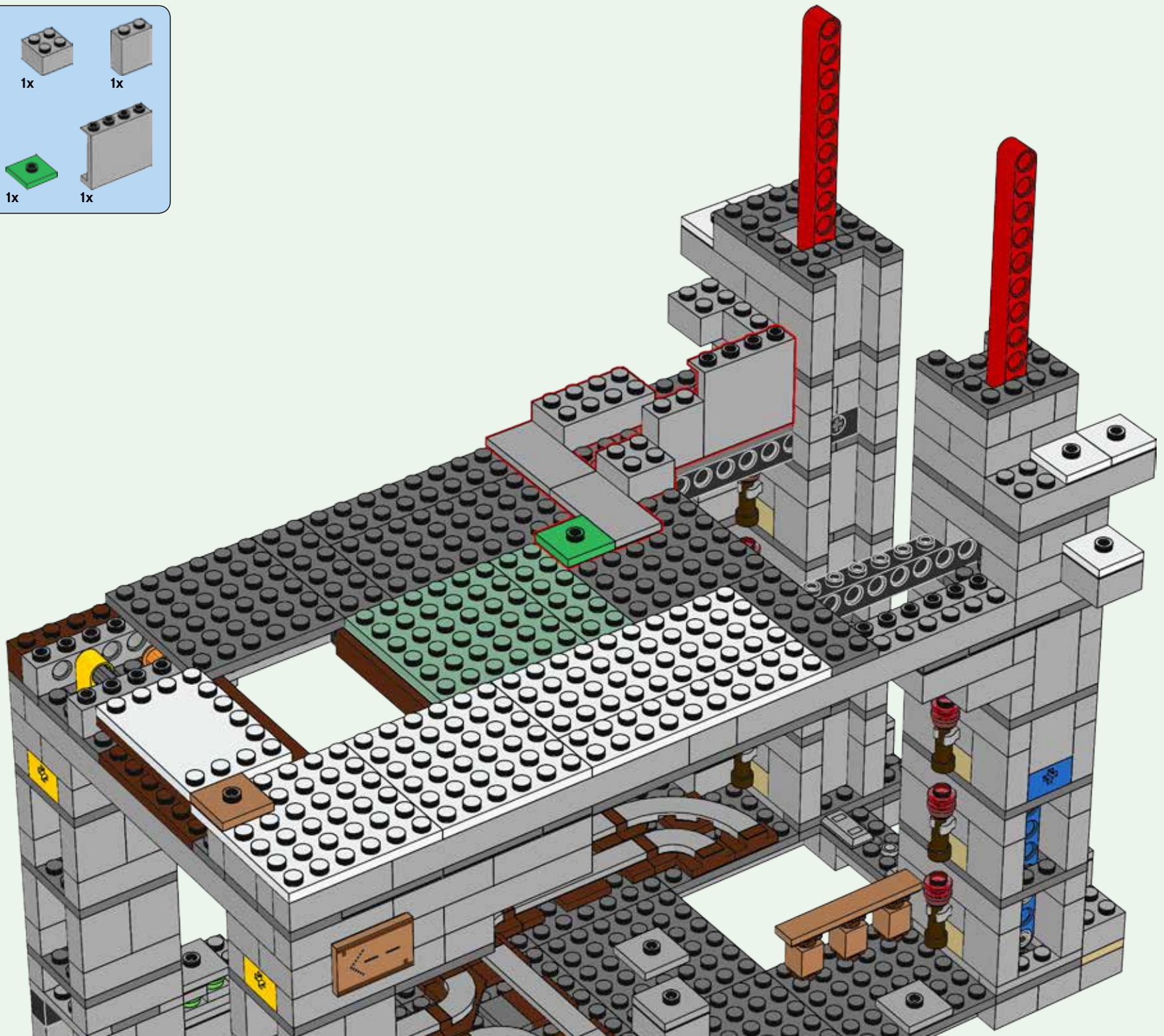

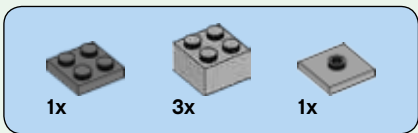

193

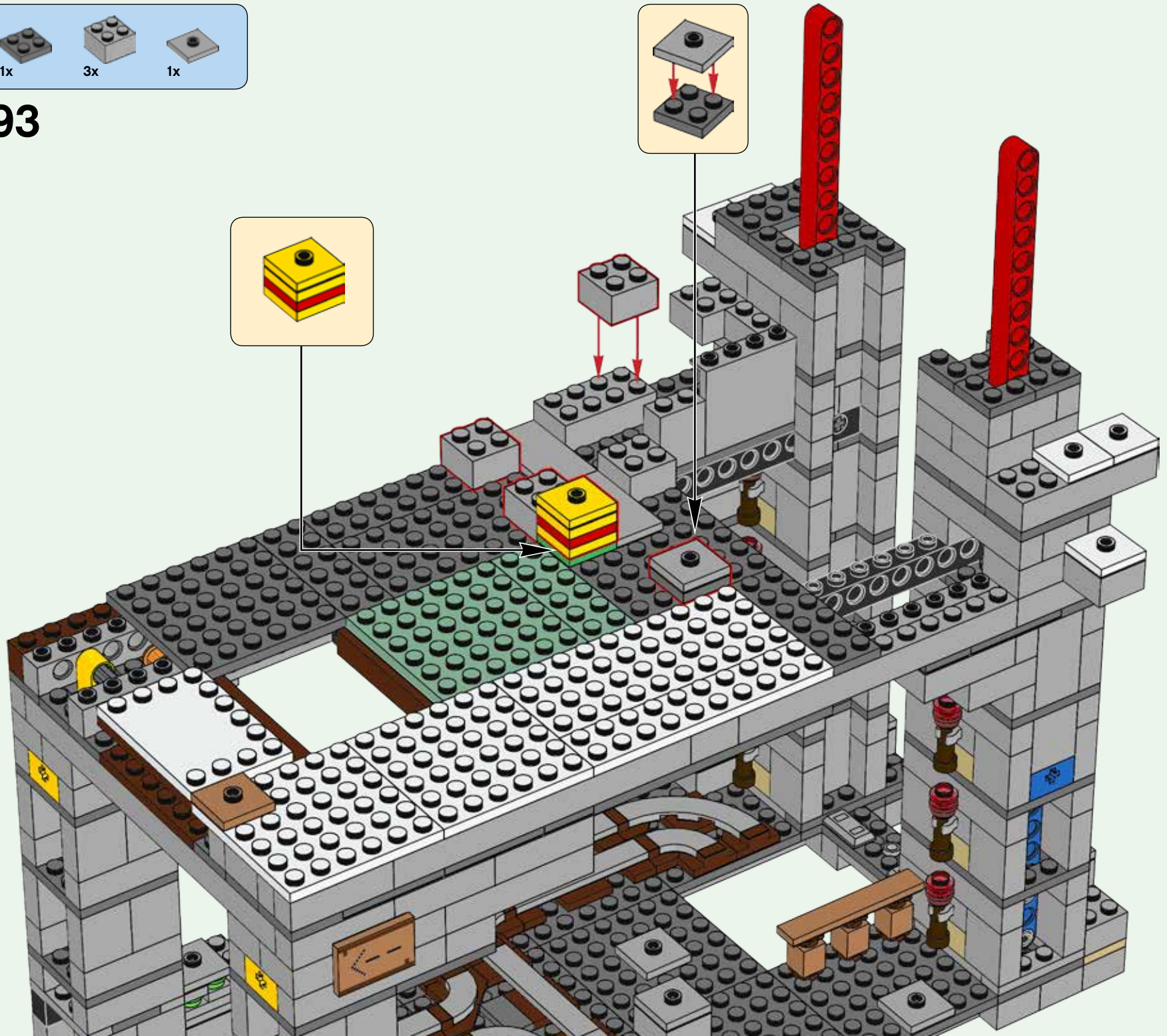

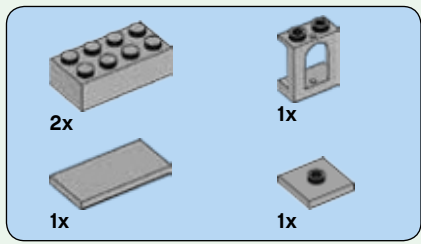

194

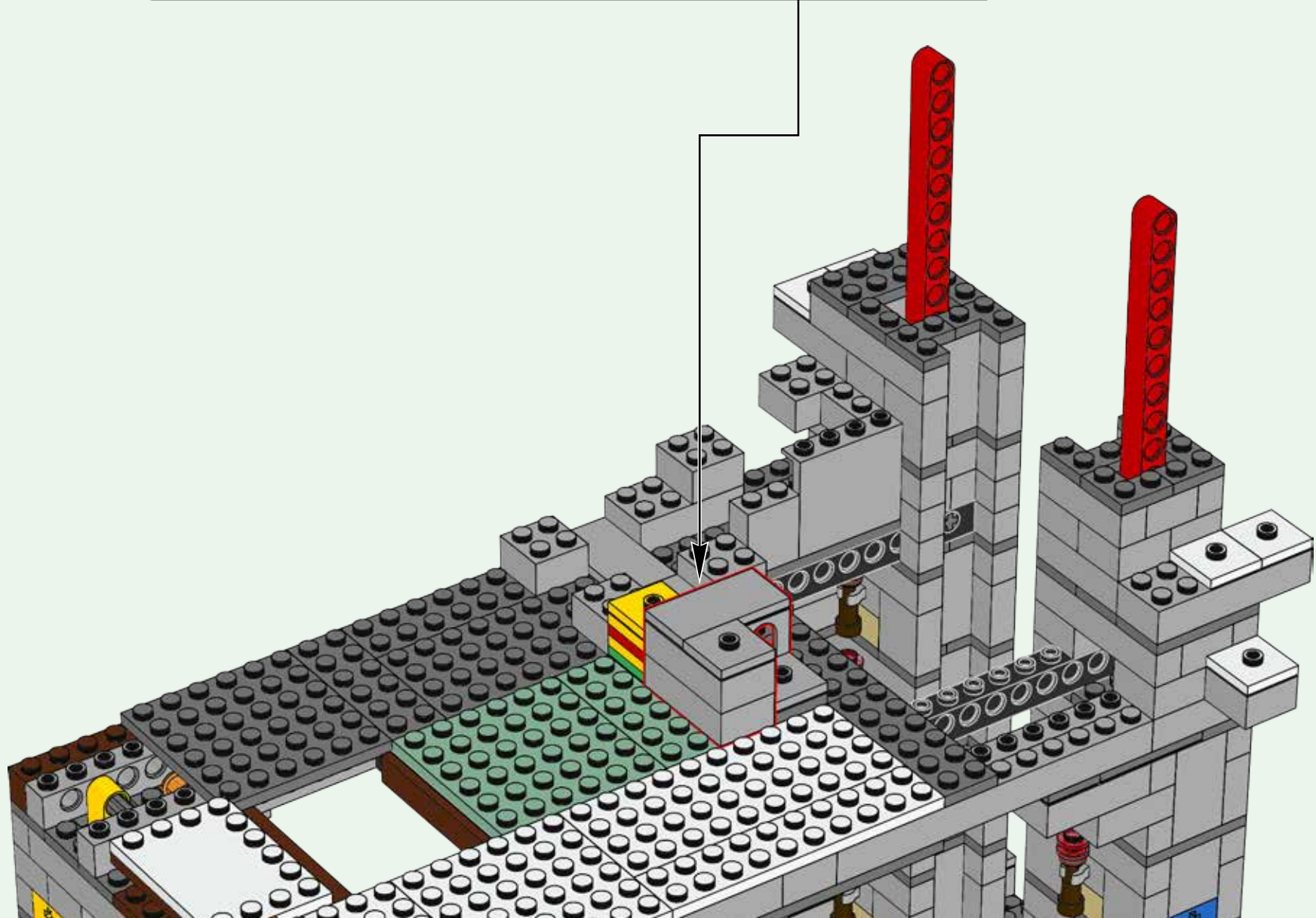
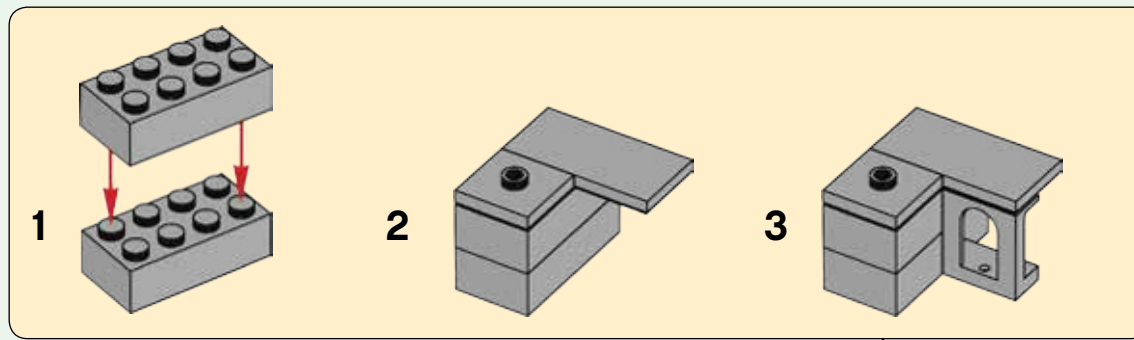

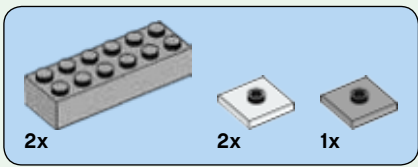

195

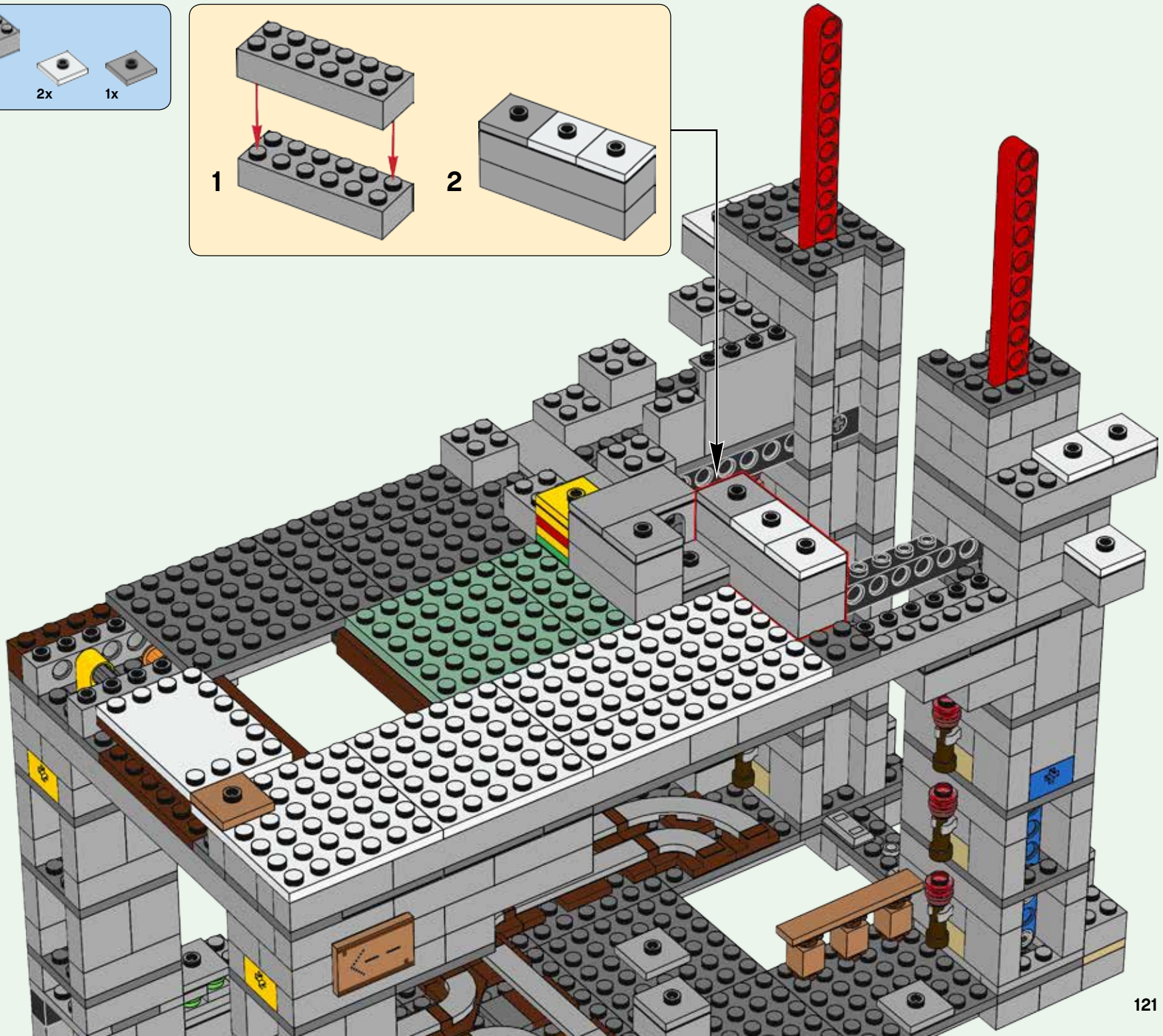
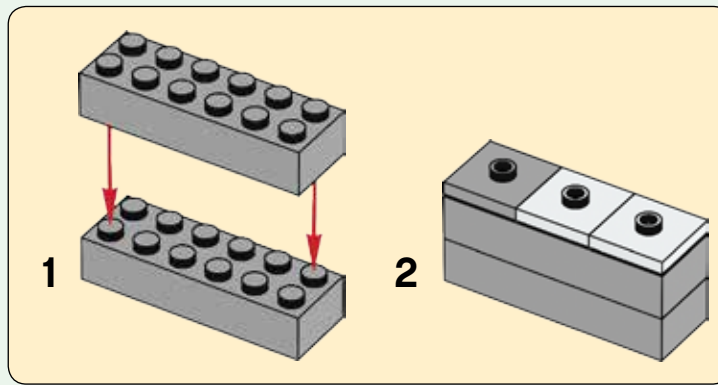

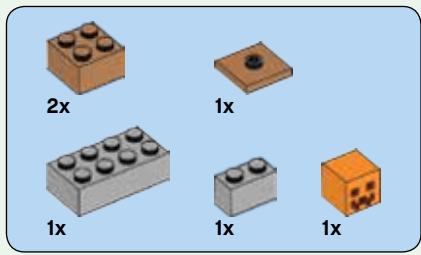

196

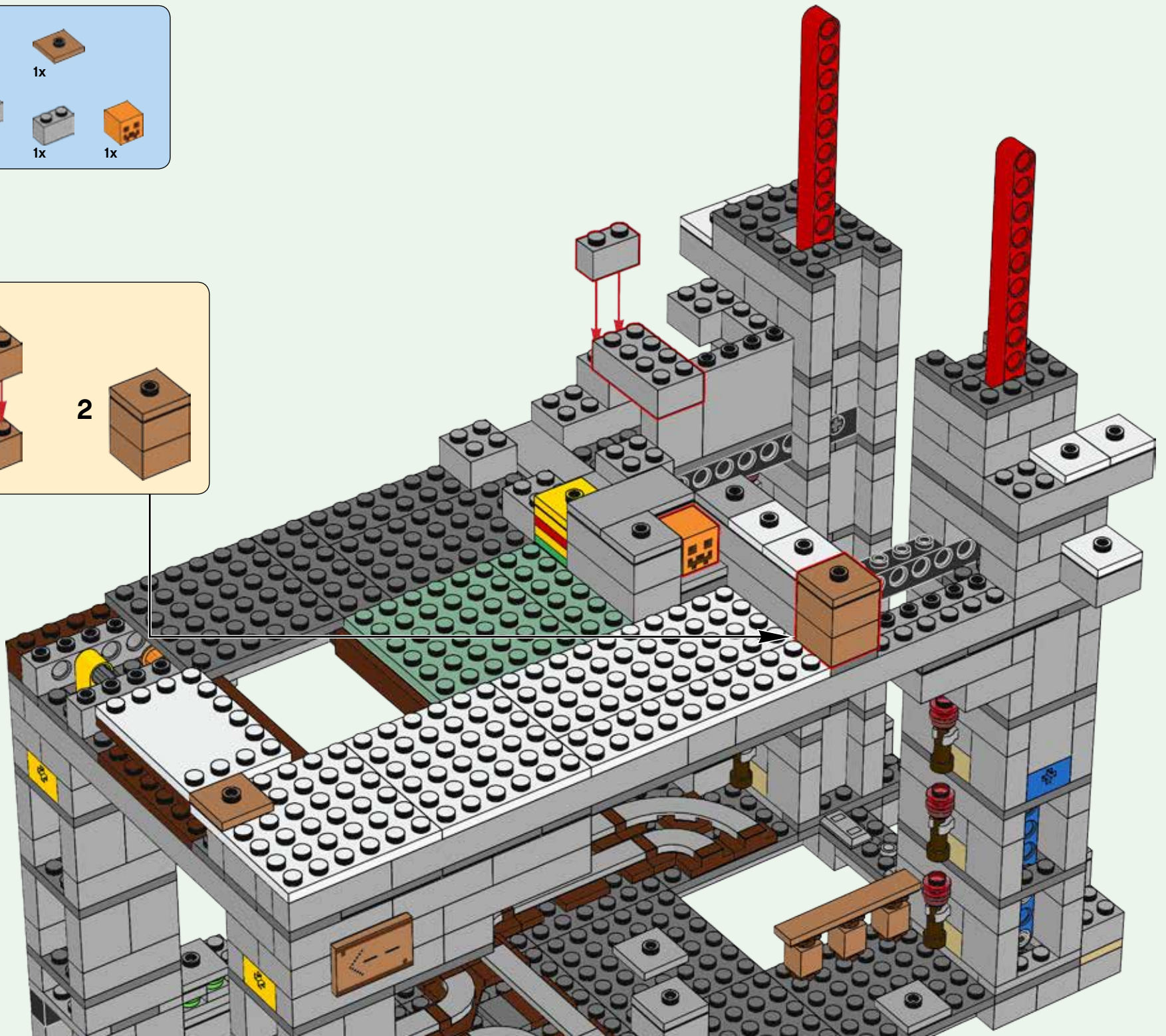
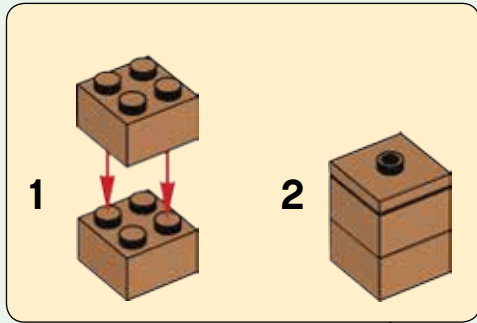

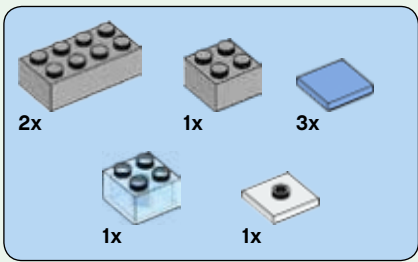

197

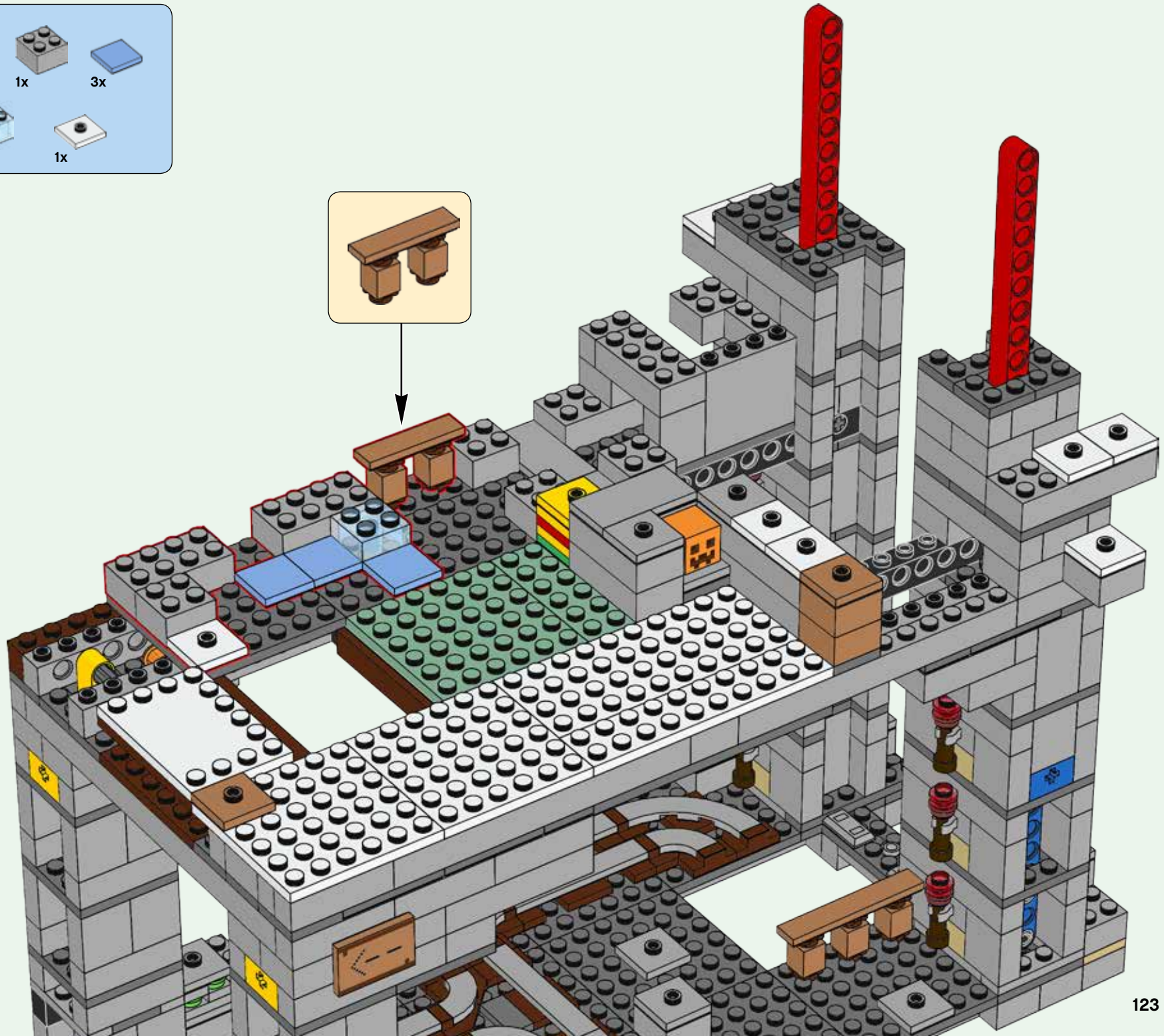
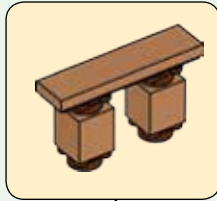

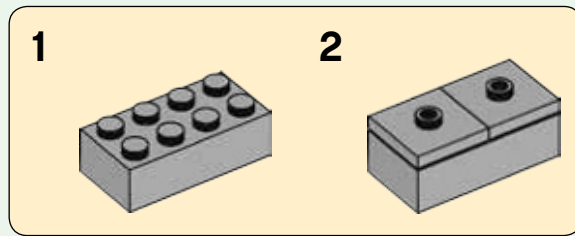
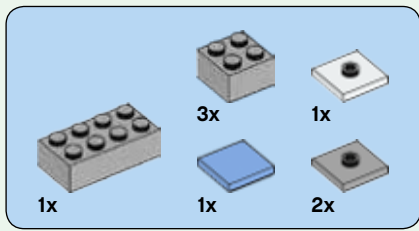

198

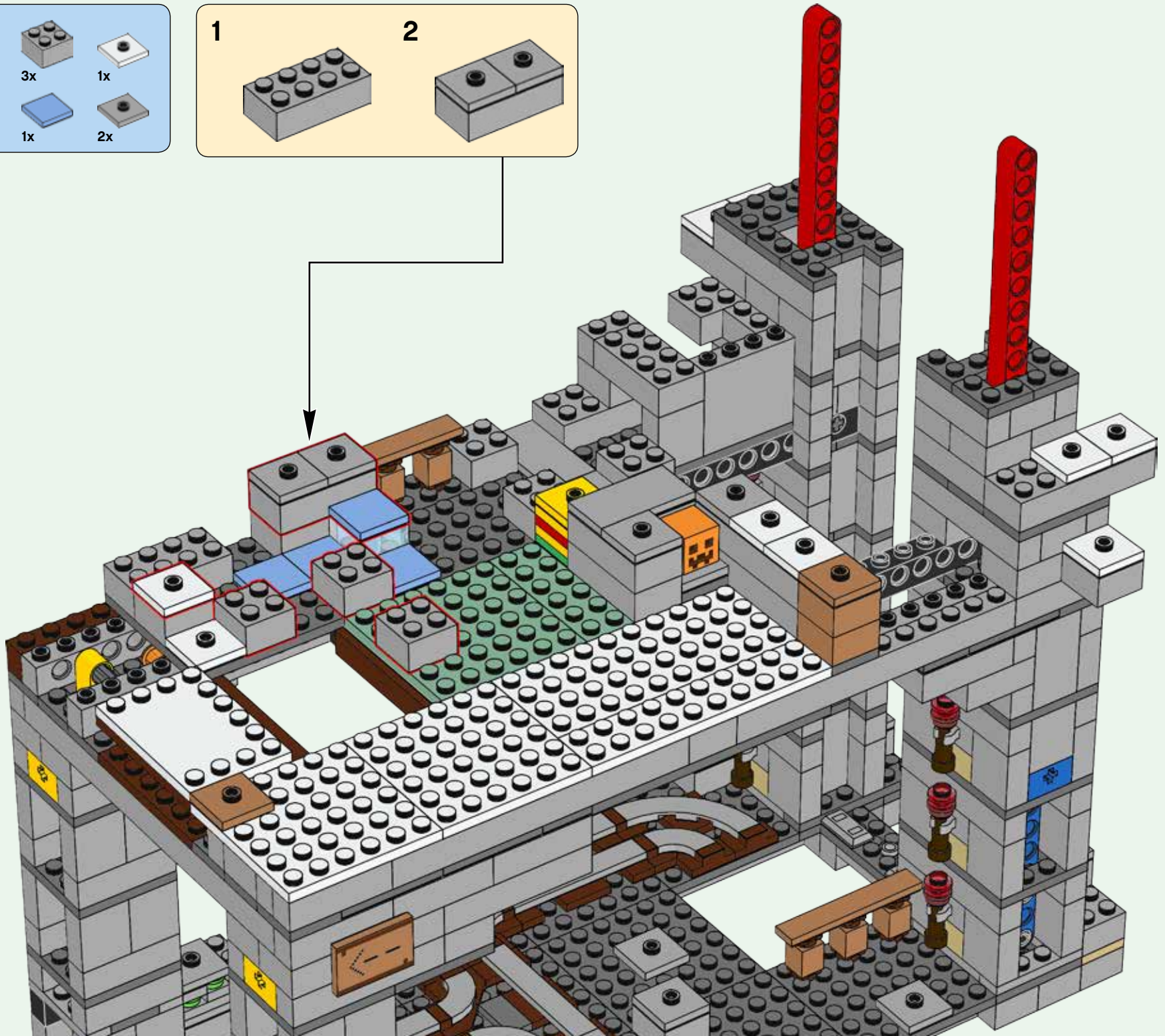

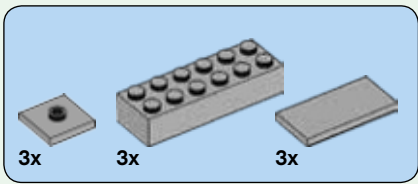

199

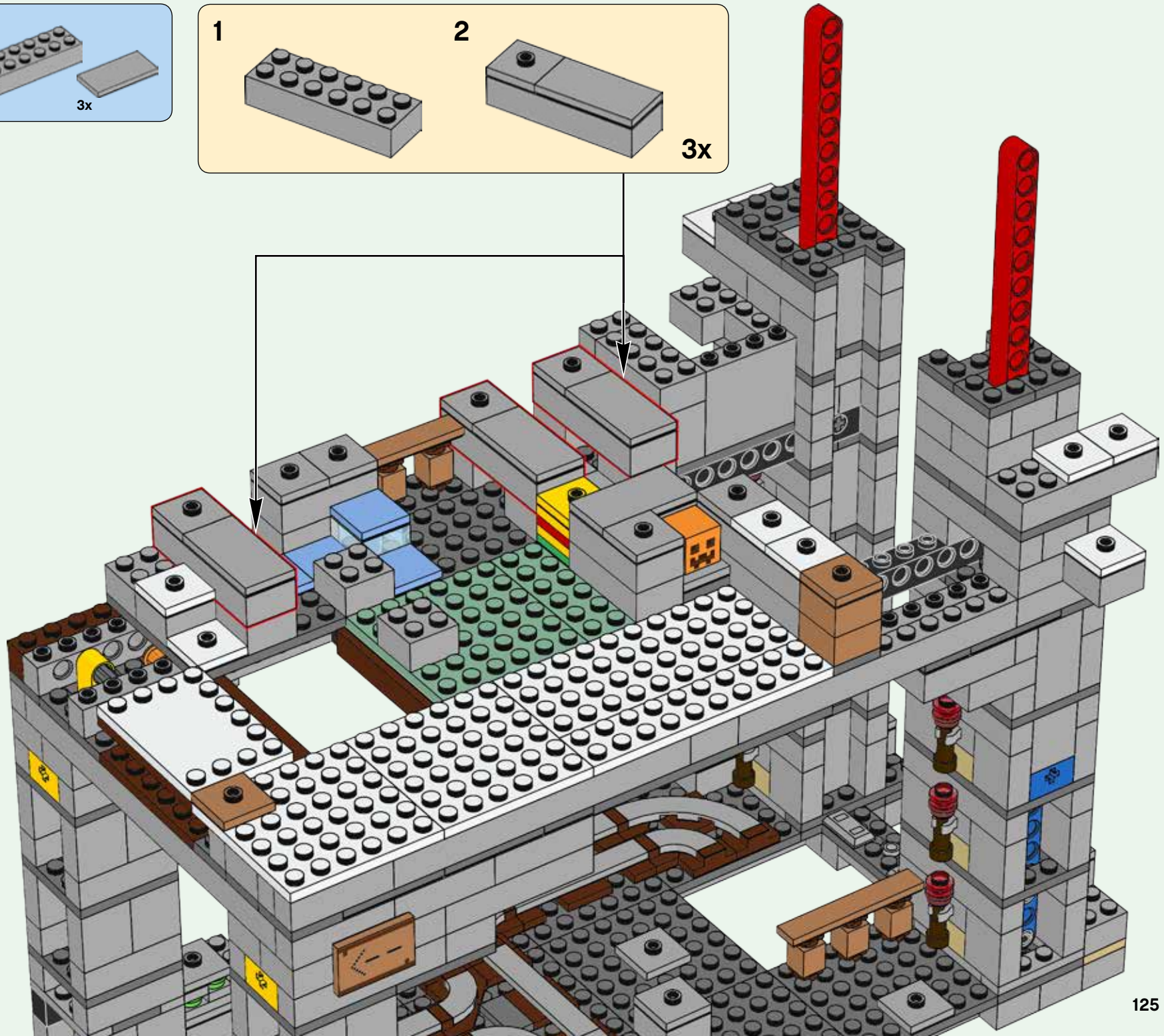
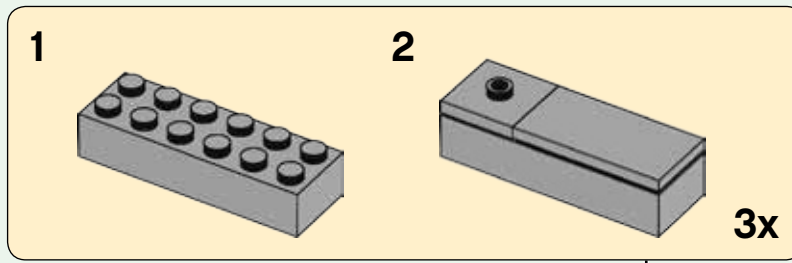

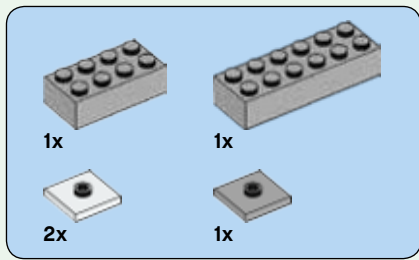

200

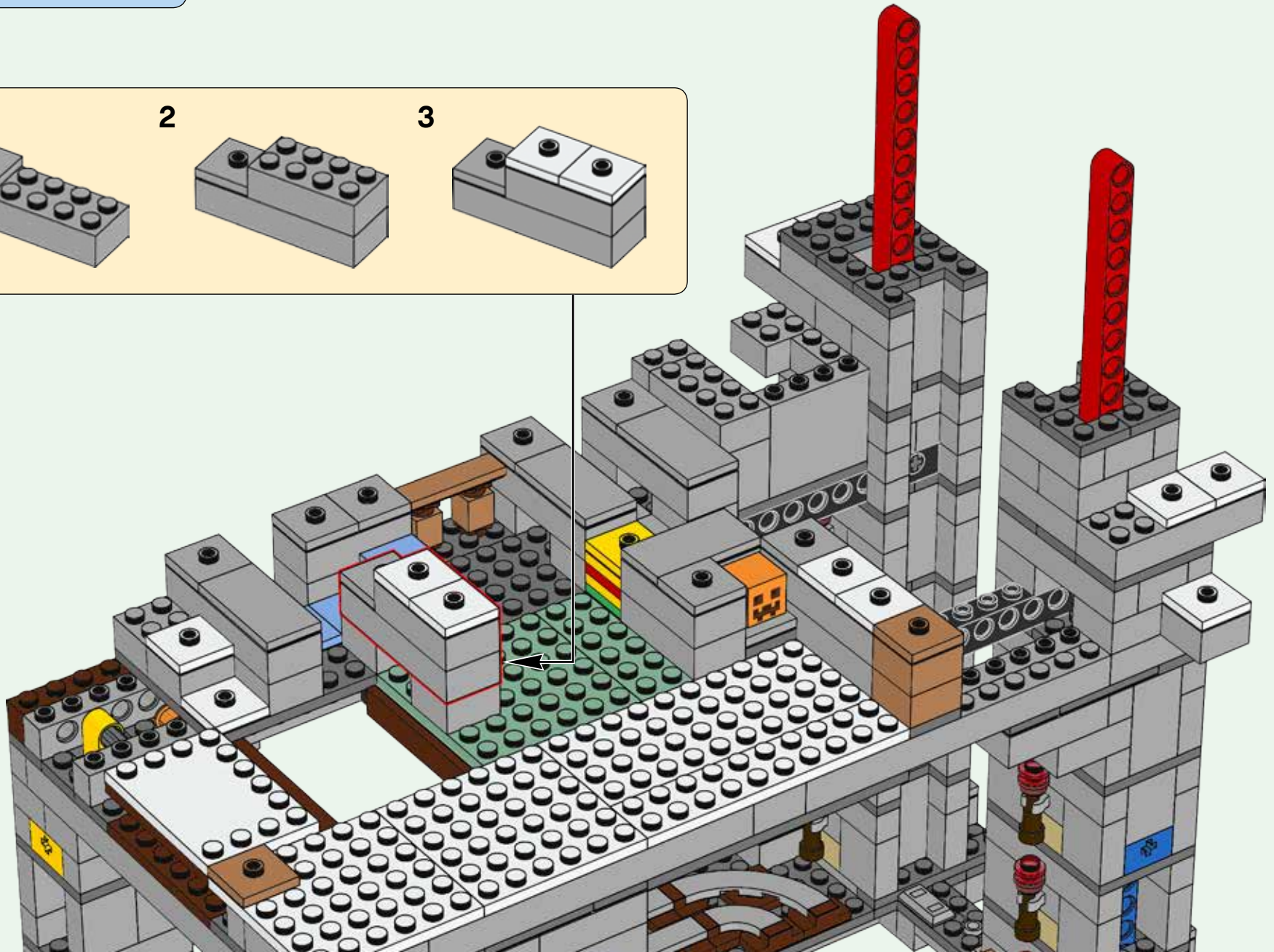
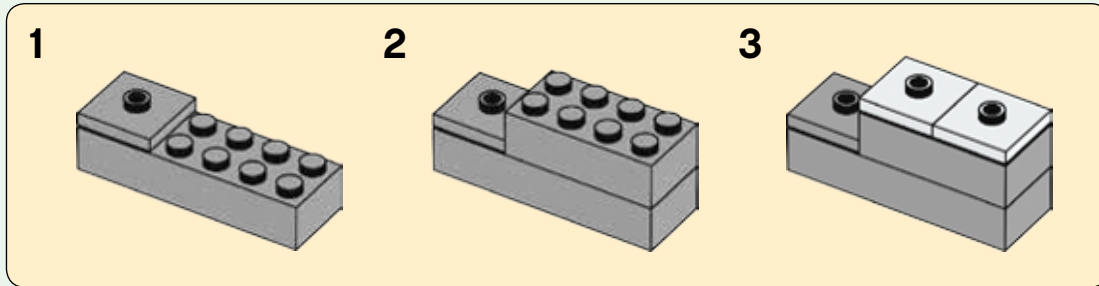

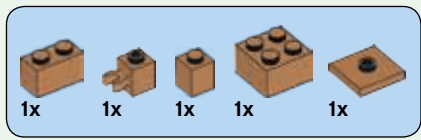

202

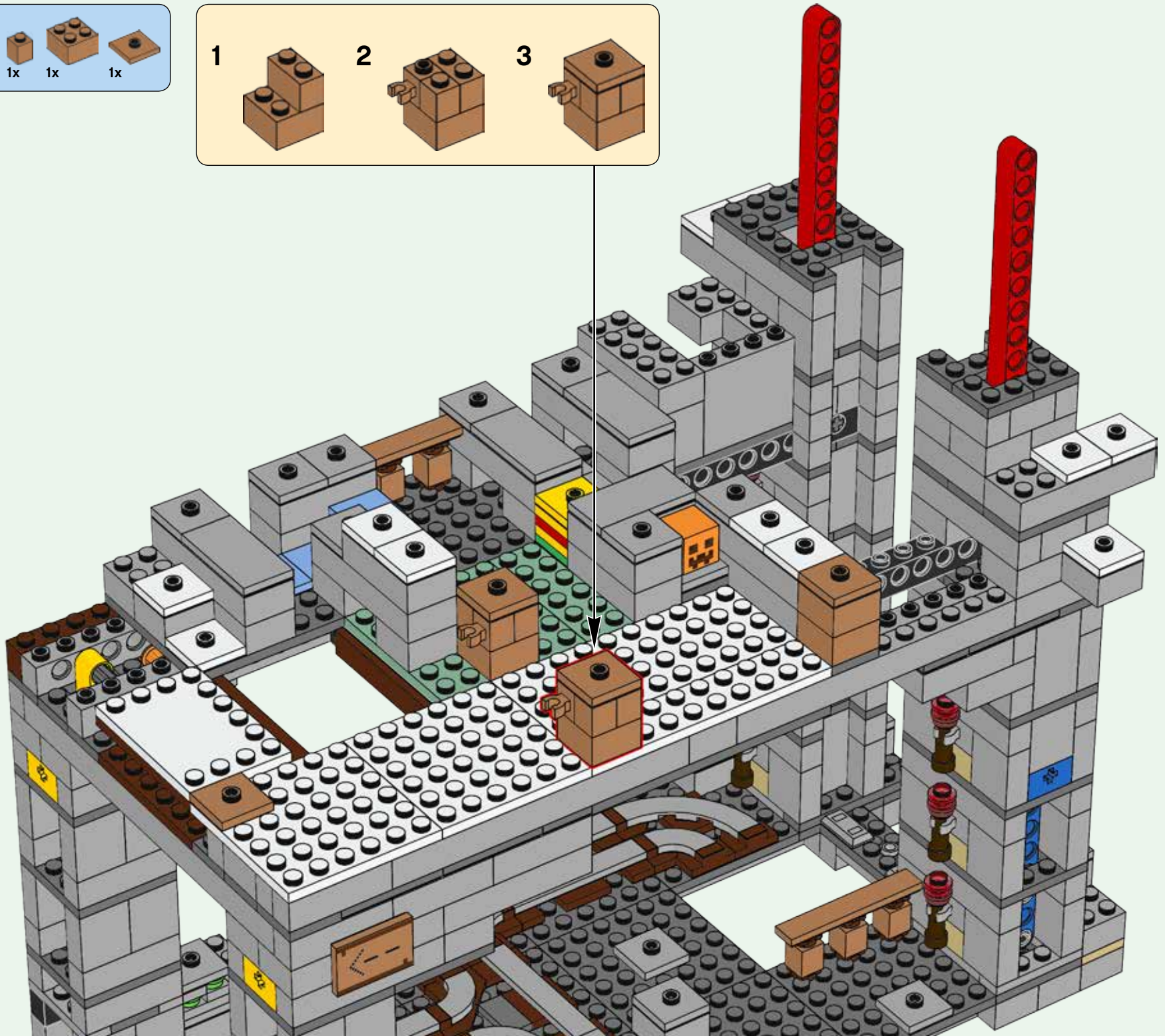
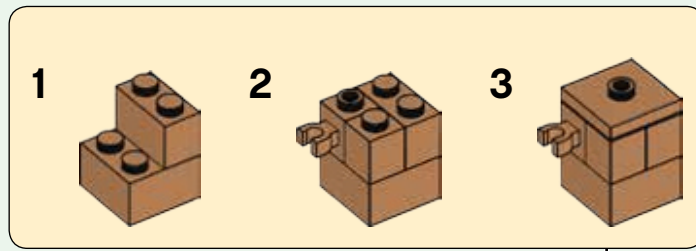

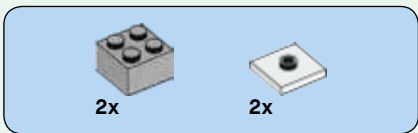

203

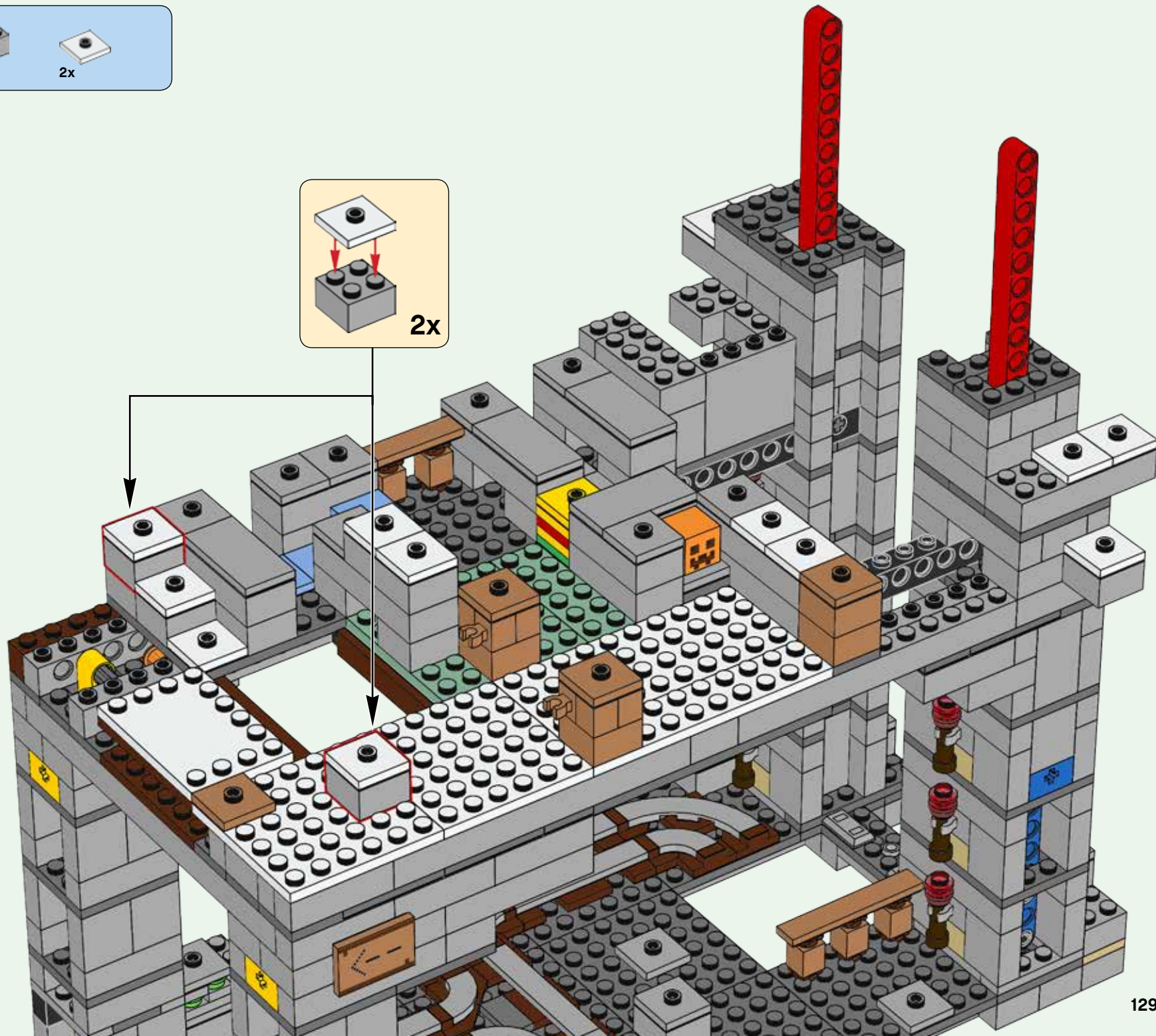
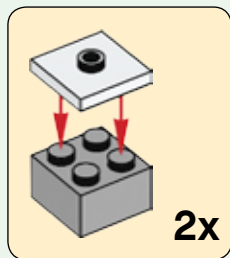

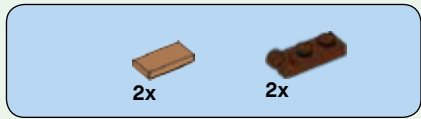

204

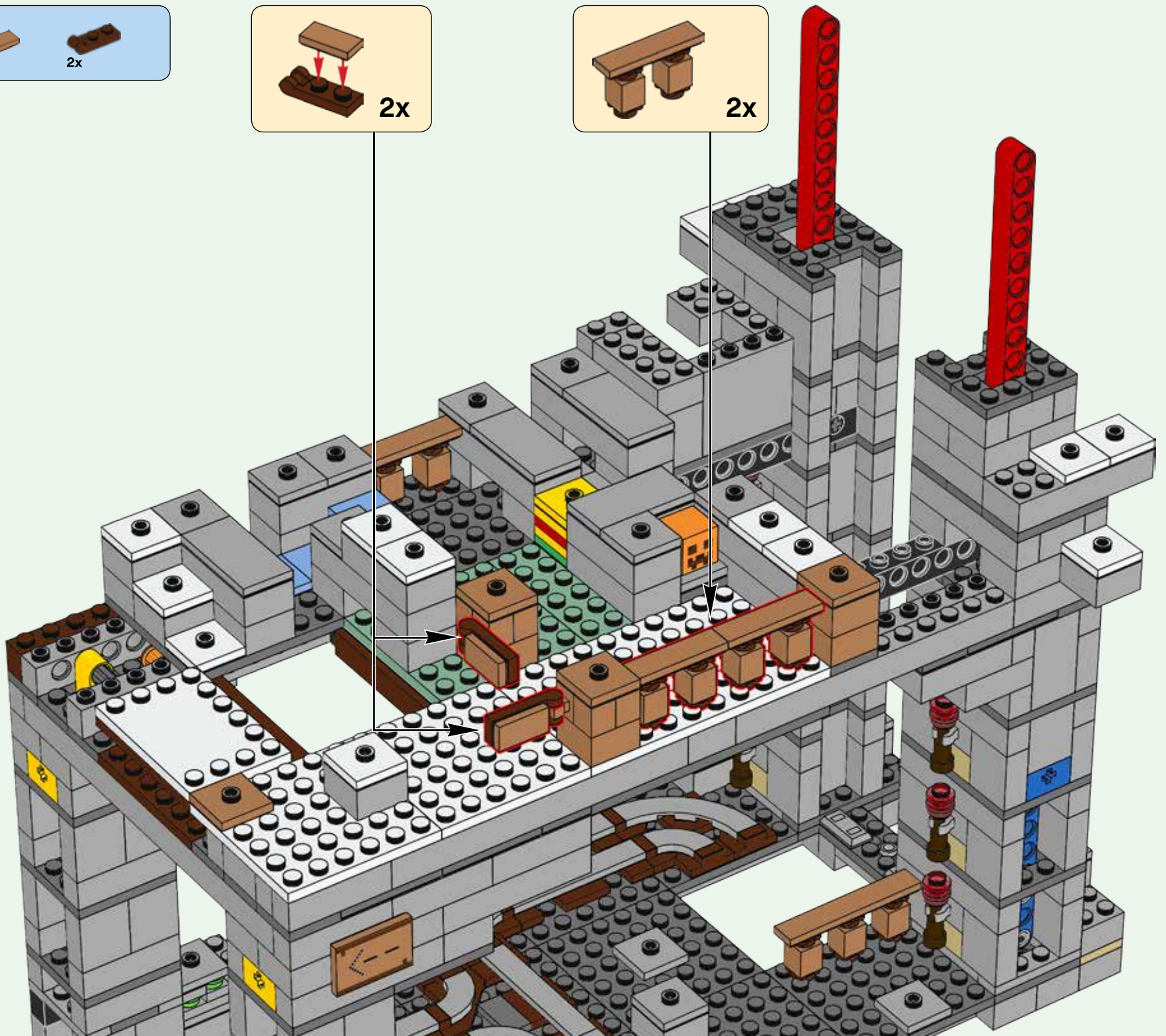
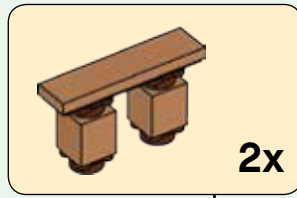
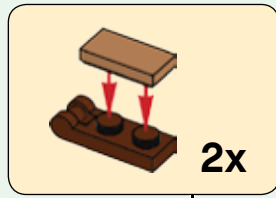



+



9

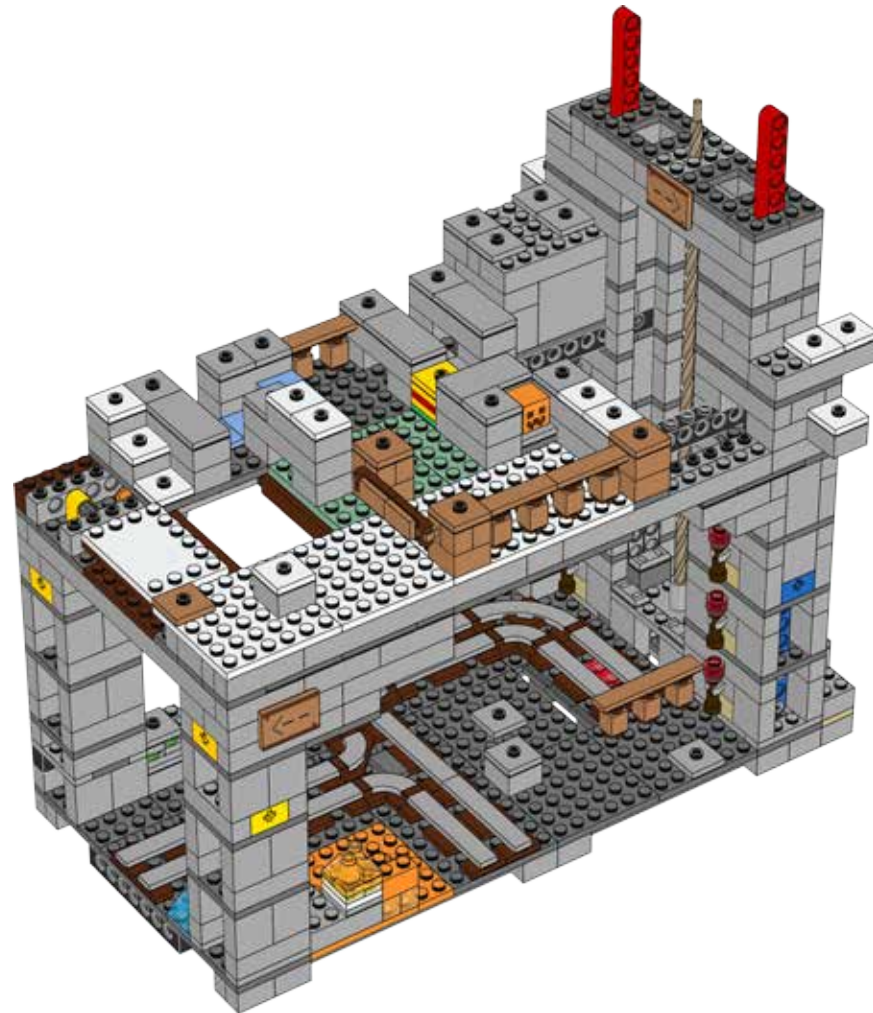

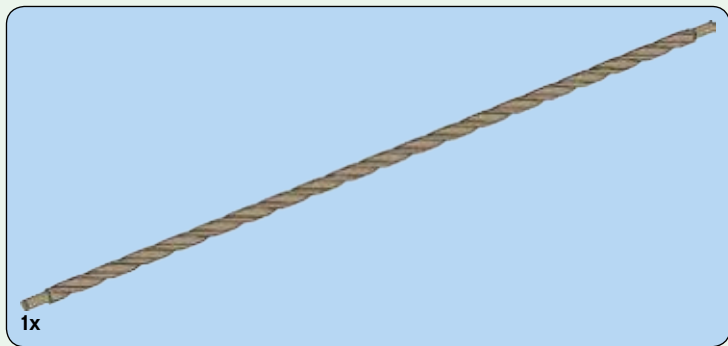

205

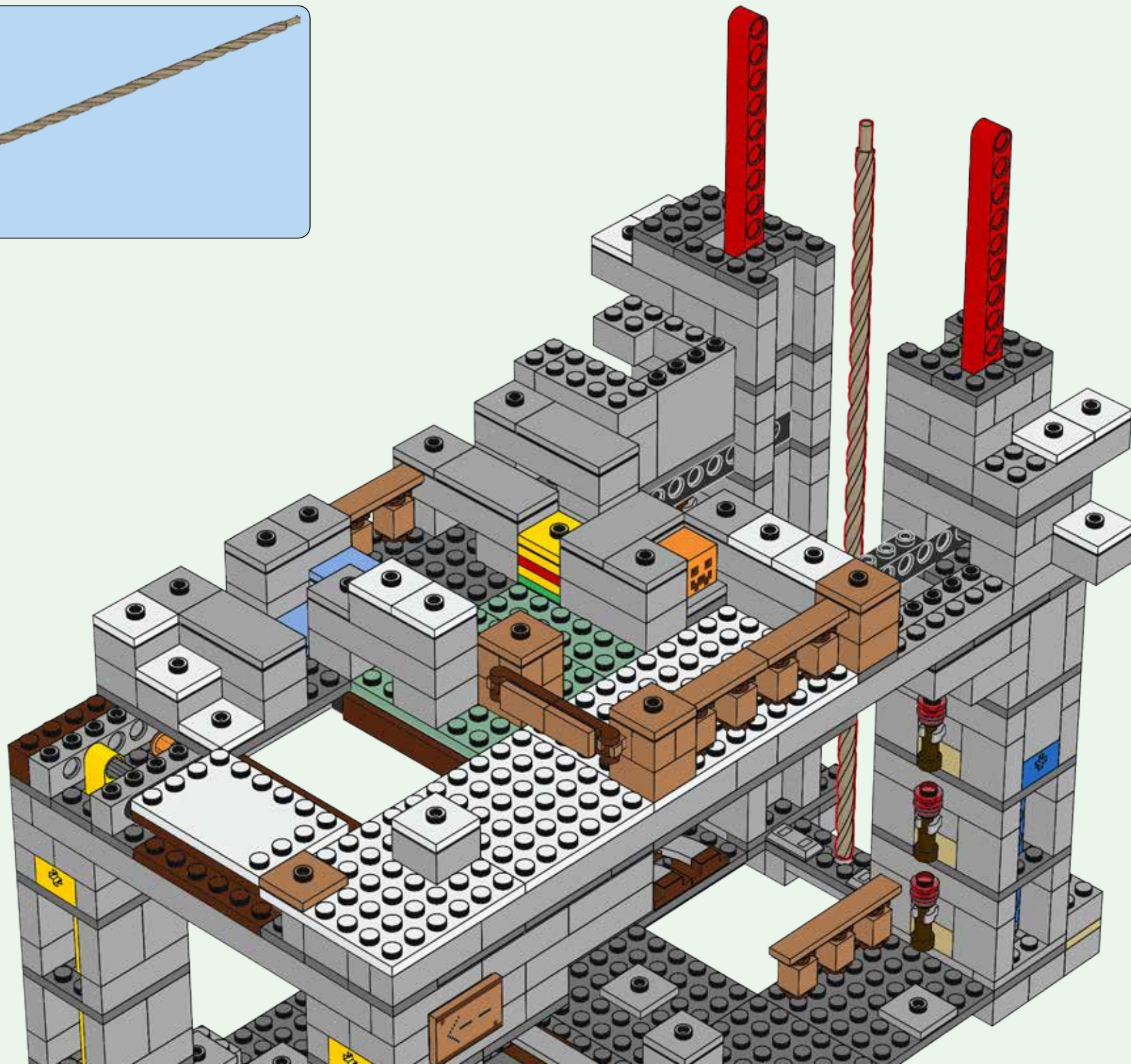

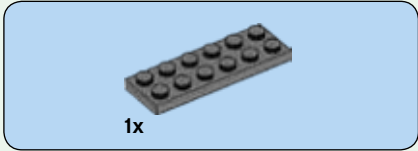
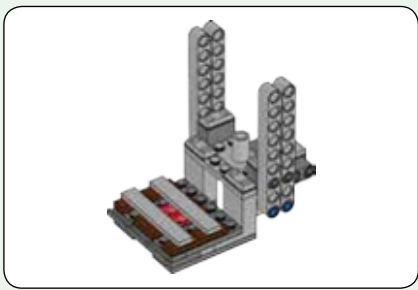

206

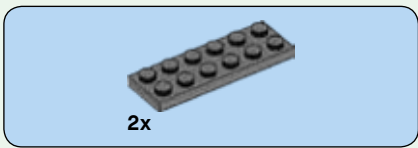

207

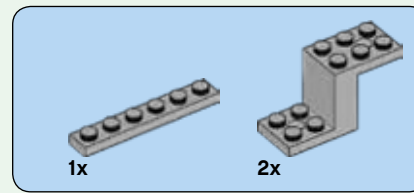
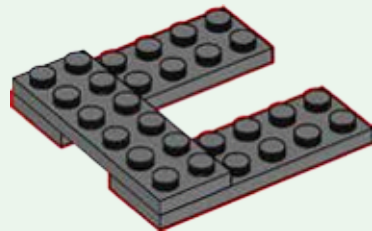

208

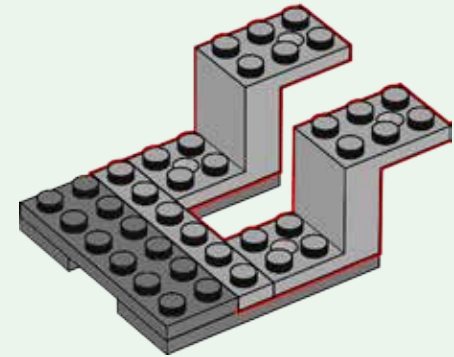

209

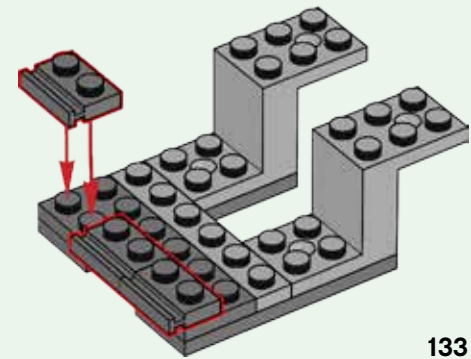

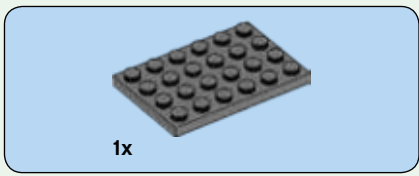

210

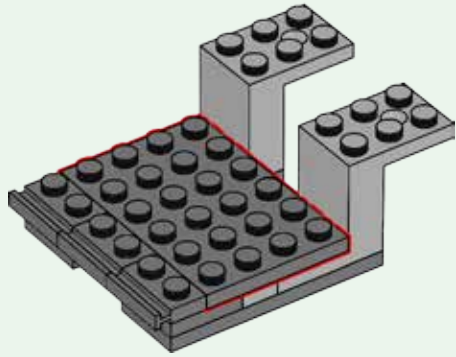

211

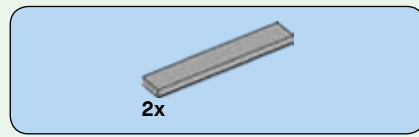
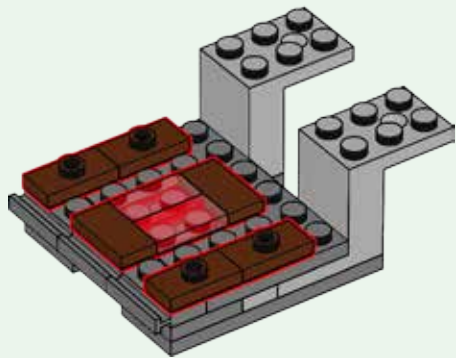

212

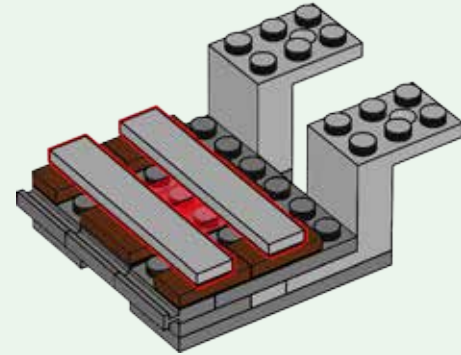

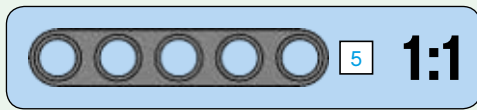
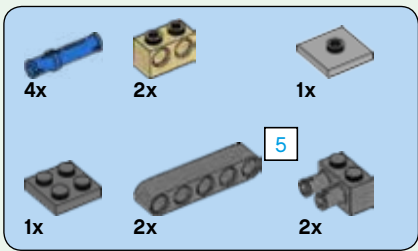

213

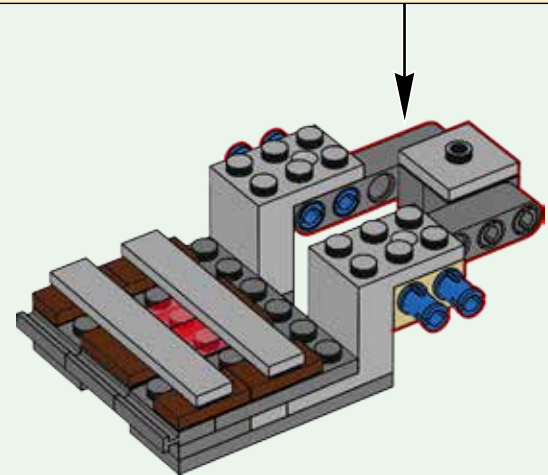
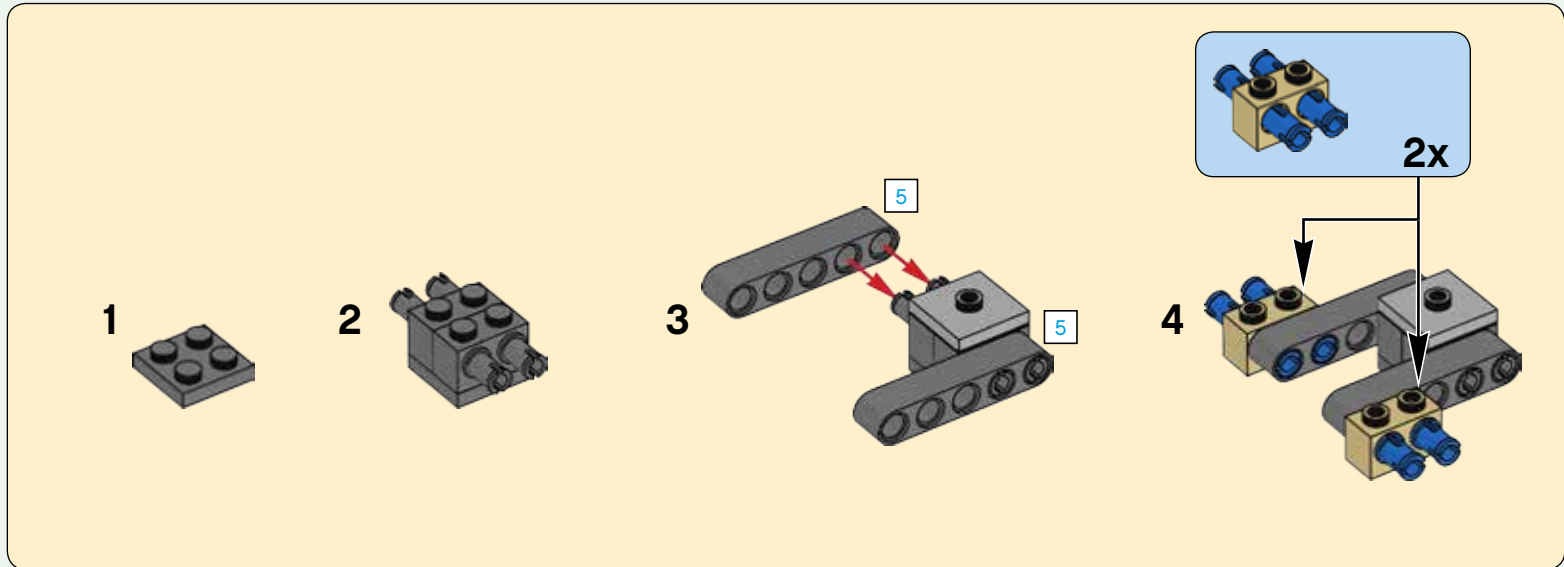

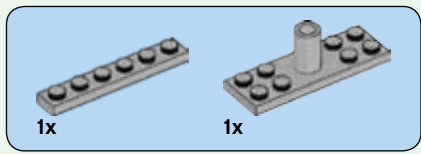

214

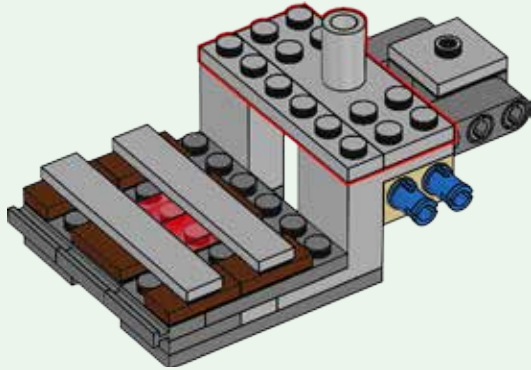

215

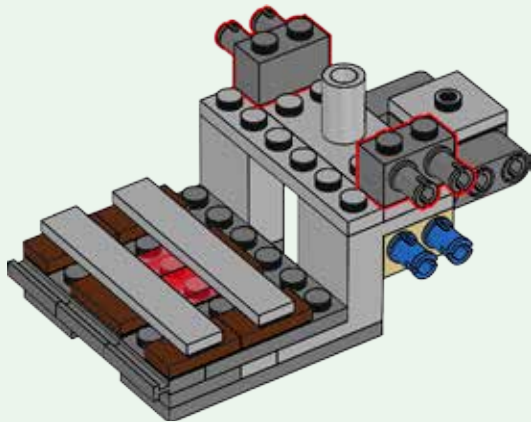

216

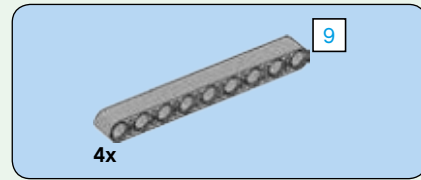
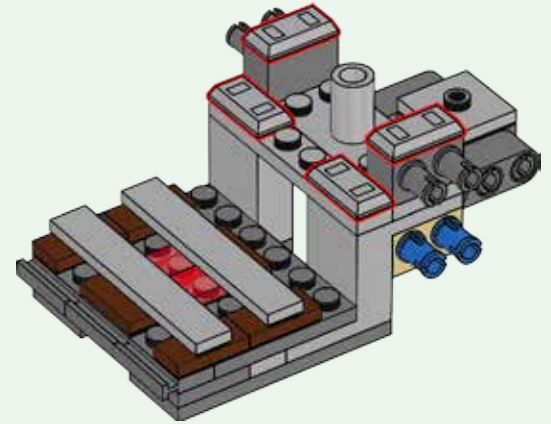

217

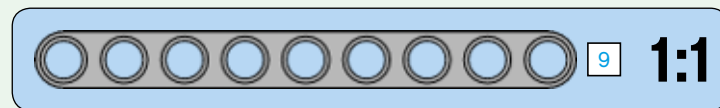
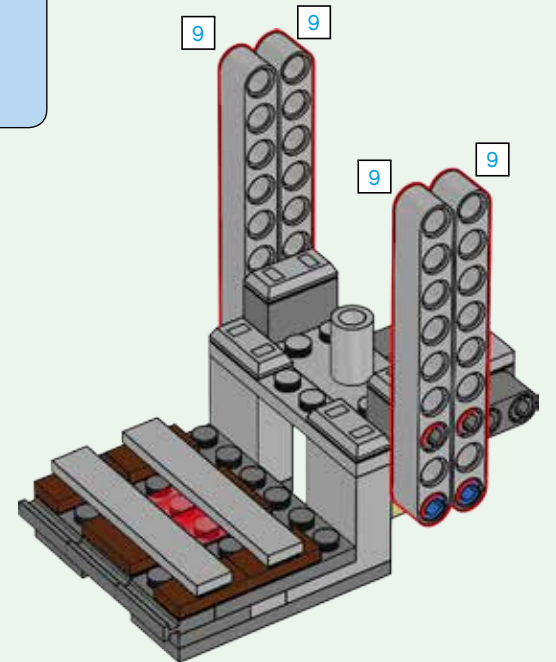

9 1:1

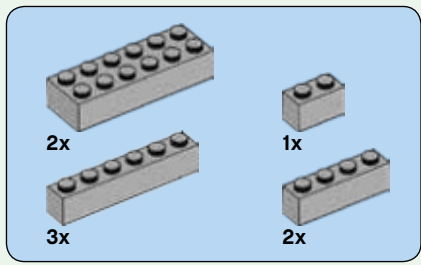

219

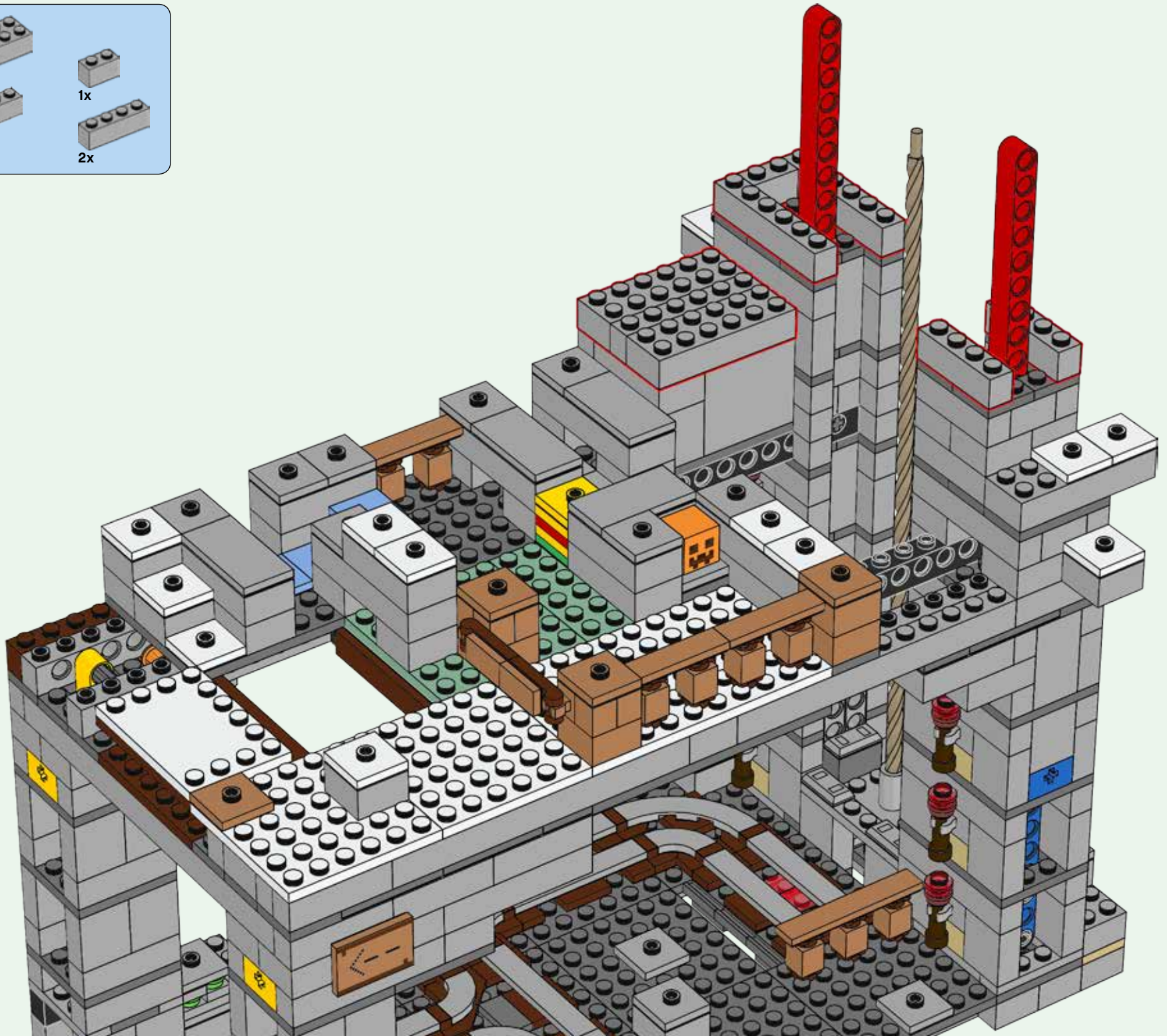

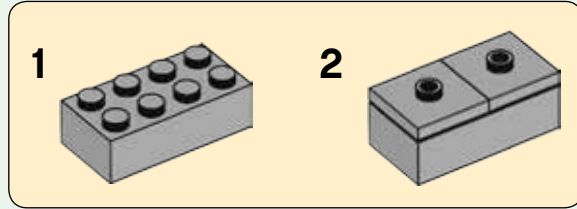
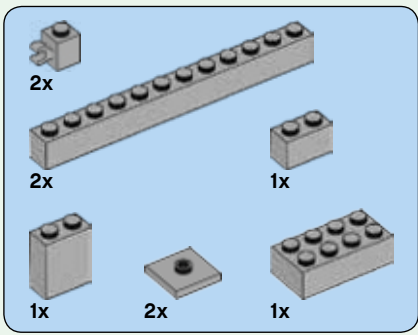

220

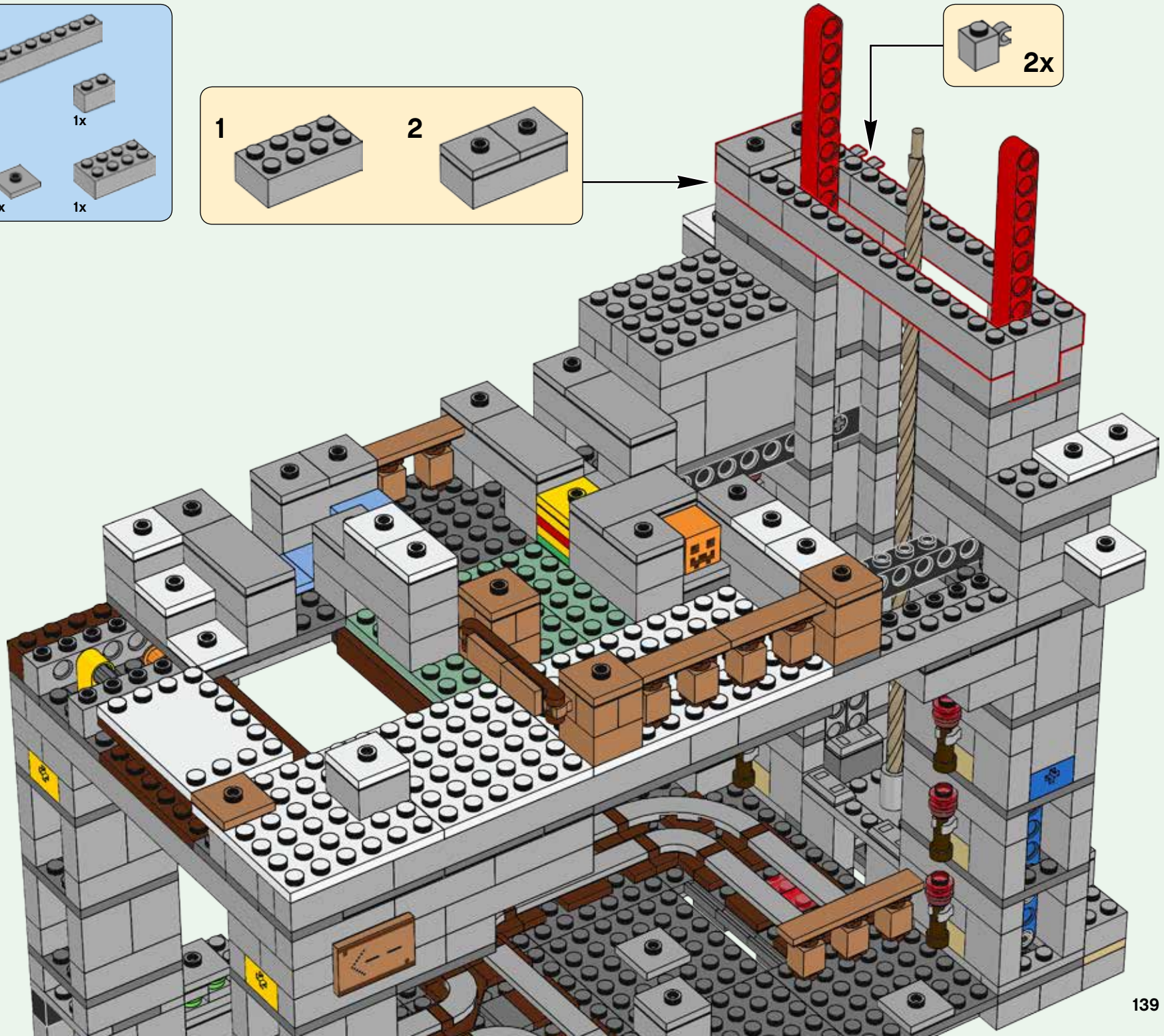

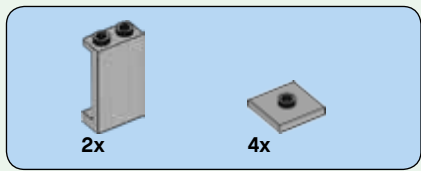

221

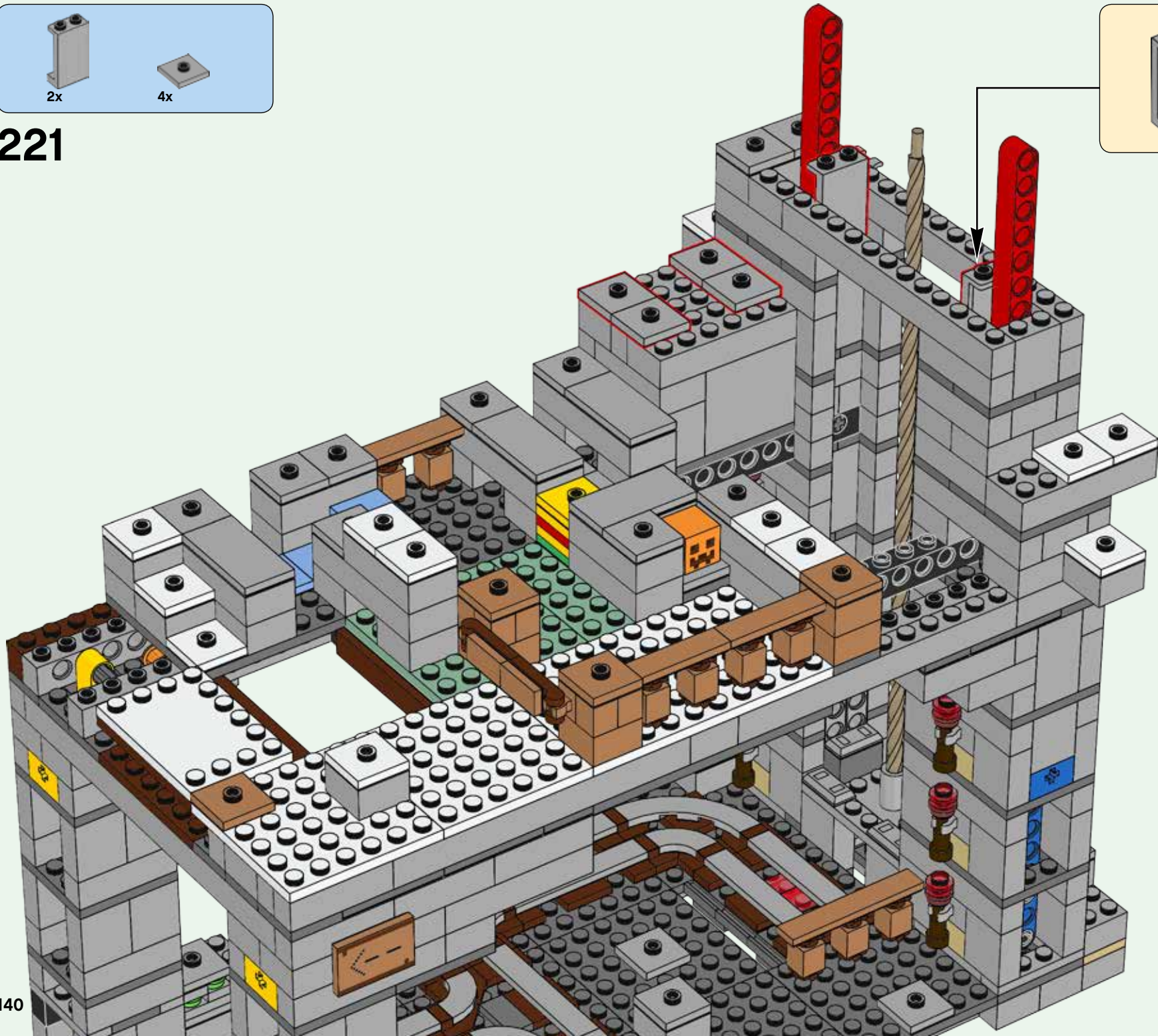
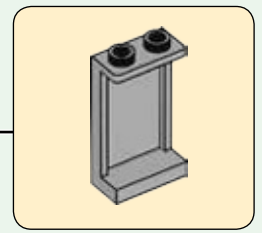

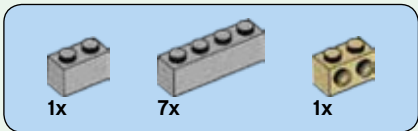

222

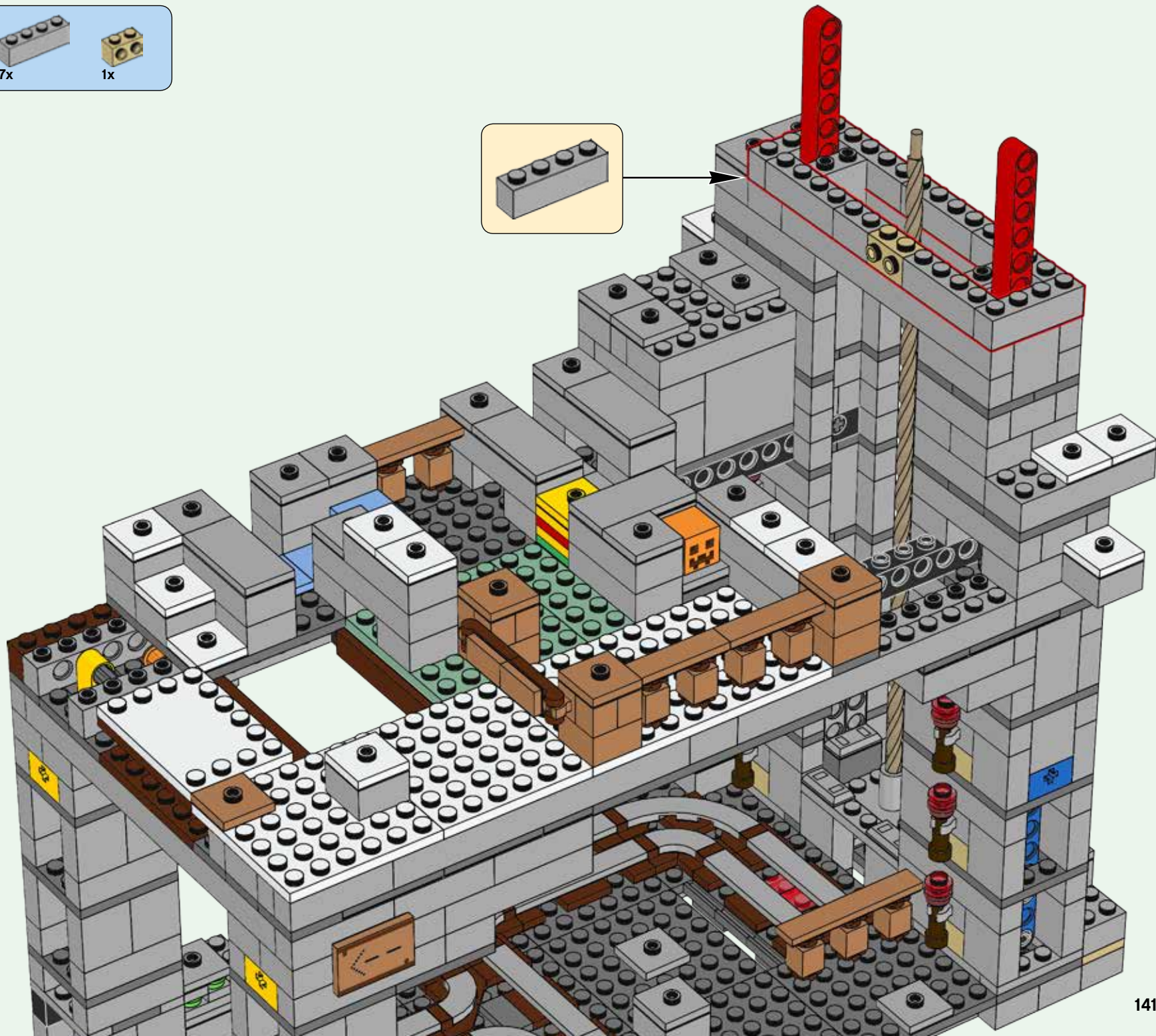

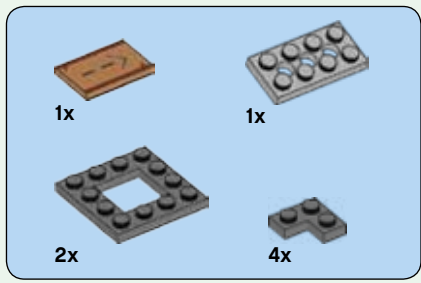

223

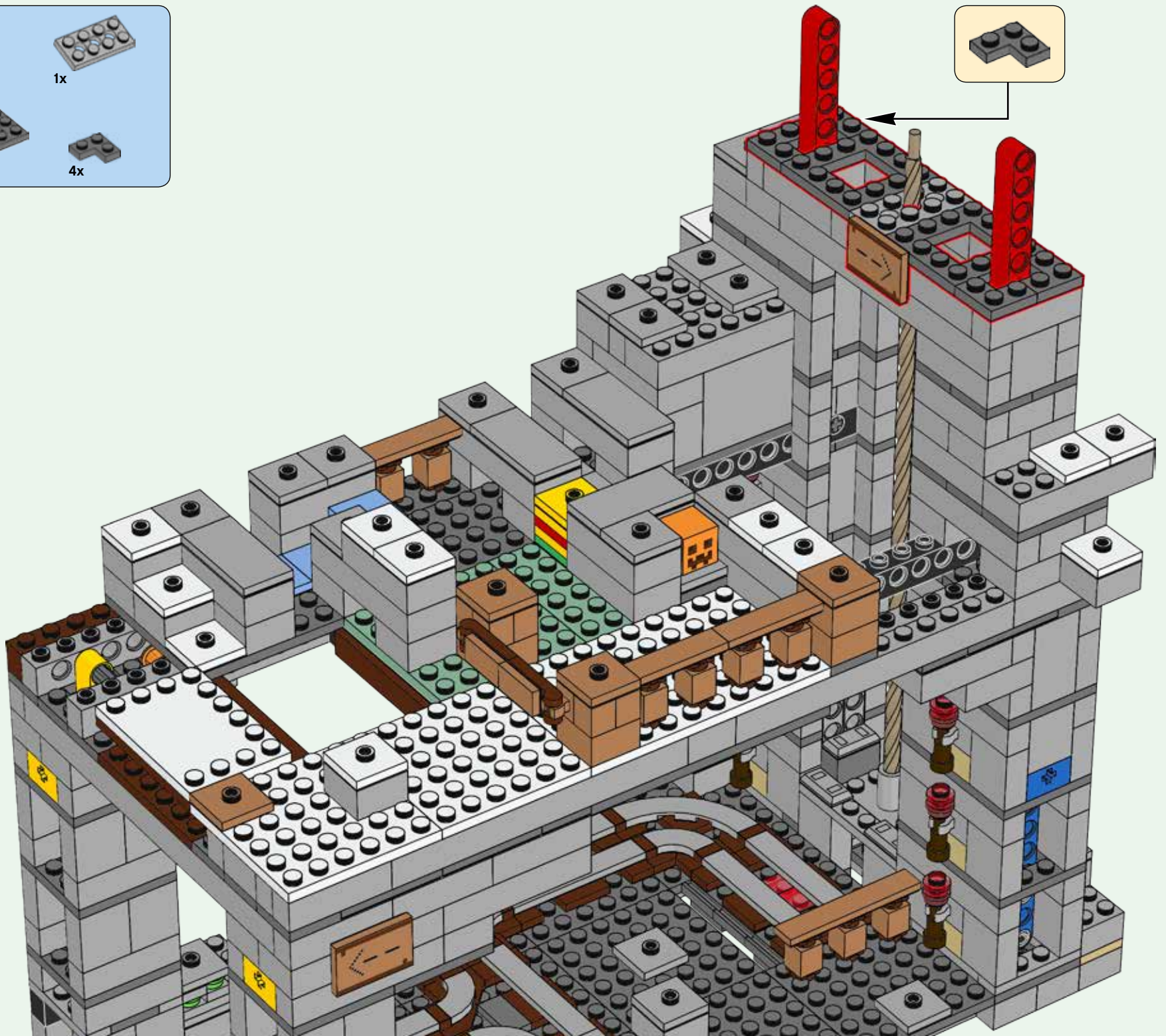

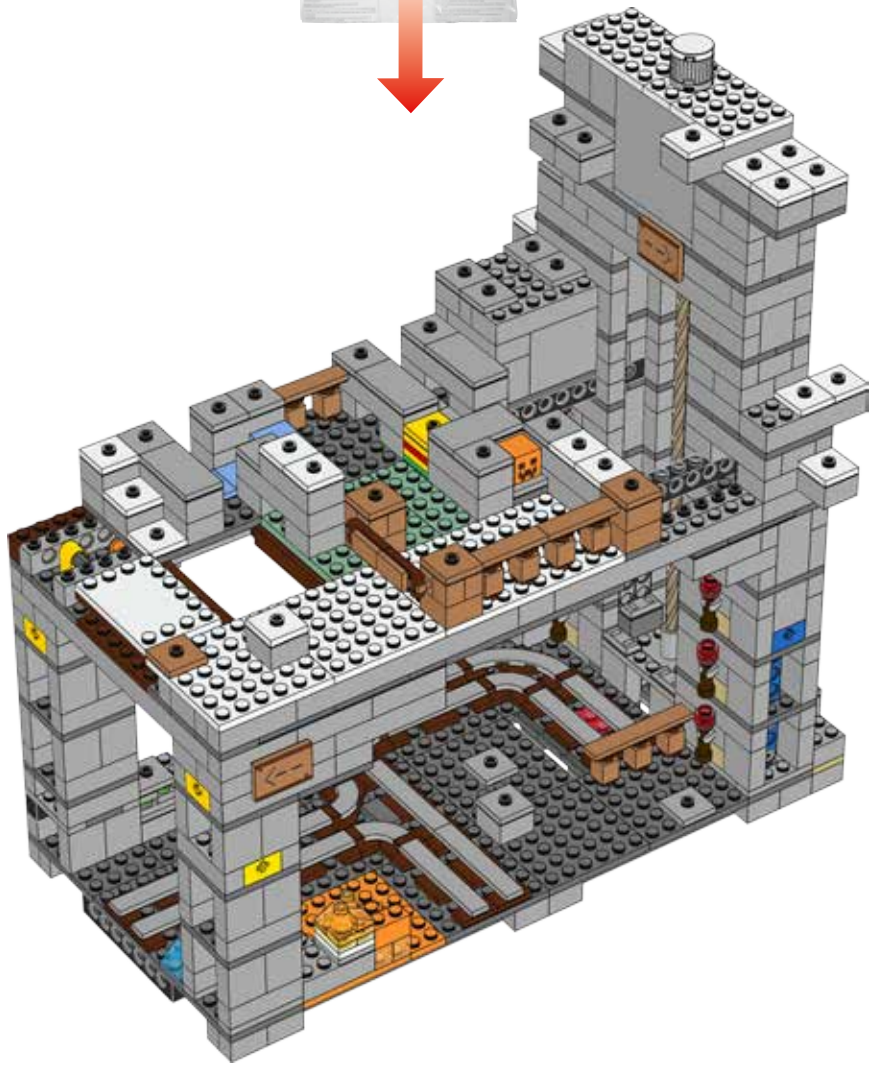

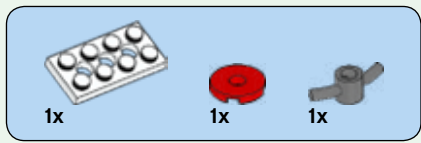

224



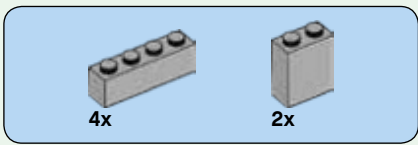

225

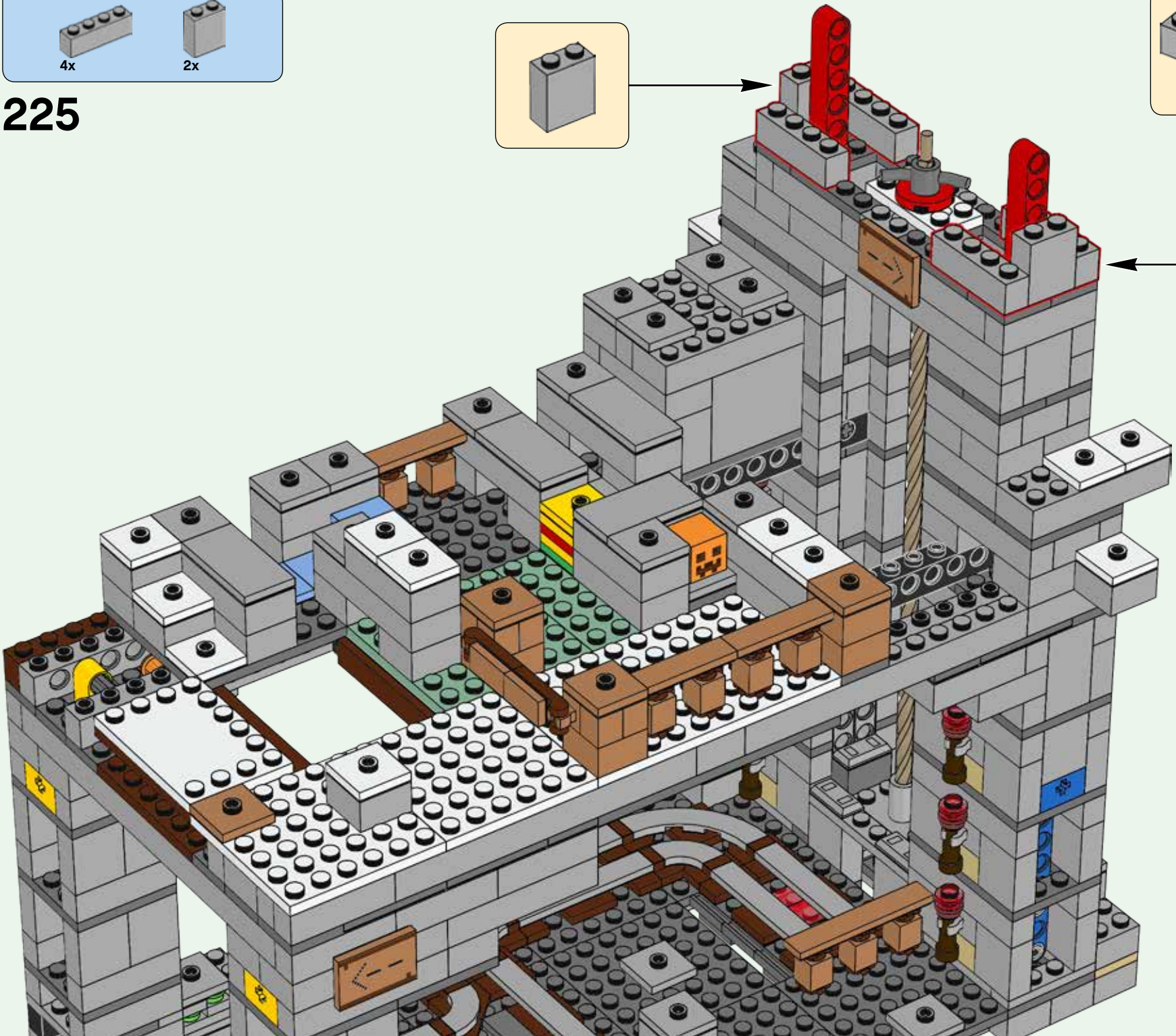
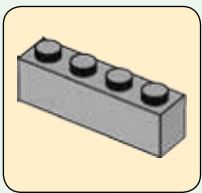
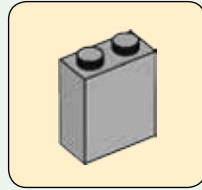

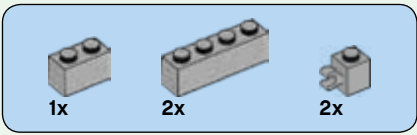

226

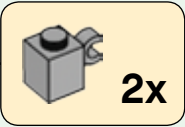

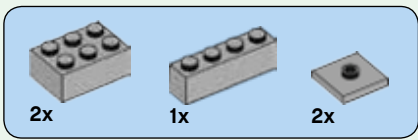

227

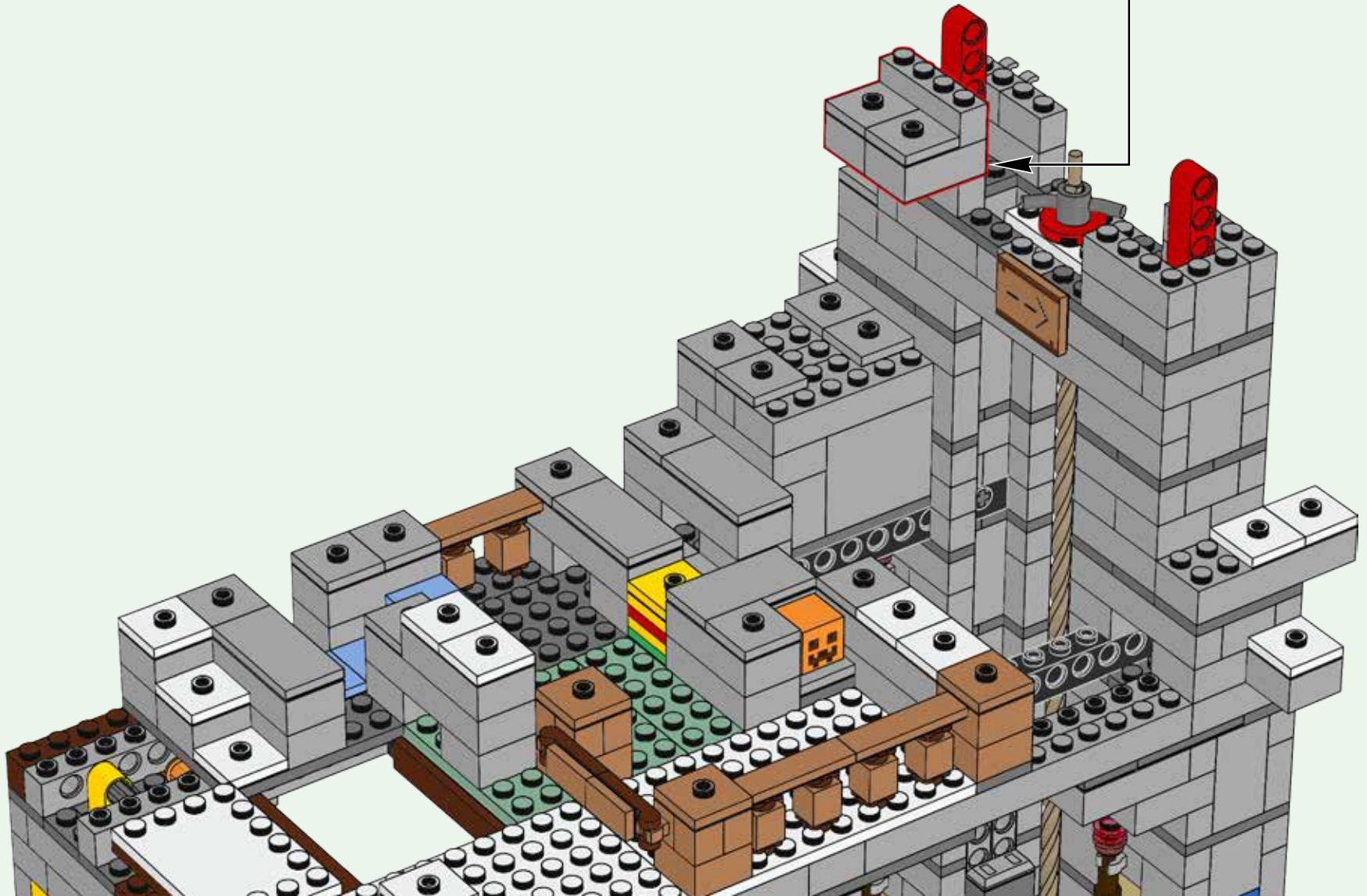
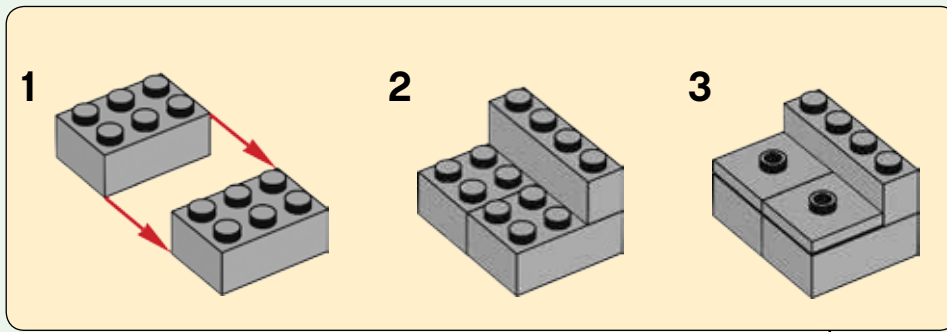

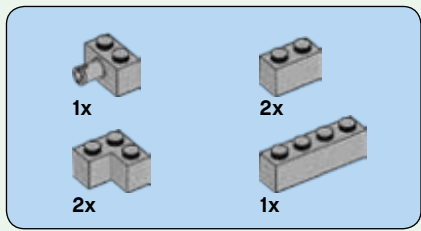

228

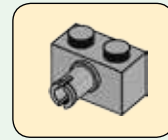

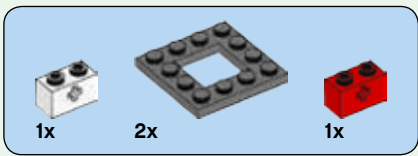

229

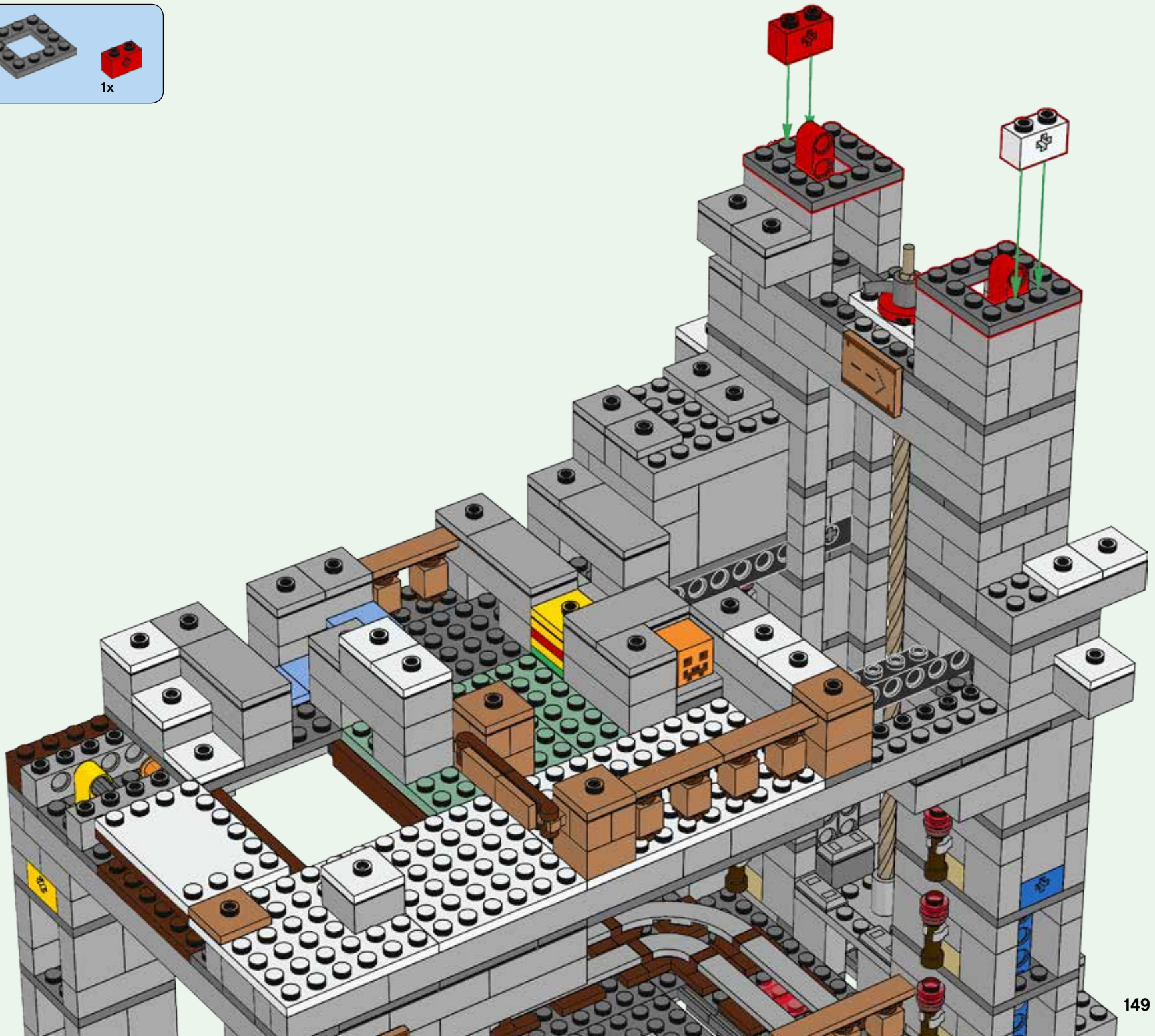

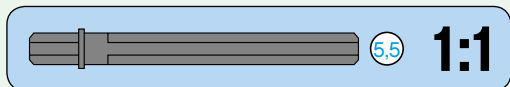
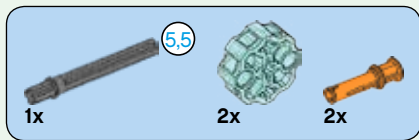

230

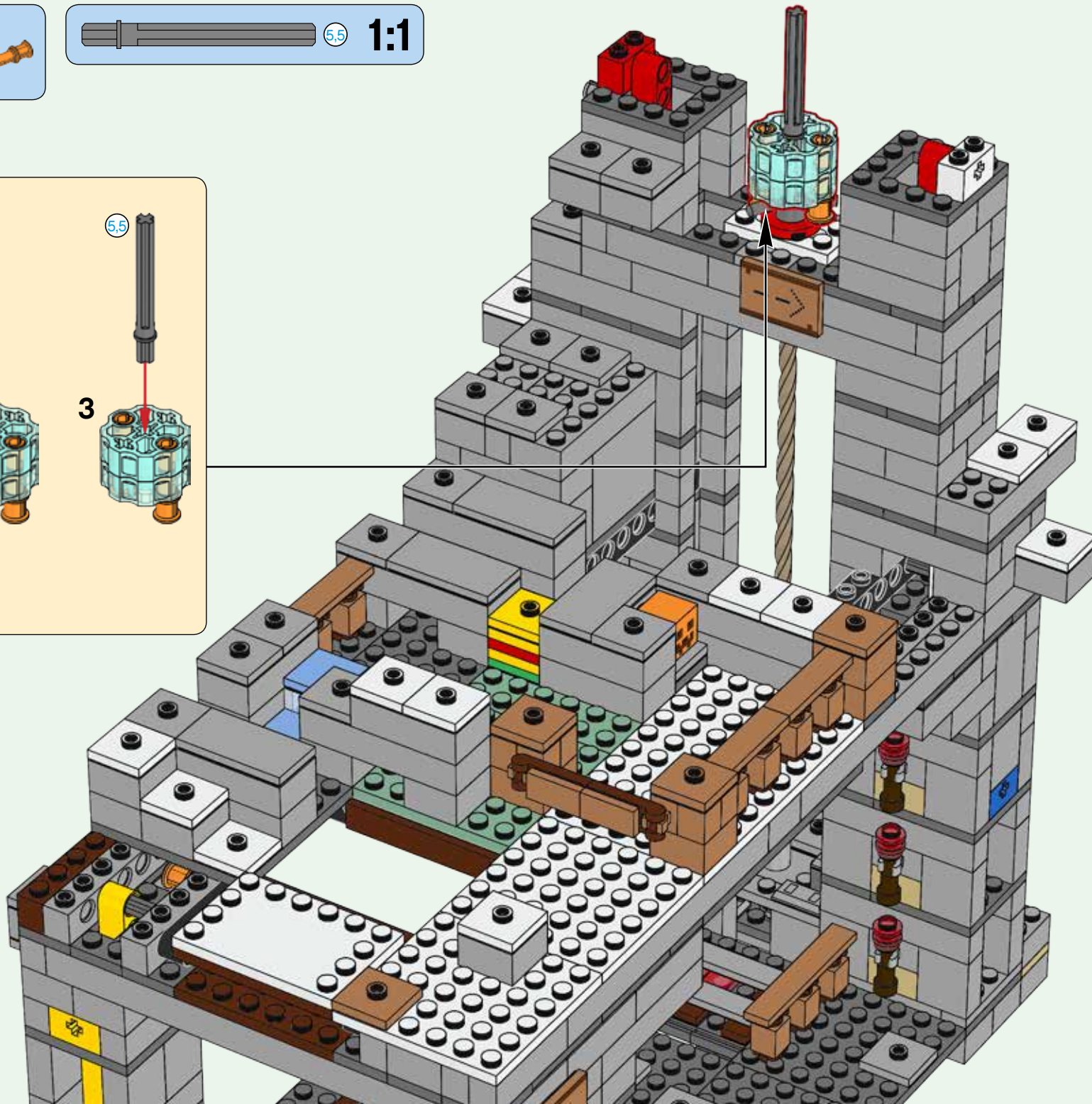
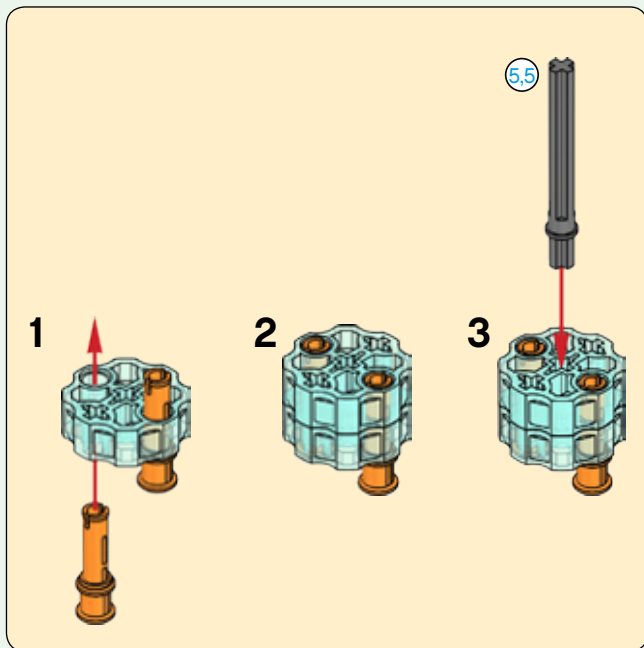

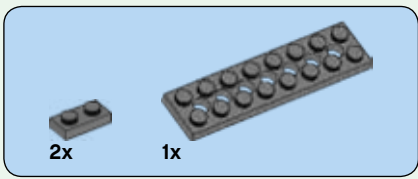

231

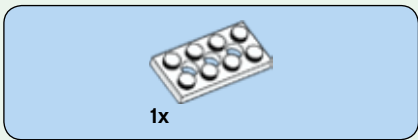
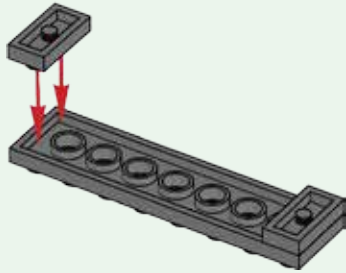

232

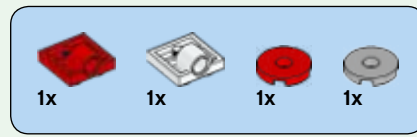
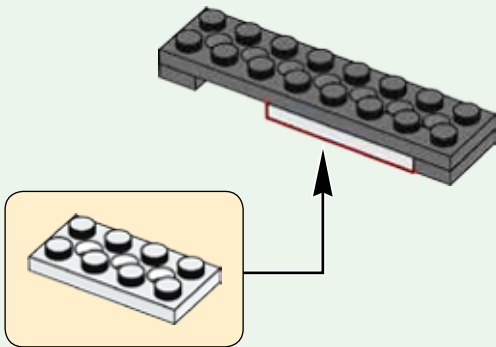
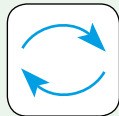

233

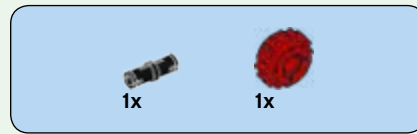
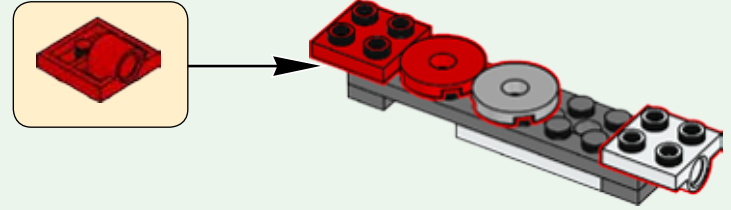

234

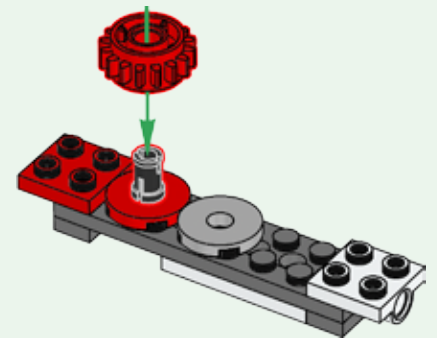



1x

235

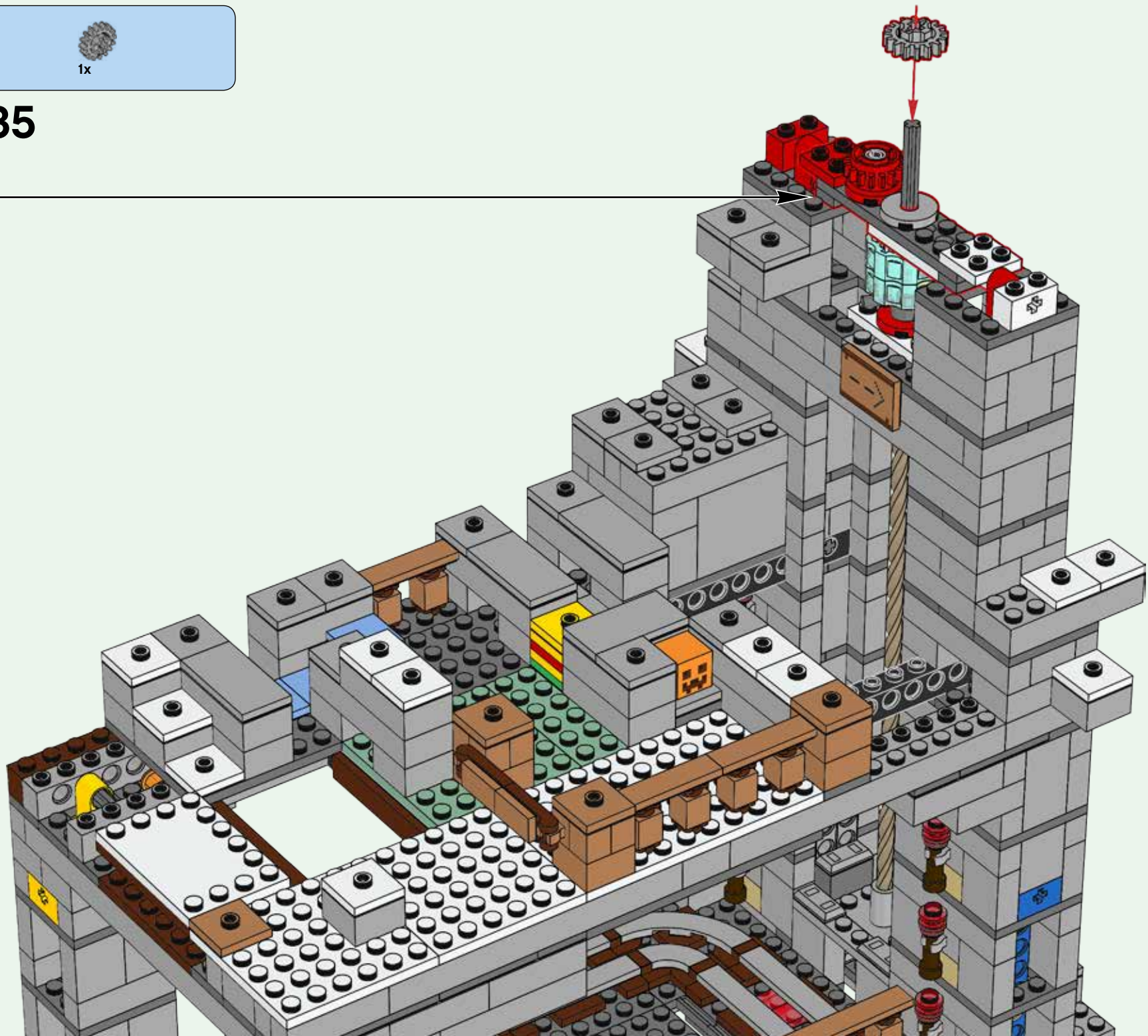

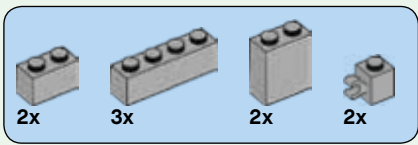

236

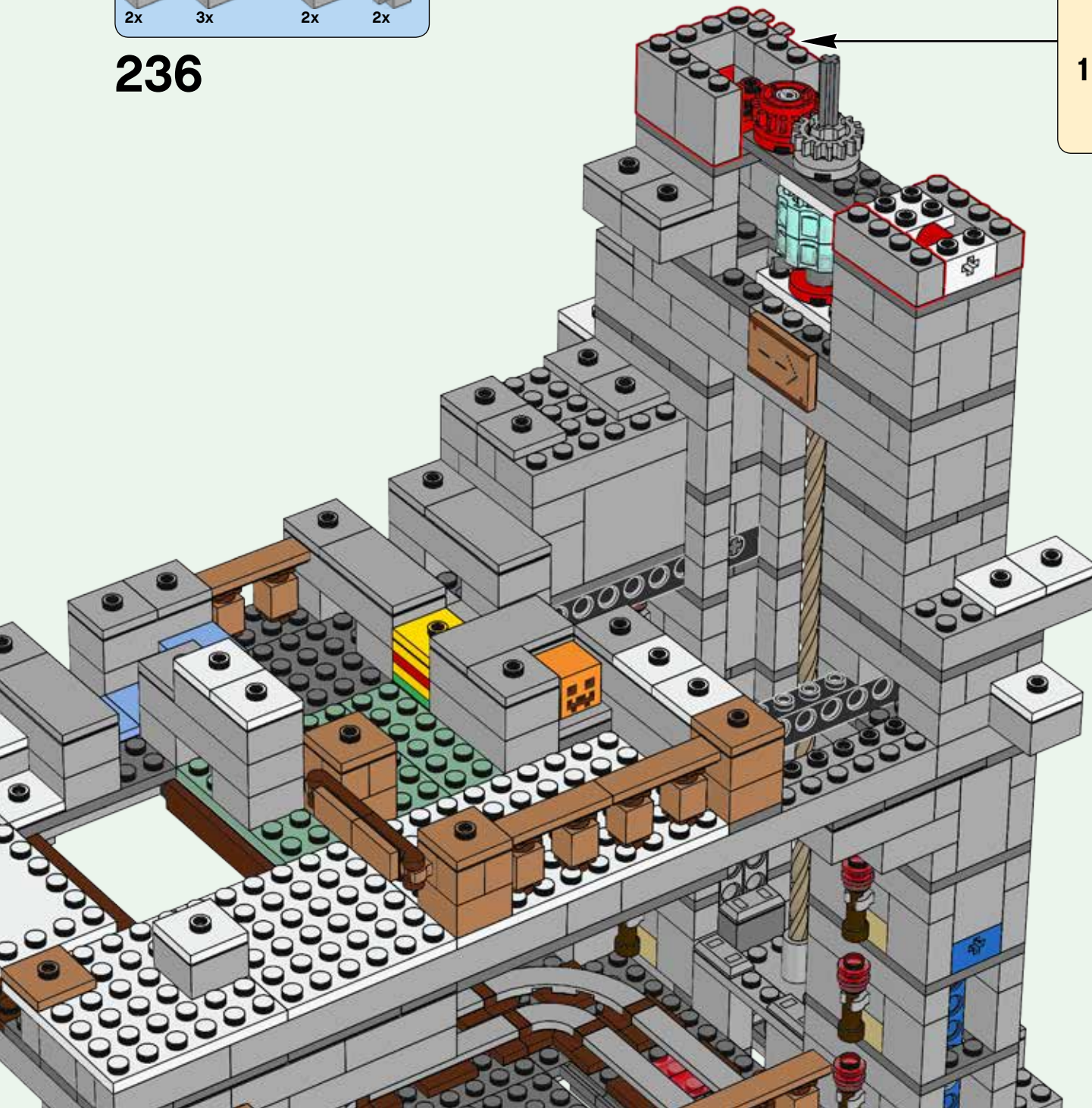
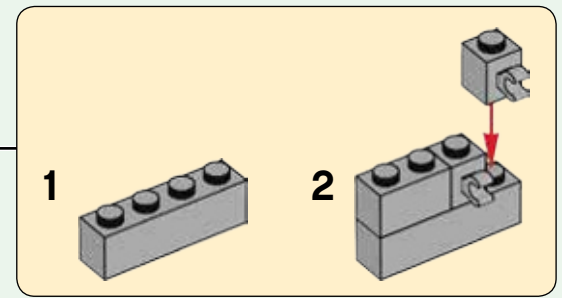

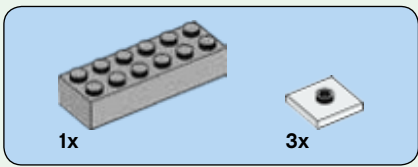

238

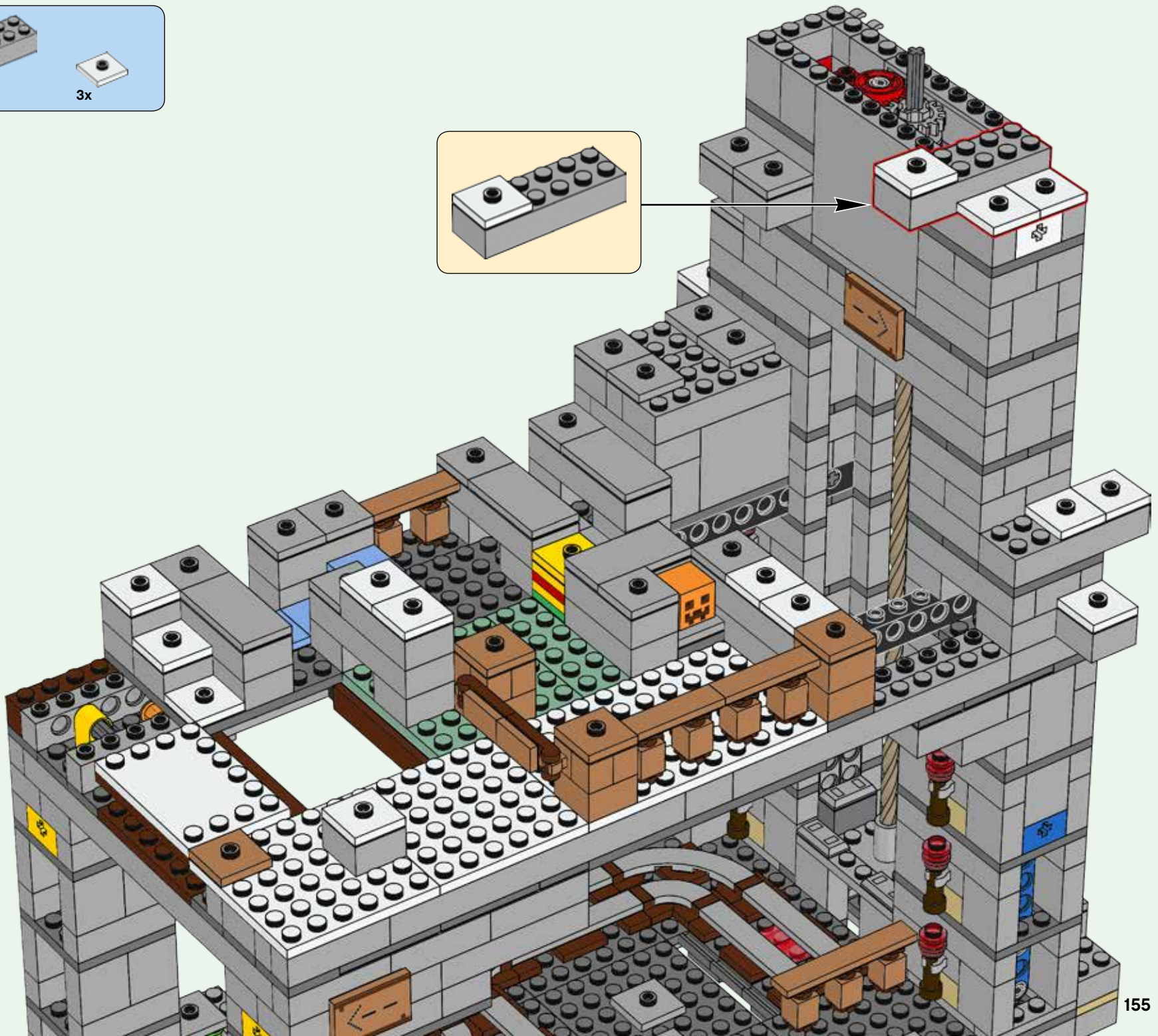
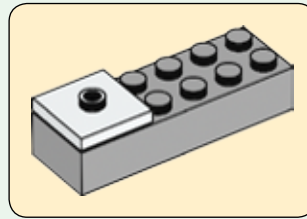

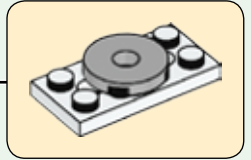
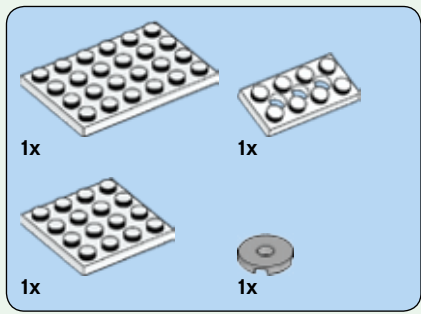

239

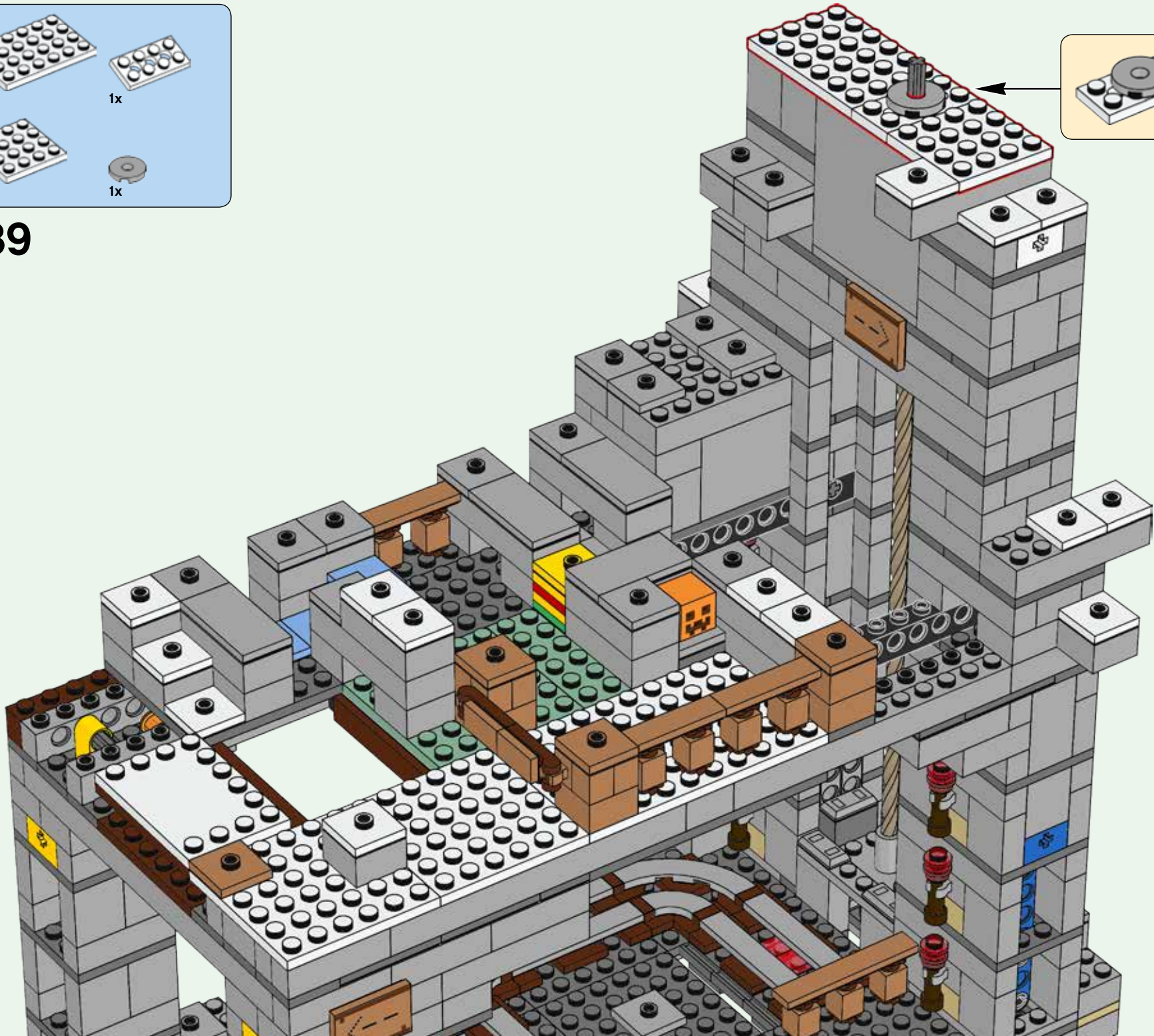



240

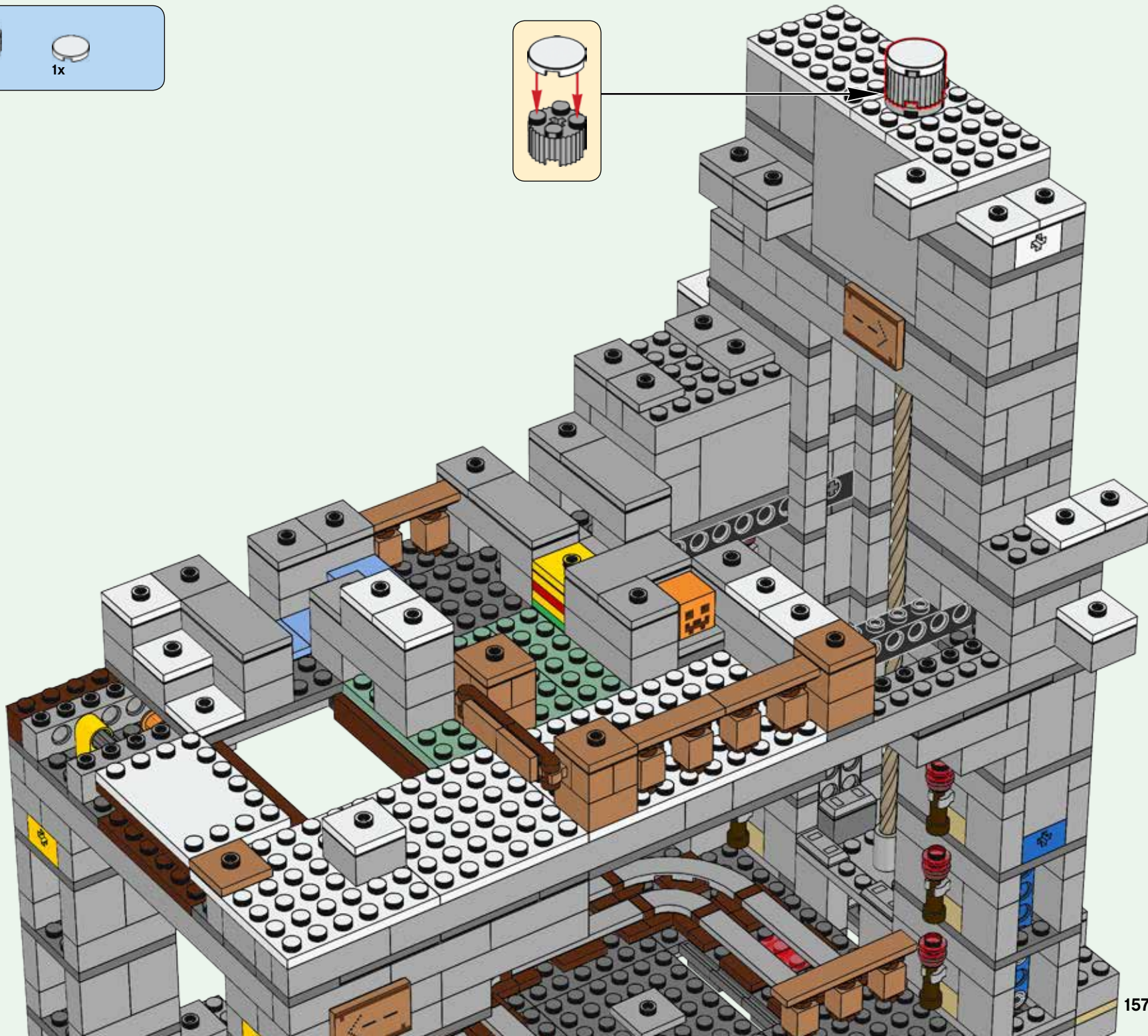
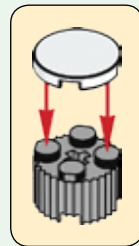



241

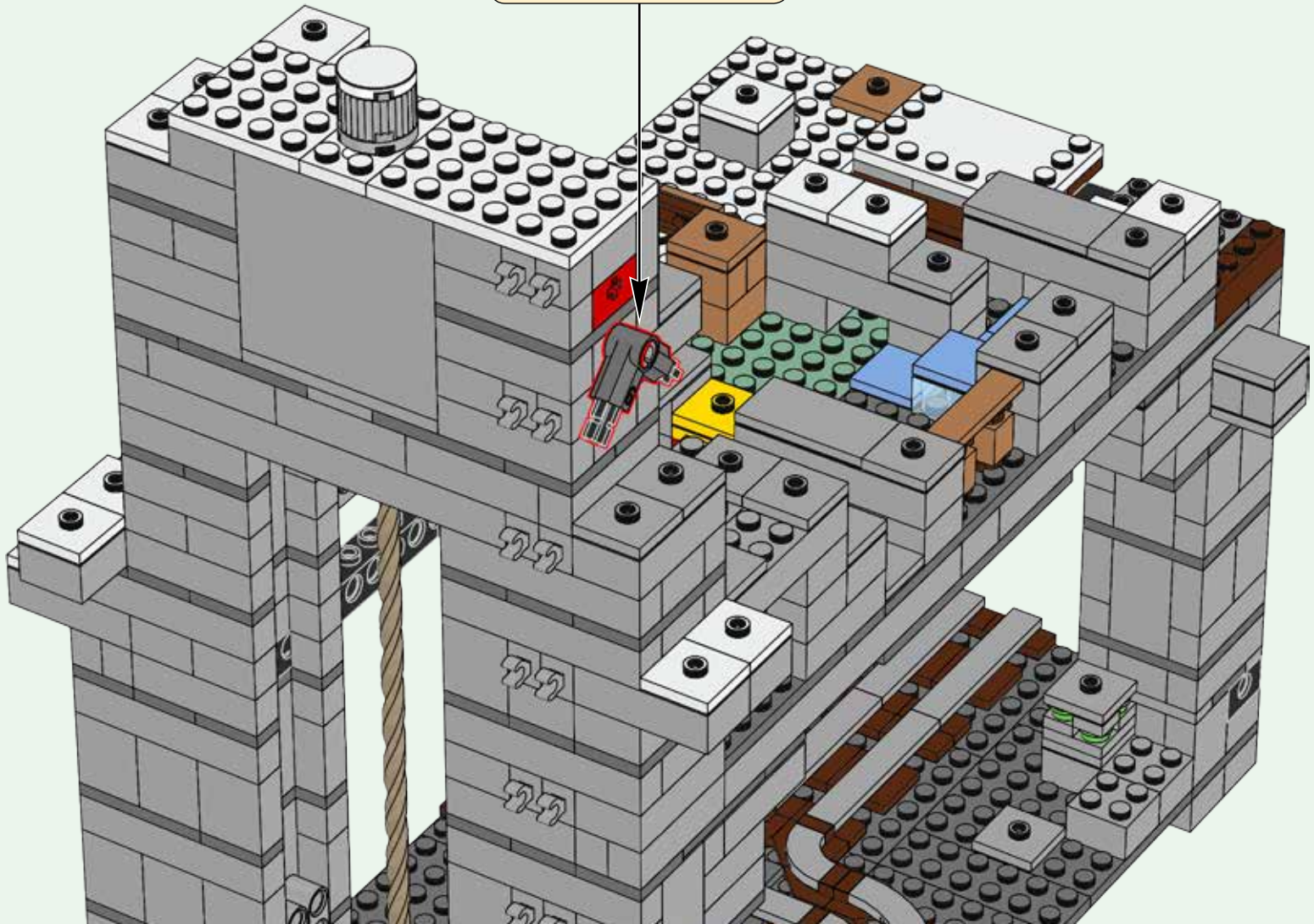
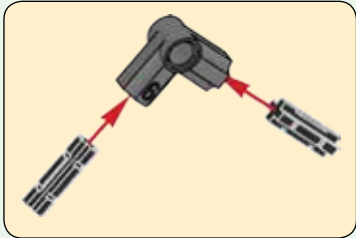

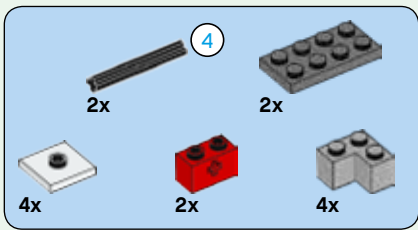

242

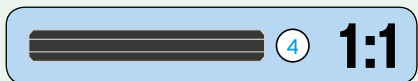
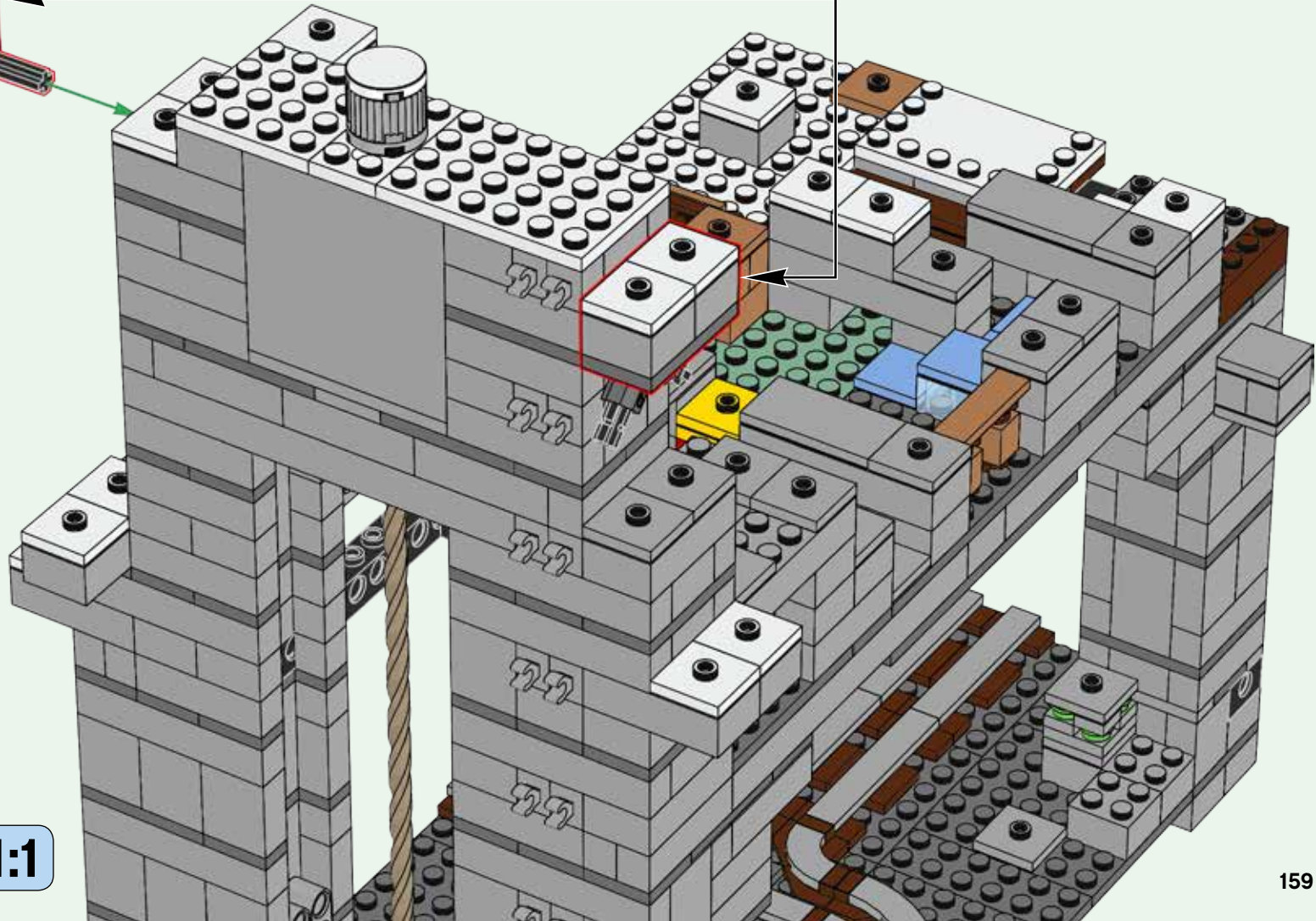
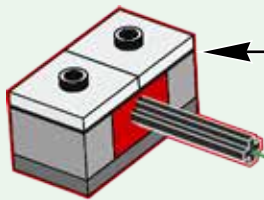
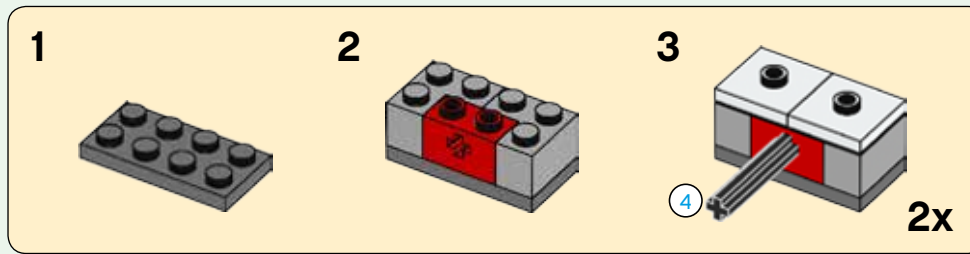

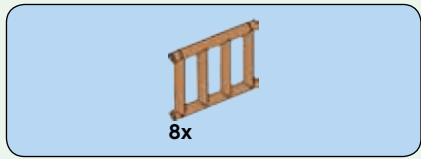

243

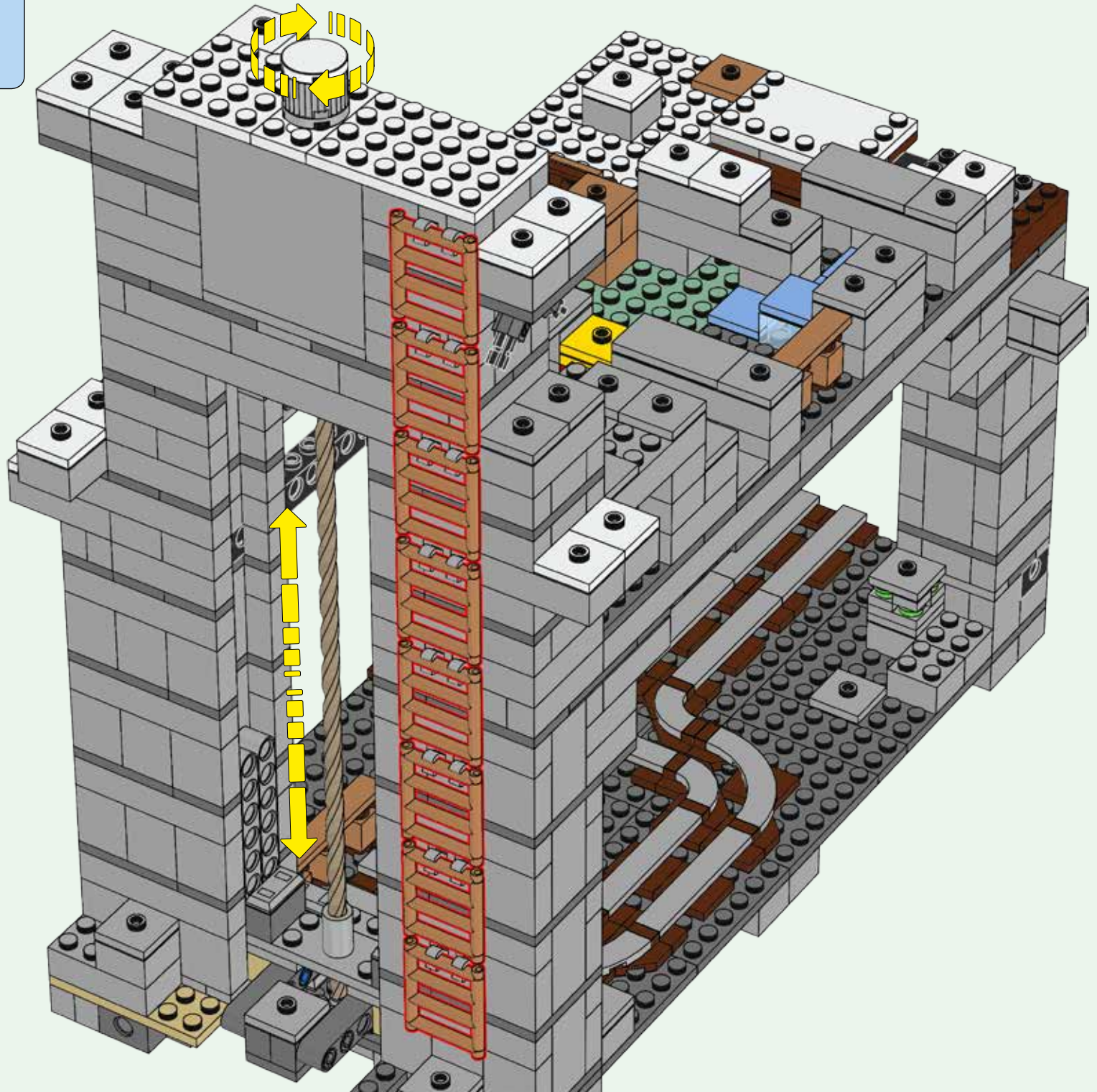

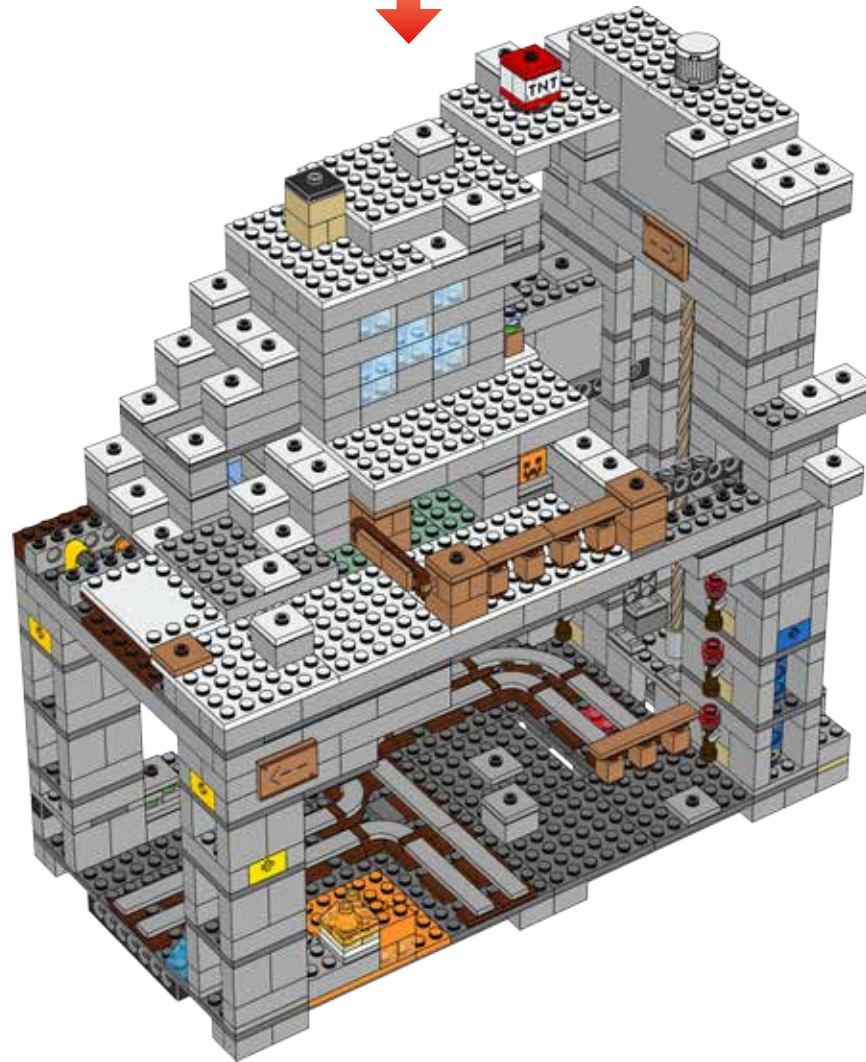

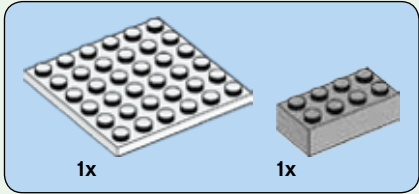
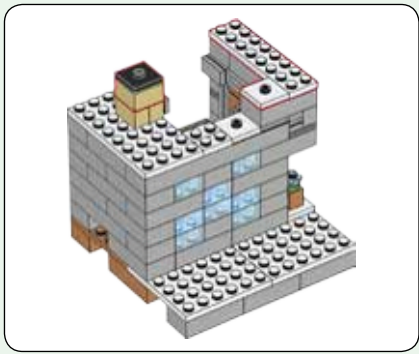

244

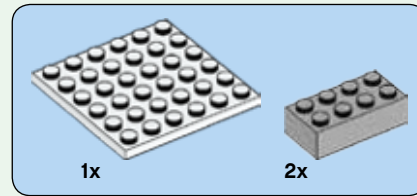
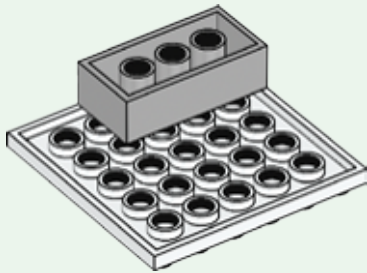

245

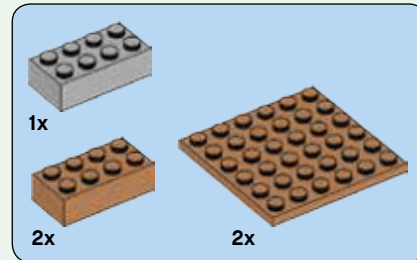
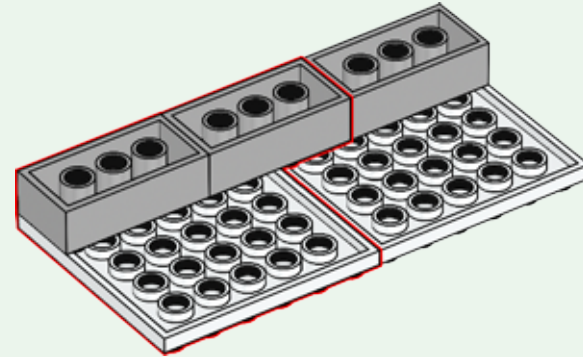

246

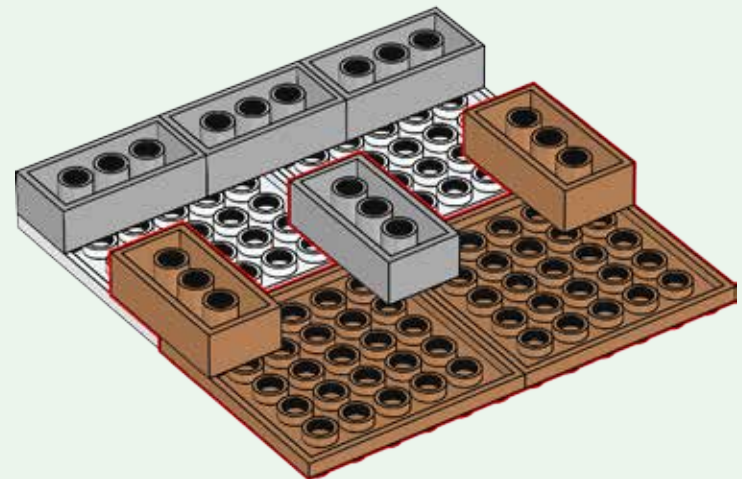

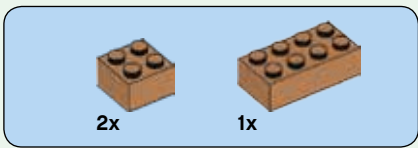

247

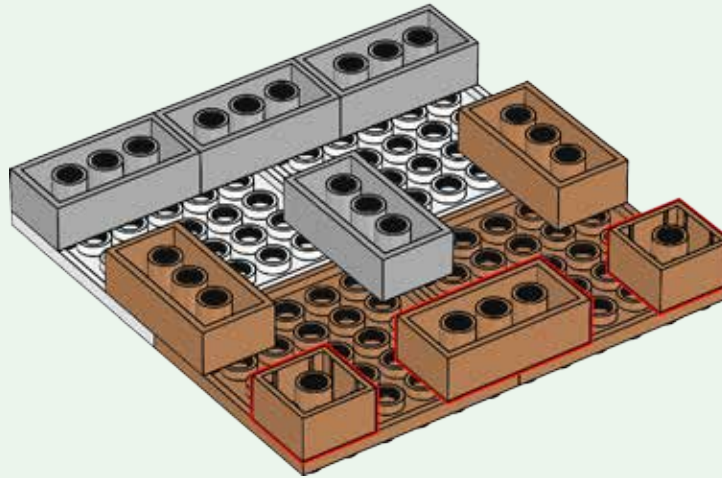

248

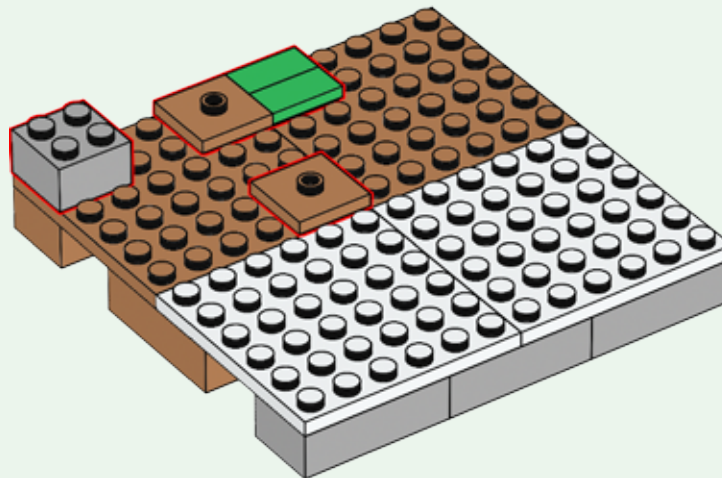
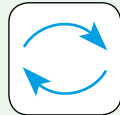



1x

249

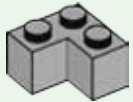

1x



1x

250

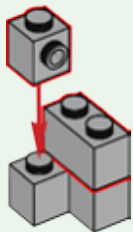

2x

251

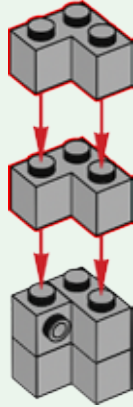

1x

252



1x



1x

253



1x



1x

254

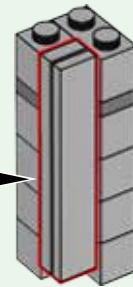
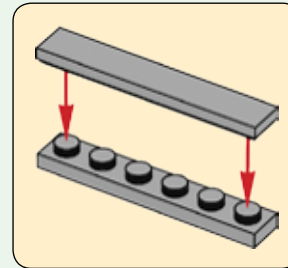

255

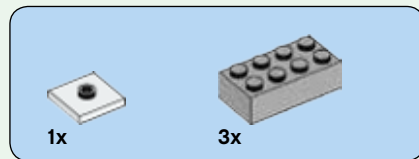
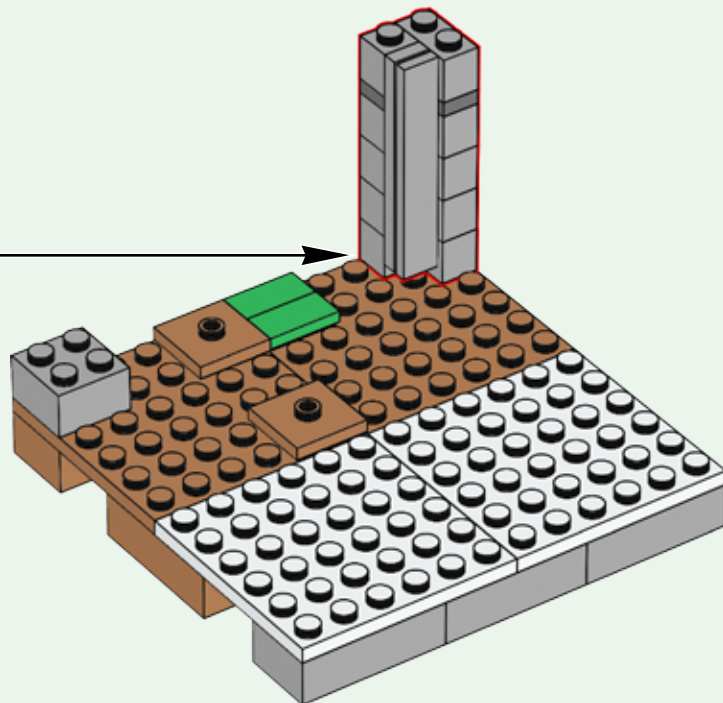

257

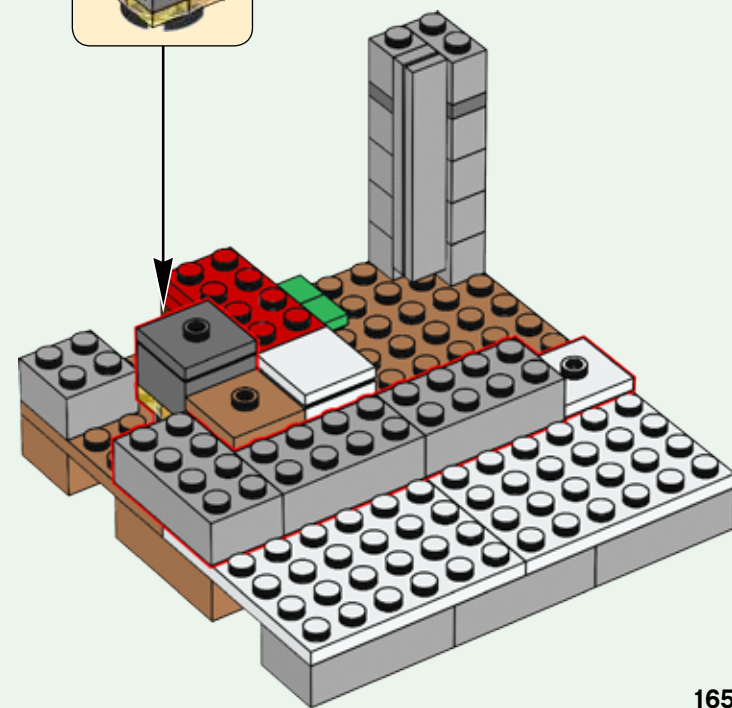
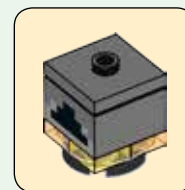

256

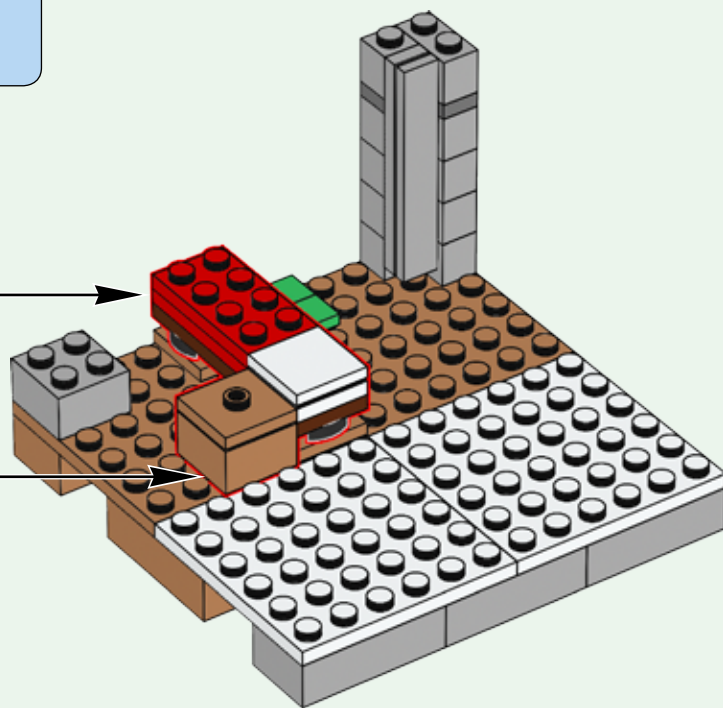
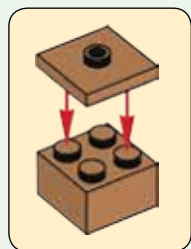
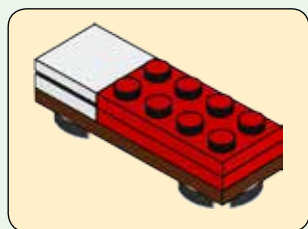

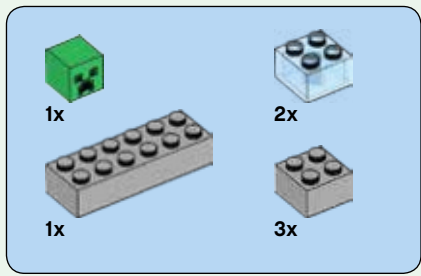

258

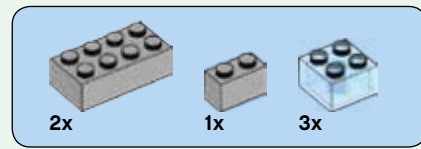
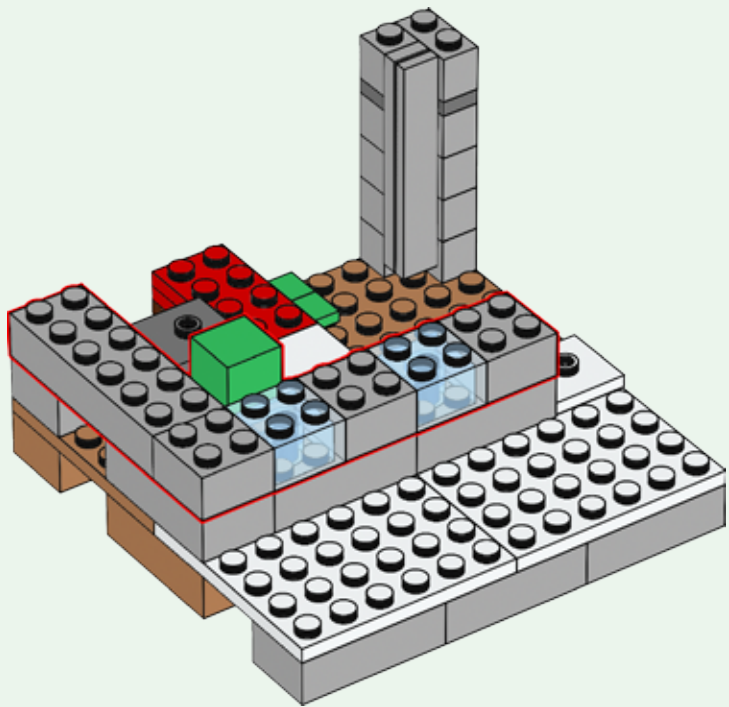

259

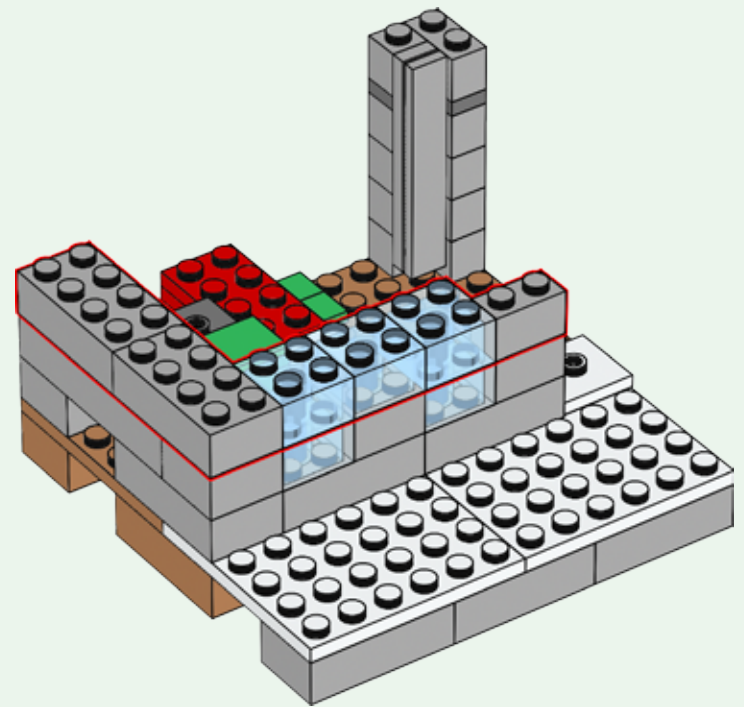

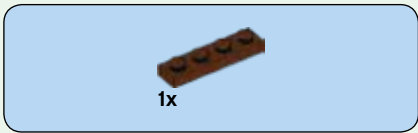

260



261

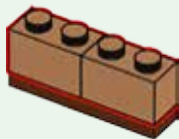

262



263

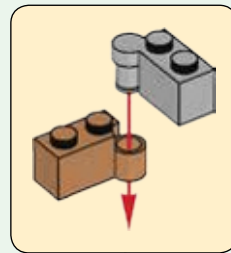

264

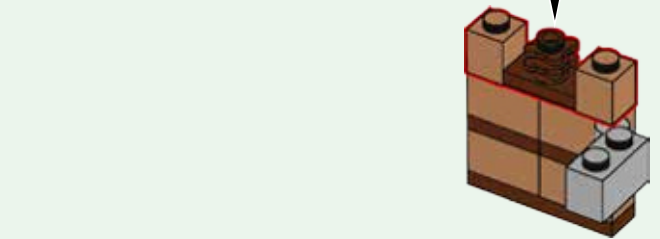
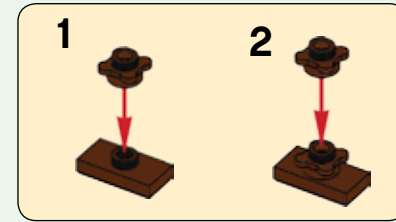

265

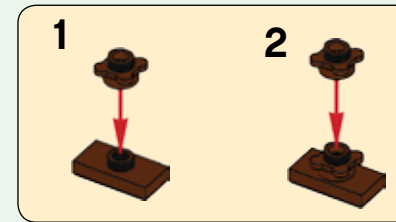

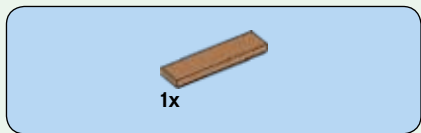

266

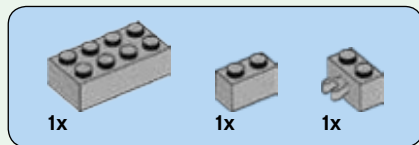
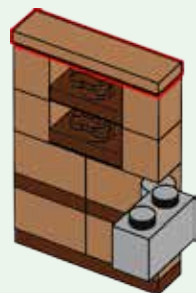

268

267

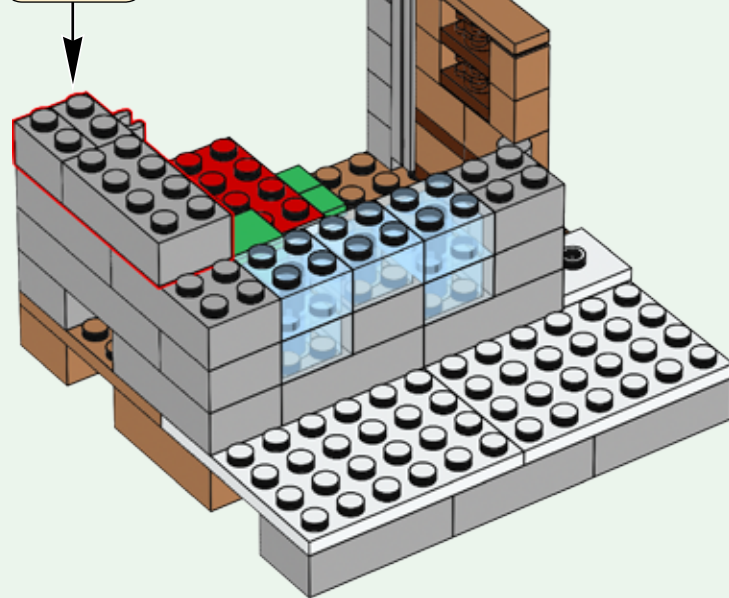
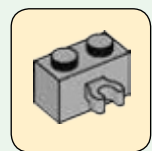
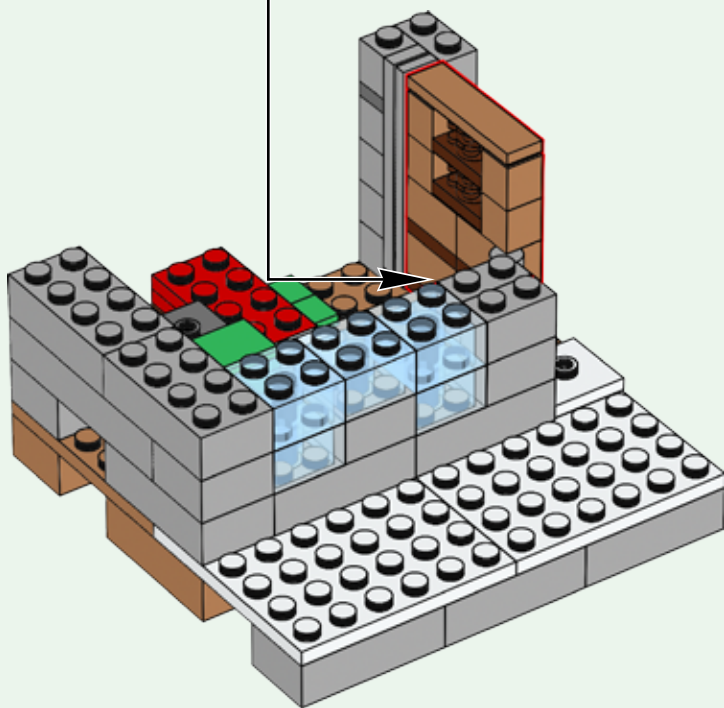

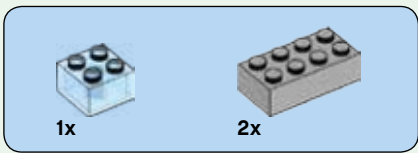

269

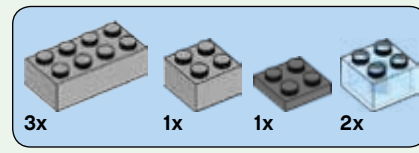
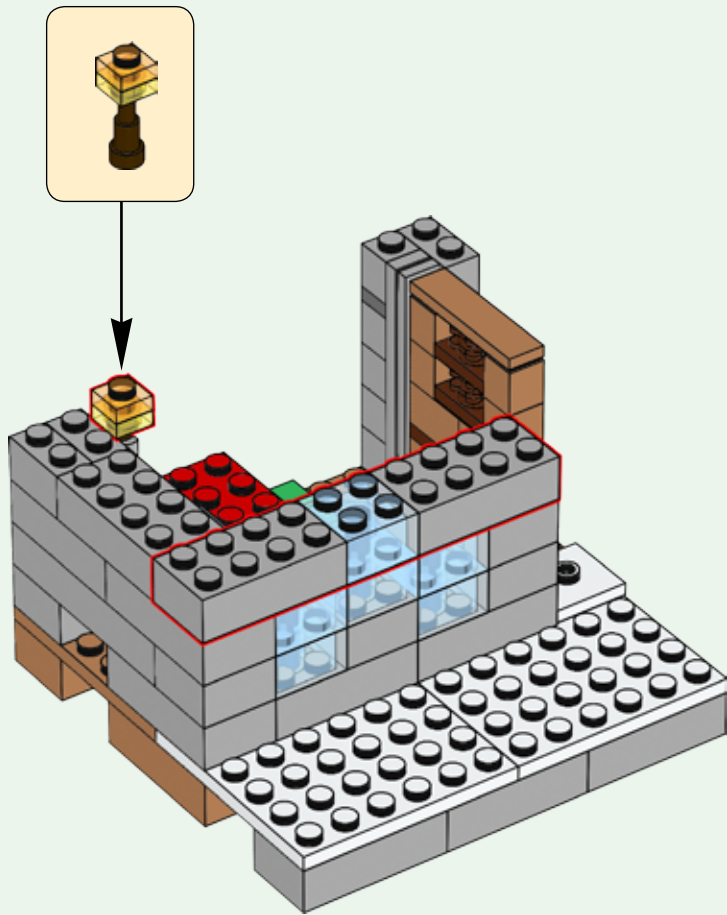

270

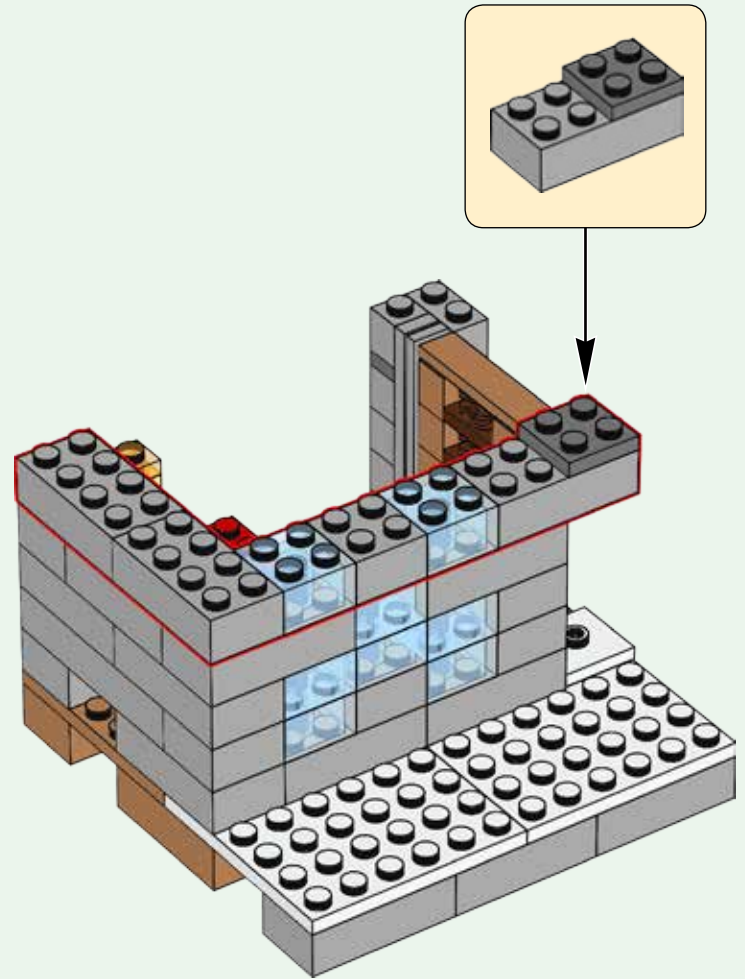

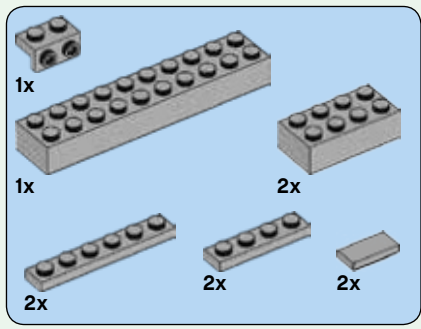

271

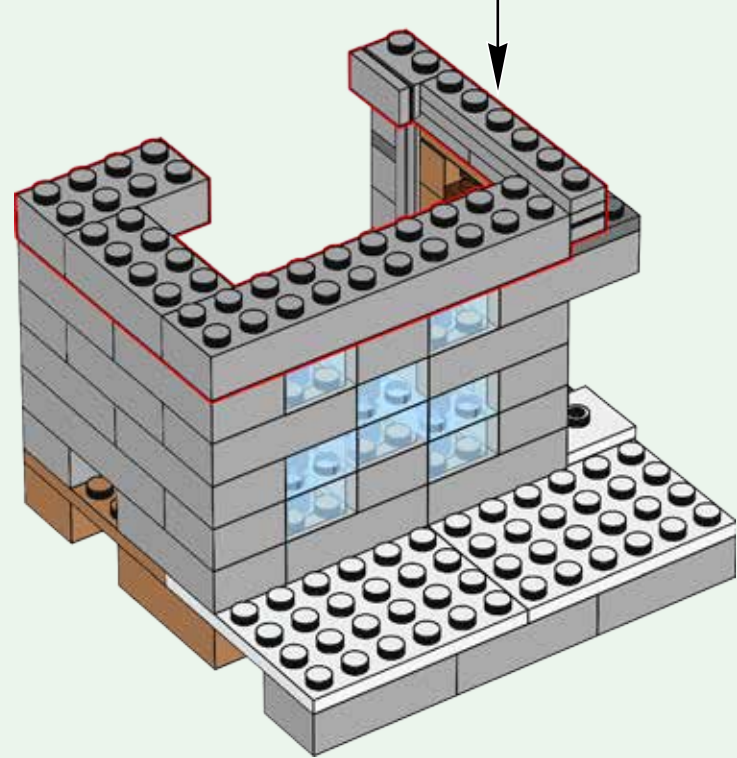
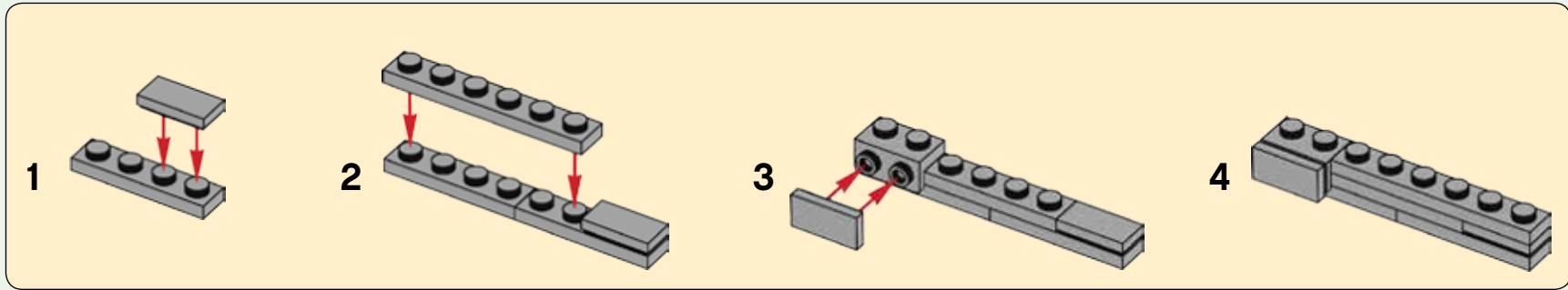

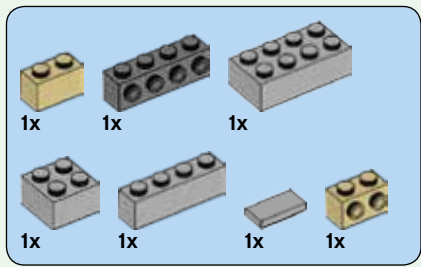

274

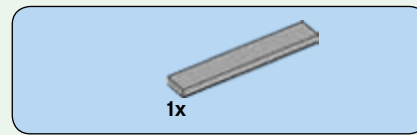
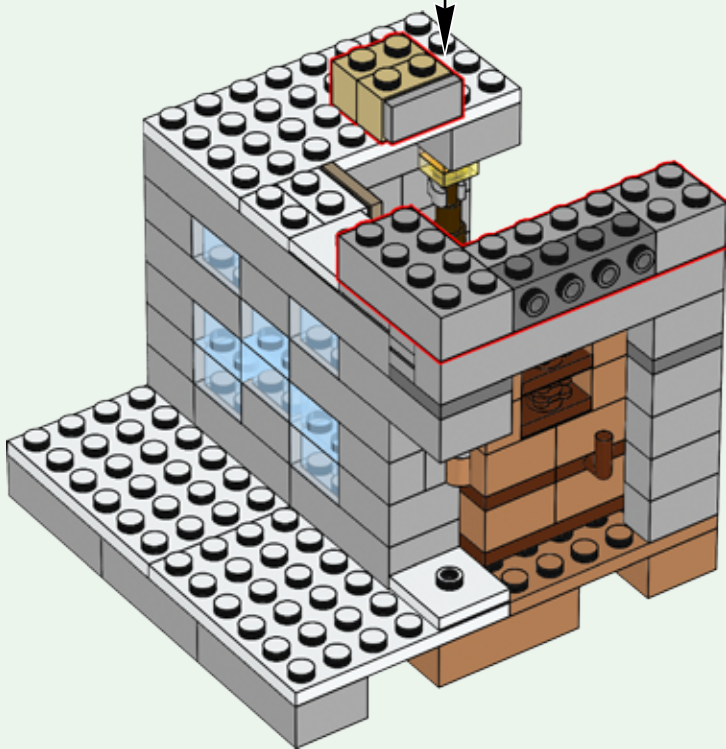
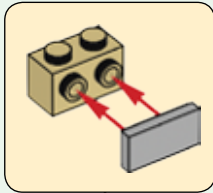

275

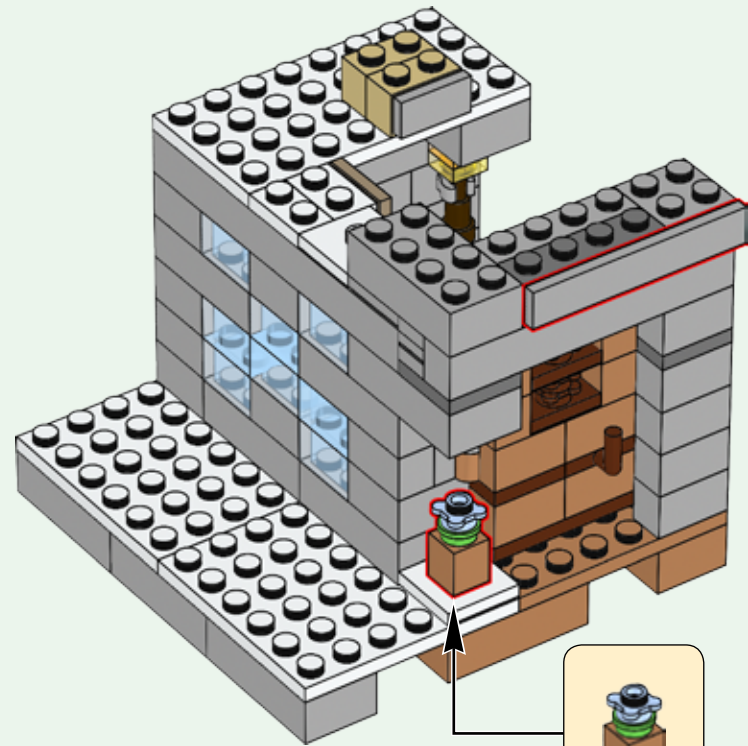

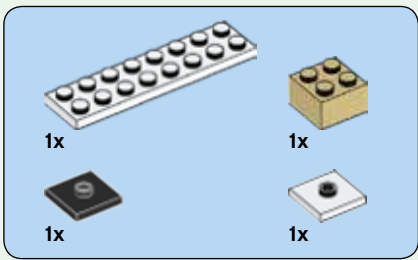

276

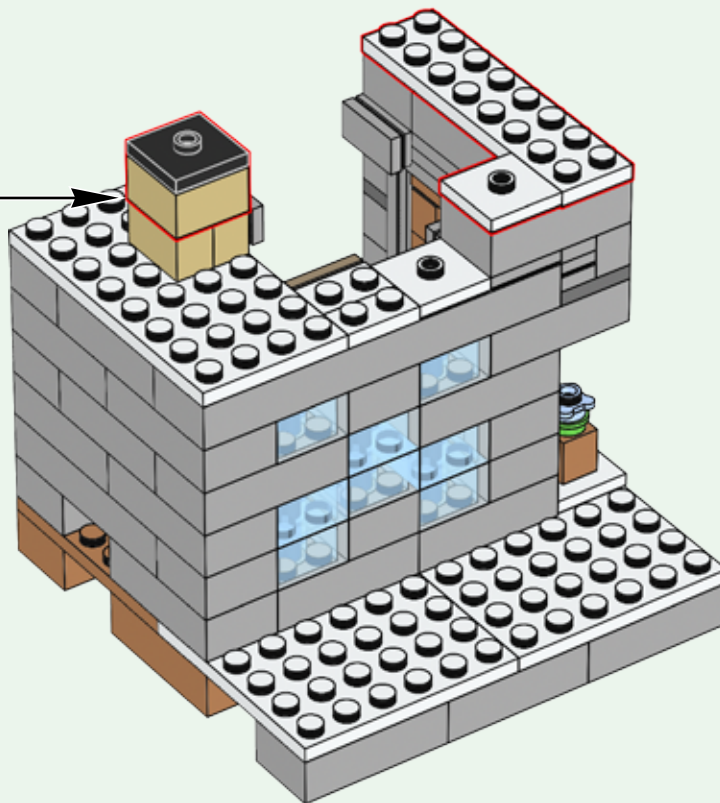
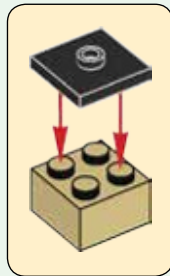
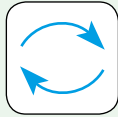

277

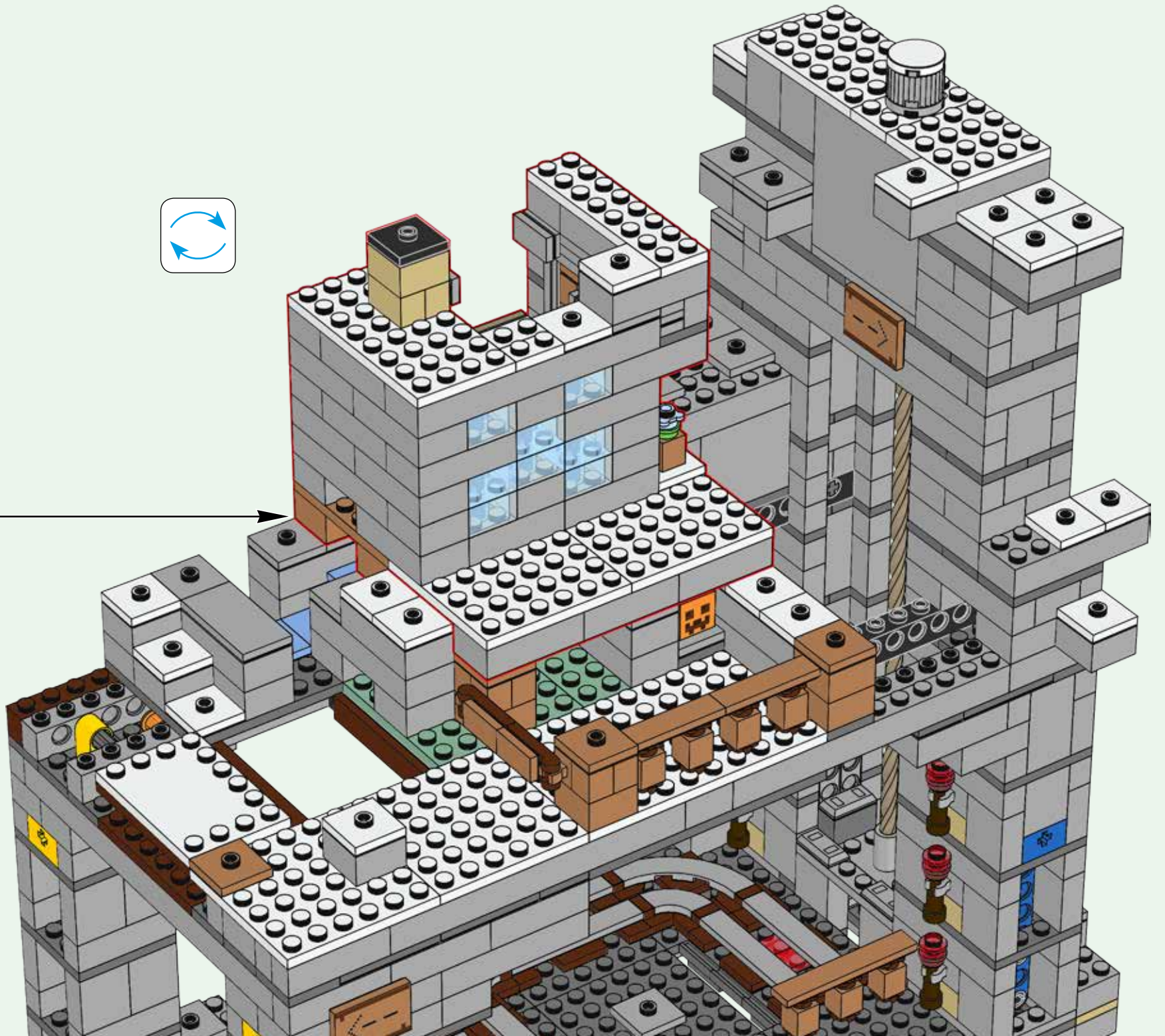

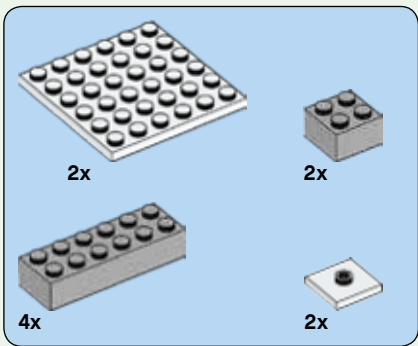

278

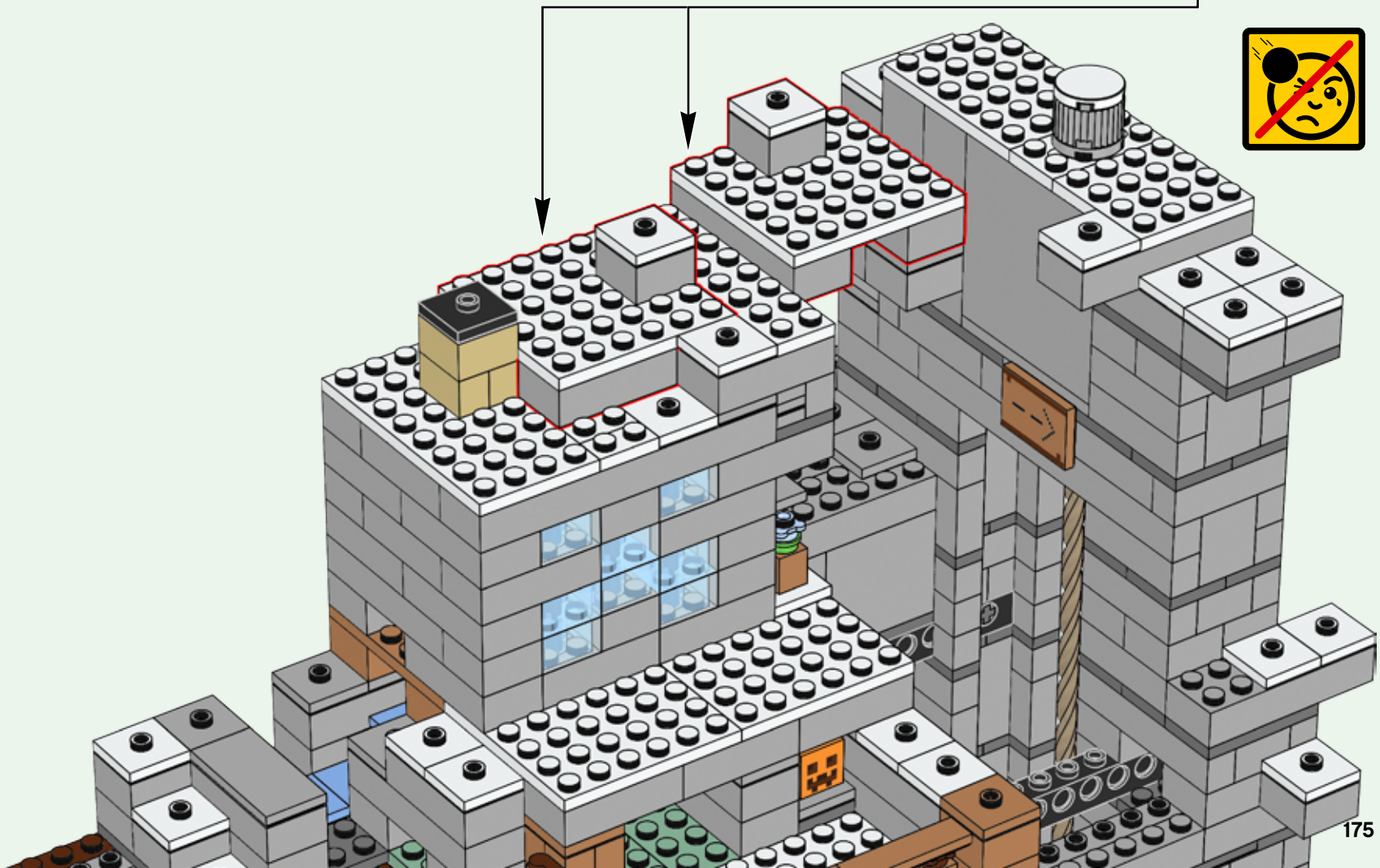
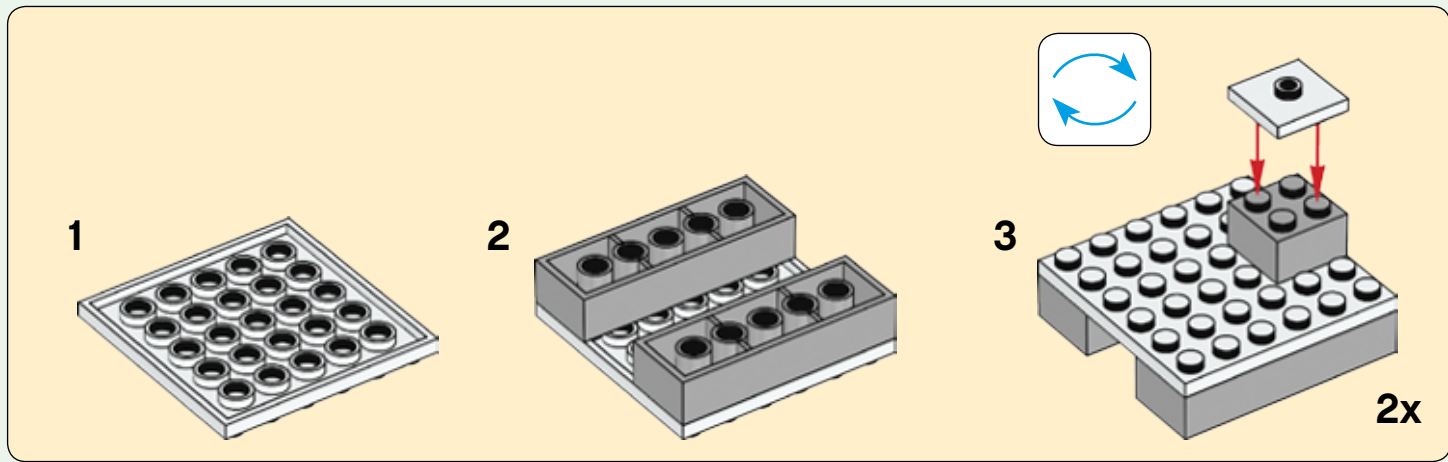

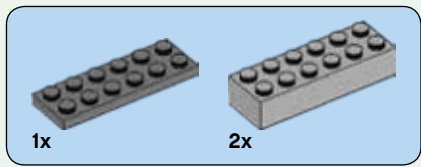

279

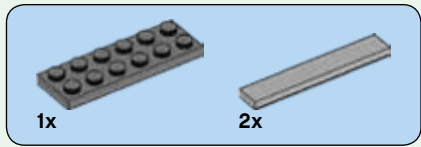
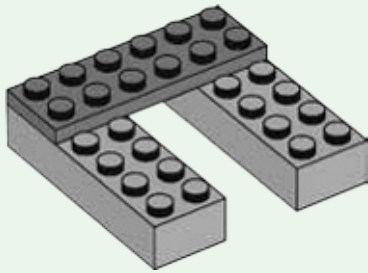

280

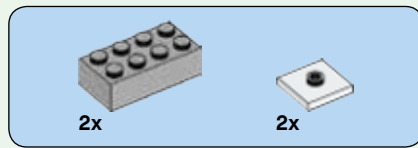
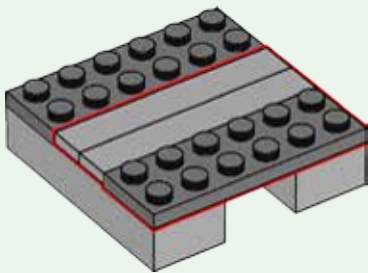

281

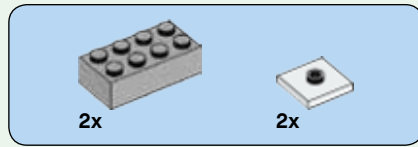
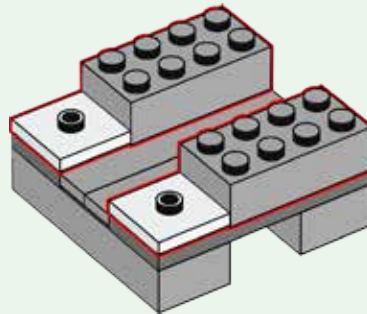

282

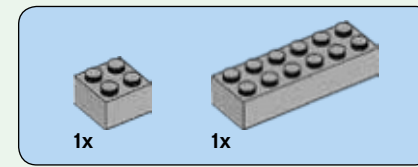
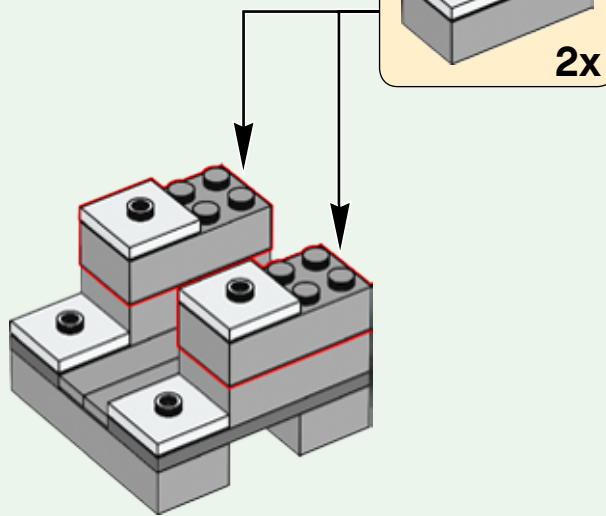

283

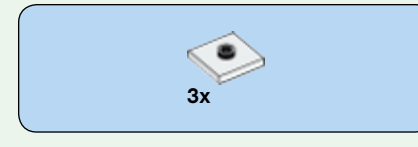
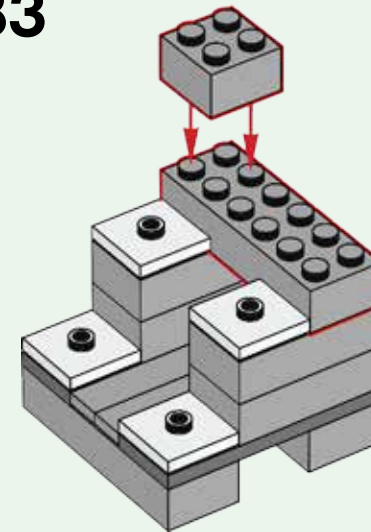

284

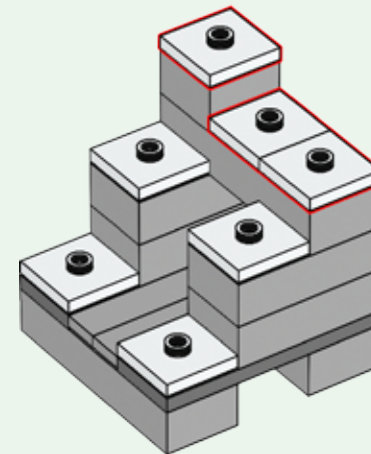

285

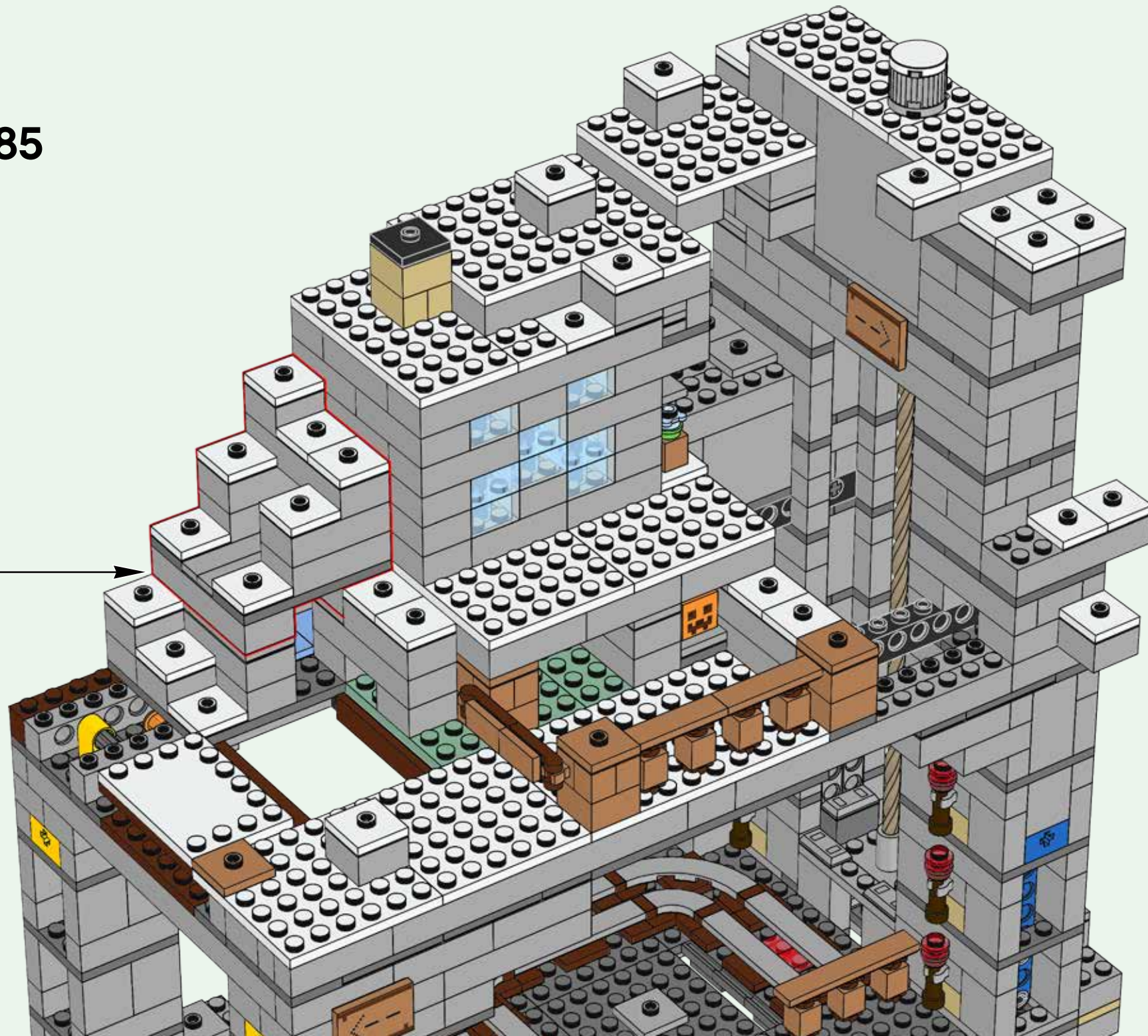

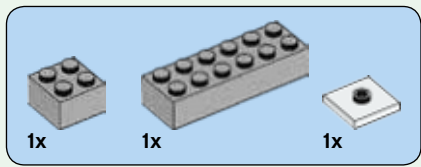

286

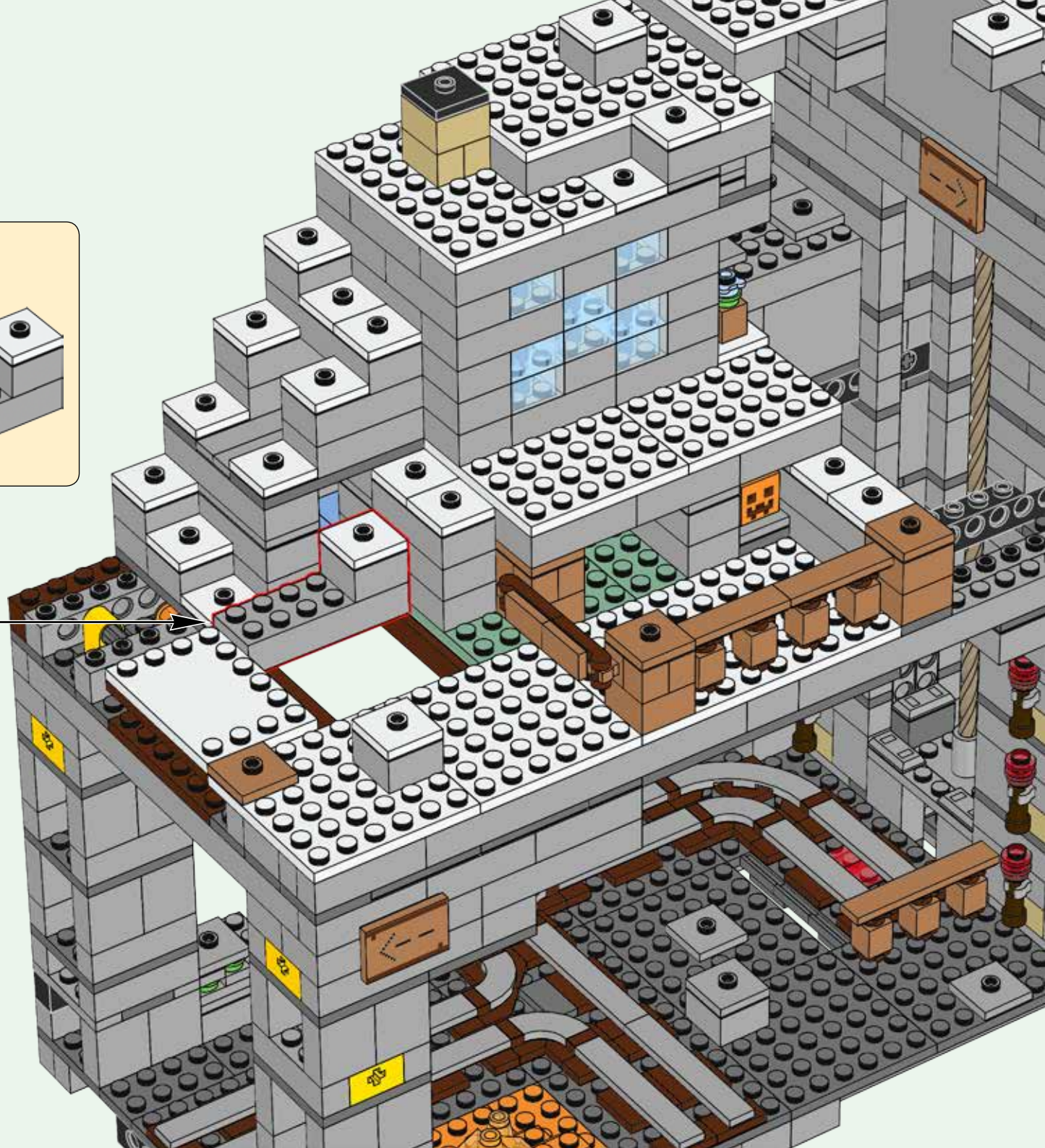
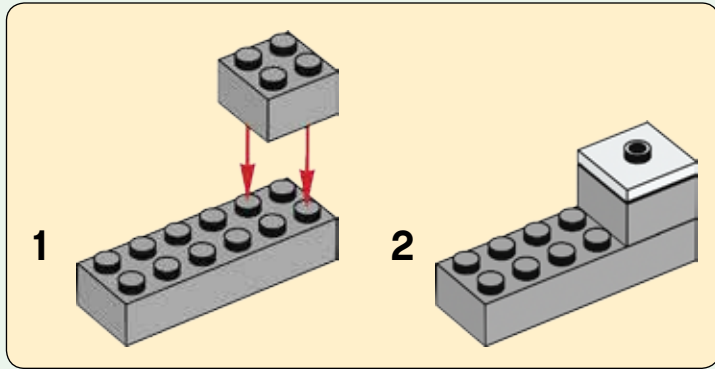

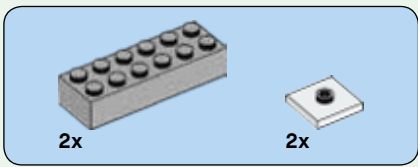

287

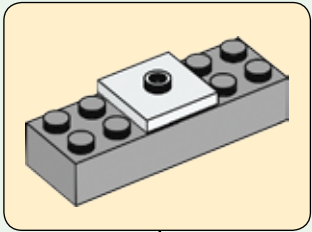
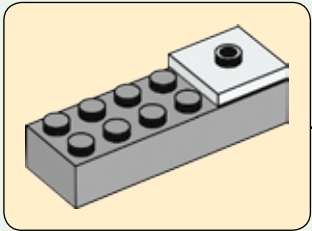

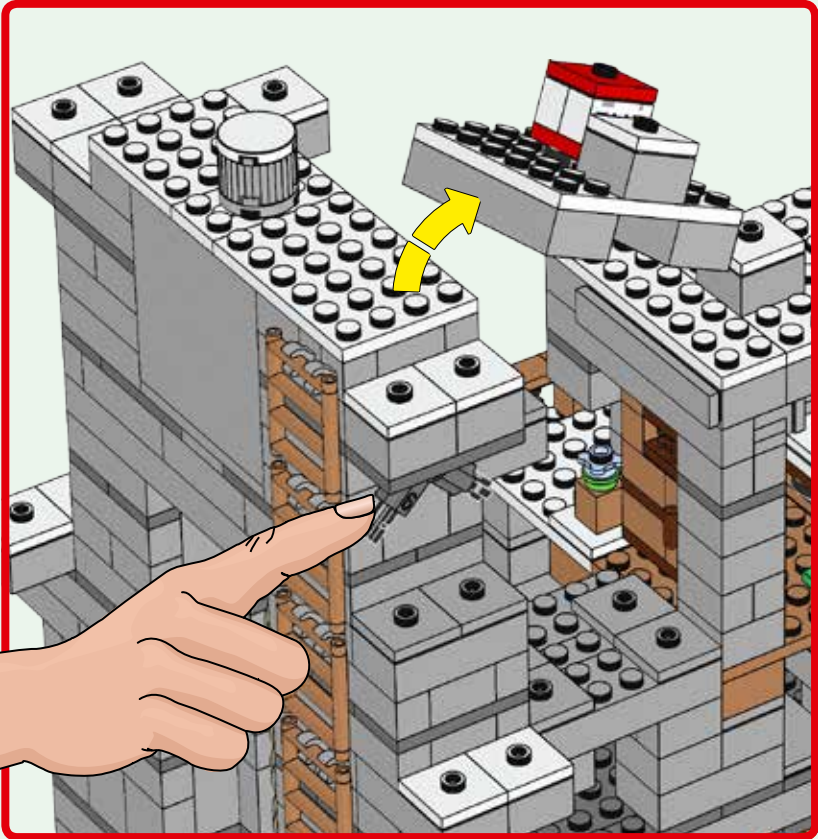
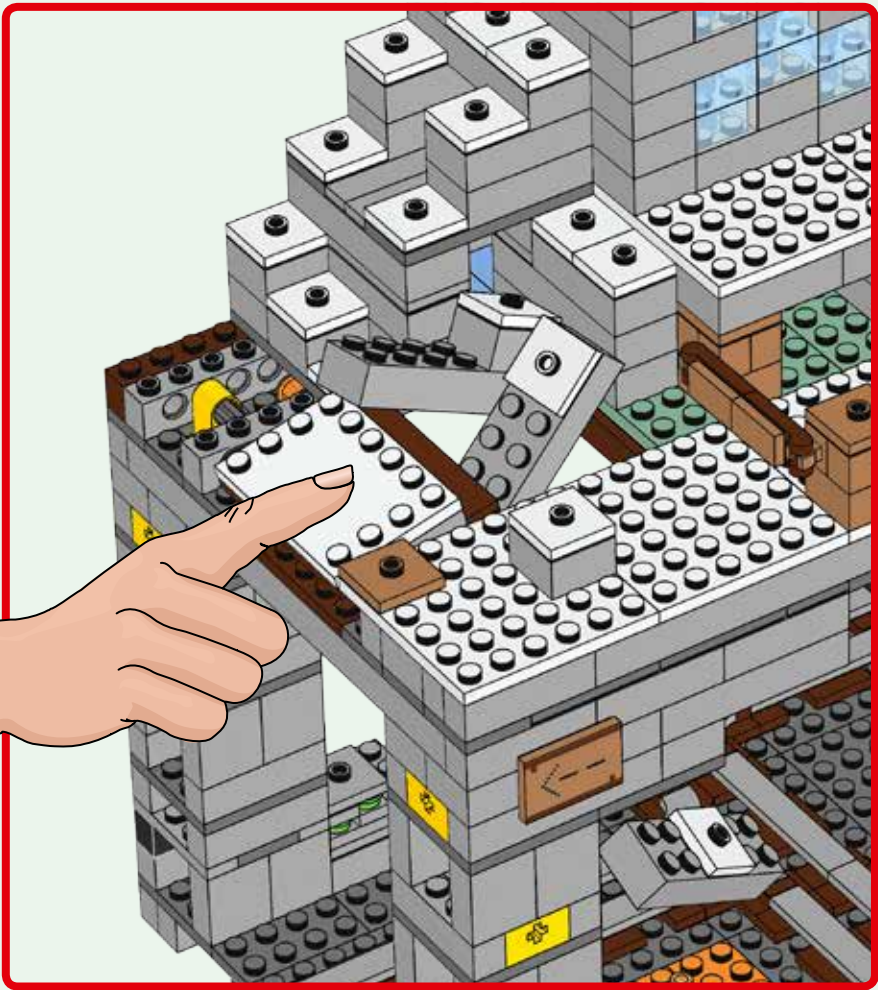

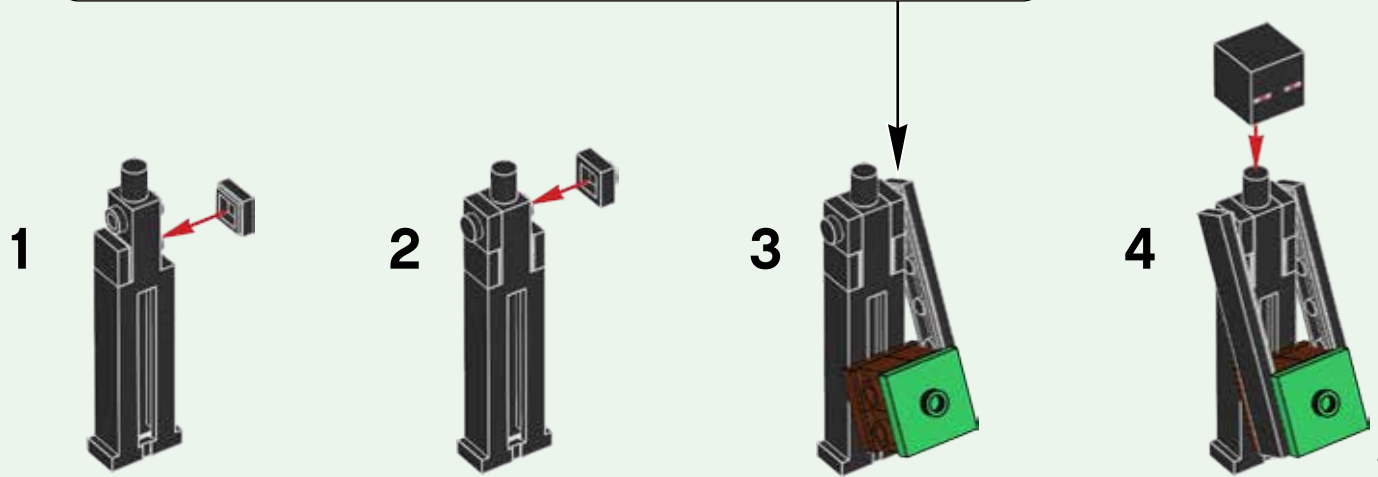
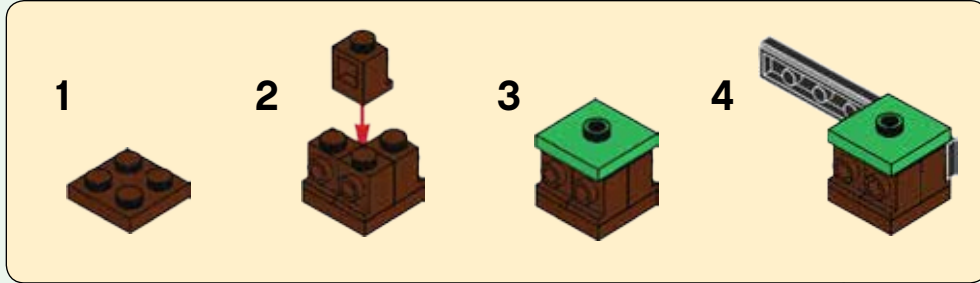
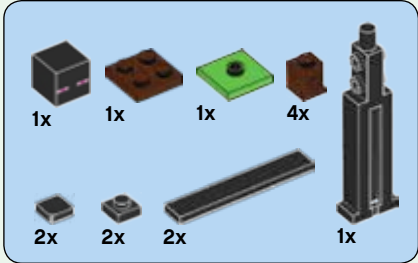

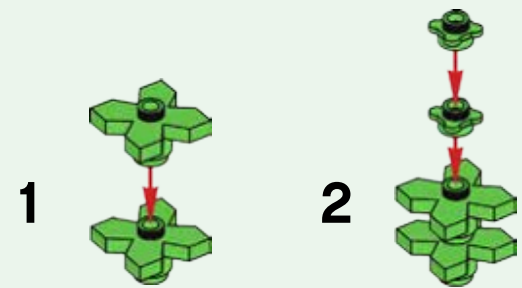
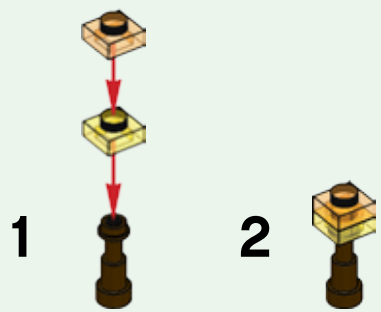
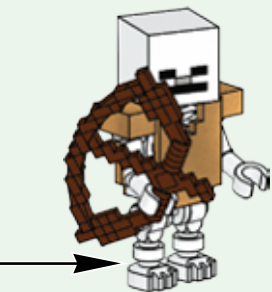
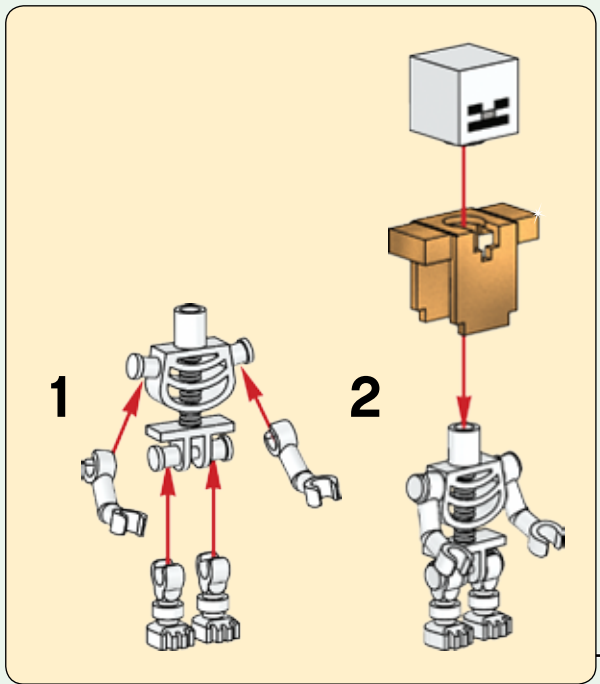
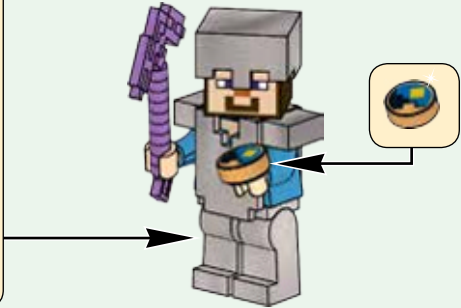
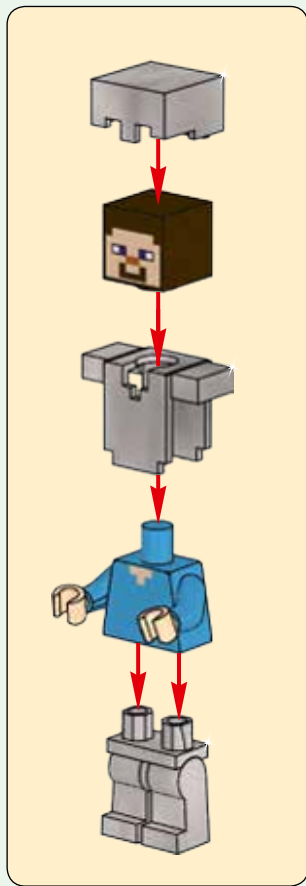

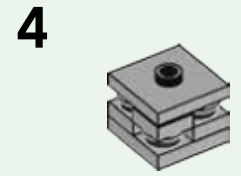
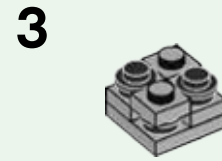
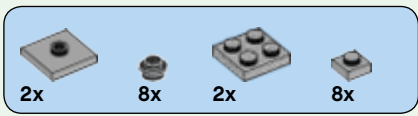

2x



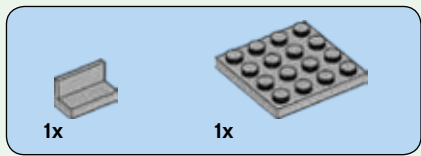

288

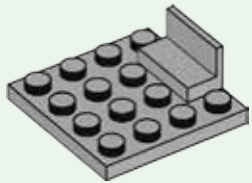

289

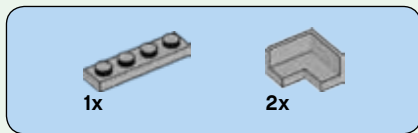
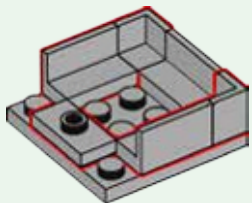

290

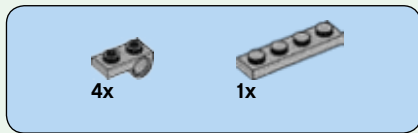
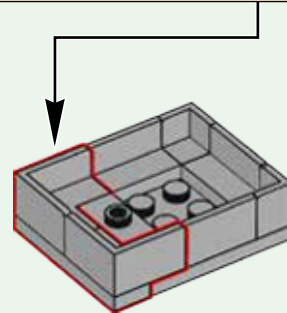
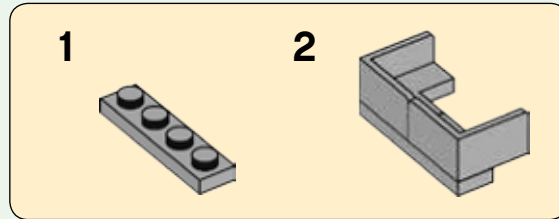

291

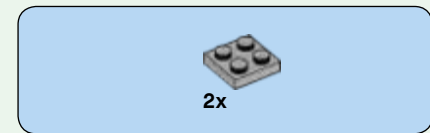
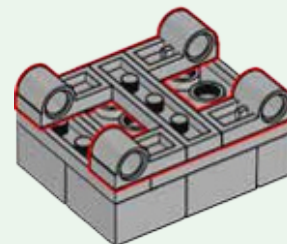
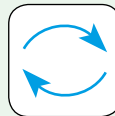

292

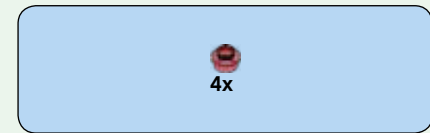
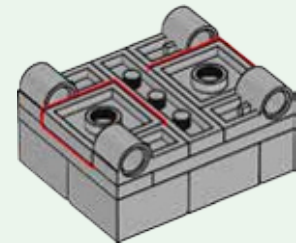

293

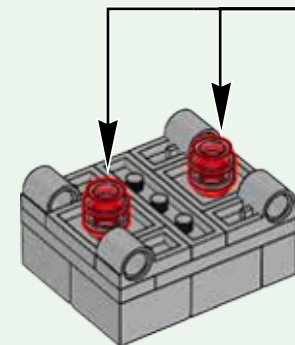
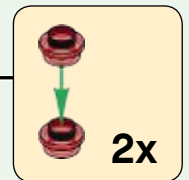



294

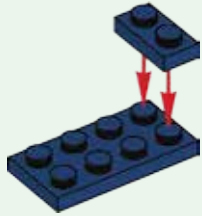

295

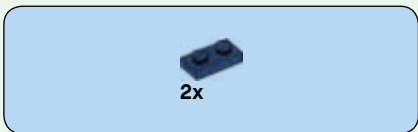

296

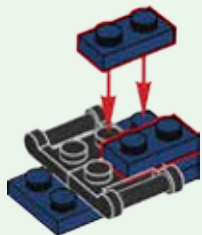

297

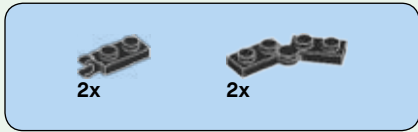

298

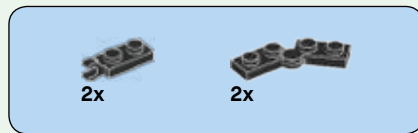
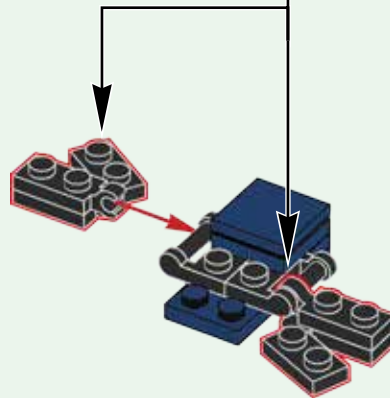
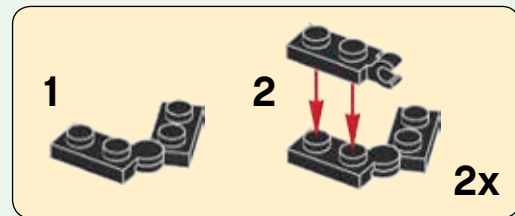

299

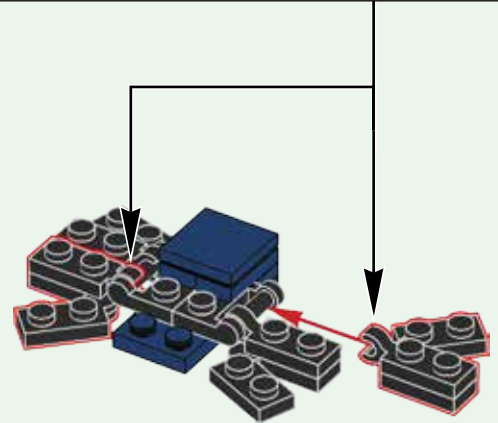
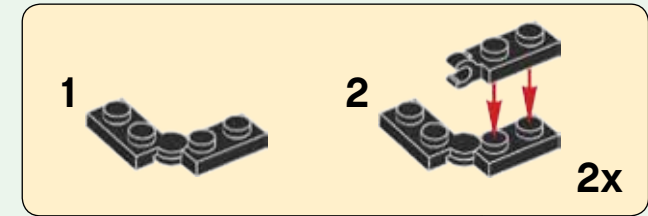

300

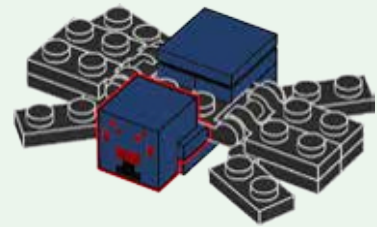



301

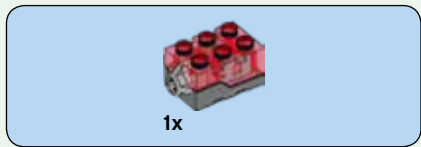
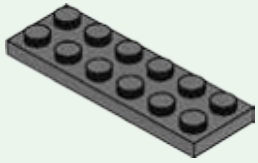

302

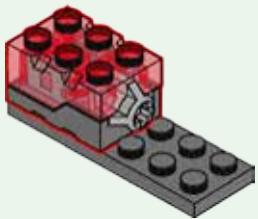

303



2x

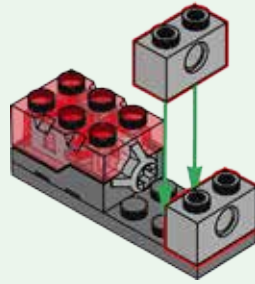

304



1x



2x

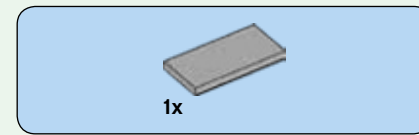
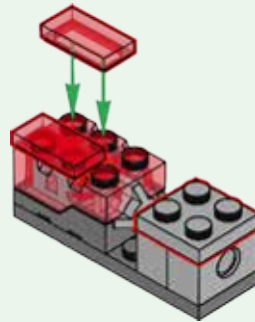

305

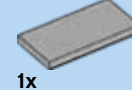

1x

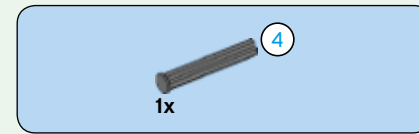
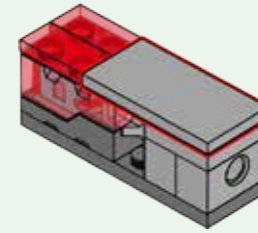

306



1x

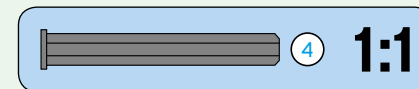
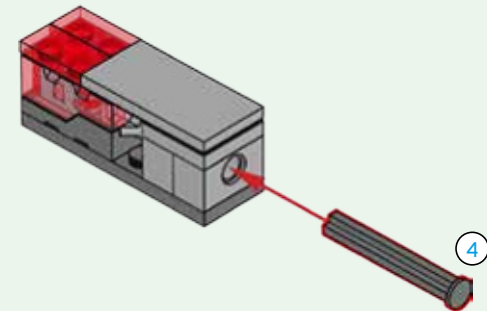

4

1:1

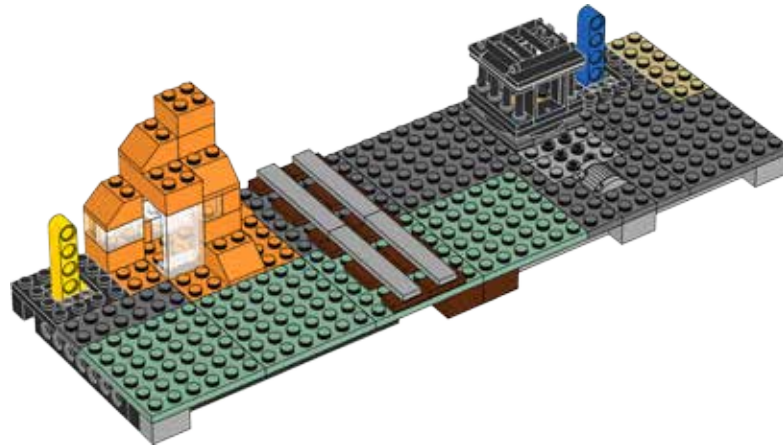

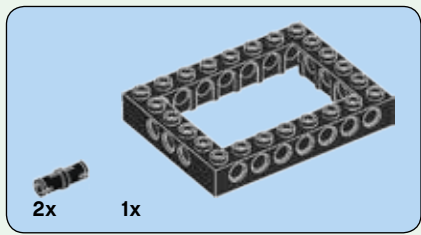

307

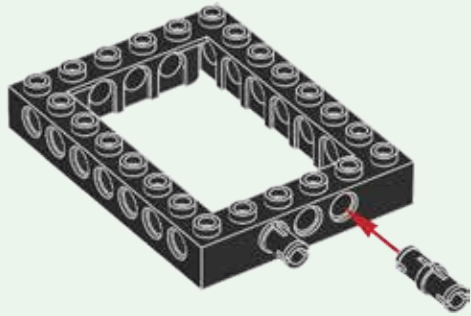

308

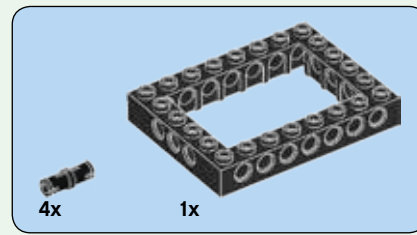
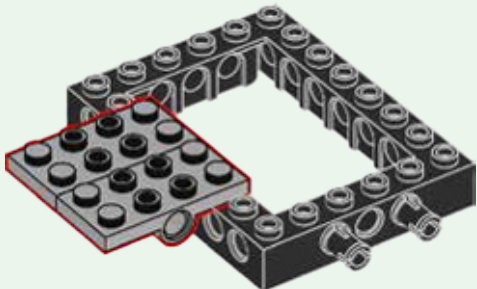

309

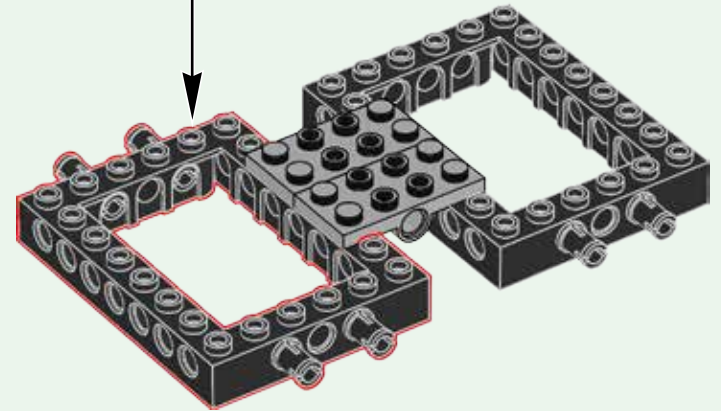
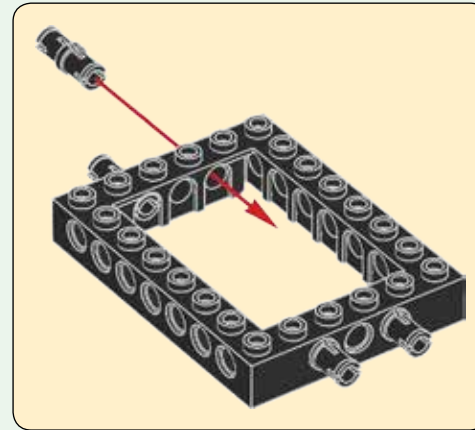

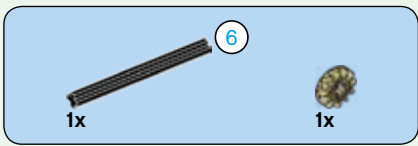

310

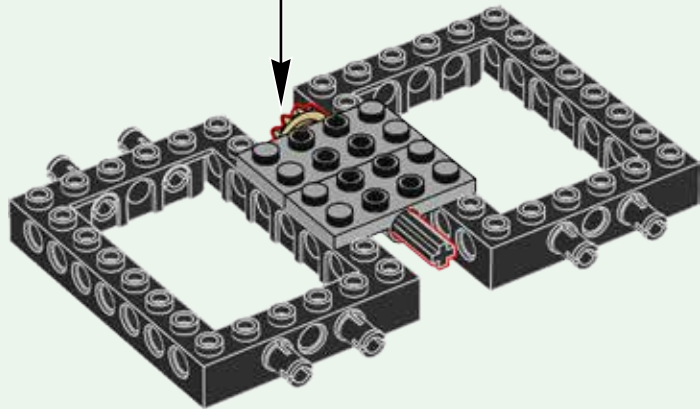
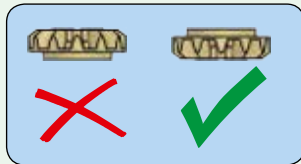
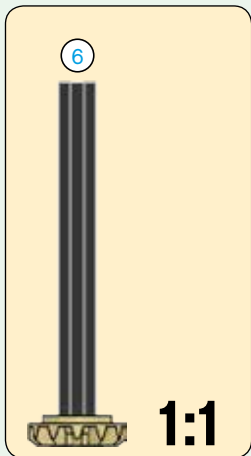

311

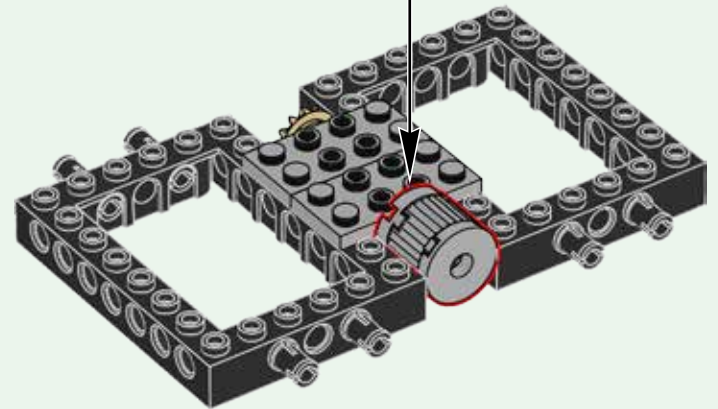
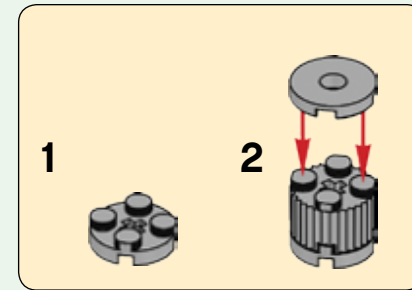

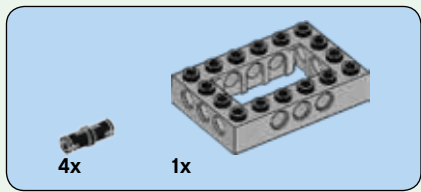

312

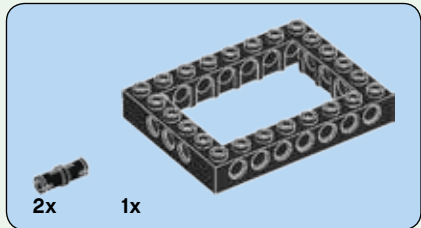
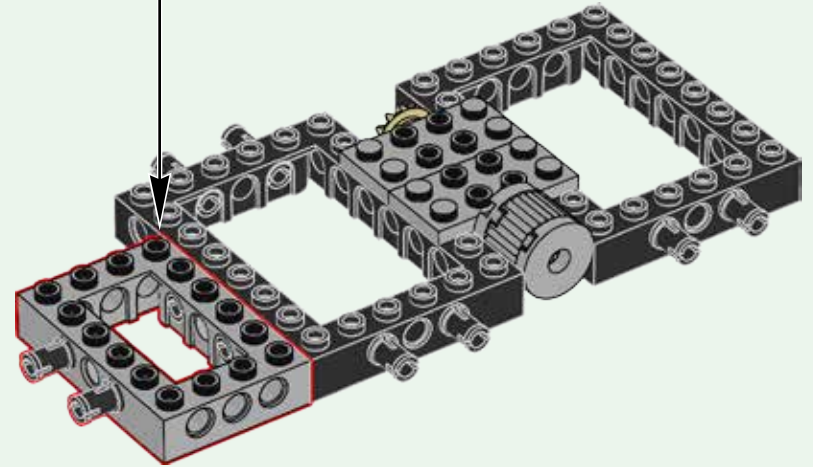
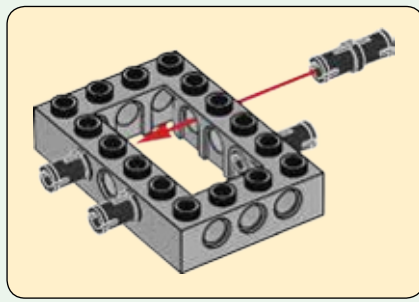

313

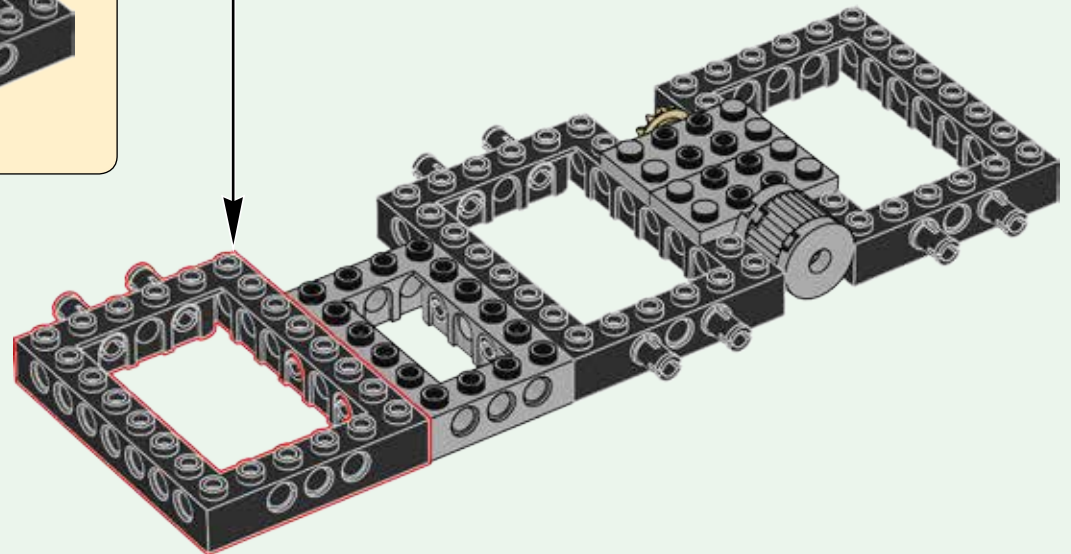
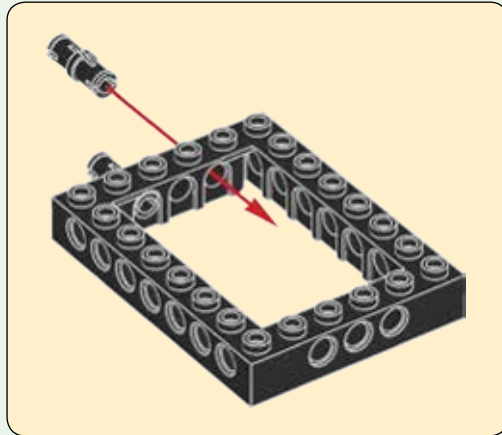

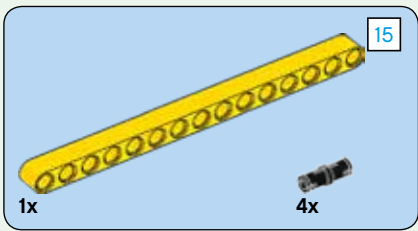

314

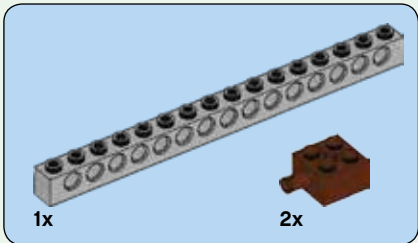
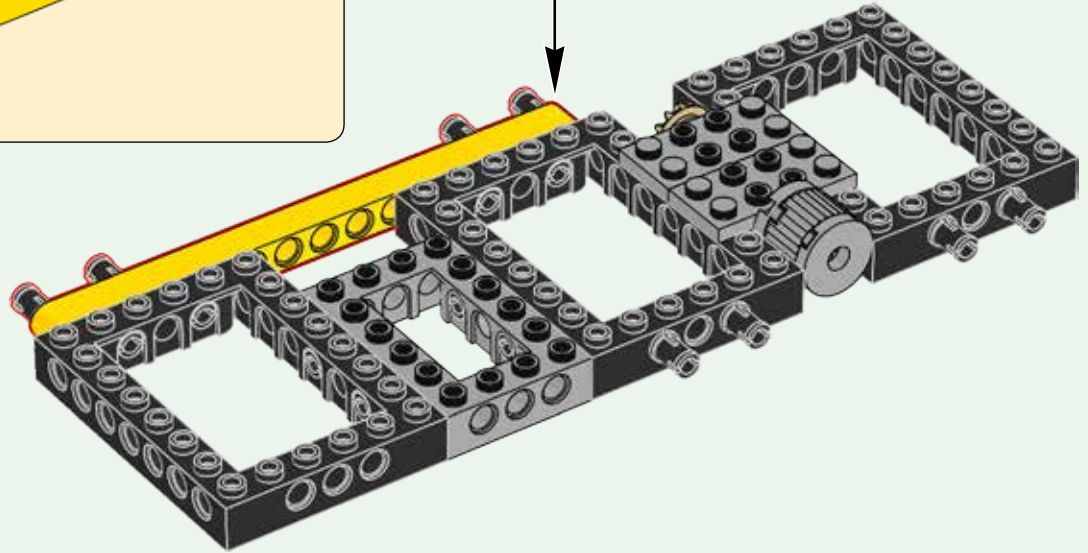
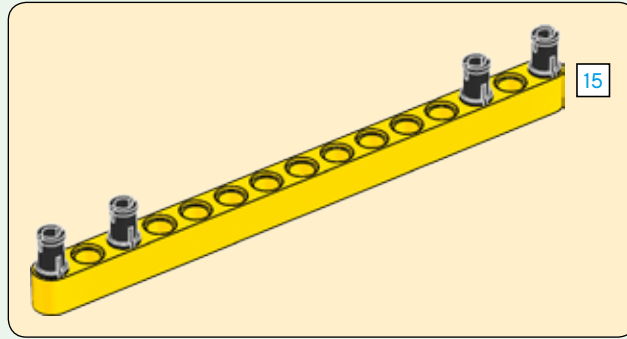
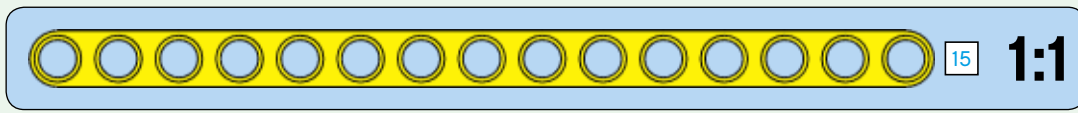

315

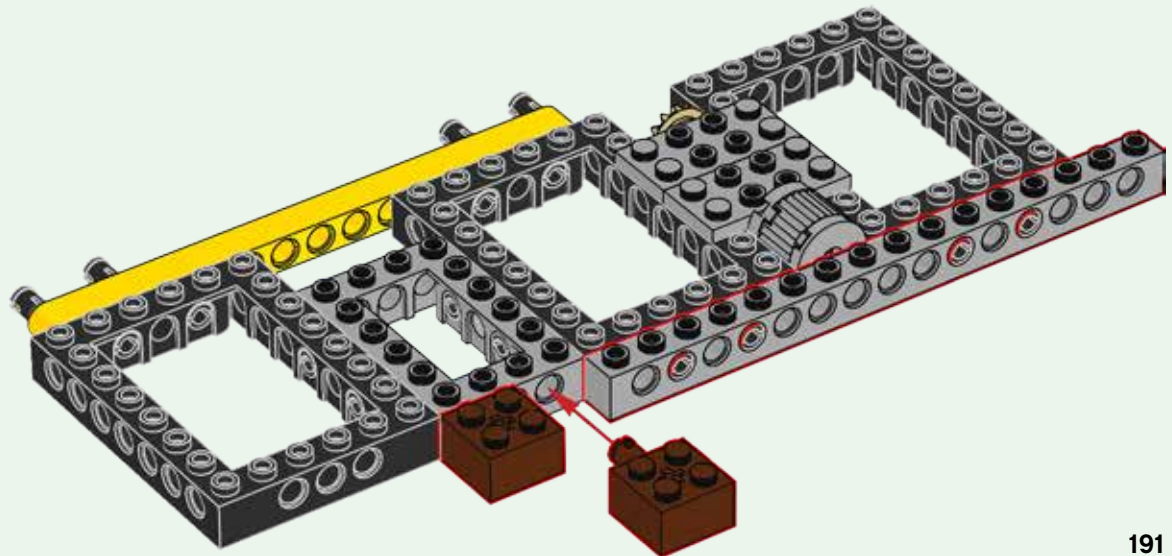



2x

316

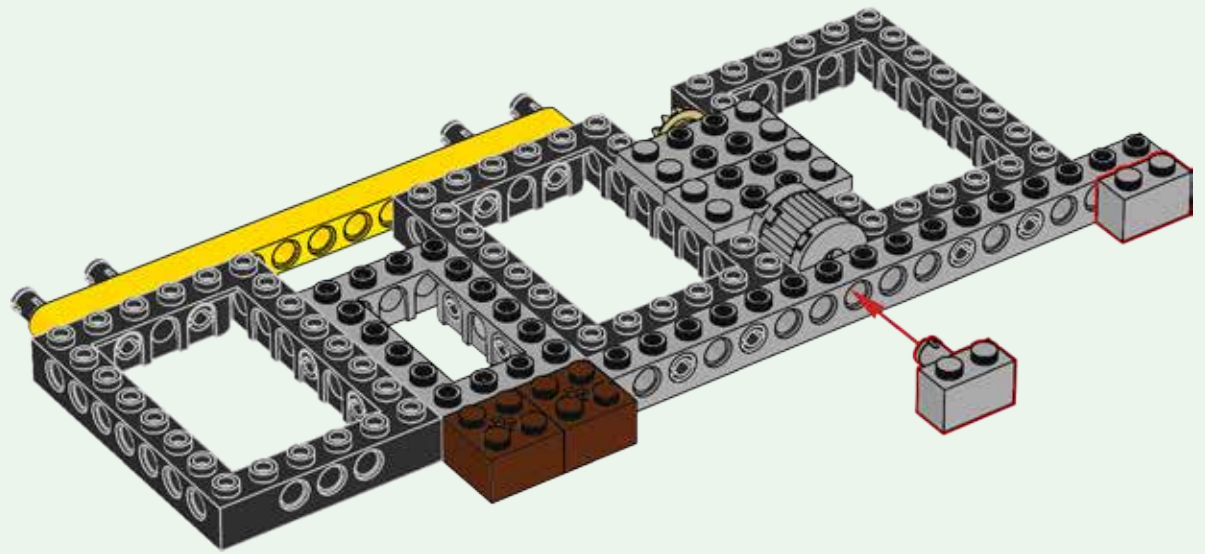

1x

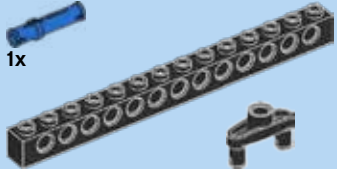

1x



1x

317

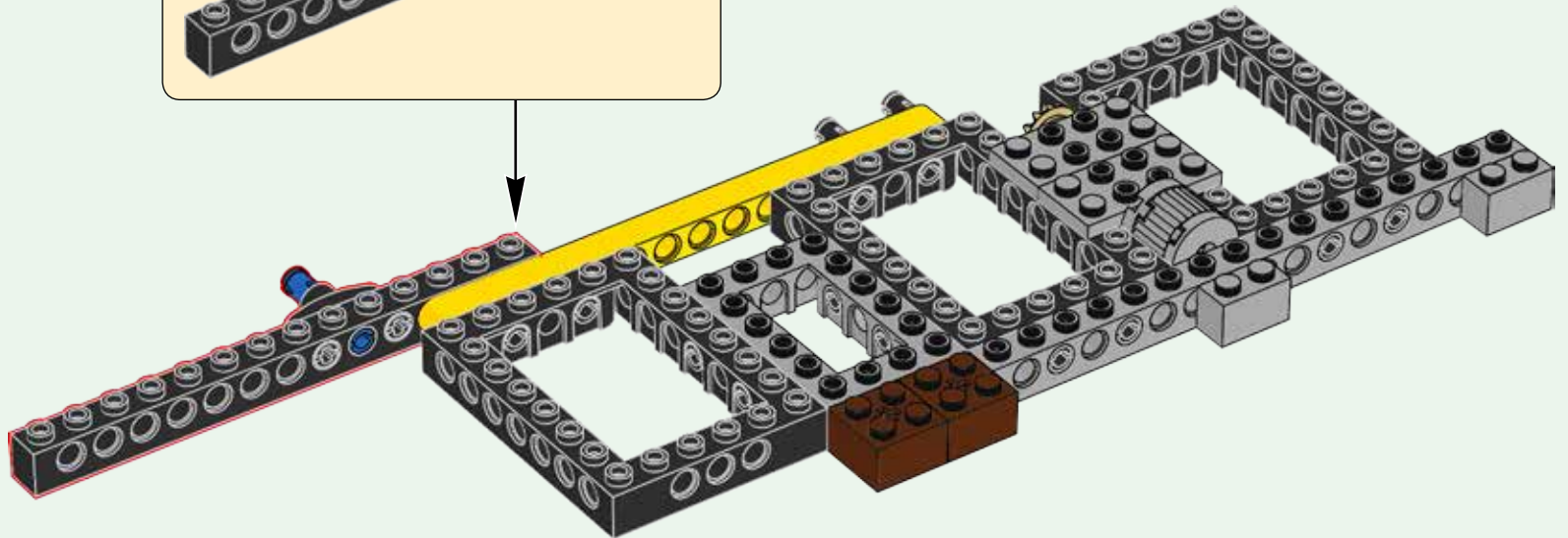
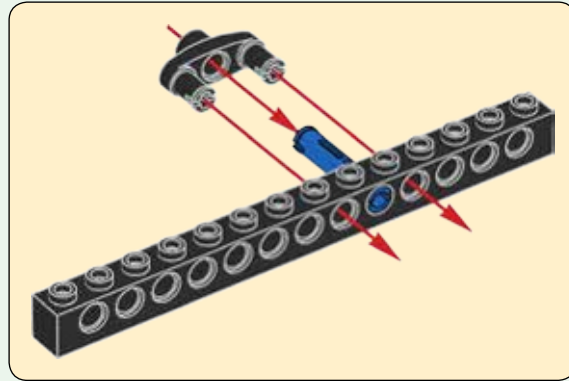

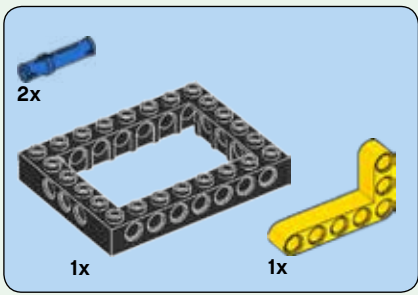

318

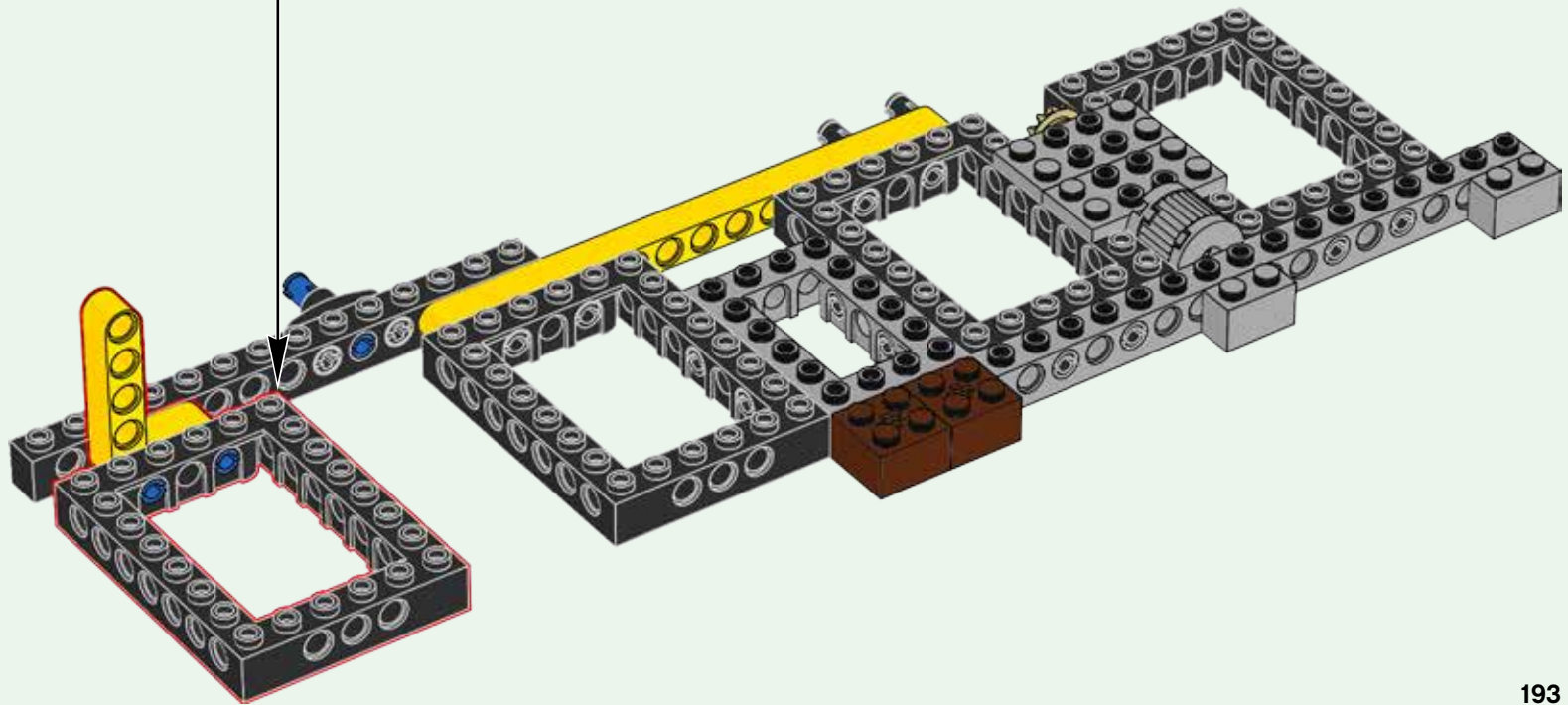
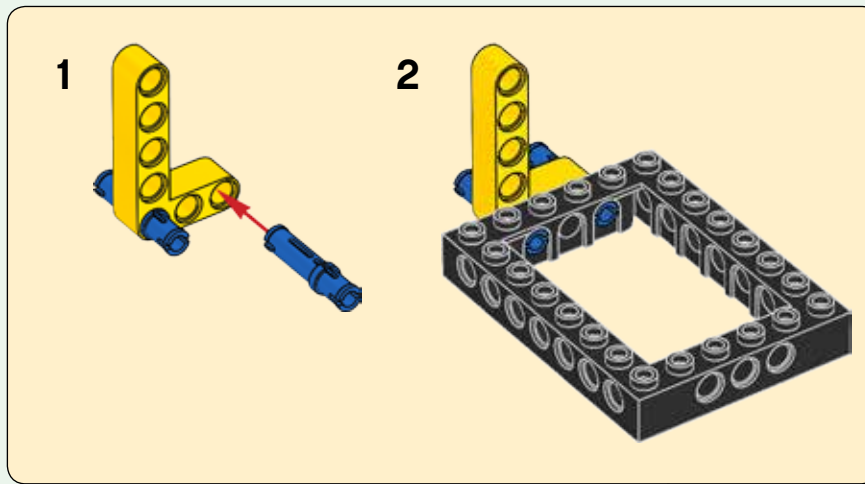

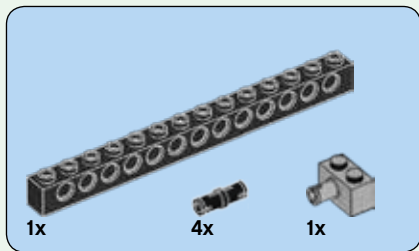

319

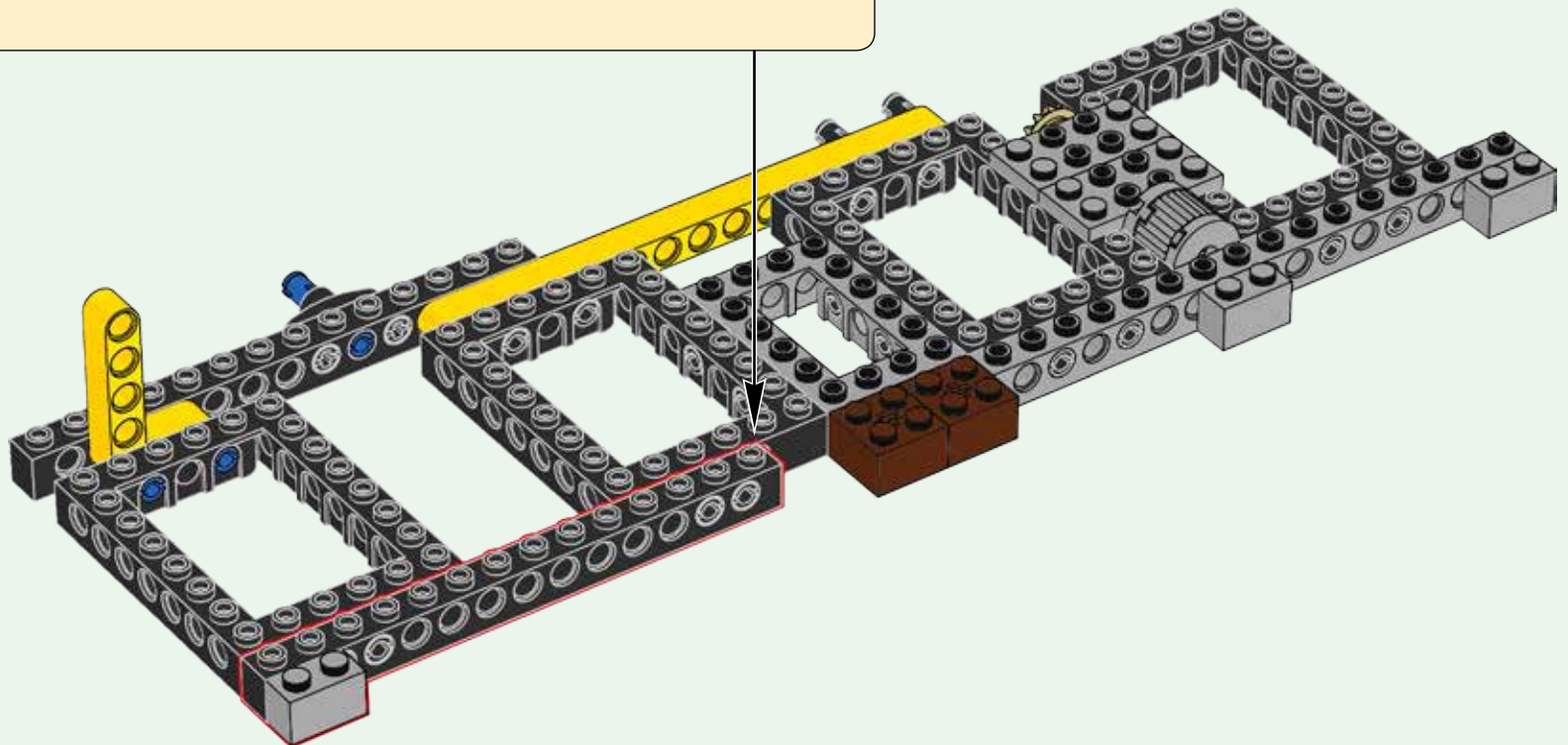
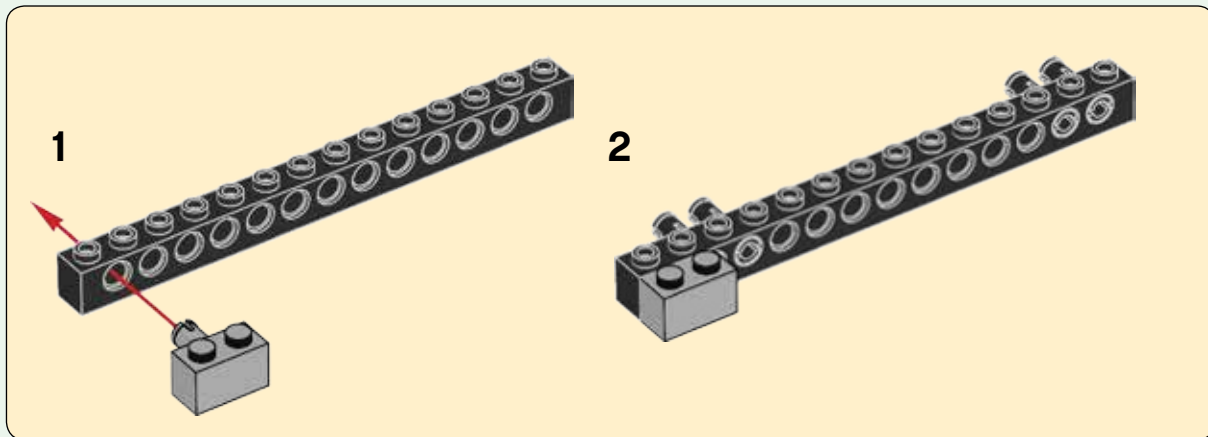

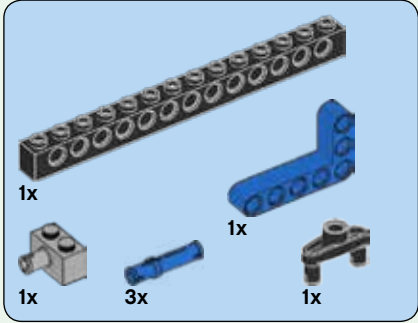
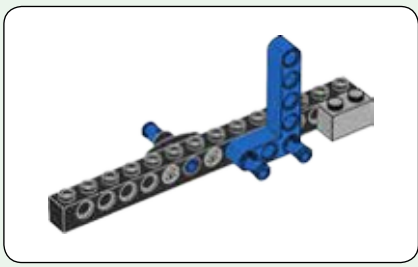

320

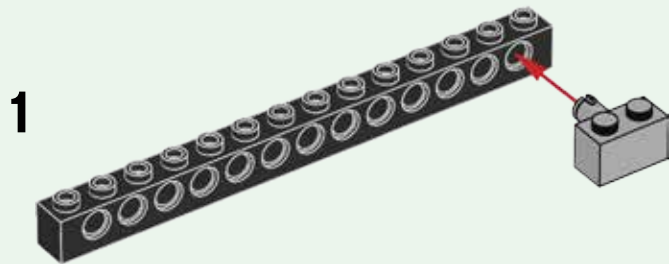

2

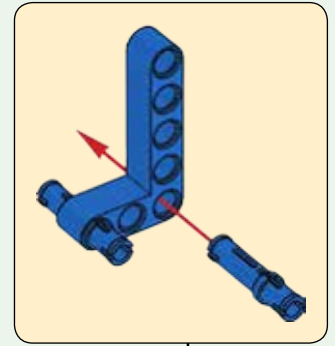
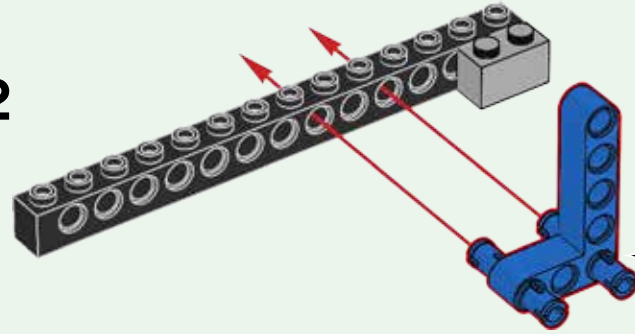

3

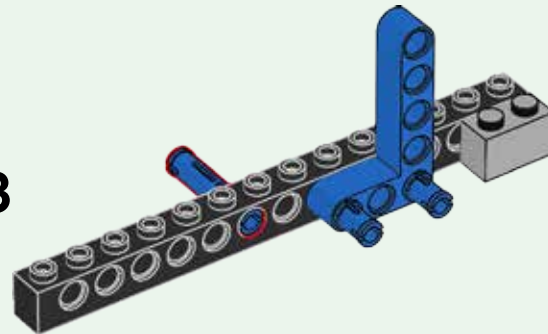

4

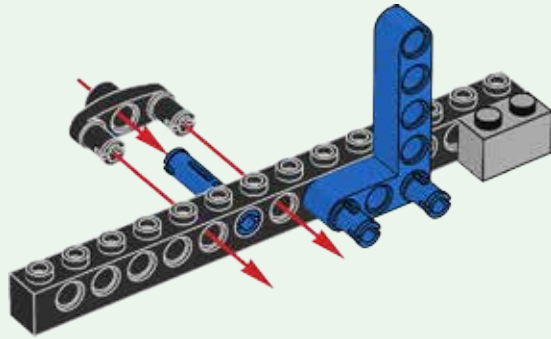

321

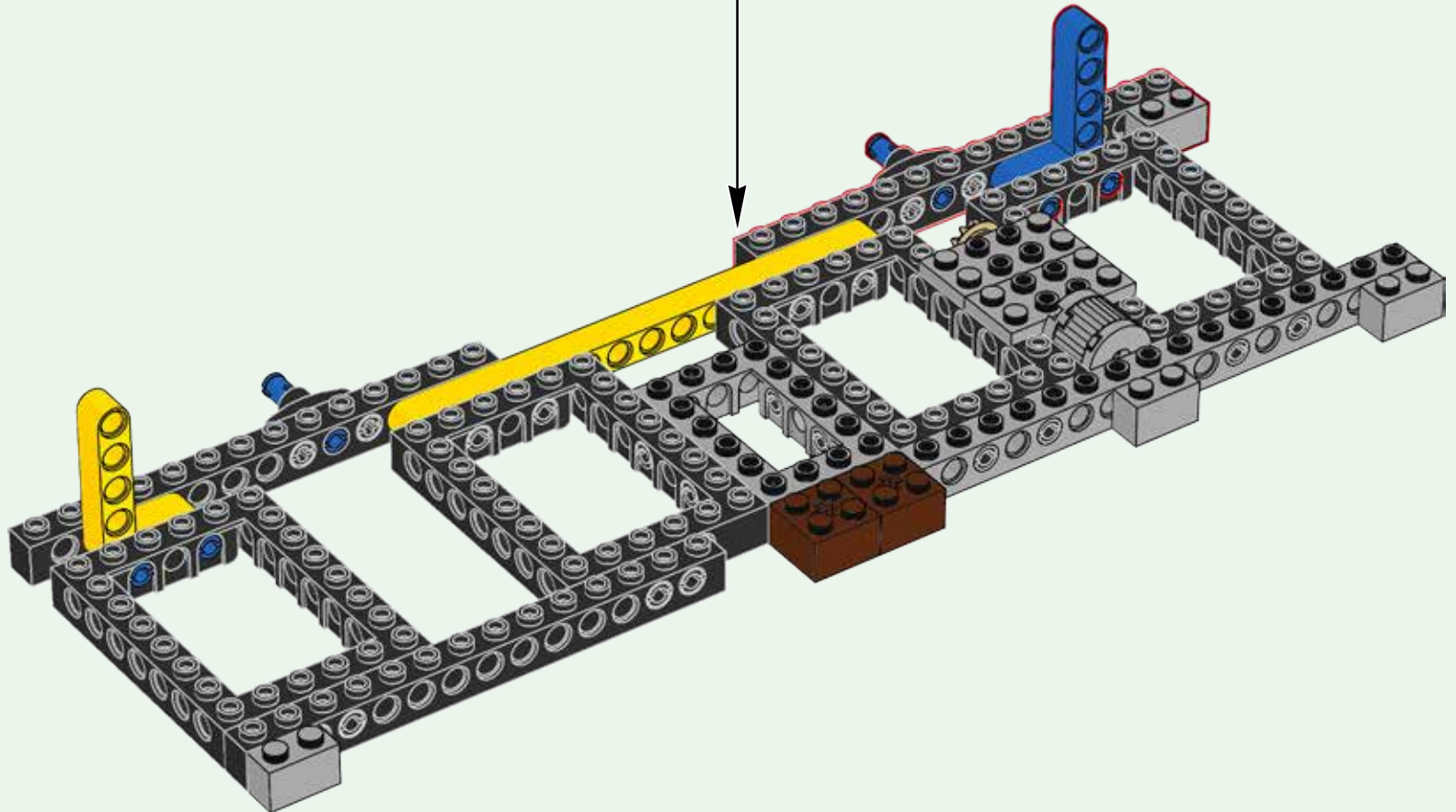



322

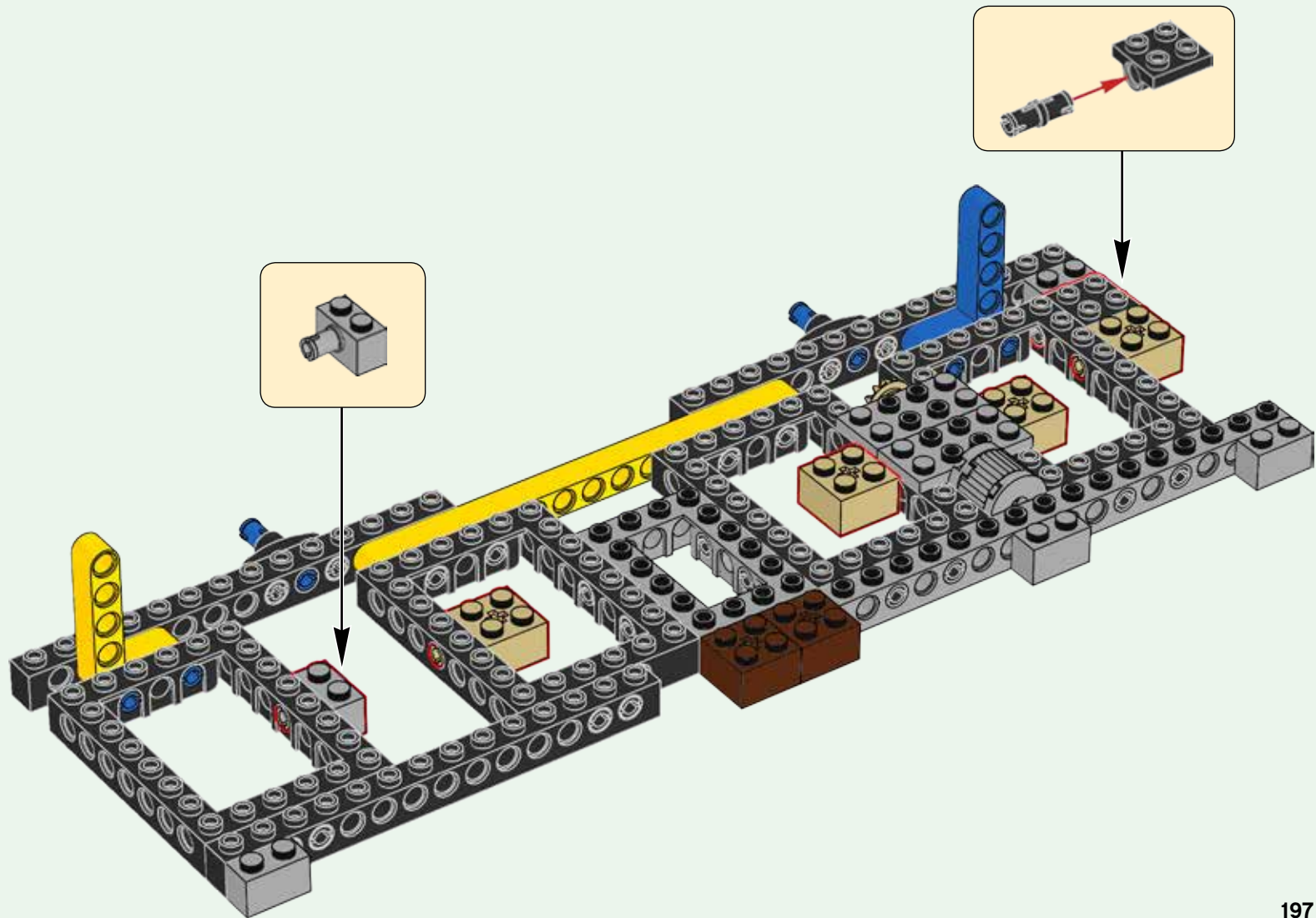



324

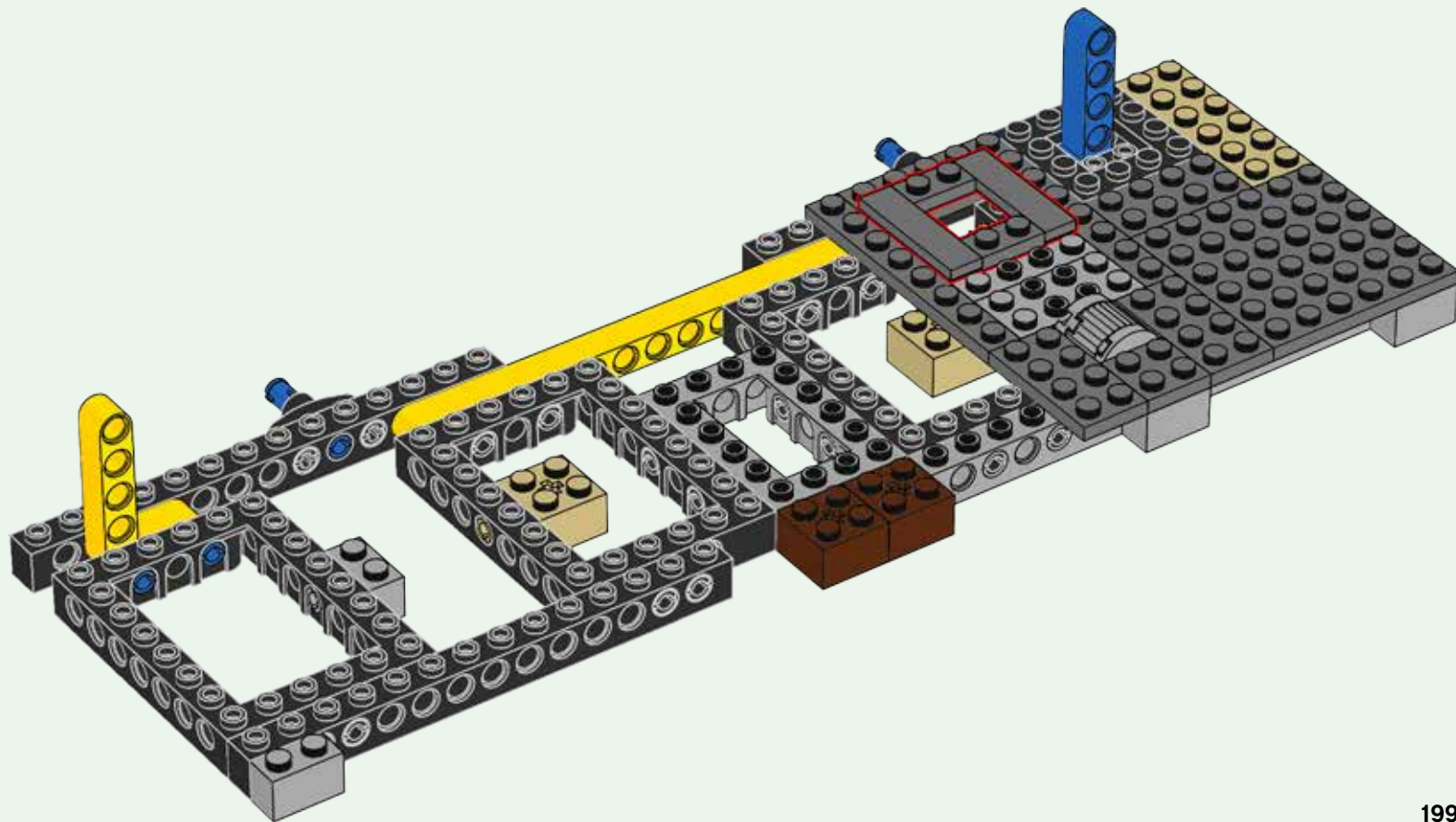

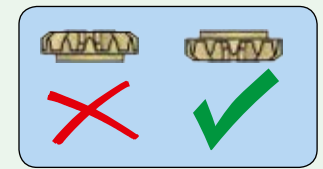
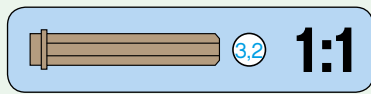
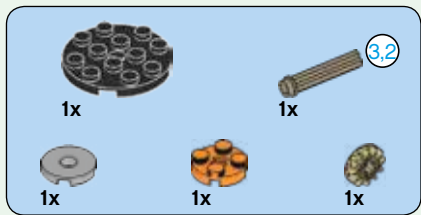

325

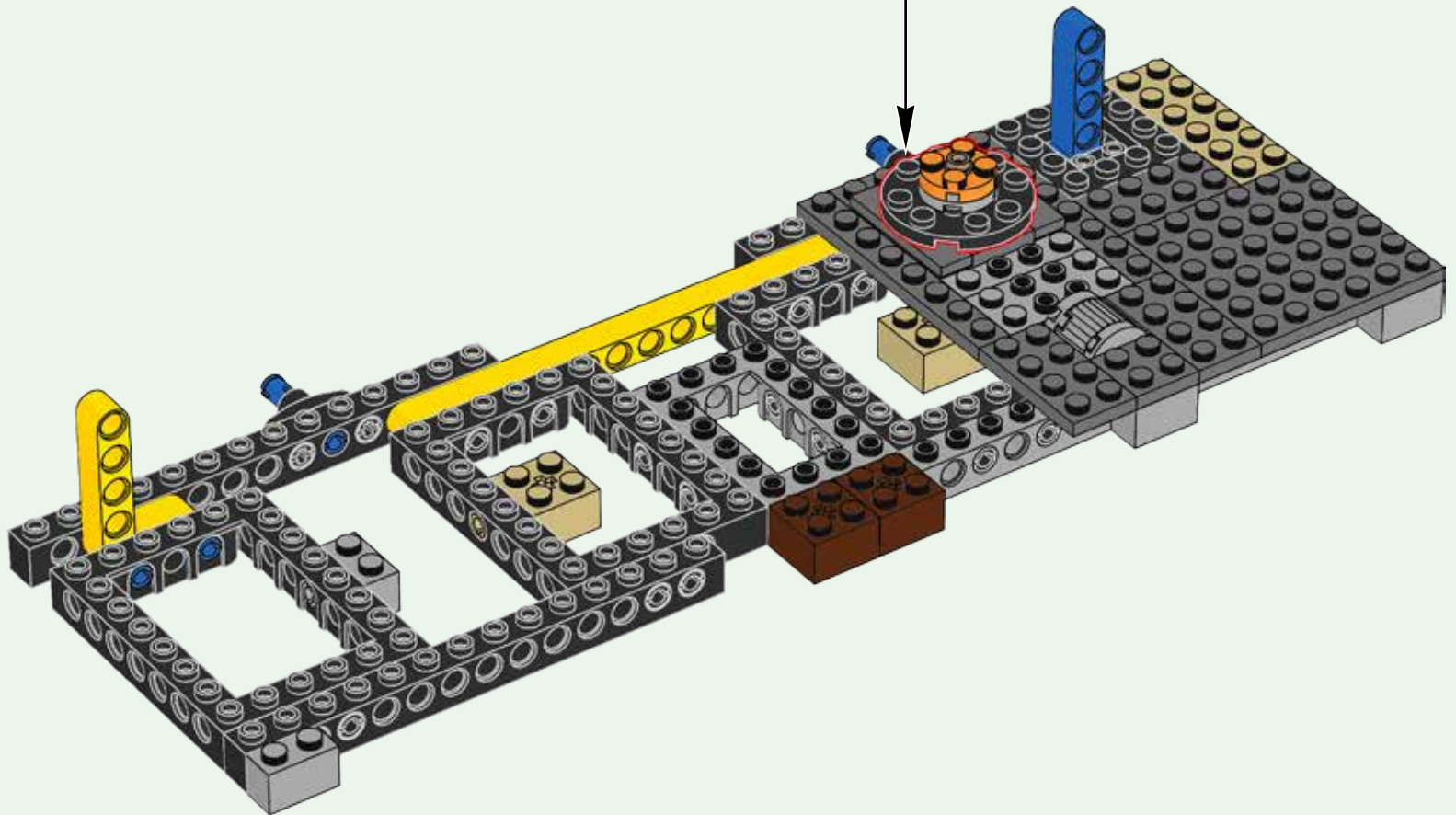
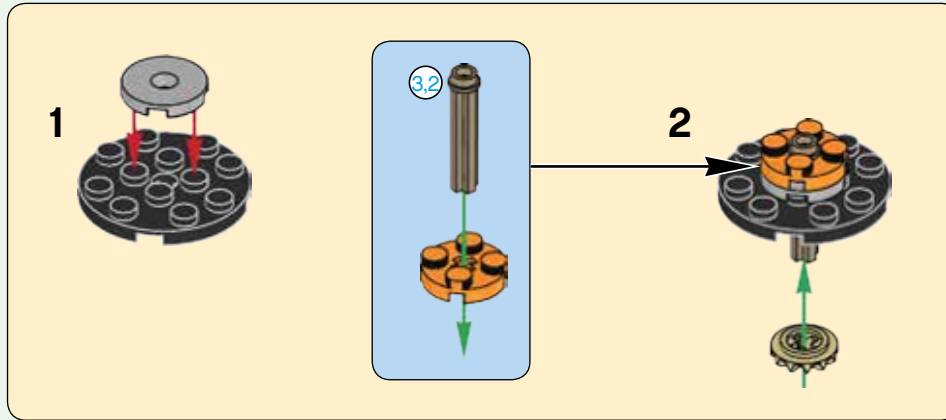



326

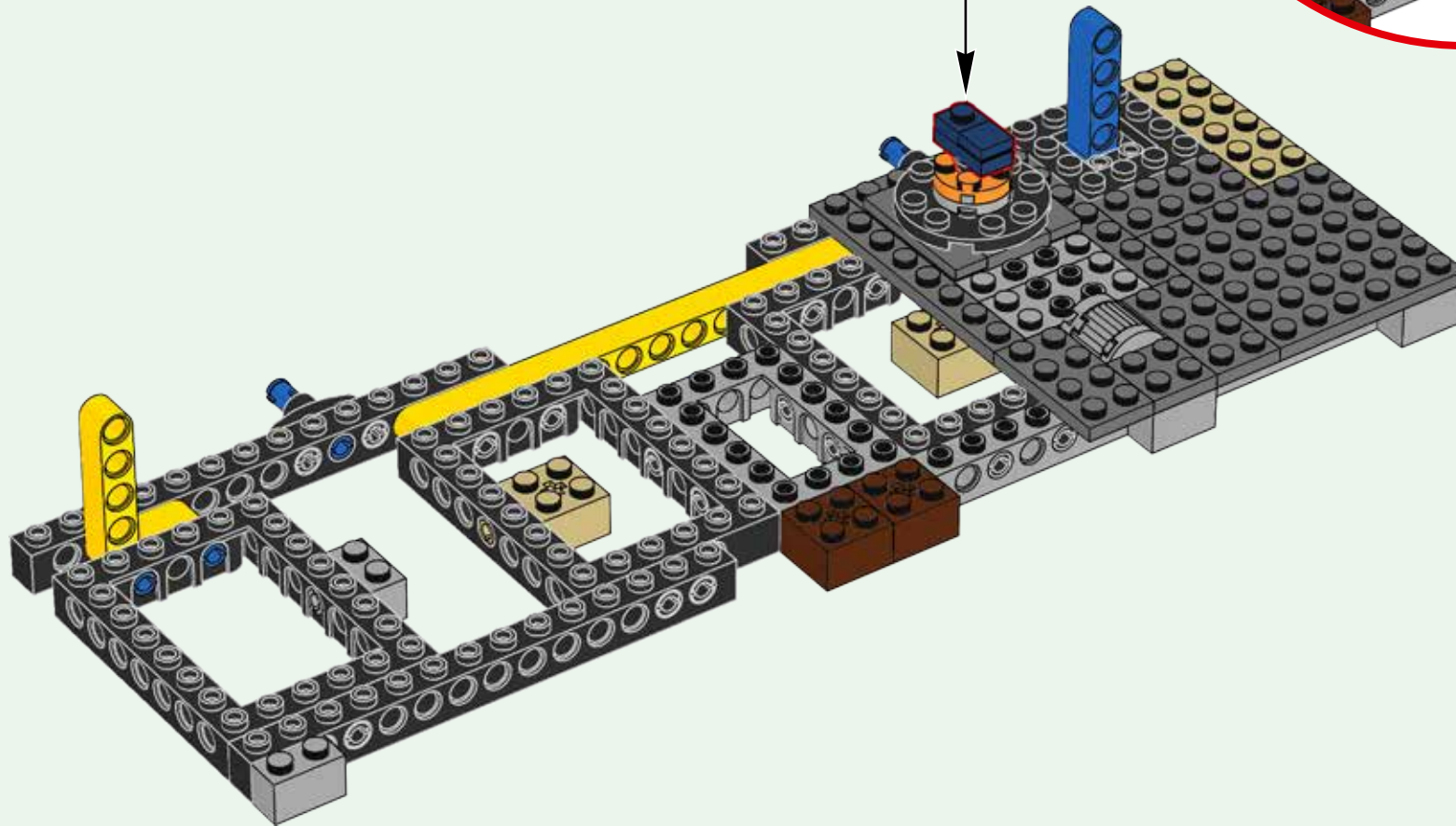
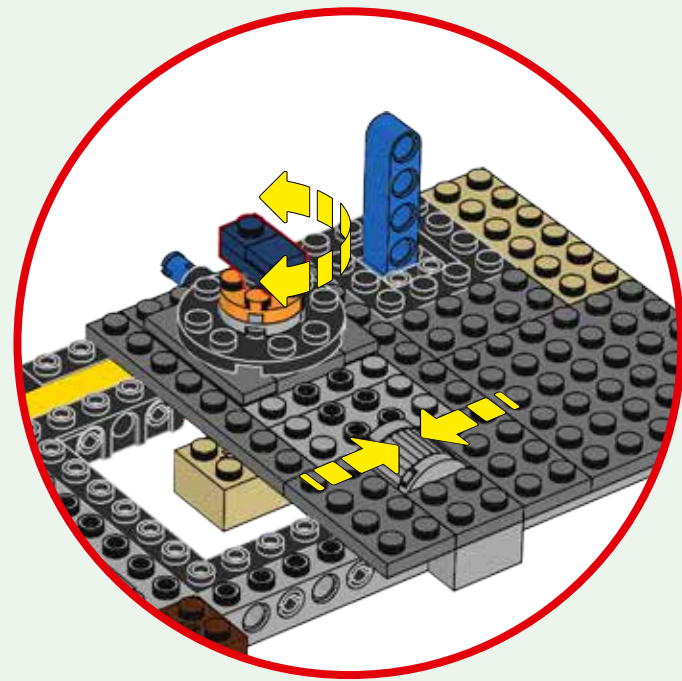
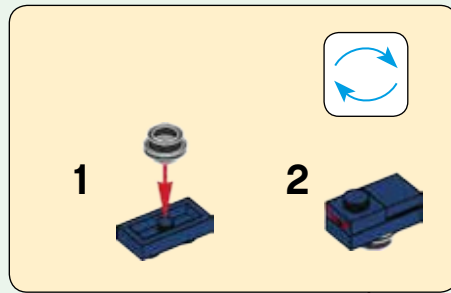

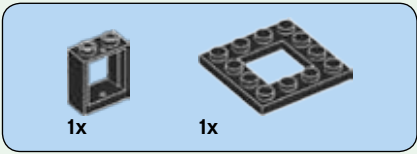

327

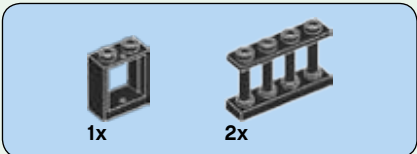

328

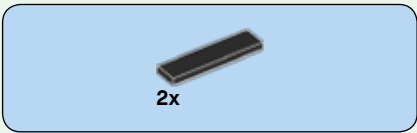

329

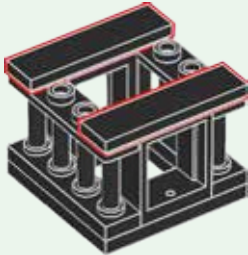

330

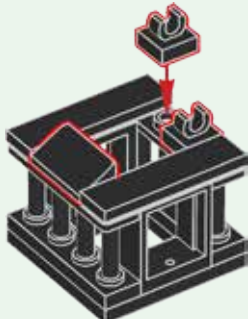

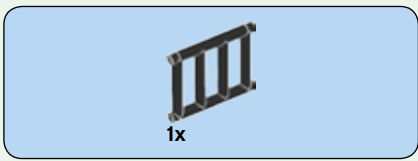

331



332

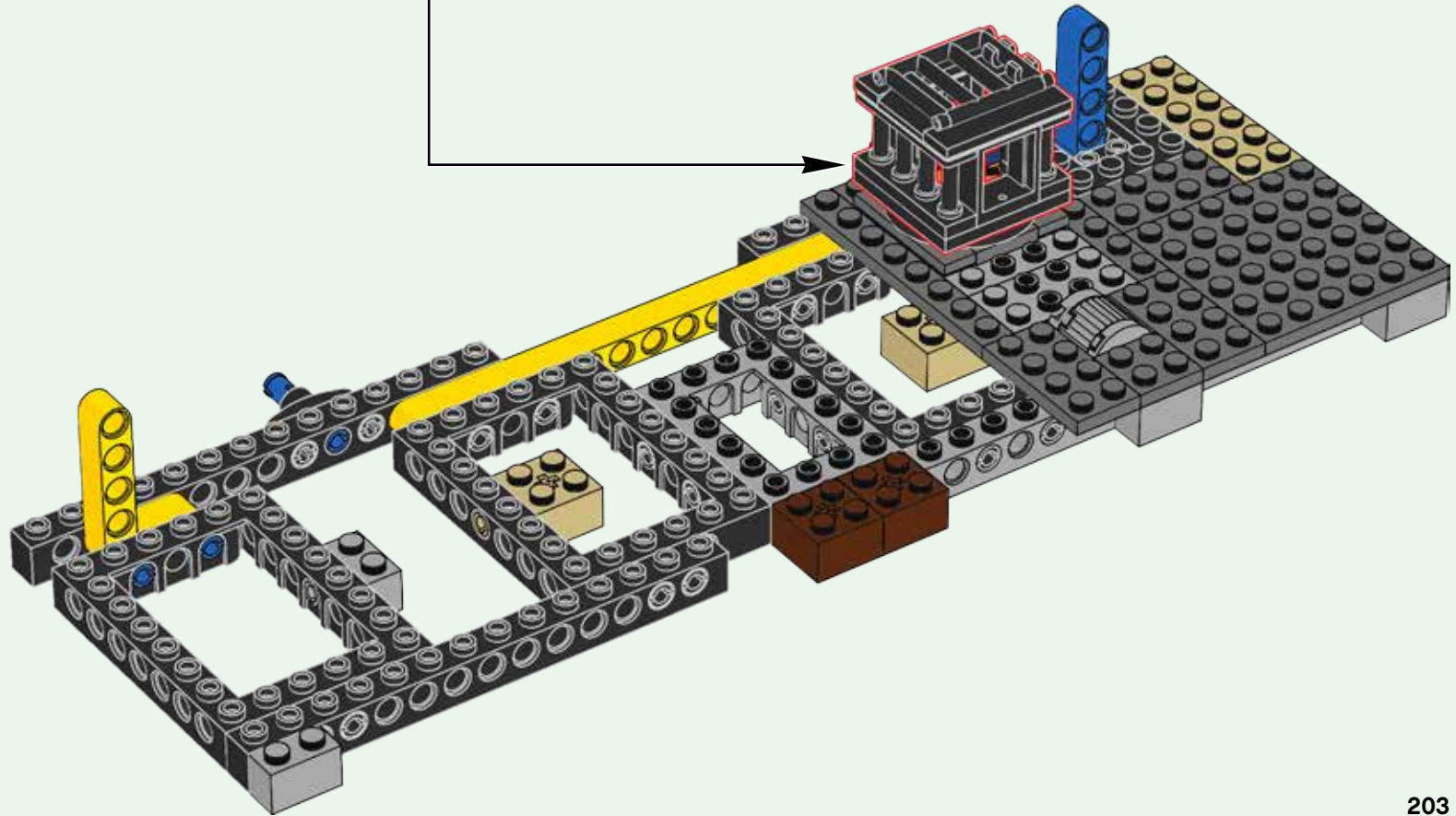

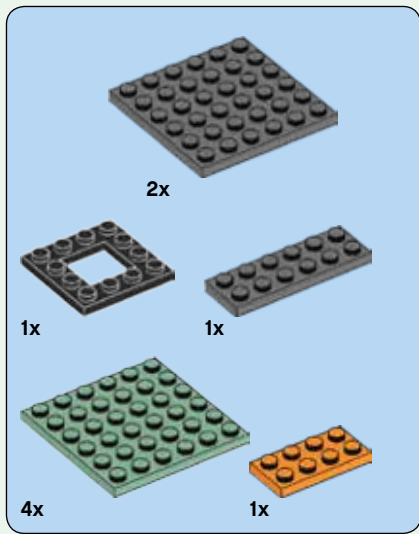

333

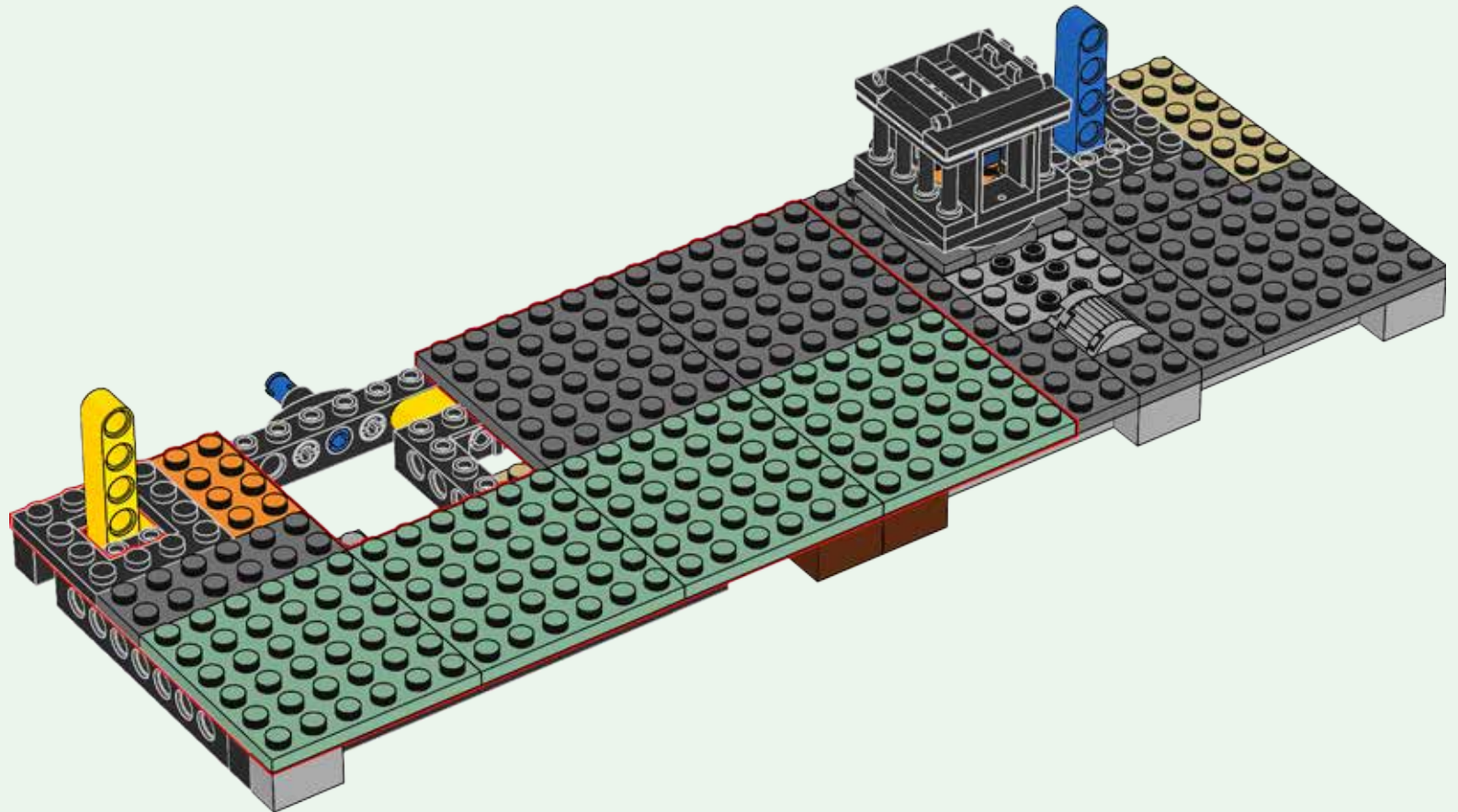



334

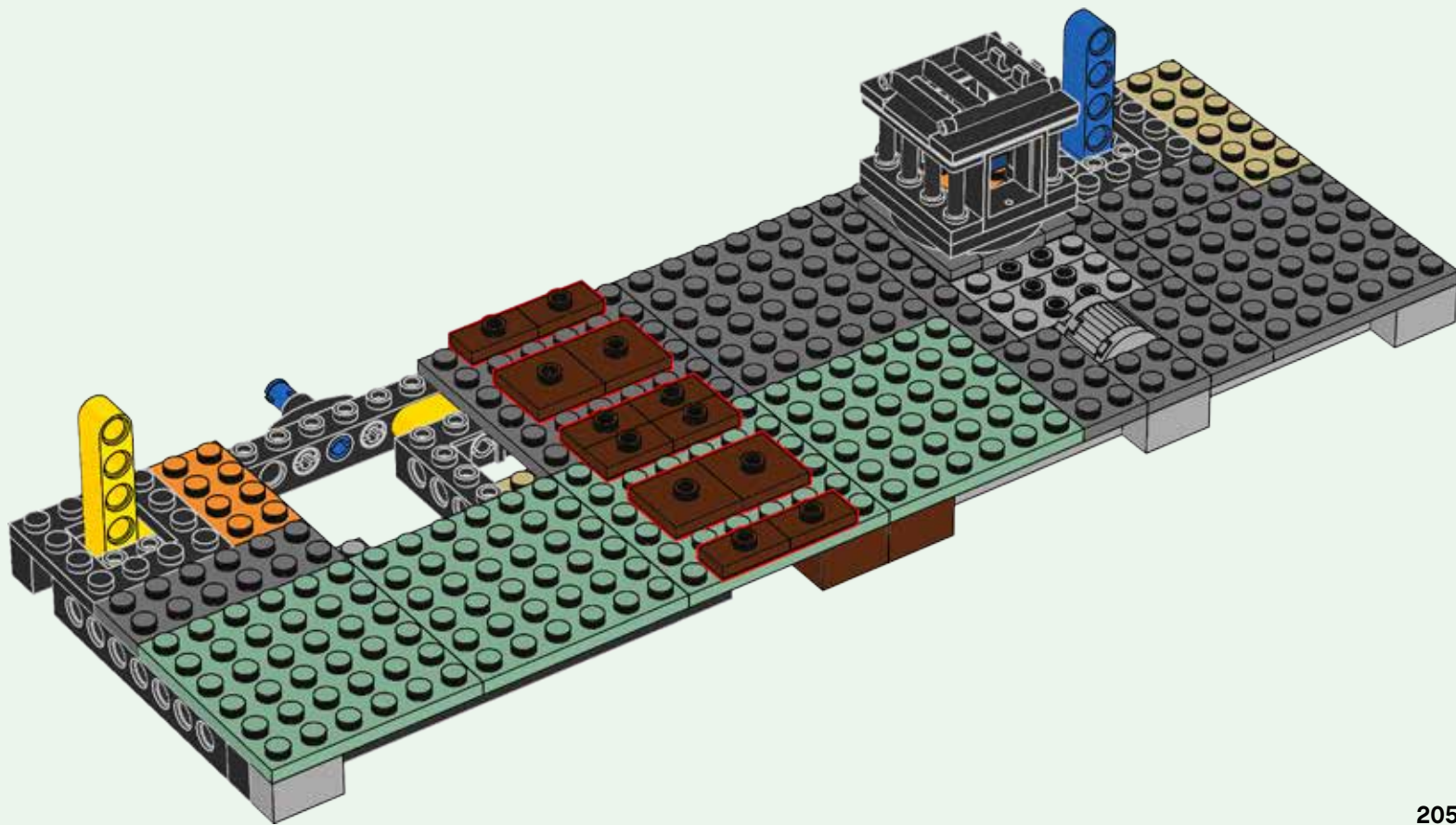

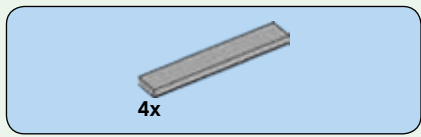

335

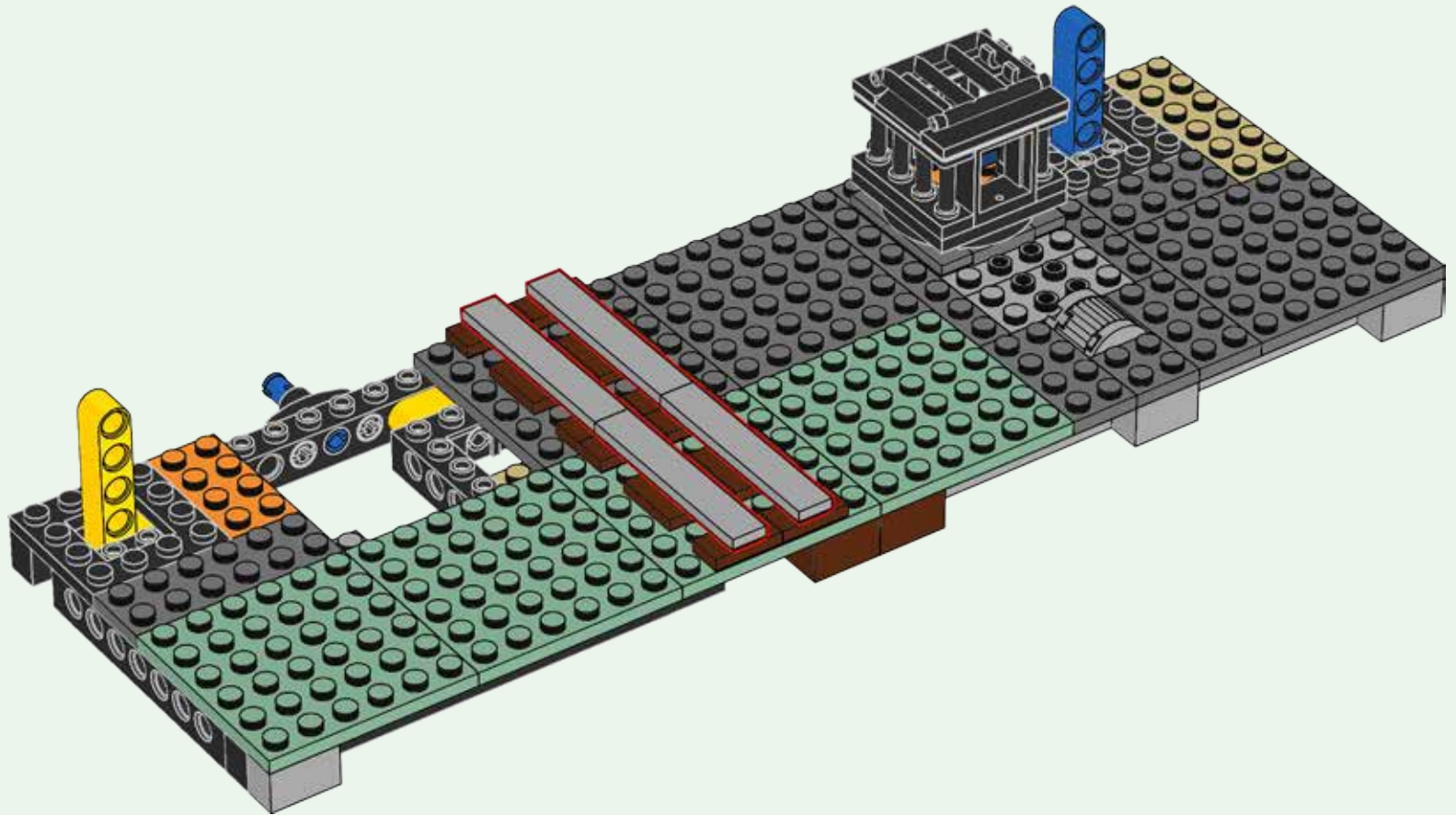

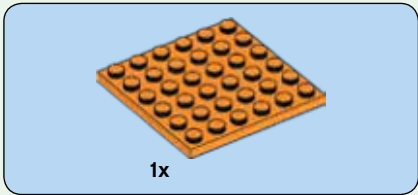

336

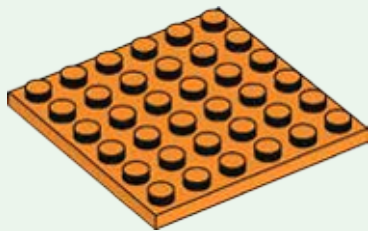

337



338

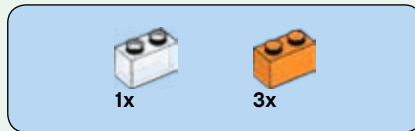
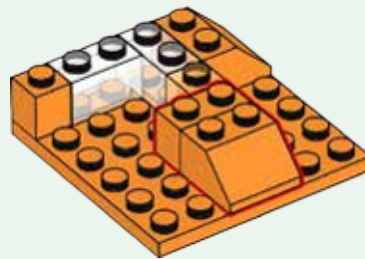

339

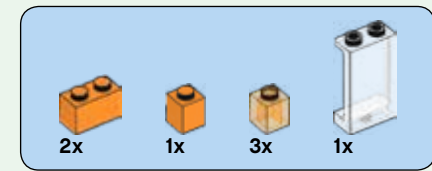
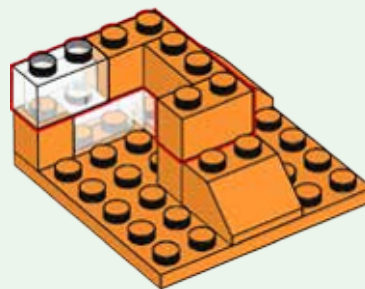

340

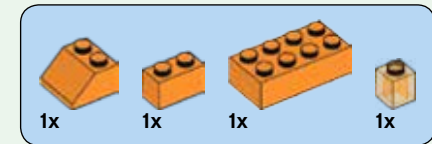
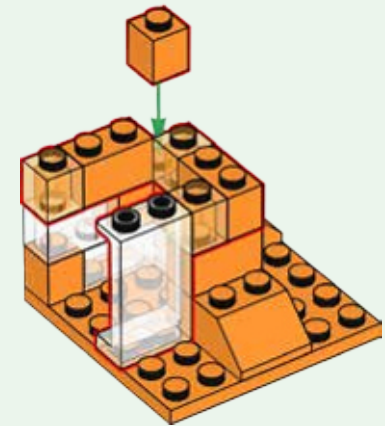

341

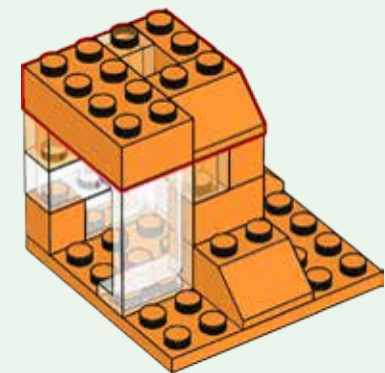

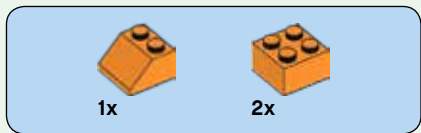

342

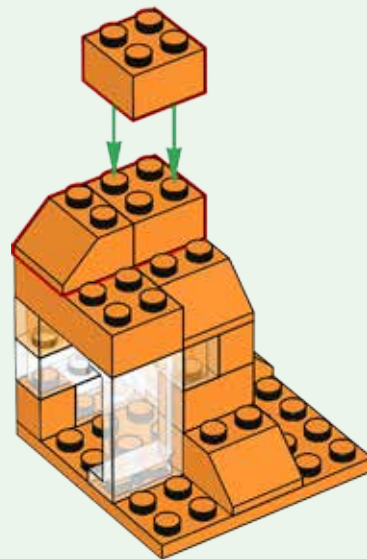

343

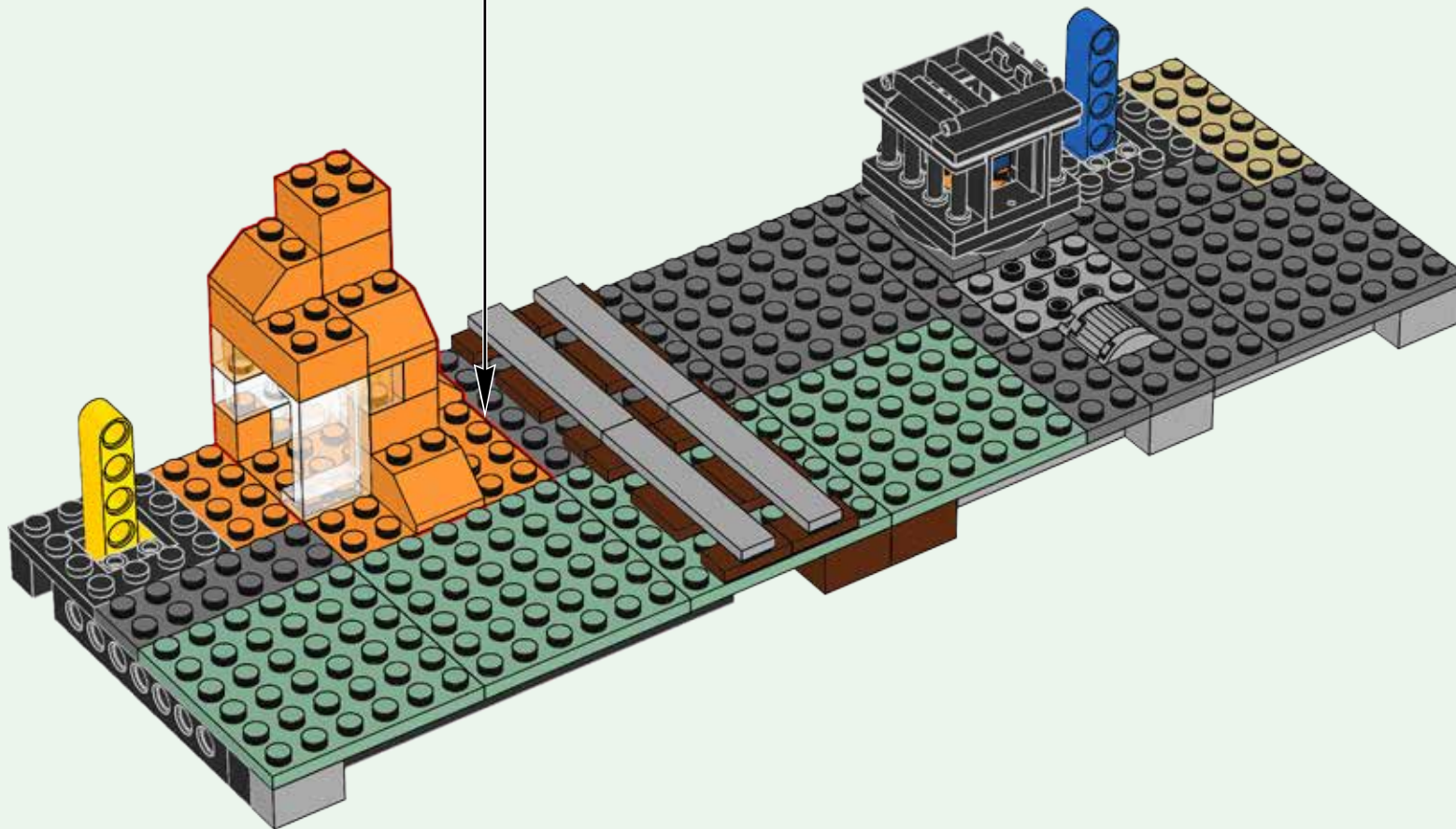

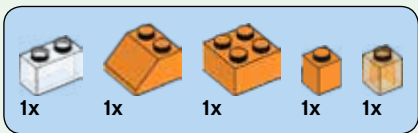

344

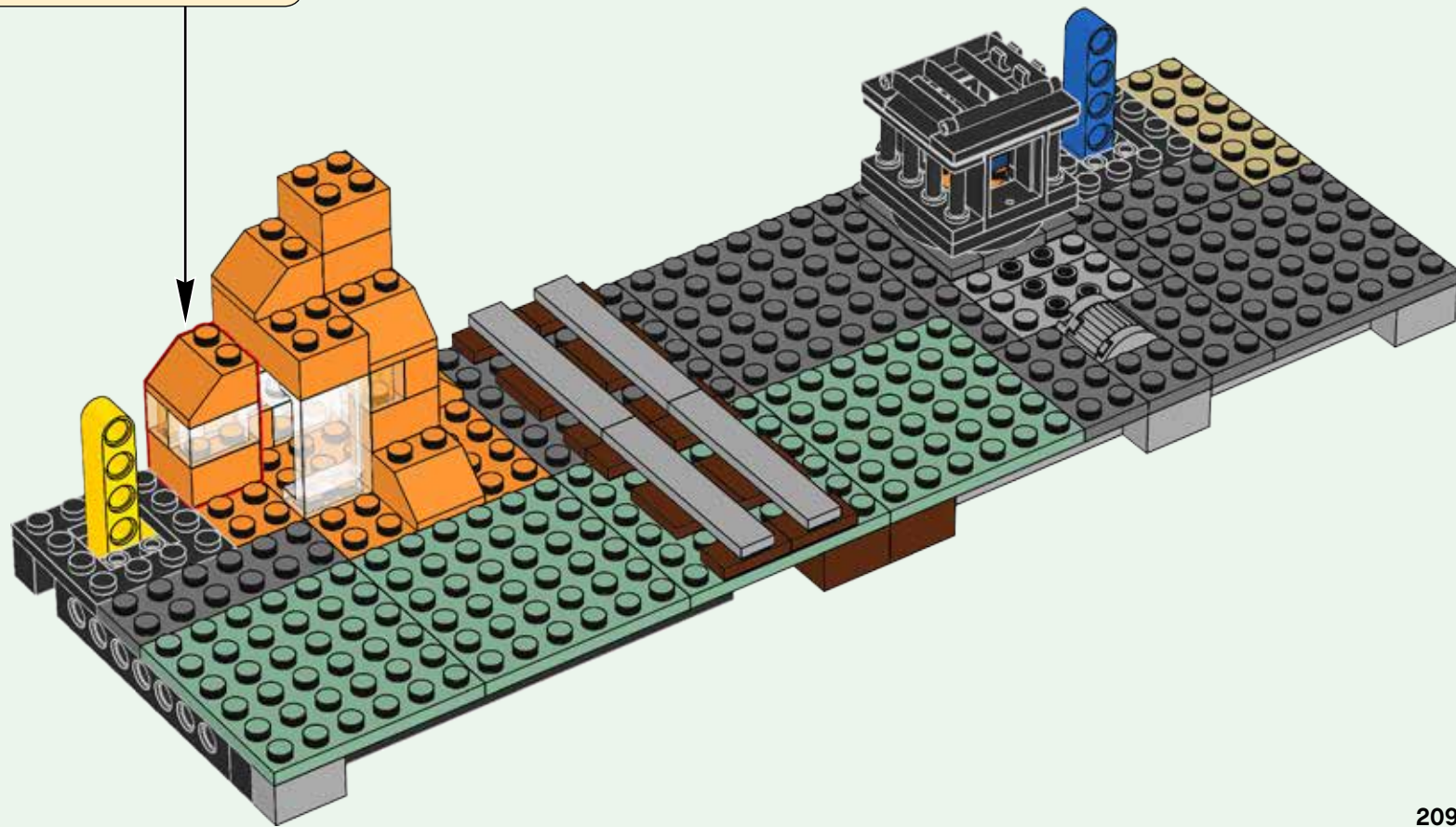

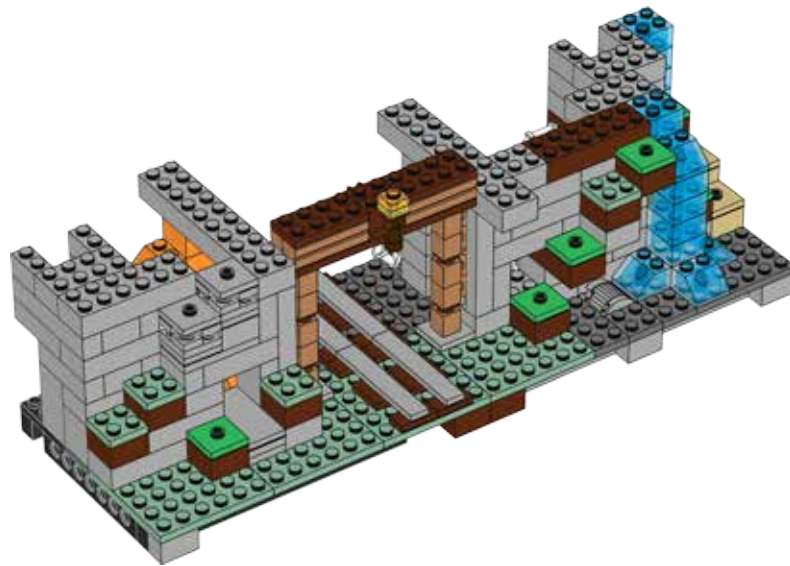

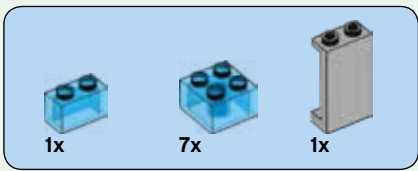

345

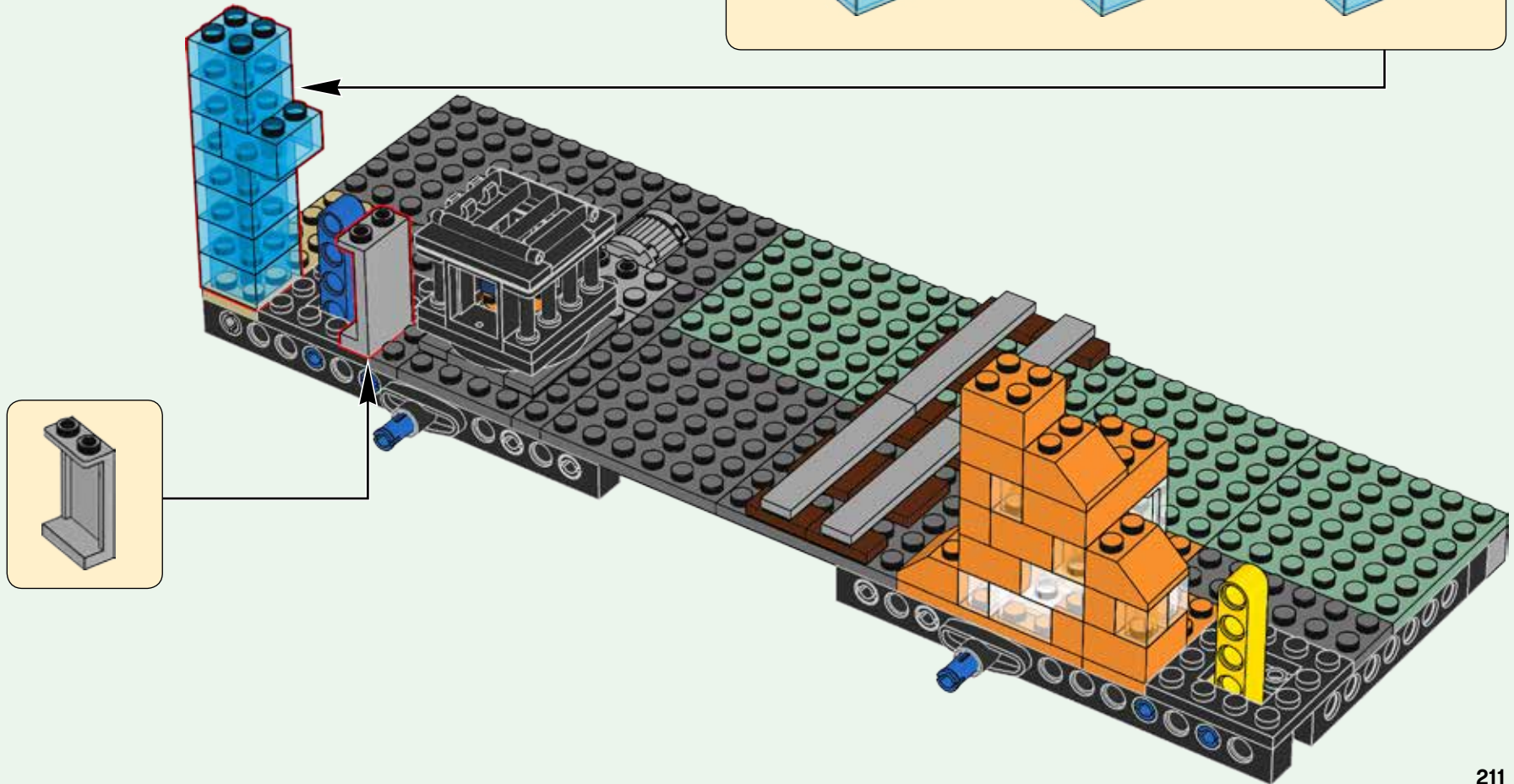
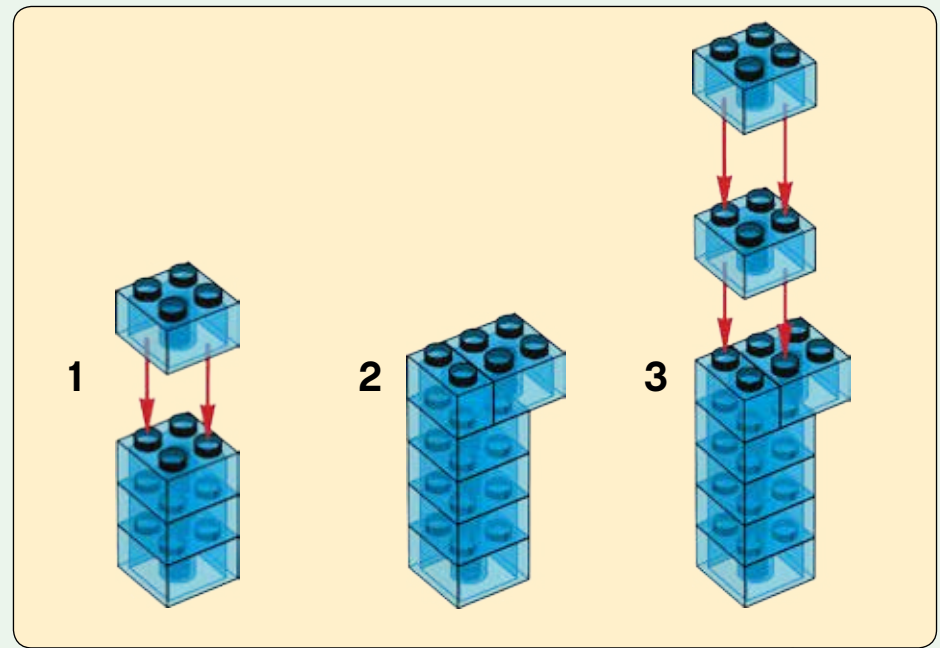
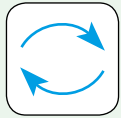

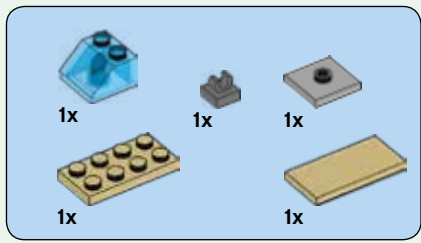

346

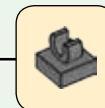
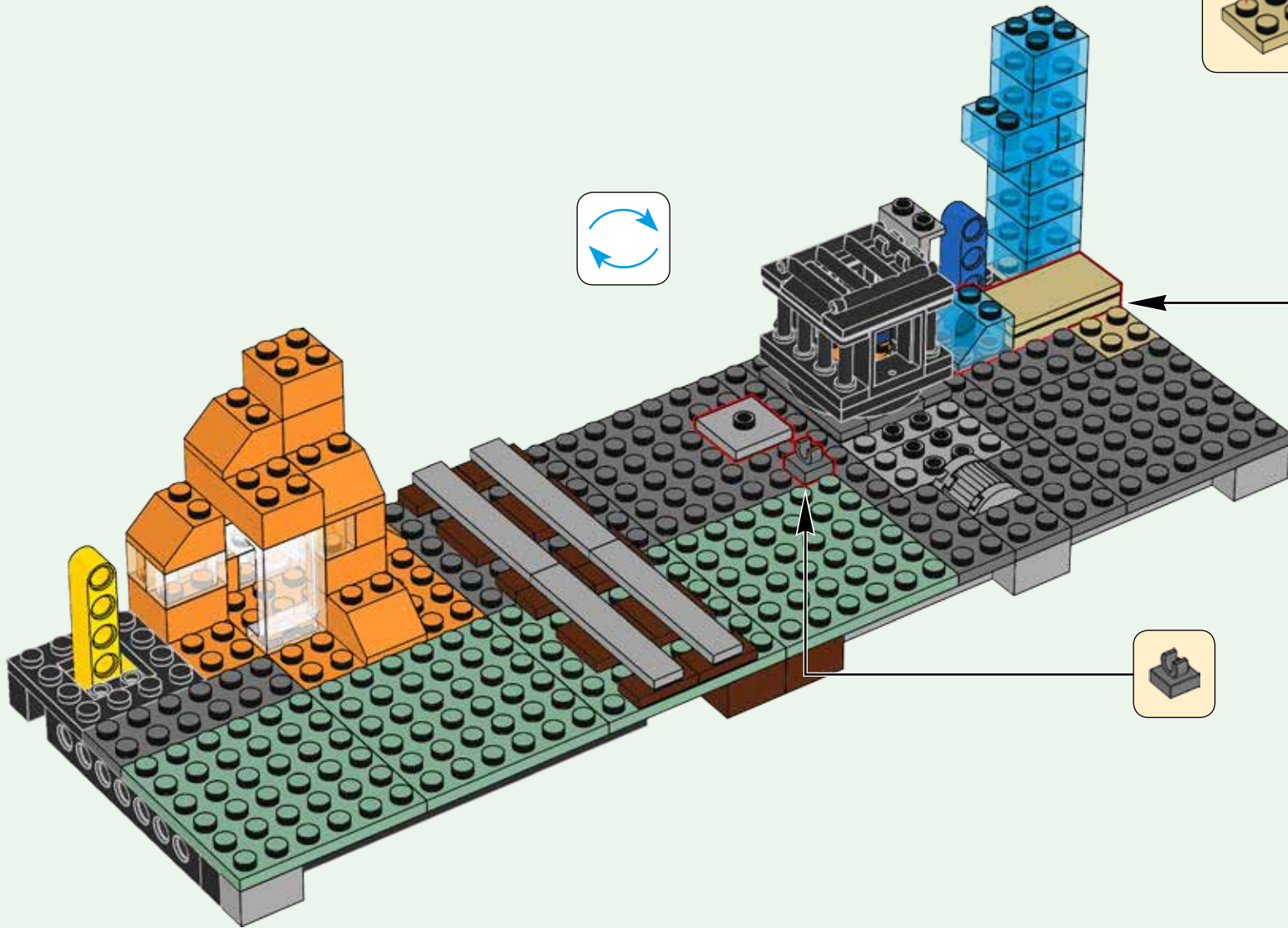
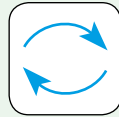
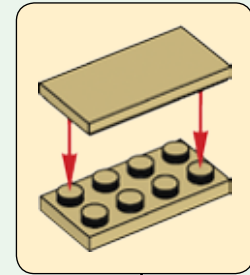

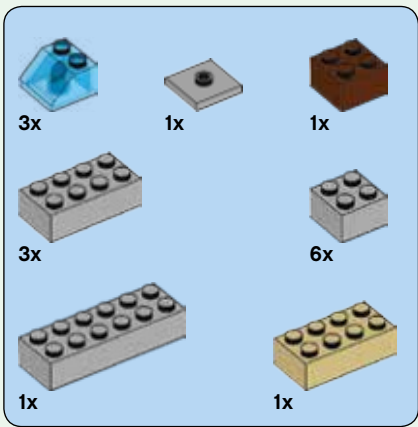

347

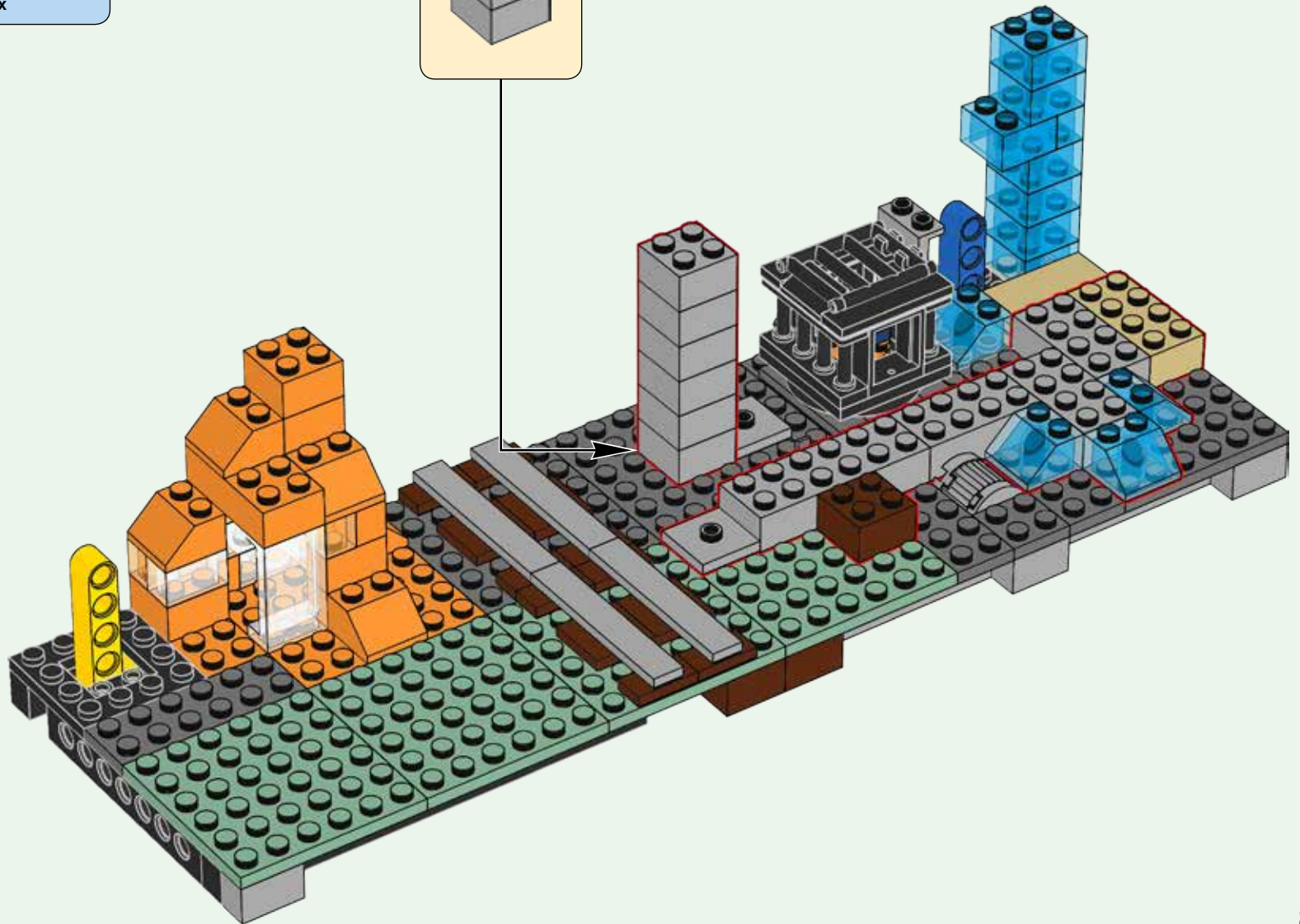
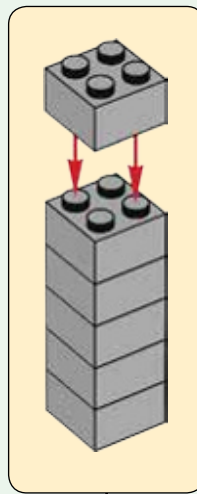

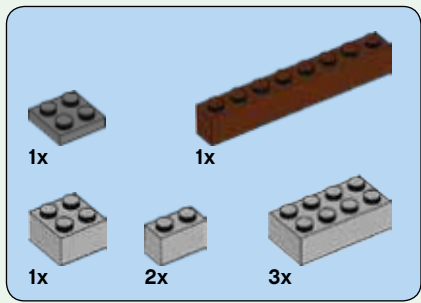

350

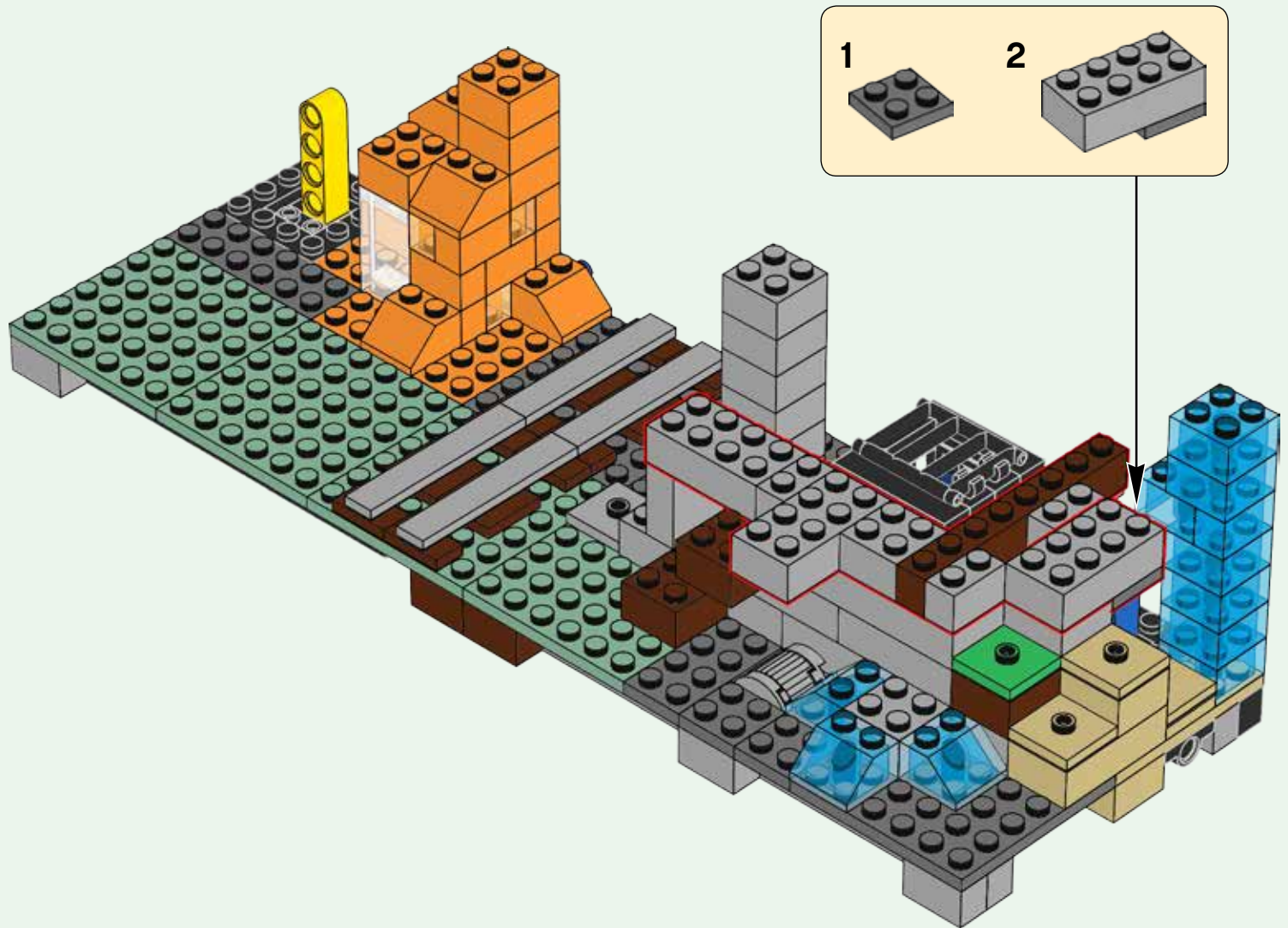

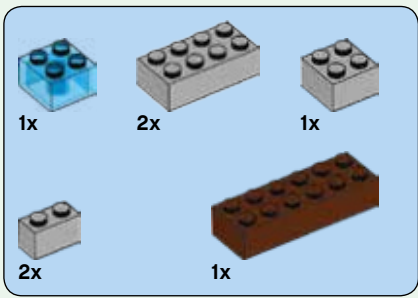

353

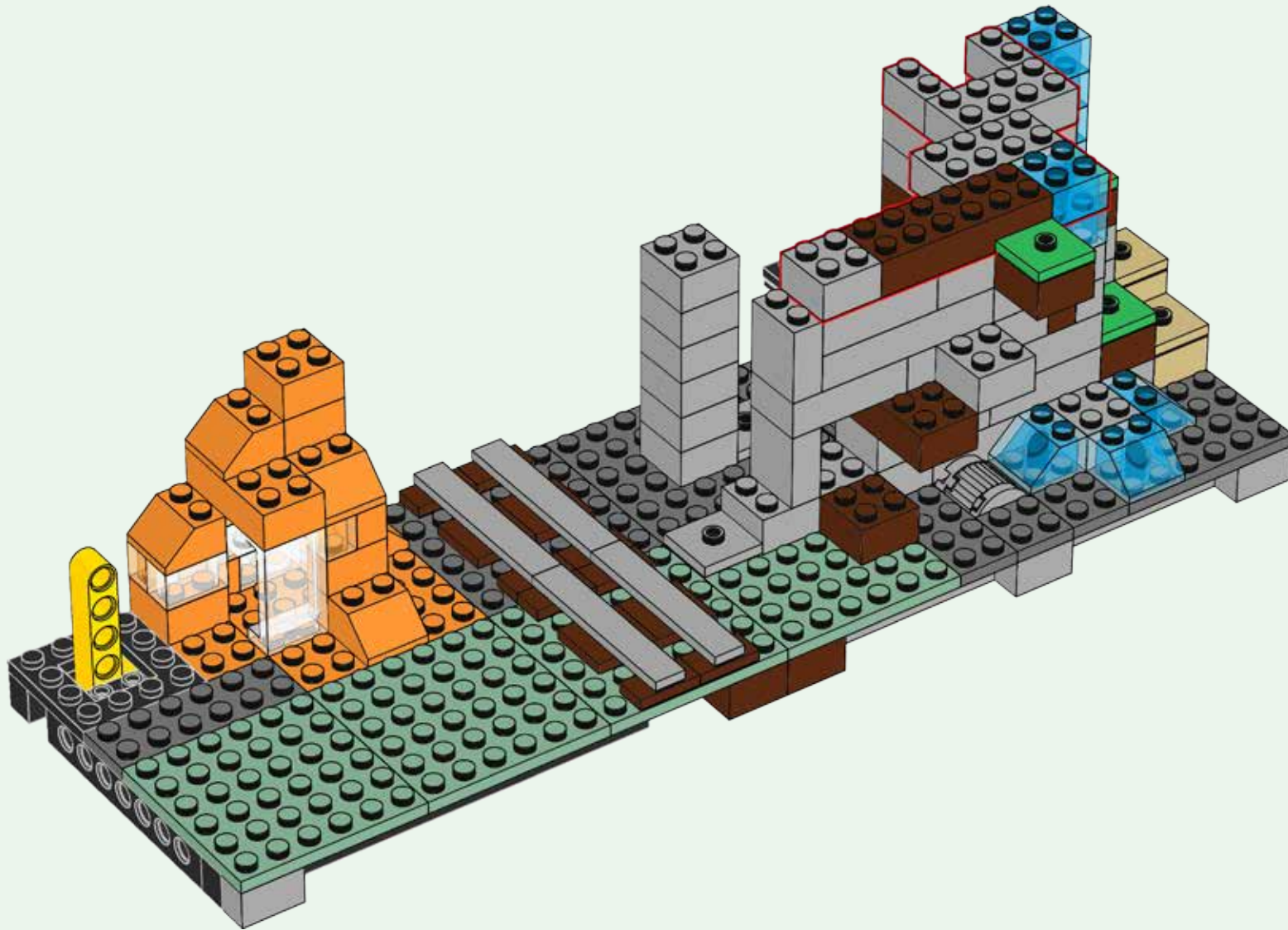



3x

354

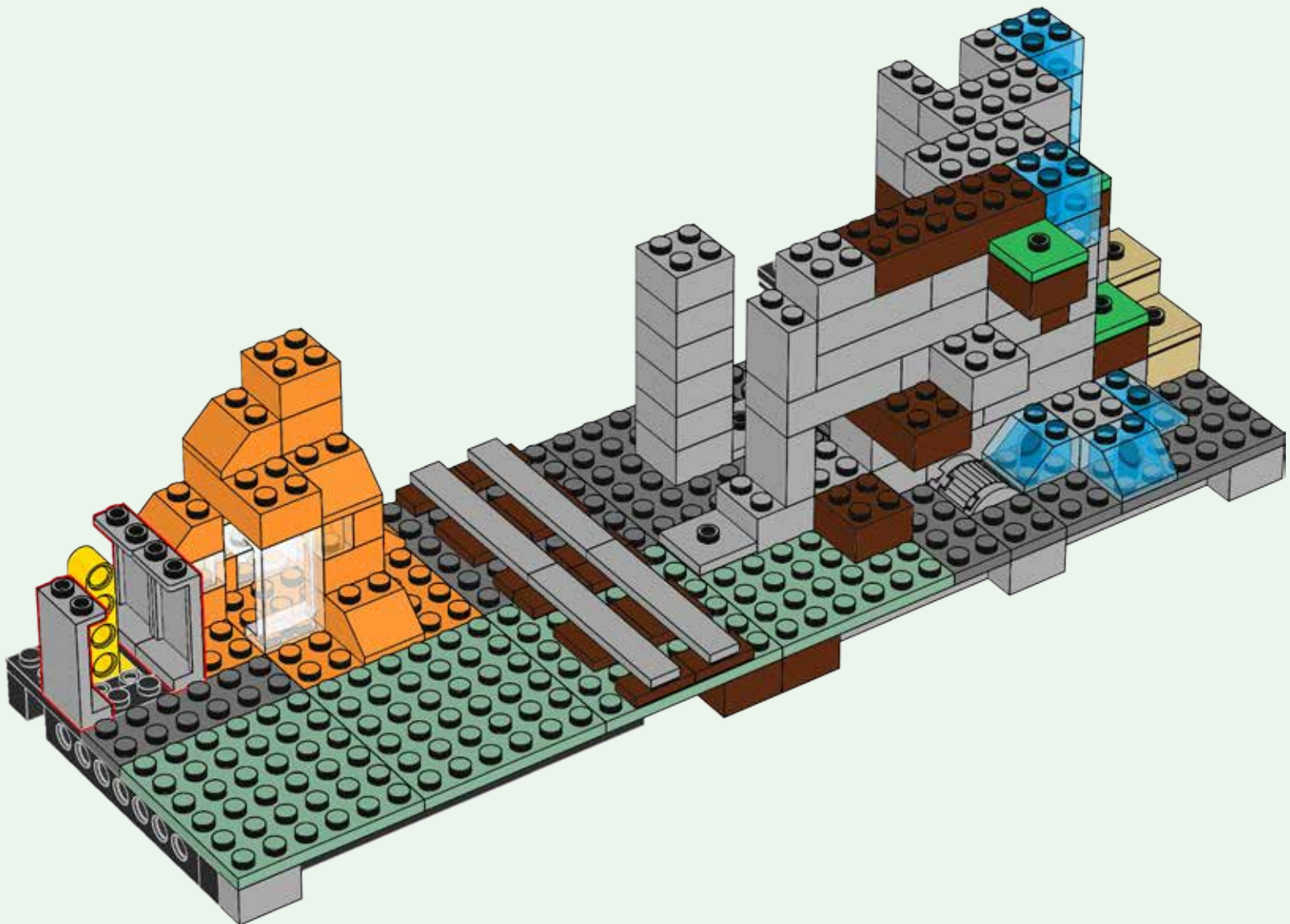

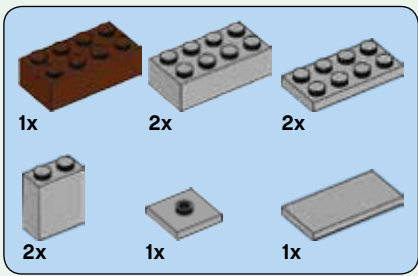

355

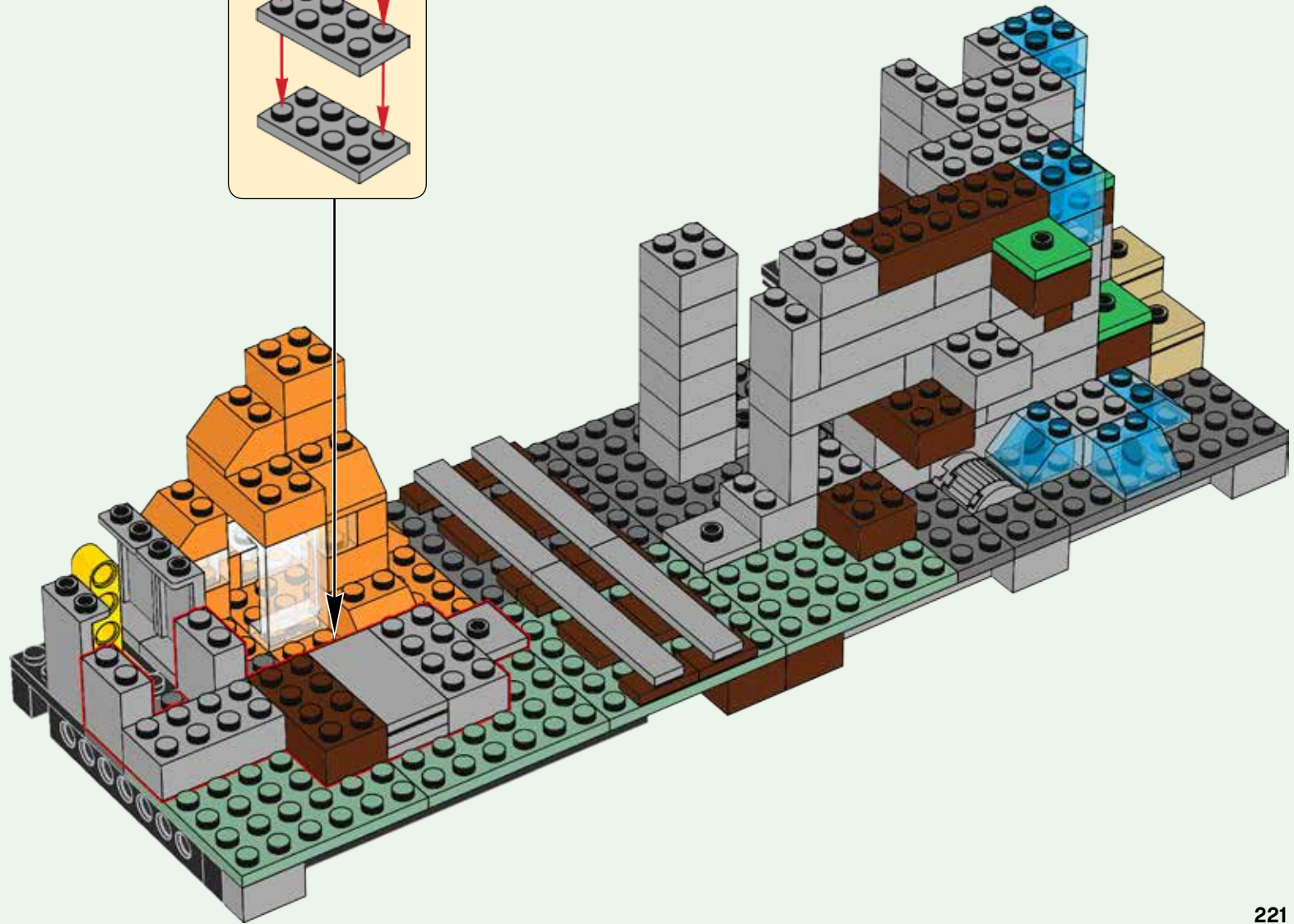
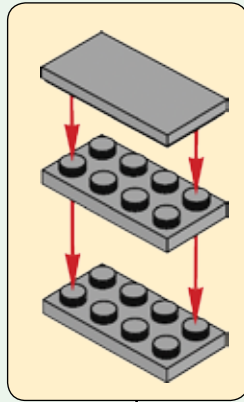

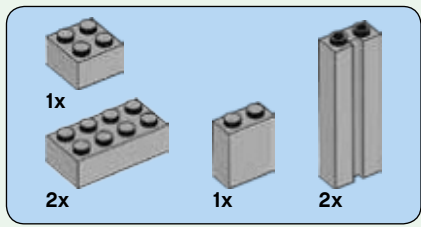

356

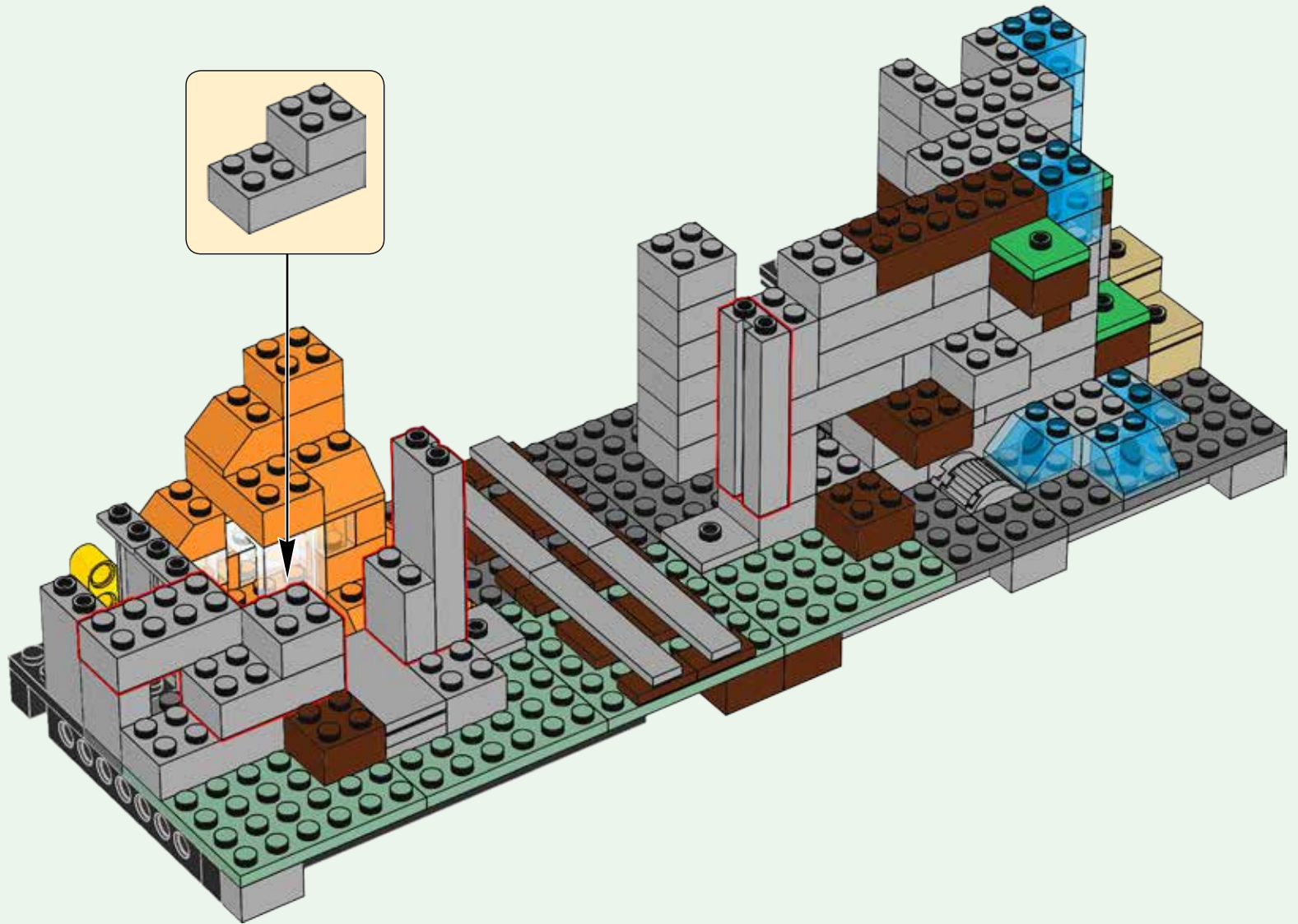

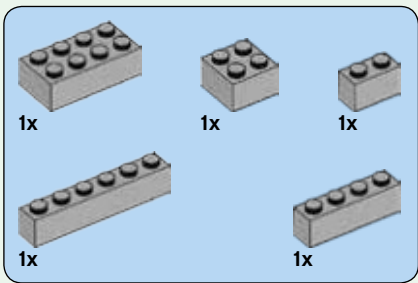

357

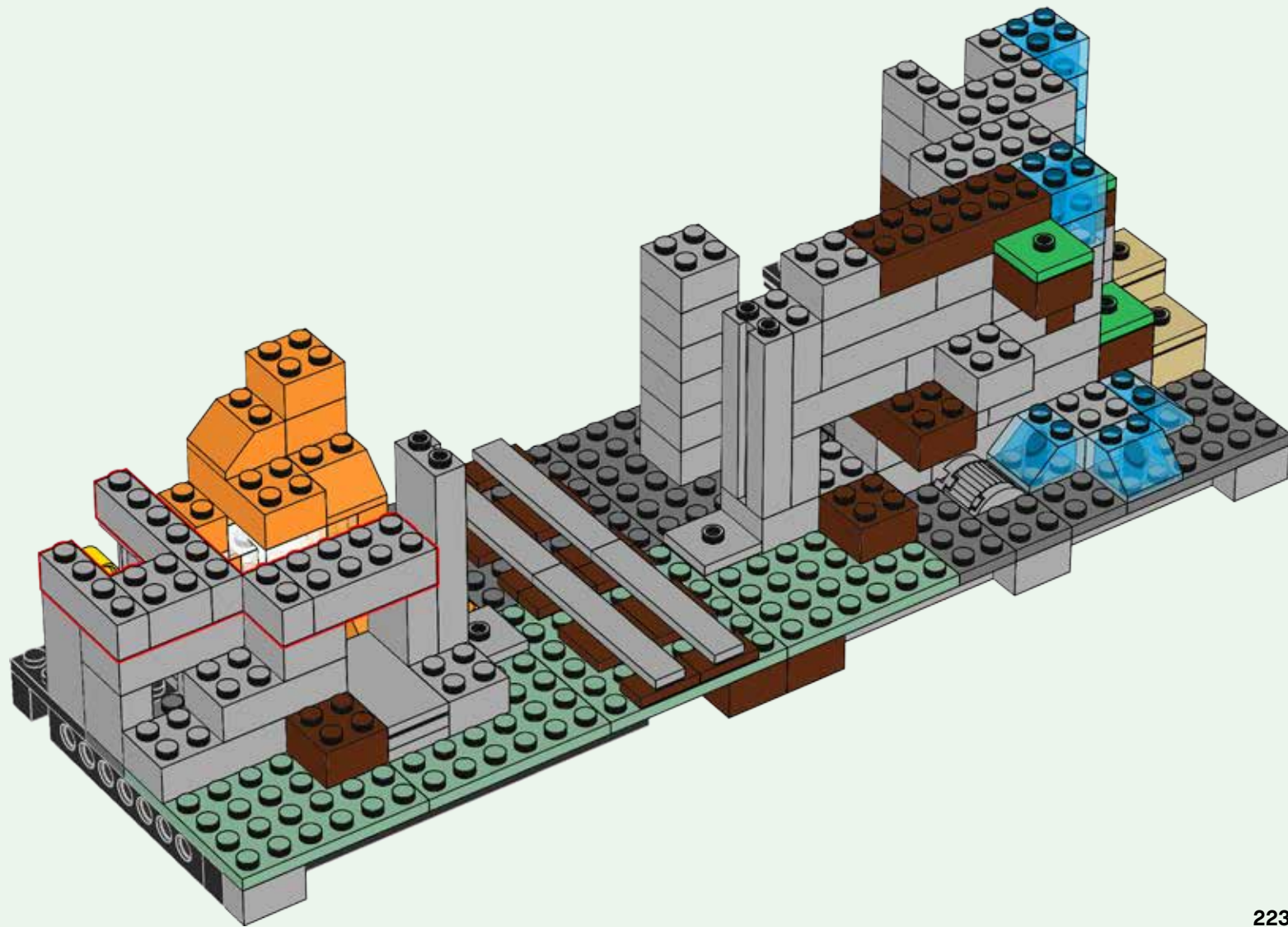

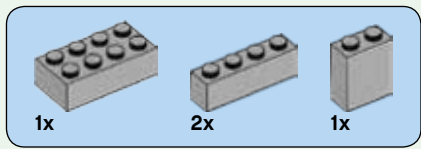

358

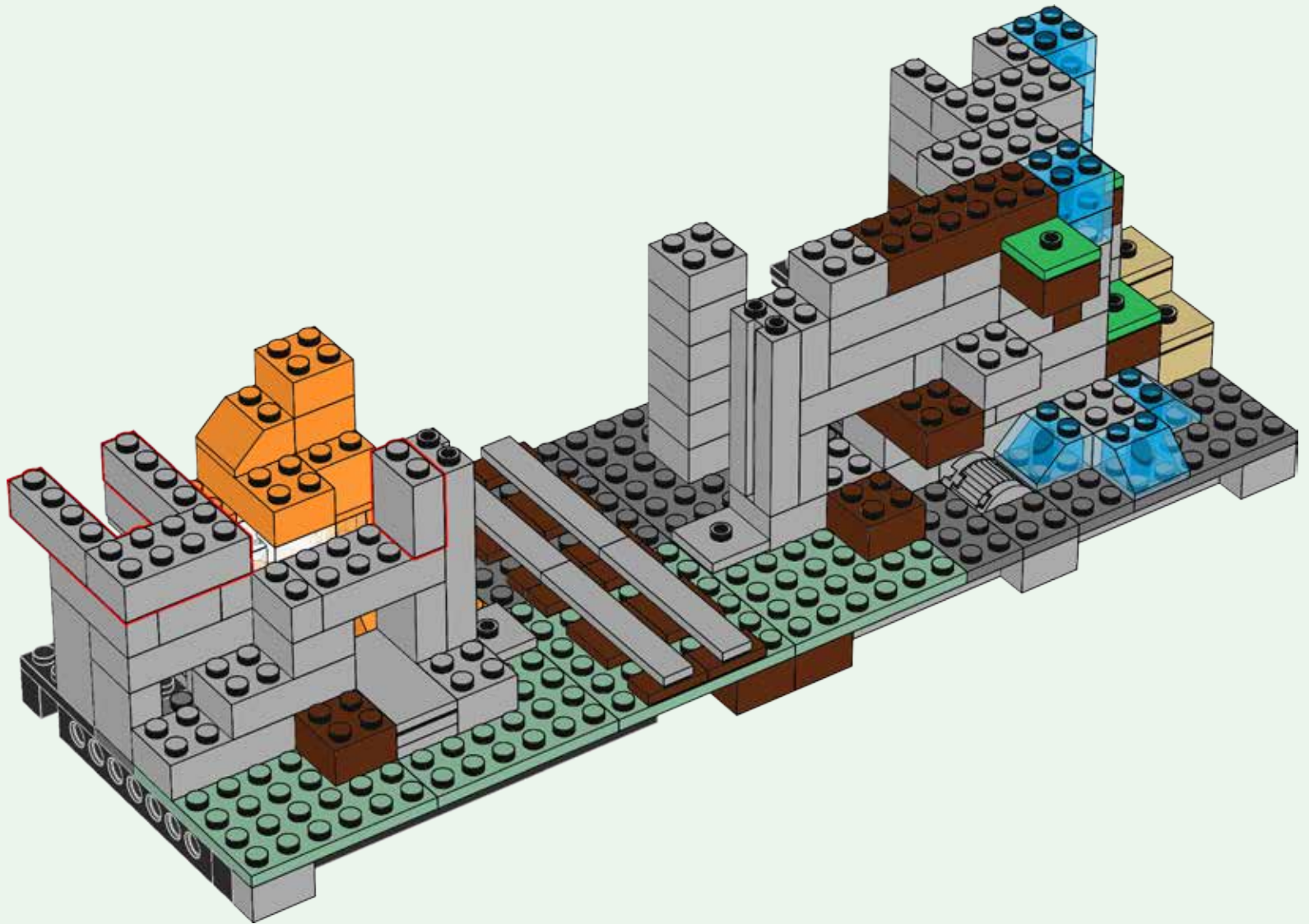

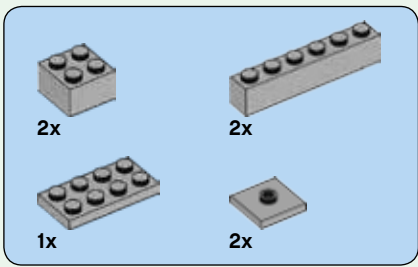

359

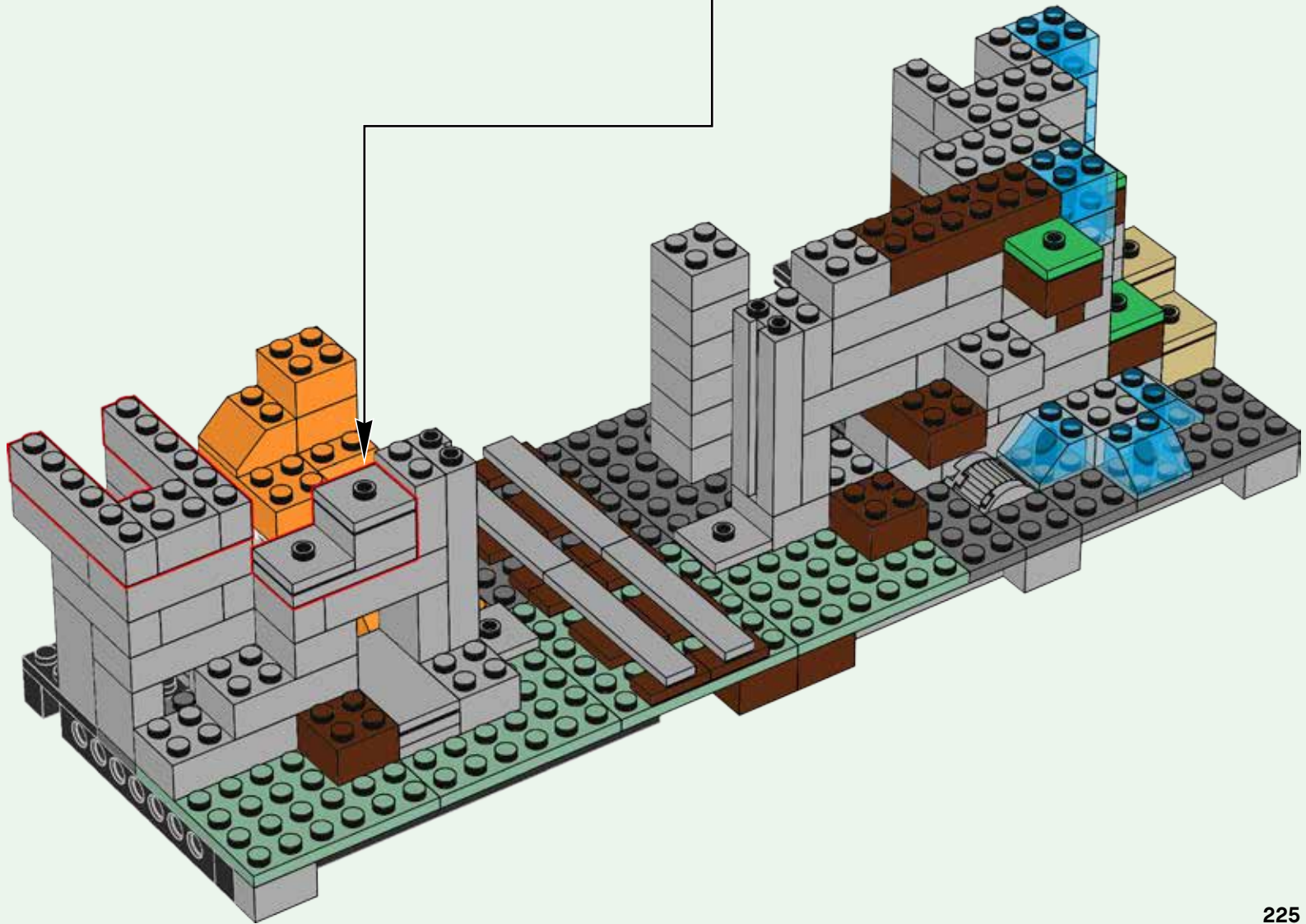
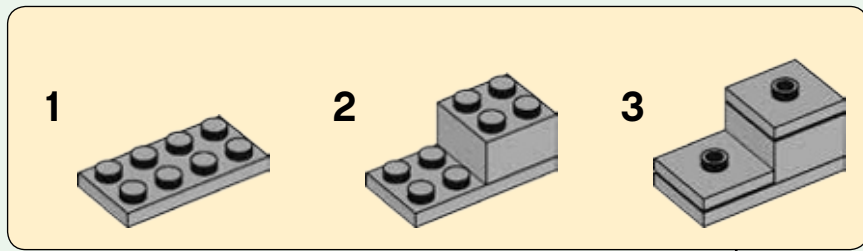

2x 6x 8x

360

1 2 3 4 2x

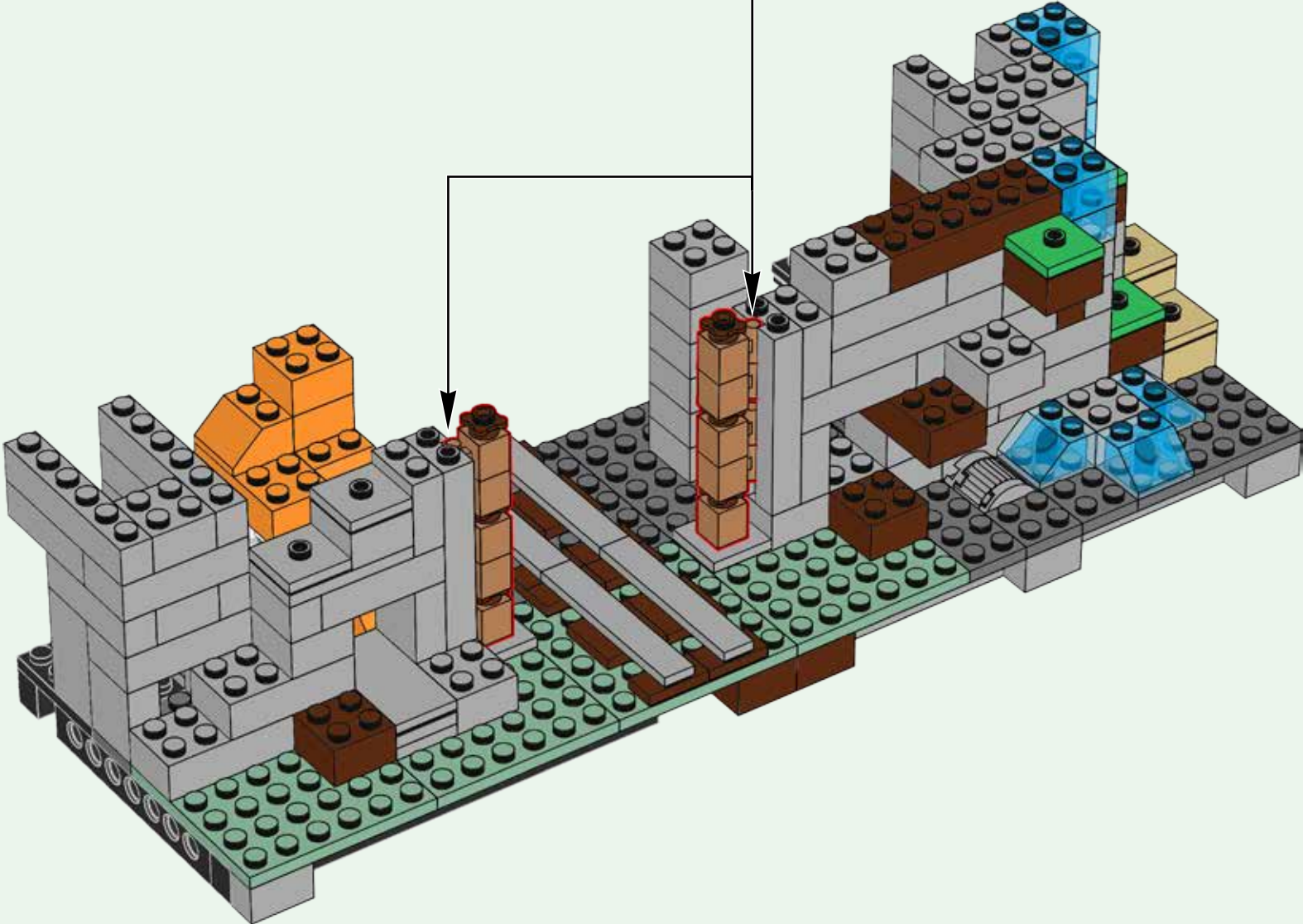

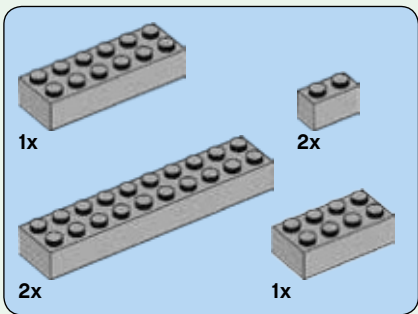

361



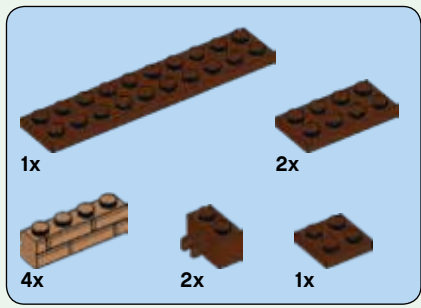

362

1

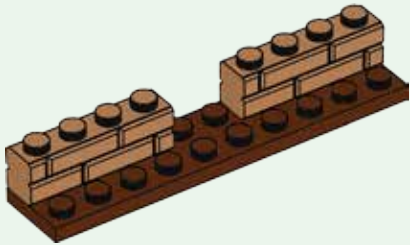

2

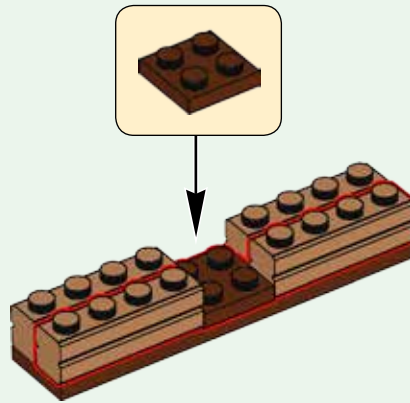

3

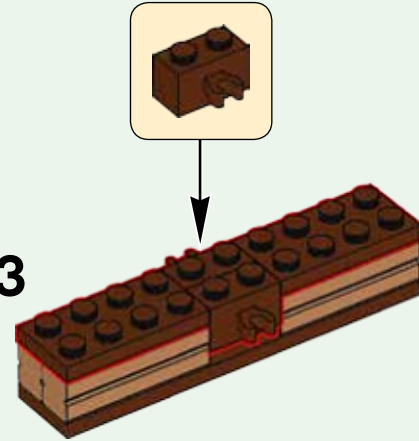

4

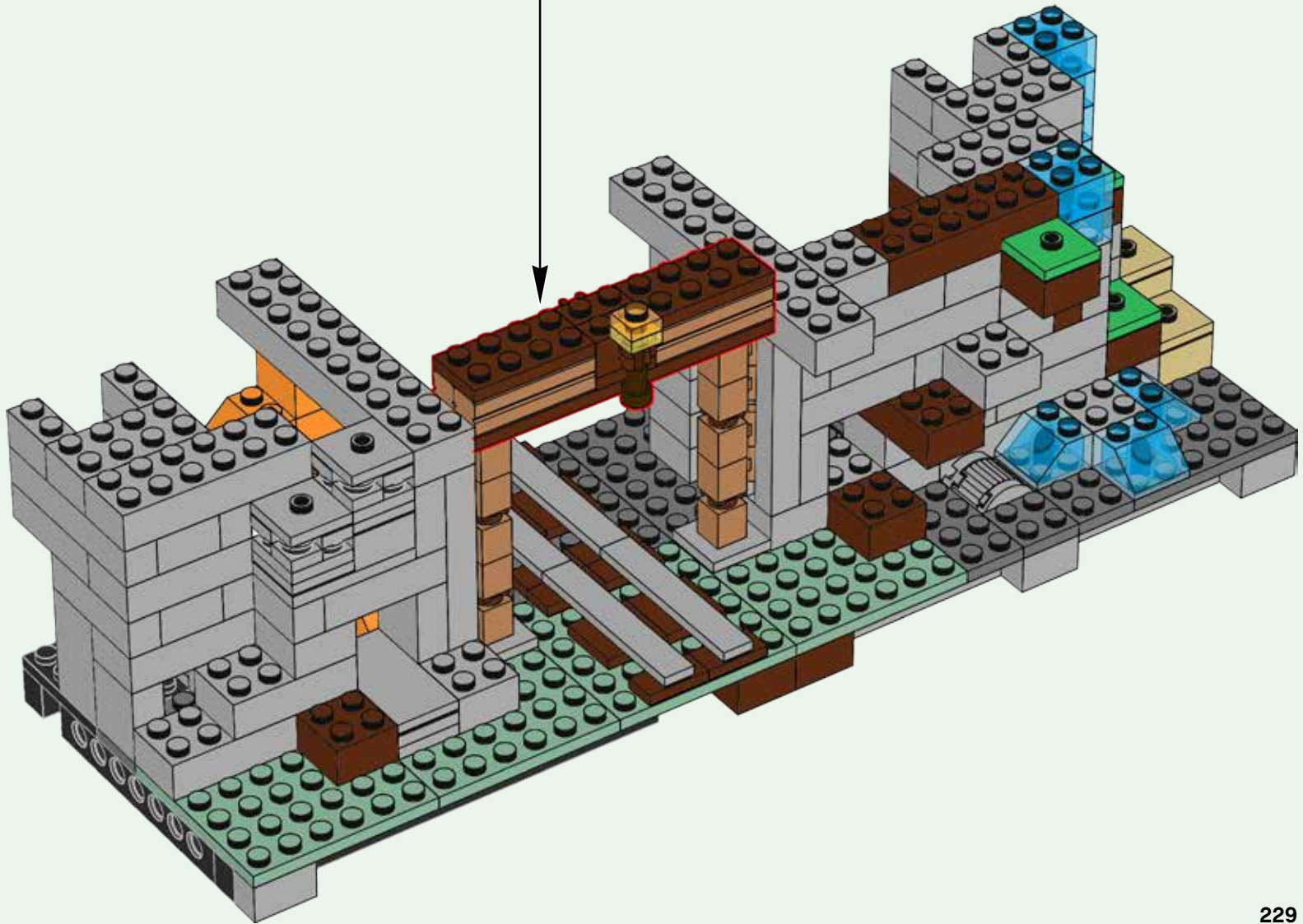
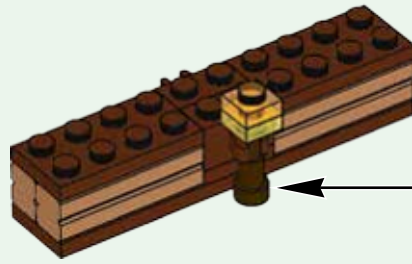

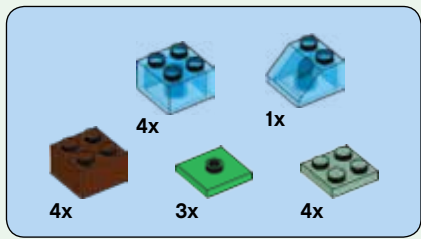

363

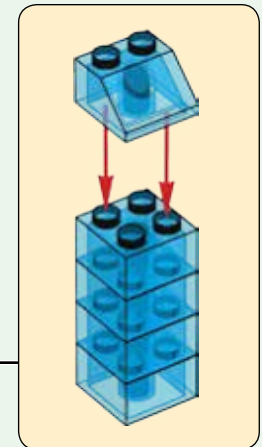
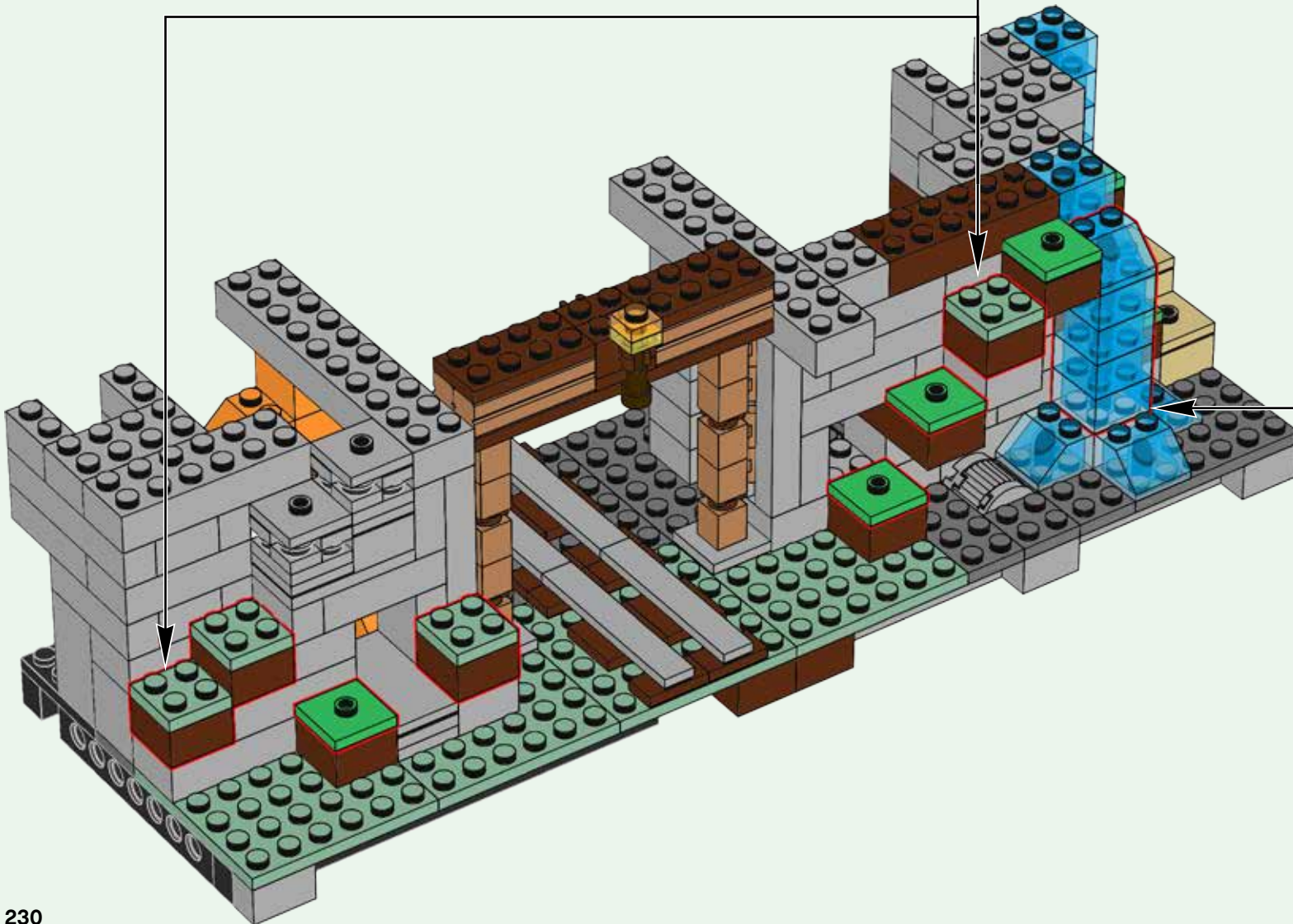
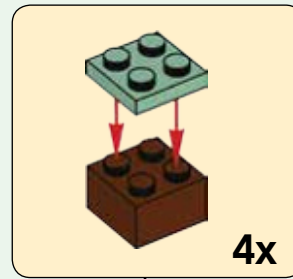



364

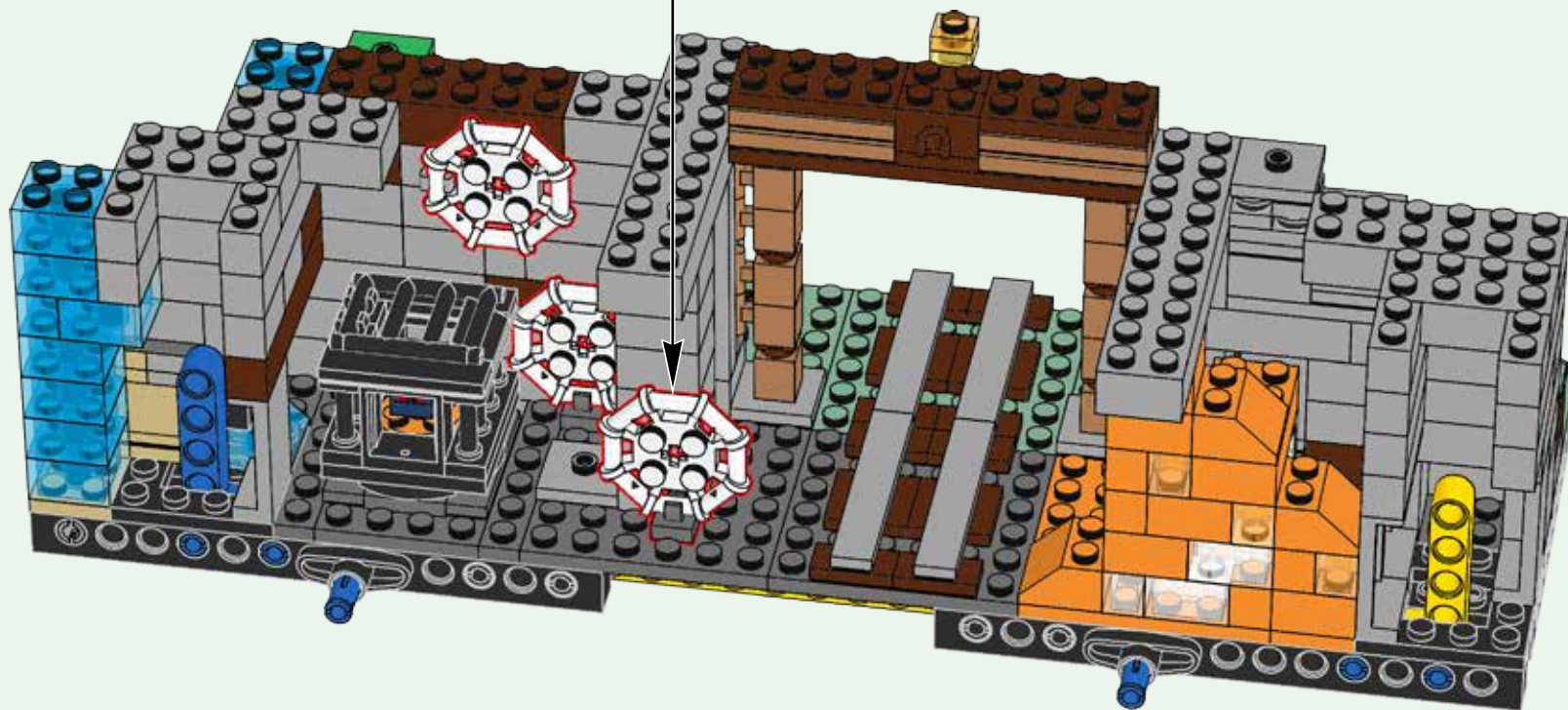
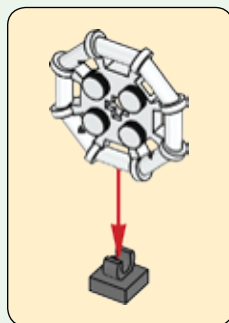
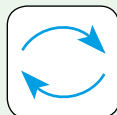

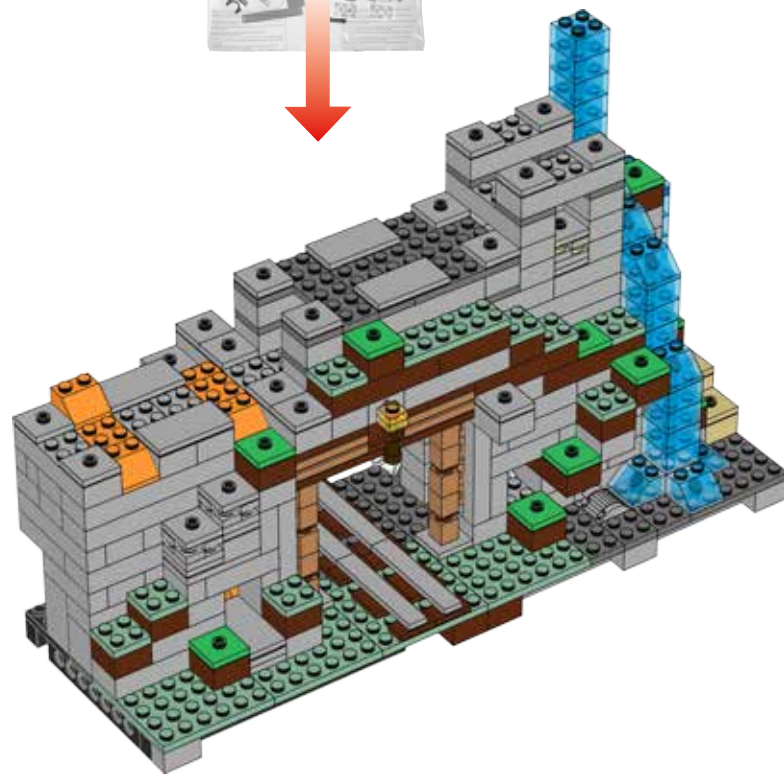

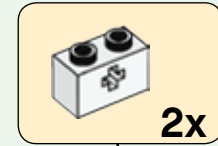
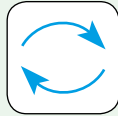
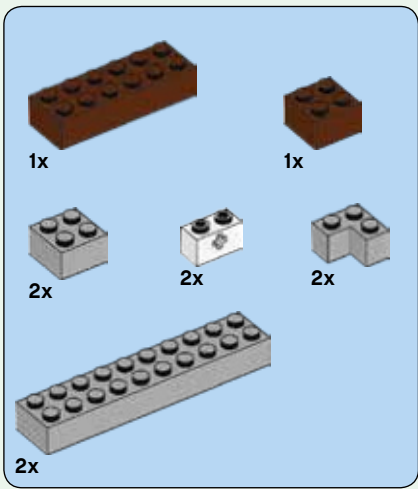

365

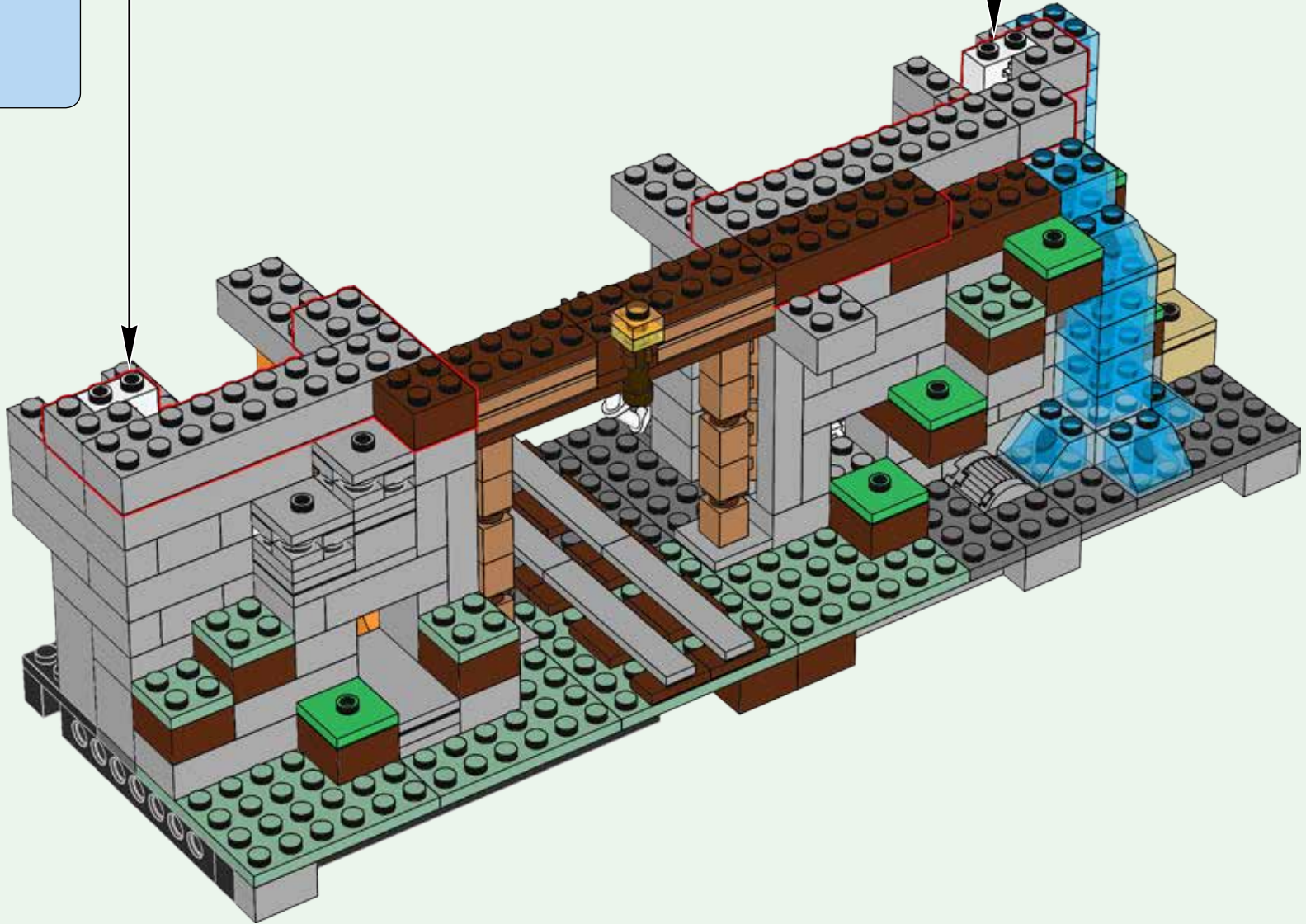

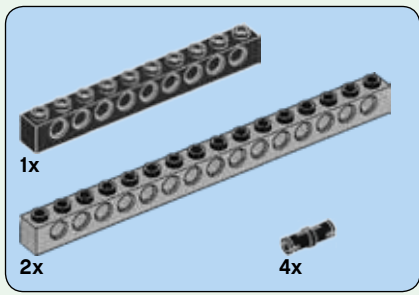

366

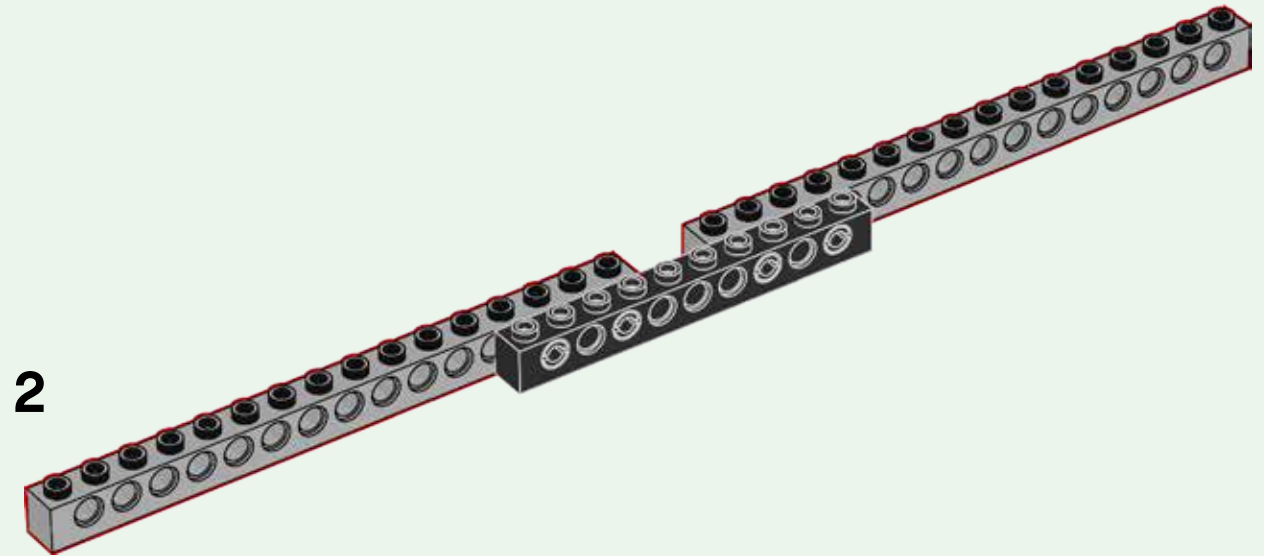
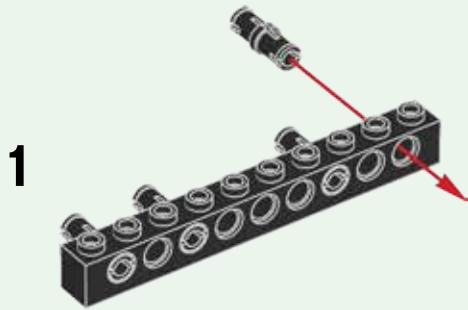

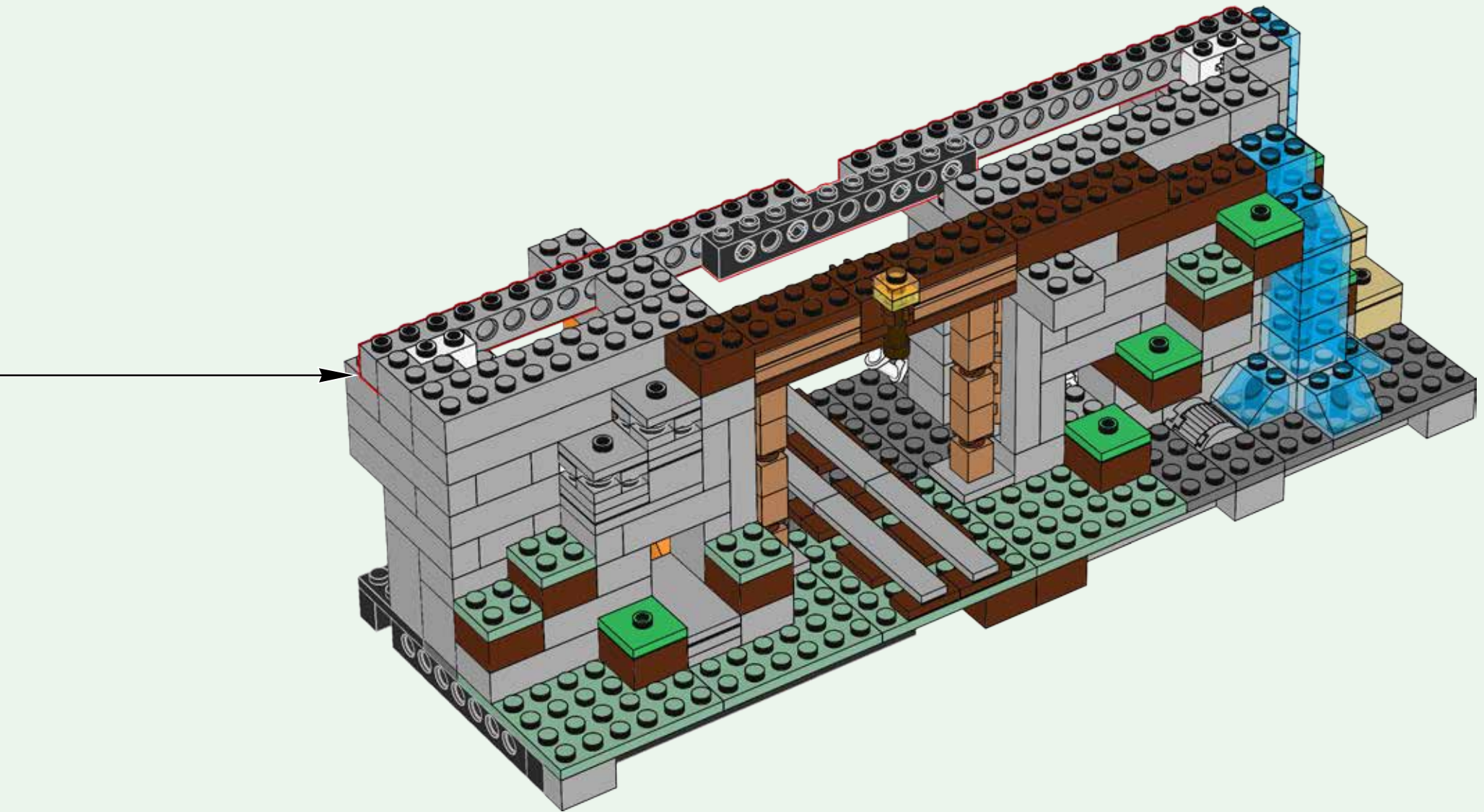

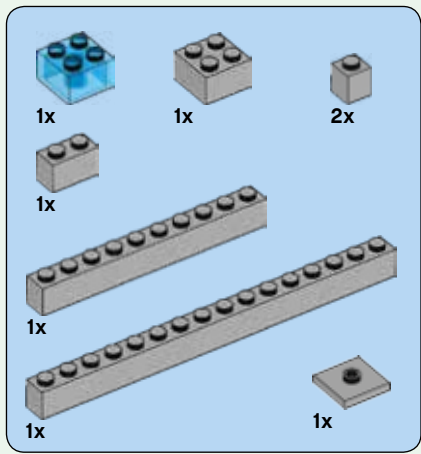

367

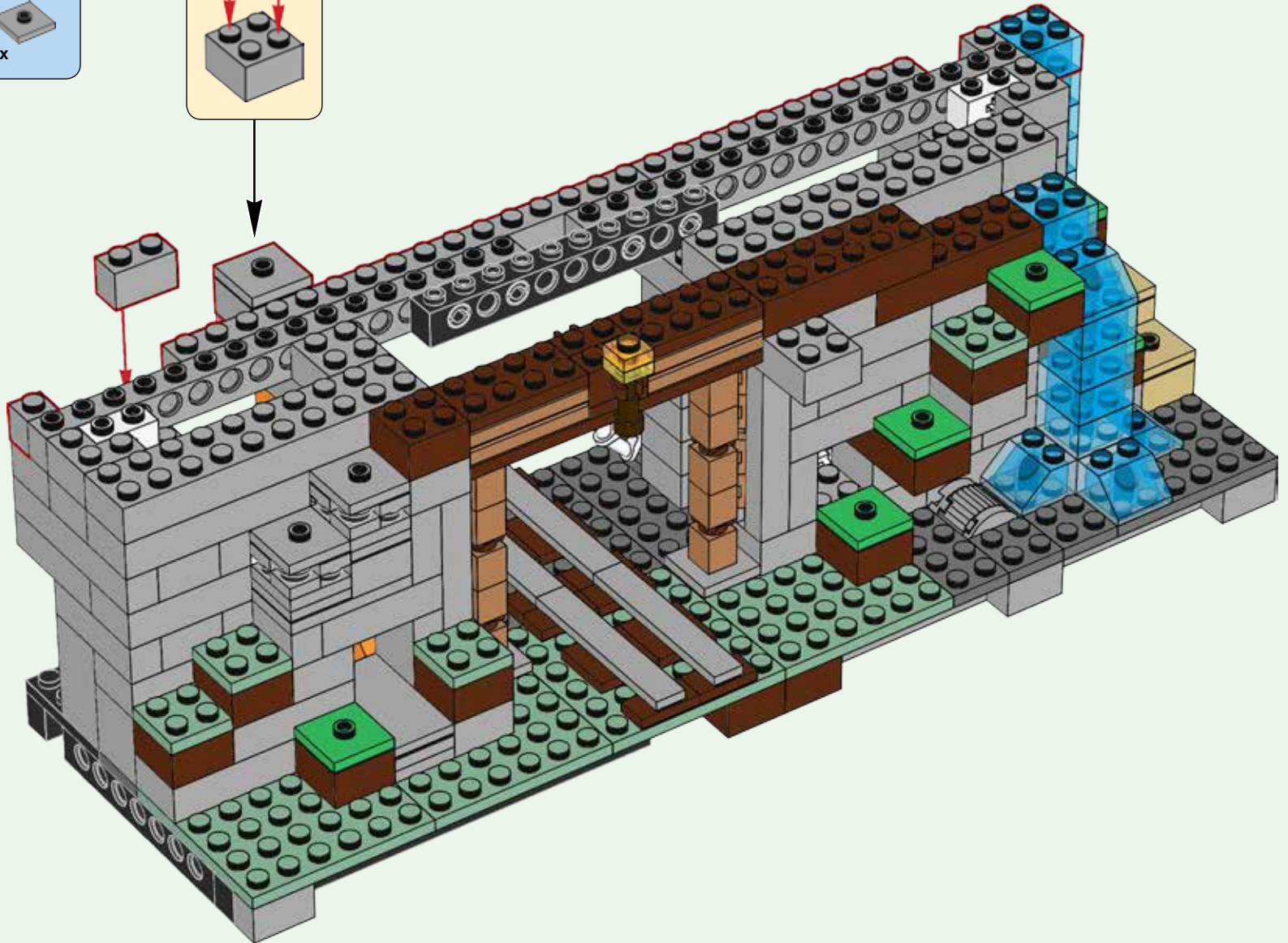
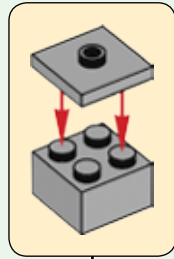

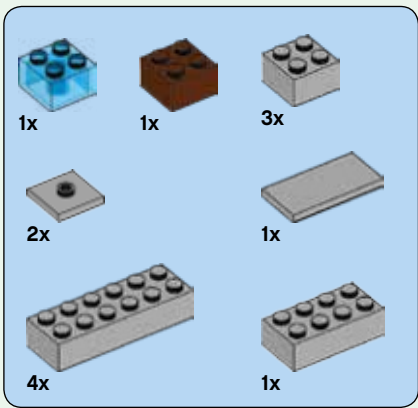

368

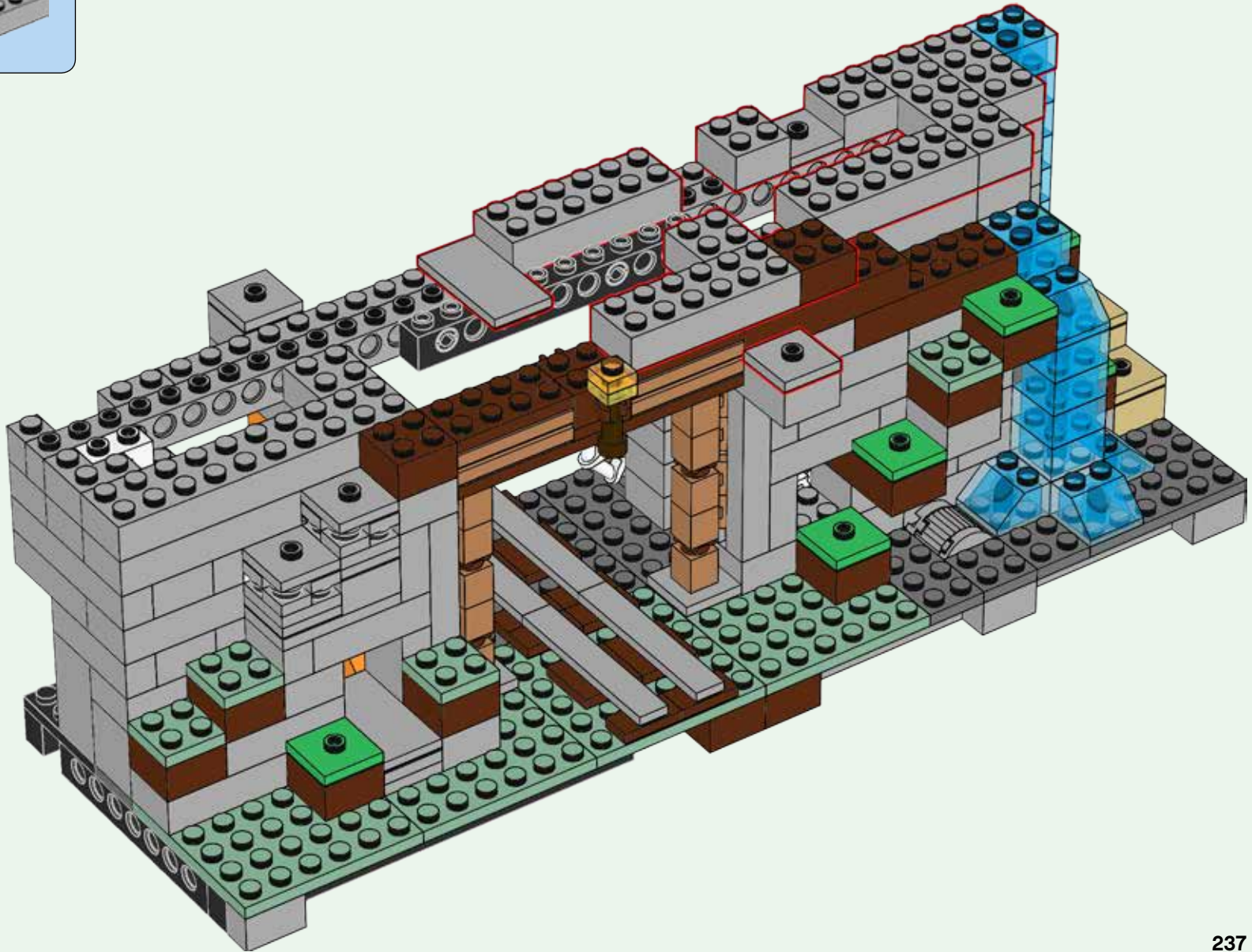

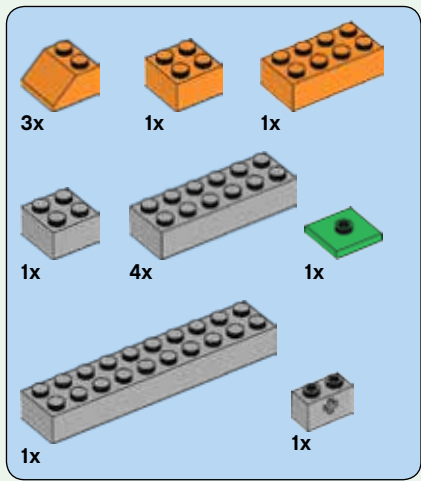

369

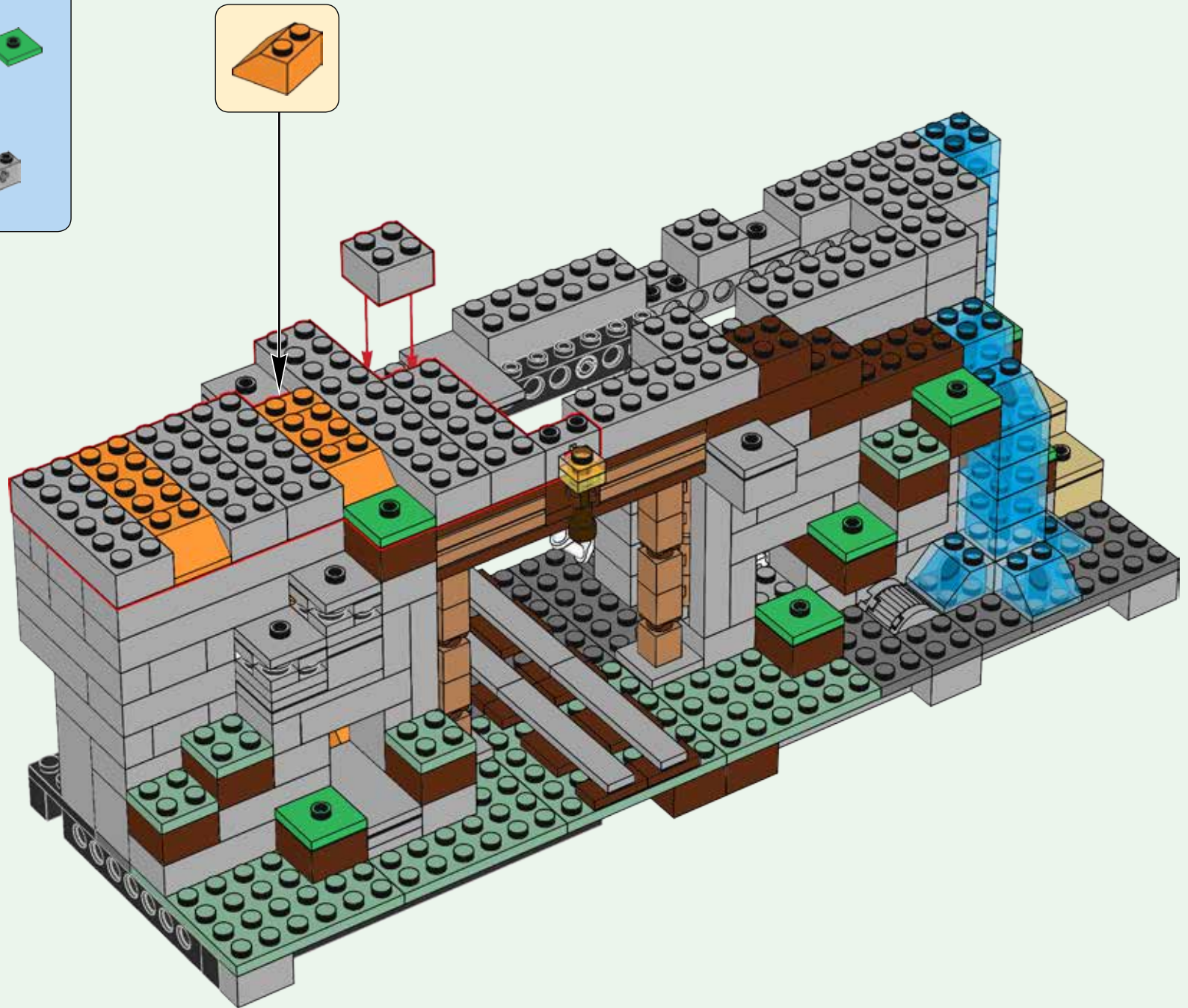



371

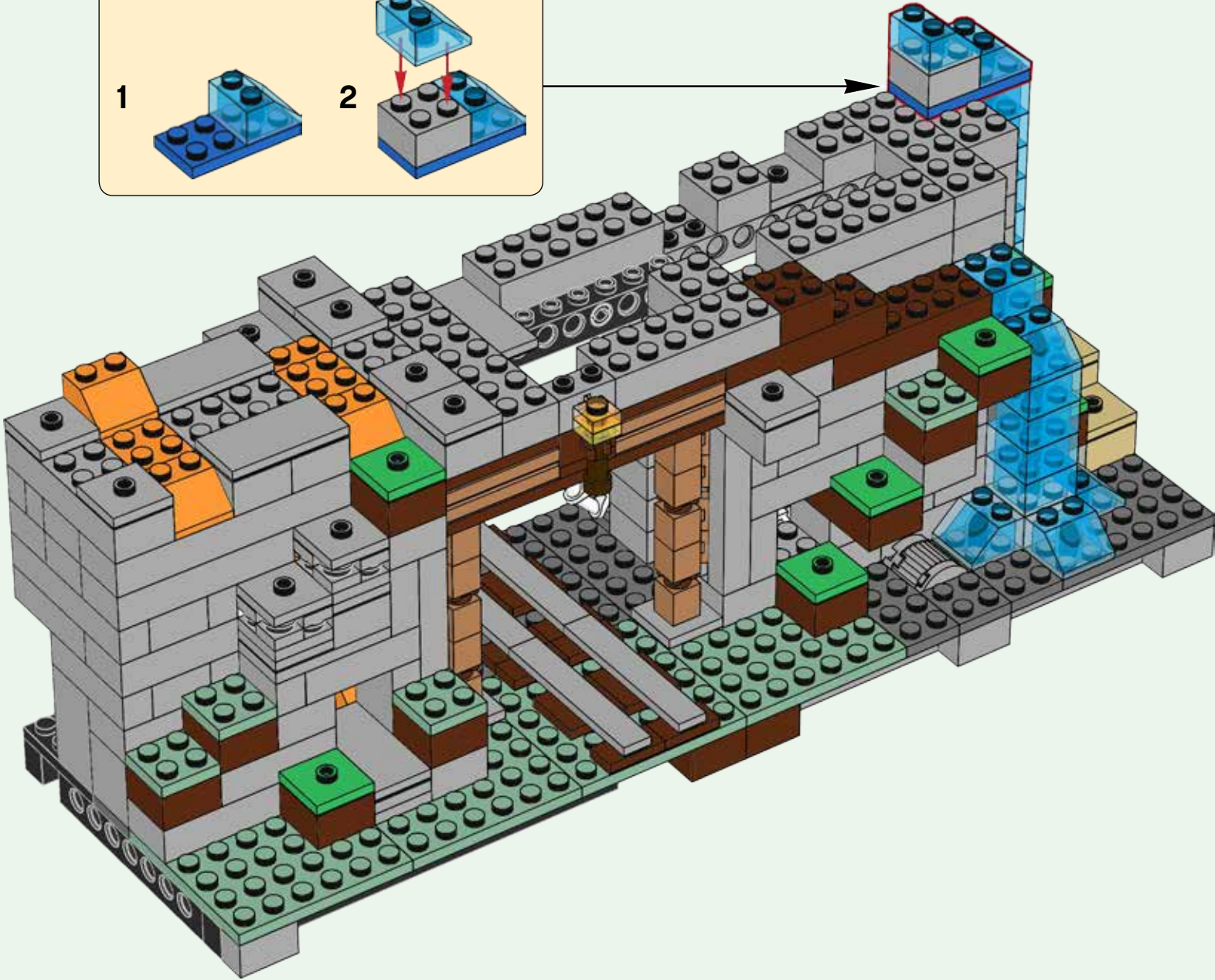
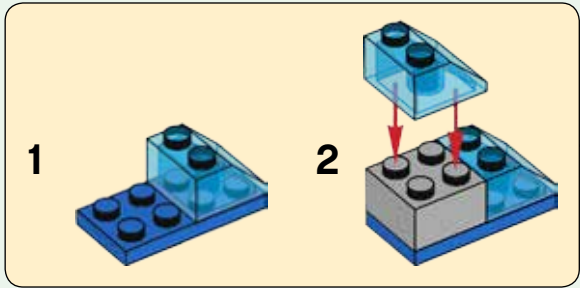

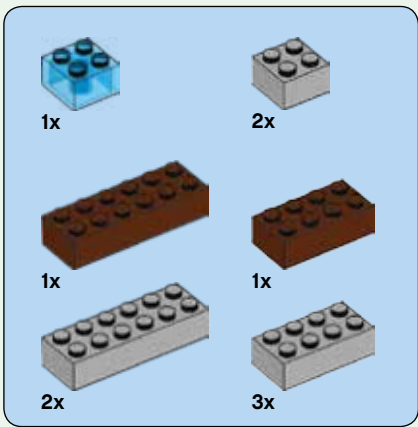

372

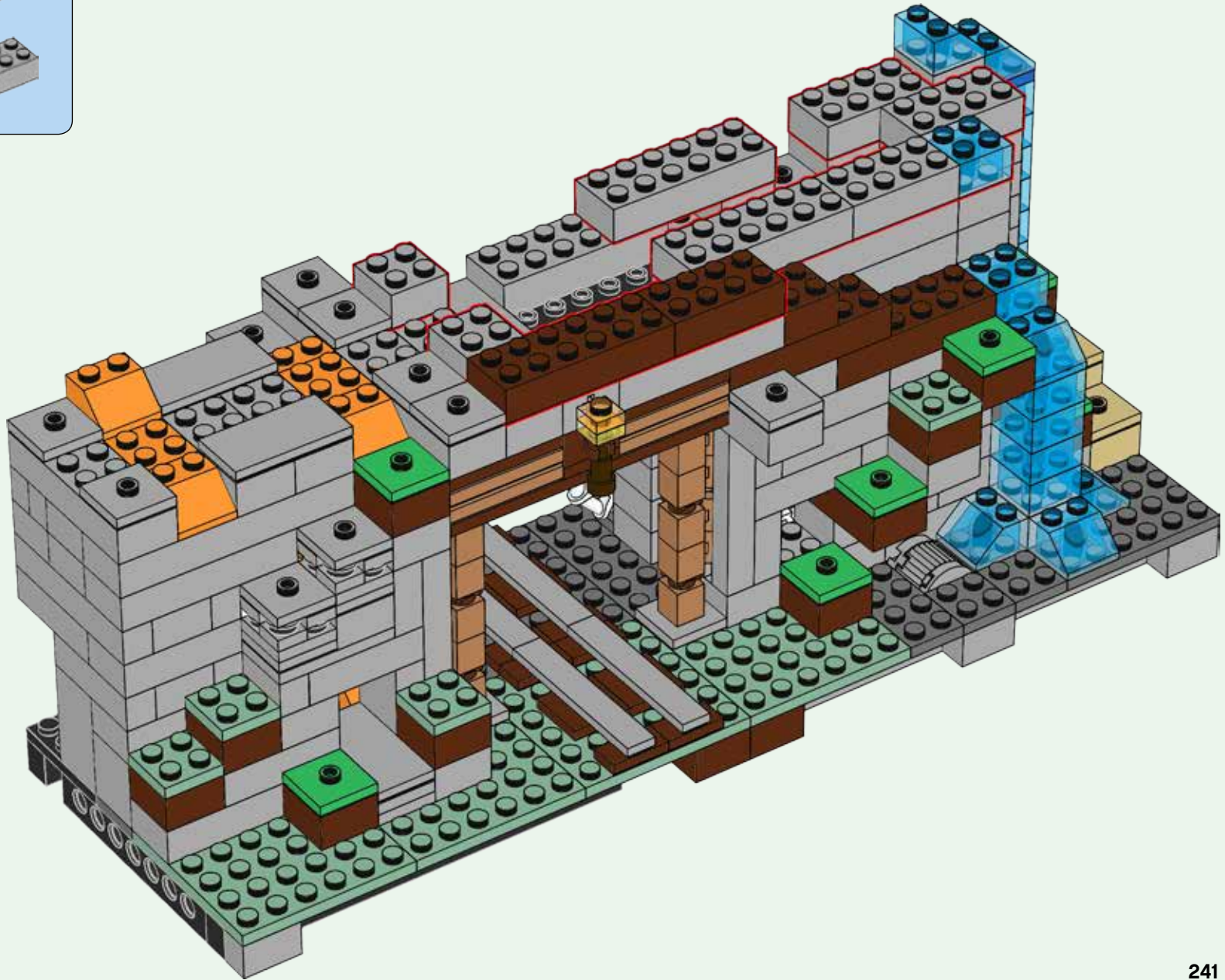

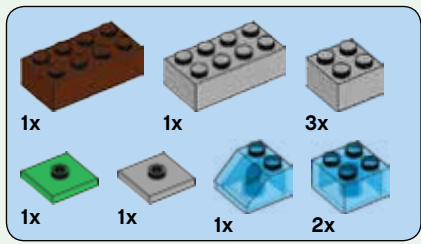

373

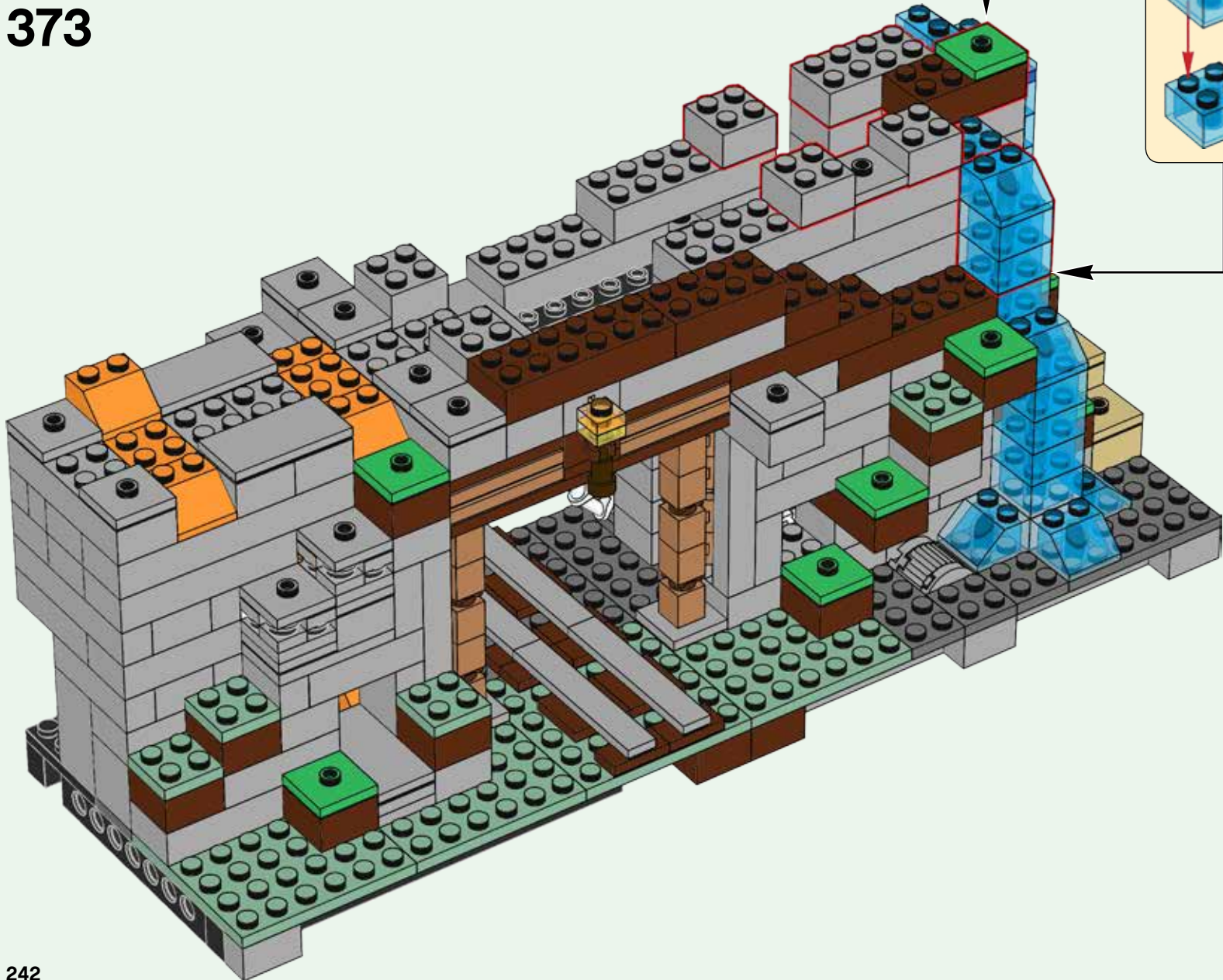
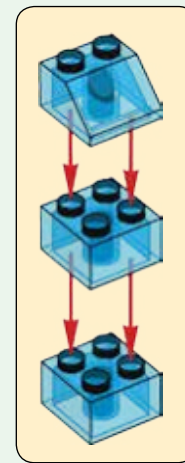
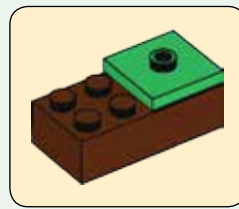

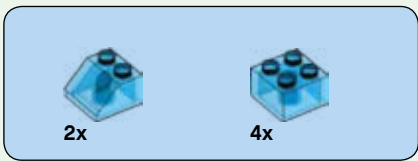

374



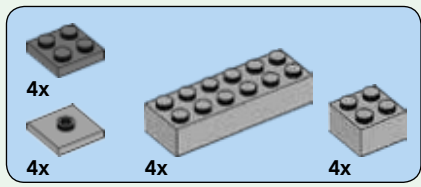

375

1

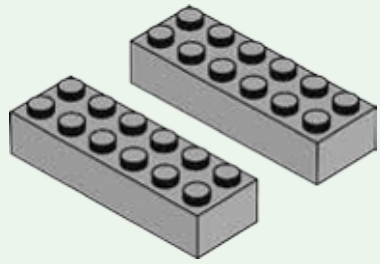

2

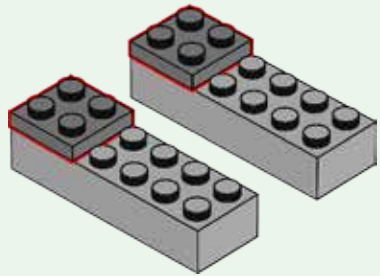

3

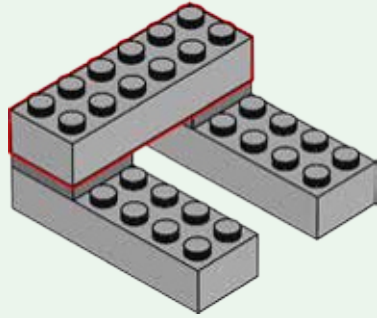

4

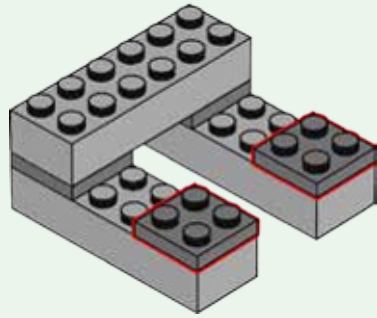

5

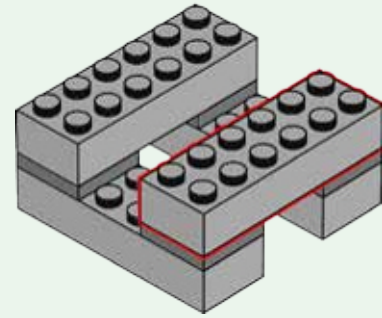

6

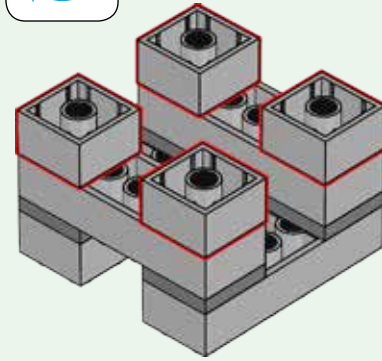
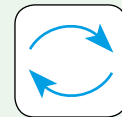

7

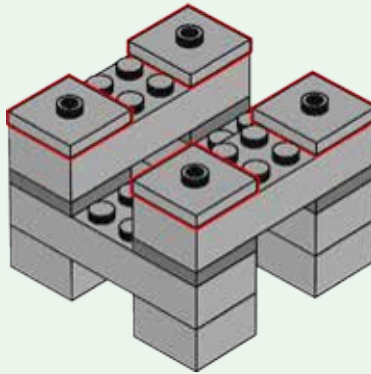
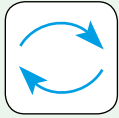

376

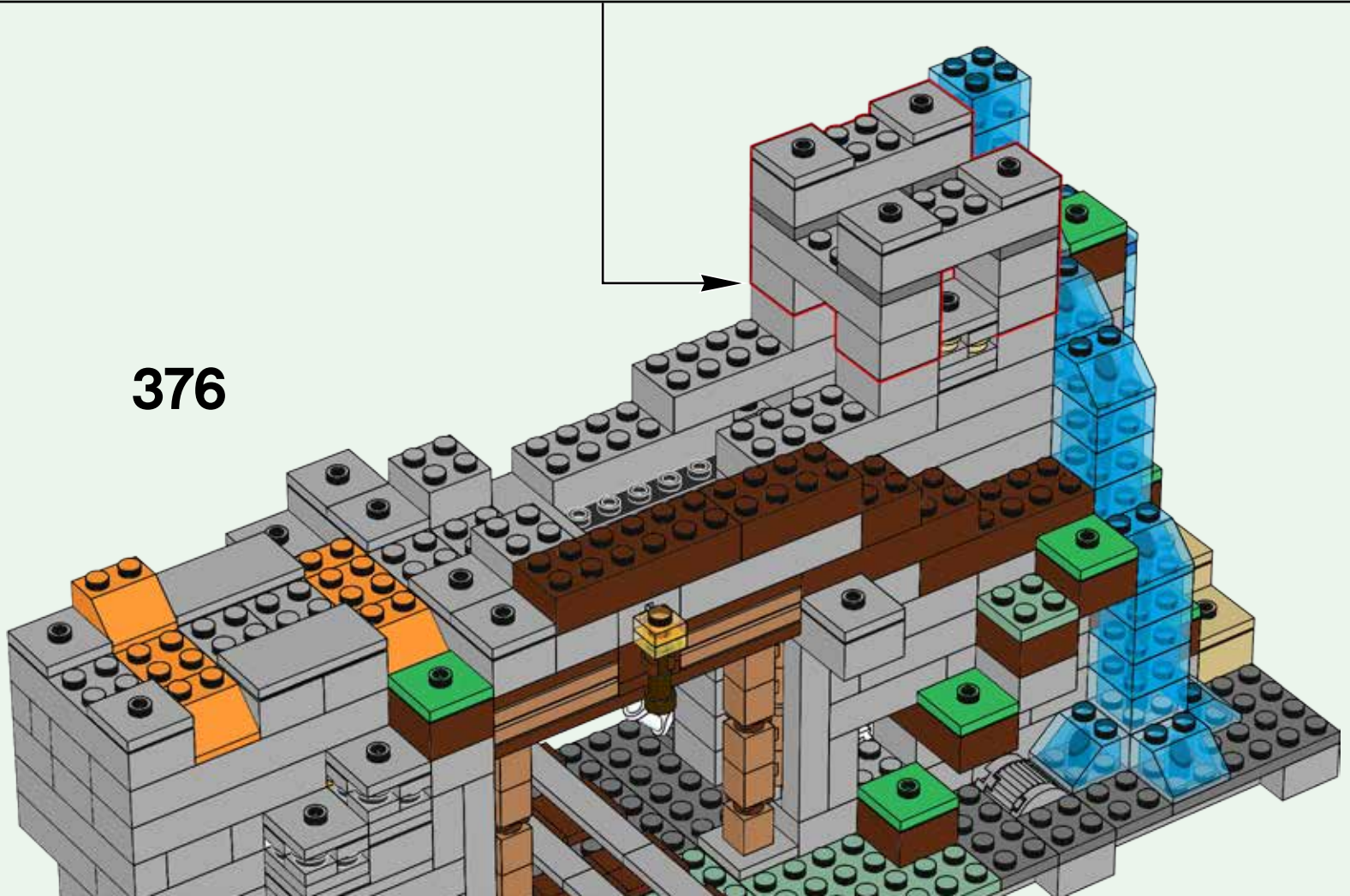

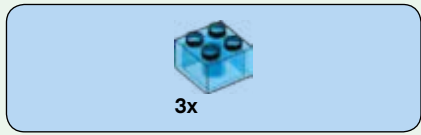

377

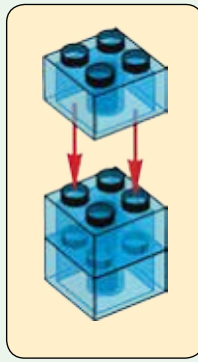

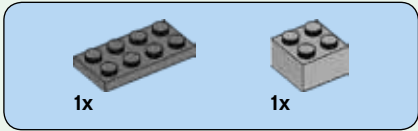
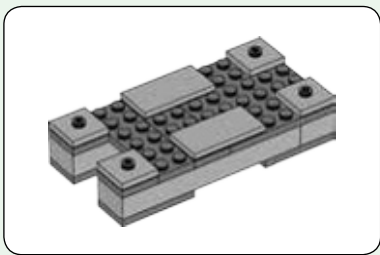

378

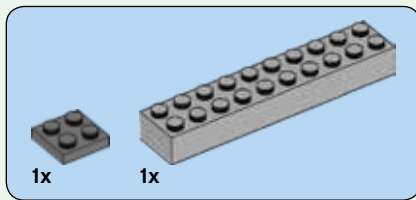
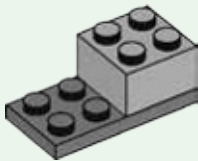

379

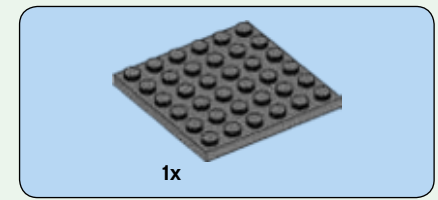
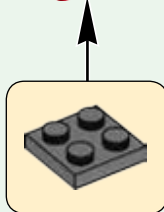
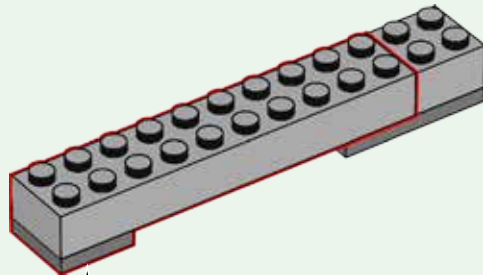

380

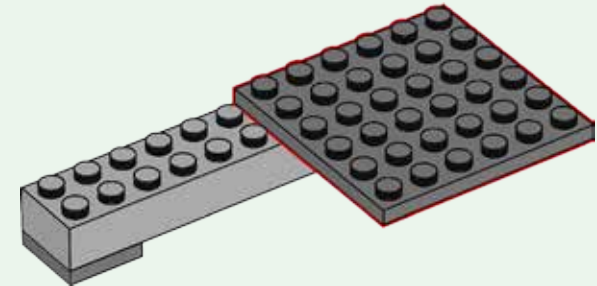

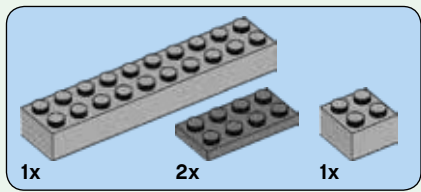

381

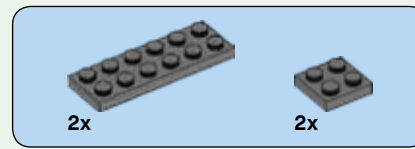
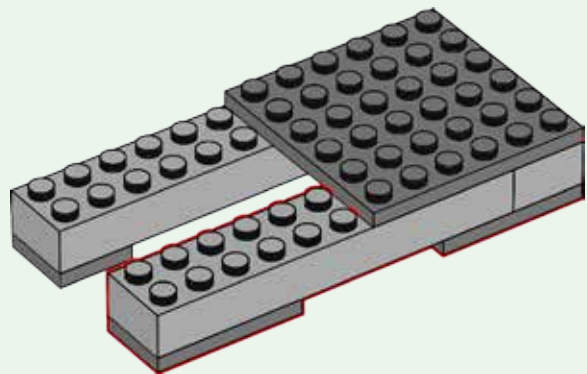
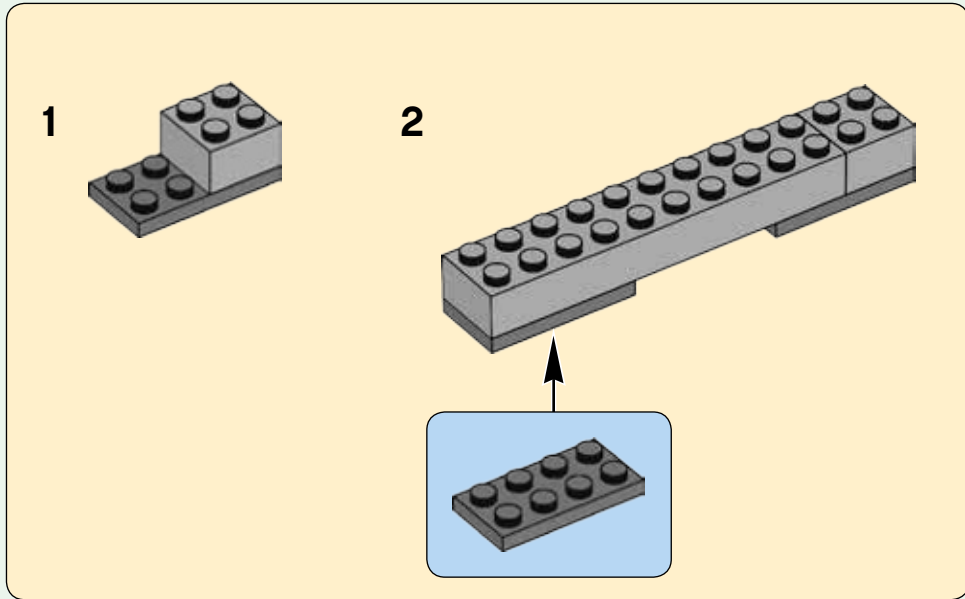

382

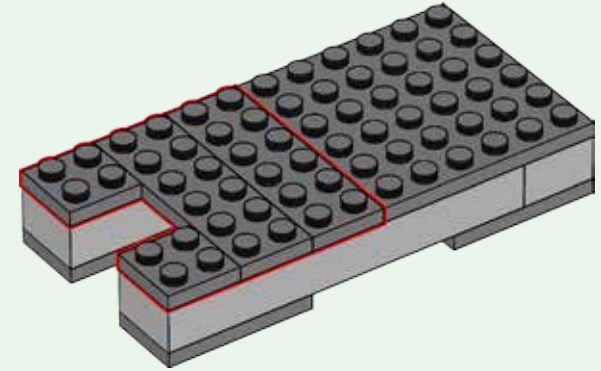

383

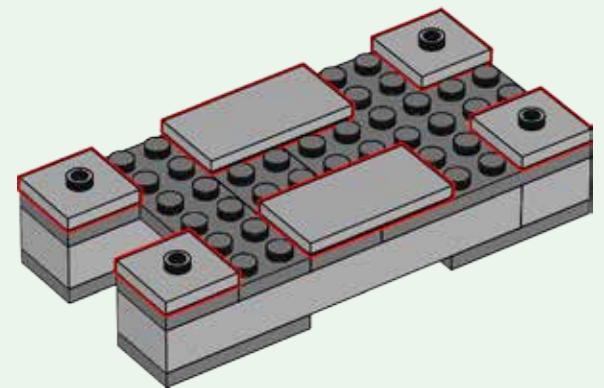

384



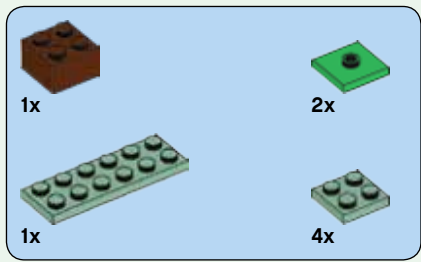

385

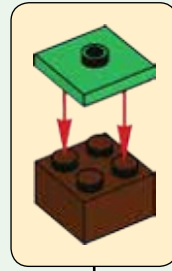

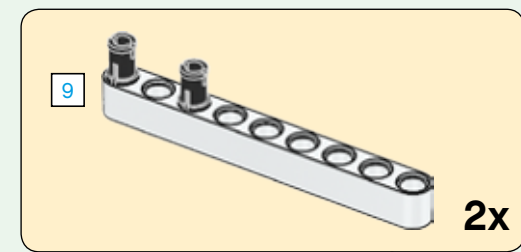
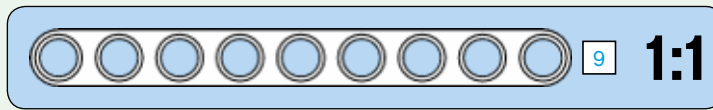
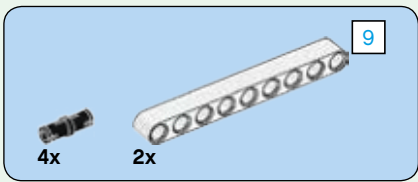

386

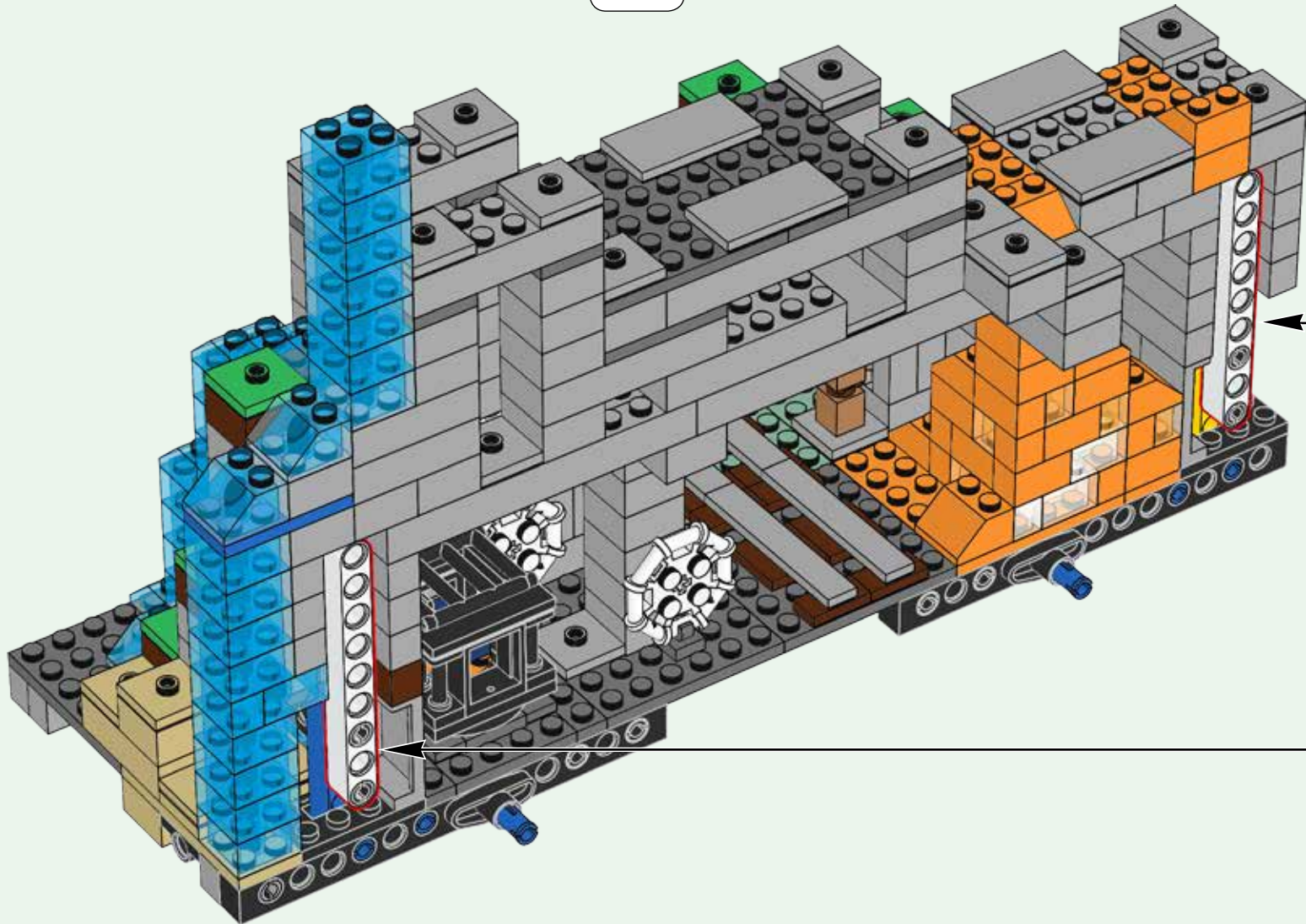
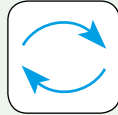

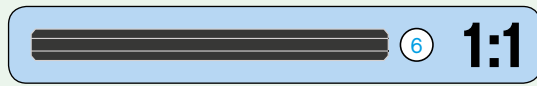
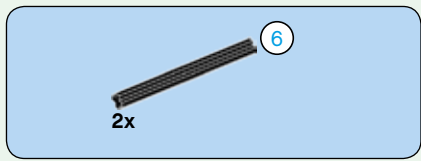

387

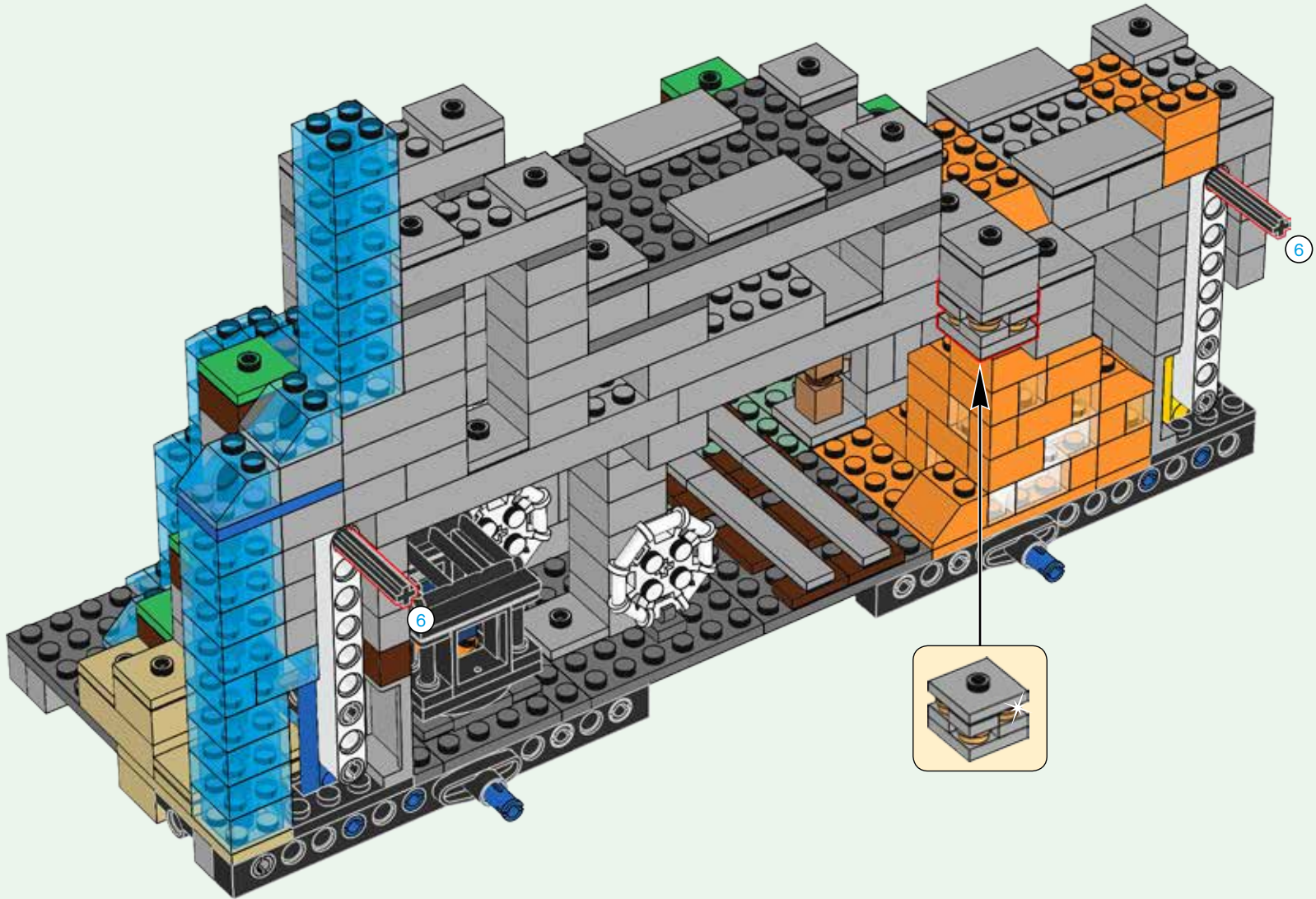

388

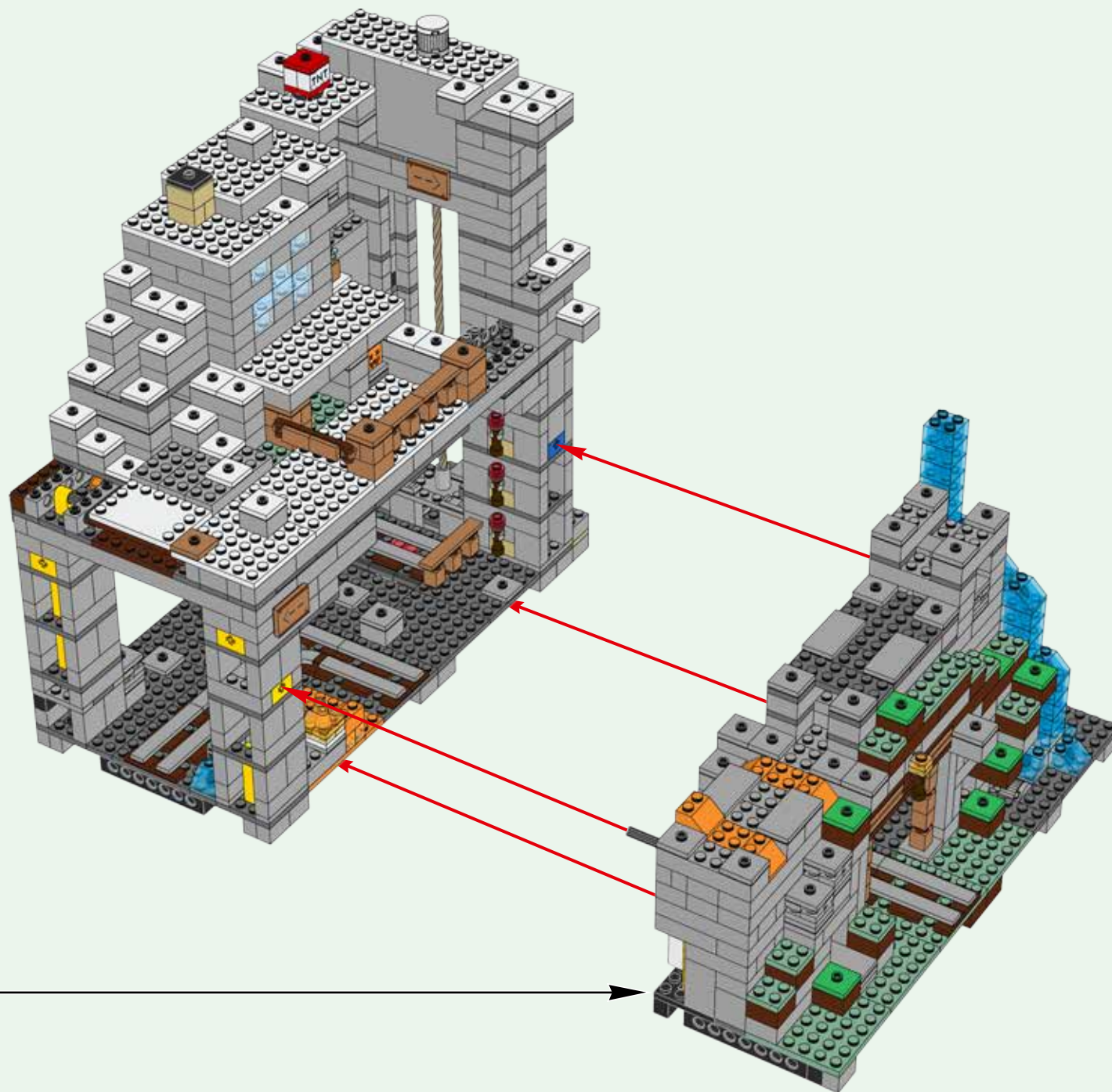

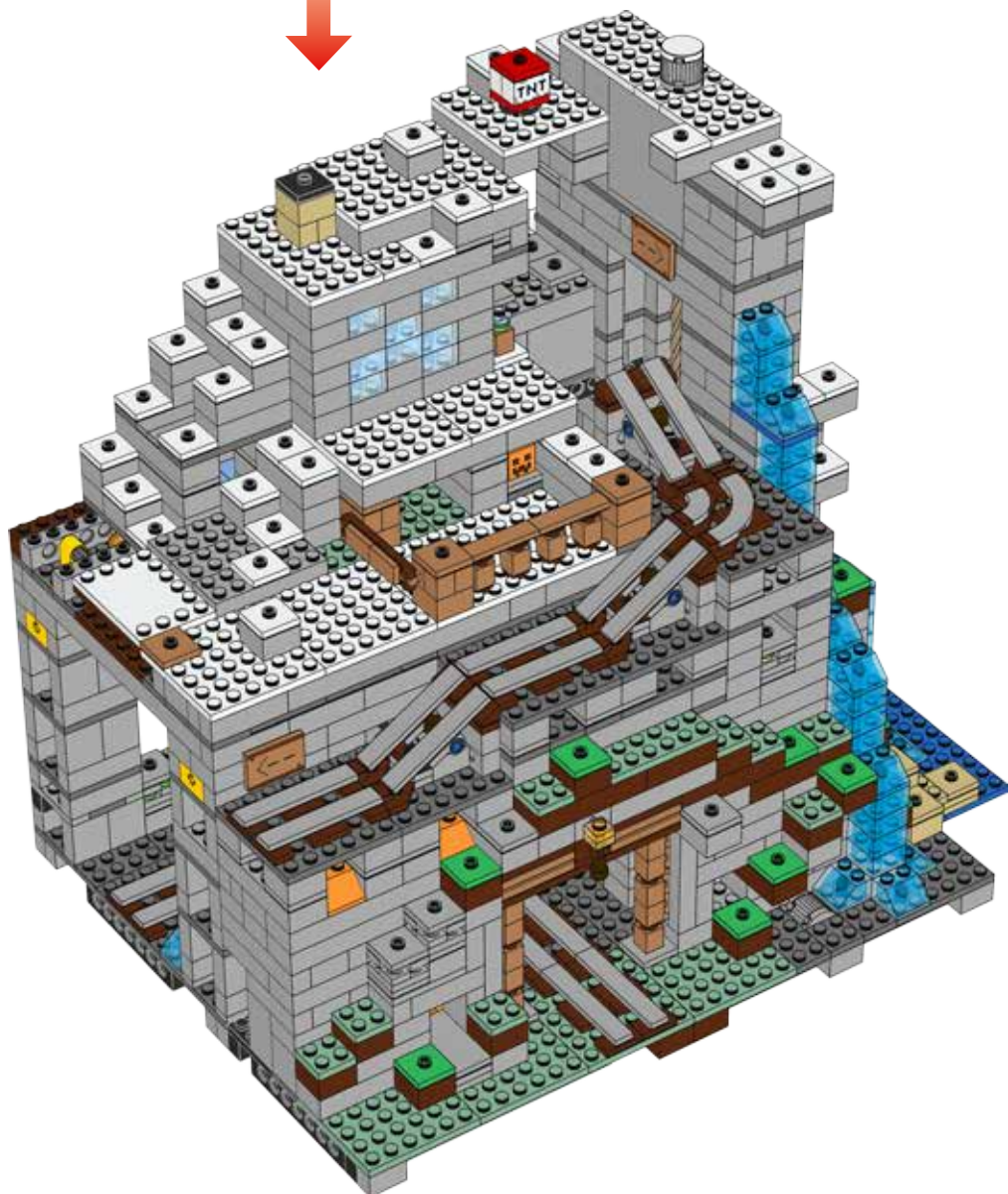



389

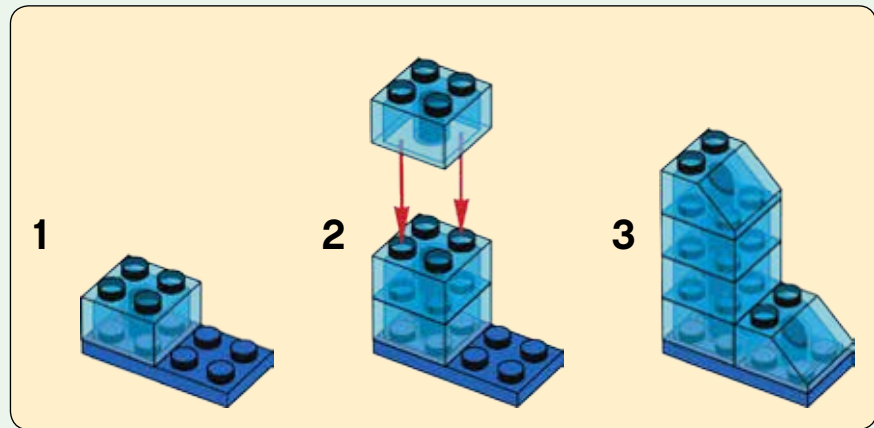

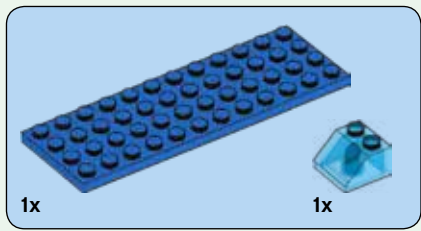

390



391

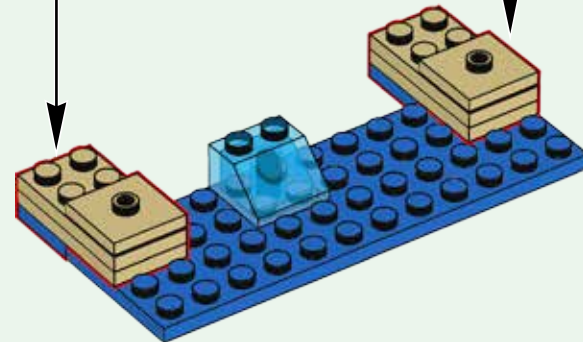
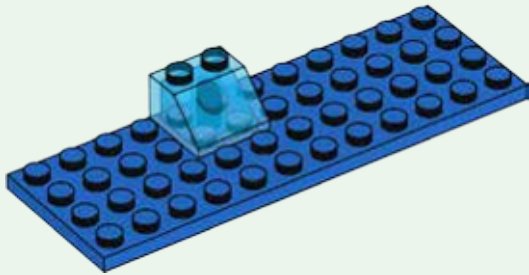
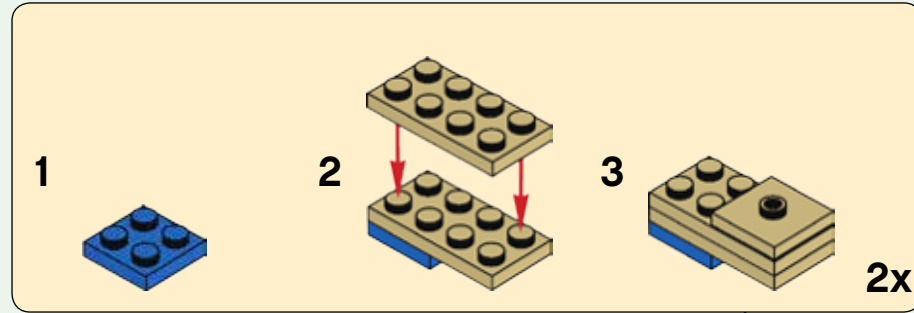

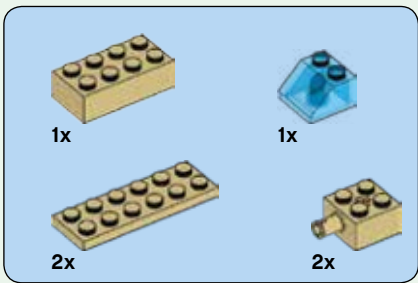

392

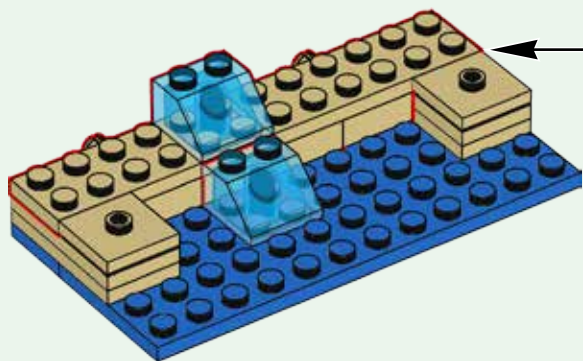
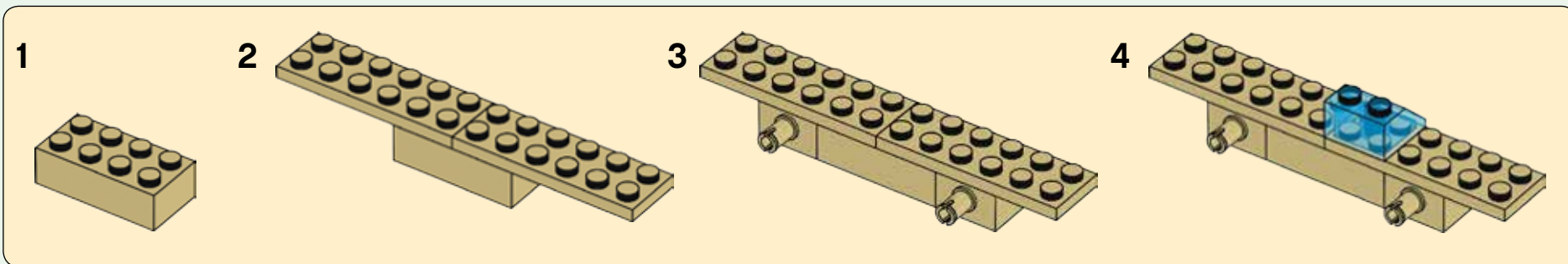

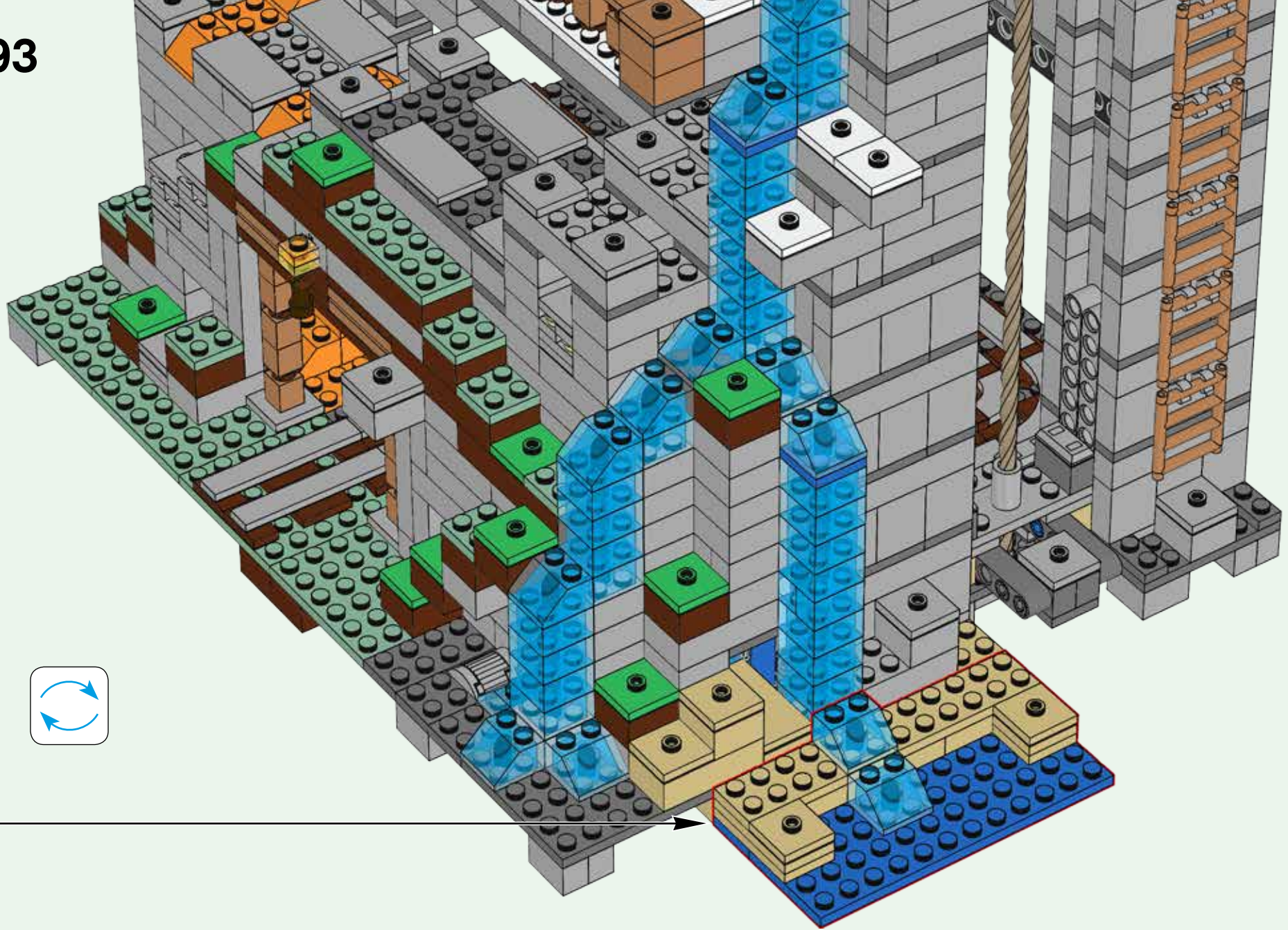

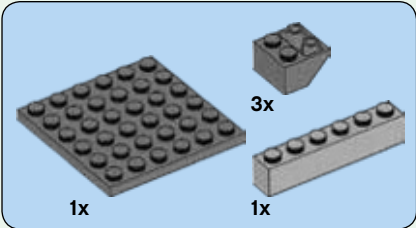

394

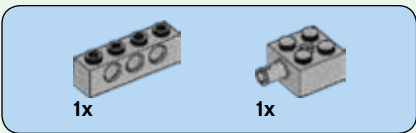
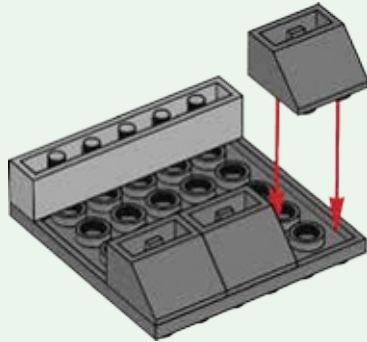

395

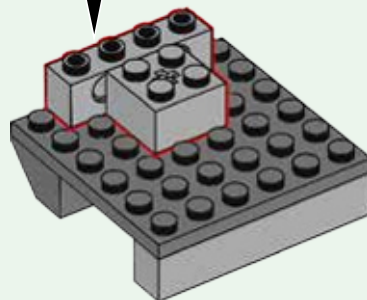
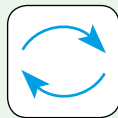
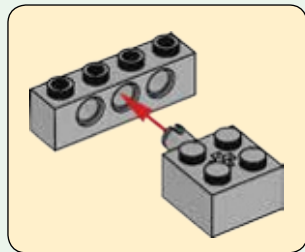

396

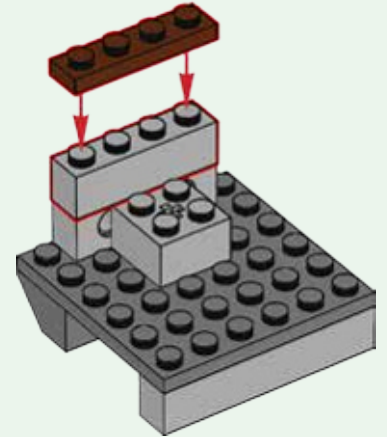

397

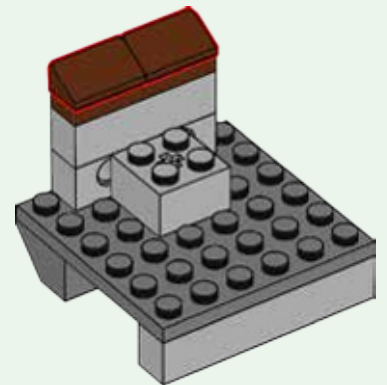

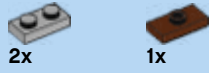

398

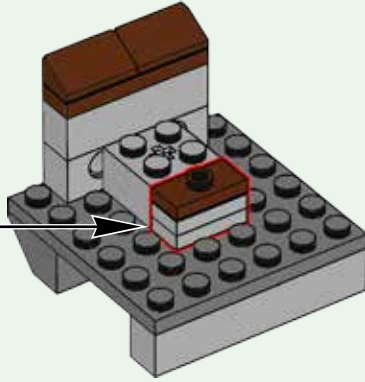
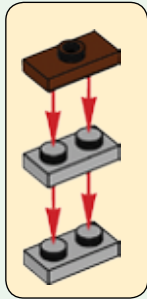

399

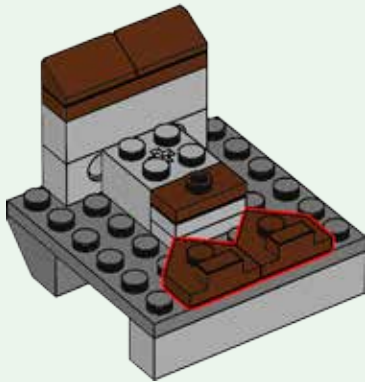

400

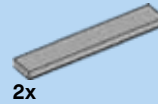
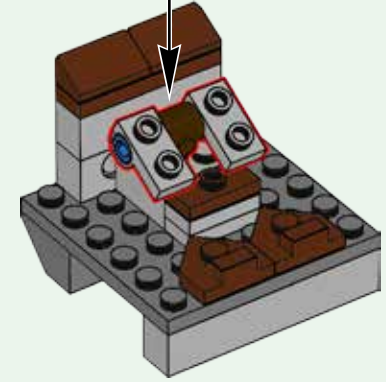

401

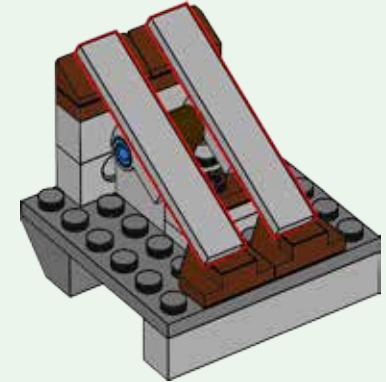

402

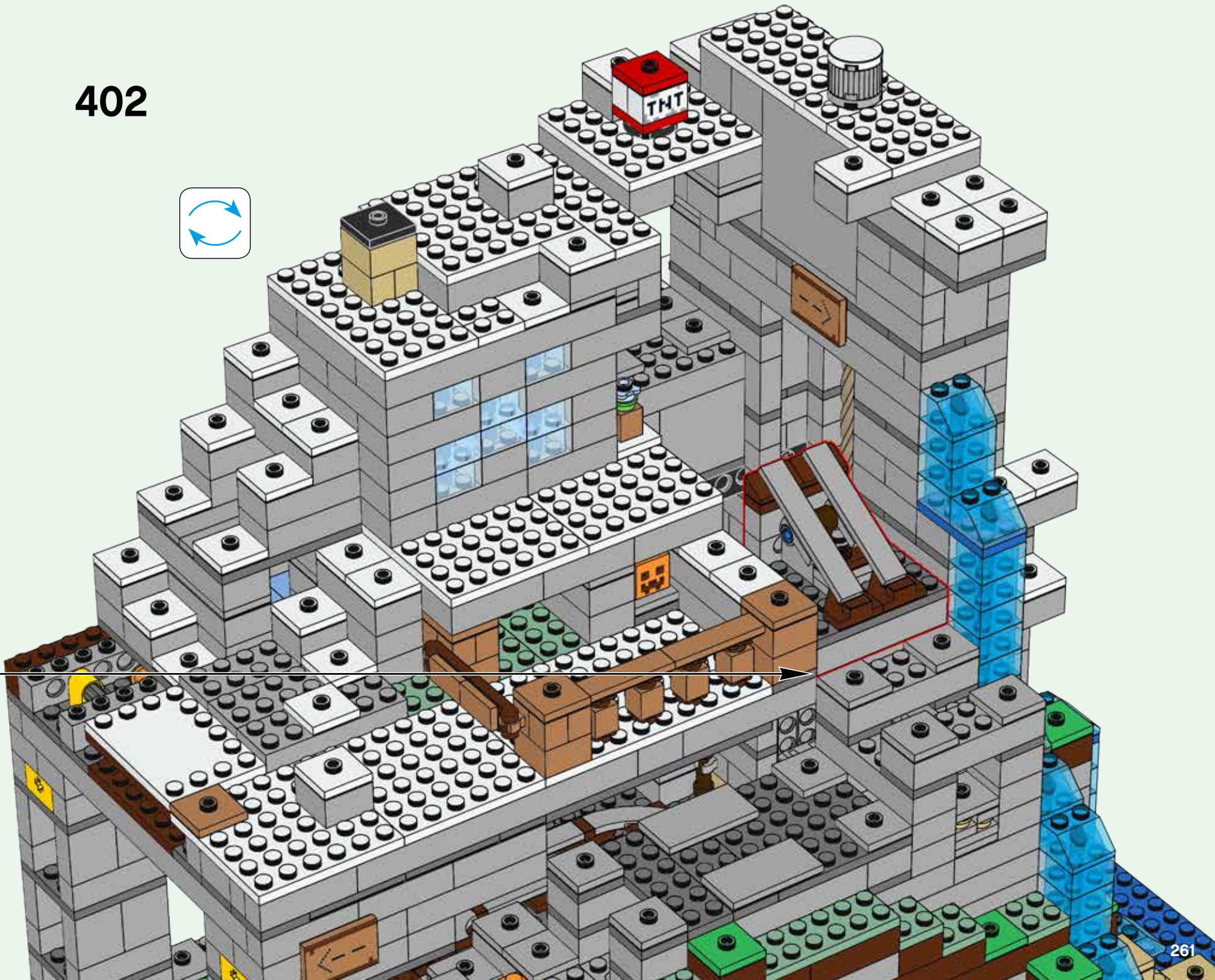
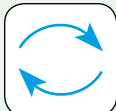

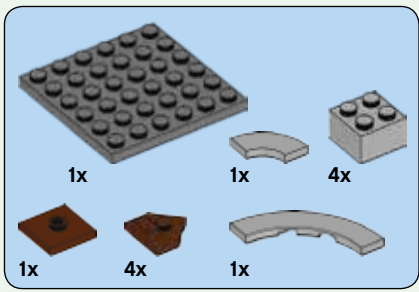

403

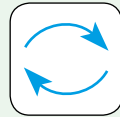

1

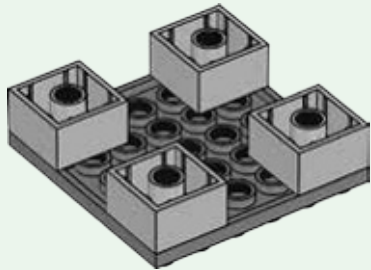

2

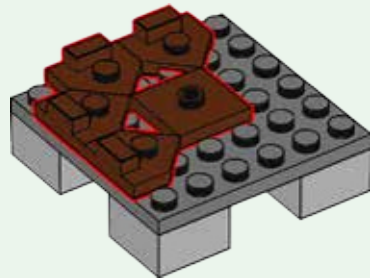

3

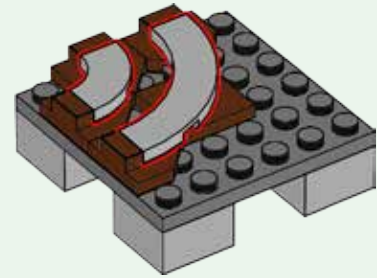

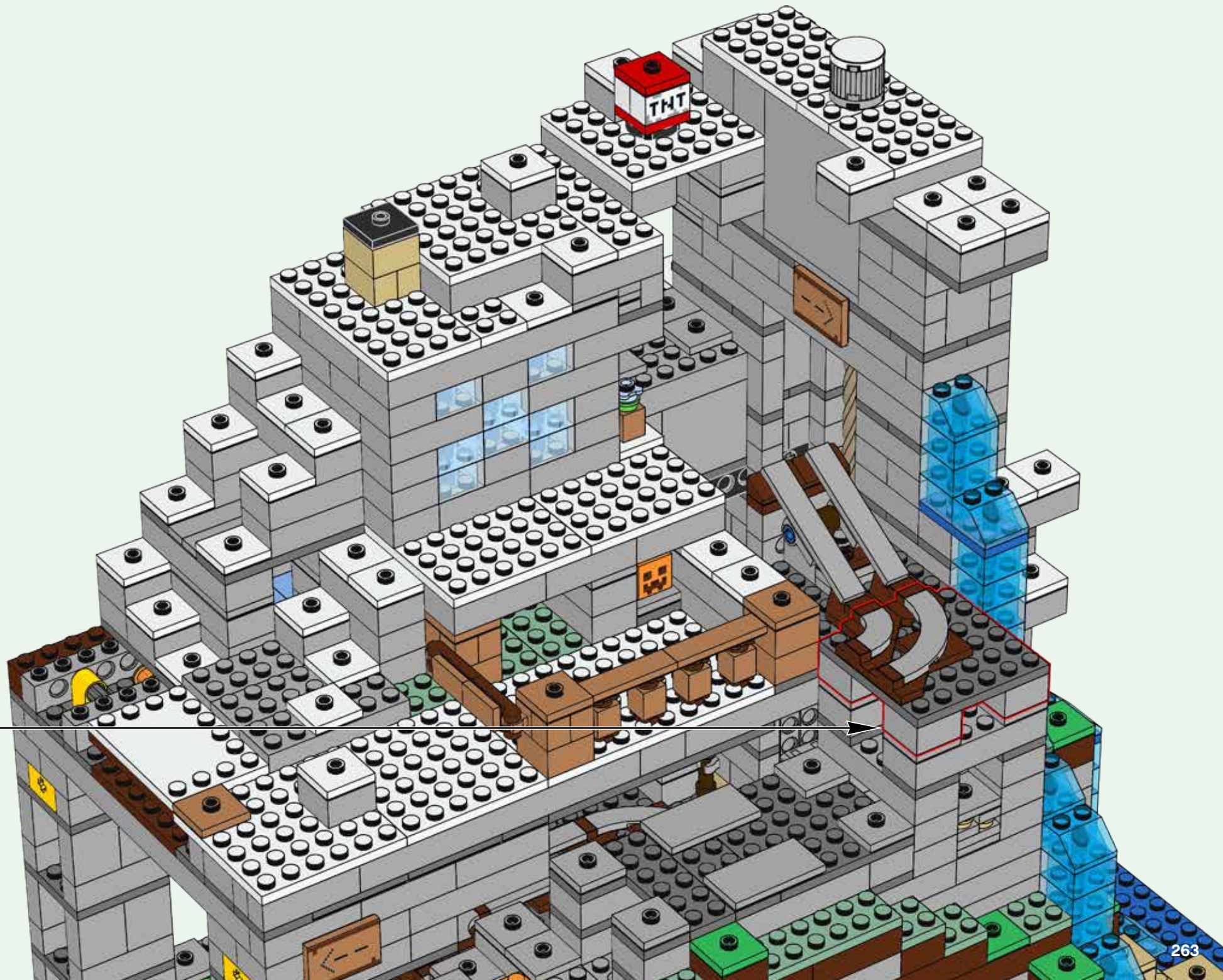

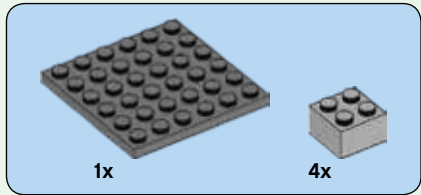
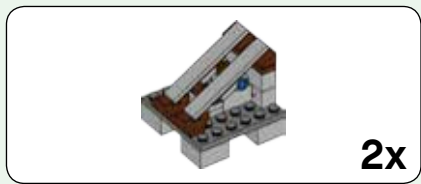

404

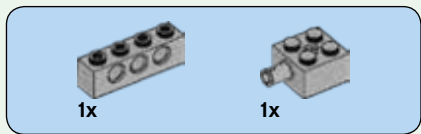
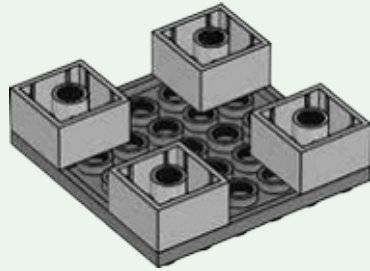

405

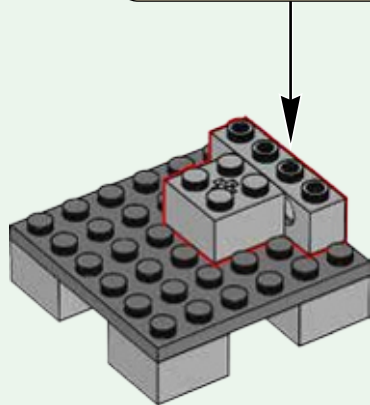
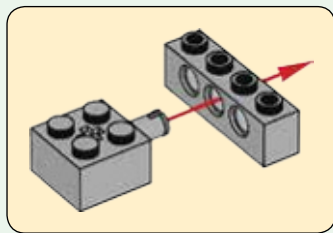
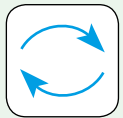

406

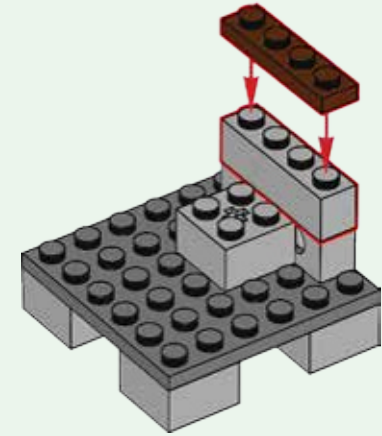

407

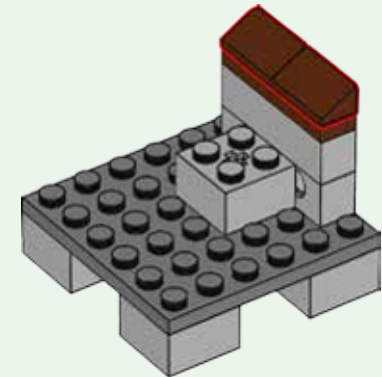

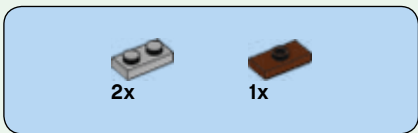

408

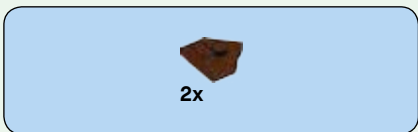
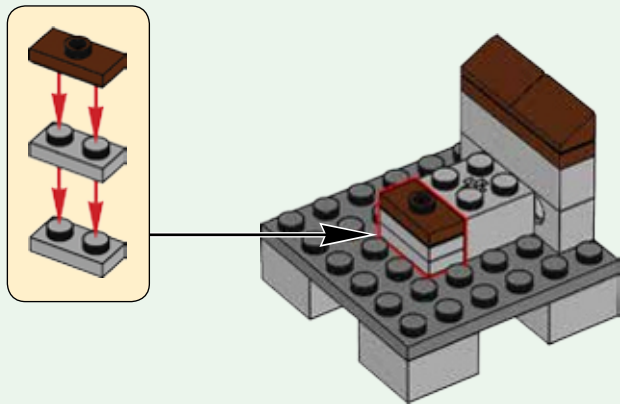

409

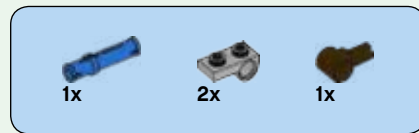
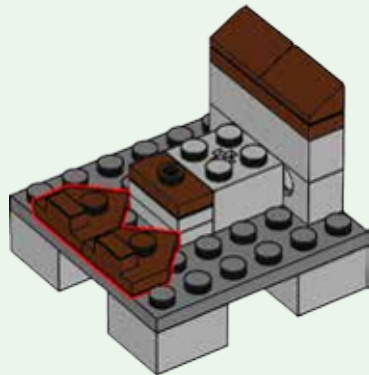

410

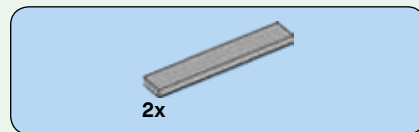
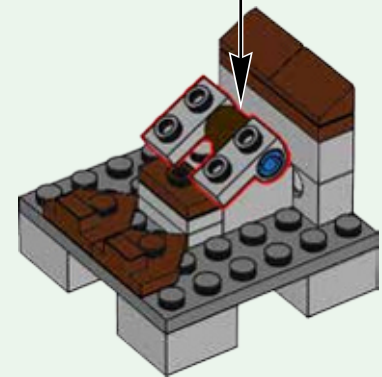

411

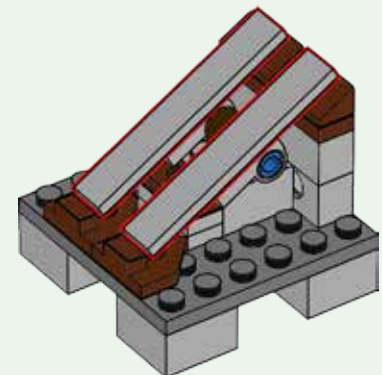

2x

412

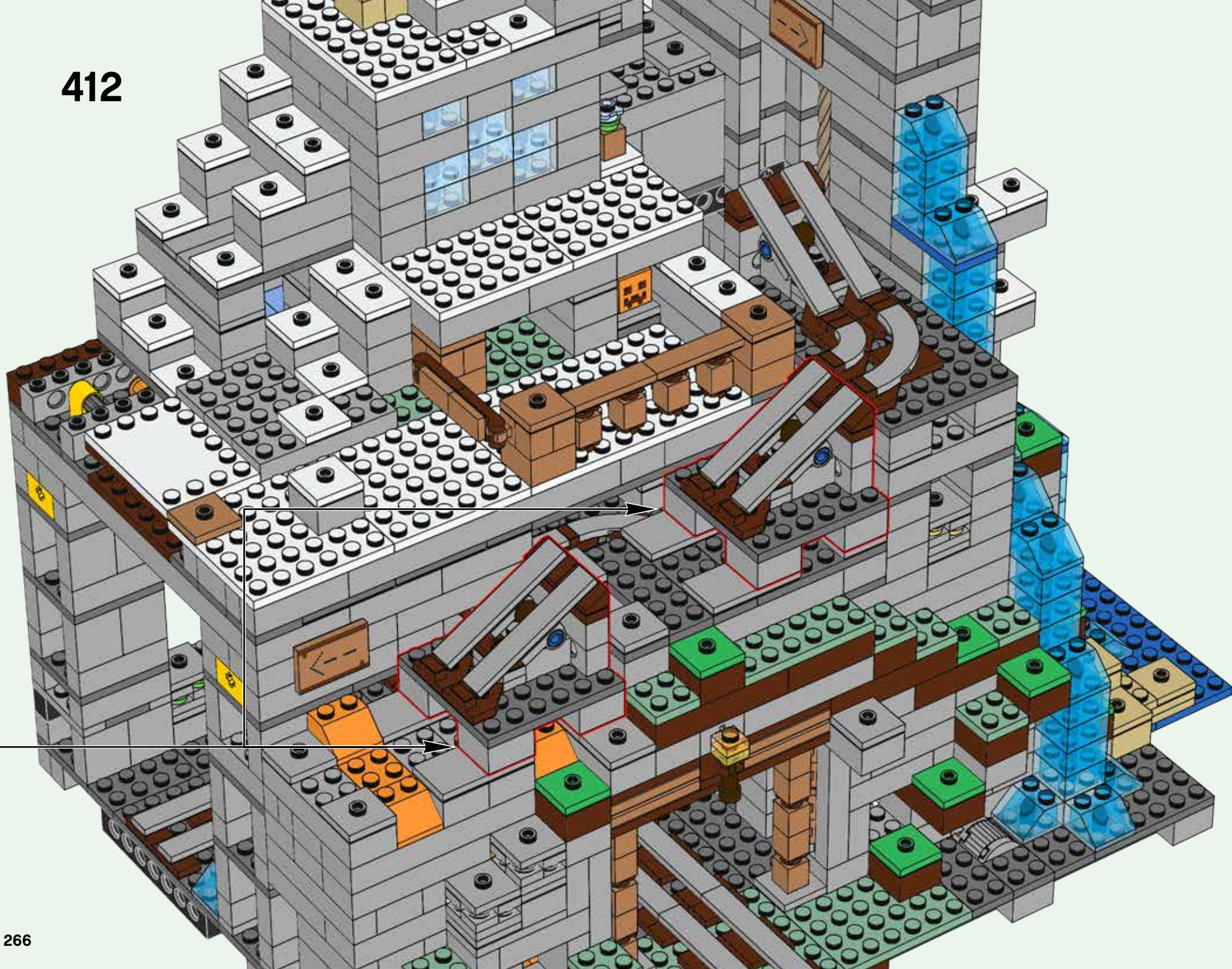

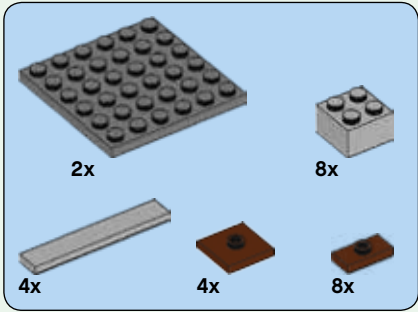

413

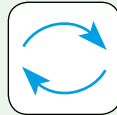

1

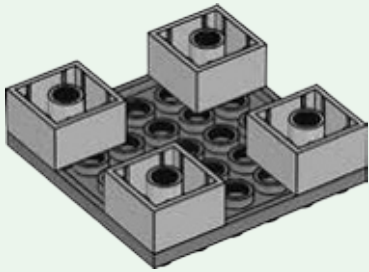

2

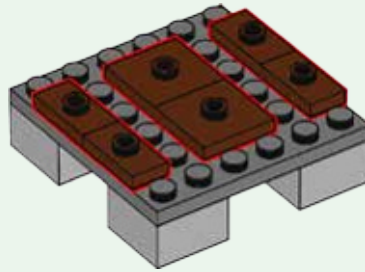

3

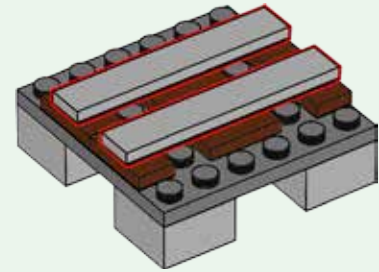

2x

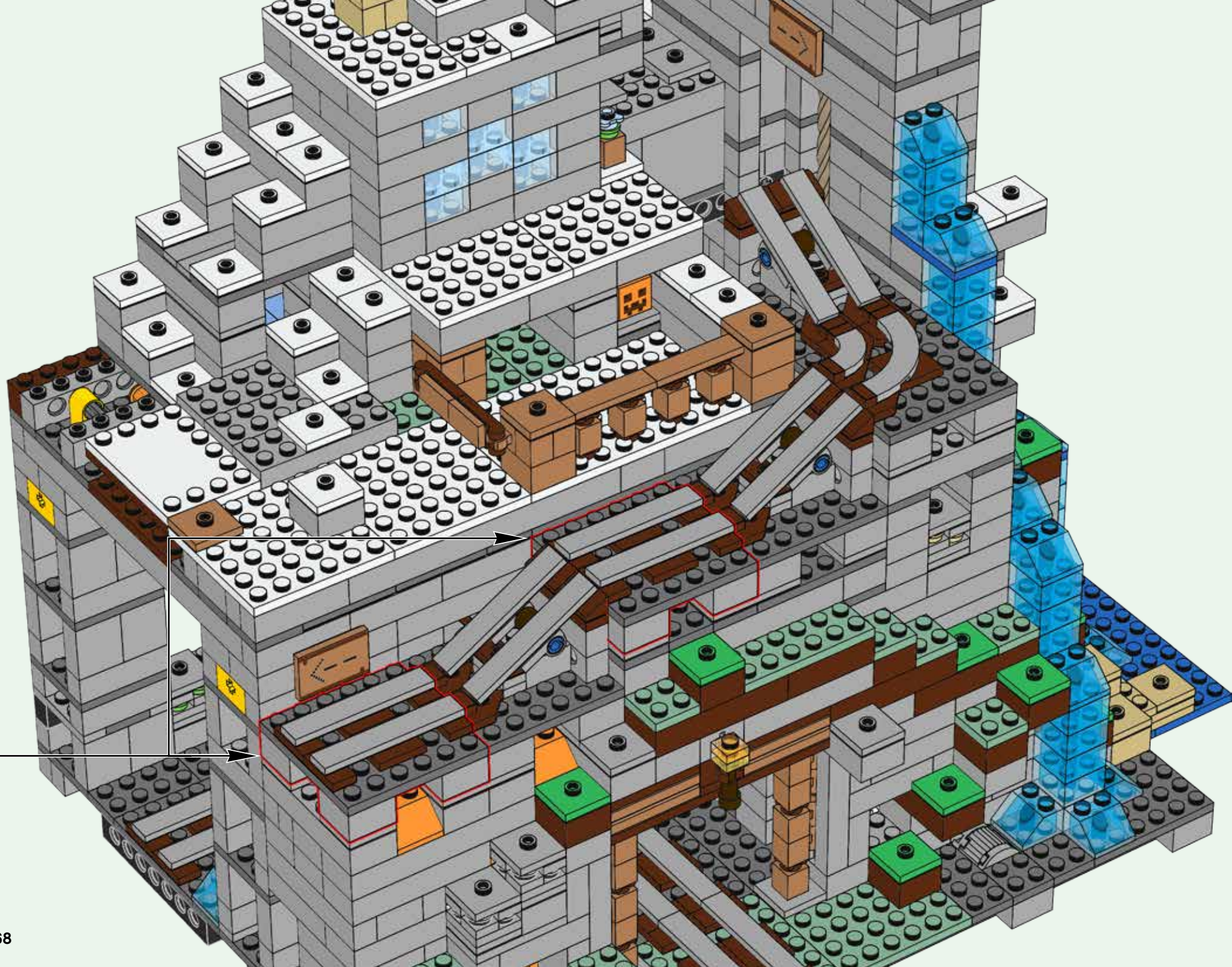

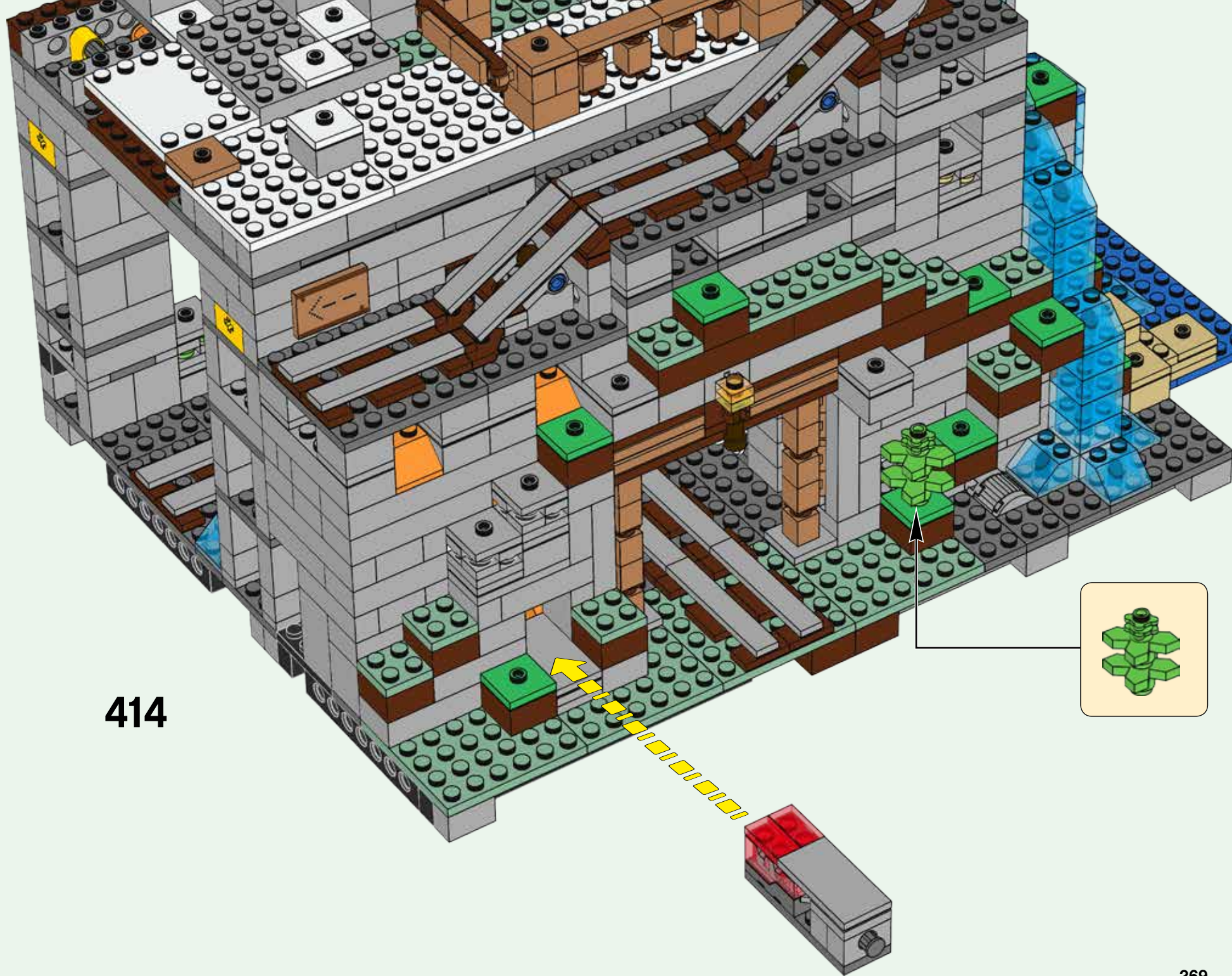

414

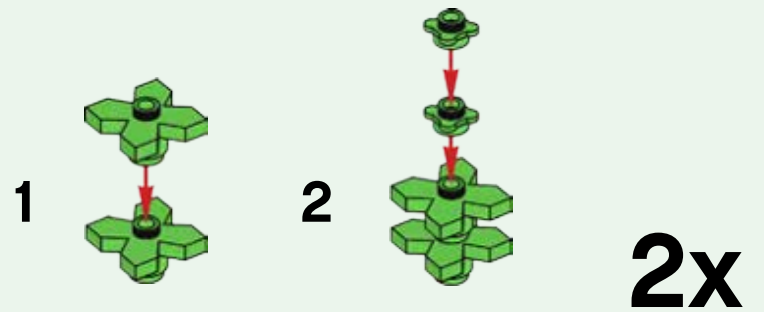
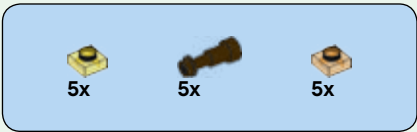
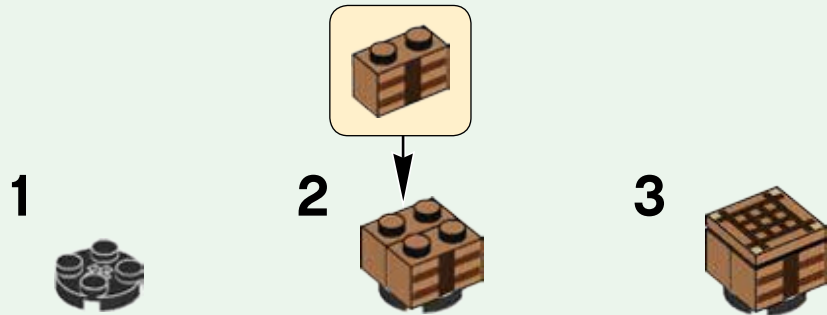
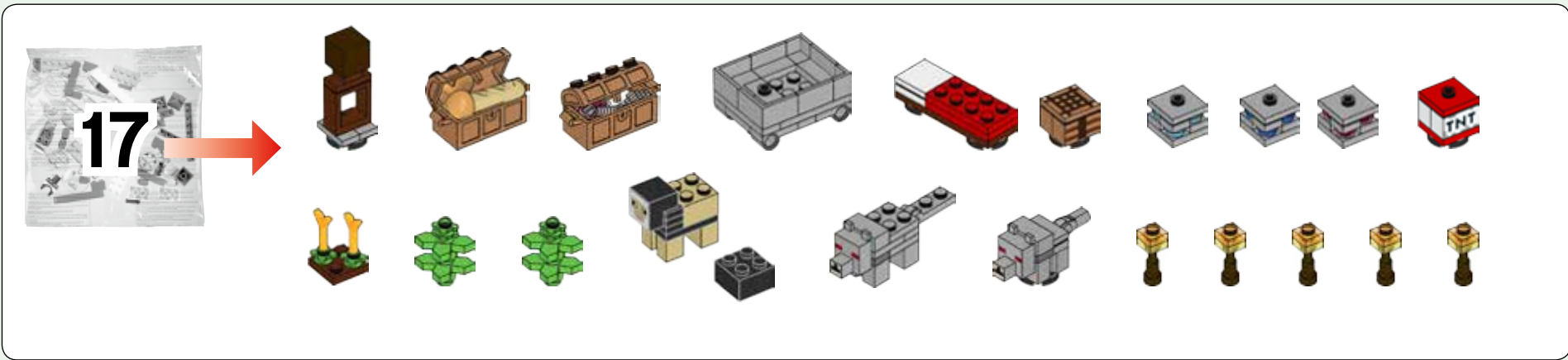



1



2



3



4

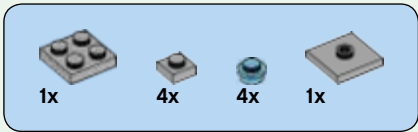

1



2

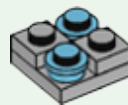

3



4

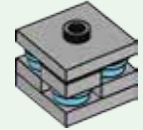

1



2



3



4

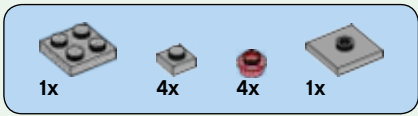
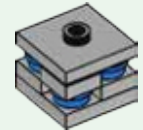

1



2



3



4

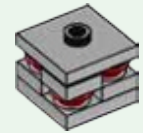

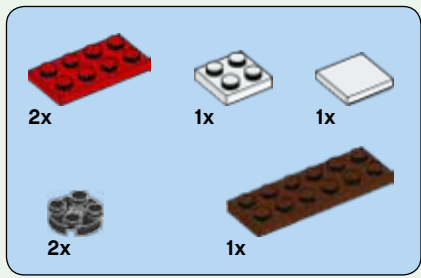

1



2



3

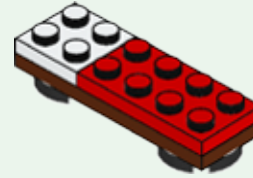
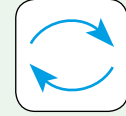

4

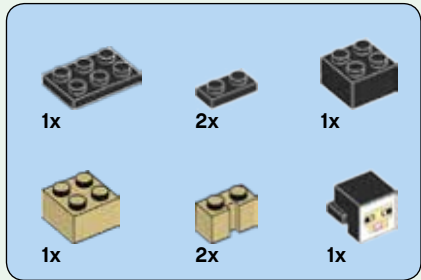
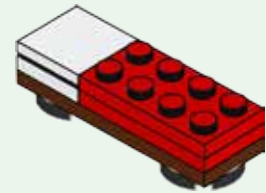

1

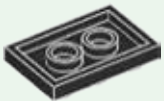

2

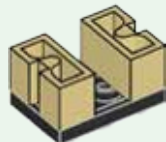

3

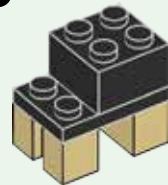
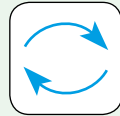

4

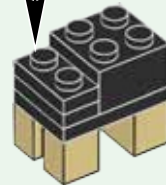
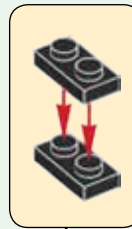

5

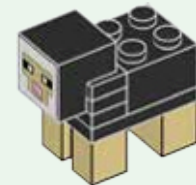
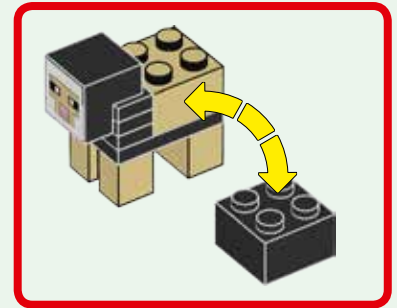

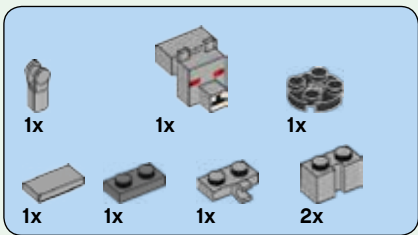

1



2



3



4

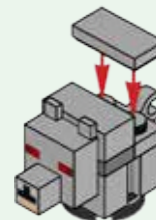

5

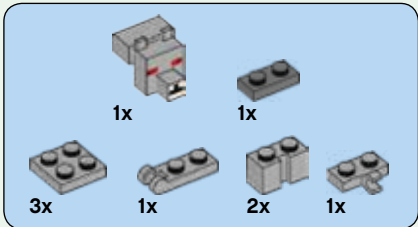
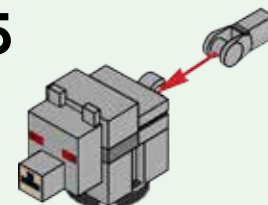

1

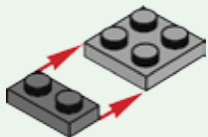

2



3

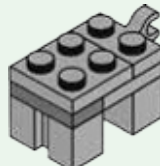

4

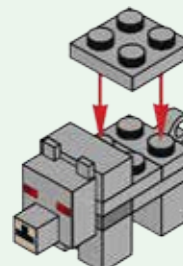

5

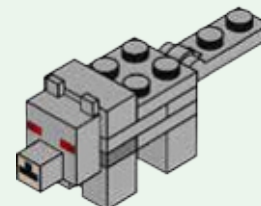

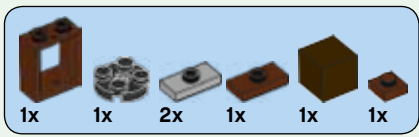

1



2



3

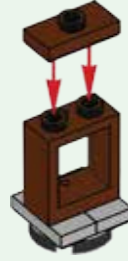

4



1



2



3

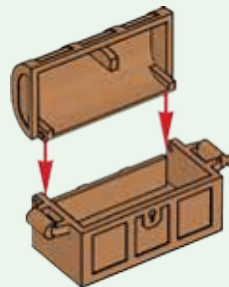
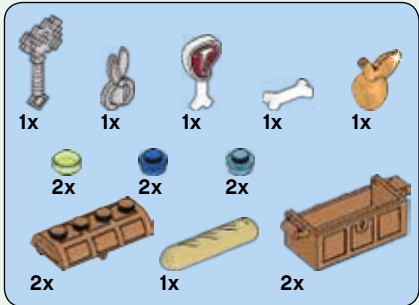

2x

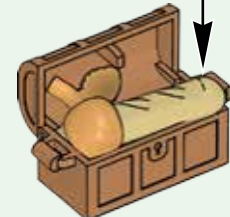
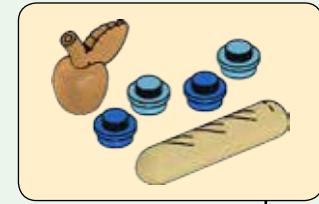

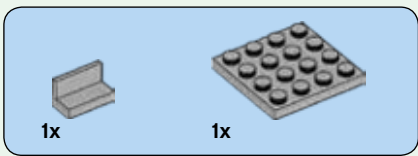

415

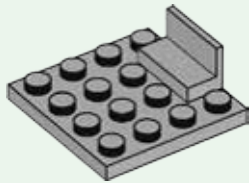

416

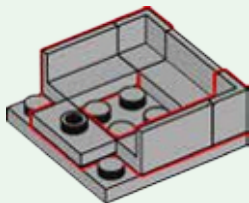

417

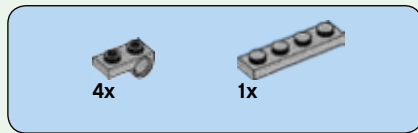
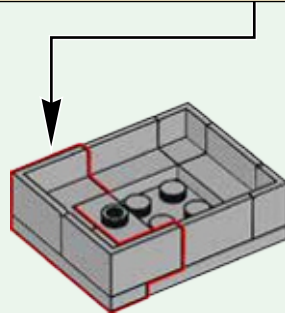
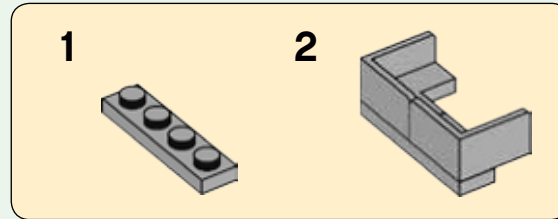

418

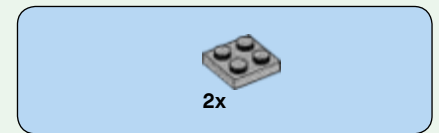
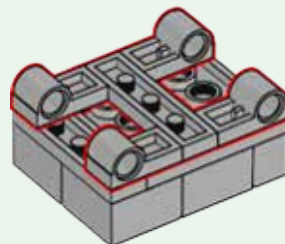
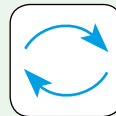

419

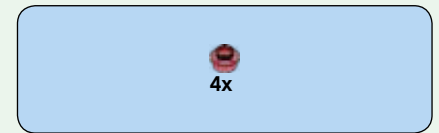
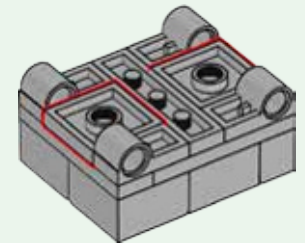

420

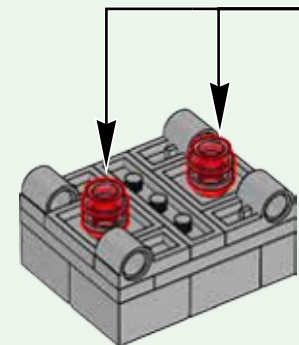
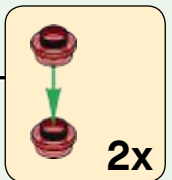

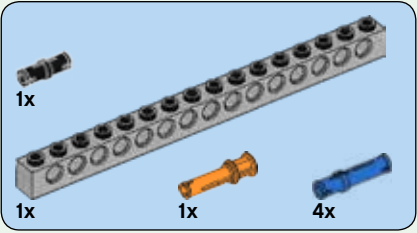
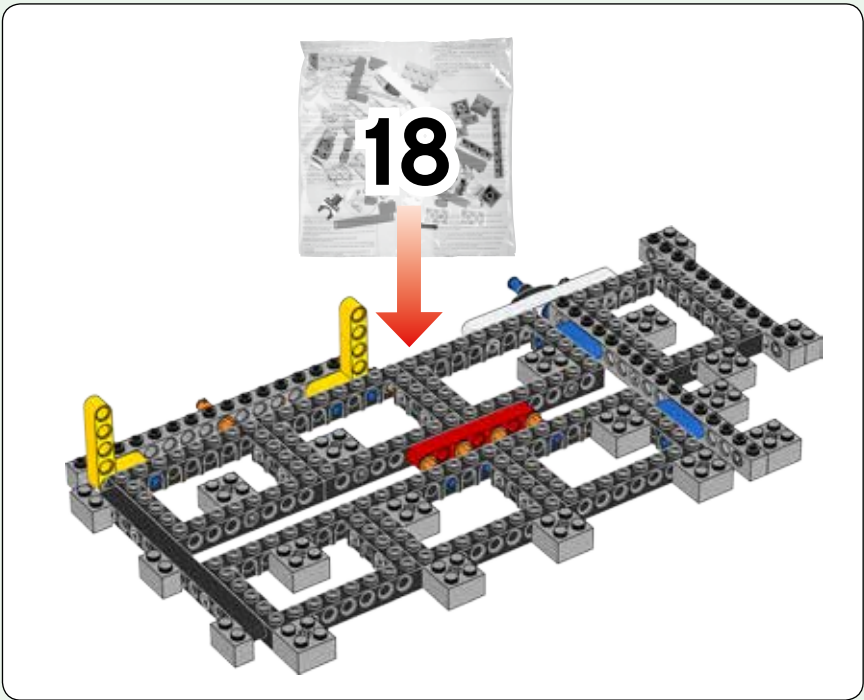
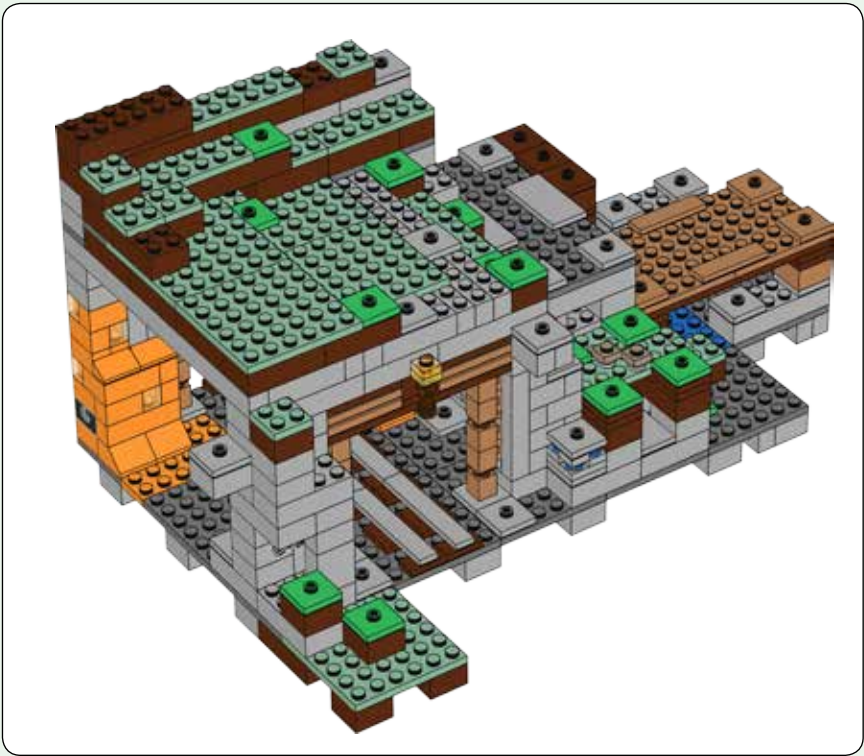

421

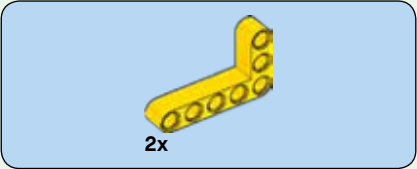
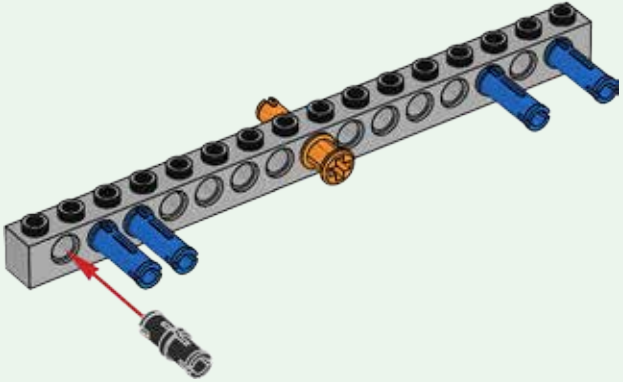

422

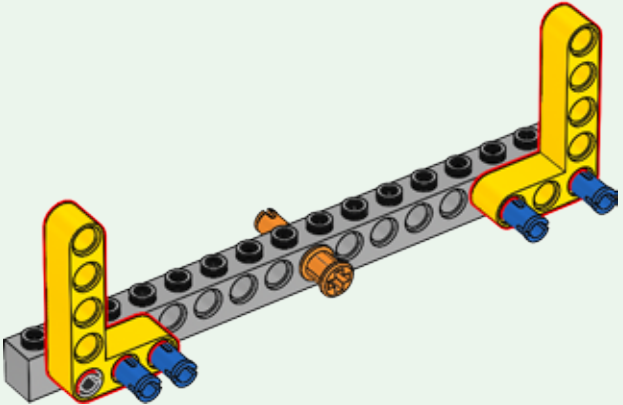

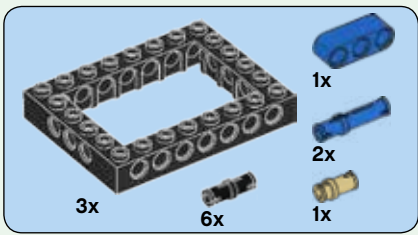

423

1

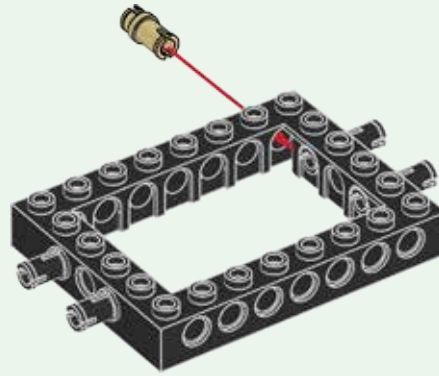

2

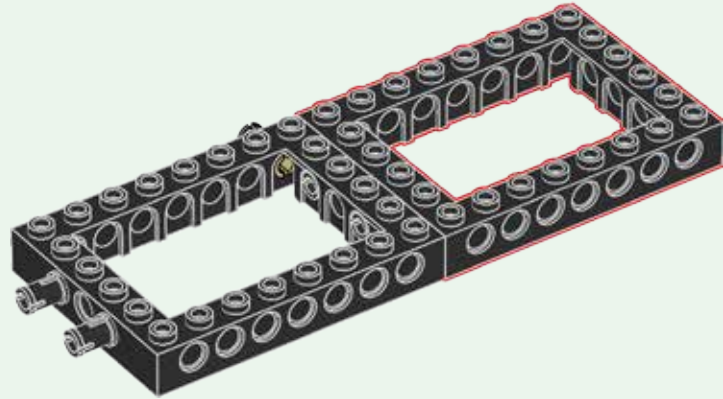

3

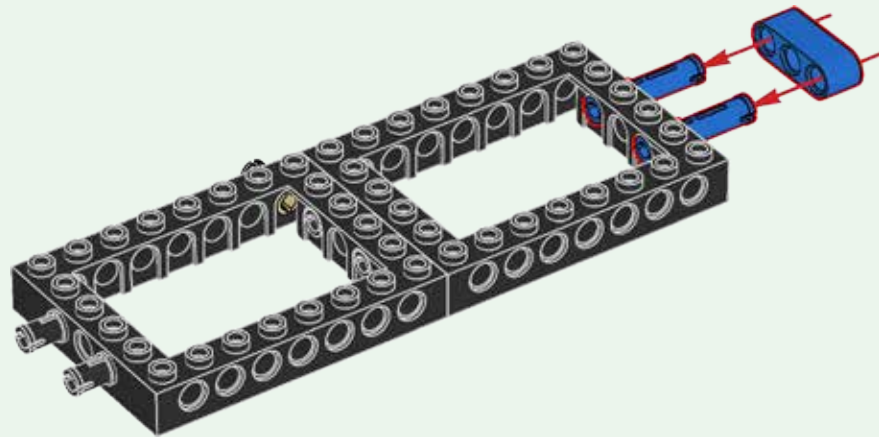

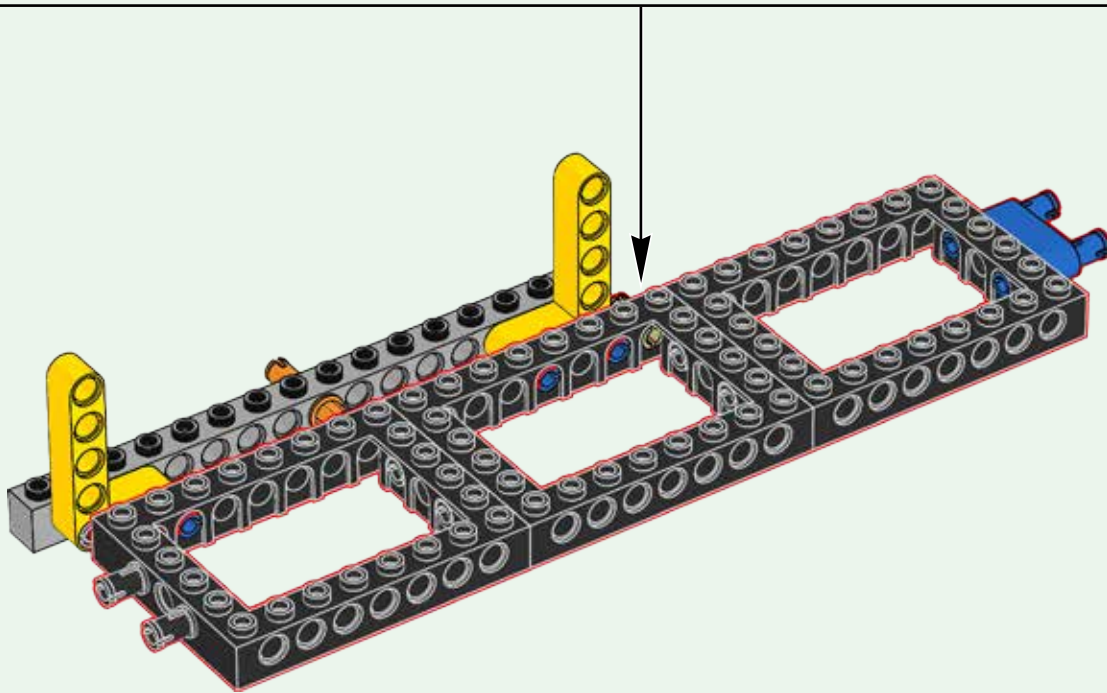
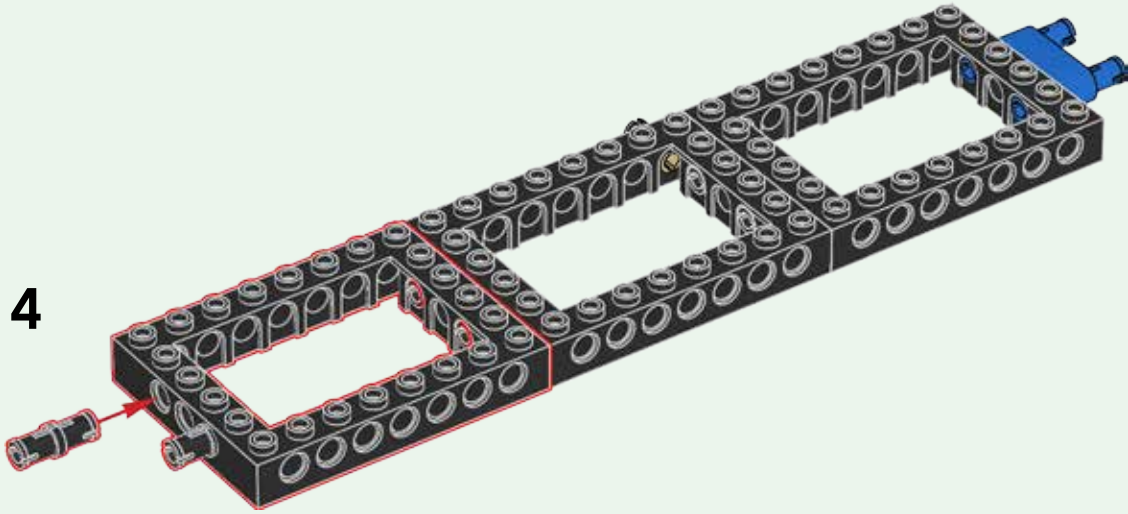

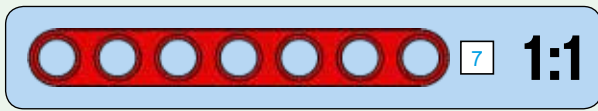
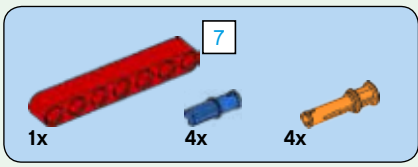

424

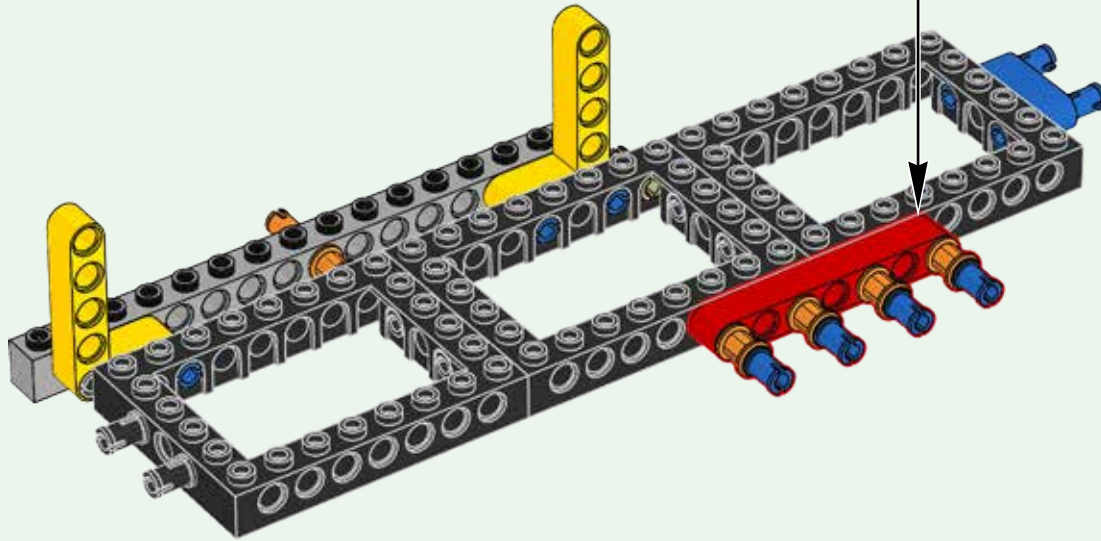
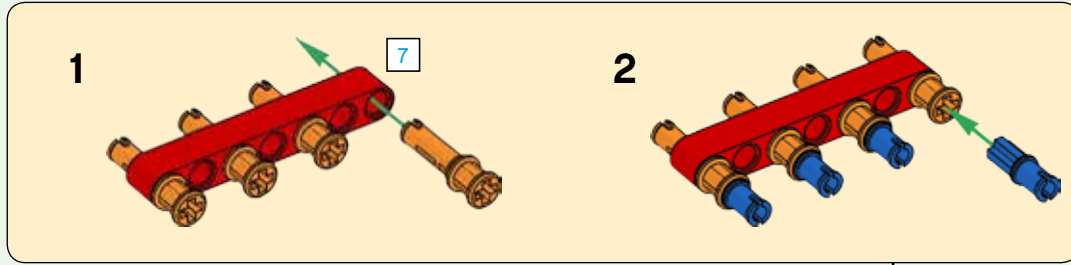

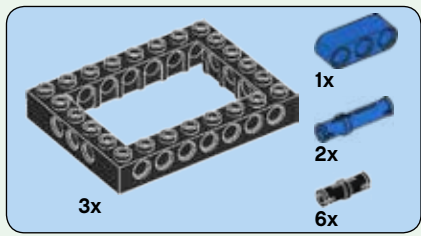

425

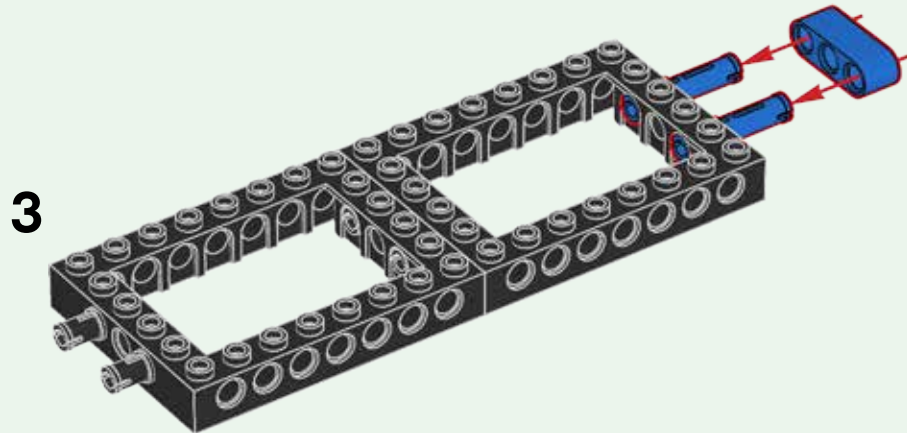
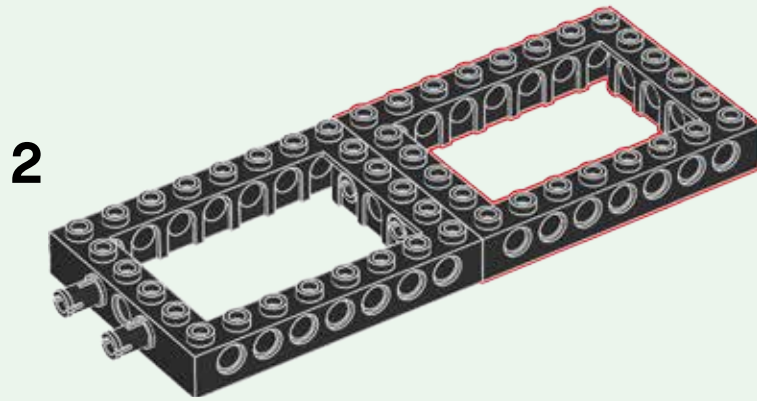
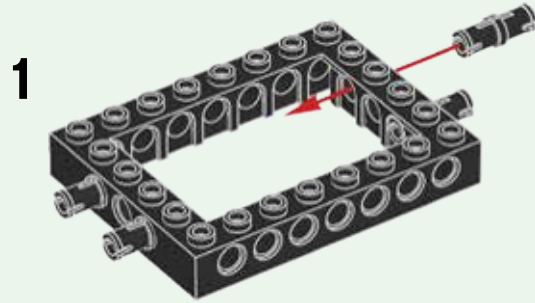

4

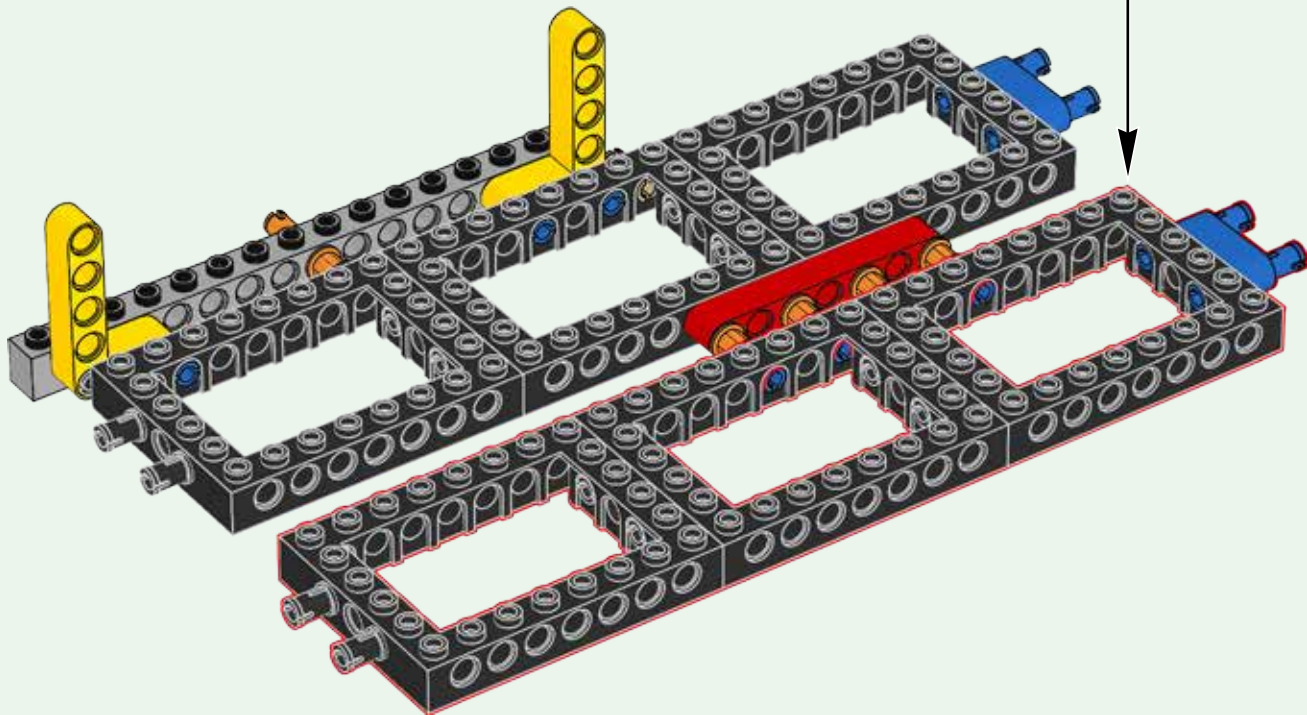
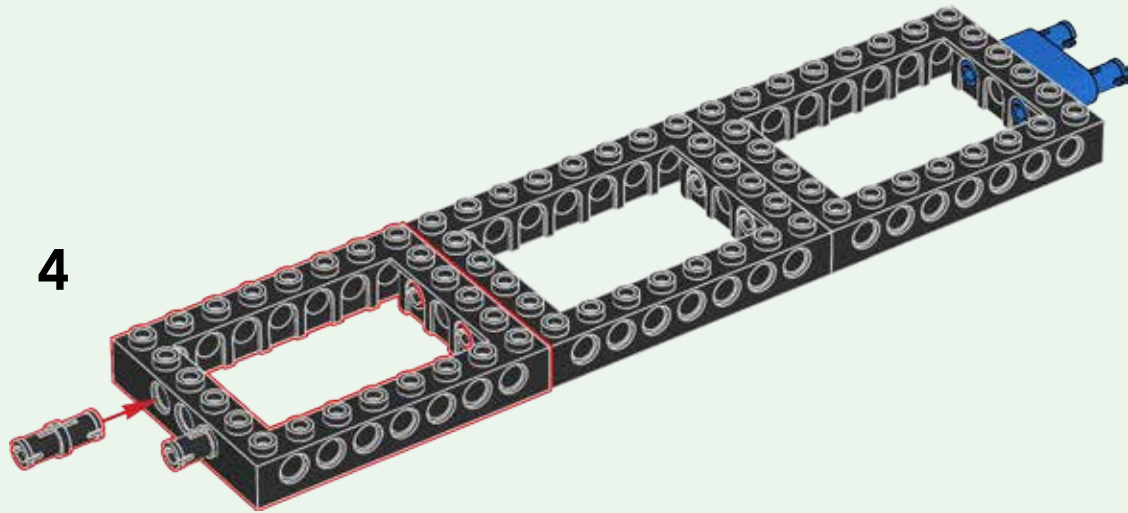

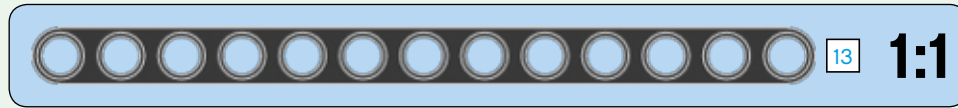
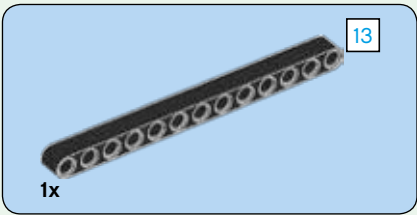

426

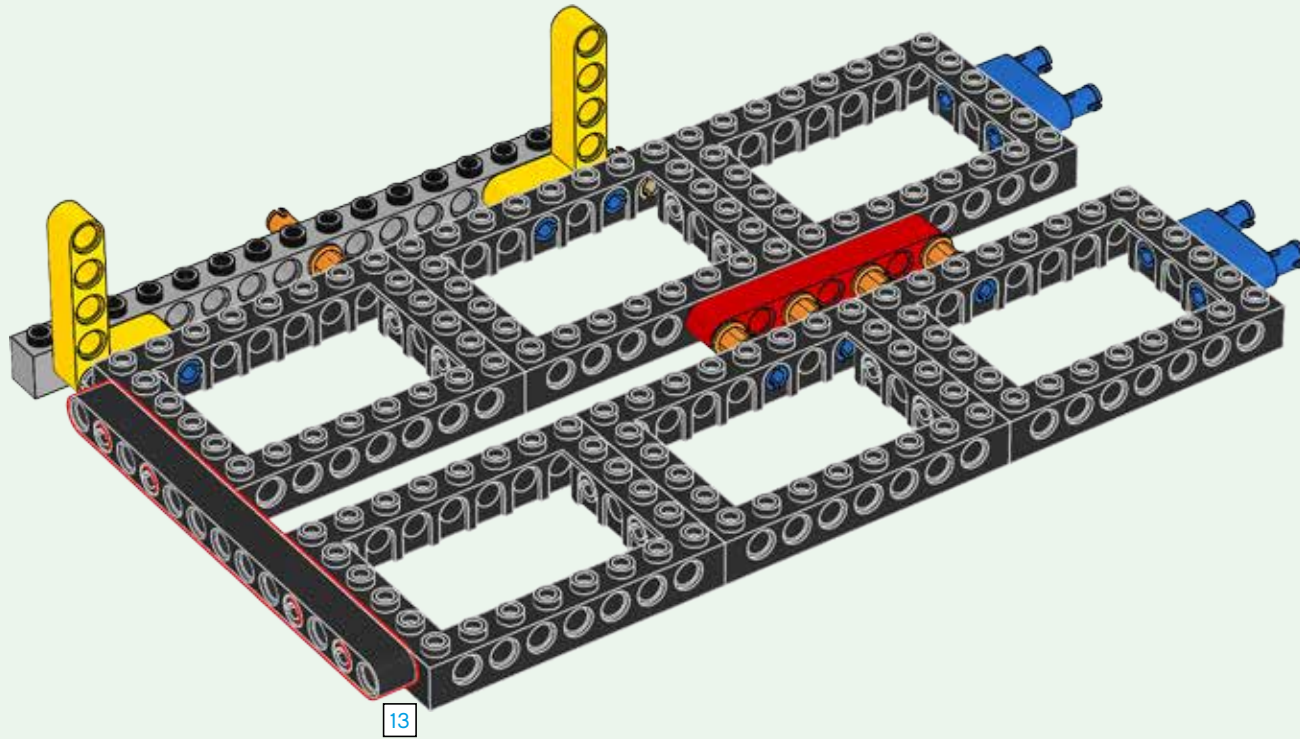

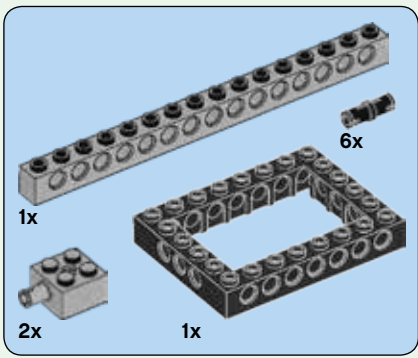

427

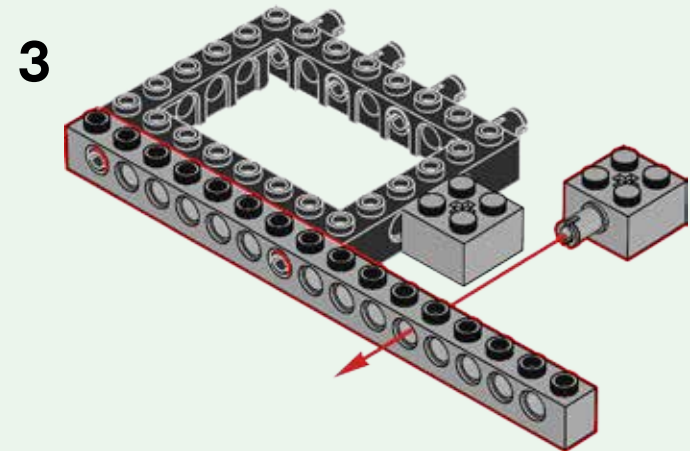
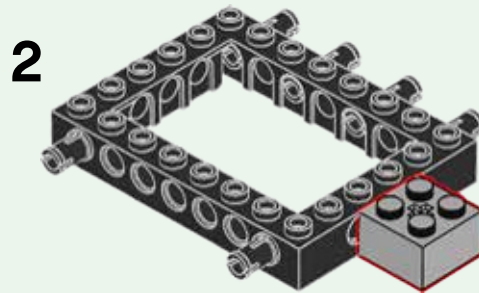
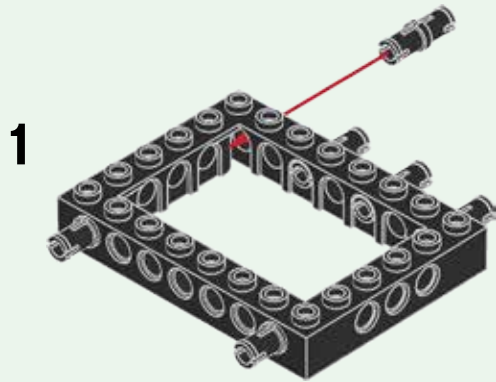

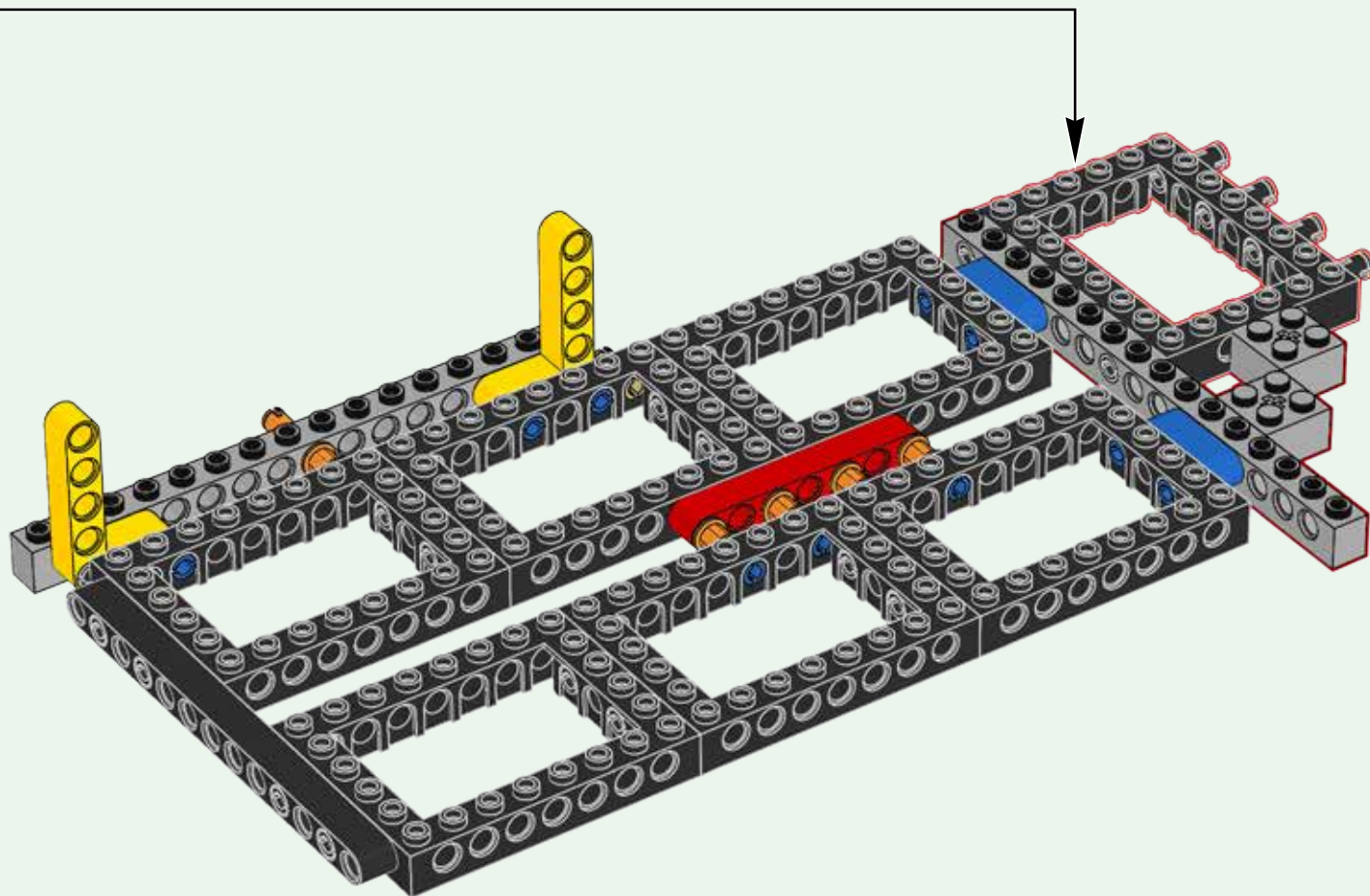

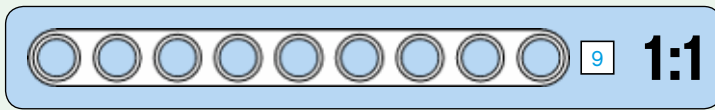
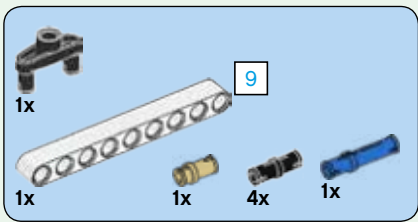

428

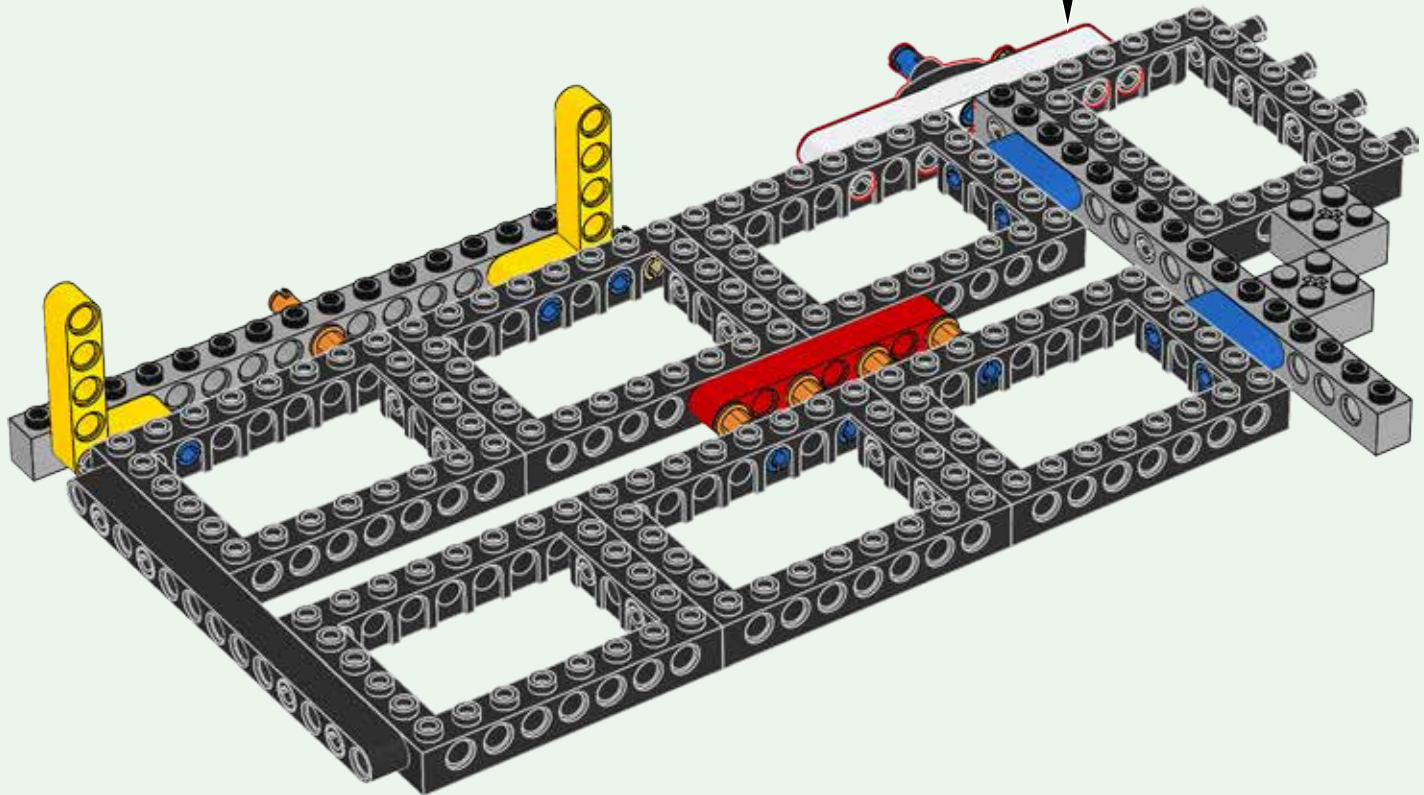
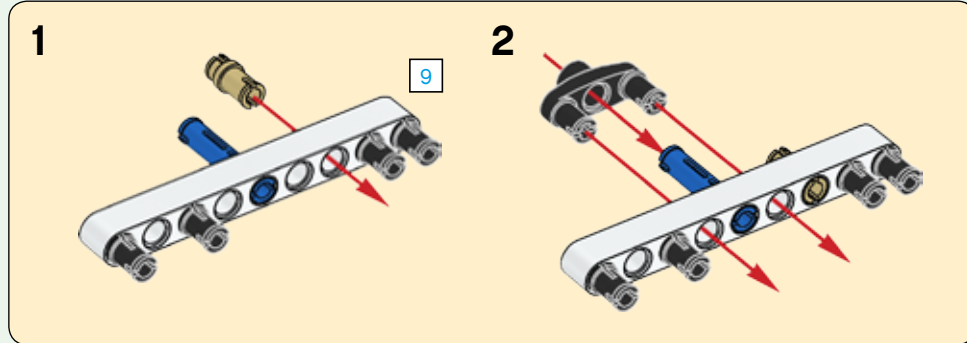

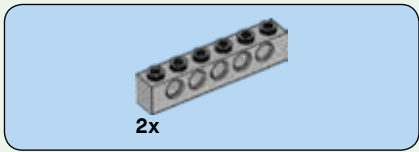

429

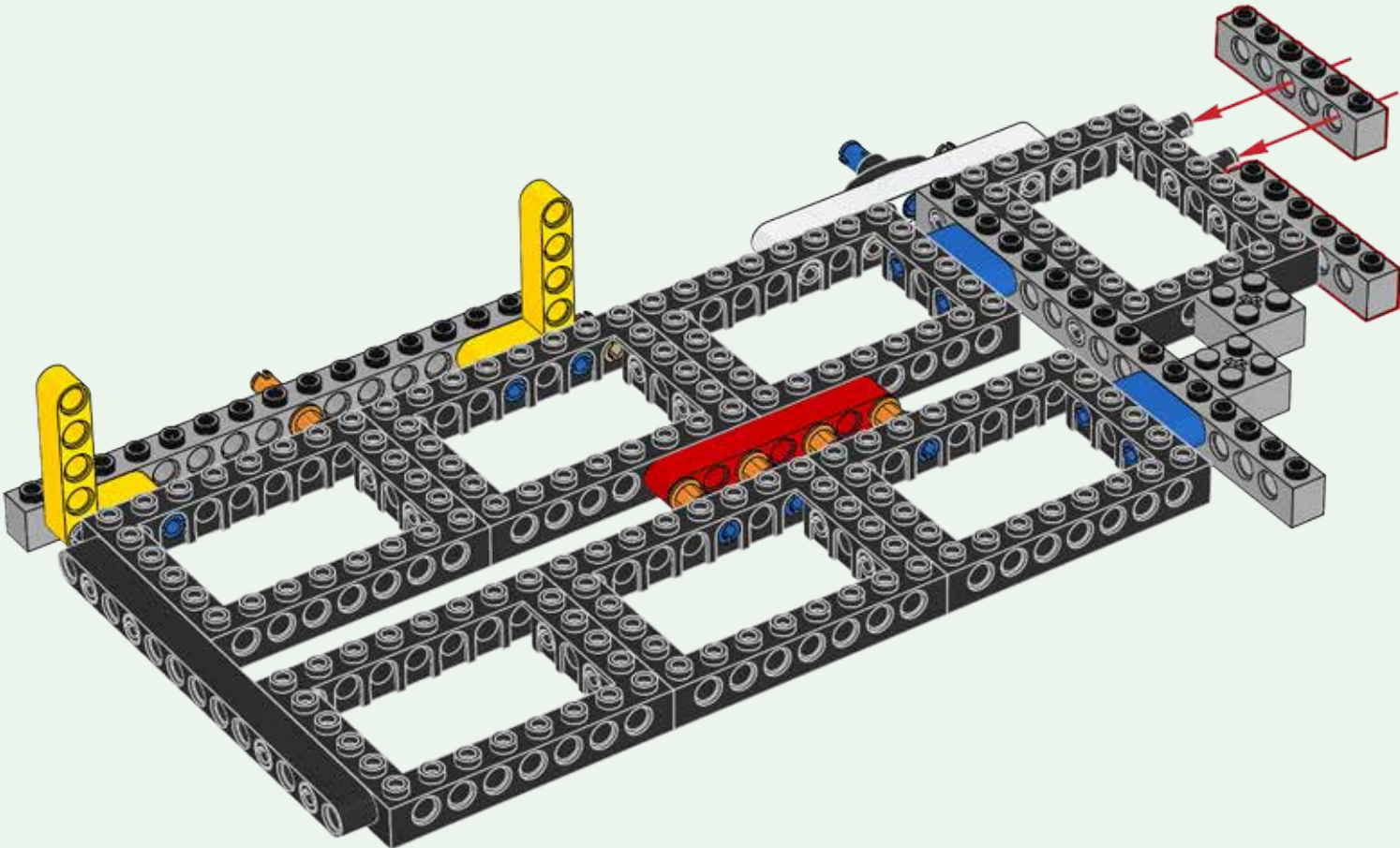

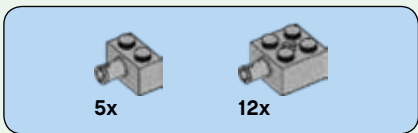

430

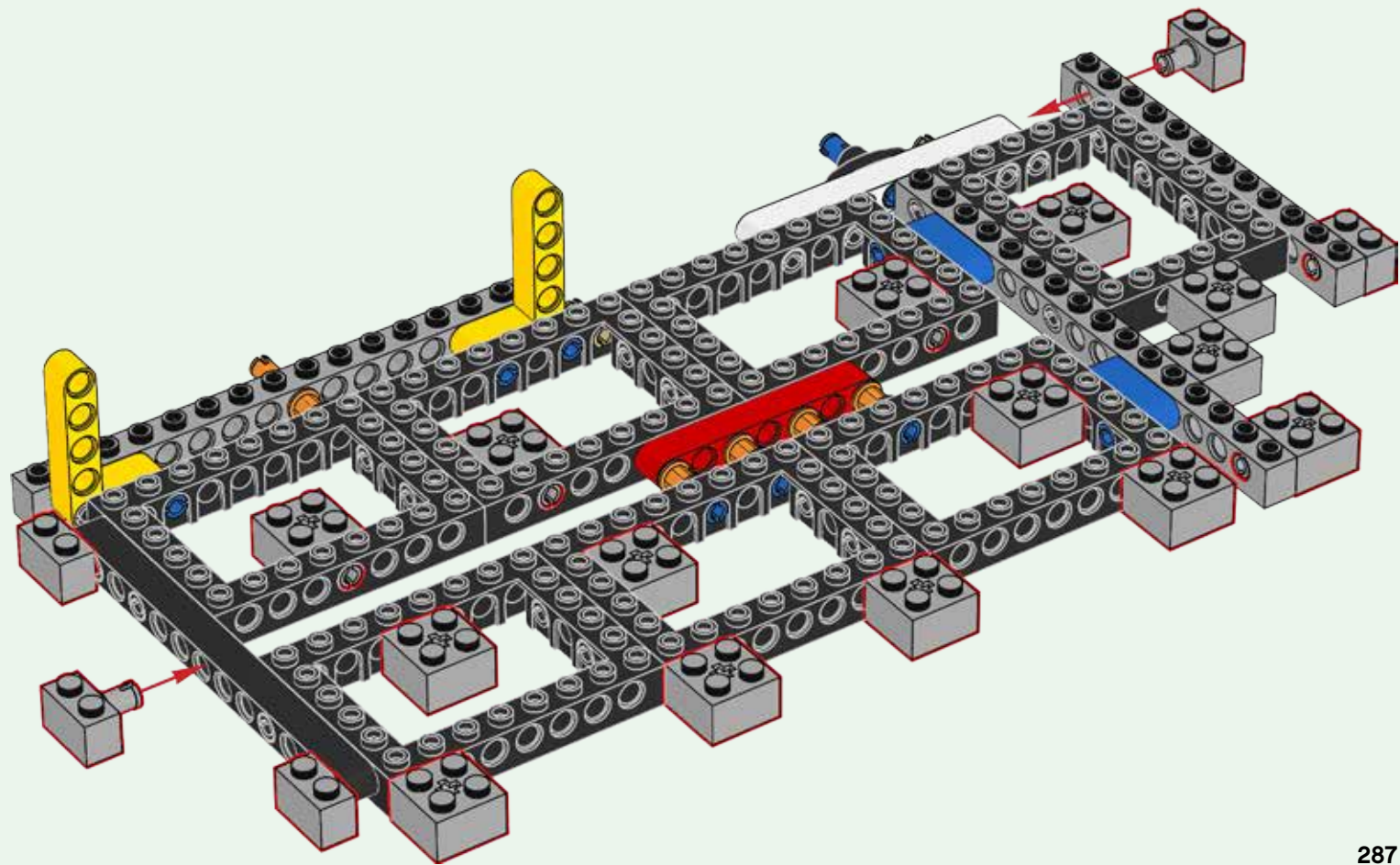

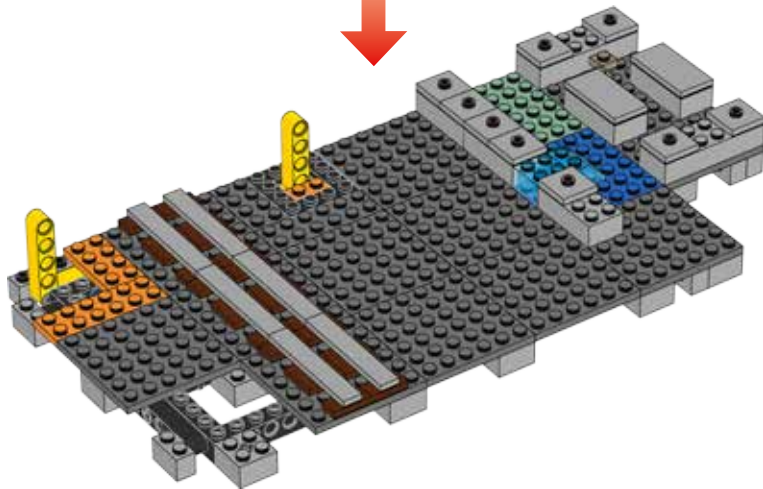

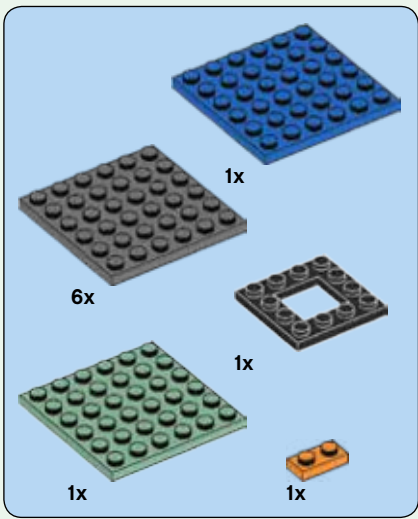

431

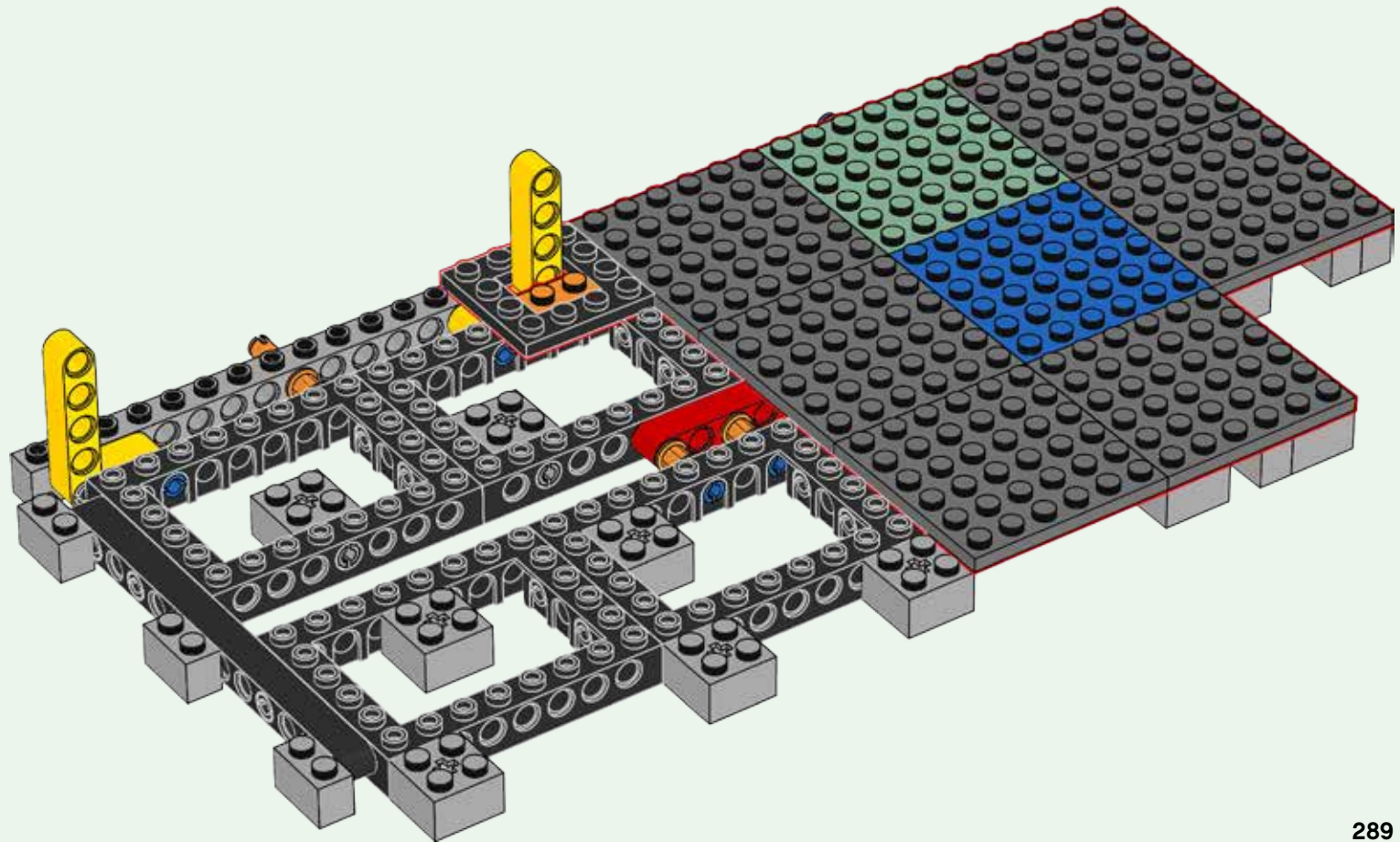

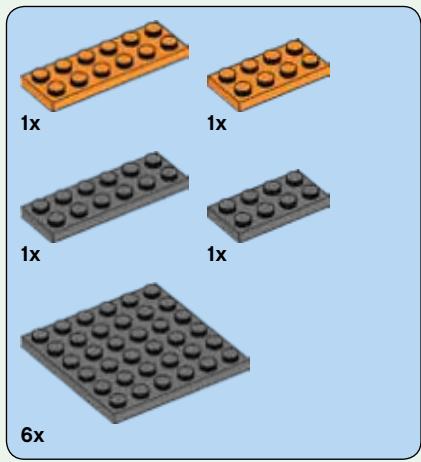

432

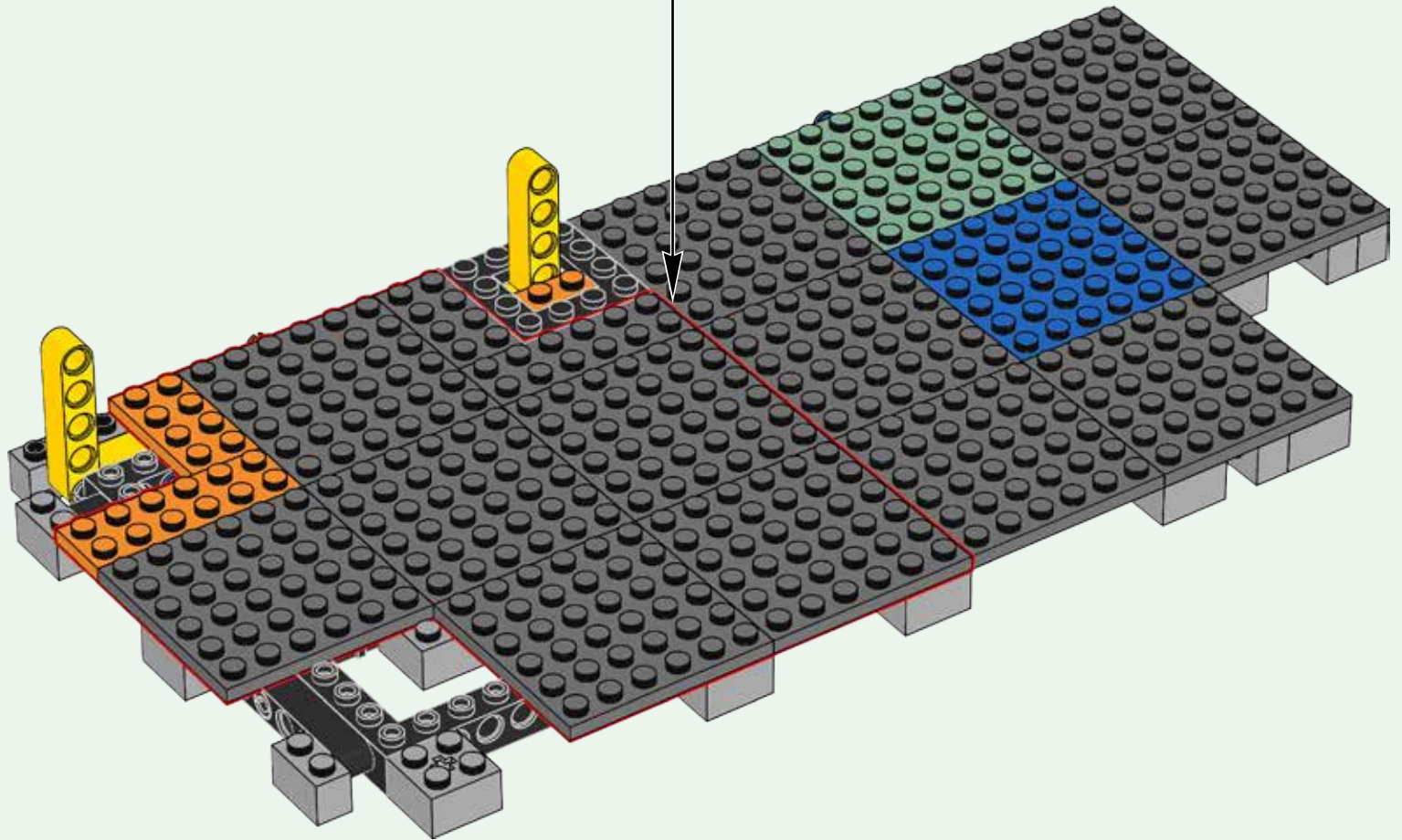
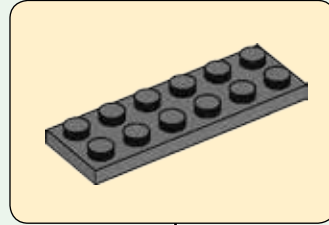

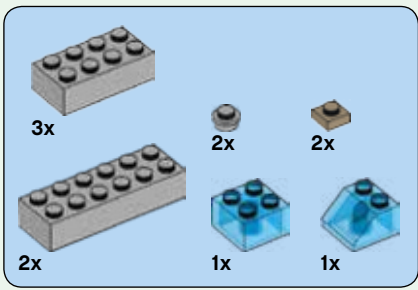

433

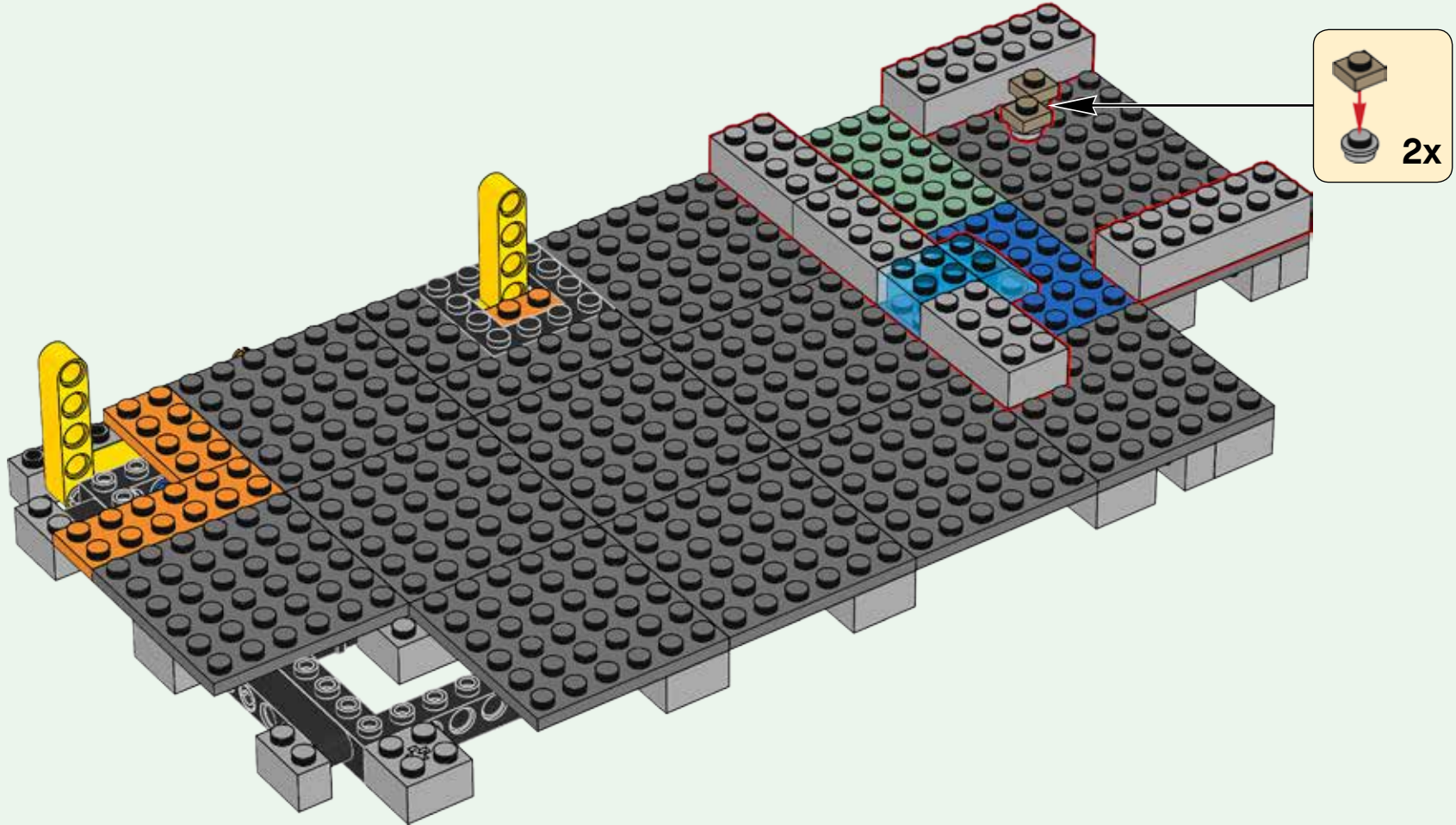

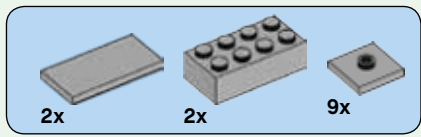

434

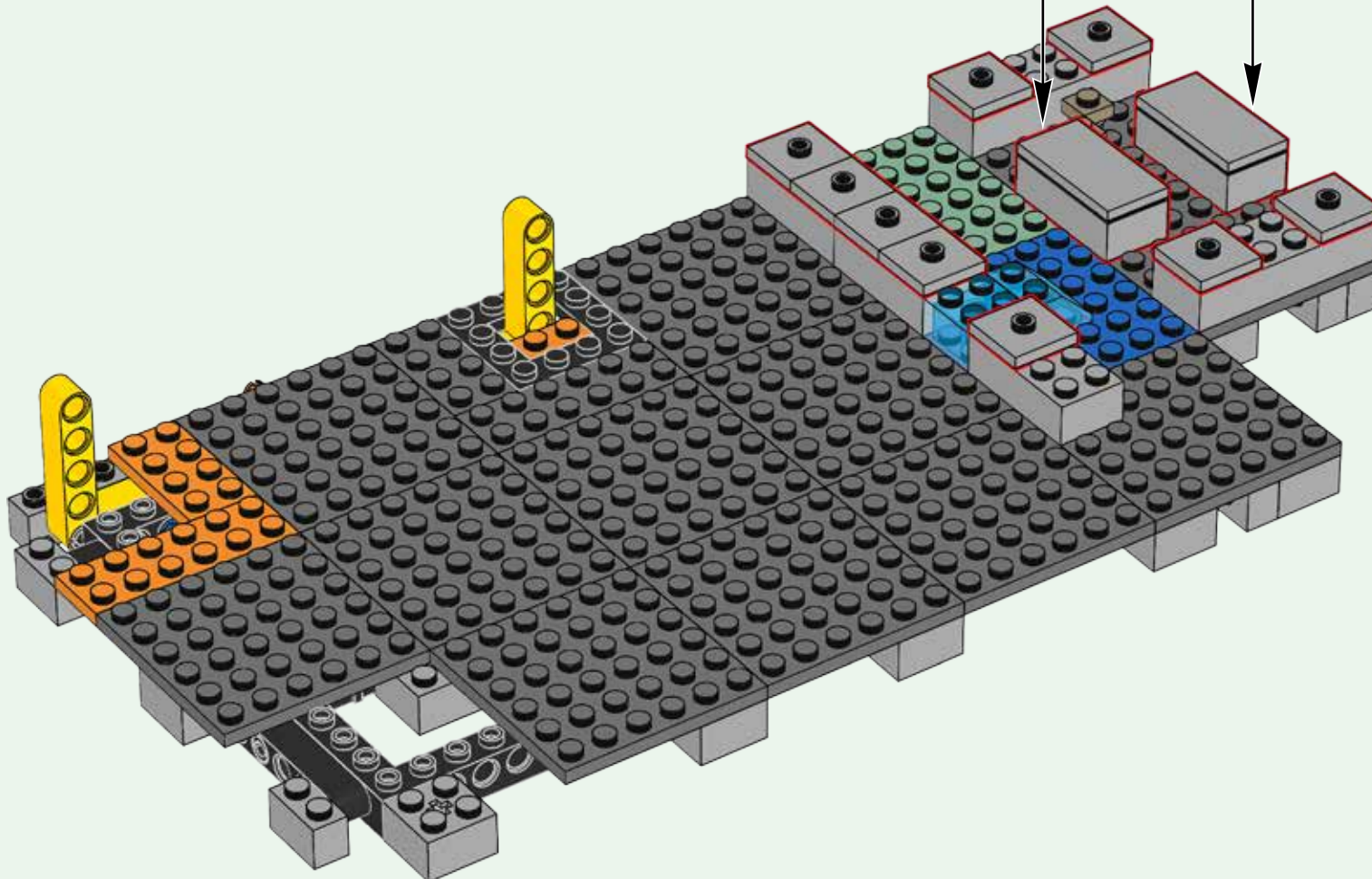
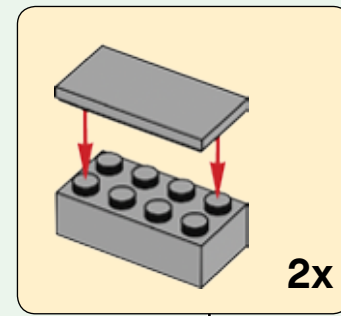

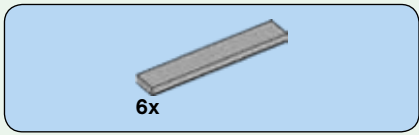

436

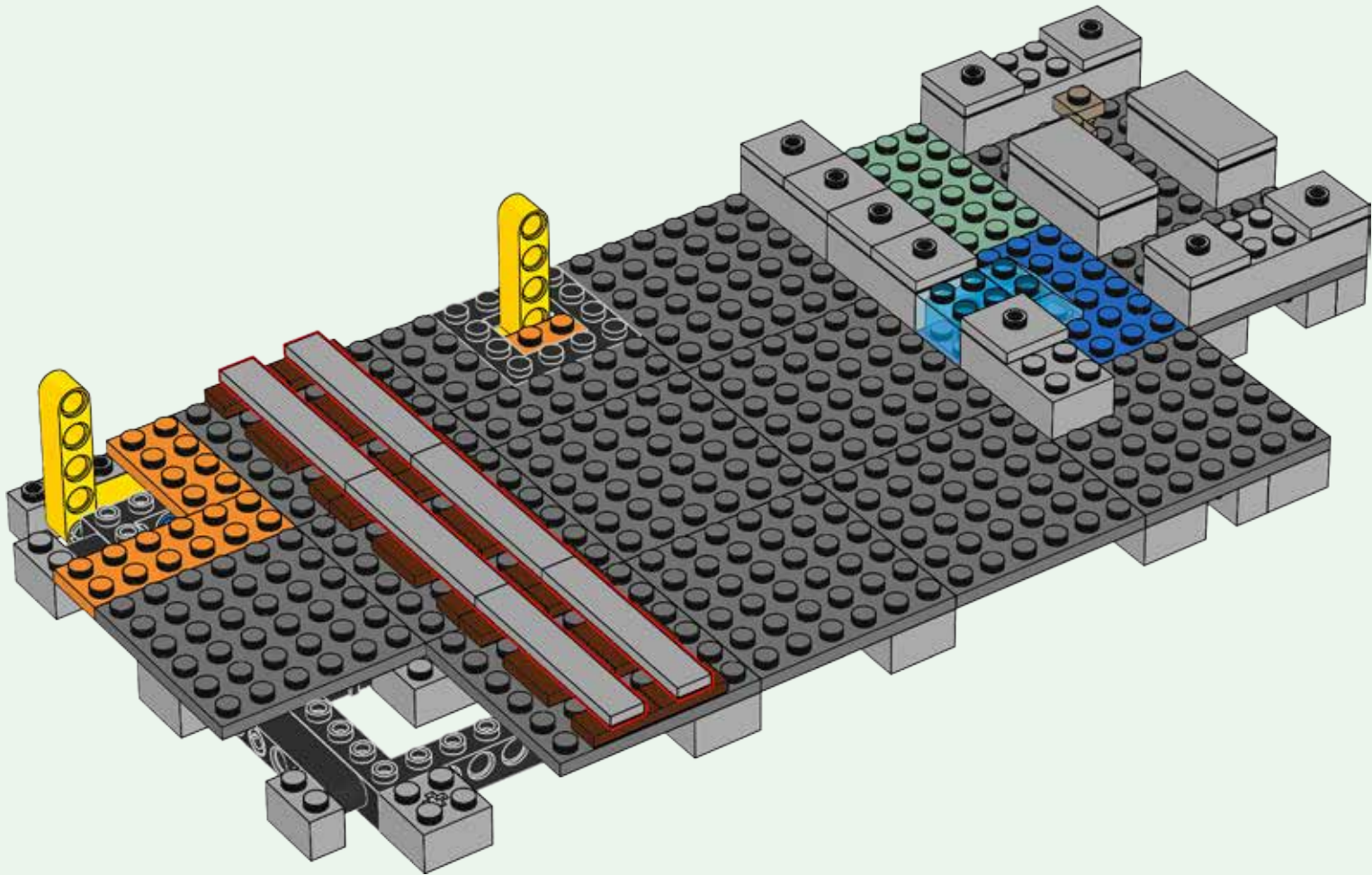

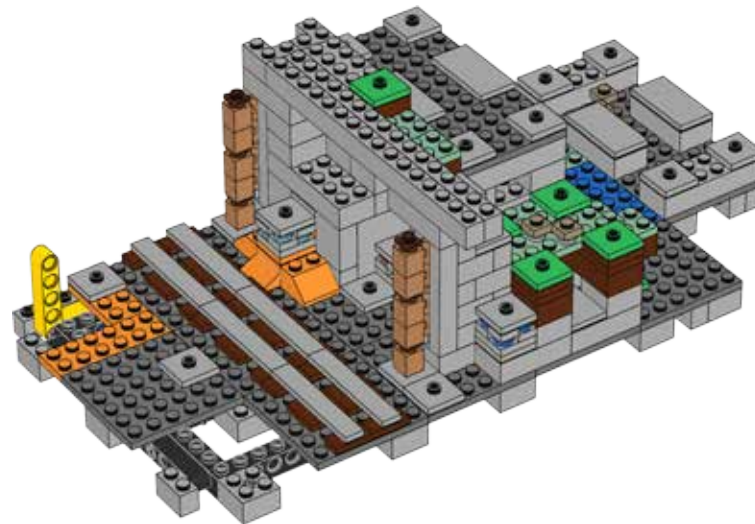

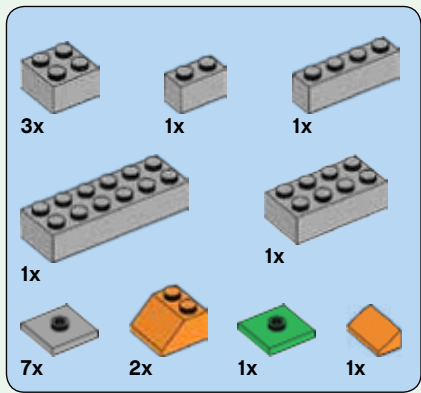

437

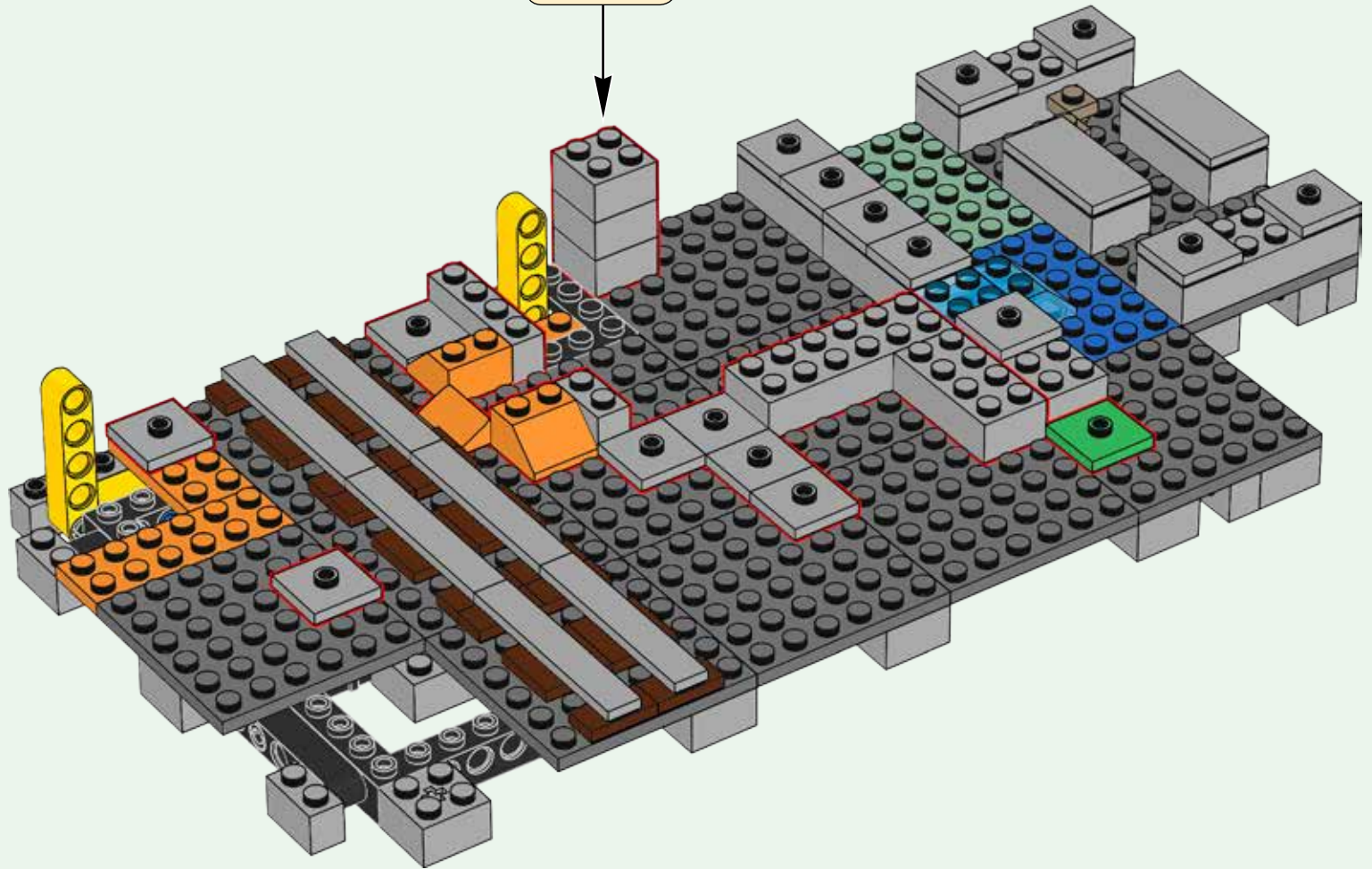
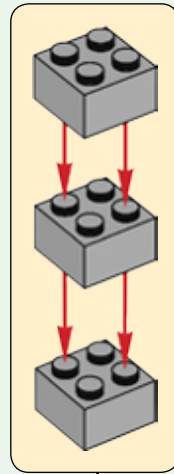

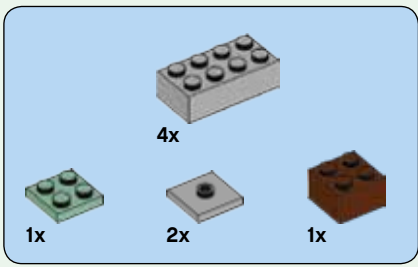

438

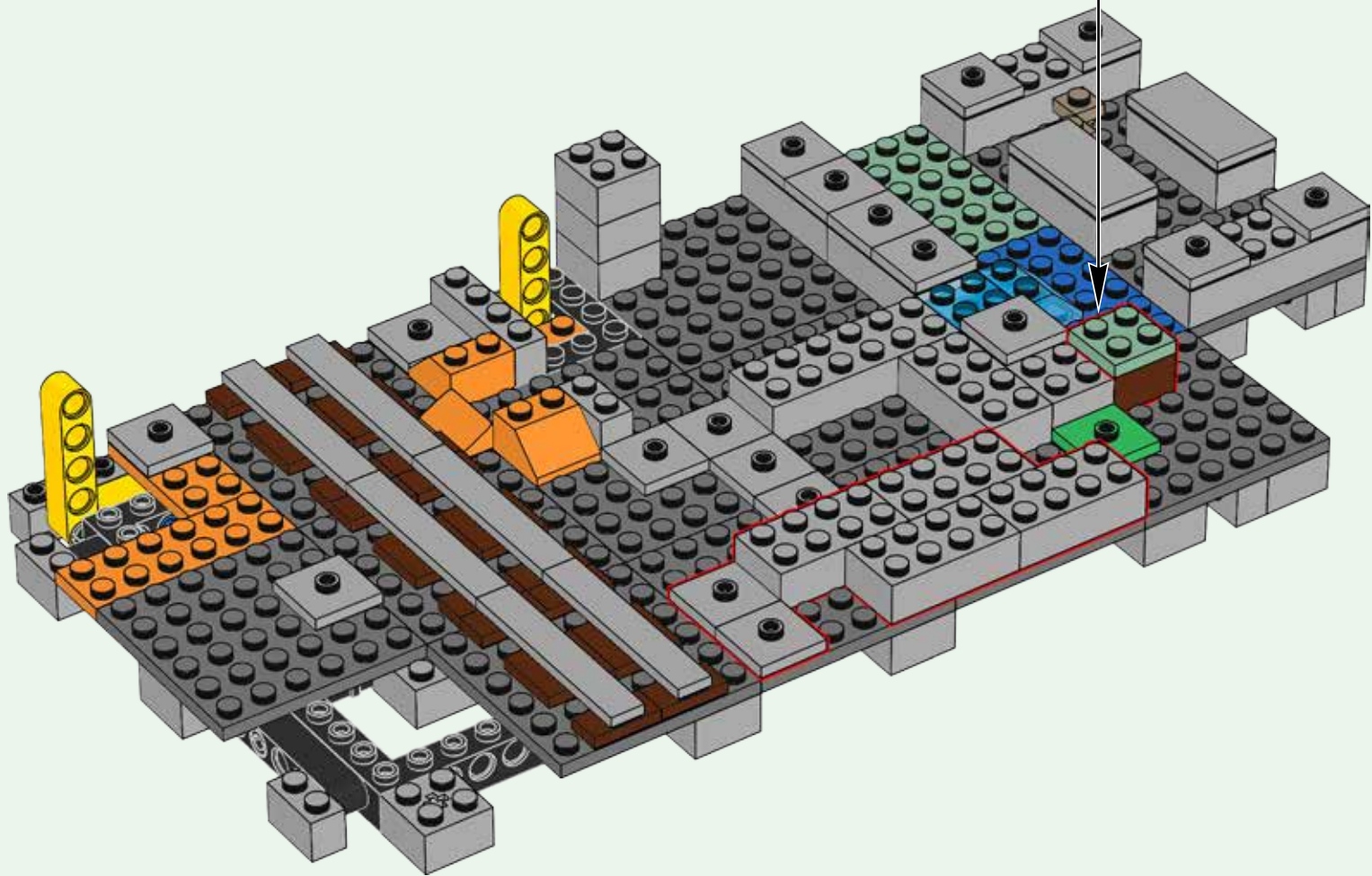
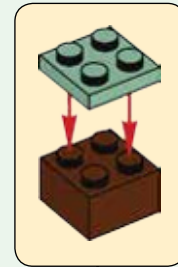

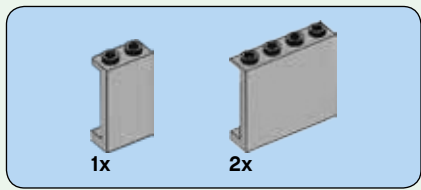

439

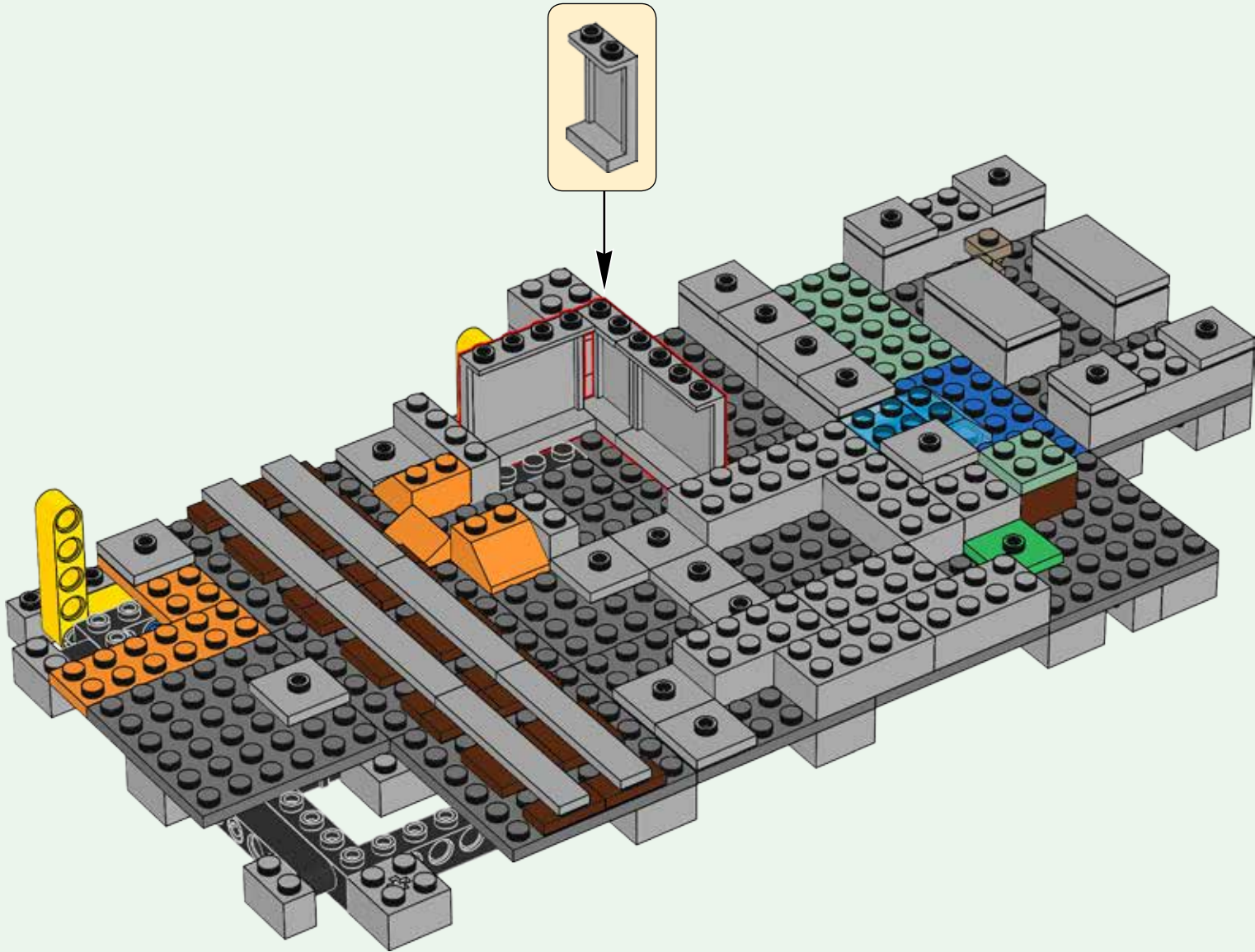



440

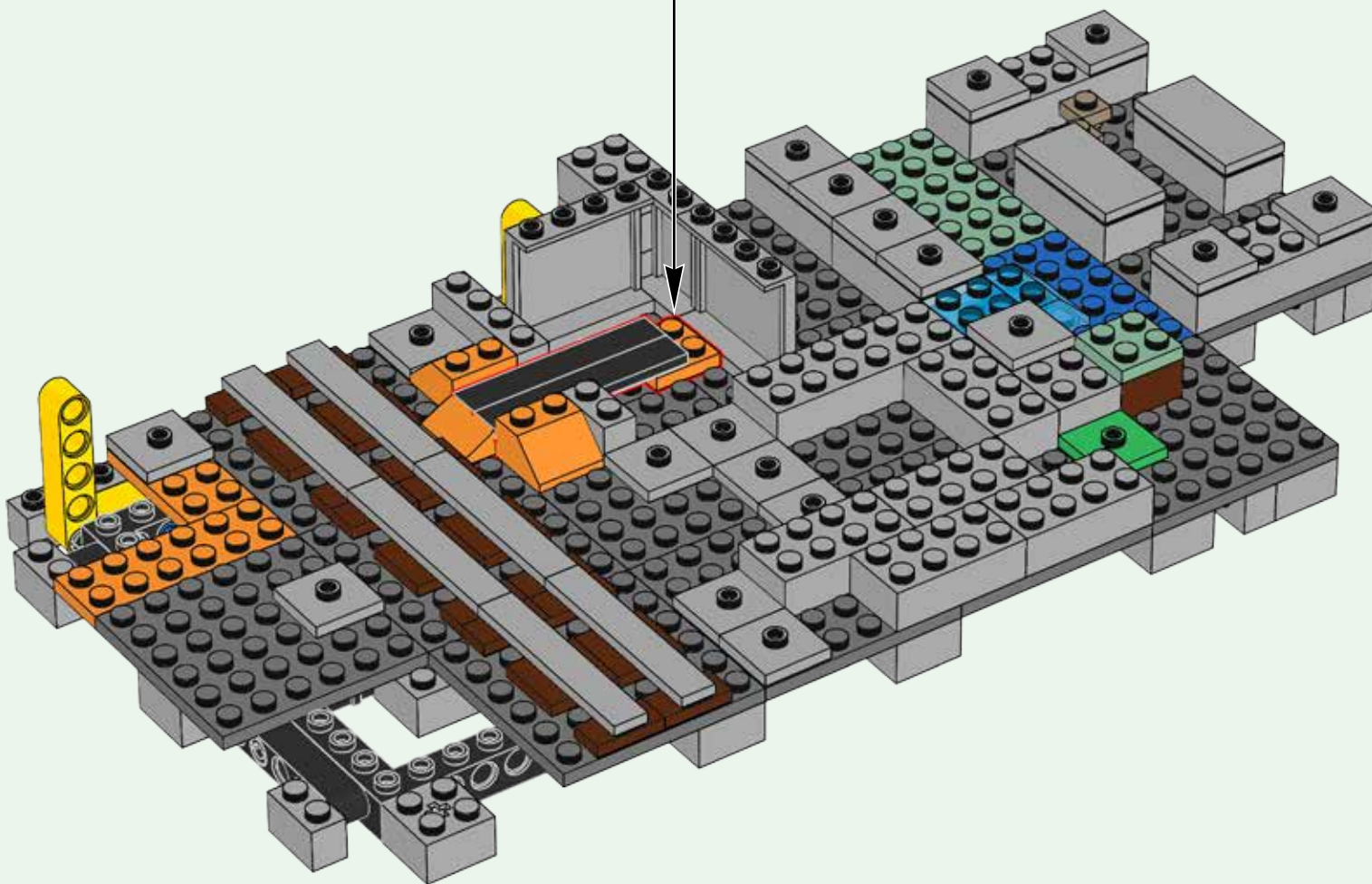
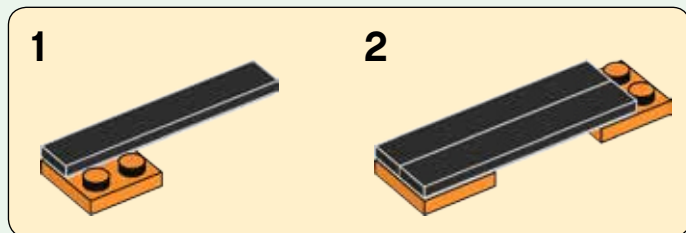

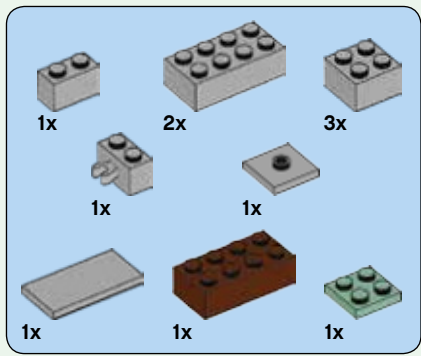

441

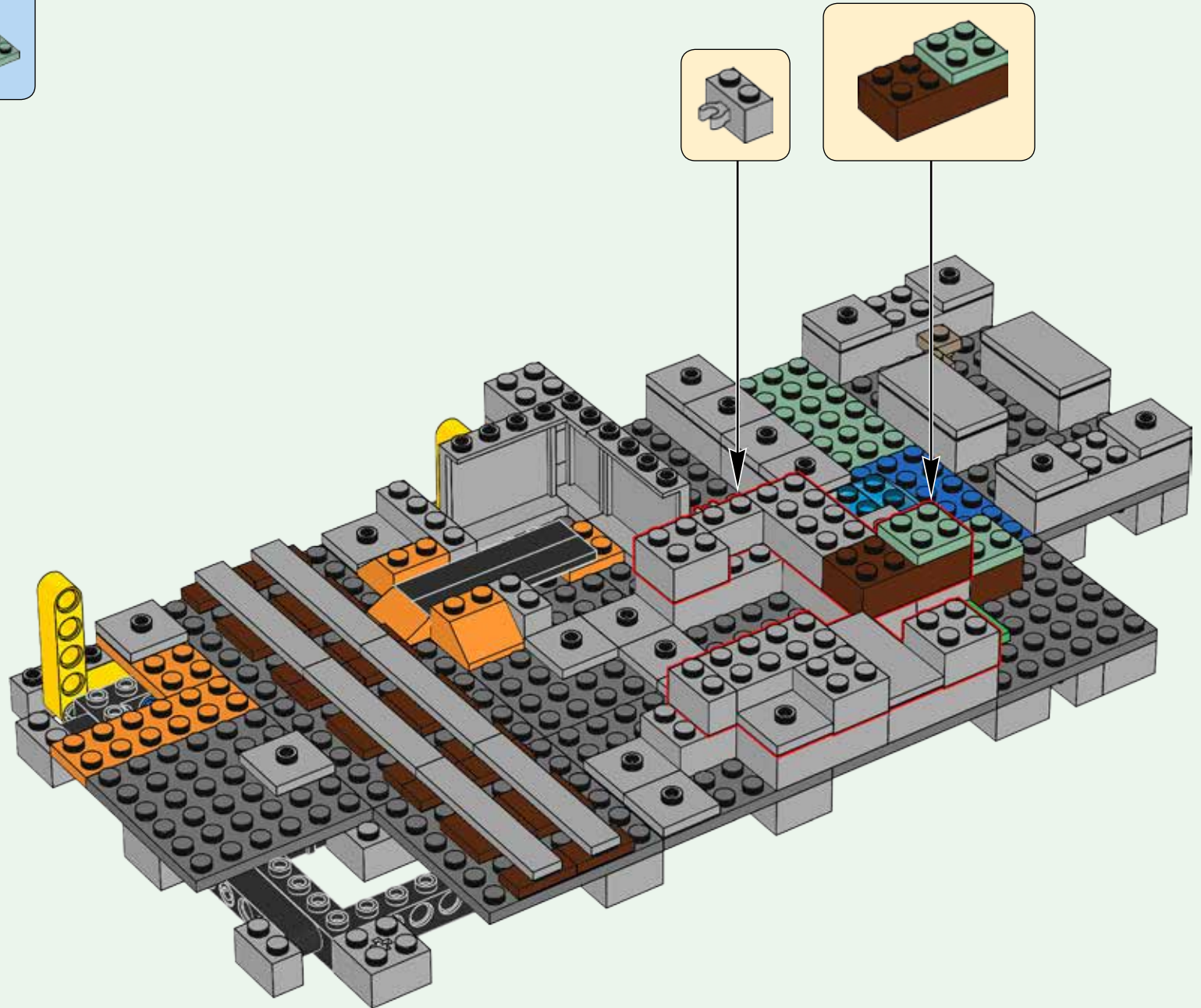

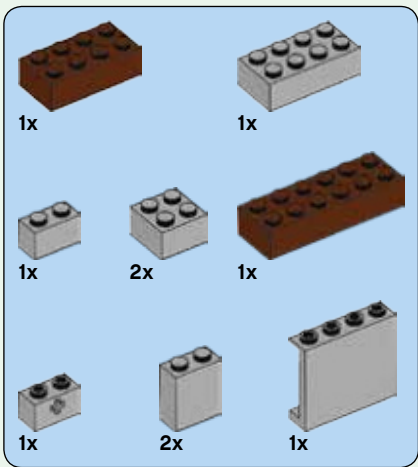

442

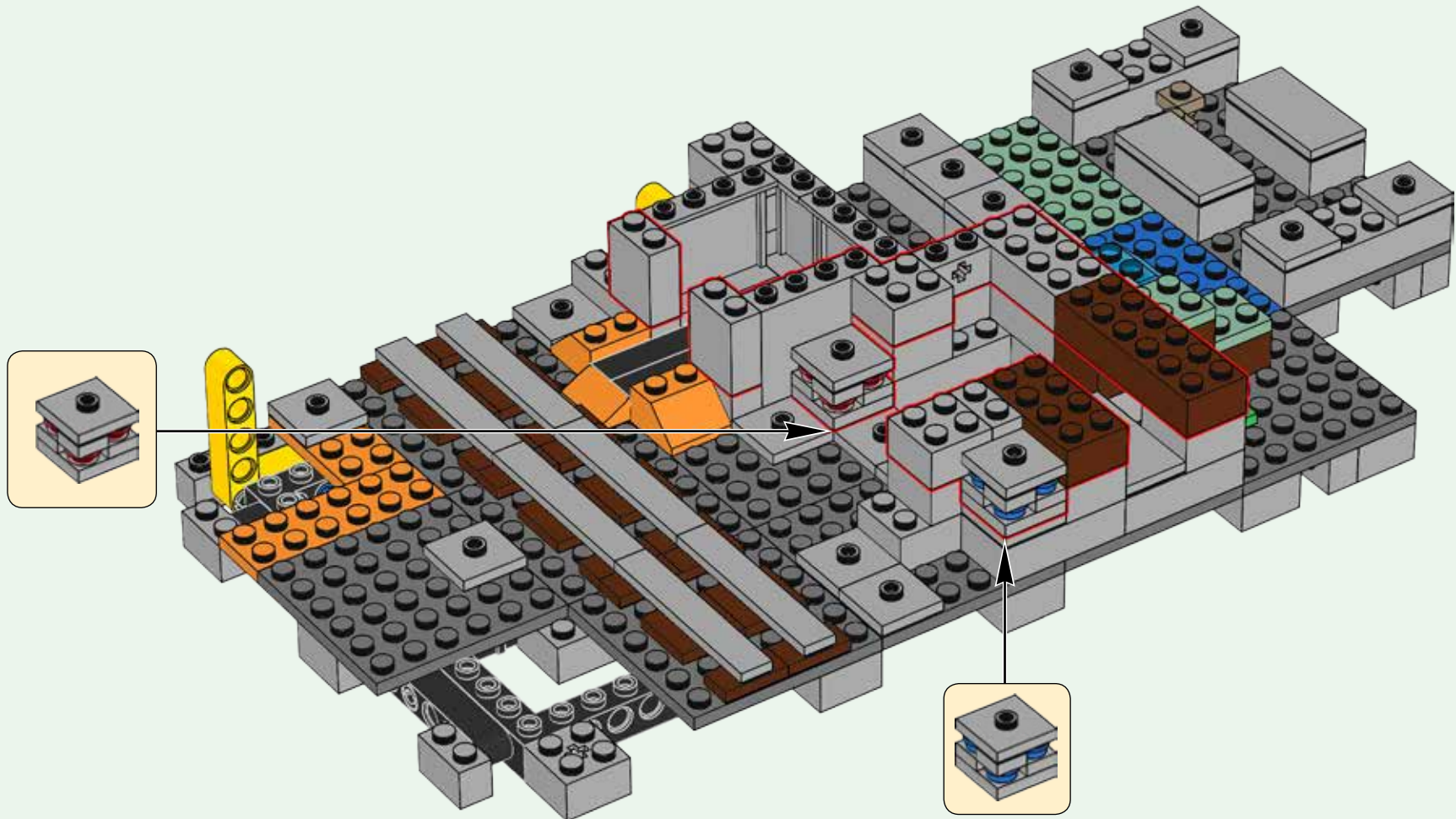

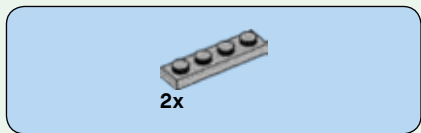

443

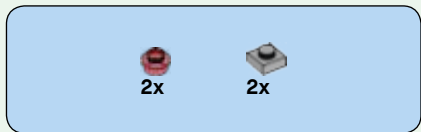
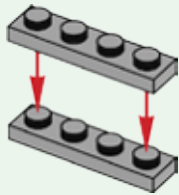

444

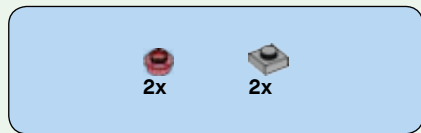
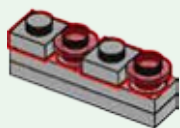

445

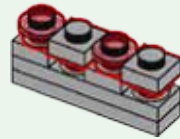

446

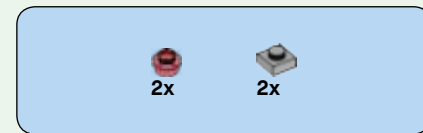
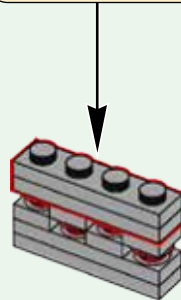
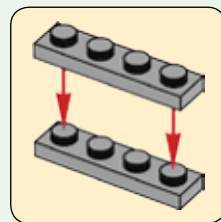

447

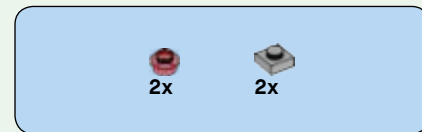
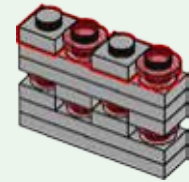

448

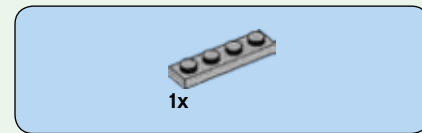
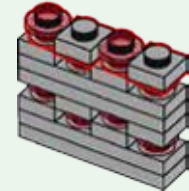

449

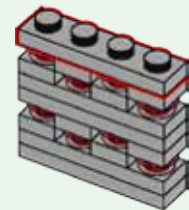

450

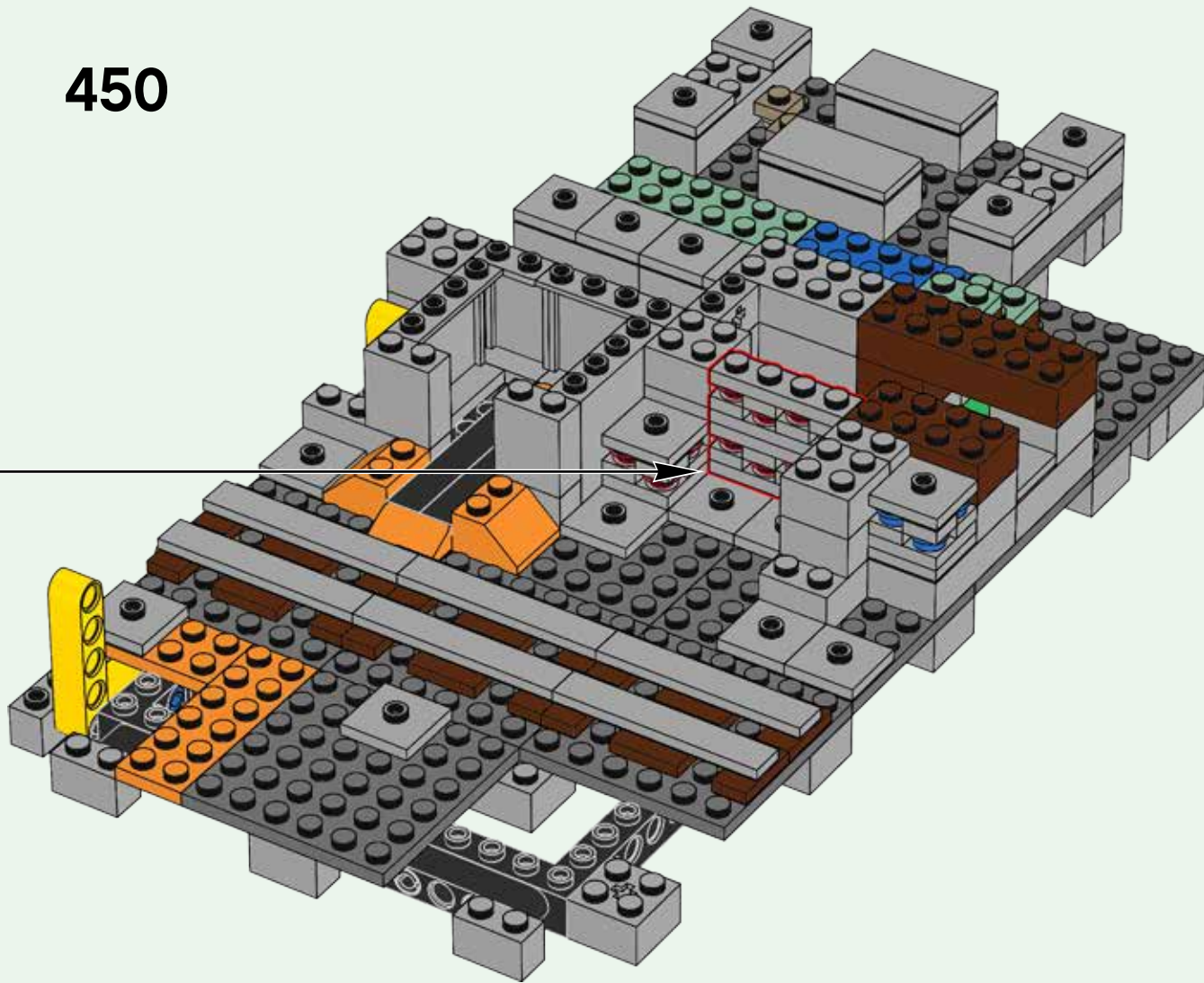

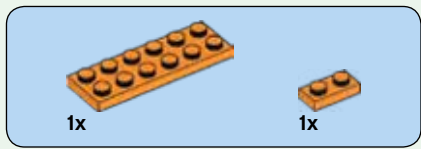

451

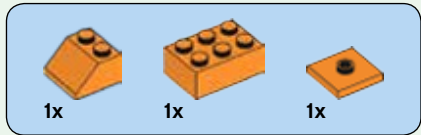
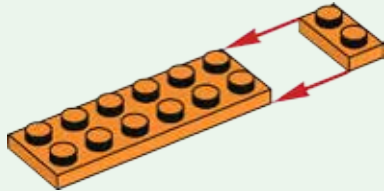

452

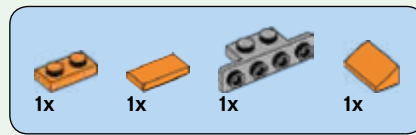
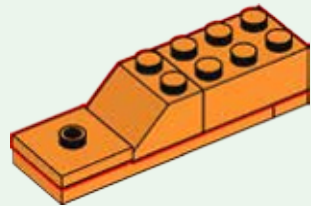

453

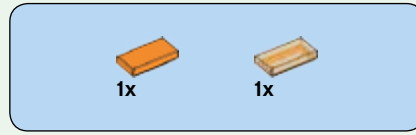
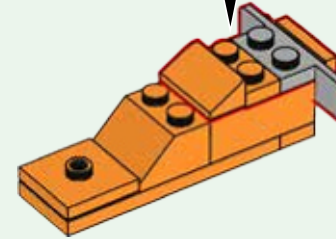
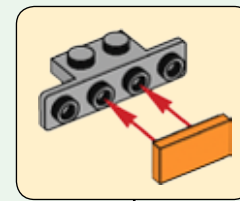

454

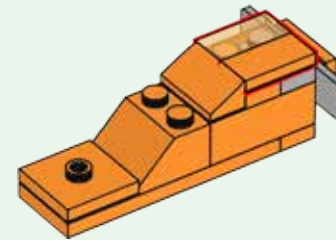

455

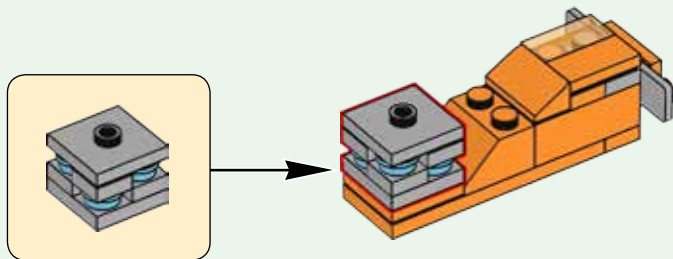

456

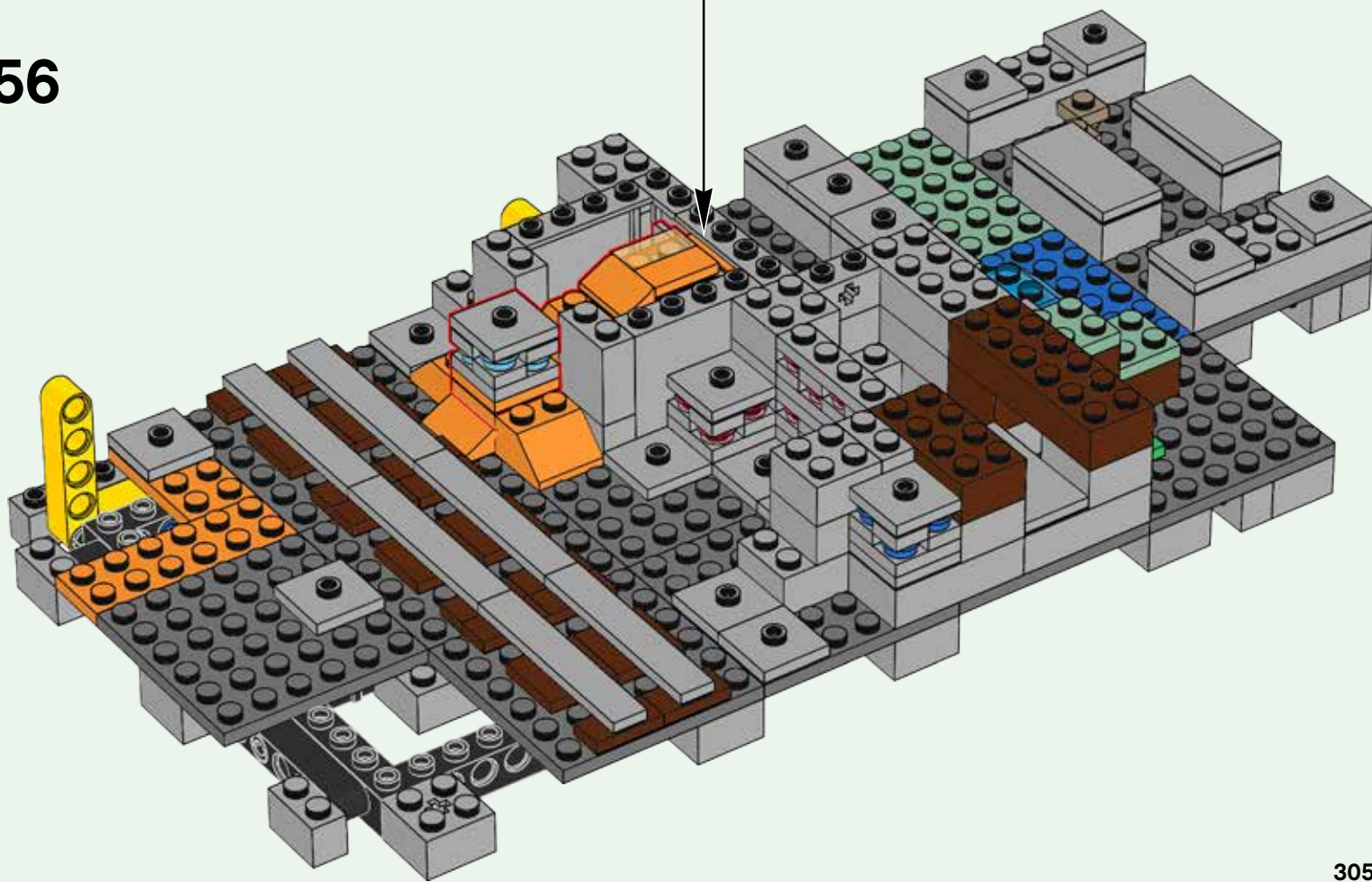

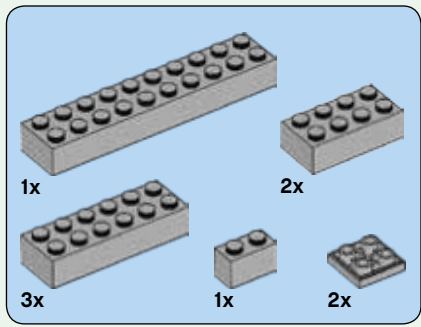

457

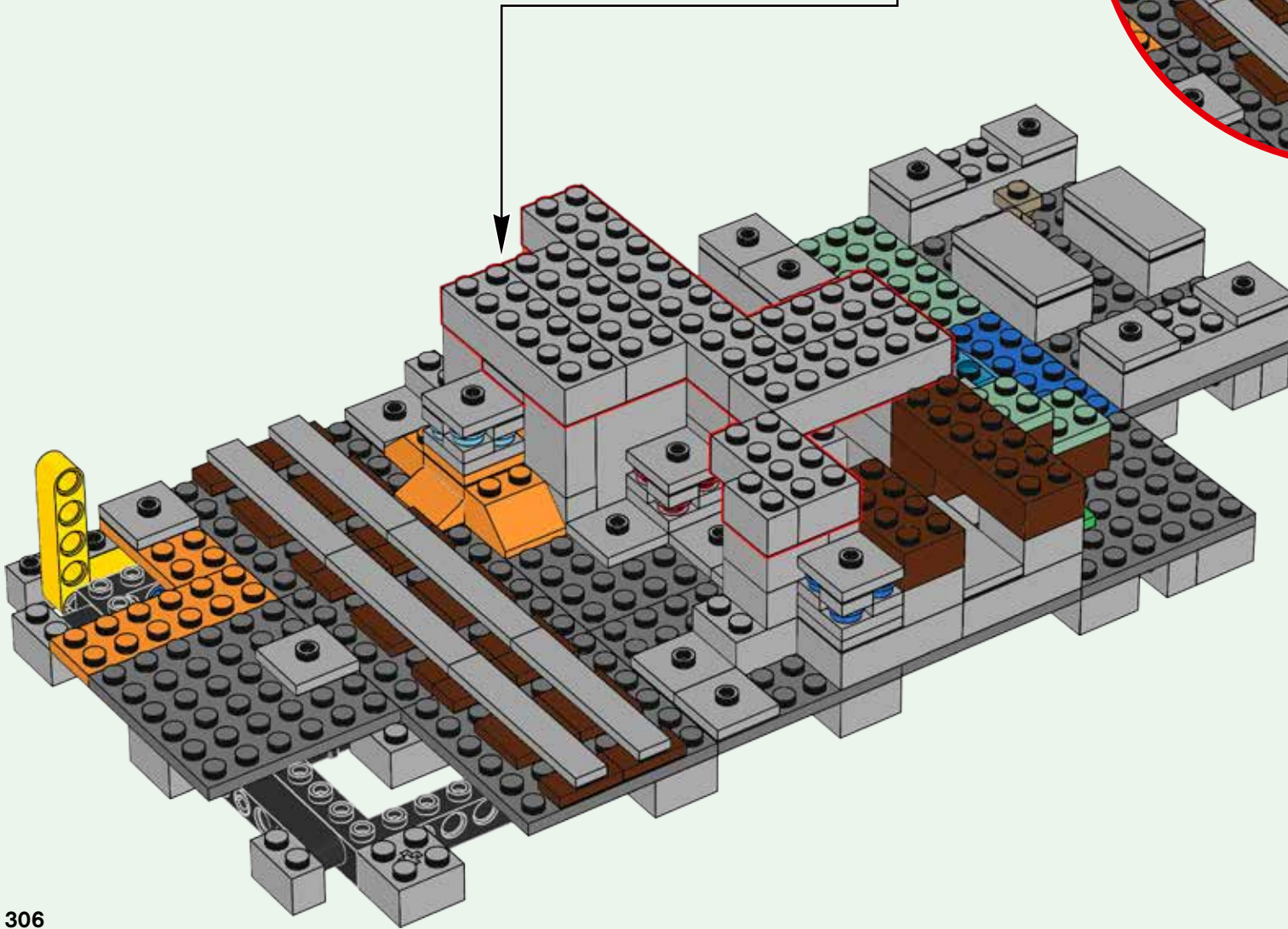
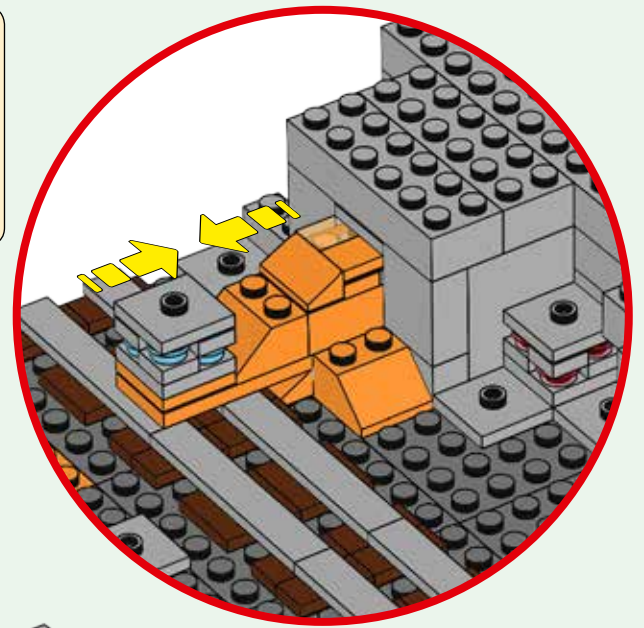
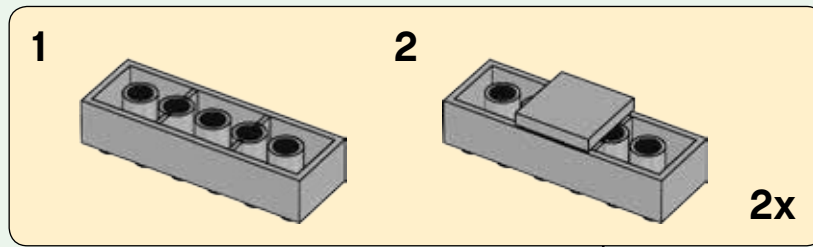

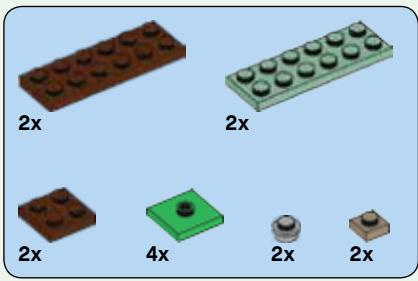

458

1



2

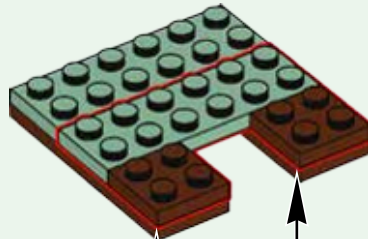

3

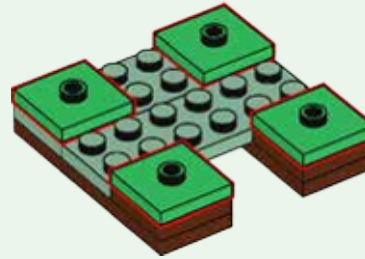

4

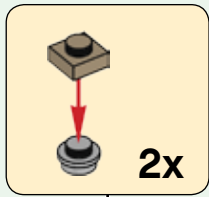
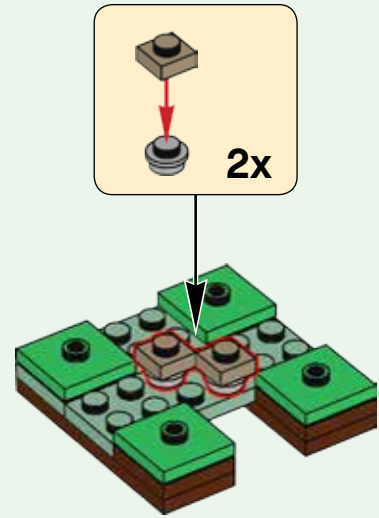

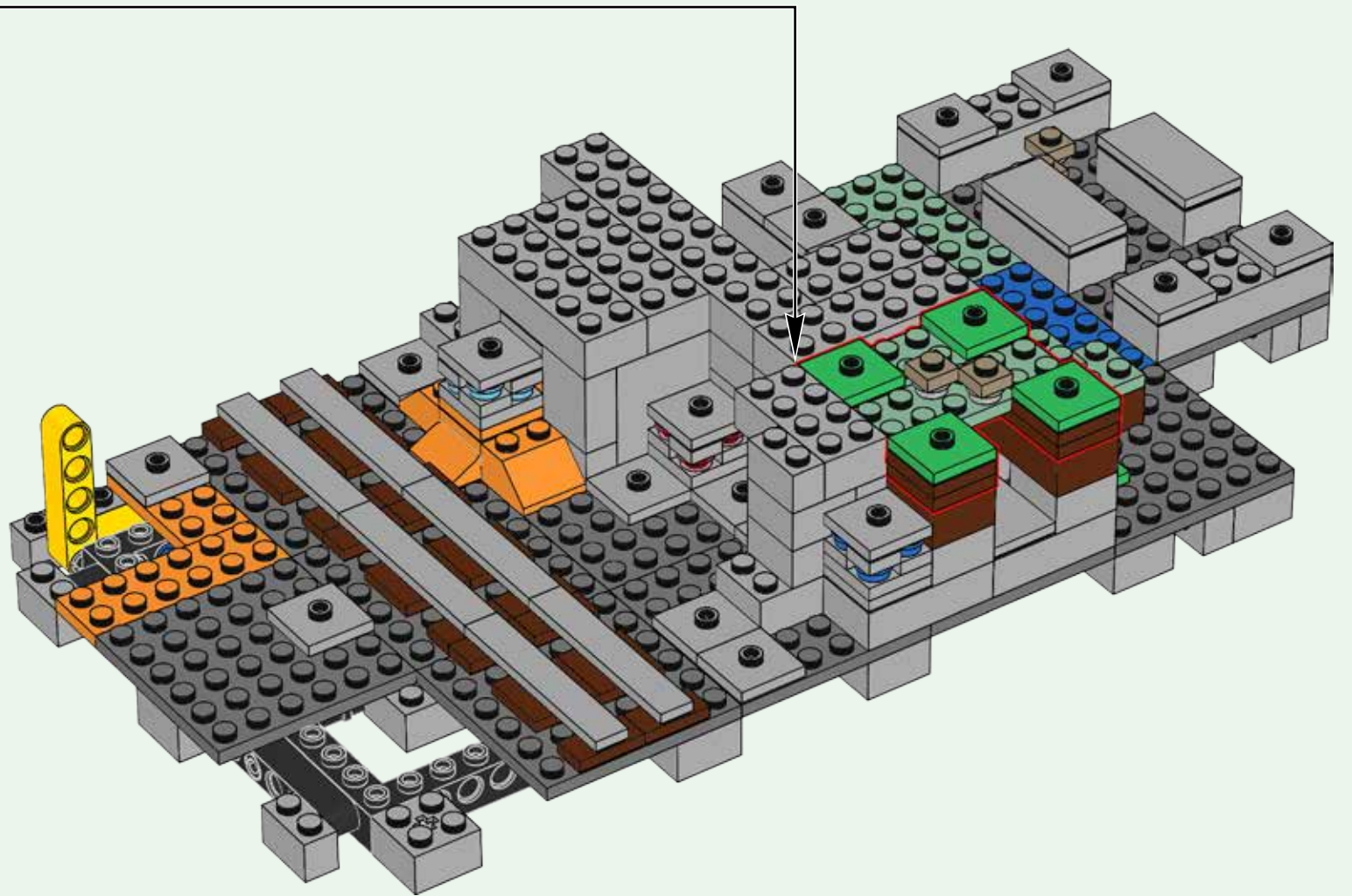

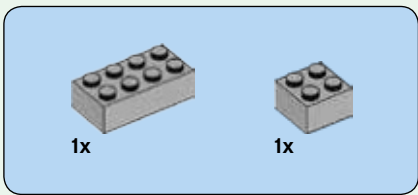

459

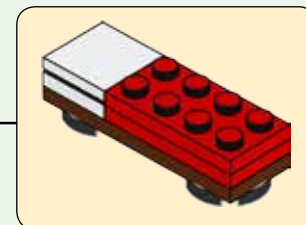
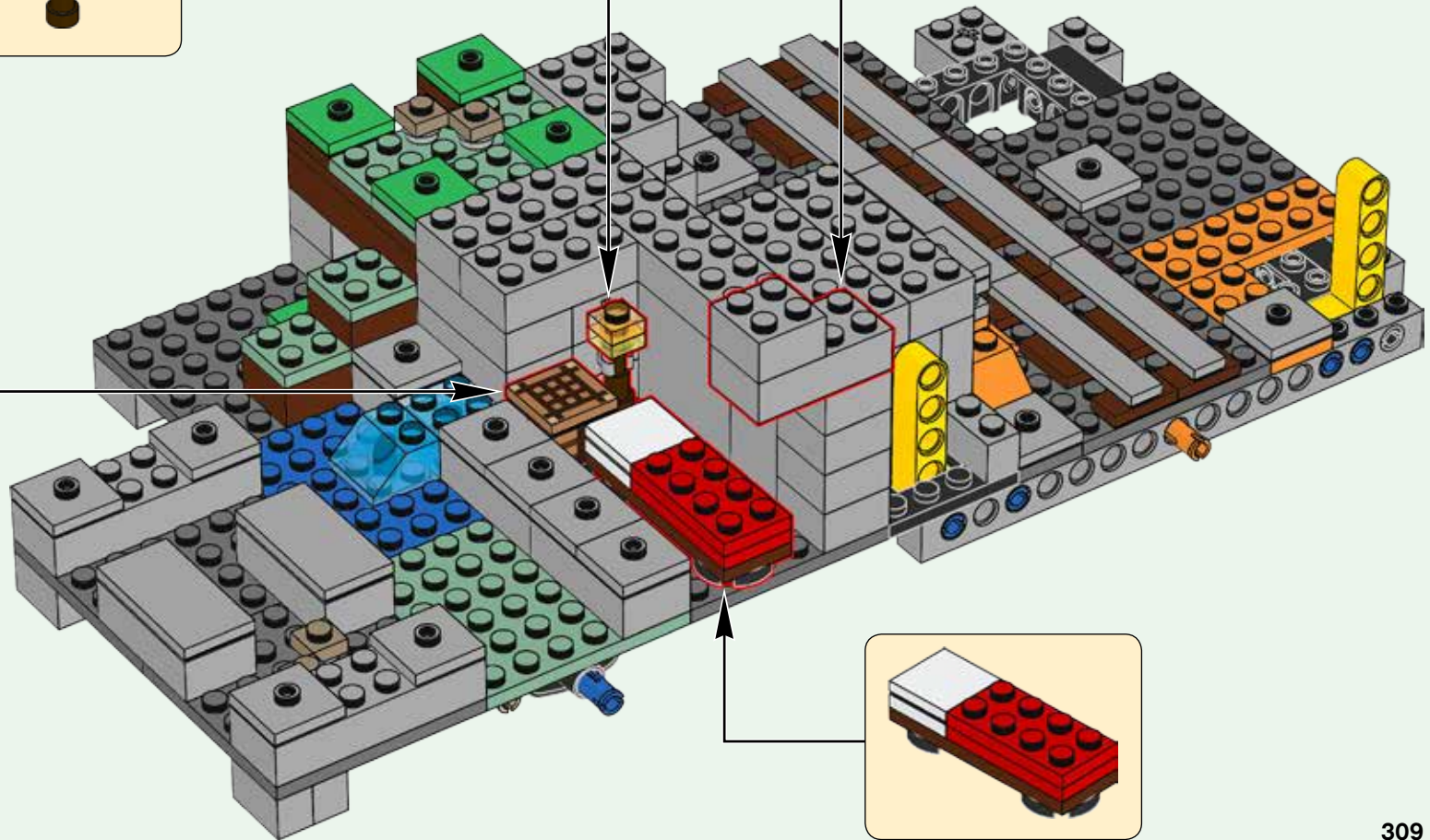
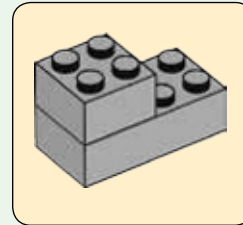
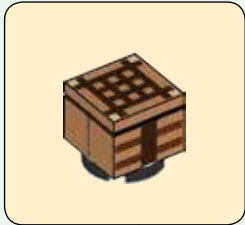
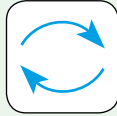

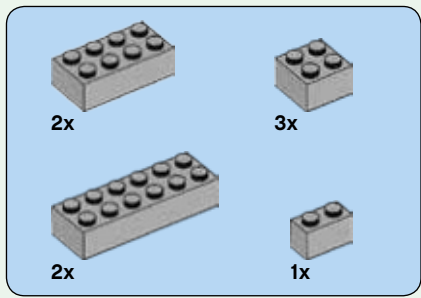

460

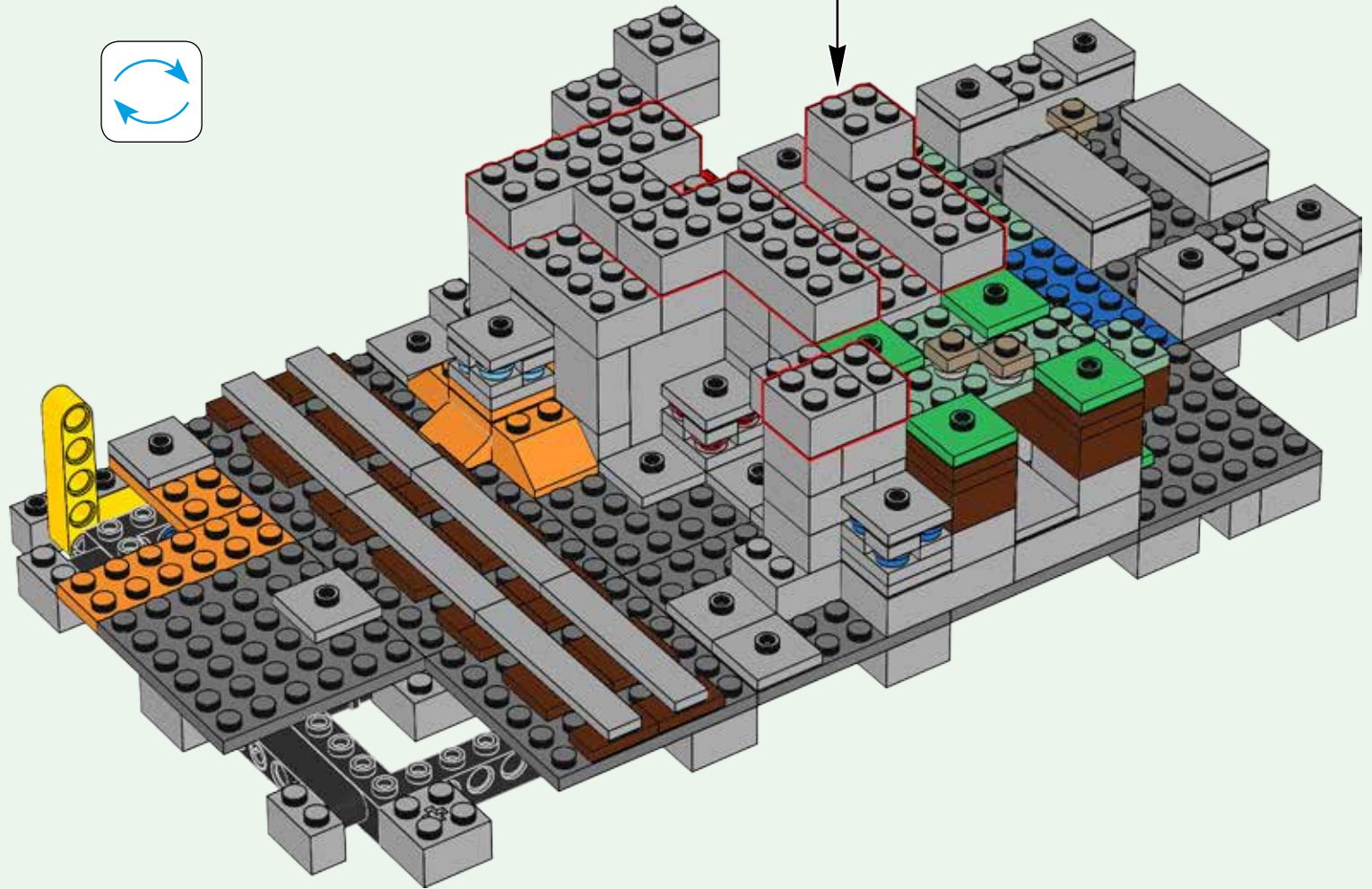
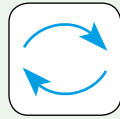
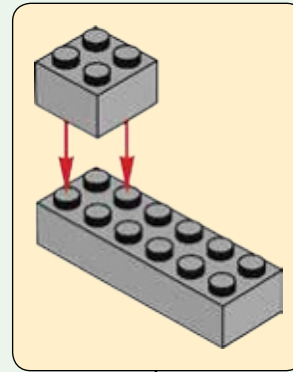

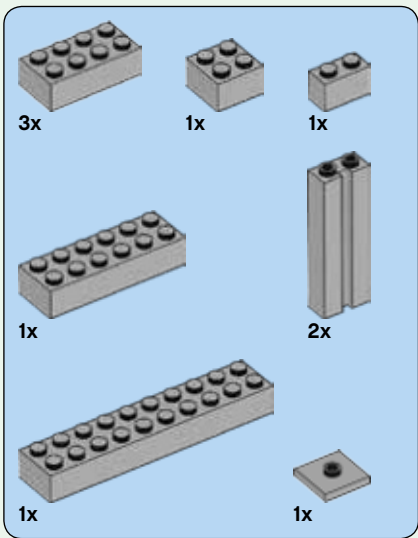

461

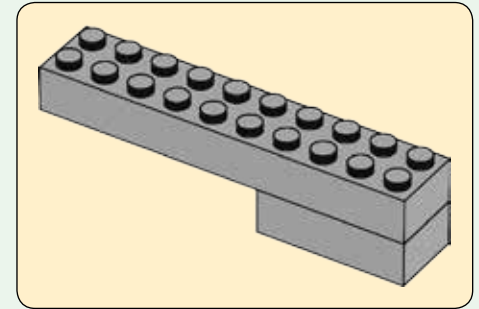
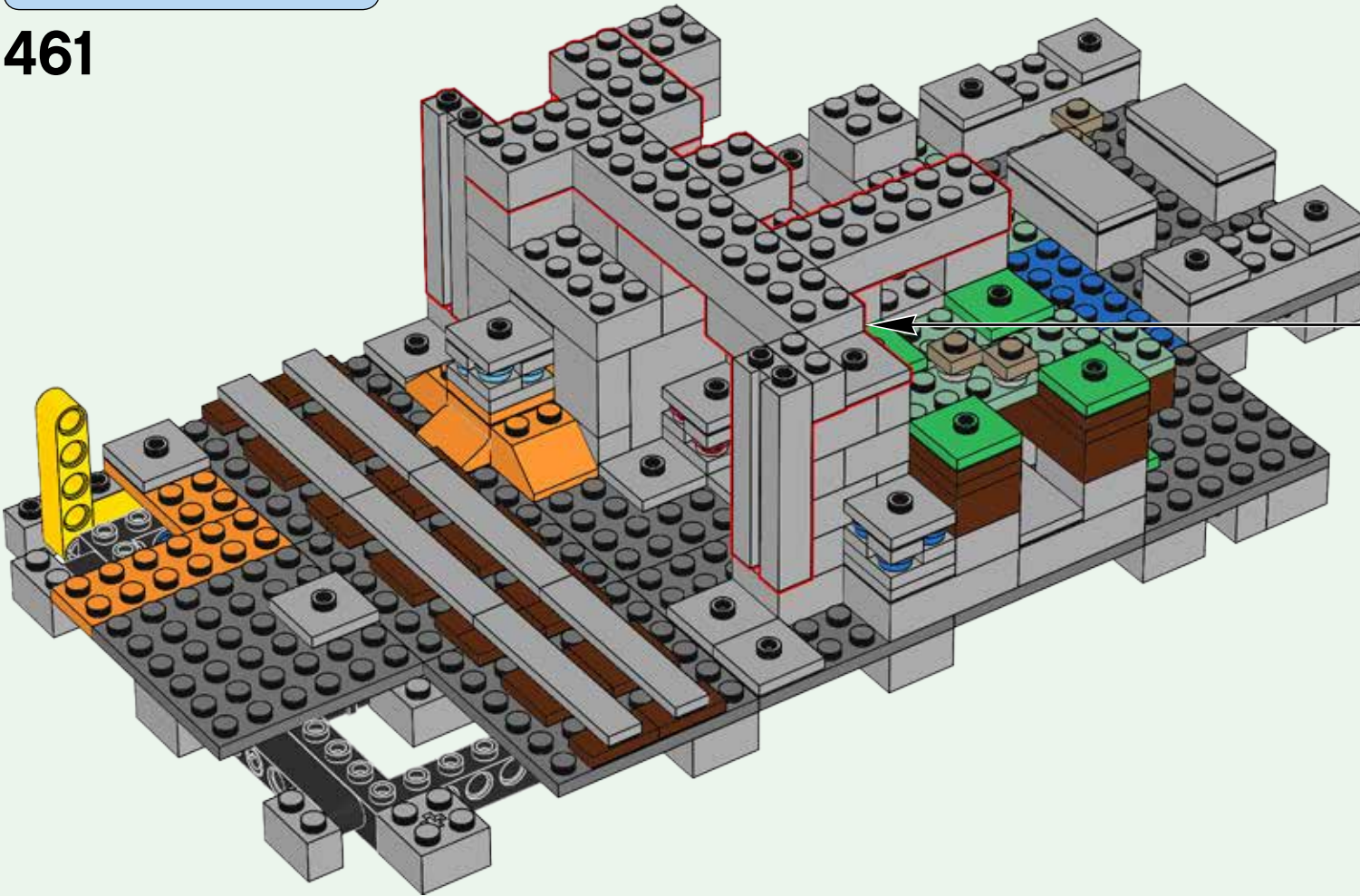

2x 6x 8x

462

1 2 3 4 2x

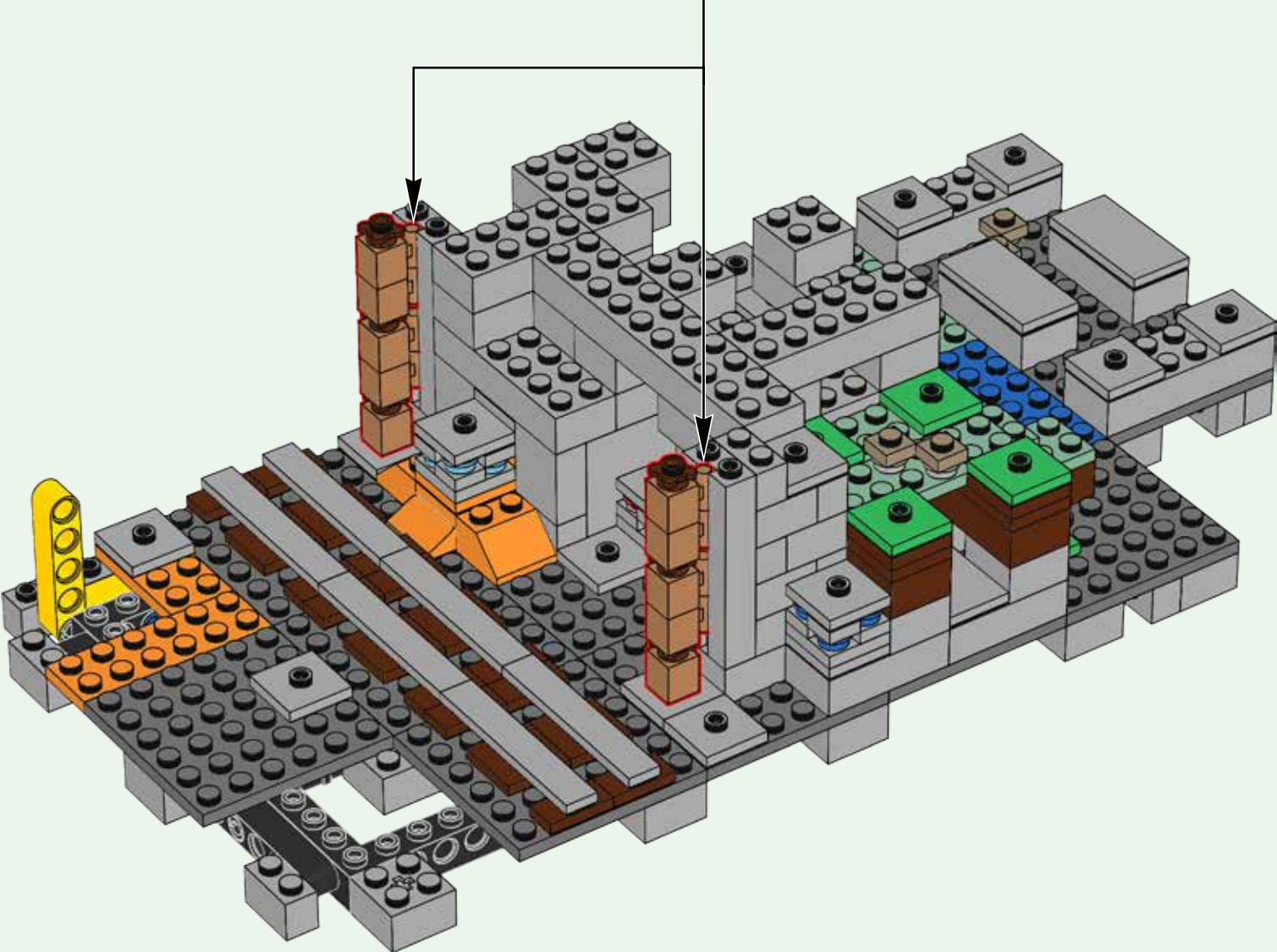

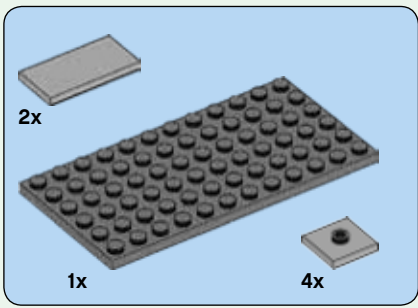

463

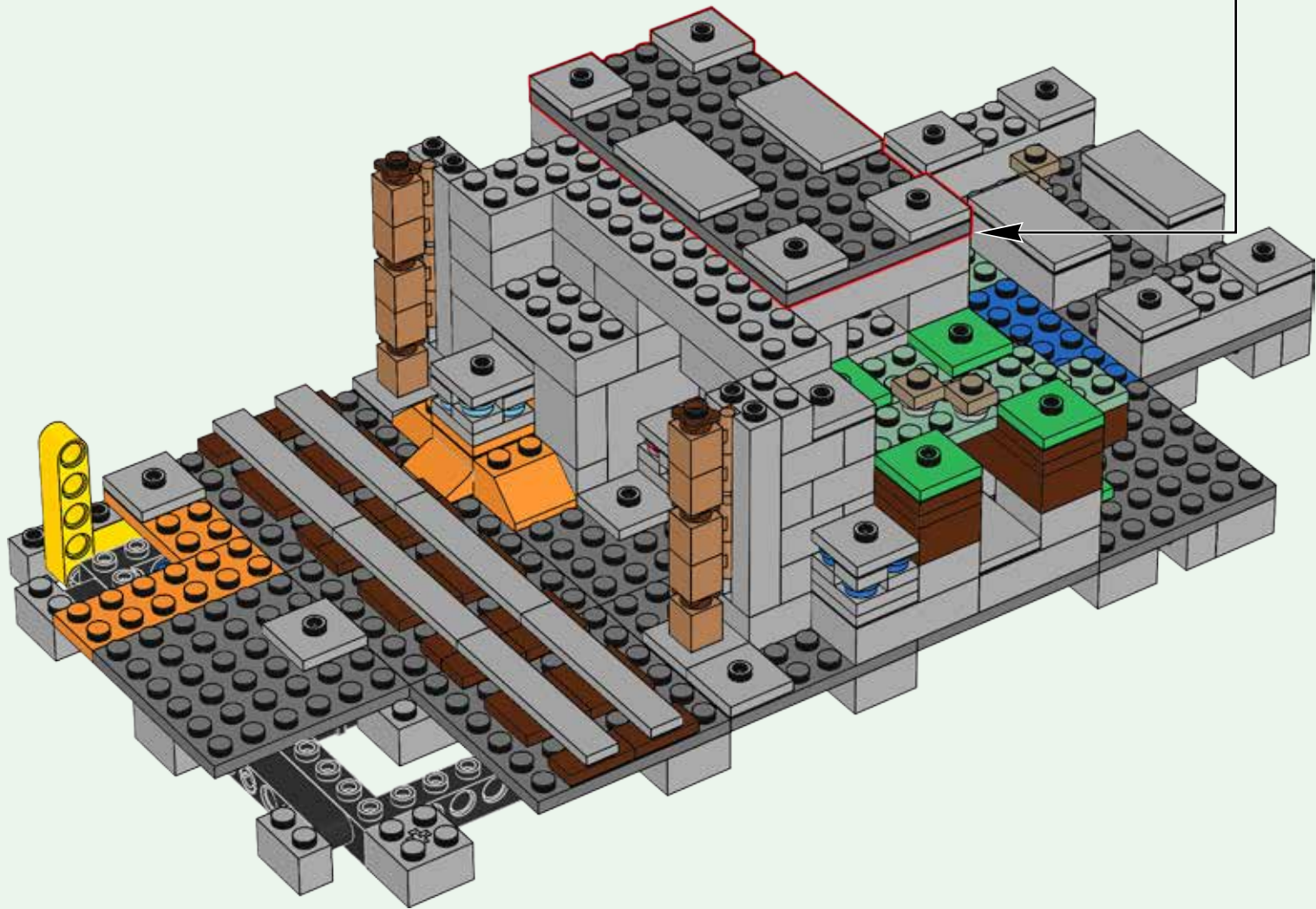
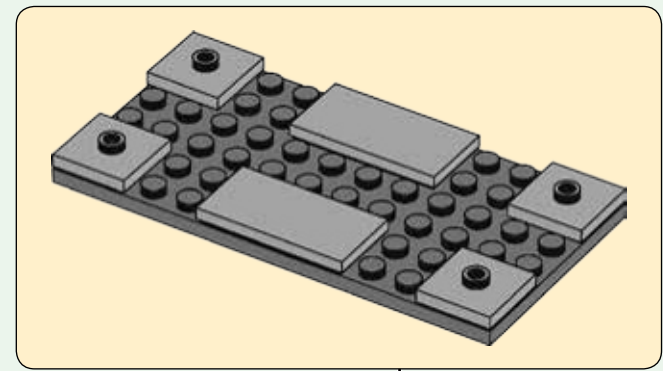

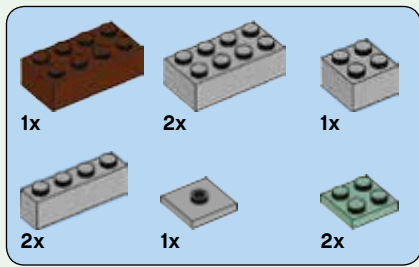

464

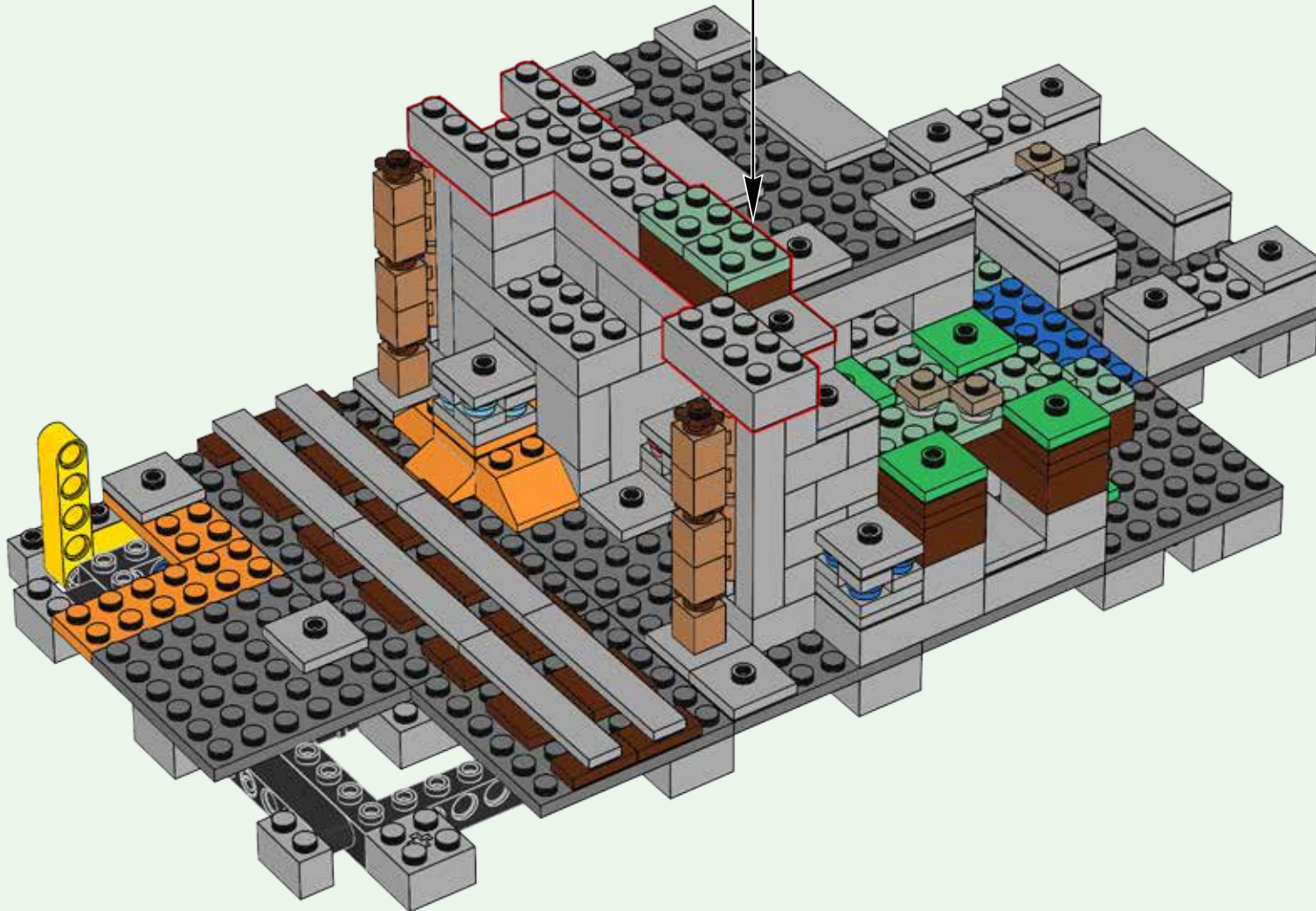
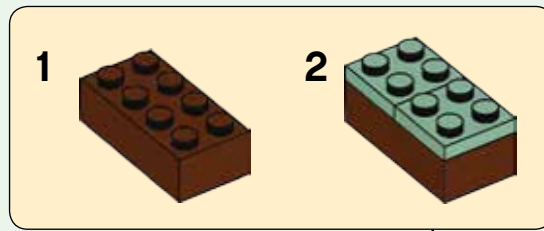

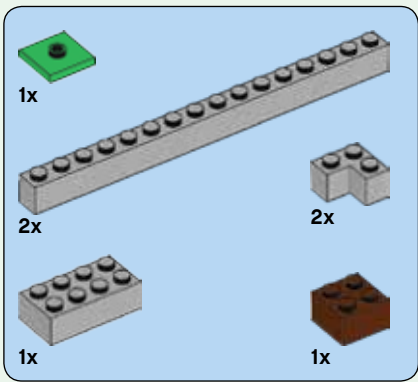

465

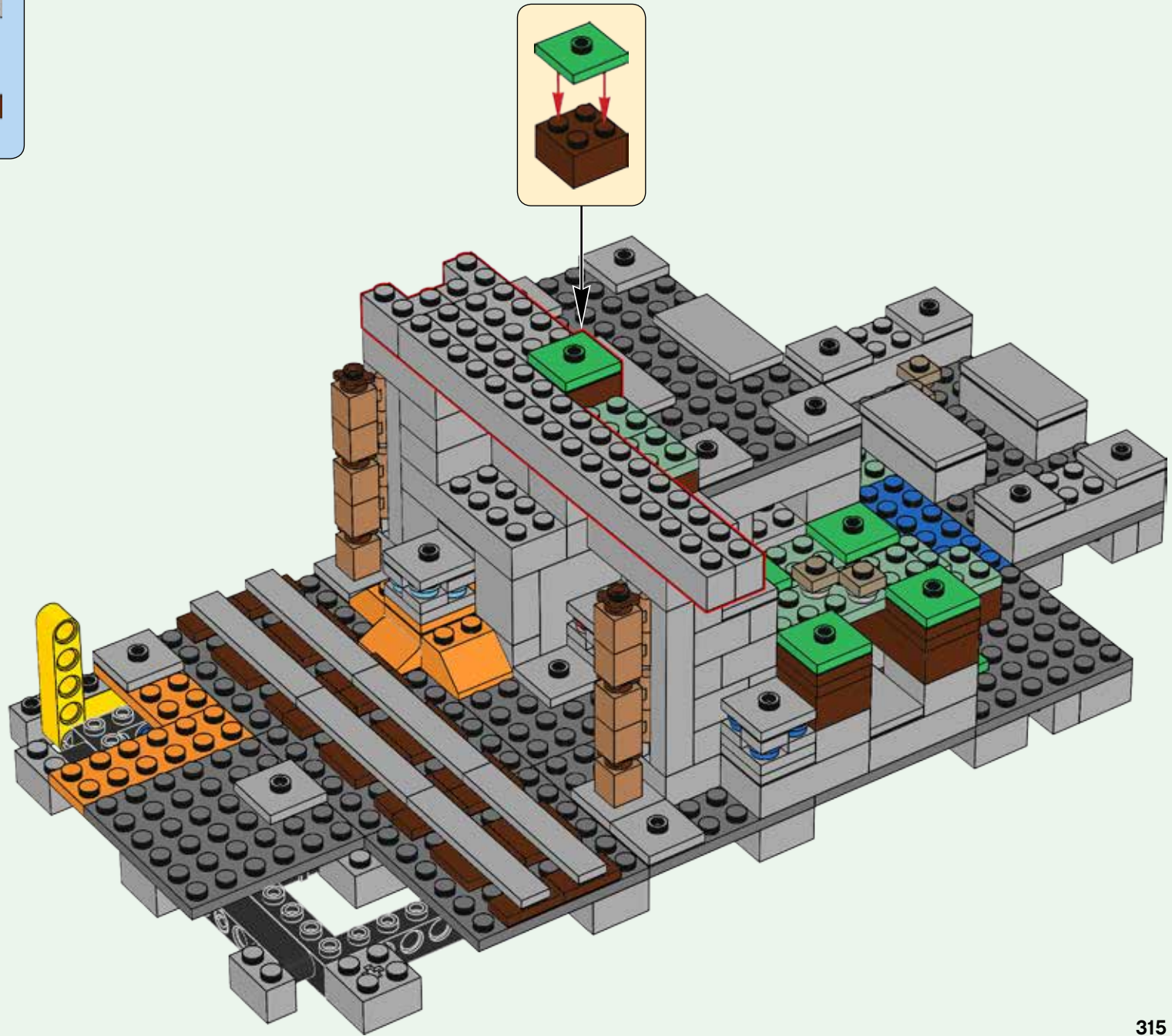

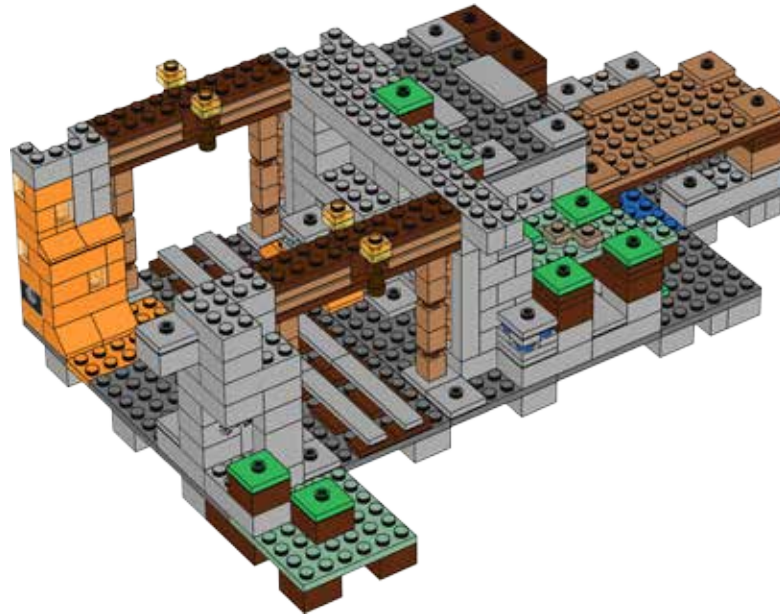

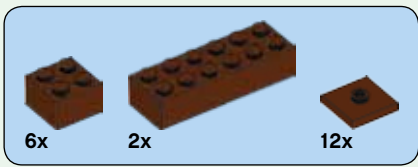

466

1

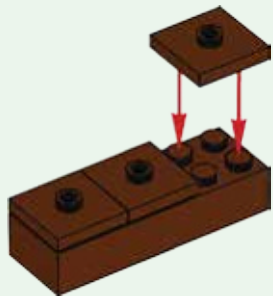

2

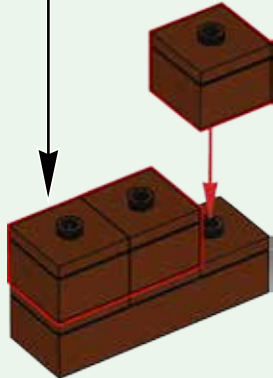

3

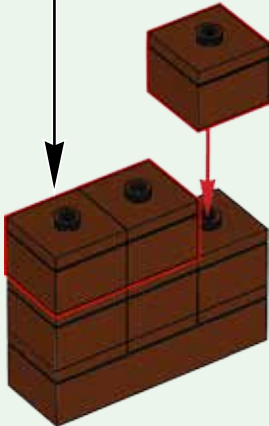

4

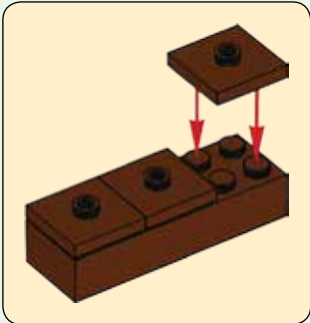
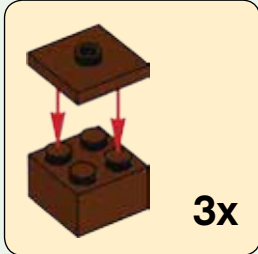
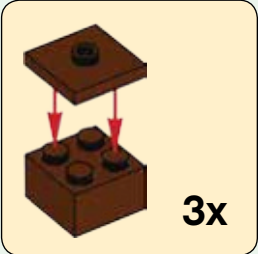

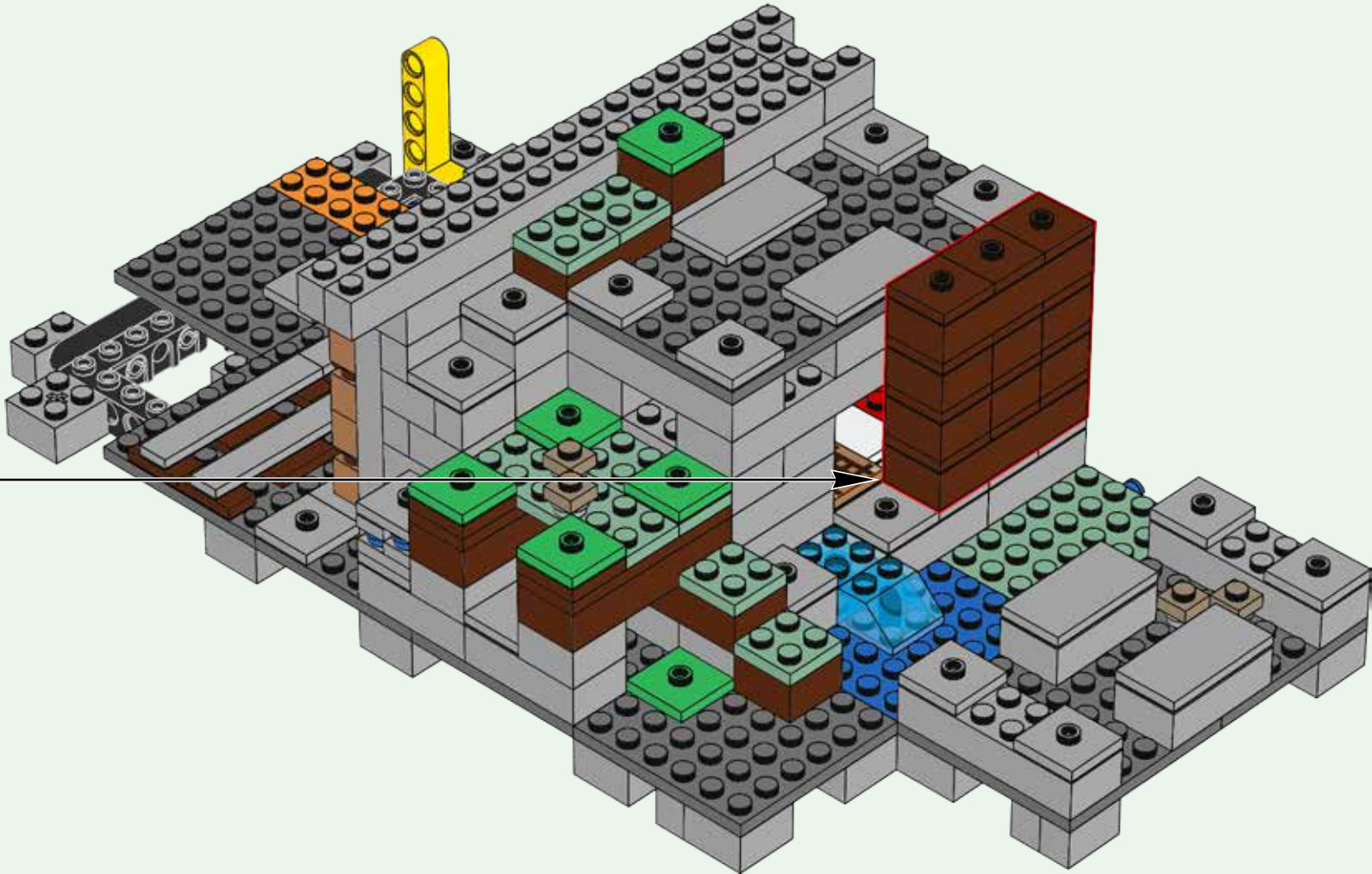

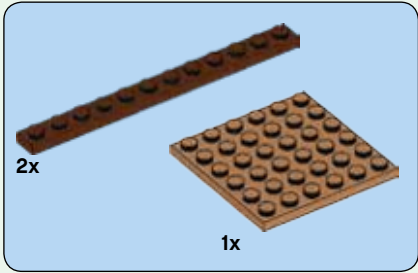
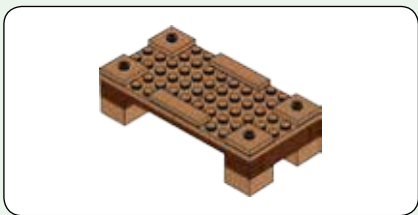

467

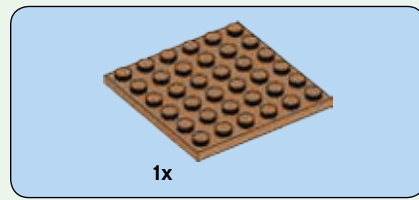
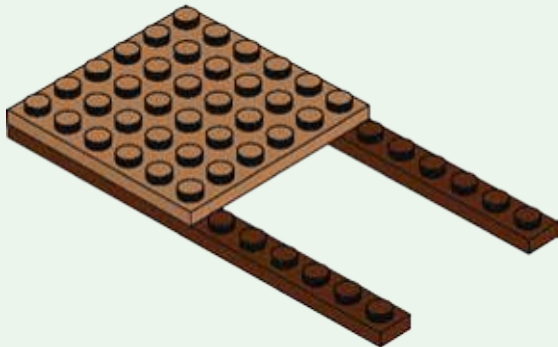

468

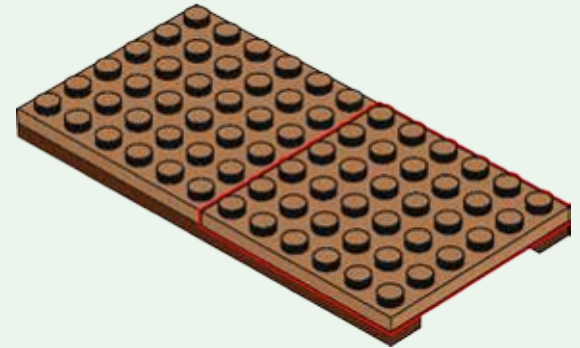

469

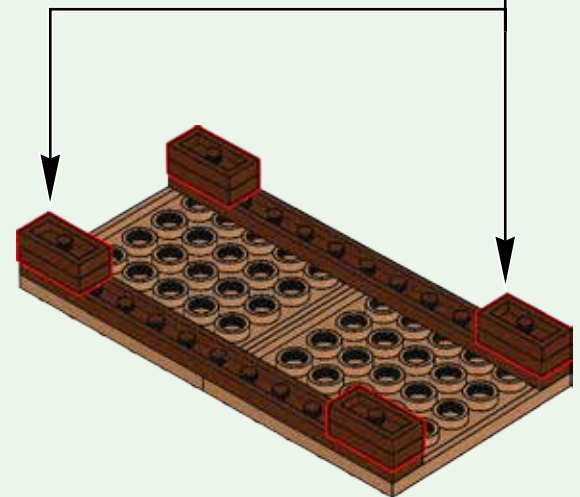
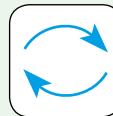
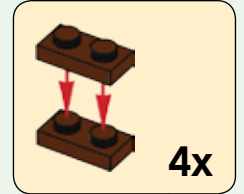

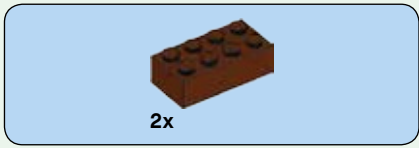

470

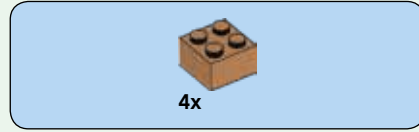
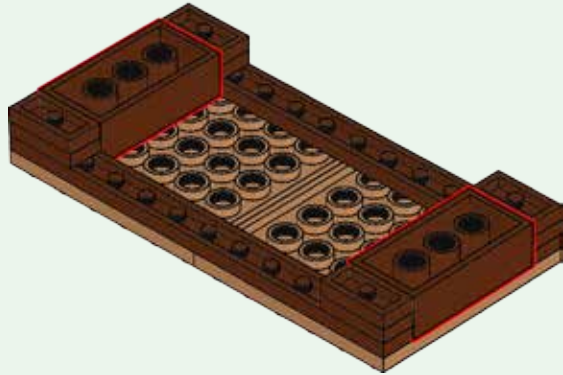

471

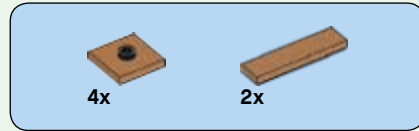
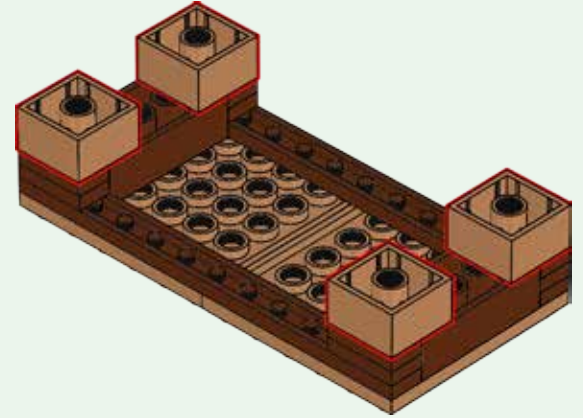

472

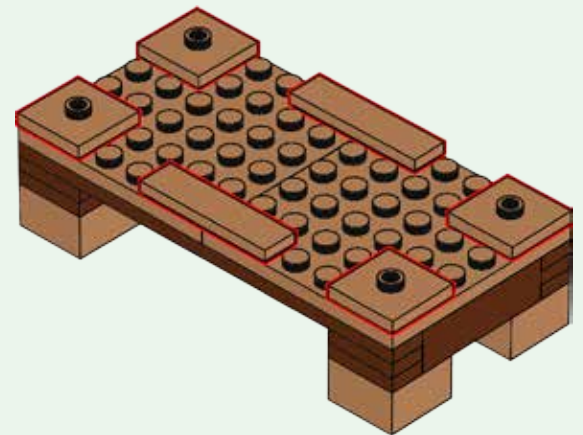
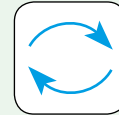

473

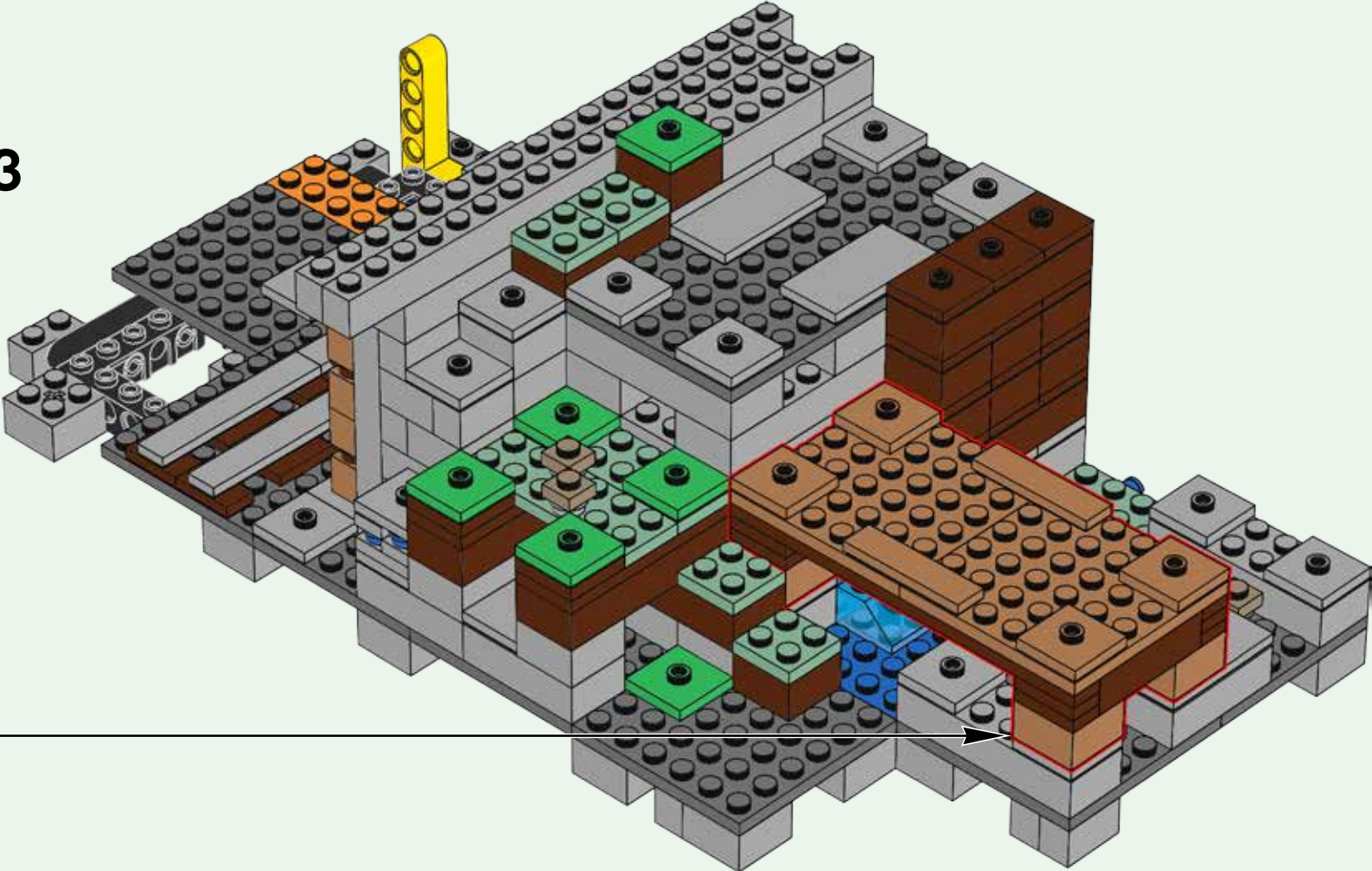

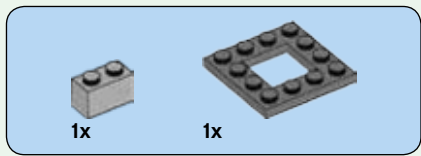

474

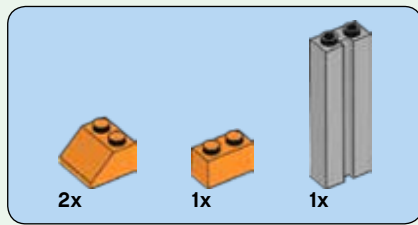
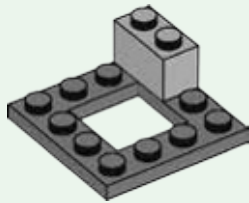

475

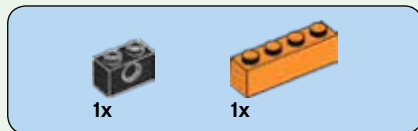
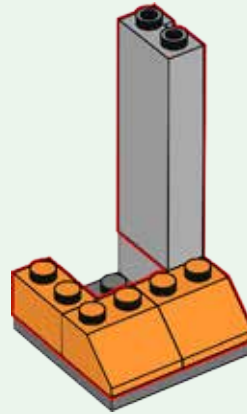

476

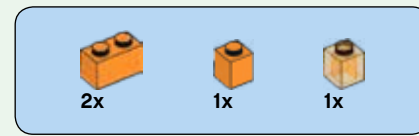
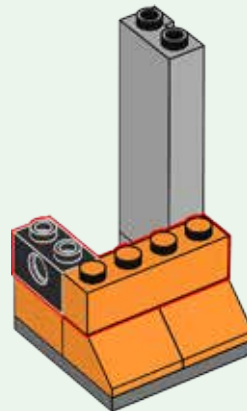

477

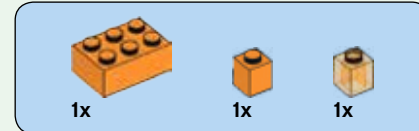
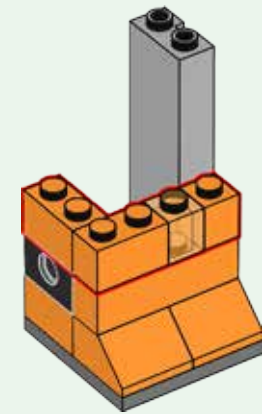

478



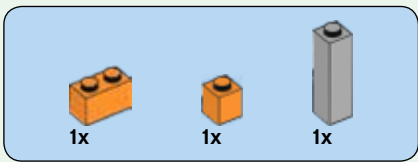

479

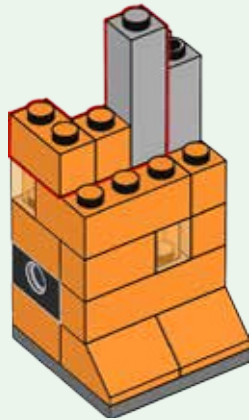

480

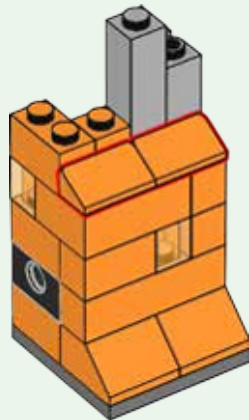

481

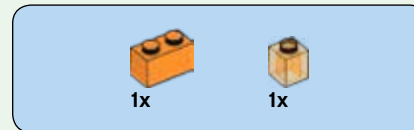
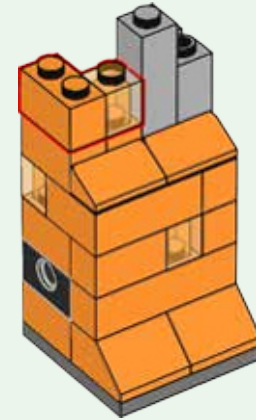

482

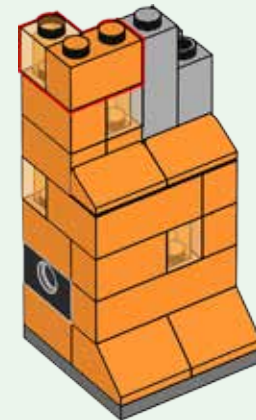

483

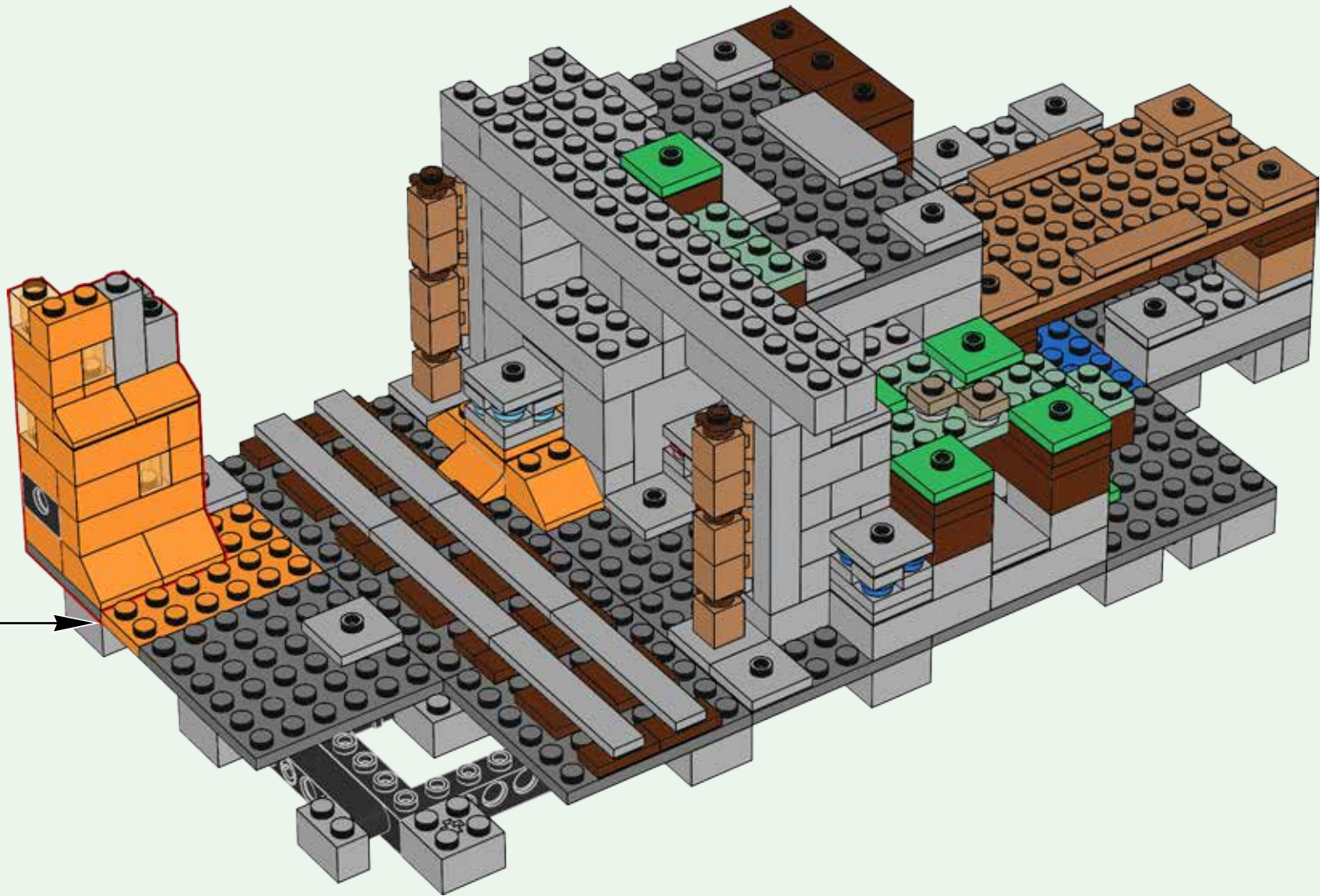

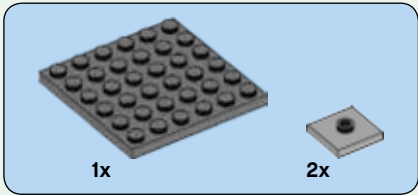
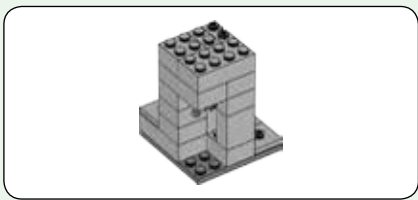

484

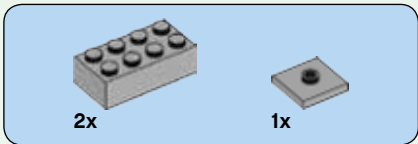
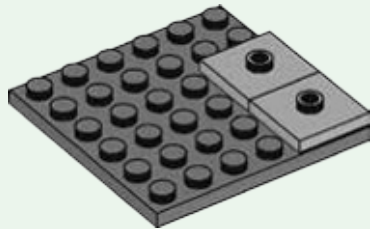

485

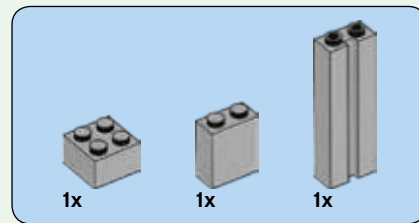
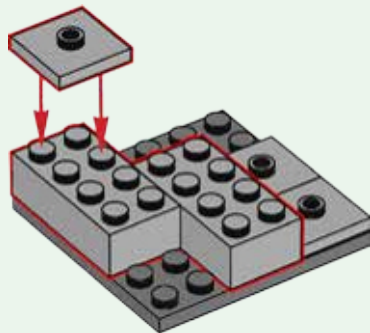

486

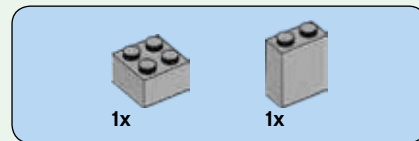
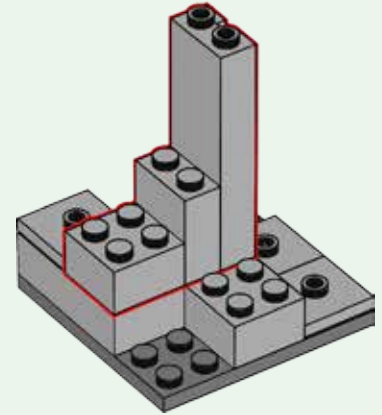

487

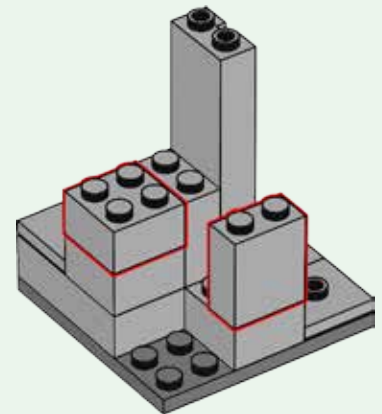

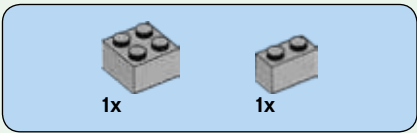

488

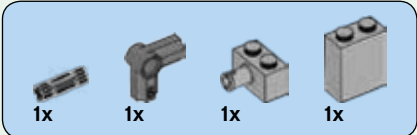
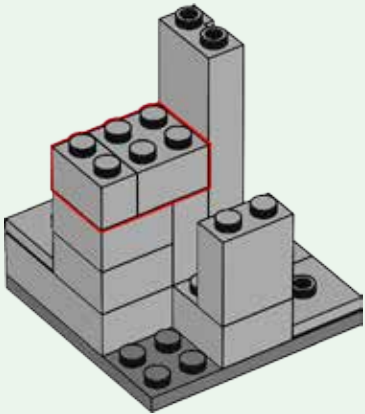

489

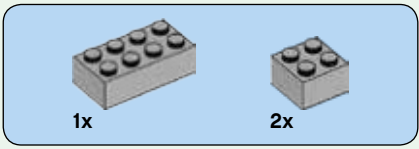
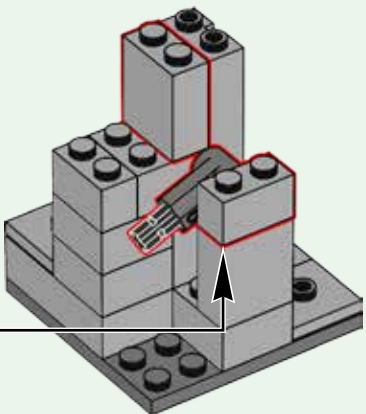
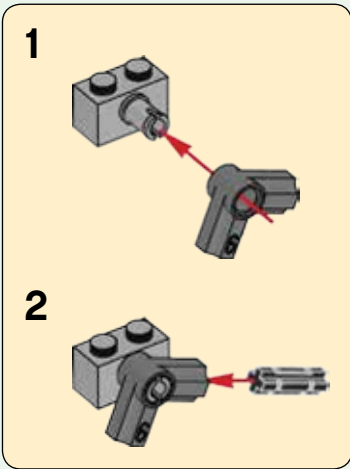

490

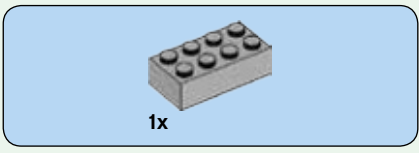
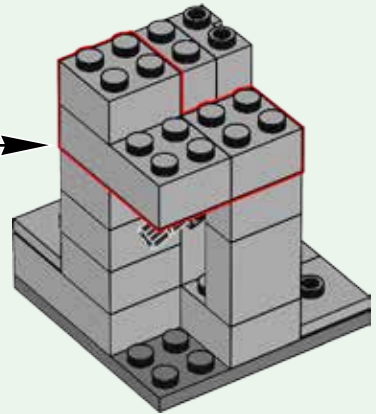
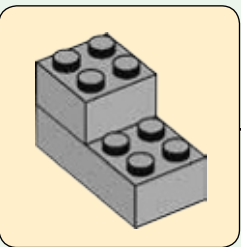

491

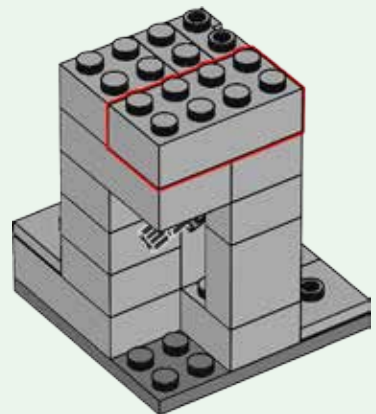

492

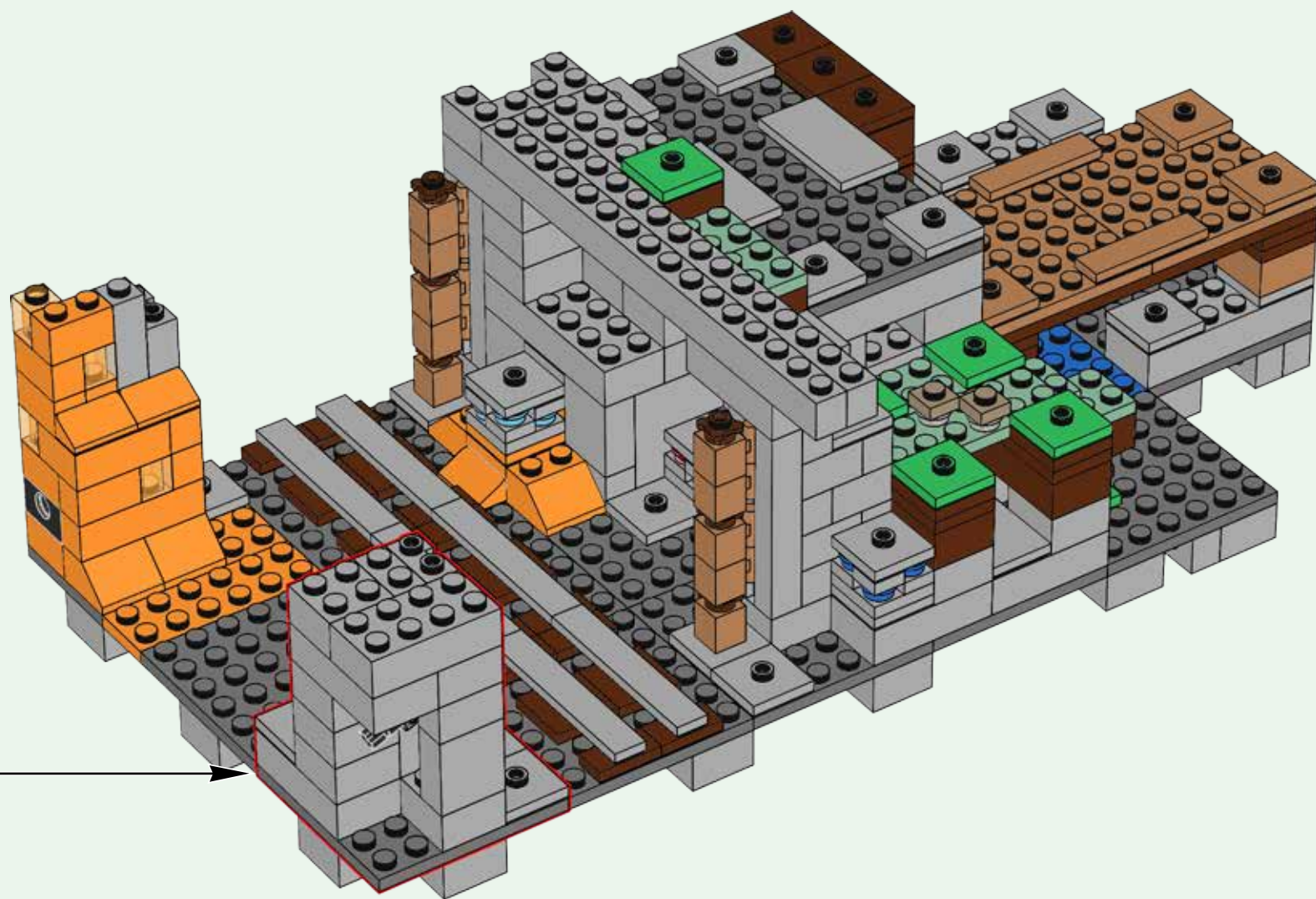

2x 6x 8x

493

1 2 3 4 2x

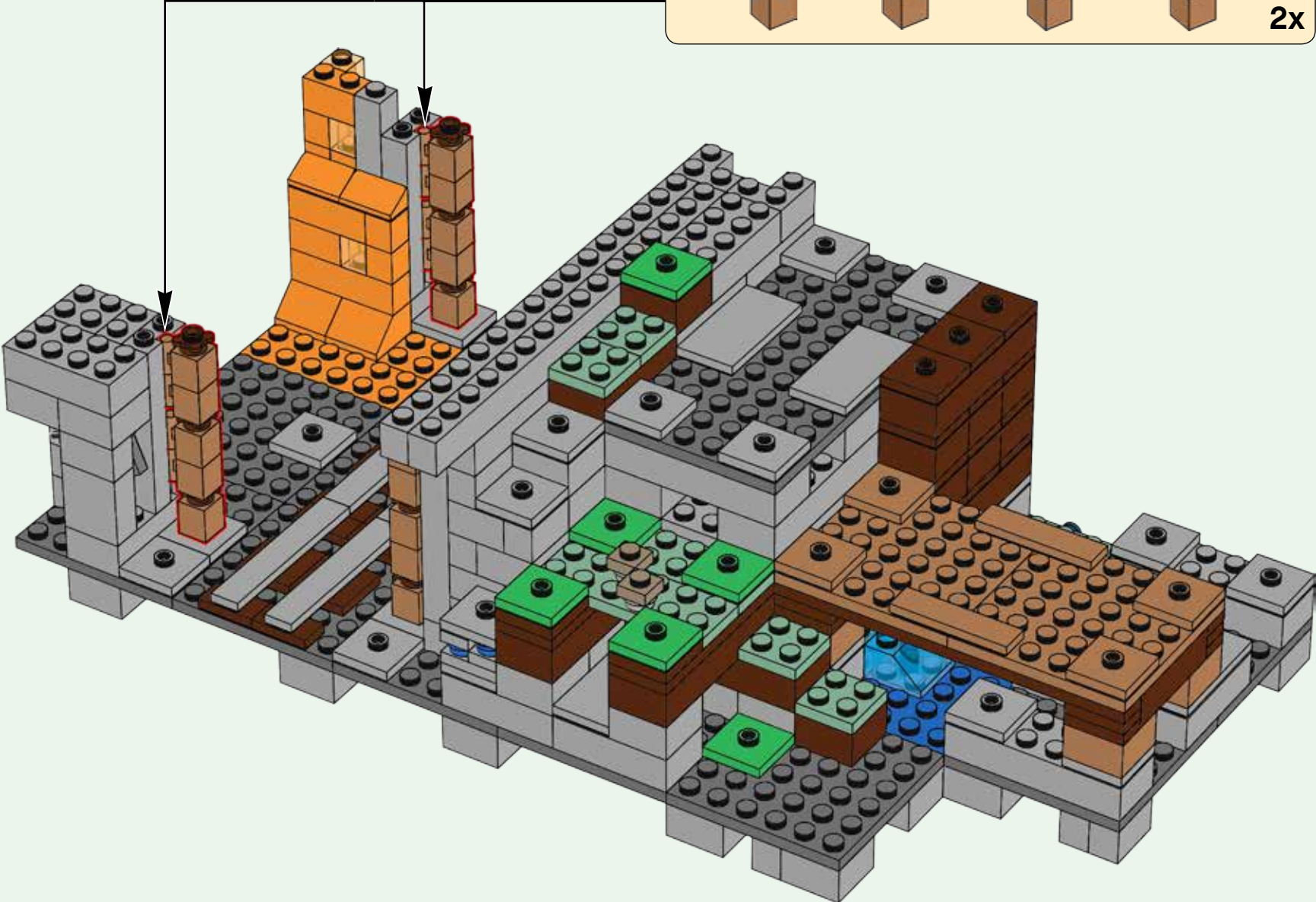

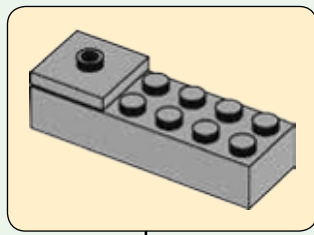
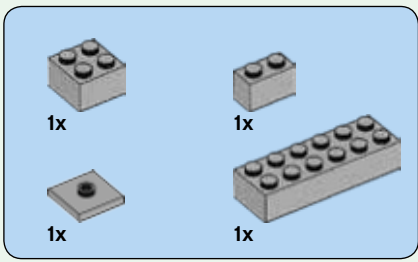

494

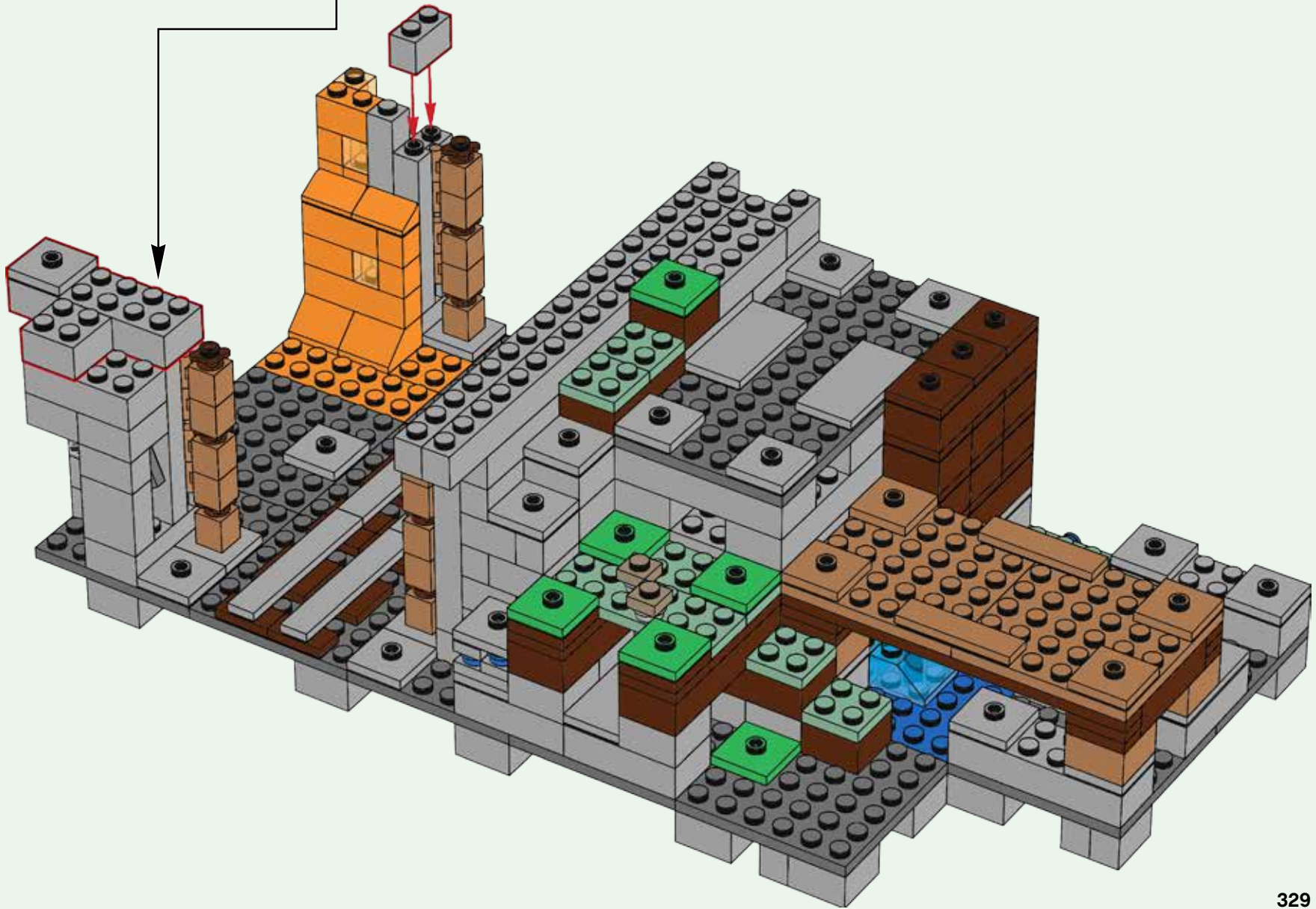

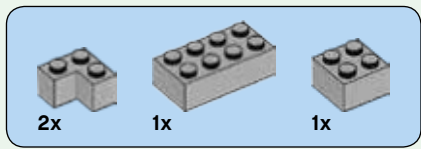

495

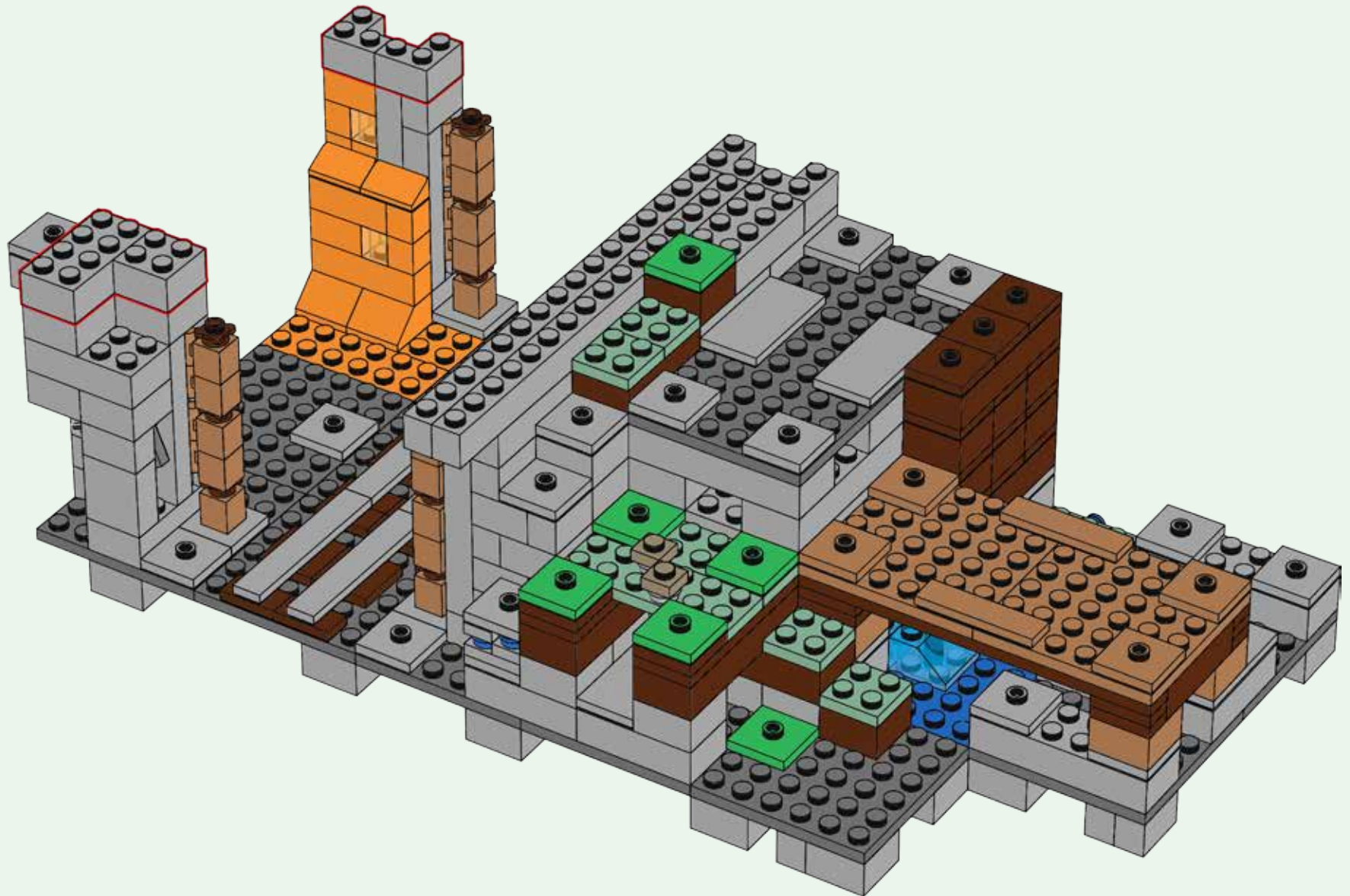

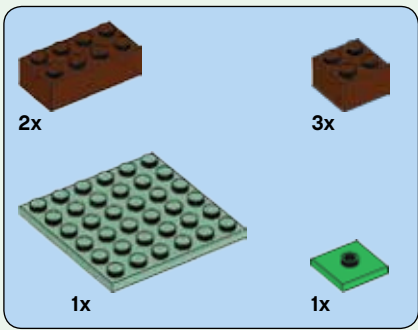

496

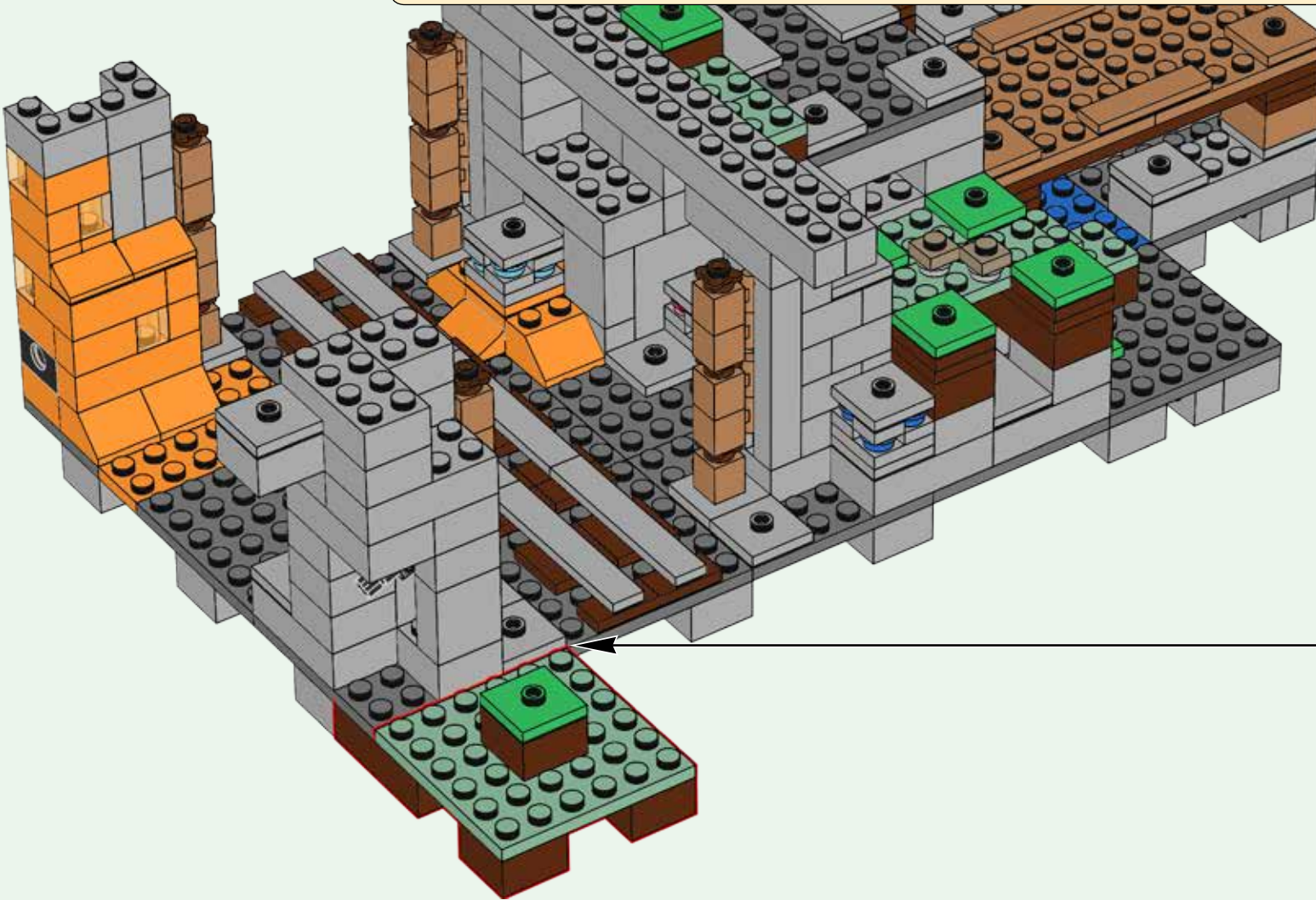
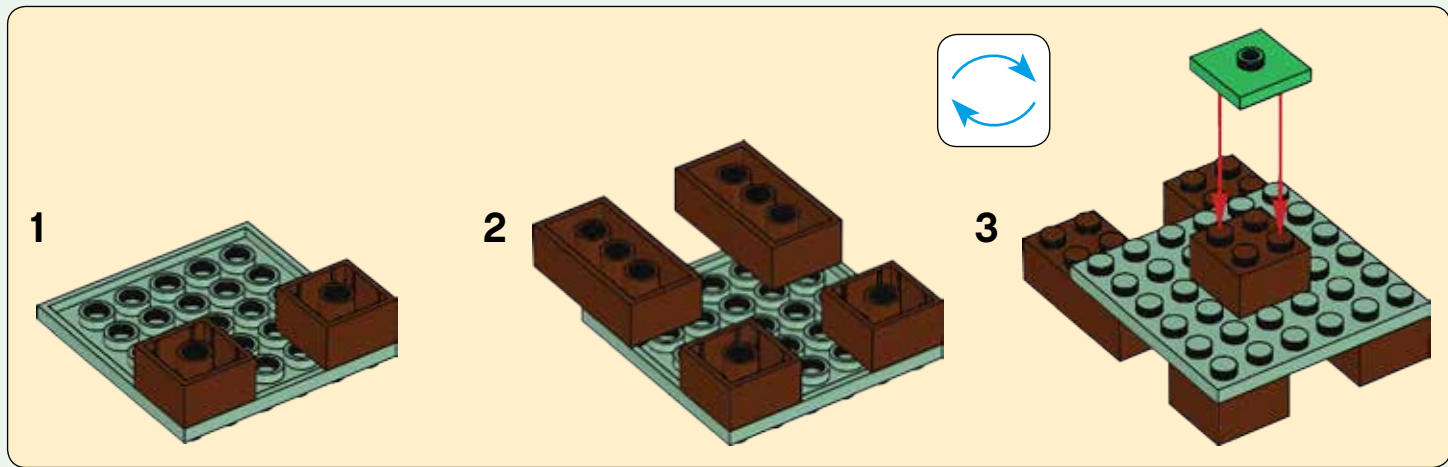

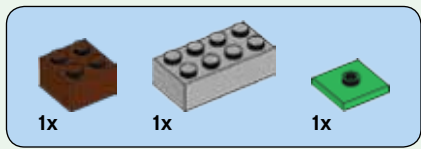

497

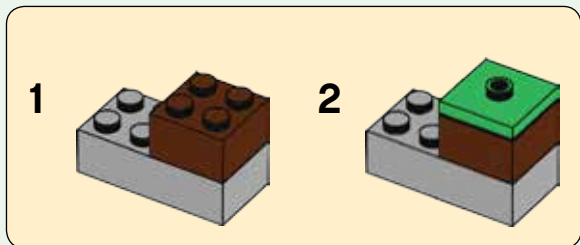
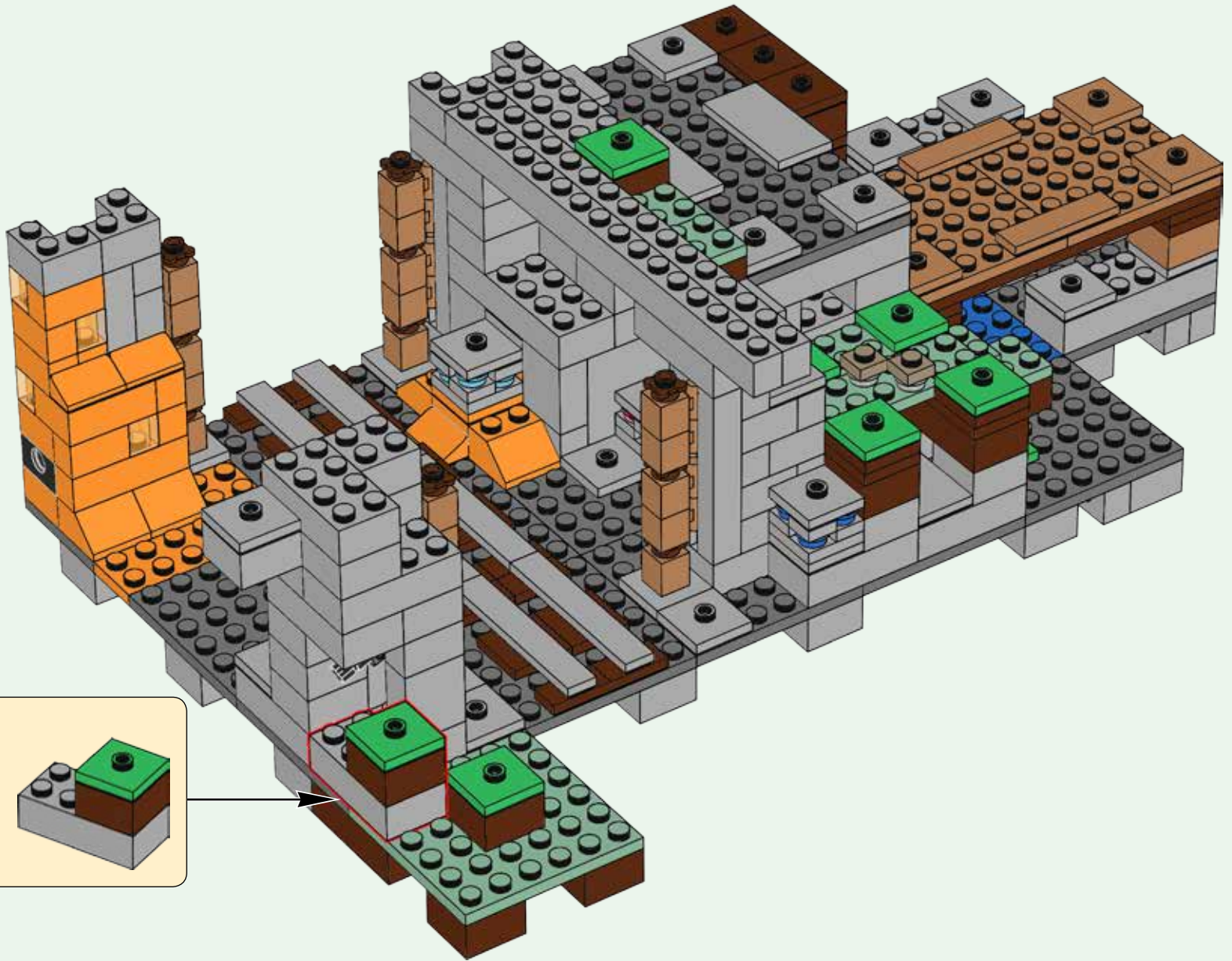

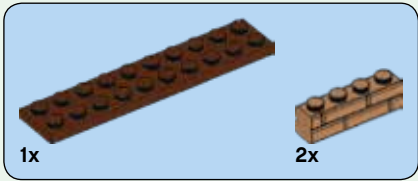

498

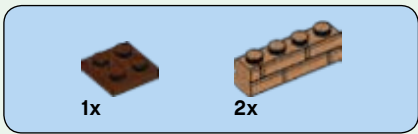
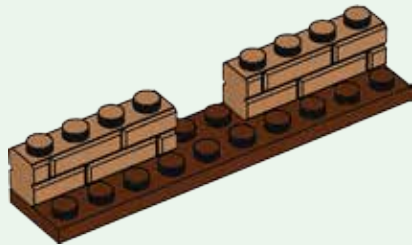

499

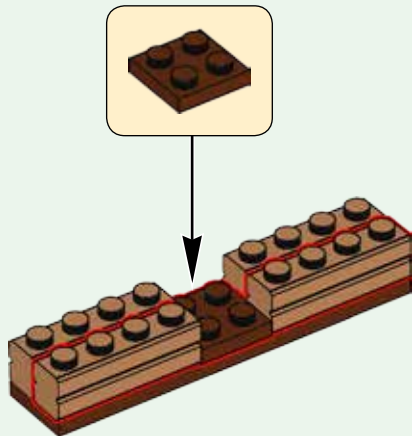

500

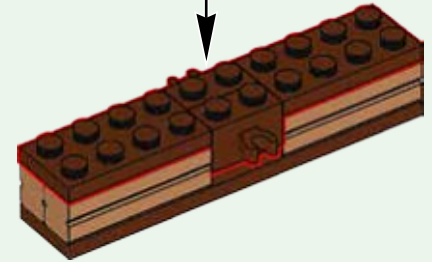

501

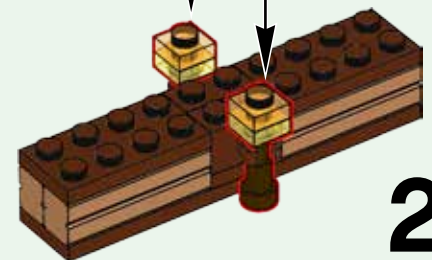

2x

502



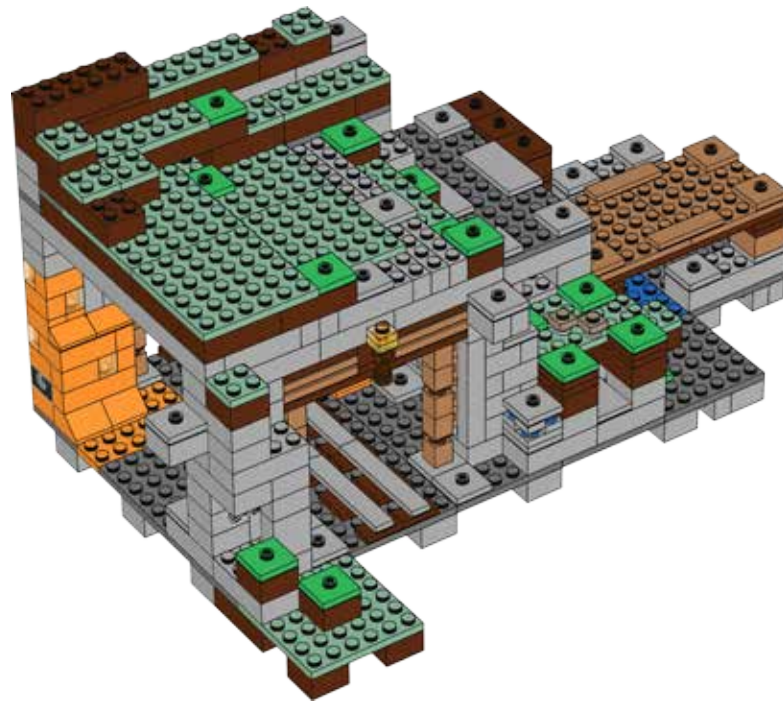

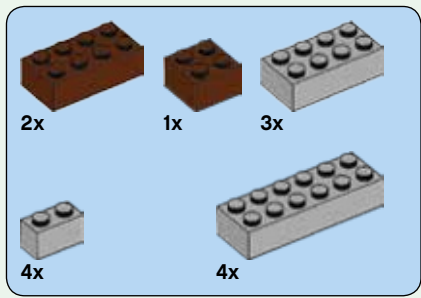

503

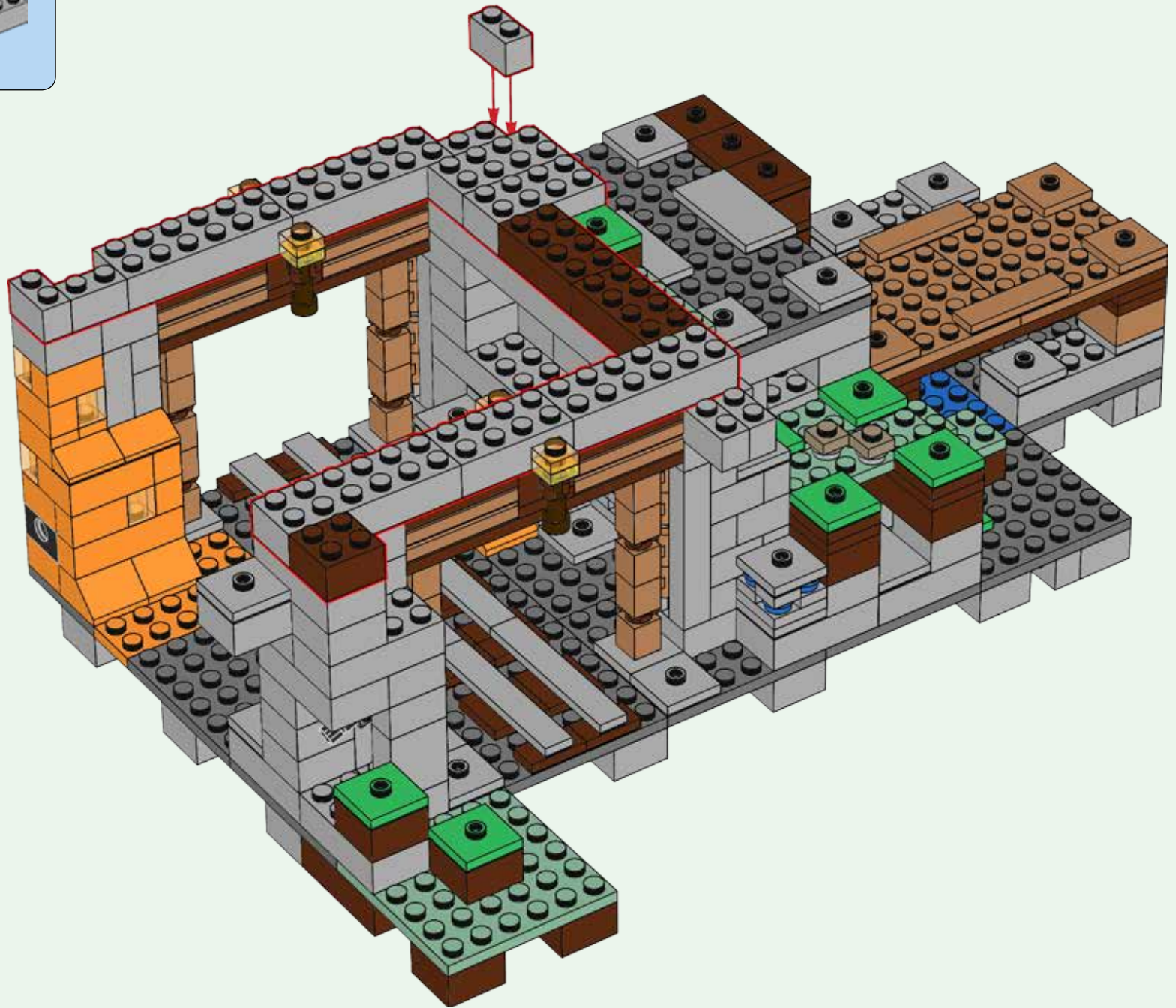

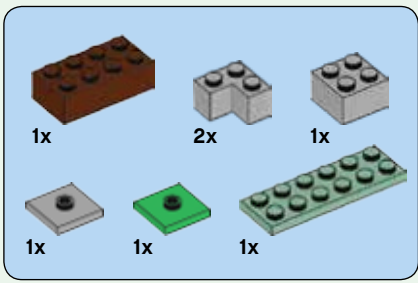

504

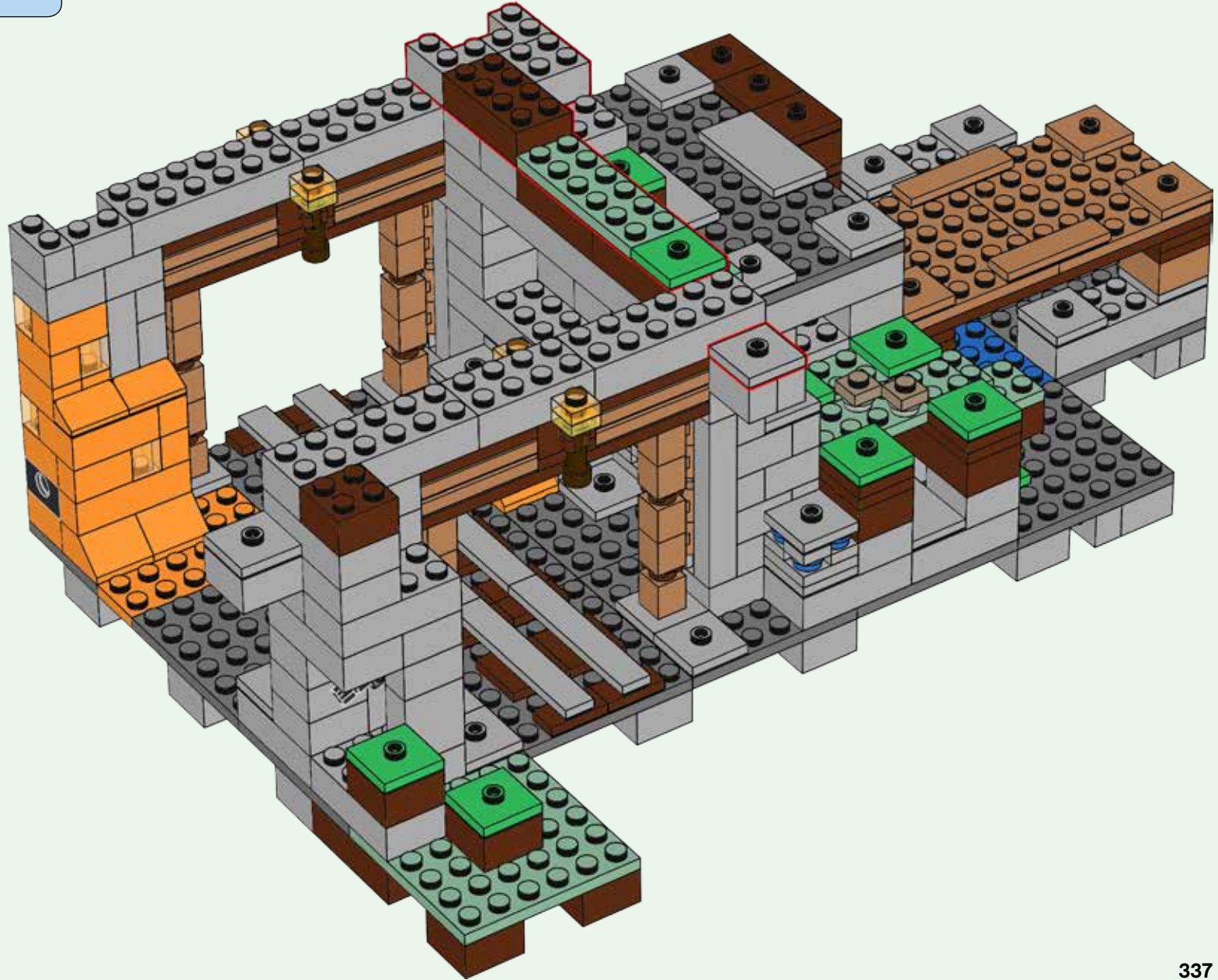
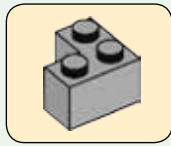

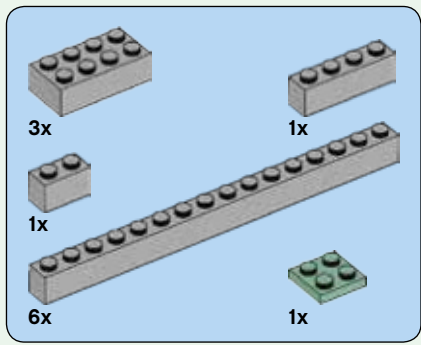

505



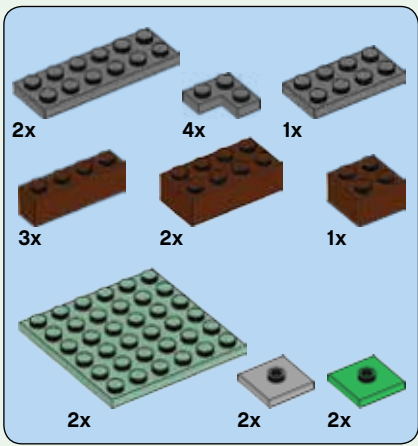

506

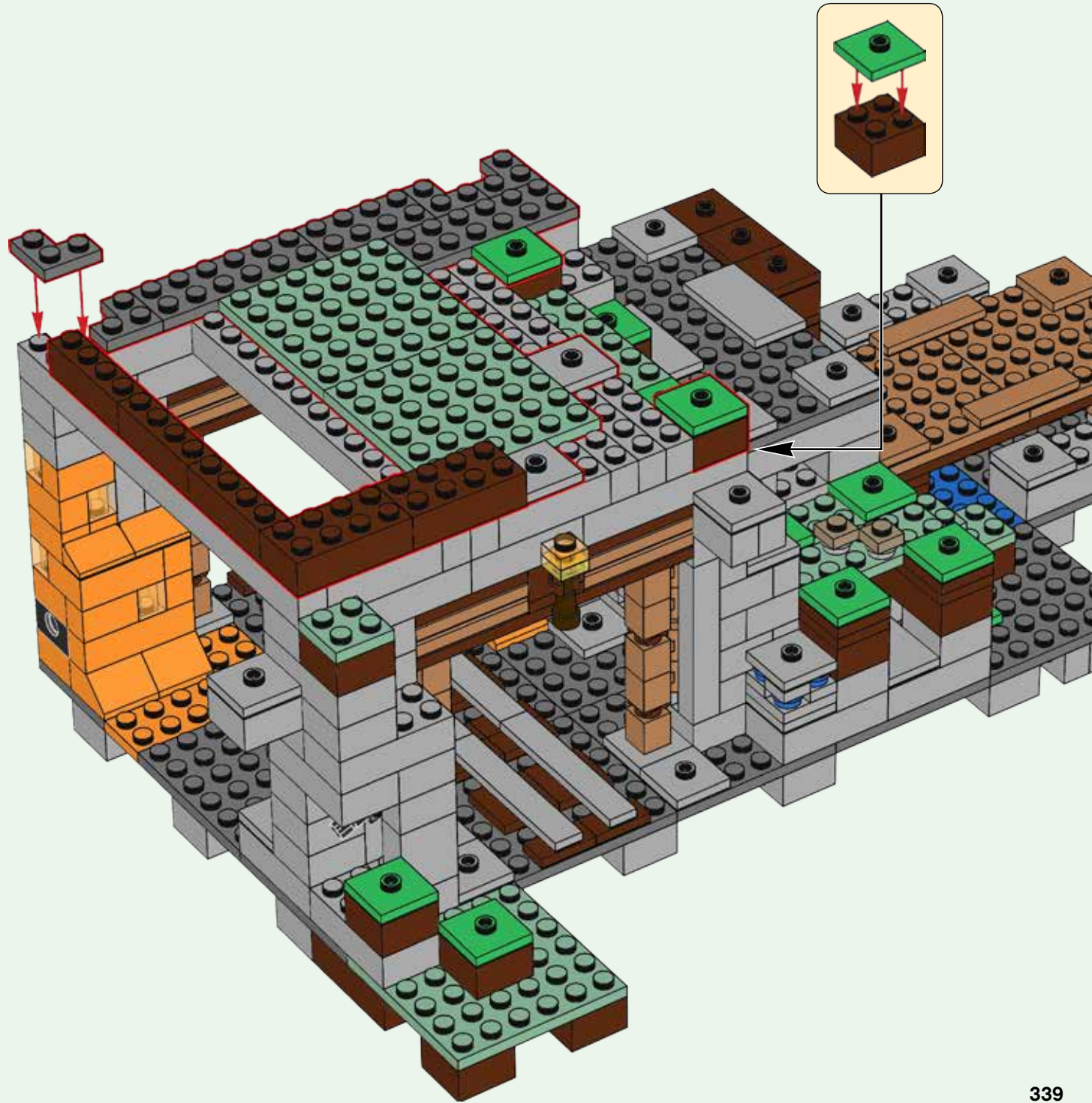

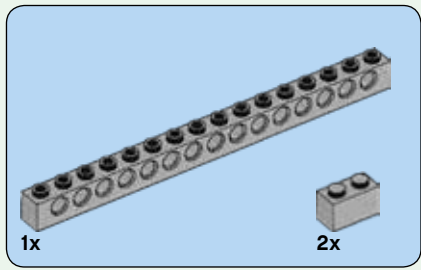

507

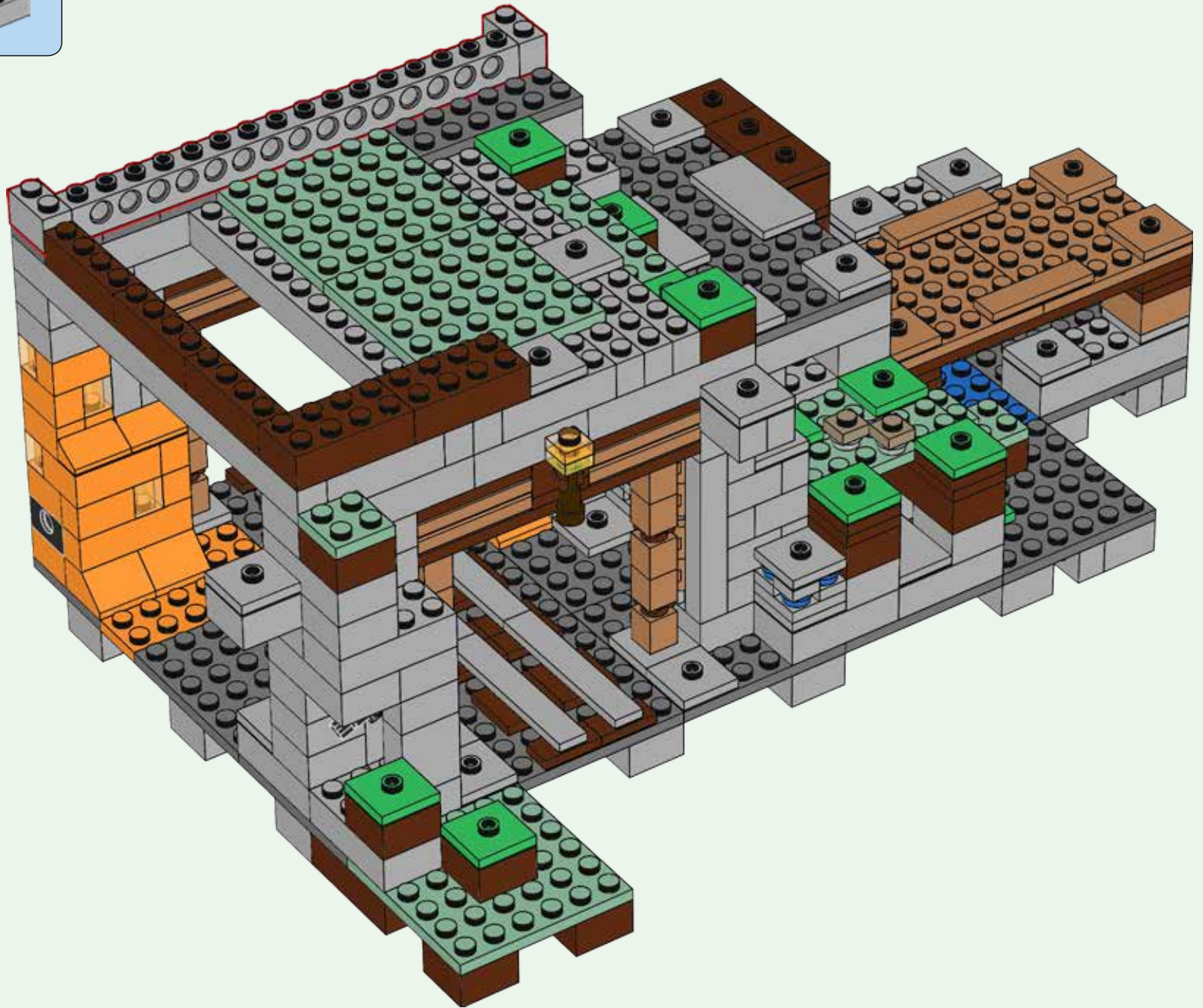

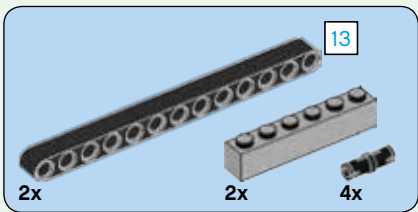

508

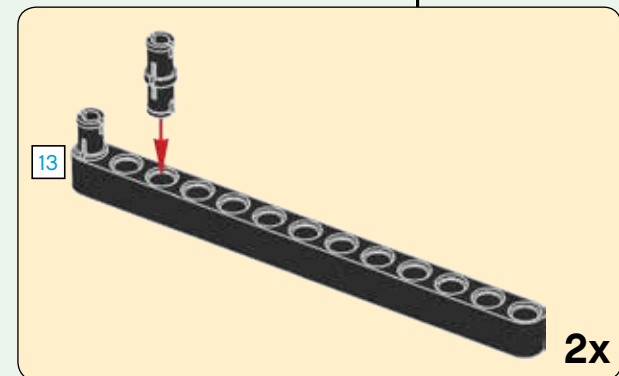
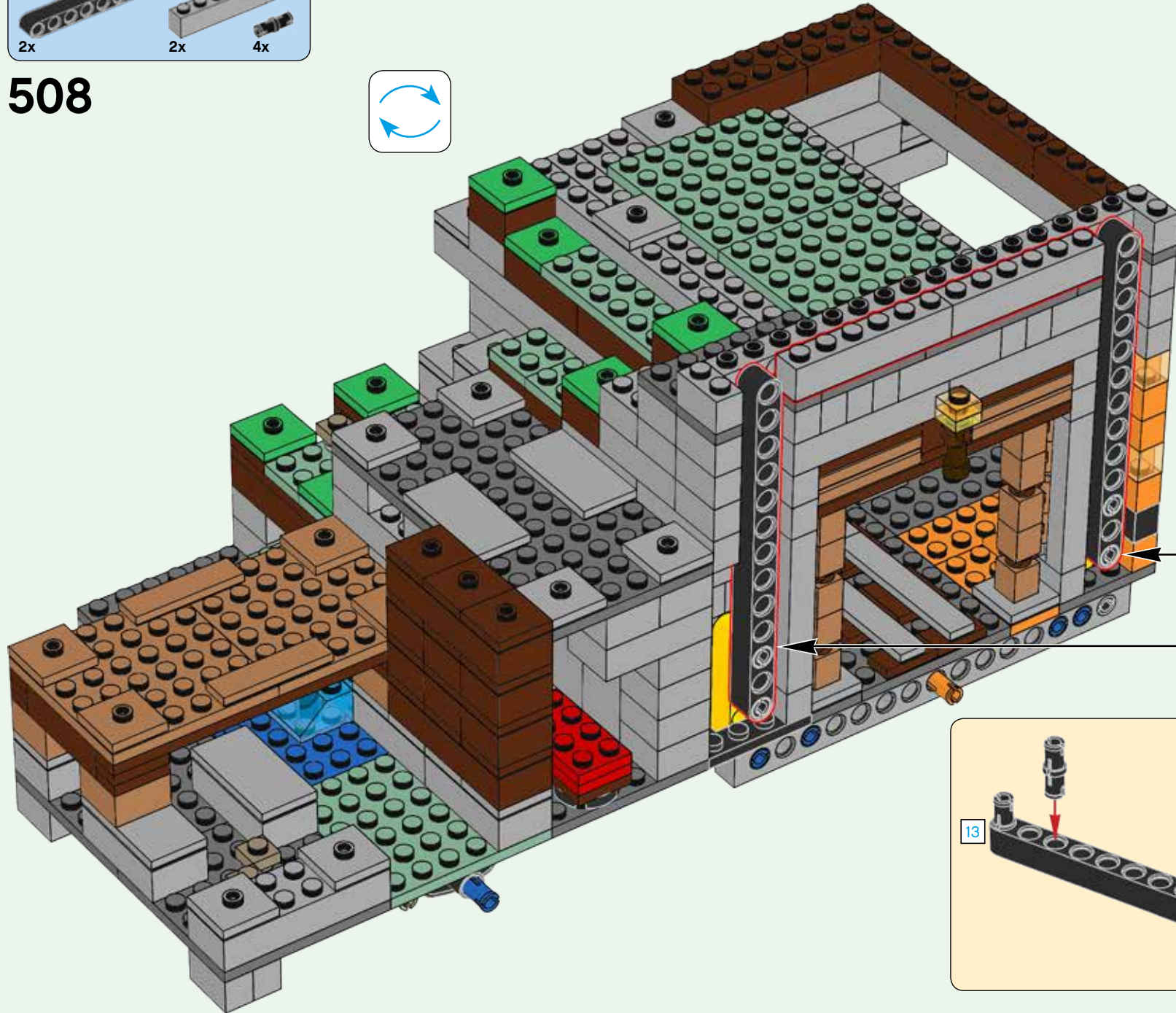
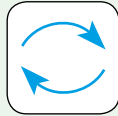
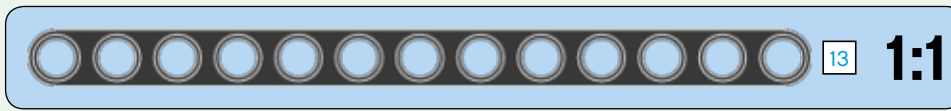

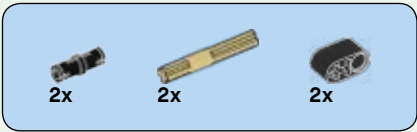

509

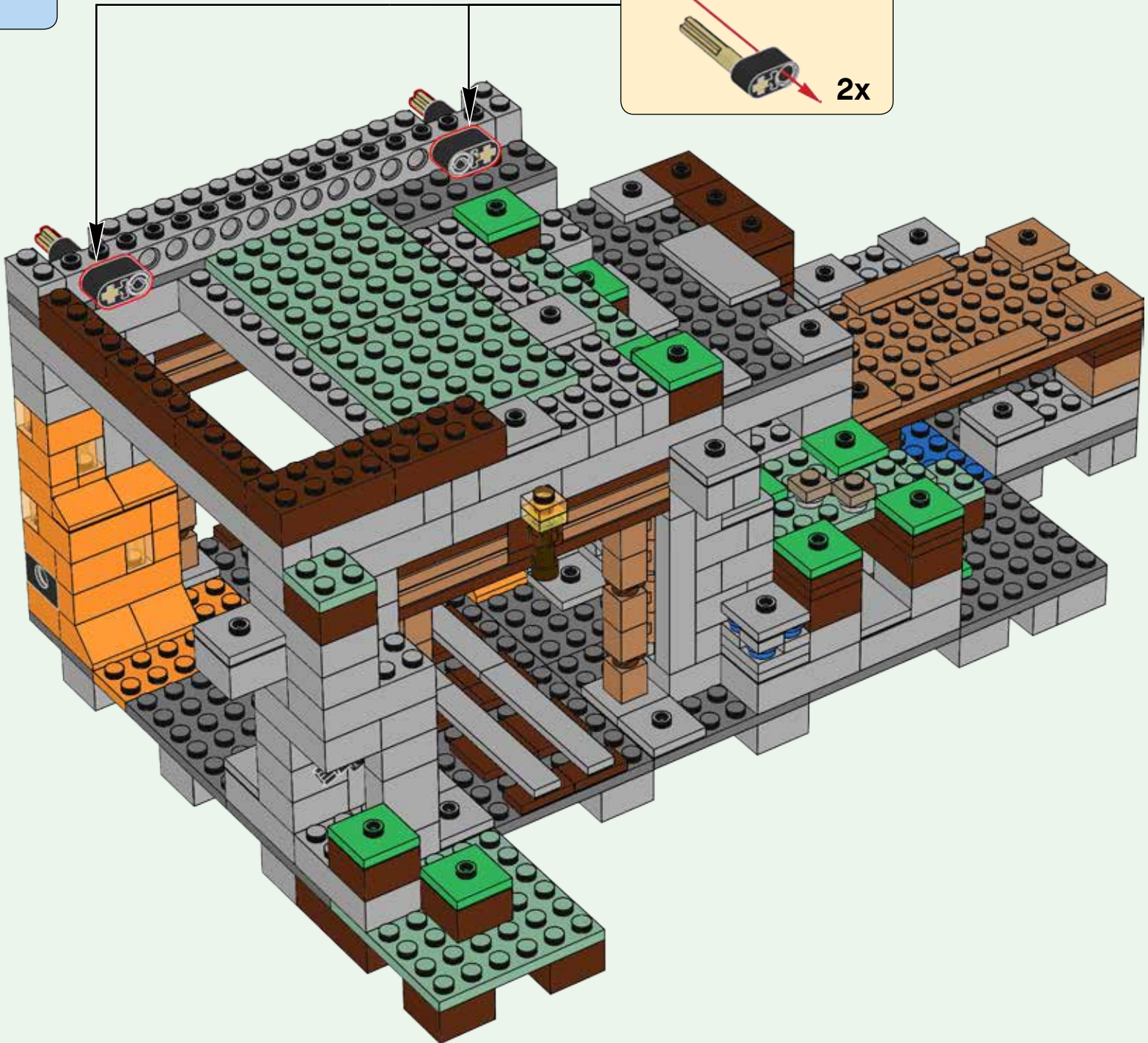
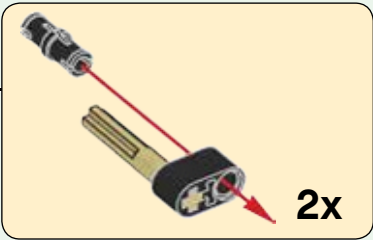

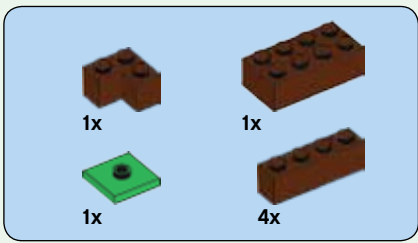

510

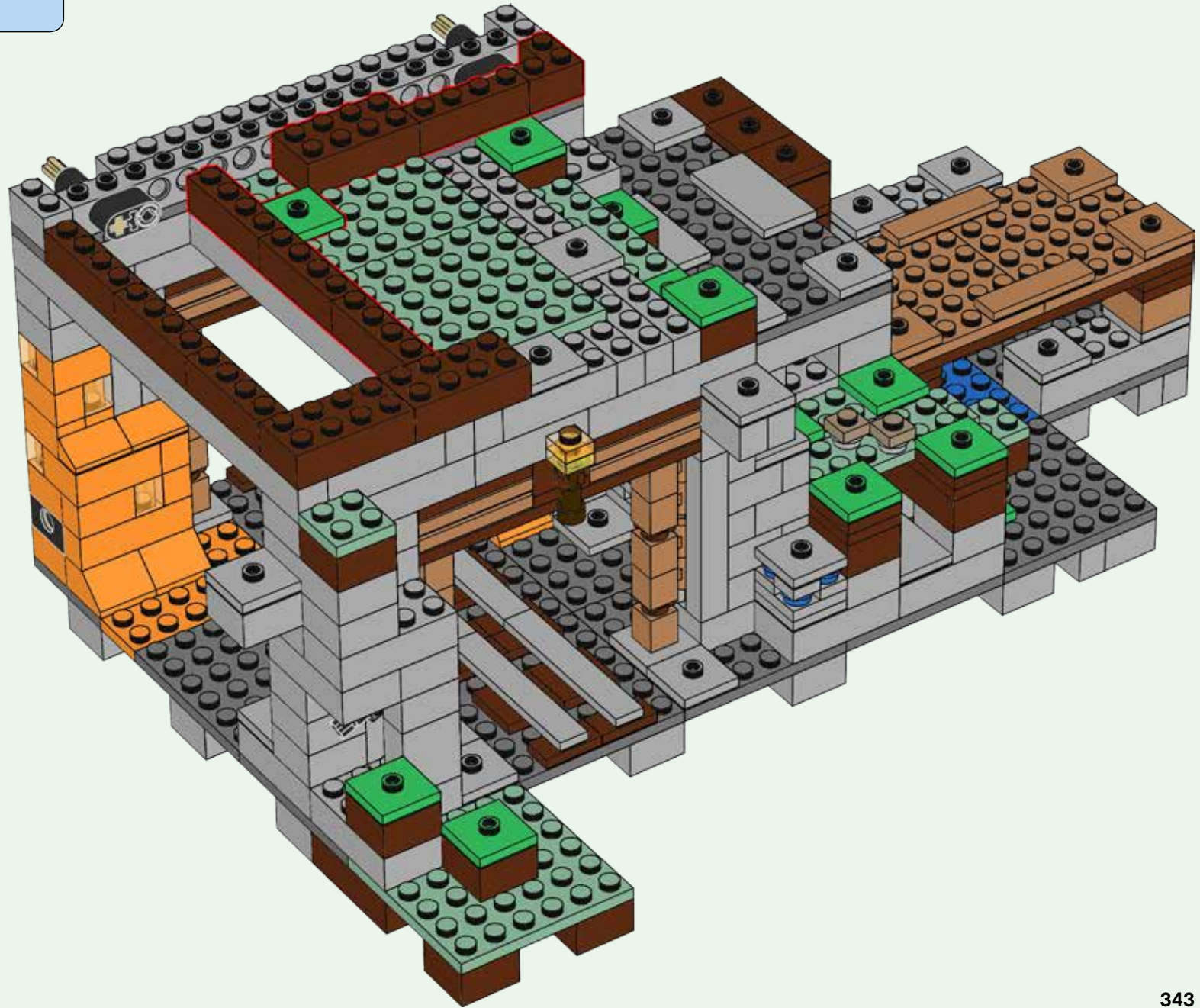

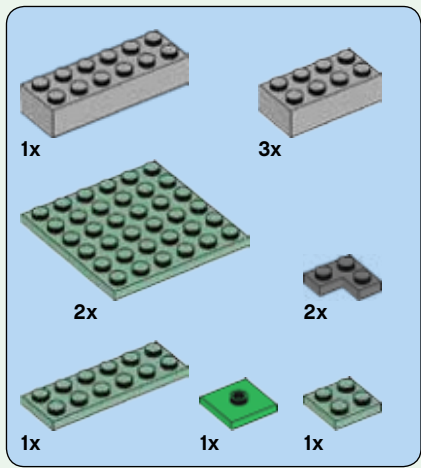

511



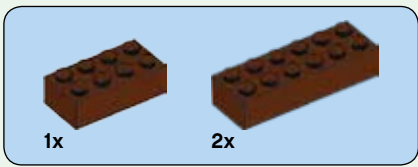

512

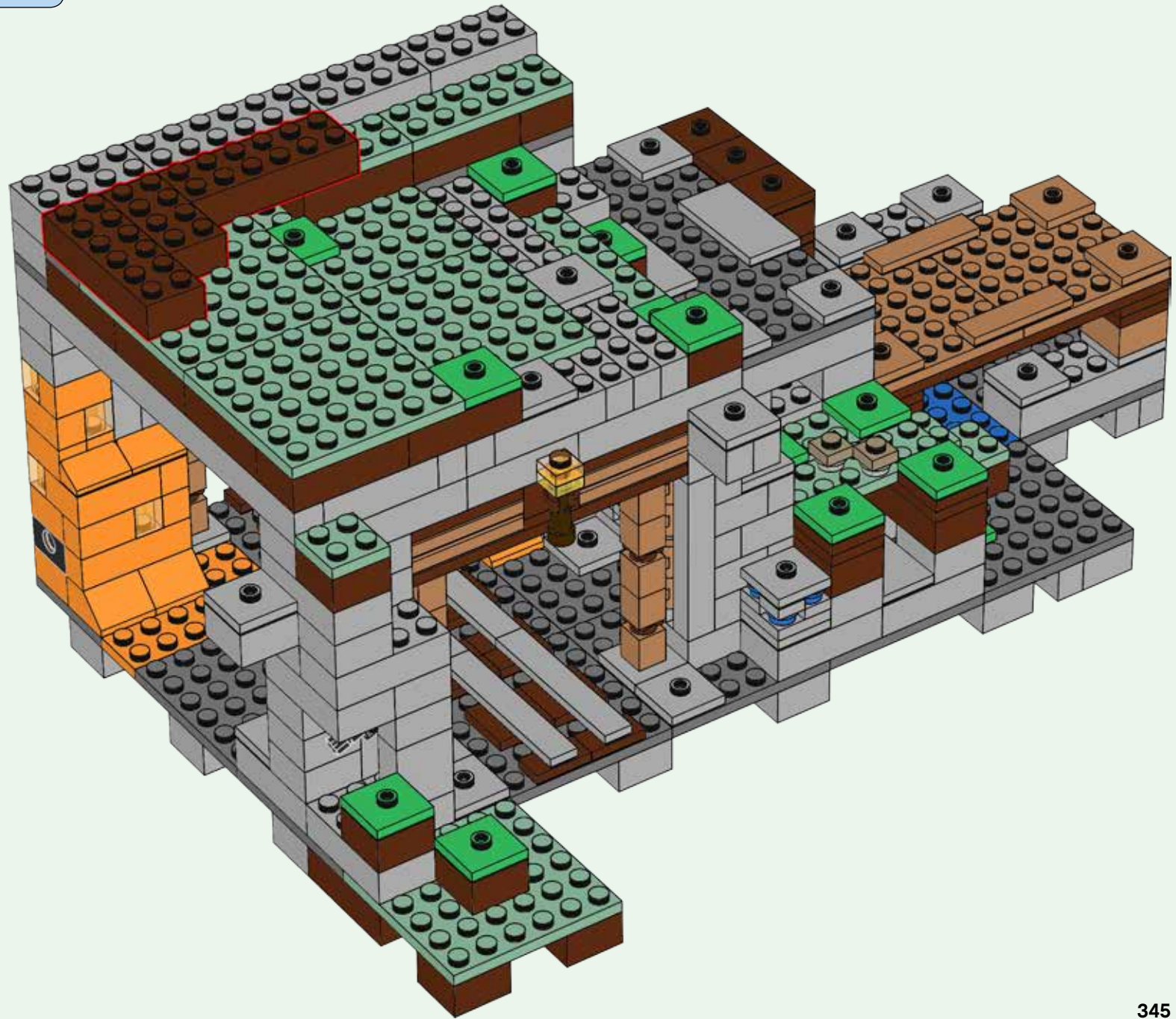

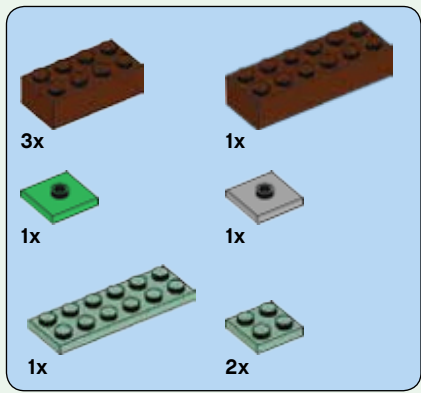

513

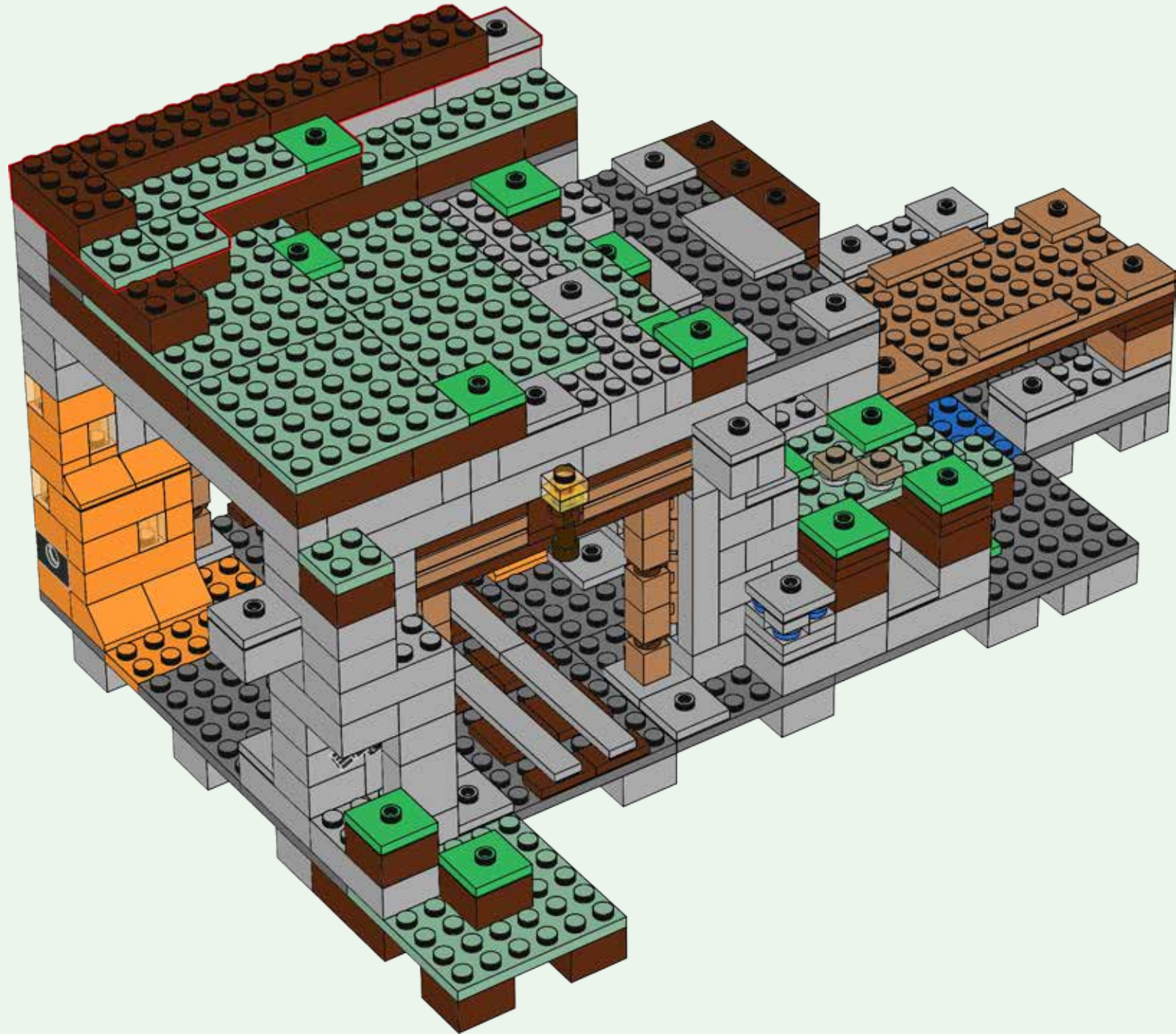

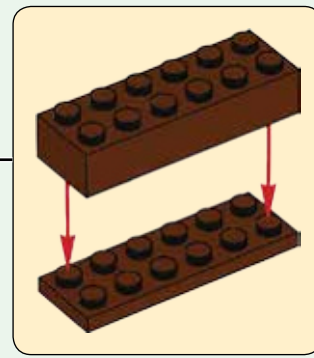
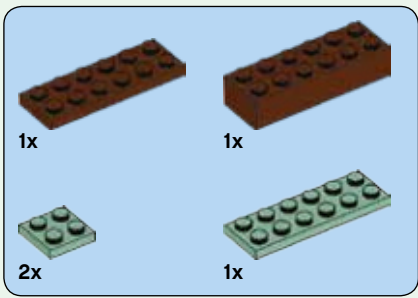

514

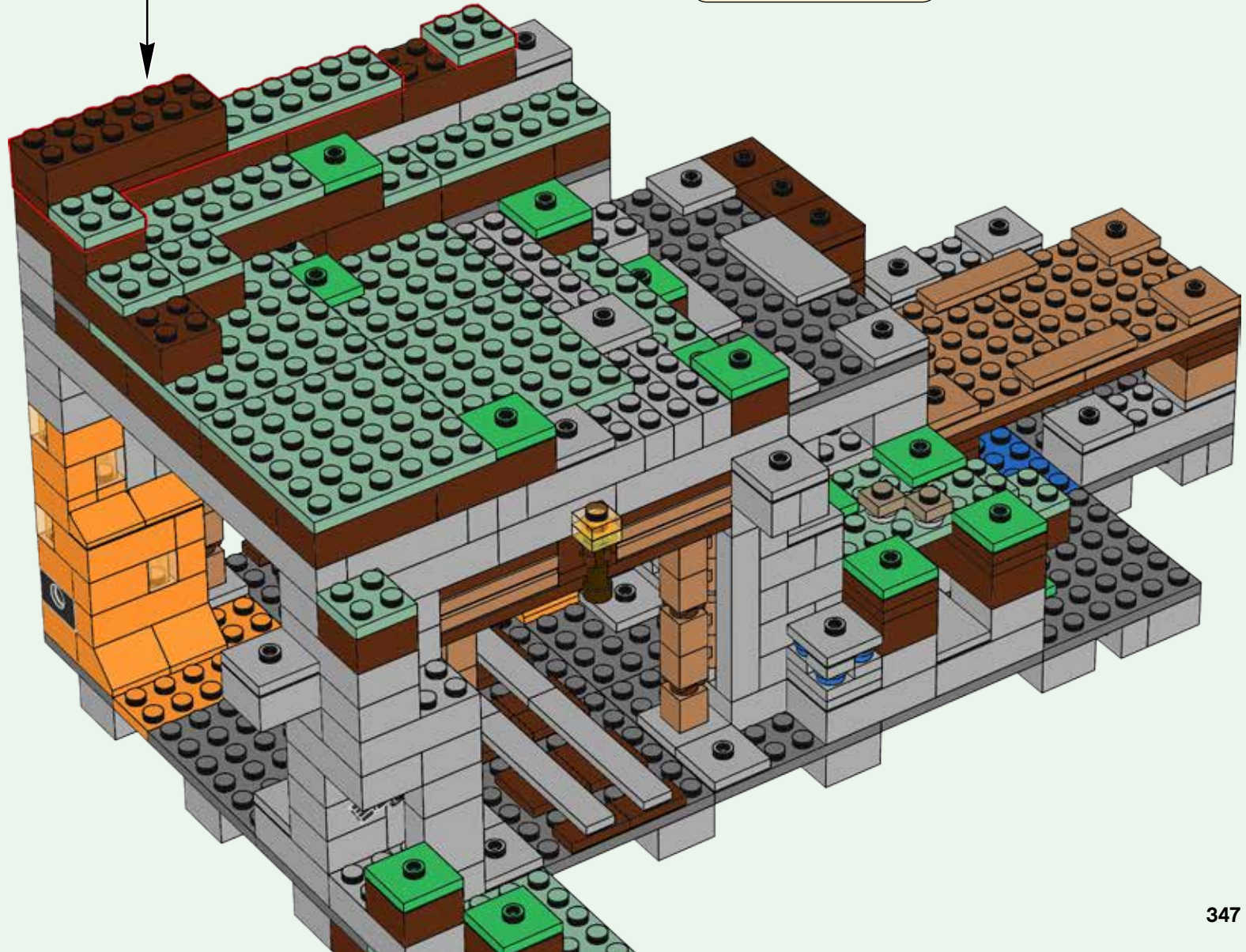



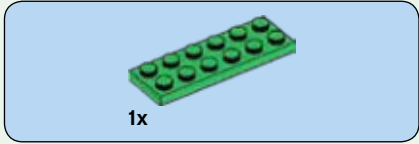
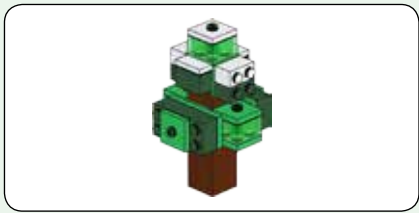

516

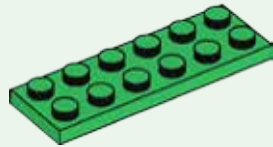

517

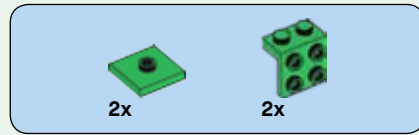
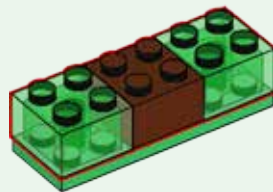

518

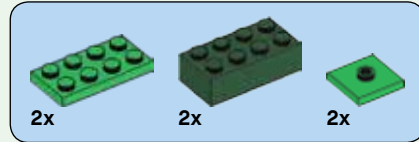
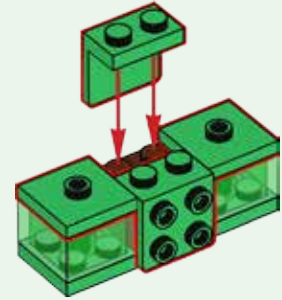

519

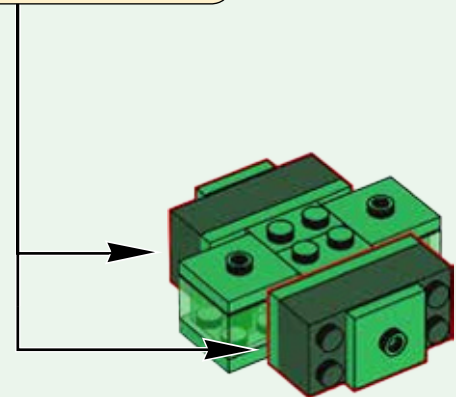
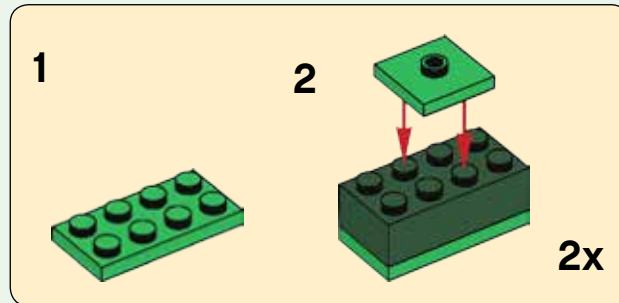

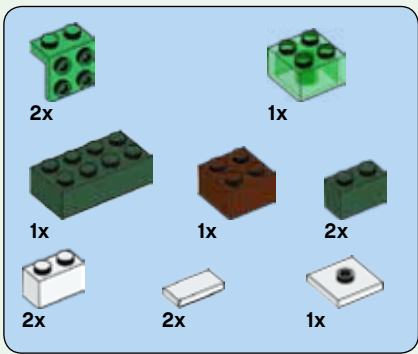

520

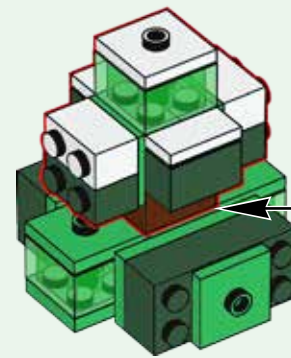
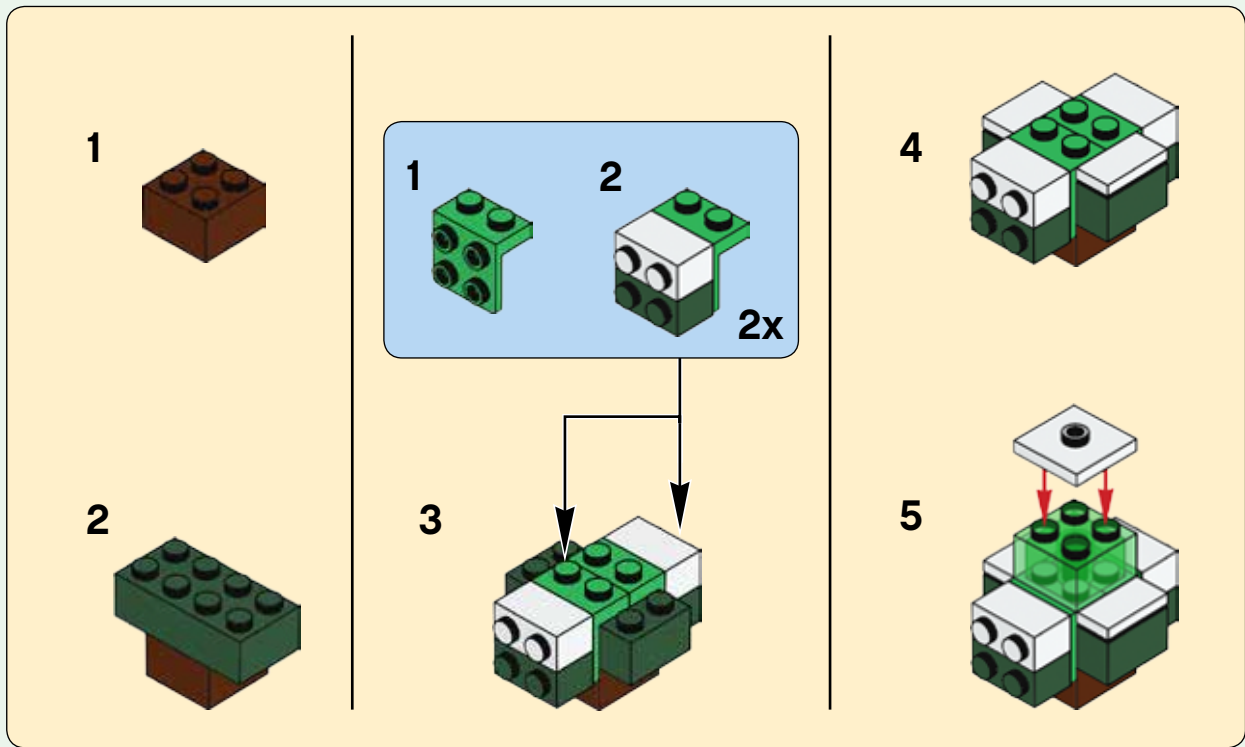

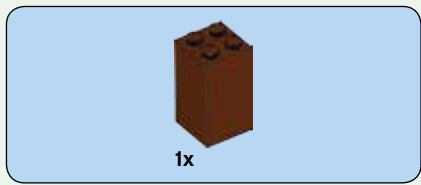

521

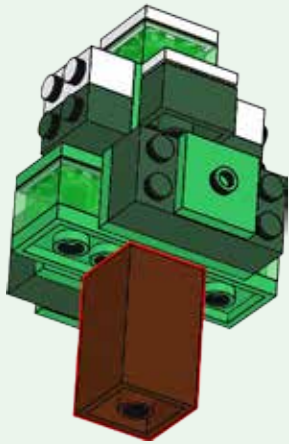

522

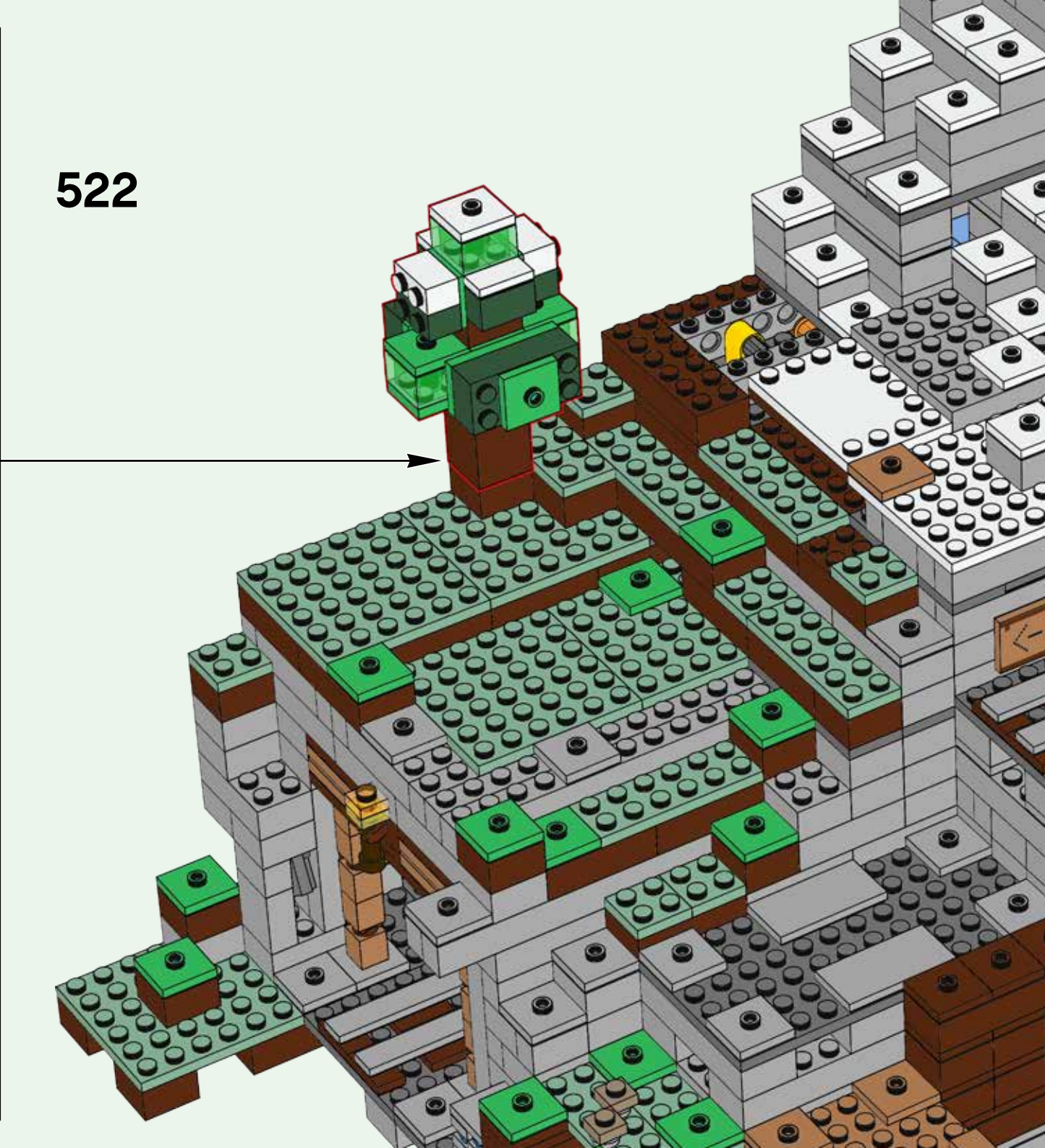

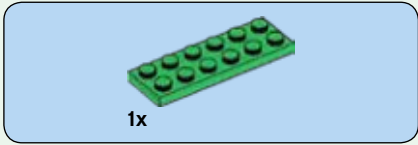

523

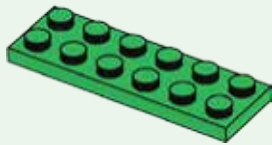

524

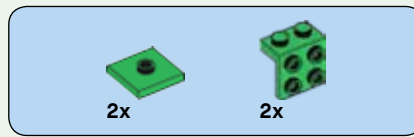
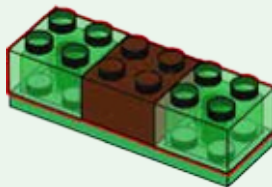

525

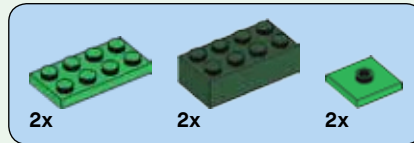
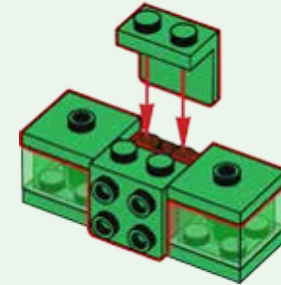

526

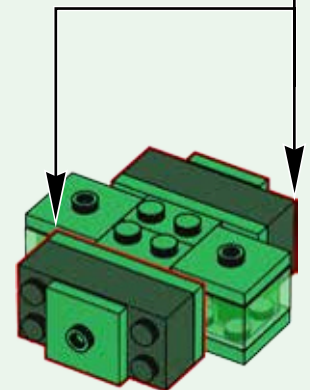
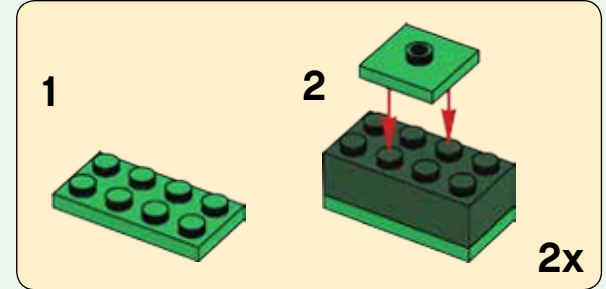

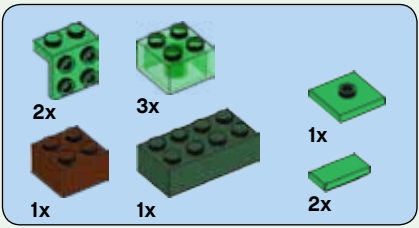

527

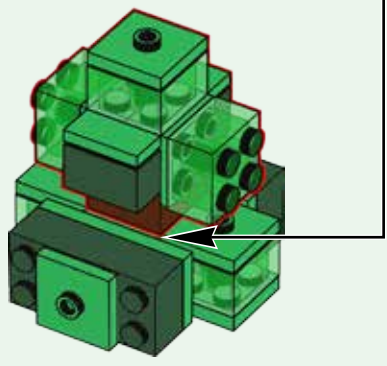
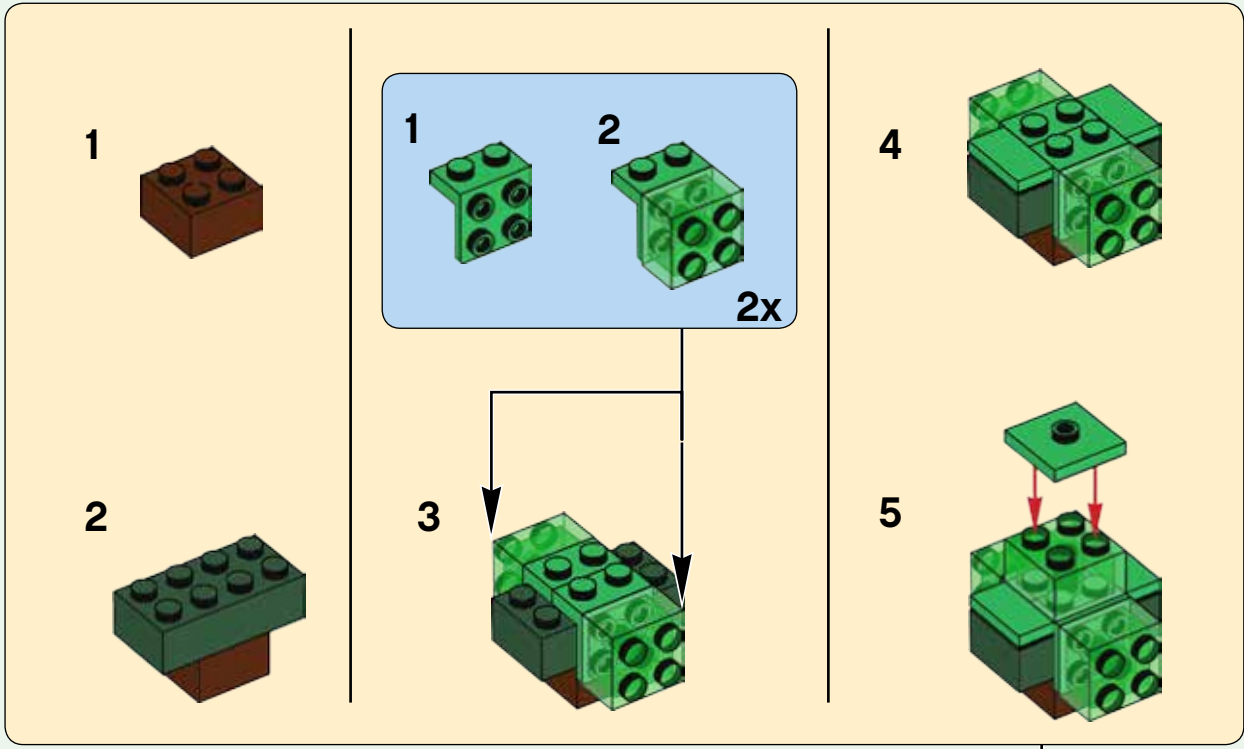

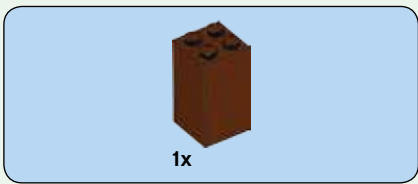

528

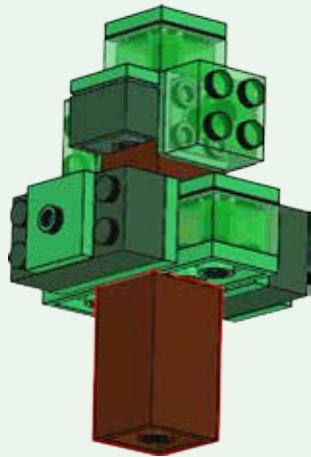

529

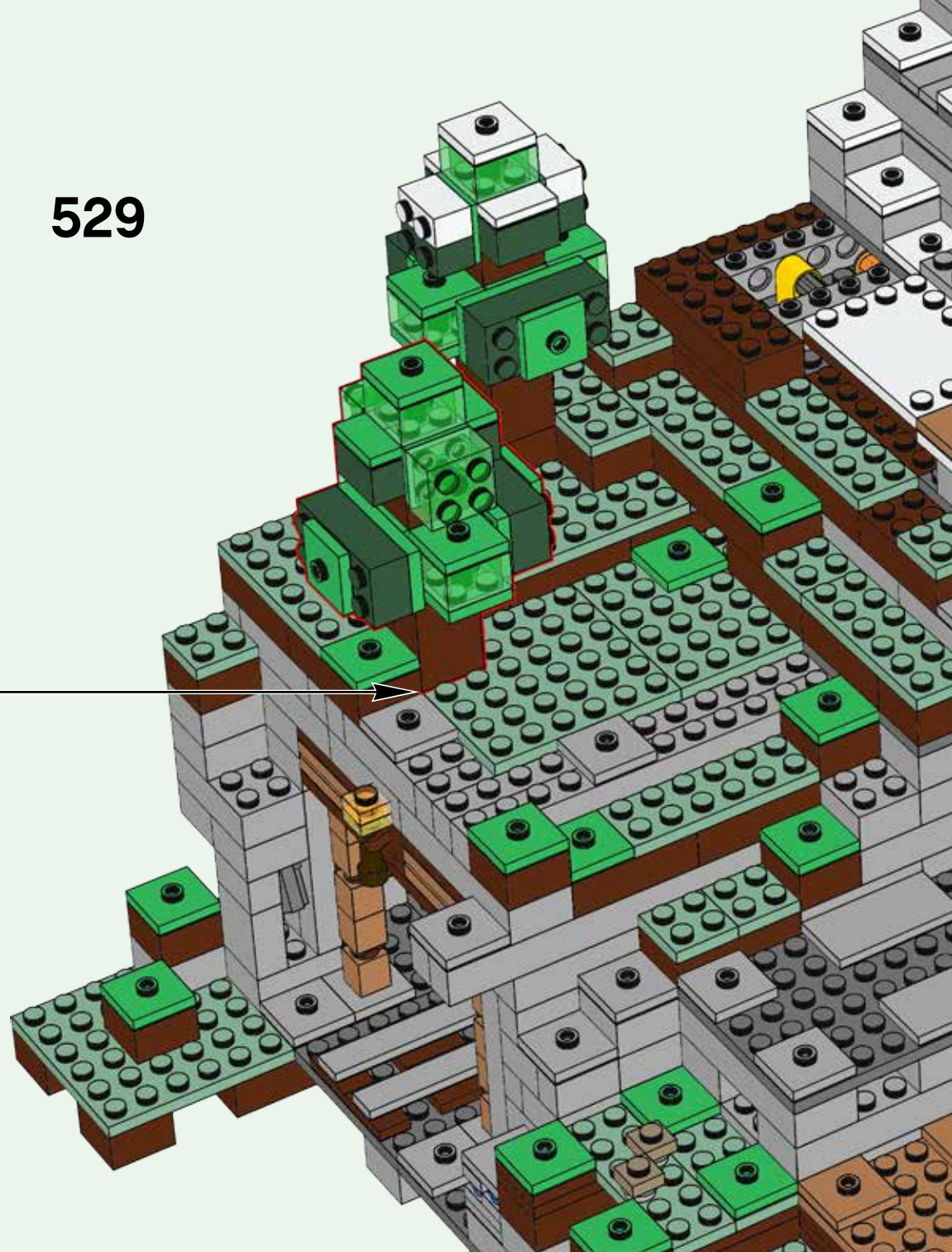



530

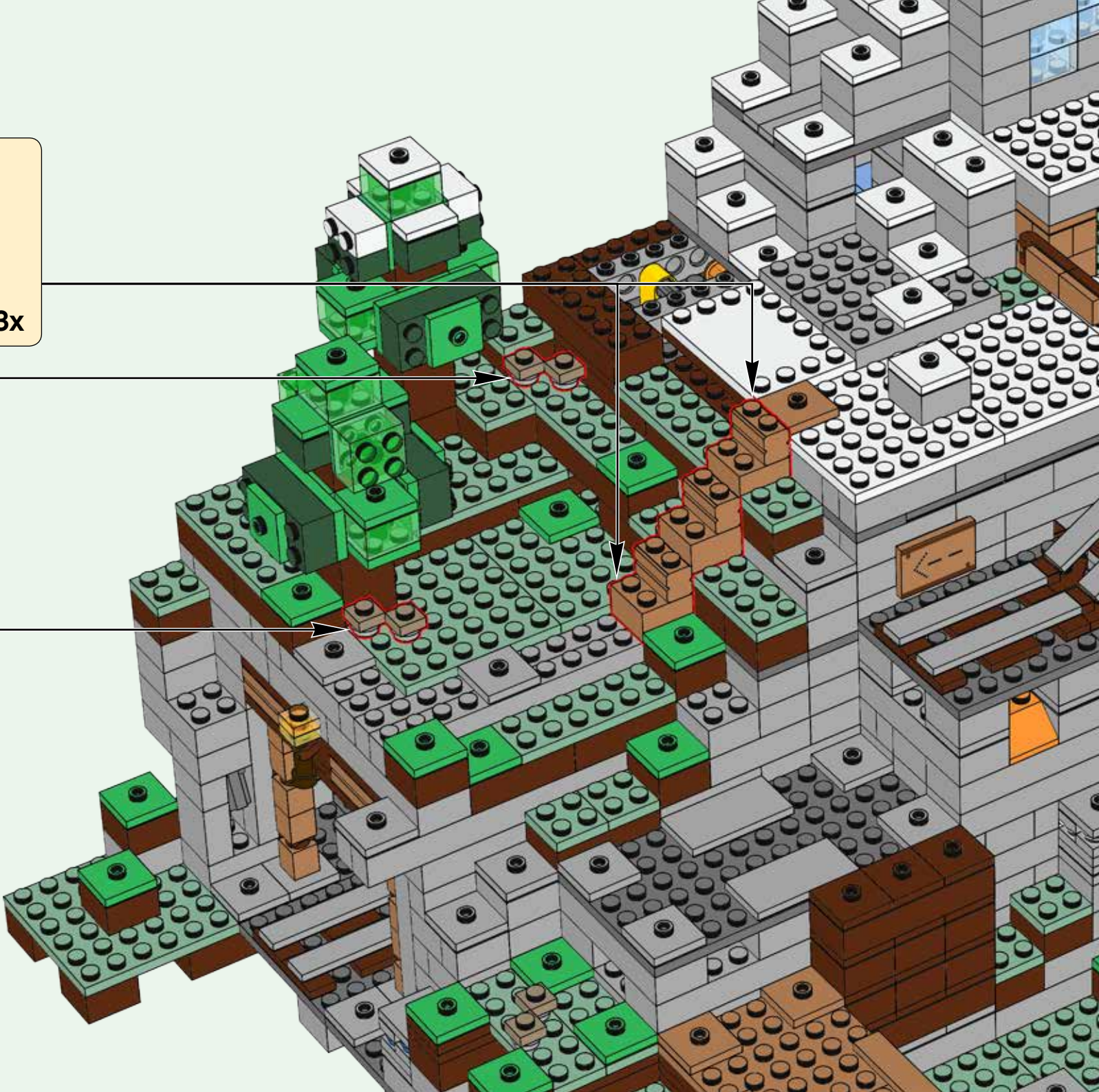
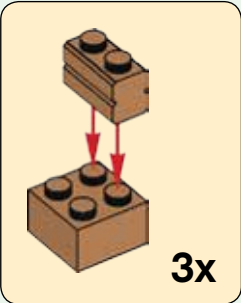

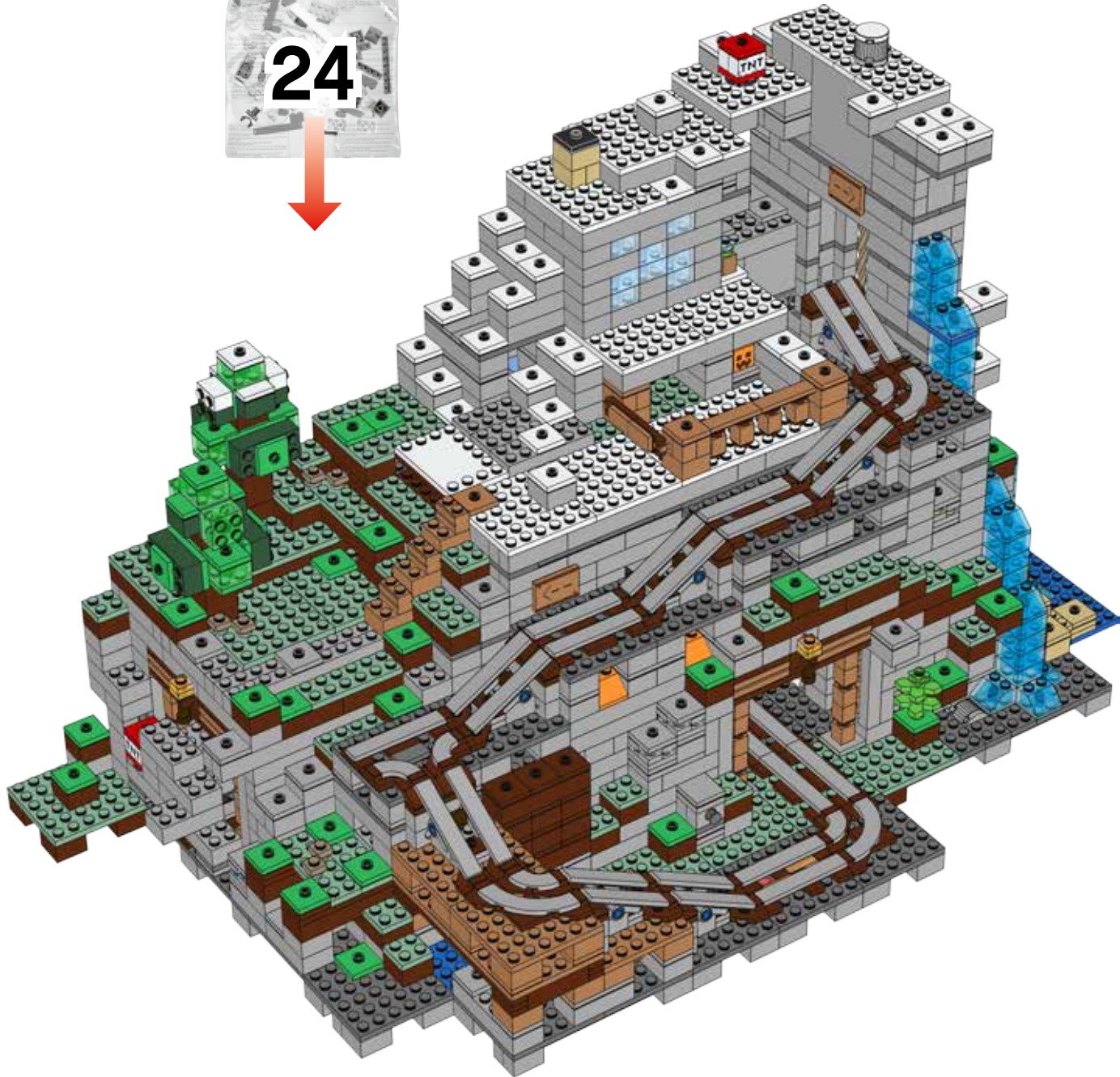

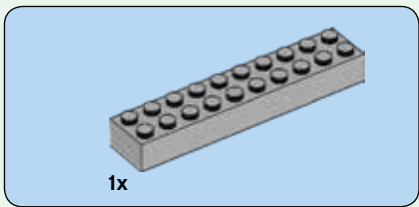

1x

531

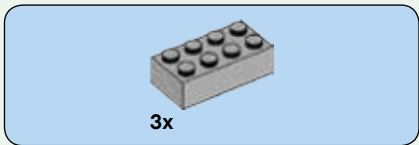
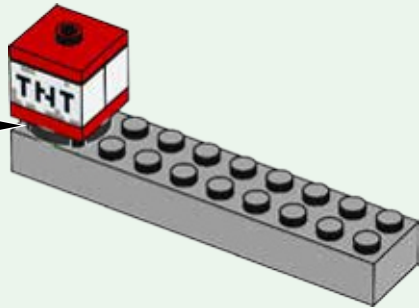
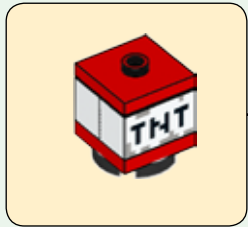

3x

532

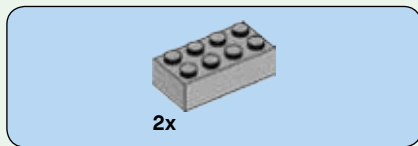
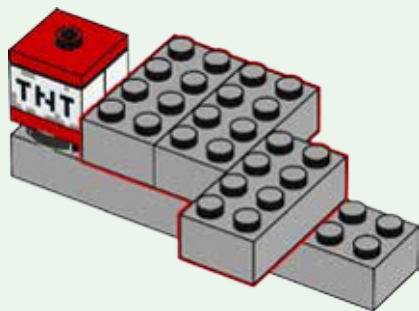

2x

533

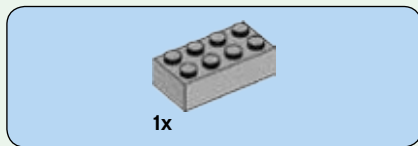
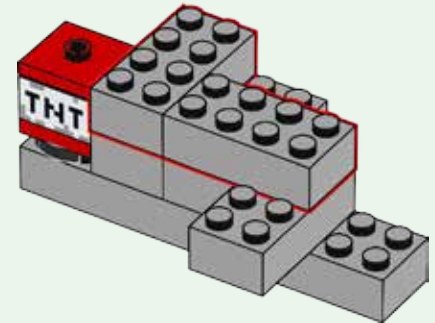

1x

534

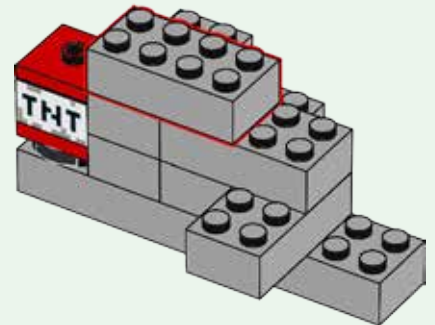

2x

535



2x

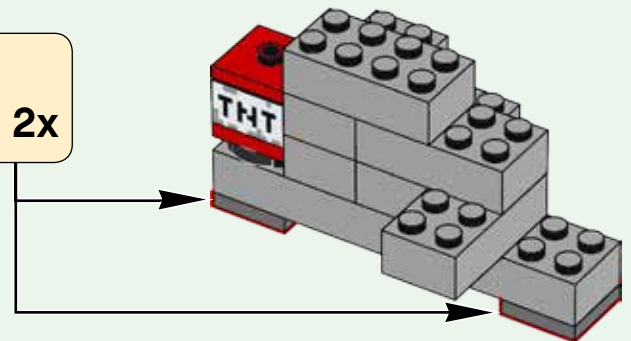

536



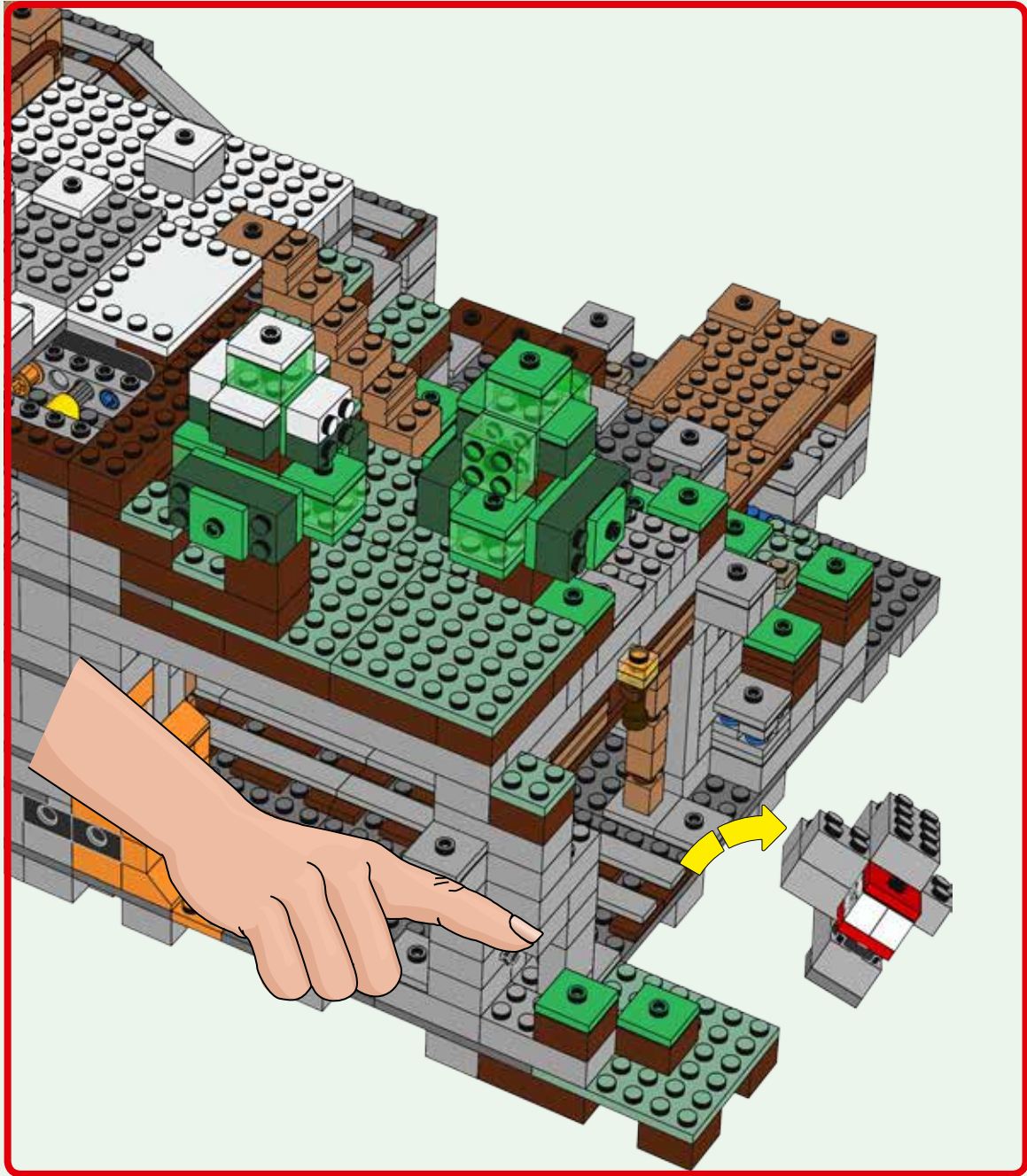

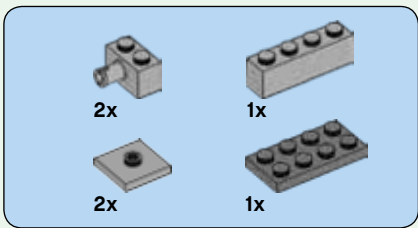

537

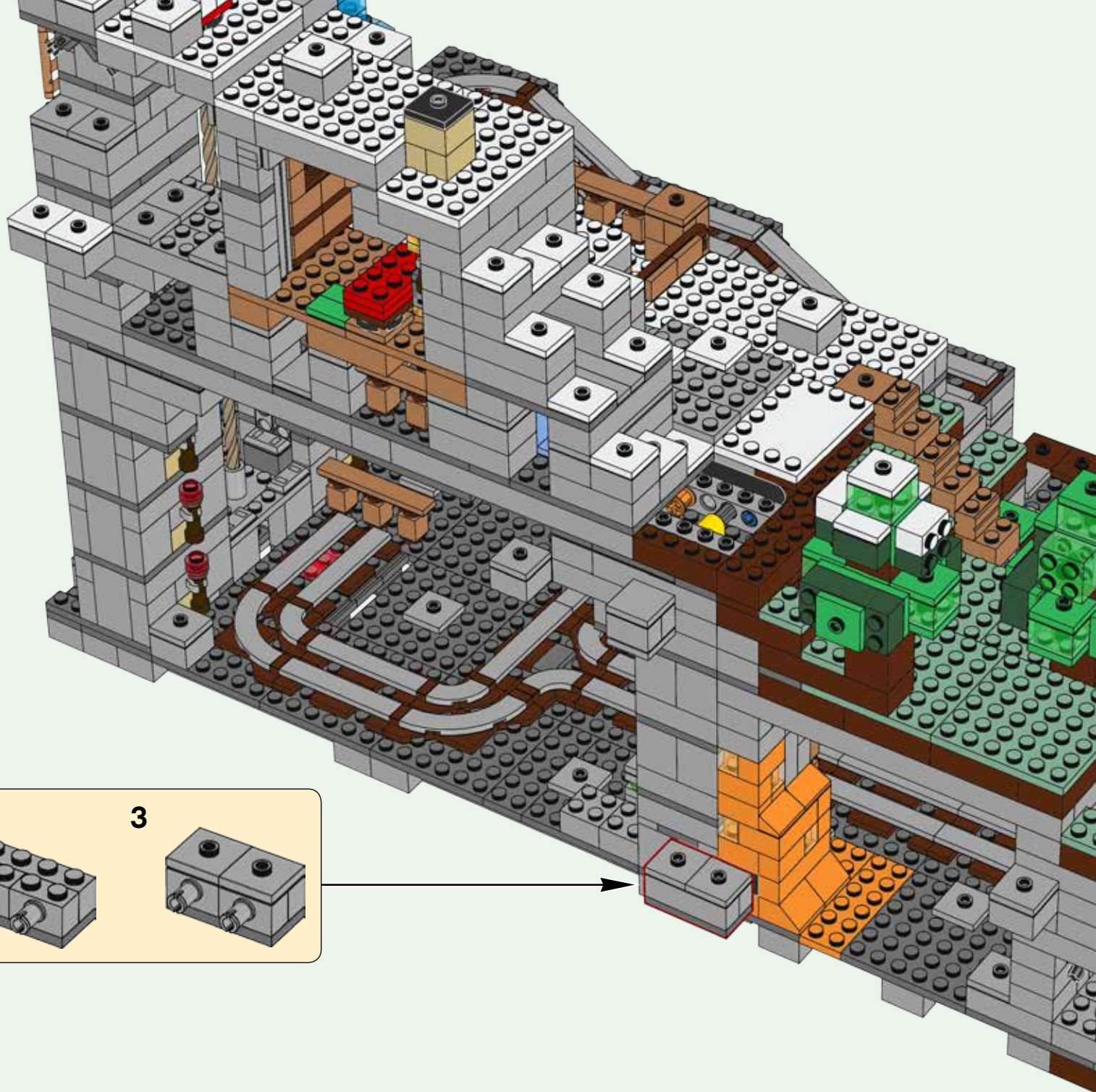
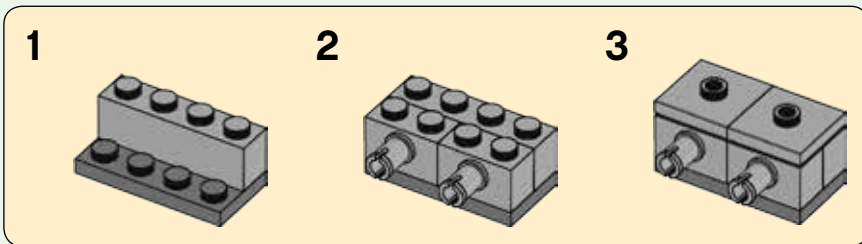
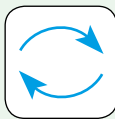

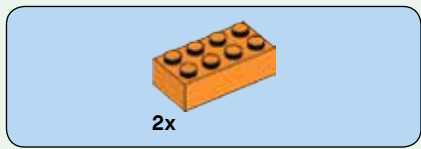

538

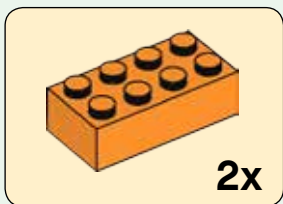
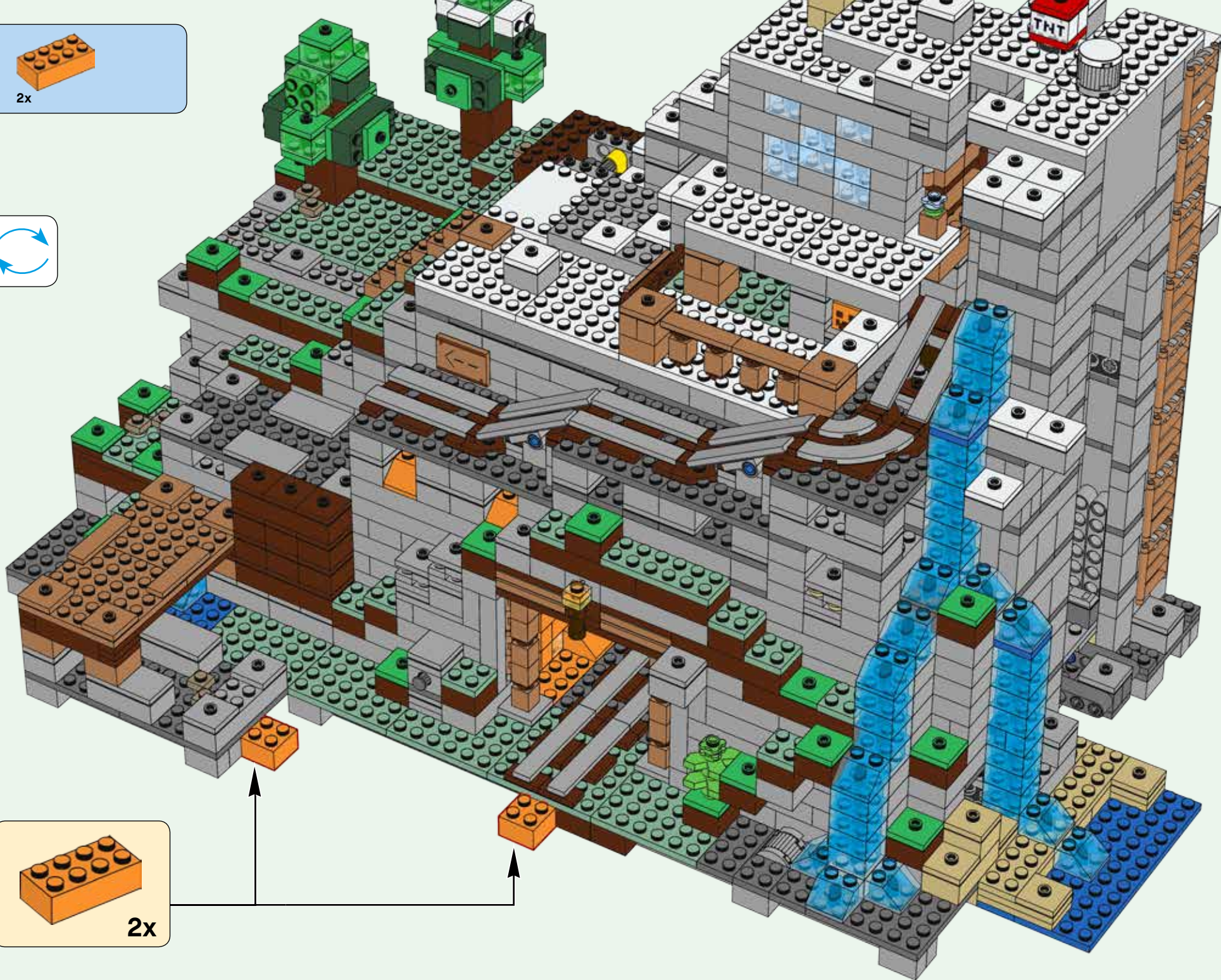

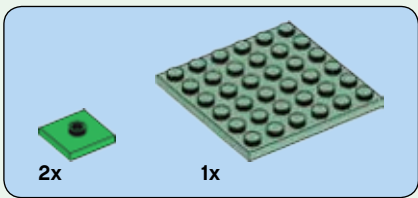

539

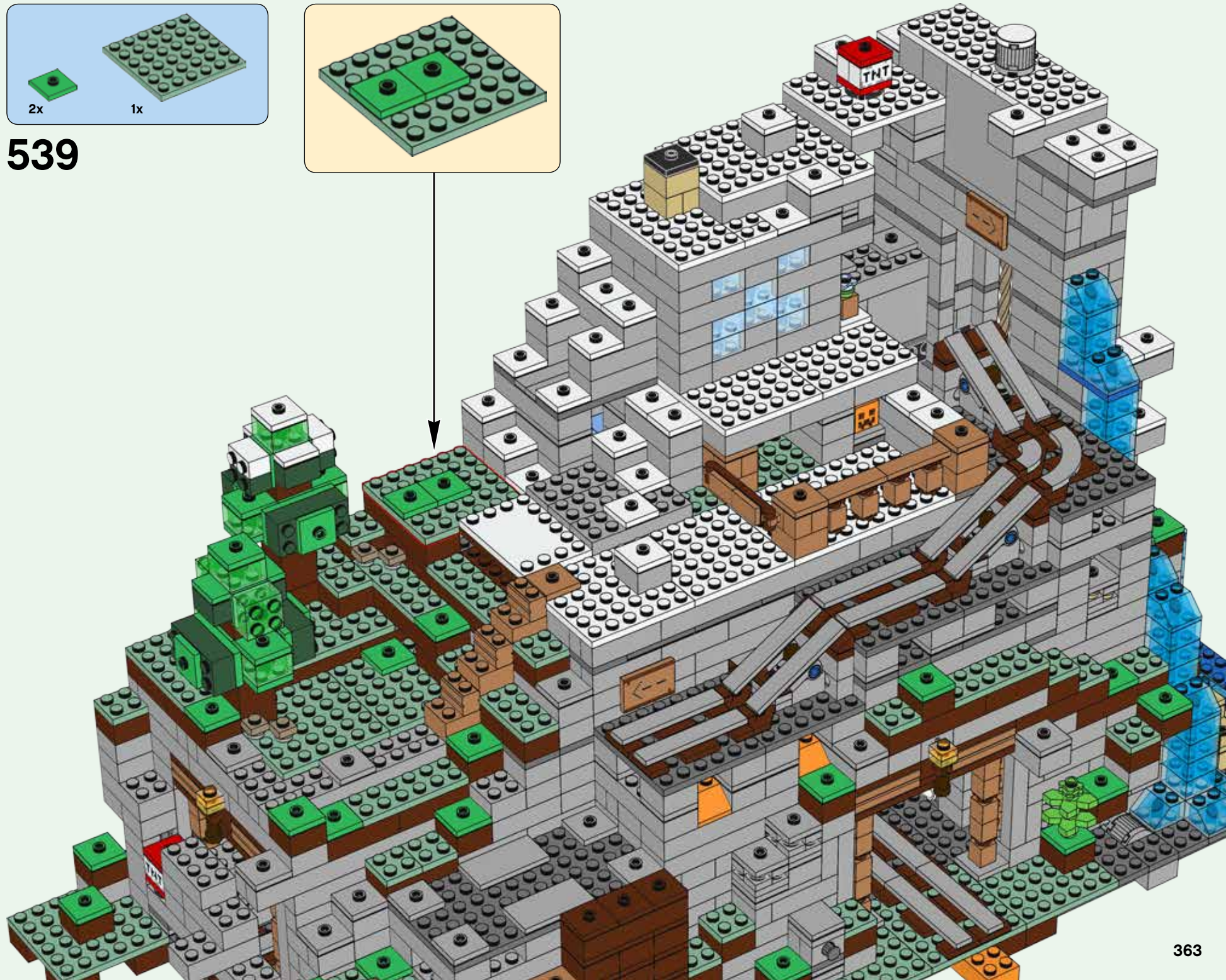
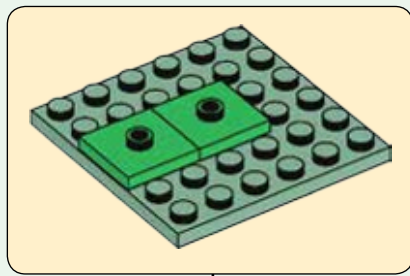

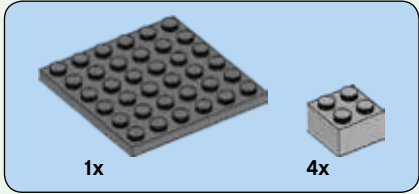
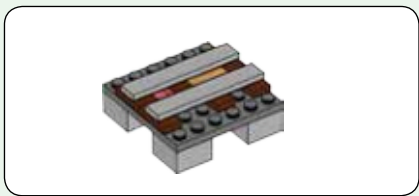

540

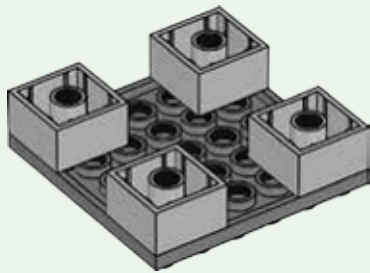

541

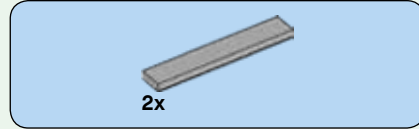
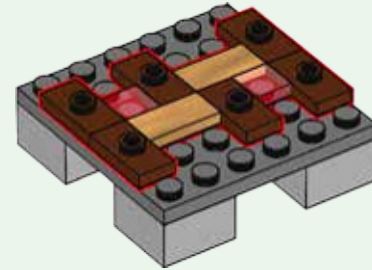
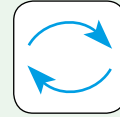

542

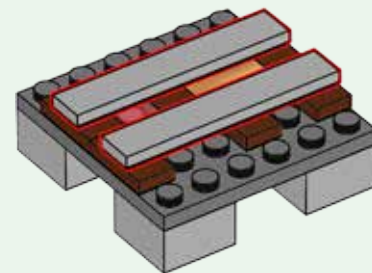

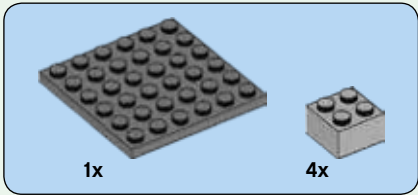
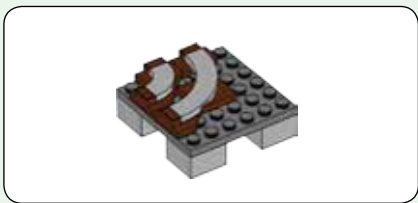

543

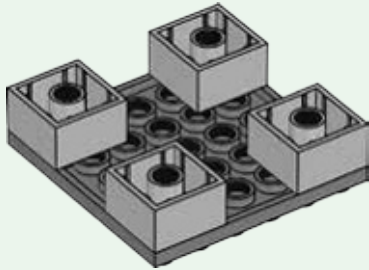

544

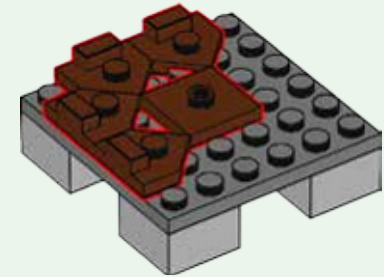
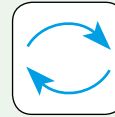

545

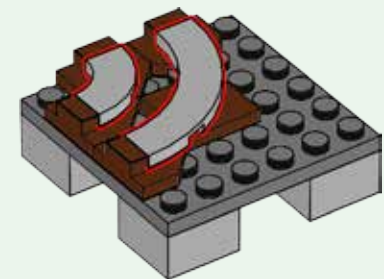

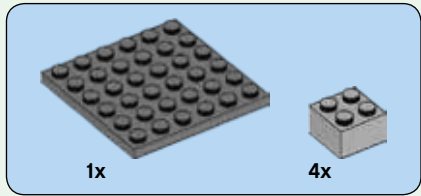
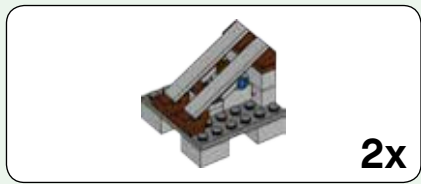

546

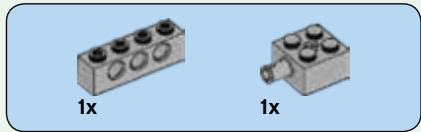
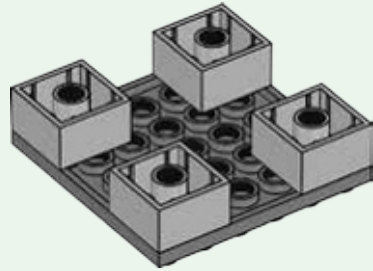

547

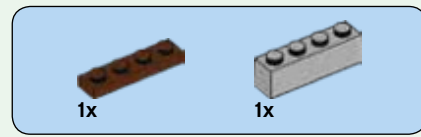
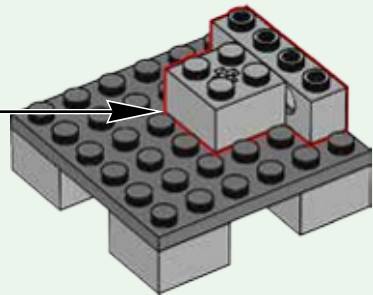
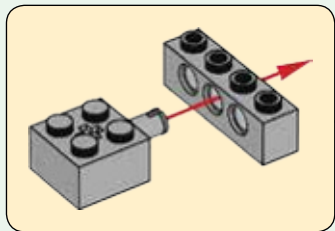
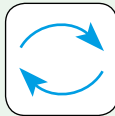

548

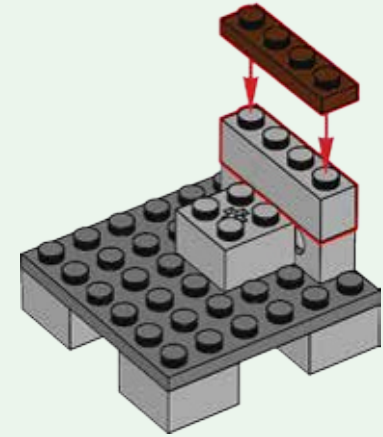

549

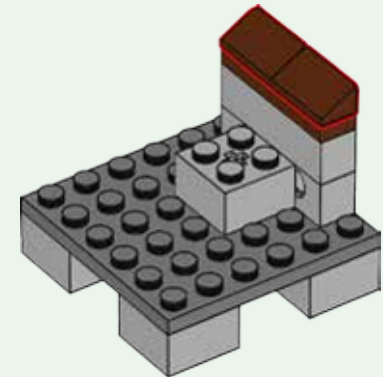



550

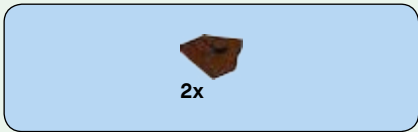
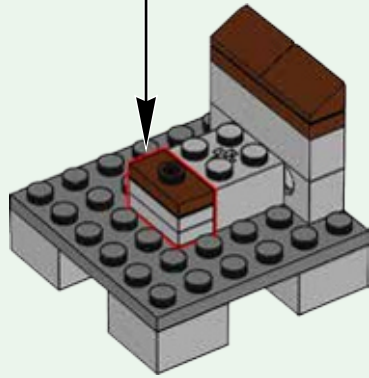
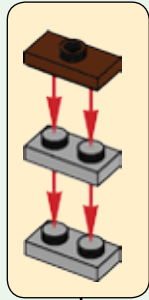

551

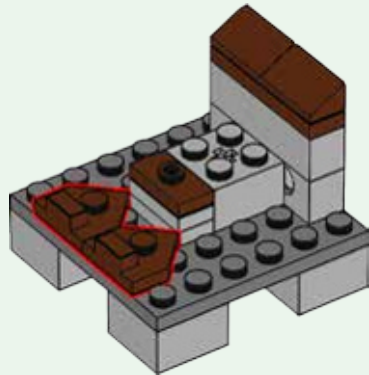

552

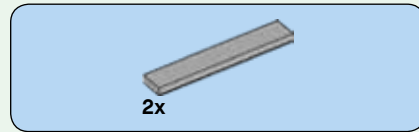
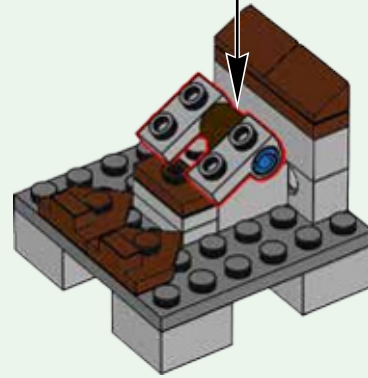
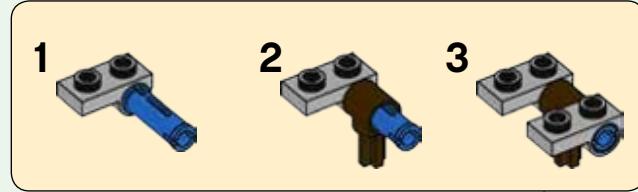

553

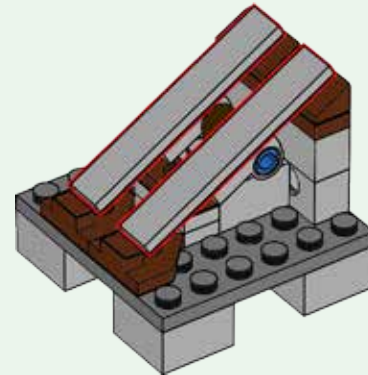

2x

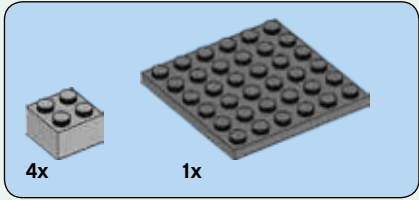
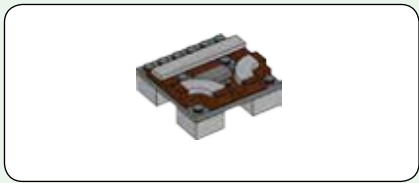

554

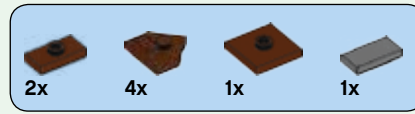
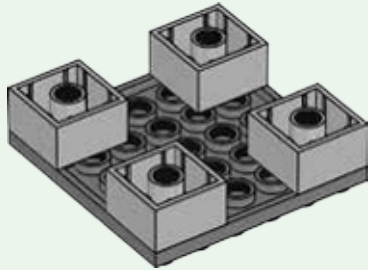

555

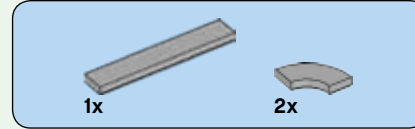
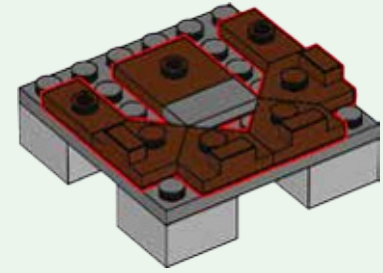
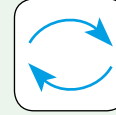

556

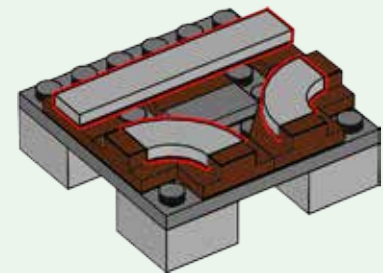

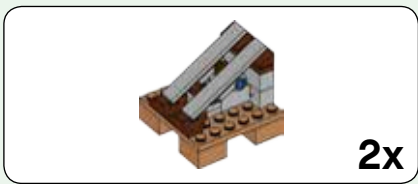

557

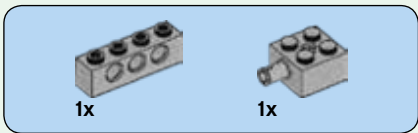
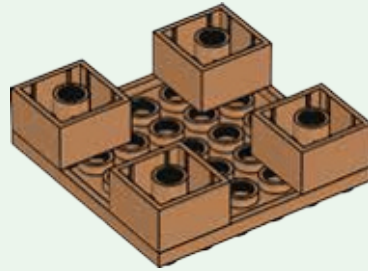

558

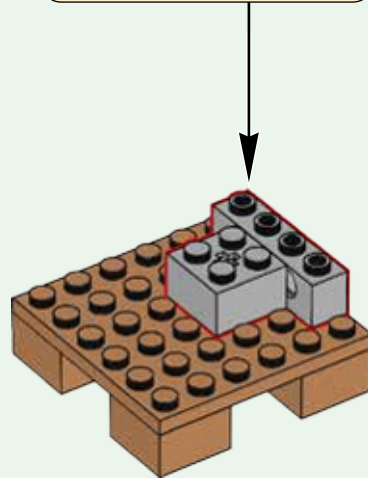
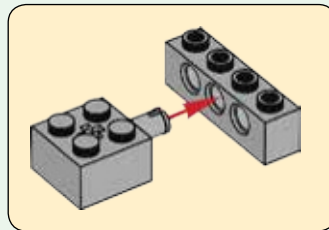
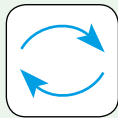

559

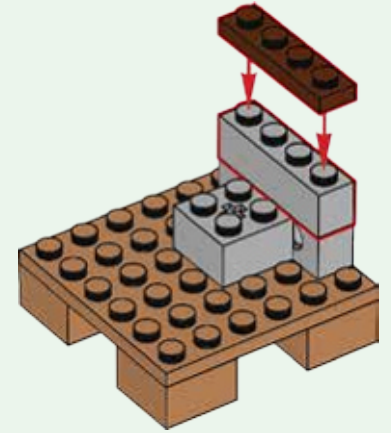

560

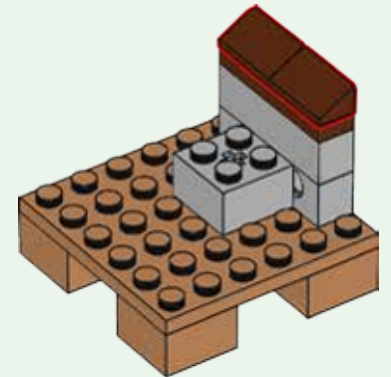



561

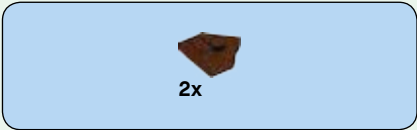
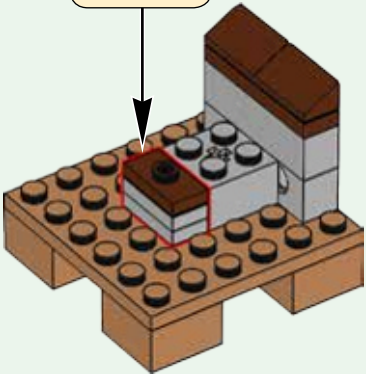
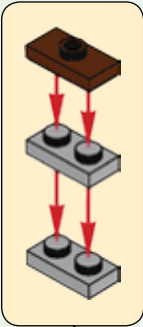

562

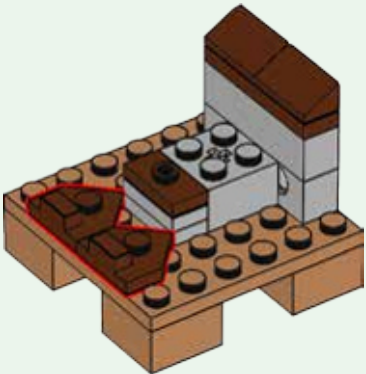

563

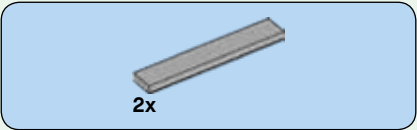
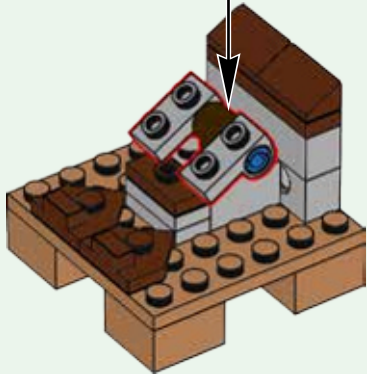
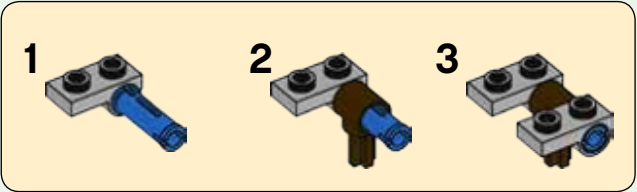

564

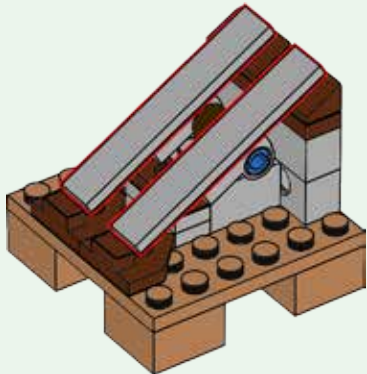

2x

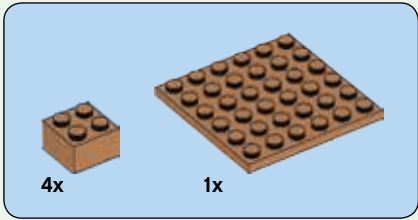

565

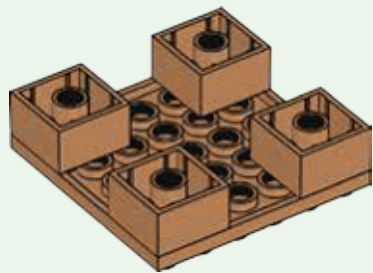

566

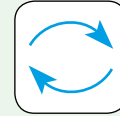

567

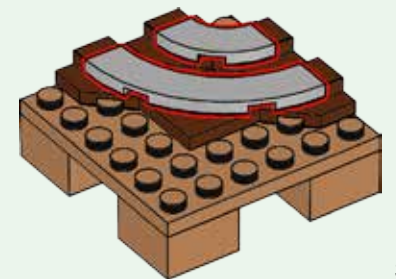

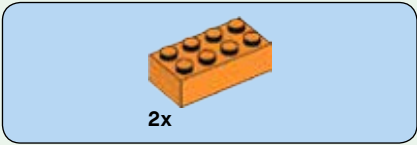
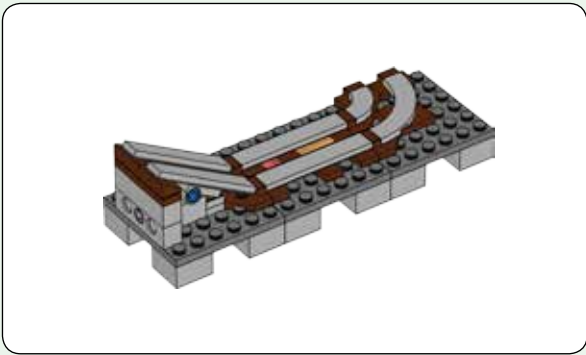

568

1

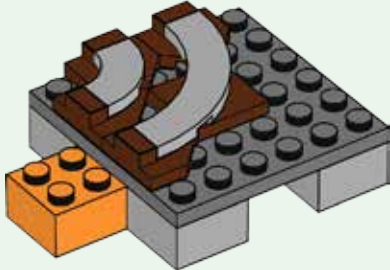

2

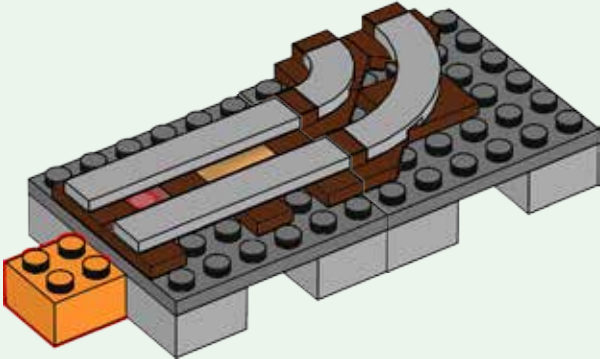

3

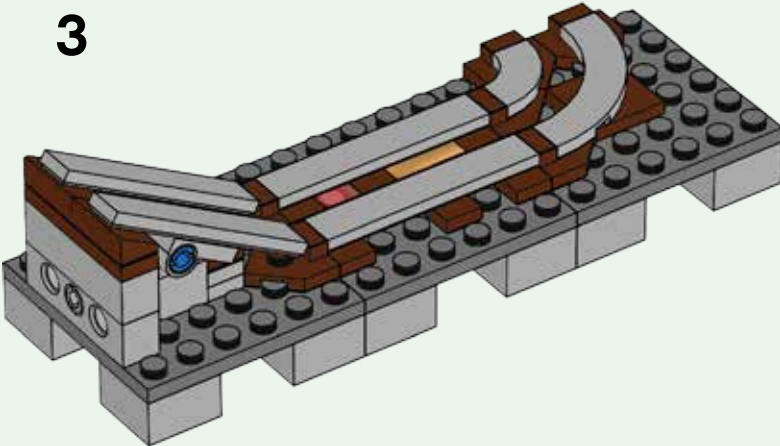

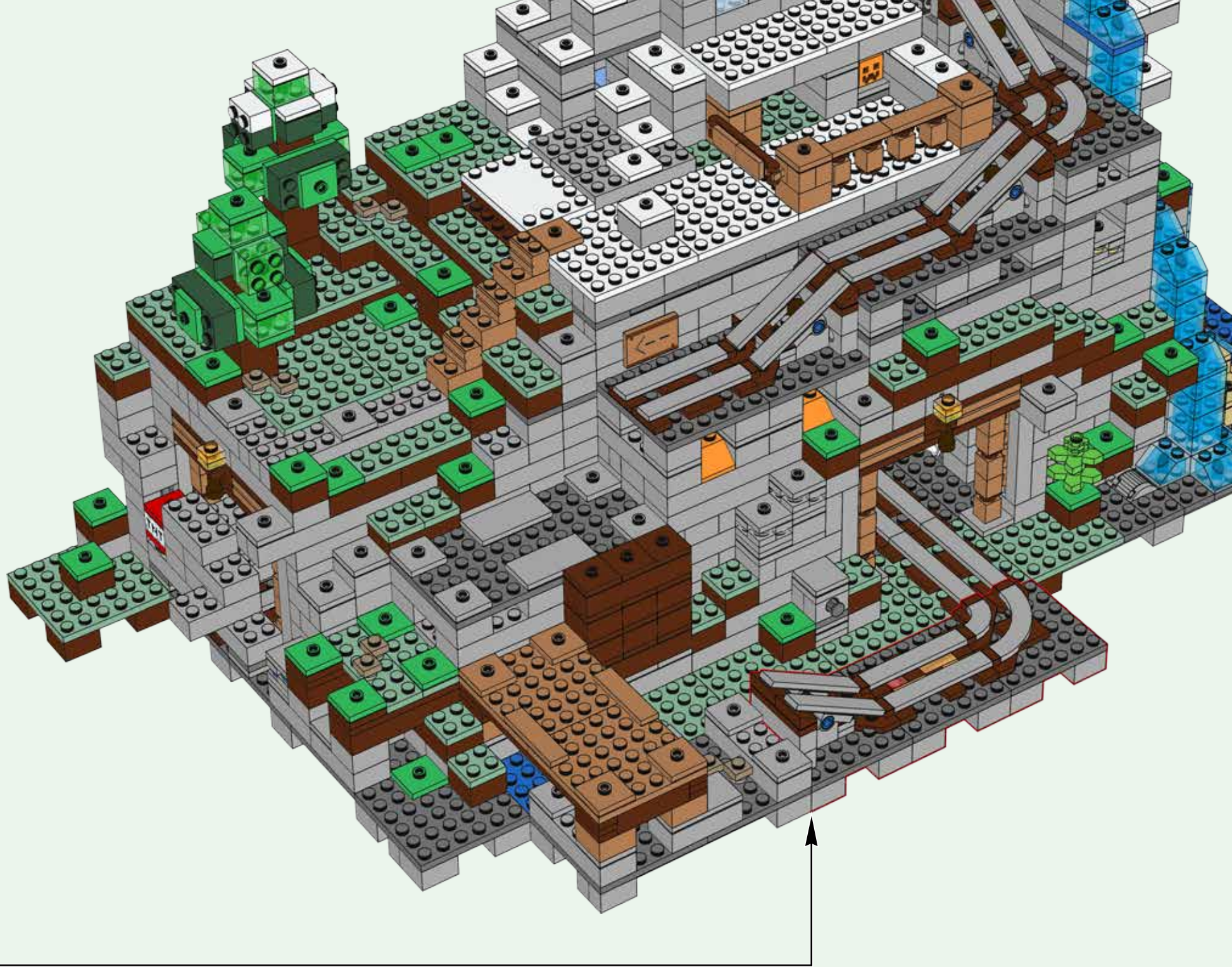

569





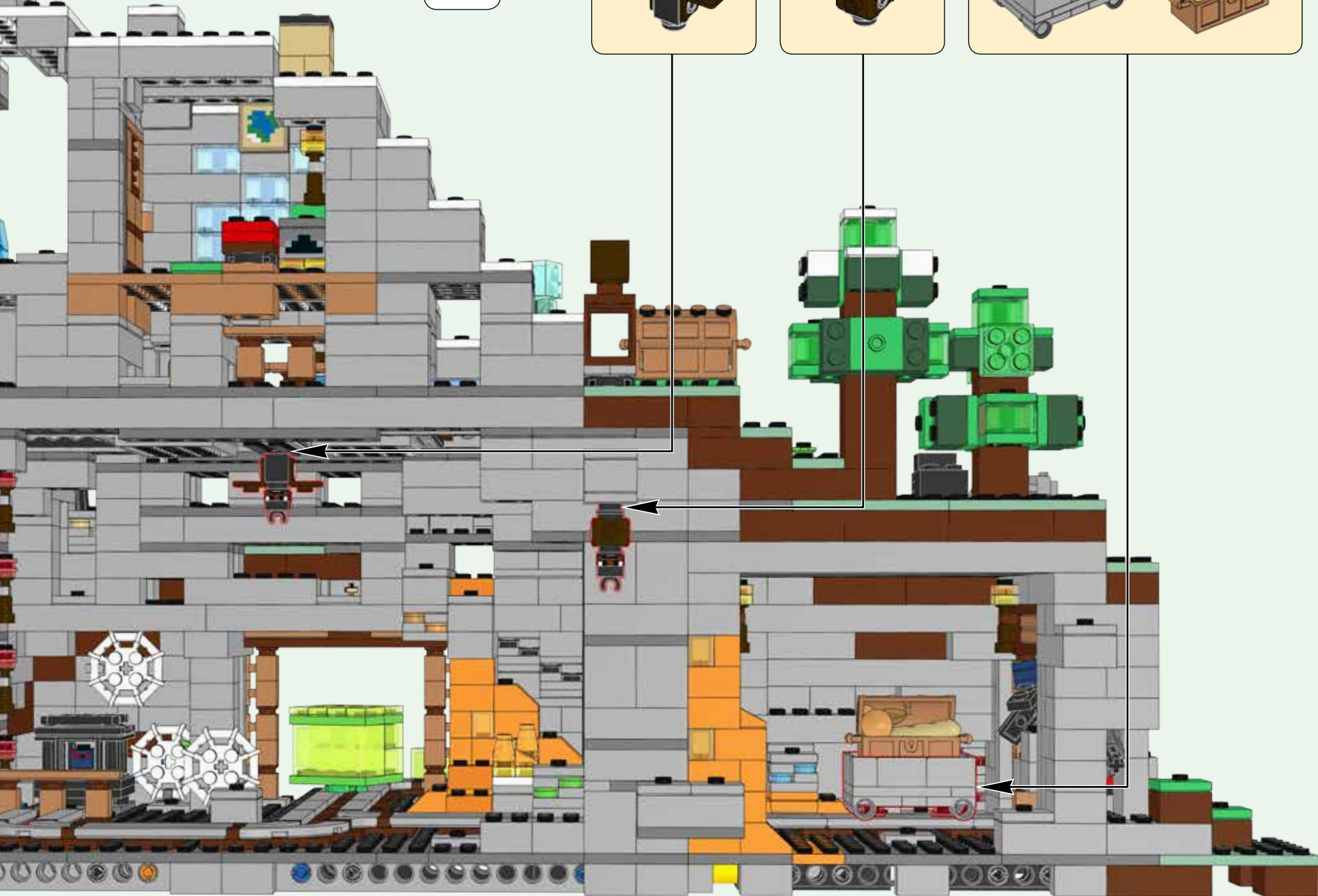
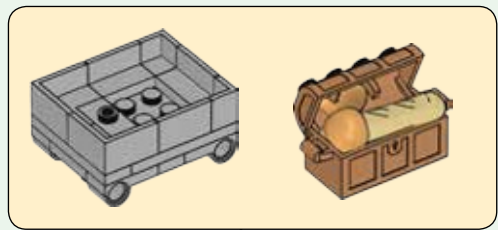
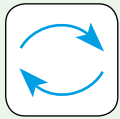

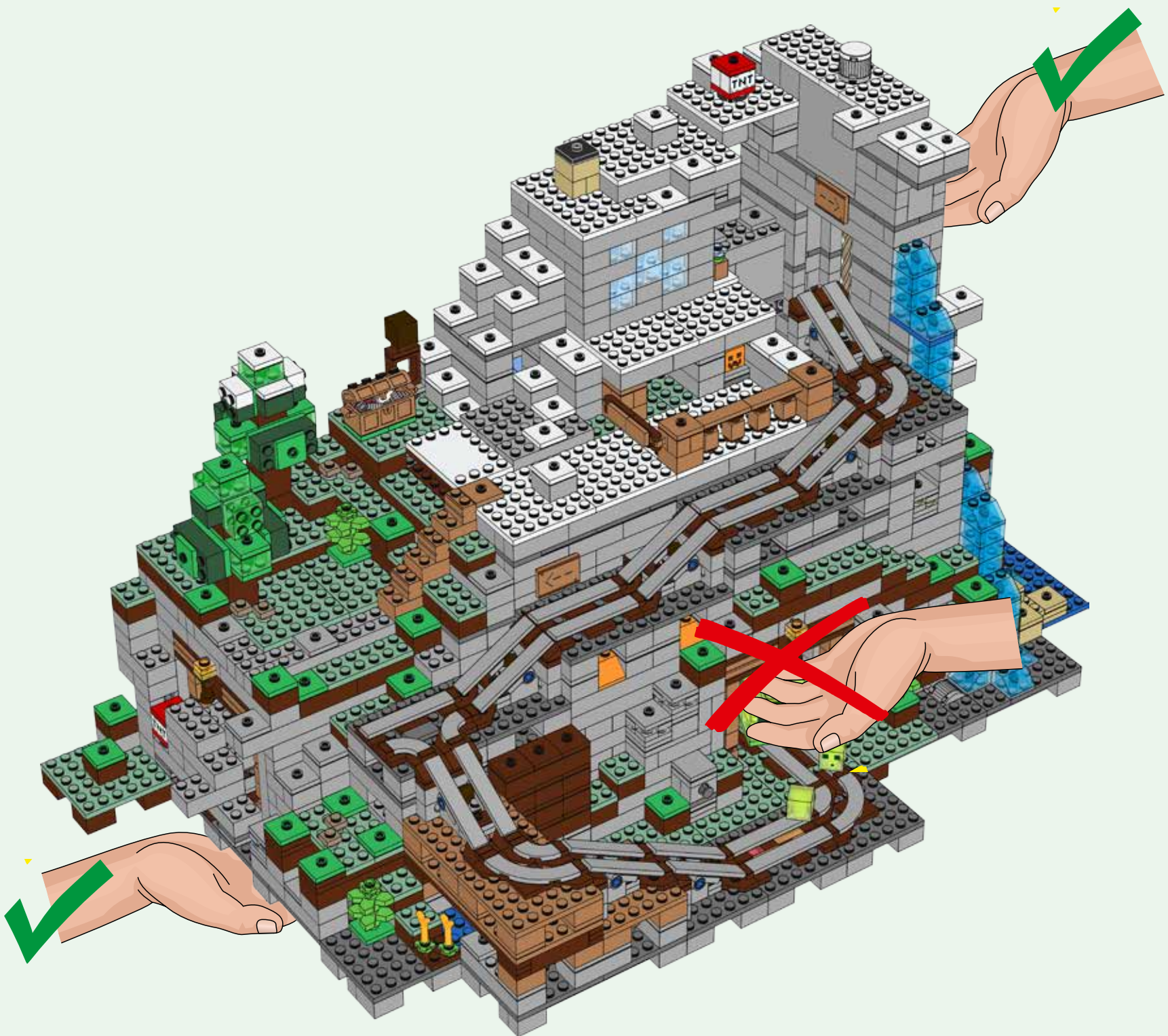

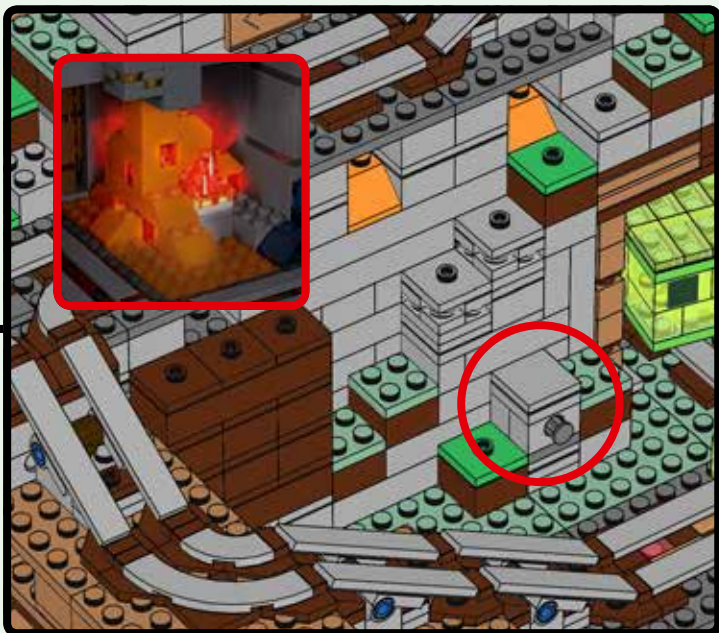
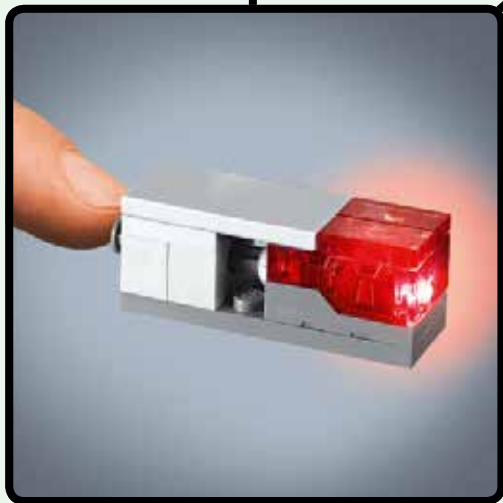
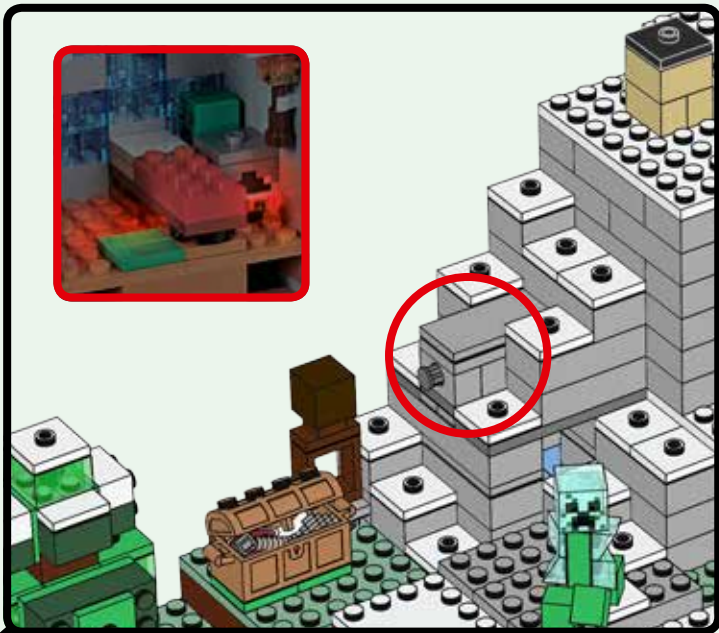
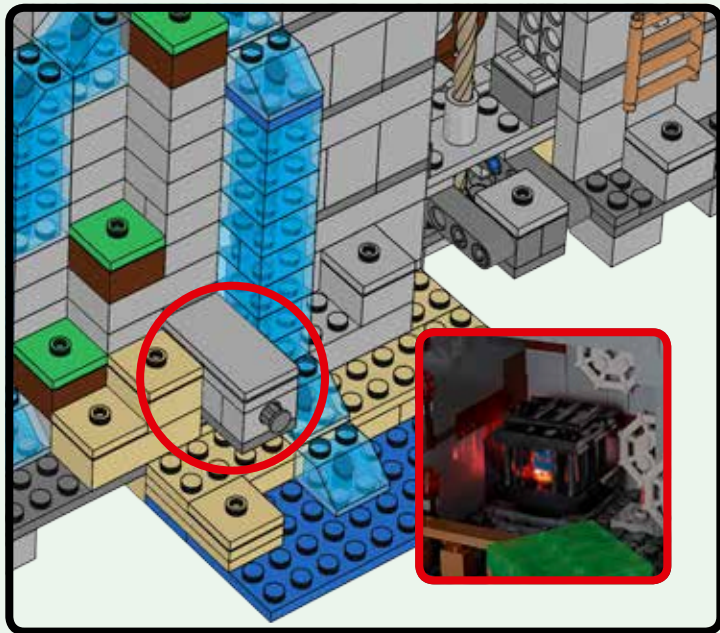

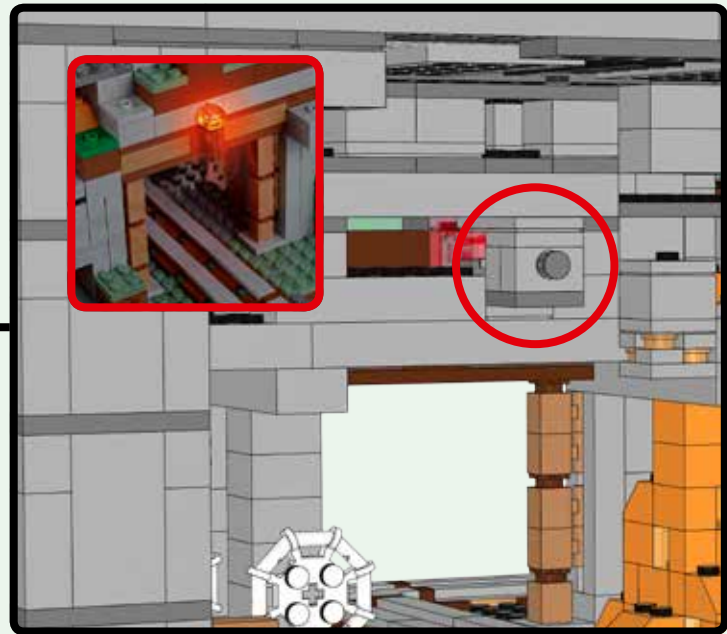
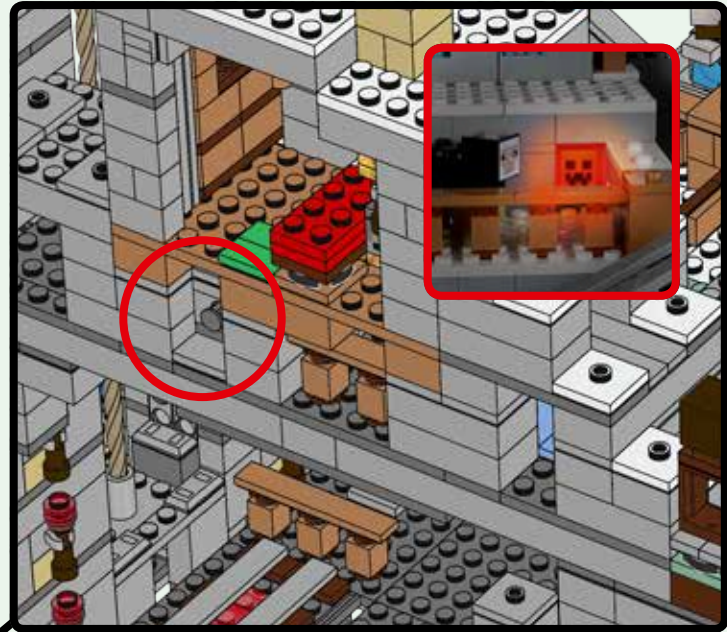
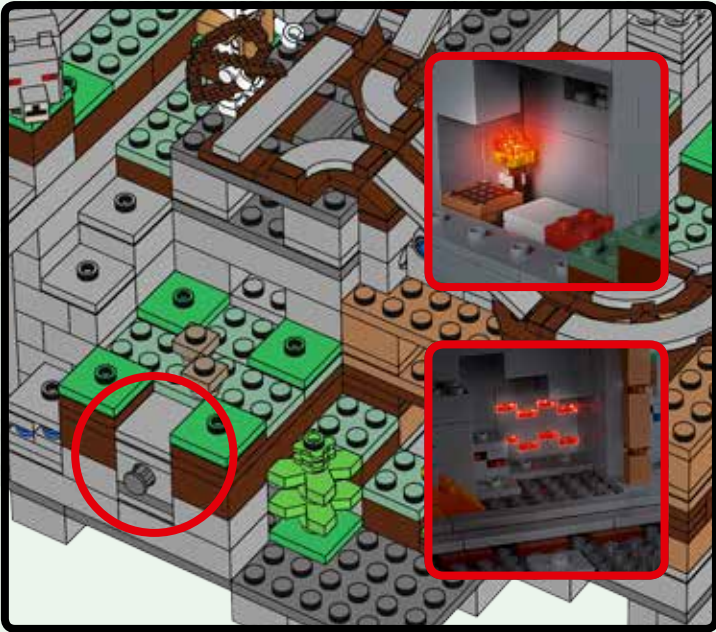

Change to New Models
Crée de nouveaux modèles
Inventa nuevos modelos

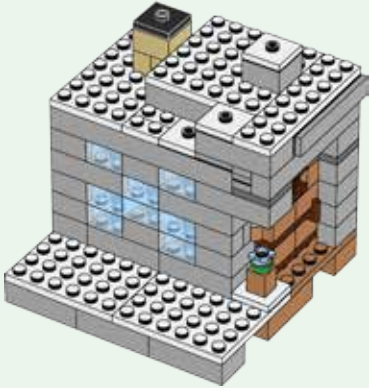
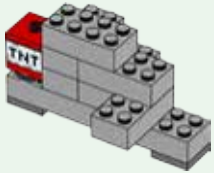
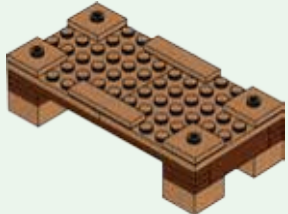
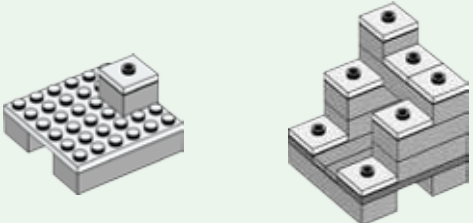
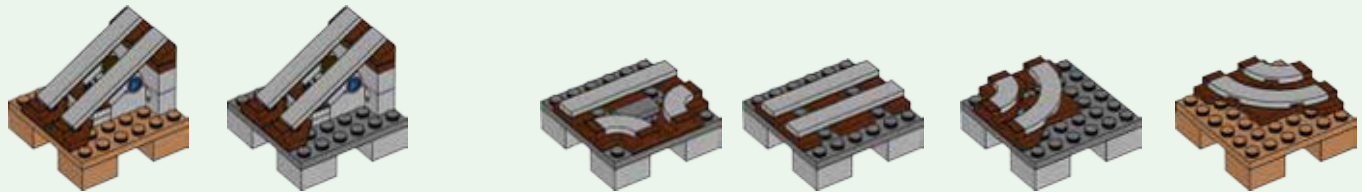

Inspiration
Idées
Ideas

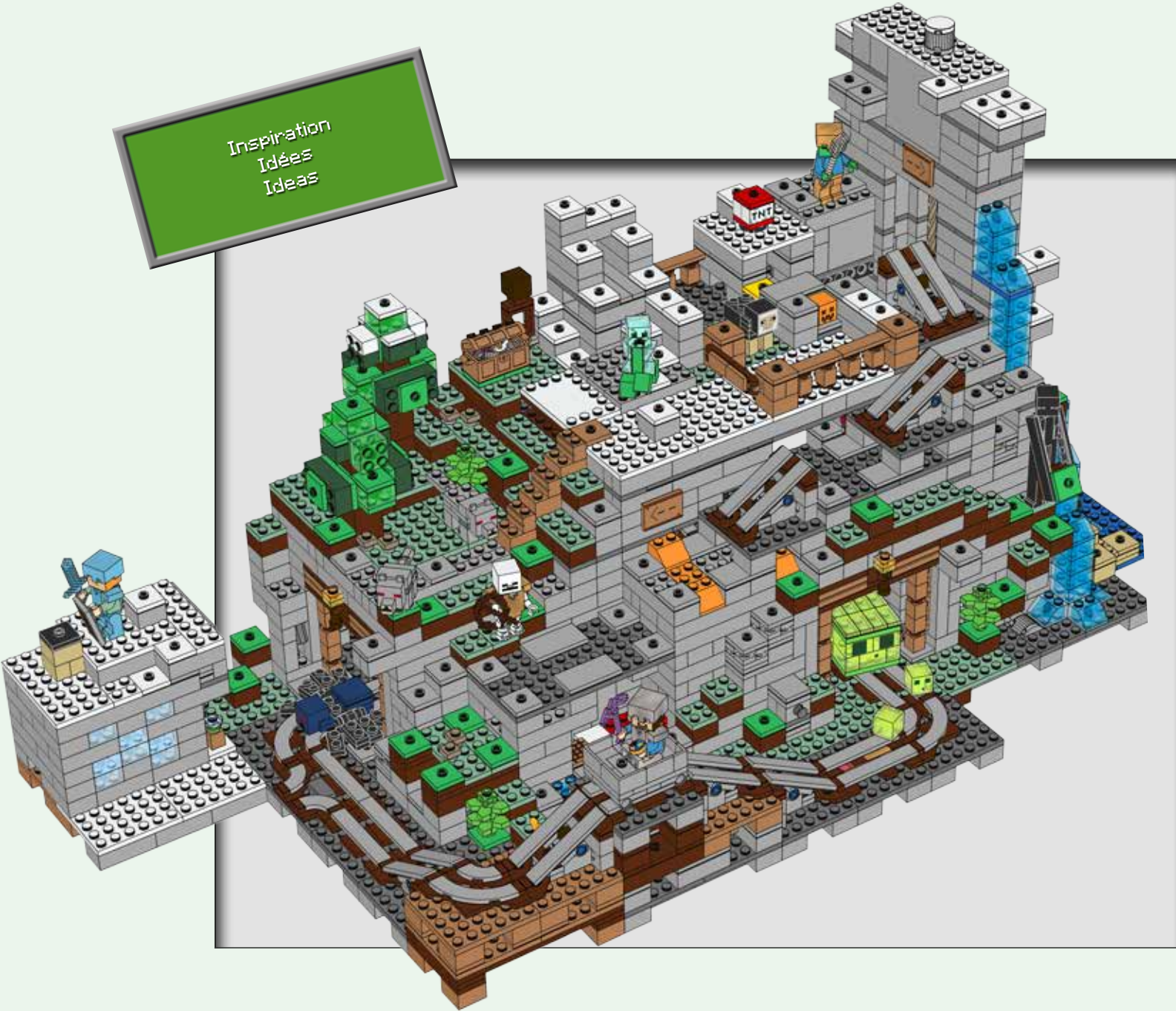

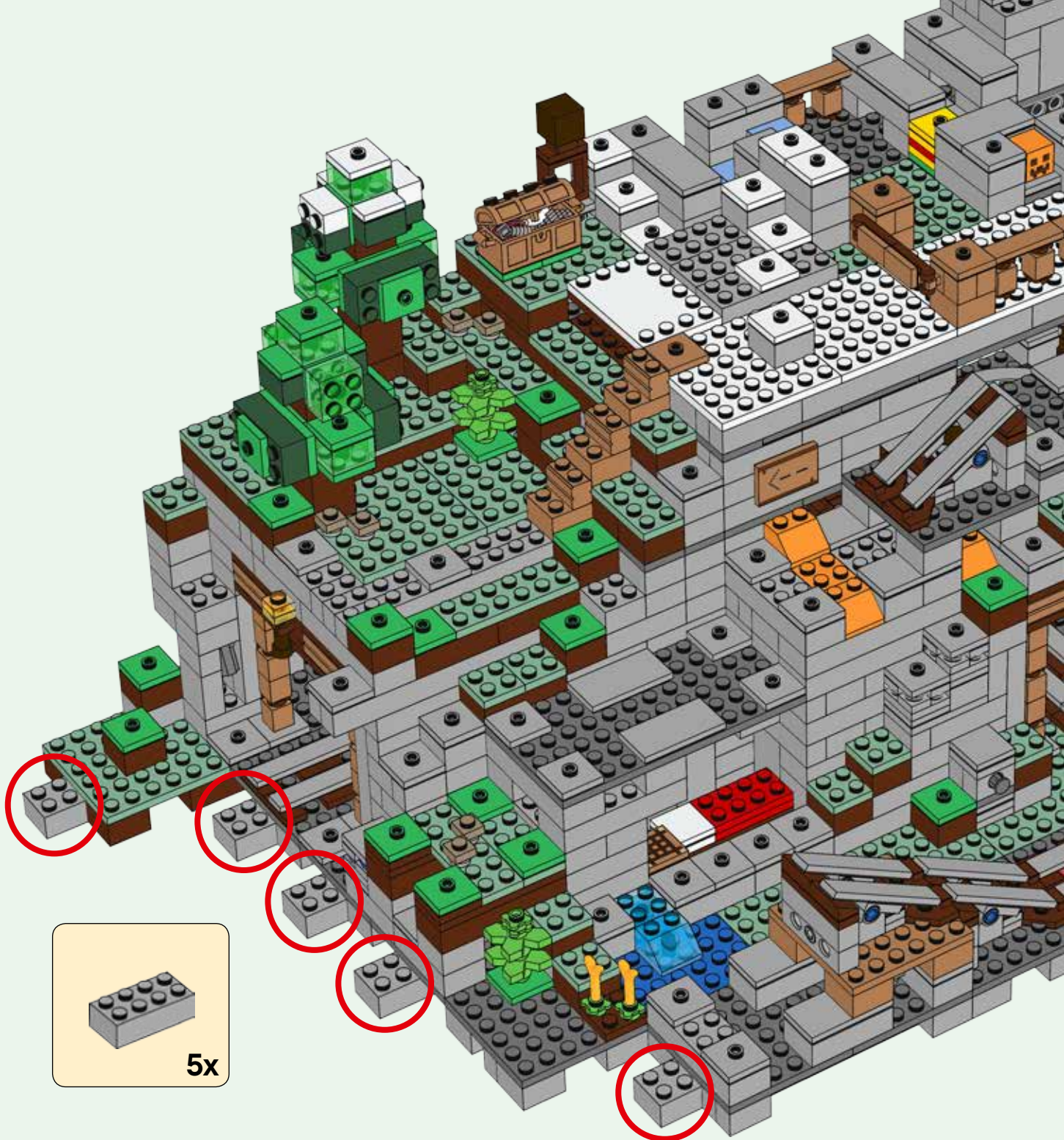
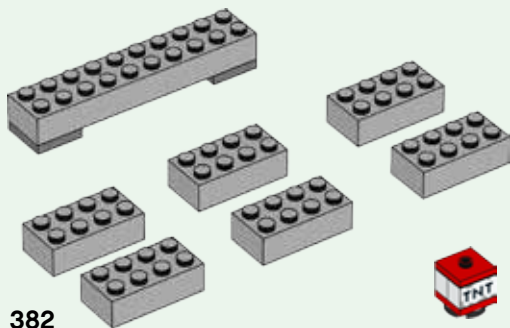
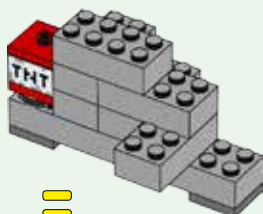

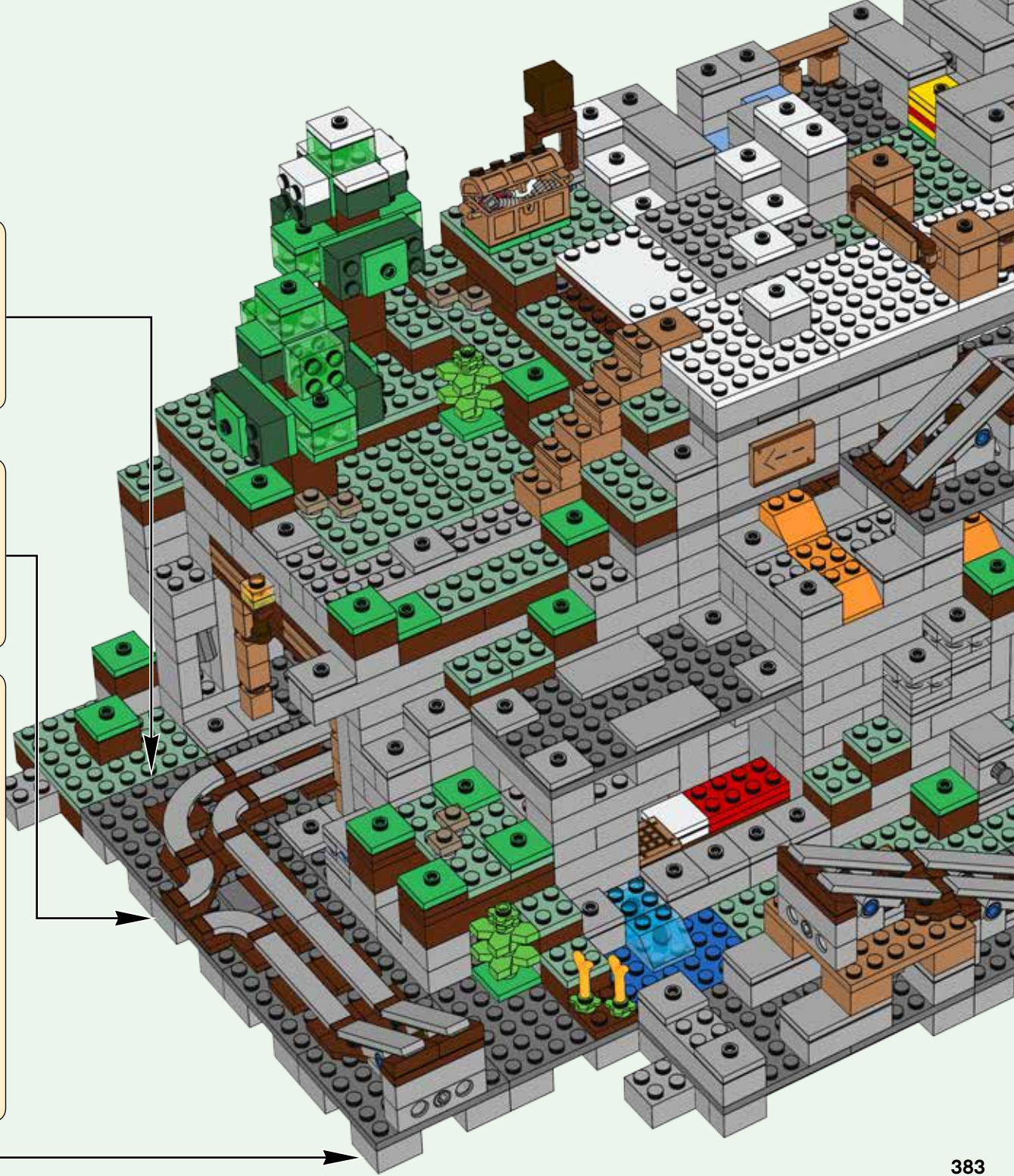
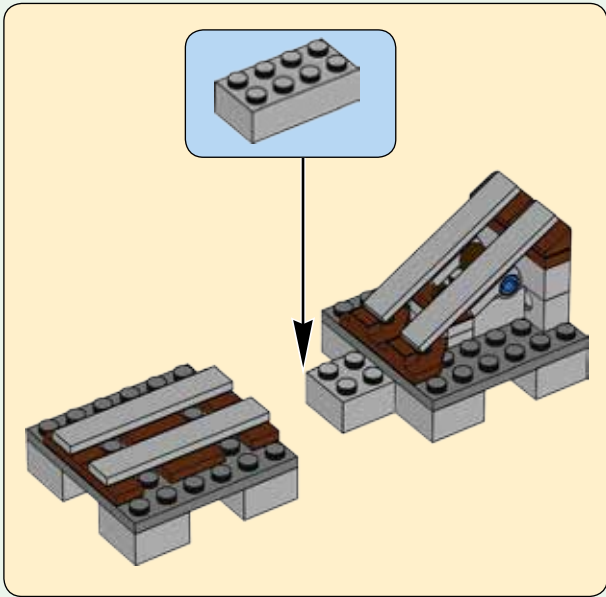
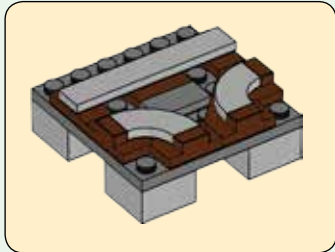
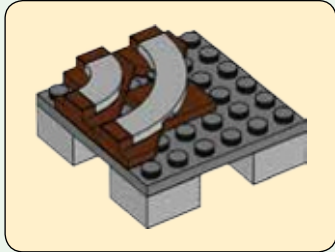

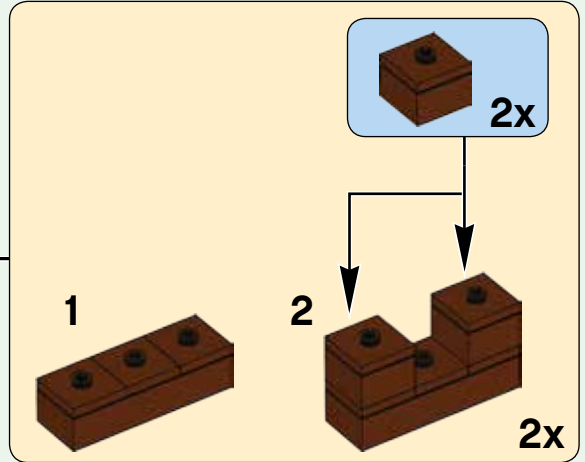
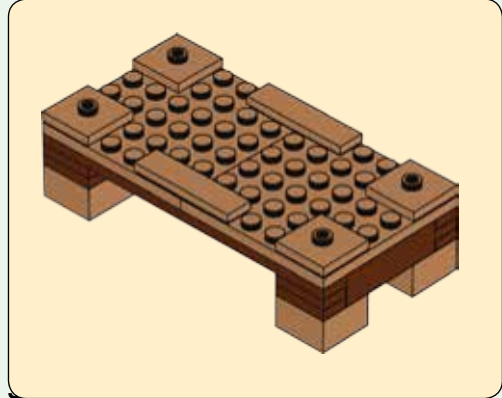

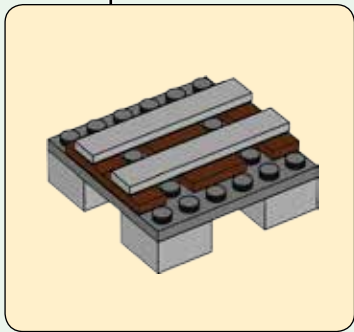
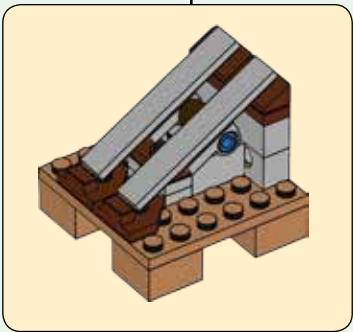

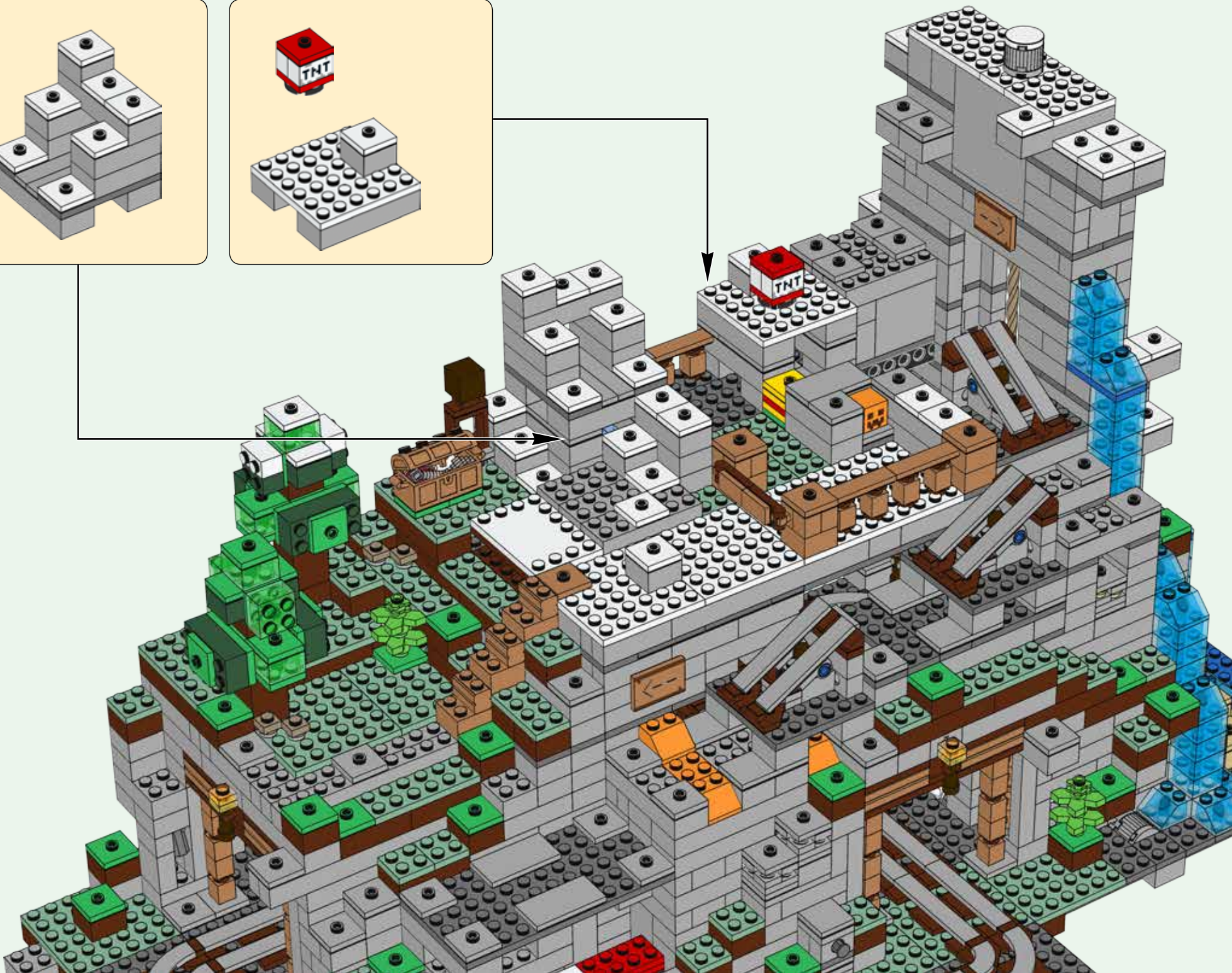
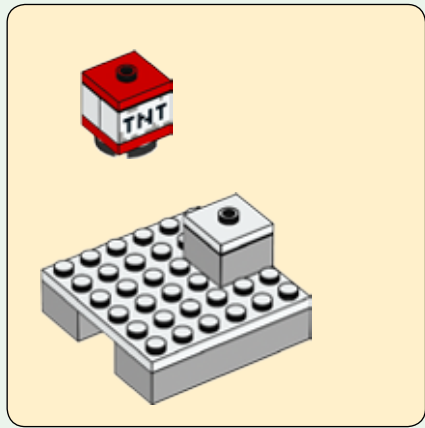
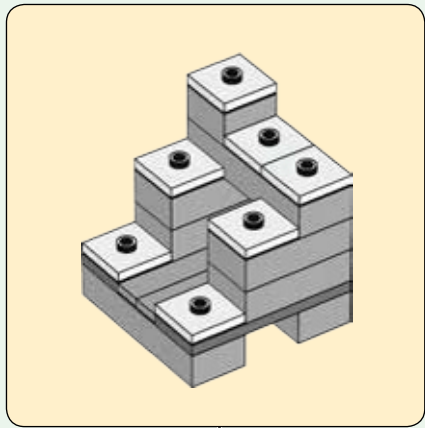

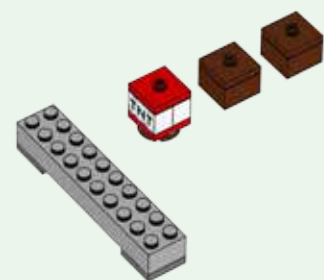
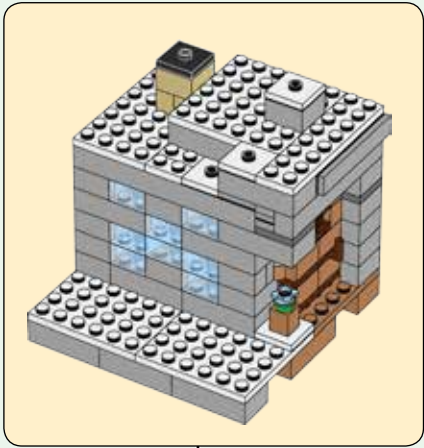

Change to New Models
Crée de nouveaux modèles
Inventa nuevos modelos

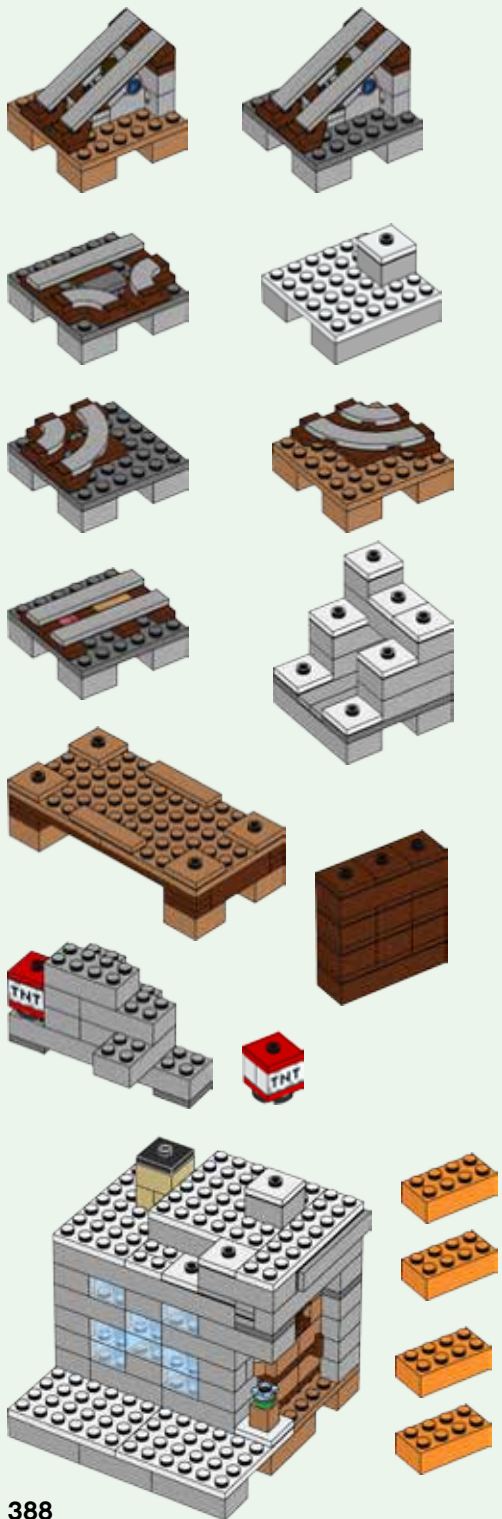

Inspiration
Idées
Ideas

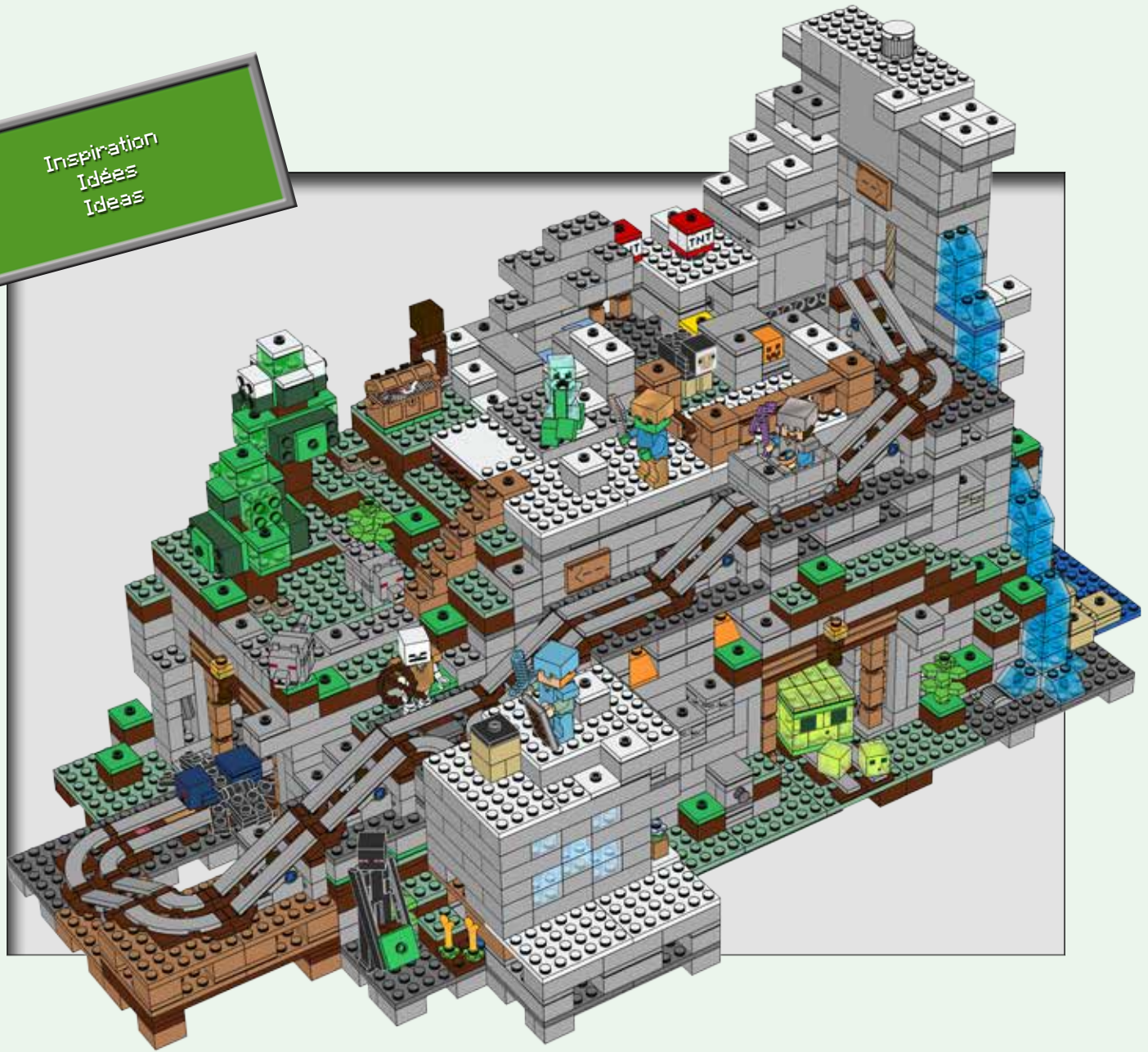

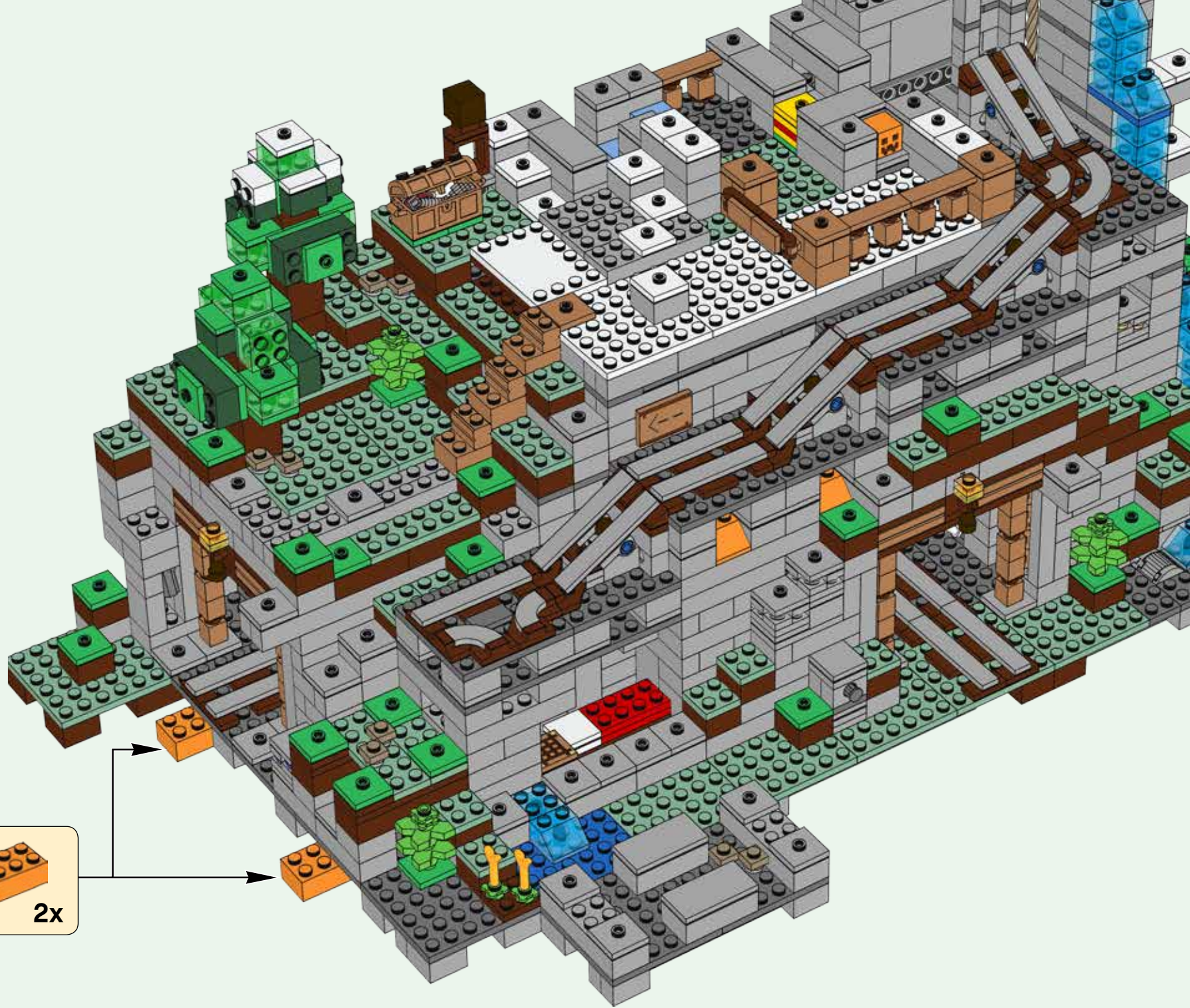

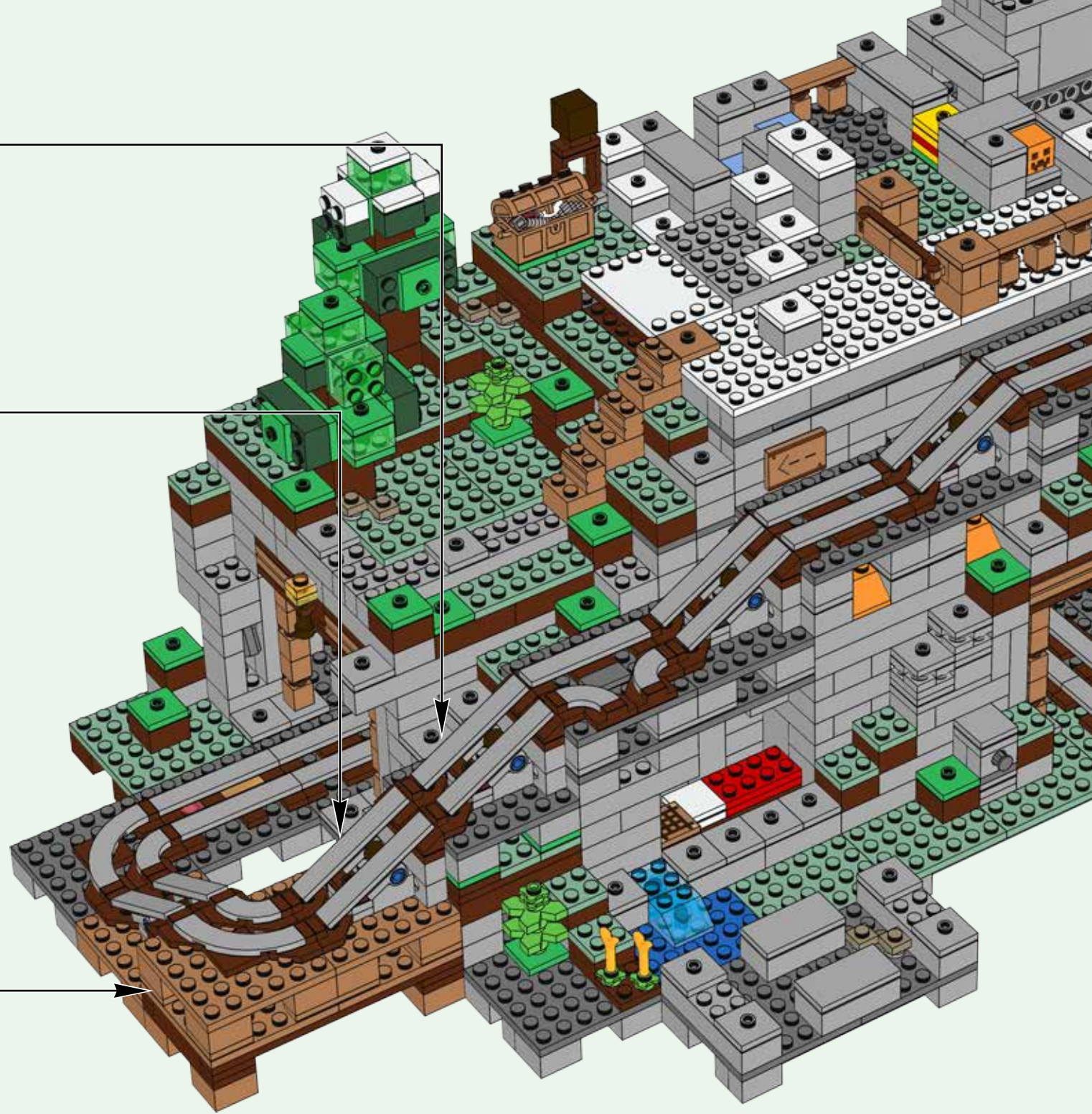
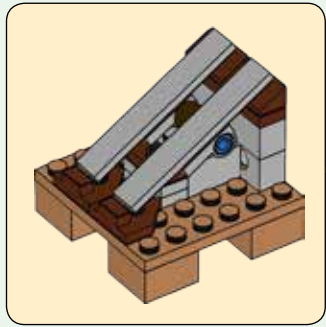
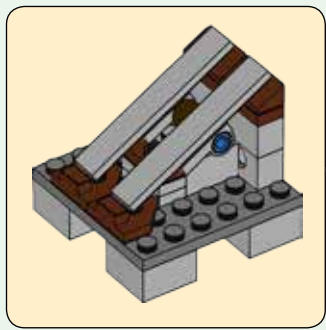

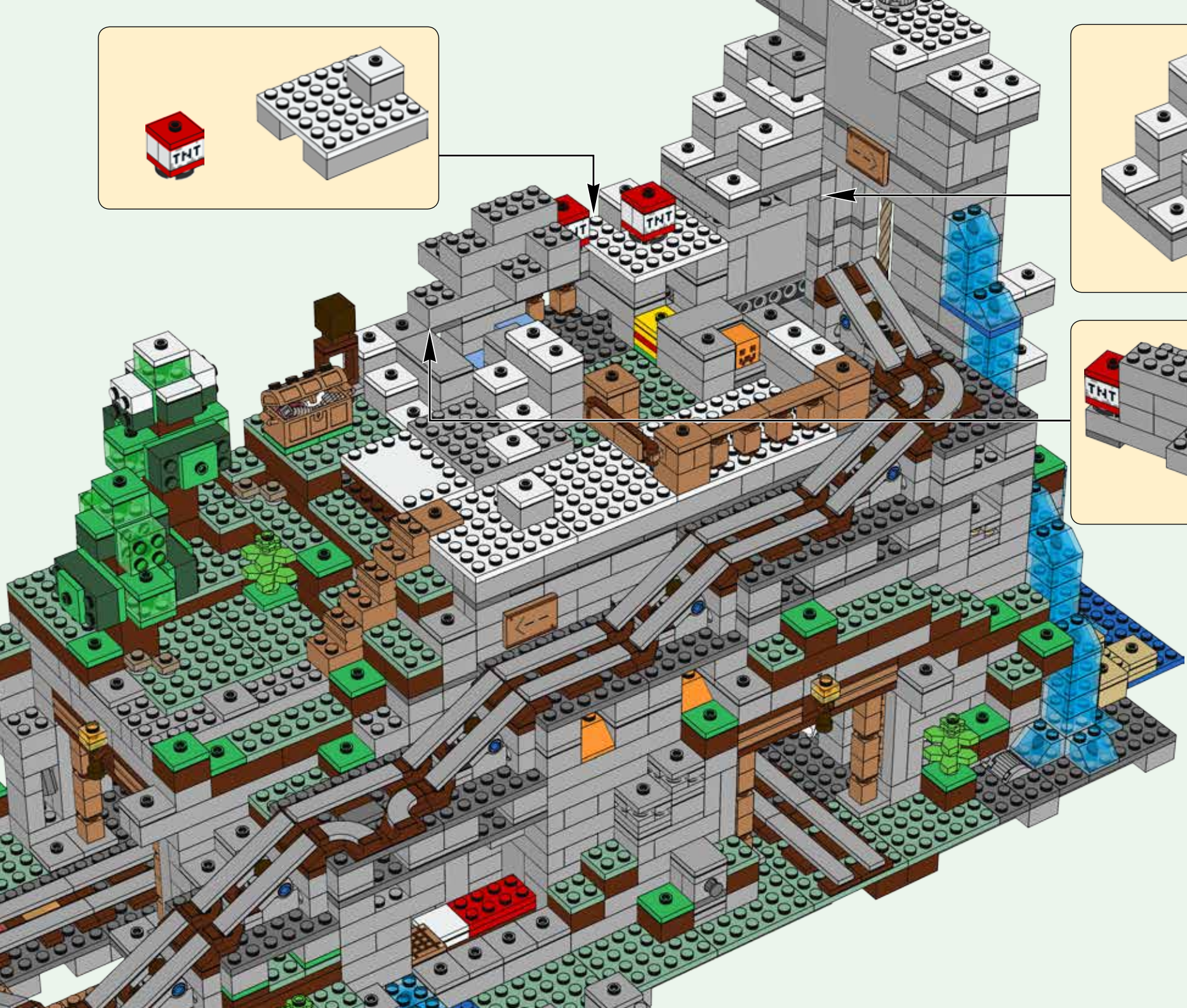
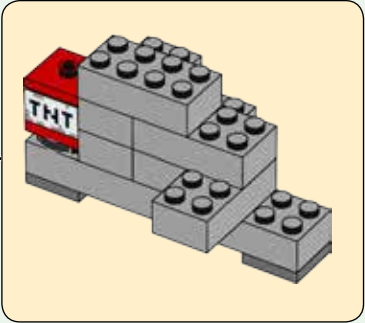
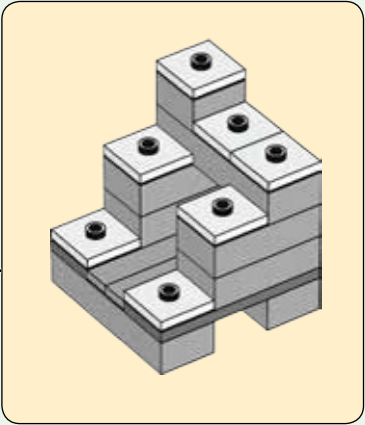
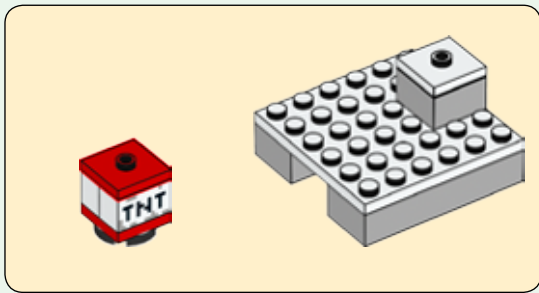

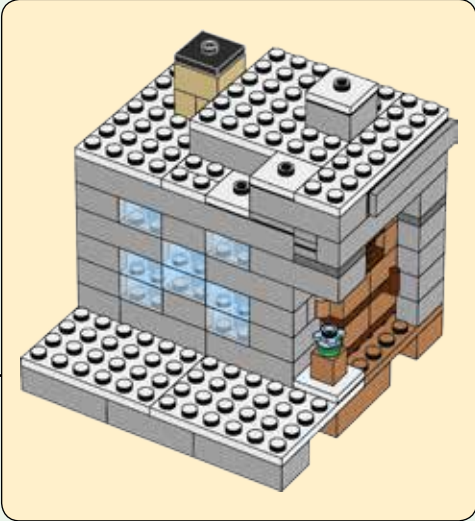

2x 6038450
 2x 6146060
 1x 6143319
 1x 4600294
 1x 302301
 2x 306901
 1x 6044691
 36x 6126046
 2x 306801
 3x 302201
 1x 6061024
 1x 6162386
 4x 6097028
 2x 300401
 3x 6178921
 1x 6117940
 1x 4508143

3x 6009016
 3x 370901
 1x 4243812
 1x 4163986
 1x 303201
 1x 303401
 5x 6001831
 6x 4144012
 1x 303501
 1x 383201
 1x 4503008
 18x 6186823
 8x 6194726
 12x 6186830

9

4x 6161734
 2x 4565452
 2x 6013938
 2x 6103001
 9x 4109995
 2x 4523145
 3x 6024495
 4x 4565387
 3x 4114306
 6x 4185273
 1x 4582437
 2x 4666999
 5x 4114309
 1x 6122047
 2x 4114319
 4x 4113993

2x 6148244
 2x 6179172
 1x 6192795
 9x 6139003
 3x 4642409
 2x 6198005
 1x 6186839
 8x 6092675
 1x 6186836

1x 6192729
 1x 4631385
 4x 4528981
 1x 6162266
 1x 4205004
 1x 4667595
 4x 4528357
 4x 6073445
 1x 6192810
 2x 4654432
 1x 6096993
 1x 6189212
 1x 6089099
 1x 6138047
 1x 6101871
 1x 6101856

1x 306543
 29x 4144387
 18x 622743
 1x 6192748
 1x 6186834
 1x 4512021
 2x 6107197
 1x 6141693
 1x 6141698
 4x 6194728
 7x 6134197
 1x 6162384
 1x 6138164
 15x 4538950
 36x 3005741
 2x 3003941
 4x 4189801

1x 6170307
 2x 4566522
 4x 4523159
 9x 3000844
 2x 4194746
 1x 6114400
 6x 6102986
 1x 6093623
 2x 4567338
 9x 4542673
 2x 4244369
 12x 4262655
 1x 4280341
 1x 4541710
 2x 6096682
 1x 6104570
 1x 6101987
 1x 6101979

8x 4549436
 1x 6192746
 1x 6031821
 1x 6121832
 1x 6104050
 9x 6109713
 1x 6121786
 2x 4245570
 6x 4260493
 7x 6173122
 3x 4233484
 1x 6126050
 2x 302224
 2x 4142133
 5x 4144022
 3x 4542579

3.2

5

12x 614126
 1x 6168646
 4x 6066102
 2x 307026
 2x 302426
 2x 4214559
 1x 4548180
 3x 4109810
 10x 403226
 121x 4121715
 1x 6162466
 2x 6006140
 7x 281726
 5x 6109808
 8x 6170300
 6x 4143562
 2x 6141590
 15x 4542579

15

- 2x 302326
- 3x 6055630
- 1x 6196991
- 4x 4535739
- 4x 6102782
- 1x 6101874
- 2x 4225201
- 2x 4521439
- 1x 302226
- 3x 4565323
- 1x 300326
- 2x 242026
- 3x 370026
- 1x 302126
- 396**
- 1x 4521681
- 4x 370526
- 2x 4120017
- 2x 6066113
- 2x 243126
- 1x 4515350
- 3x 370626
- 4x 6058118
- 4x 663626
- 1x 273026
- 17x 4188143
- 3x 4522933
- 5x 4107558
- 6x 614123
- 2x 4143005
- 14x 4206482
- 1x 6132158
- 2x 302223
- 40x 4514553
- 2x 4509376
- 2x 302023
- 3x 4158923
- 1x 4199519
- 1x 4528850
- 2x 6057799
- 1x 4495933
- 2x 4542575
- 3x 302221
- 1x 6014616
- 3x 6196217
- 2x 6126048
- 2x 6102138
- 1x 6100930
- 4x 302021
- 1x 6153264
- 4x 306540
- 1x 6010737
- 2x 6021997
- 1x 6097003
- 11x 6102994
- 22x 6057986
- 24x 6170572
- 2x 4569385
- 3x 4656783
- 2x 6097024
- 5x 4569382
- 1x 6102967
- 26x 6058085
- 8x 6167599
- 2x 6192782
- 12x 6055309
- 6x 6102998
- 3x 6135191
- 1x 6102995
- 2x 6167286
- 2x 6102984
- 7x 6162899
- 1x 4211200
- 27x 4211210
- 2x 6173948
- 2x 6102975
- 2x 6195084
- 8x 4211225
- 8x 4211190
- 6x 4211186
- 23x 4211201
- 2x 4211204
- 1x 4221590
- 7x 4211247
- 10x 4216615
- 1x 4263776
- 3x 4211214
- 2x 6055145
- 40x 6170302
- 2x 6195336
- 4x 4225469
- 1x 4221744
- 14x 6035291
- 6x 6127734
- 42x 6163991
- 68x 6092590
- 9x 4211150
- 2x 4211151
- 1x 4595814
- 1x 6173941
- 1x 6089103
- 41x 4565394
- 7x 4216695
- 6x 4173805
- 4x 6068996
- 1x 6162469
- 1x 6162510
- 14x 4121739
- 1x 6013635
- 4x 4159007
- 4x 4153825
- 2x 4153826
- 16x 4118828
- 1x 4118827
- 2x 4158355
- 6x 4153827
- 3x 4121741
- 1x 4654448
- 2x 6052391
- 3x 4177932
- 2x 4188771
- 15x 6143033
- 1x 6030521
- 1x 403228
- 1x 6162485
- 1x 6162390
- 4x 306928
- 8x 6117971
- 37x 4565321
- 1x 6104065
- 1x 6101877
- 1x 4617799
- 4x 302028
- 2x 379528

4

6

15

13

7

15

2x
4211807

1x
4640536

11x
4641682

2x
6028812

6x
6146223

22x
6089147

62x
4211388

4x
6066097

1x
6011459

6x
4211414

1x
4211475

4x
6179186

14x
4211398

1x
4515369

2x
4650645

1x
6152107

8x
4211525

1x
4211483

2x
4558953

1x
6061702

6x
6134378

4x
4211389

40x
4211399

4x
4215513

16x
4535764

1x
4642934

6x
4233493

1x
4211541

2x
4211440

2x
4654582

24x
4211364

94x
6126082

3x
6132886

16x
4211397

28x
4211349

9x
6163990

4x
4617170

4x
6181755

83x
4211564

6x
4582153

28x
4585429

1x
6014615

1x
6198008

127x
4211387

27x
4211529

5x
4211386

3x
6093054

2x
6192716

2x
6176242

7x
4211441

61x
4211394

21x
4211445

114x
4211385

2x
4211444

5x
6163989

18x
4560183

46x
4211549

1x
6194727

4x
6059033

2x
4243797

3x
4211395

2x
6012653

2x
4211466

1x
4211716

7x
4211438

2x
4527174

56x
4211795

35x
4211393

1x
4211392

1x
4211406

2x
4211407

4x
6102449

1x
4211521

11x
4617862

7x
4211522

18x
4211443

10x
4211366

2x
6071226

2x
4210671

2x
4211052

15x
4211063

3x
4543086

5x
4210697

1x
6137325

1x
6126083

22x
4211094

4x
4211055

49x
4210635

1x
6097032

3x
4211000

1x
4547958

5x
4560184

18x
4211065

2x
4210686

1x
4508553

3x
4211056

21x
6186825

5x
6083620

2x
4211053

1x
4210725

17x
4211002

2x
4210998

2x
4211115

2x
4260707

41x
4211134

3x
4210678

6x
4603472

1x
4211122

1x
4256149

5

5.5

9

11

4

Customer Service

Kundenservice

Service Consommateurs

Servicio Al Consumidor

LEGO.com/service or dial



: 00800 5346 5555

: 1-800-422-5346

Get more Building Inspiration on
LEGO.com/minecraft
Découvrez d'autres idées de
constructions sur LEGO.fr/minecraft
Más ideas de construcción en
LEGO.com/minecraft

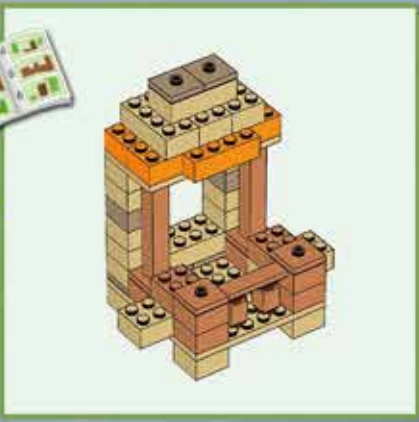
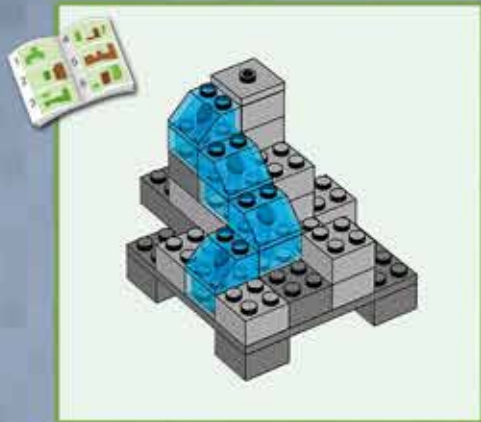

Expand Your LEGO® Minecraft™ World
Agrandis ton monde LEGO® Minecraft™
Amplía tu mundo LEGO® Minecraft™



21129



21130



21131



21132



21133

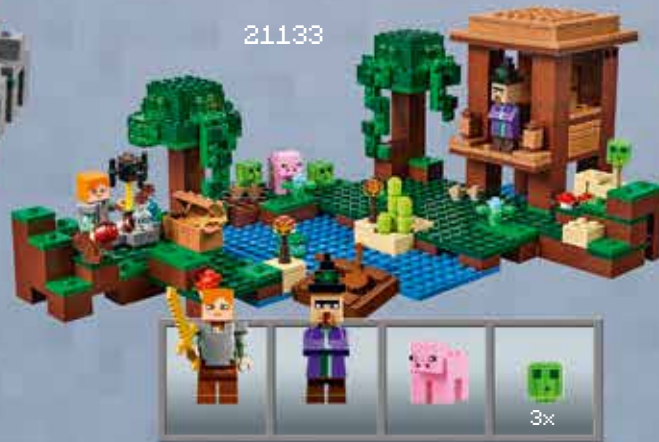

21134



21136



21137







All your LEGO® fun in one app
 Tout l'amusement LEGO® dans une appli
 Toda la diversión LEGO® en una app

Minifigure yourself
 Transforme-toi en figurine
 Conviértete en una minifigura

Share
 Partage
 Comparte



Create
 Crée
 Crea



Check availability of LEGO LIFE in your country now on LEGO.com/life
 Vérifie la disponibilité de LEGO LIFE dans ton pays sur LEGO.com/life
 Consulta si LEGO LIFE está disponible en tu país en LEGO.com/life



Ask parents' permission first.
 Demande d'abord l'autorisation d'un parent.
 Pide antes permiso a tus padres.

Apple and the Apple logo are trademarks of Apple Inc., registered in the U.S. and other countries. App Store is a service mark of Apple Inc. Google Play is a trademark of Google Inc.

For ages 5-9
 Âges : 5-9
 Para edades 5-9

LEGO, the LEGO logo, the Minifigure, the Brick and Knob configurations and the LIFE logo are trademarks and/or copyrights of the/son des marques de commerce et/ou copyrights du/son marcas registradas, algunas de ellas protegidas por derechos de autor, de LEGO Group. ©2017 The LEGO Group. All rights reserved/Tous droits réservés/Todos los derechos reservados.

WIN

GO TO WWW.LEGO.COM/PRODUCTFEEDBACK AND
GIVE US YOUR SHORT **FEEDBACK** ABOUT THIS
LEGO® SET FOR A CHANCE TO WIN
A COOL LEGO PRIZE.

Terms & Conditions apply



LEGO.com/productfeedback

GEWINNE

Erzähle uns auf
www.LEGO.com/productfeedback

etwas über die Erfahrungen, die
du mit diesem LEGO® Set gemacht
hast, und sichere dir die Chance
auf einen coolen LEGO Preis!

Es gelten die
Teilnahmebedingungen

GAGNE

Rends-toi sur
www.LEGO.com/productfeedback

et donne-nous quelques com-
mentaires sur ce produit LEGO®
pour avoir une chance de gagner
un prix LEGO !

Voir Conditions Générales

GANAN

Visita
www.LEGO.com/productfeedback

y envíanos tu opinión acerca de
este set LEGO®, ¡Participarás en el
sorteo de un premio LEGO!

Términos y Condiciones aplicables

获取奖品

登录
www.LEGO.com/productfeedback

给出关于此乐高®套装的简短反馈，
就有机会获得炫酷乐高奖品

《条款及条件》适用

경품 당첨 기회

www.LEGO.com/productfeedback

페이지로 이동하여 이 레고® 세트에
대한 간략한 피드백을 보내 주시고
멋진 레고 경품을 탈 수 있는 기회도
잡으십시오

약관 적용

ЗАПОЛНИ АНКЕТУ И ПОЛУЧИ ПРИЗ

Перейди по ссылке
www.LEGO.com/productfeedback

ответь всего на несколько во-
просов об этом наборе LEGO®,
и у тебя появится шанс выиграть
замечательный приз от компании
LEGO.

Применяются Условия и правила
участия