

1x

2

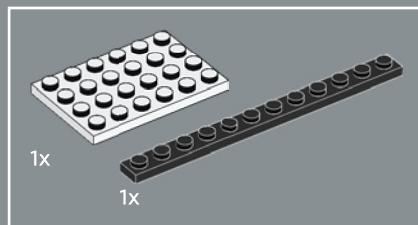
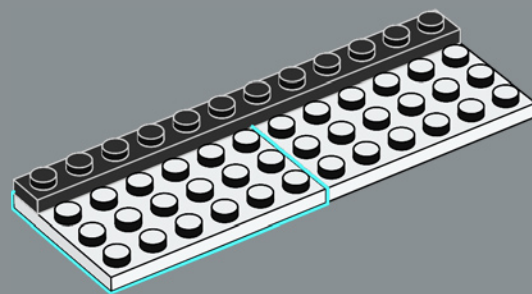

1x

1x

1

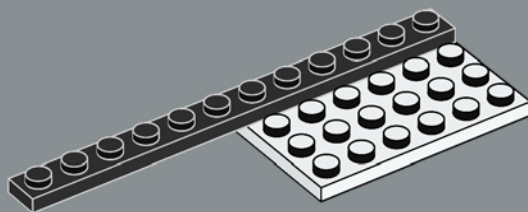

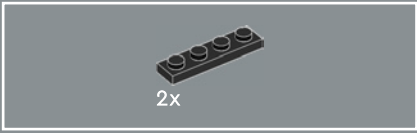

3

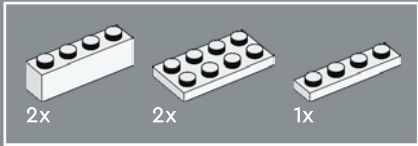
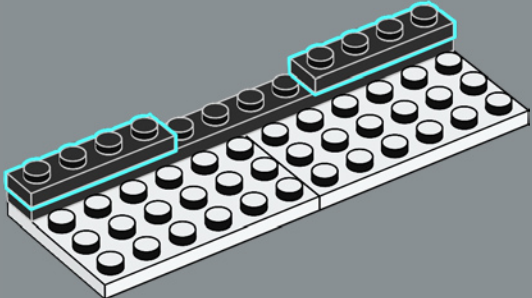

4

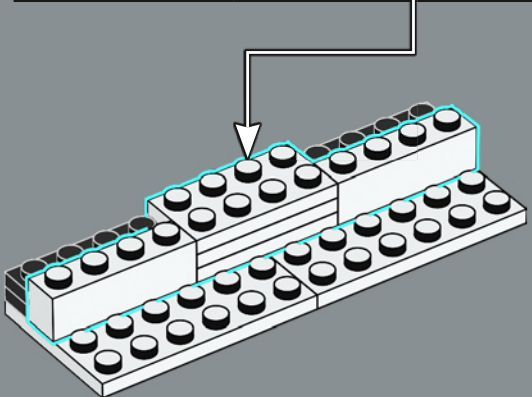
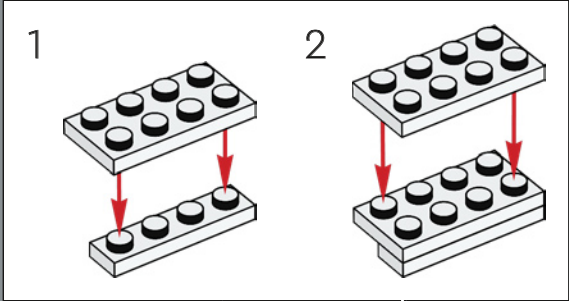

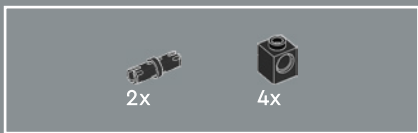

5

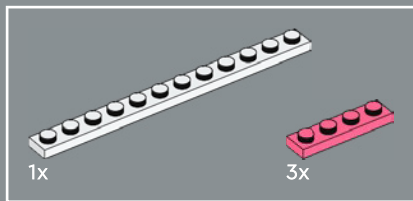
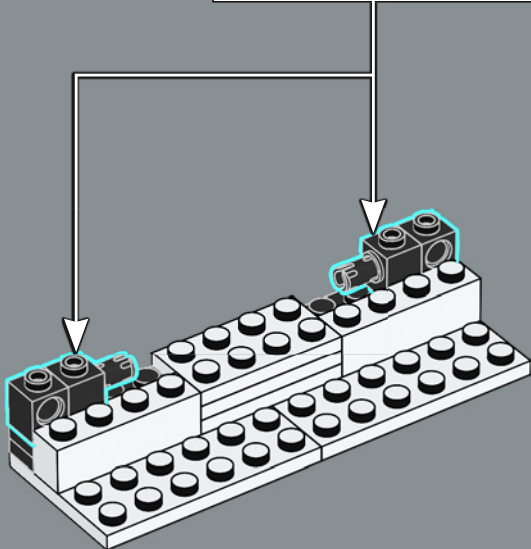
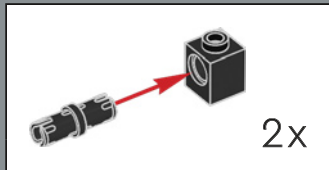

6

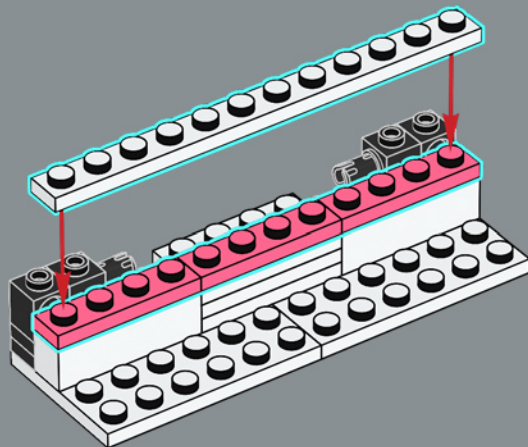

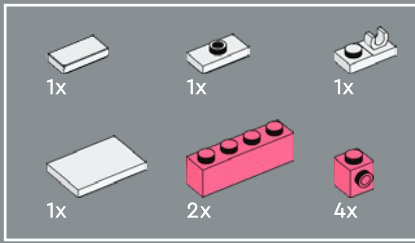

7

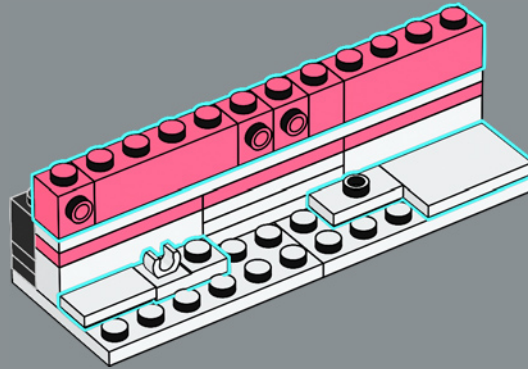
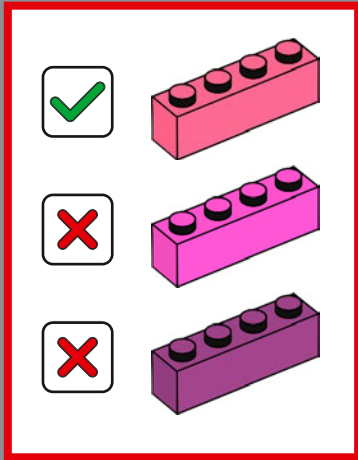



8

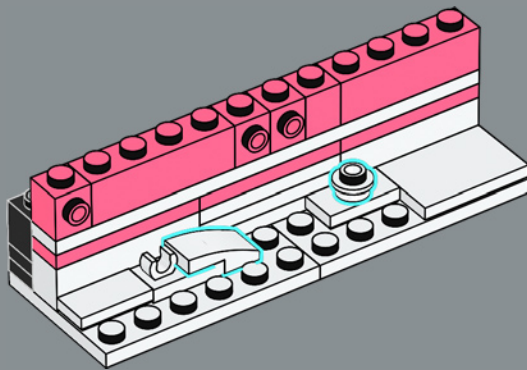

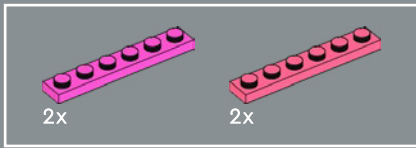

9

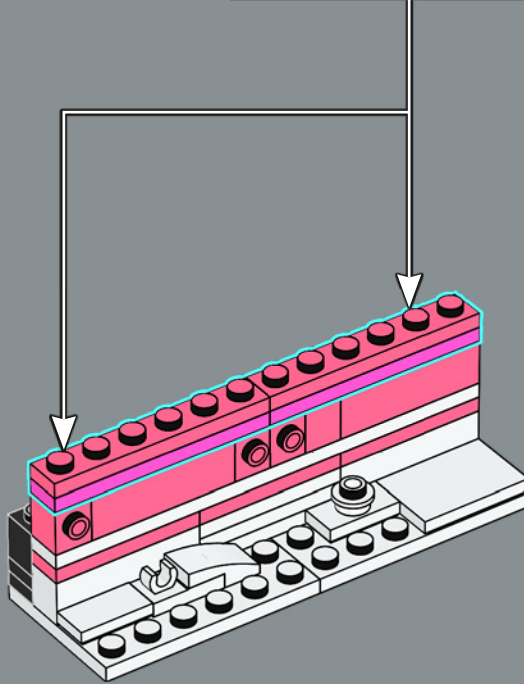
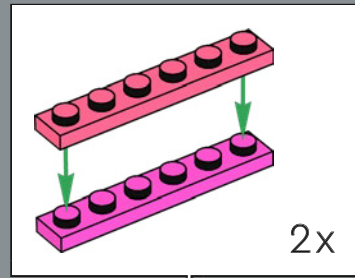
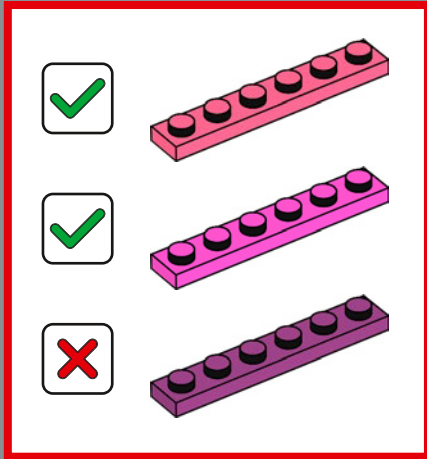



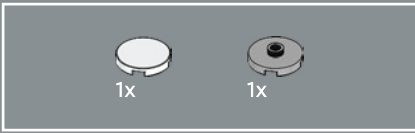

10

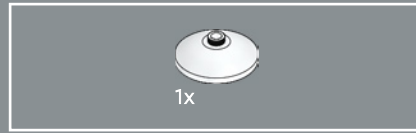
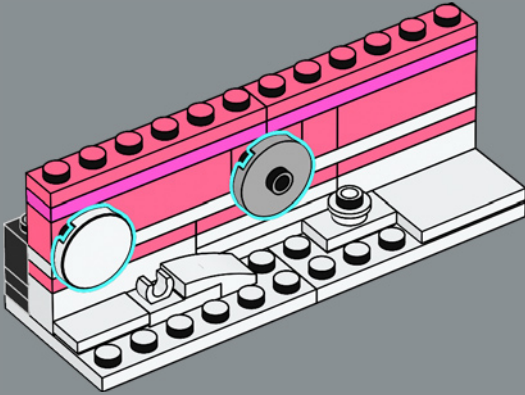

11

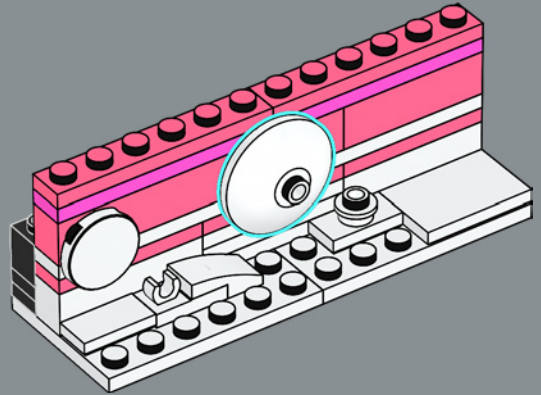

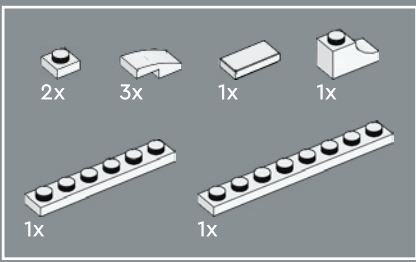

12

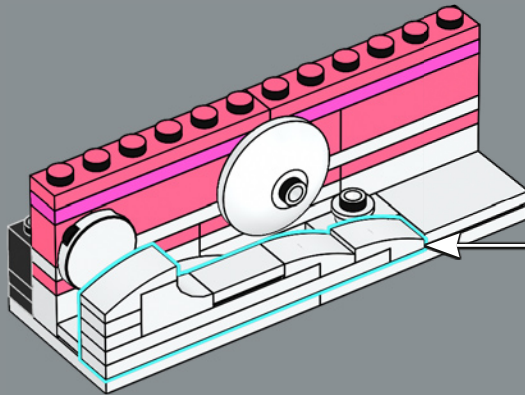
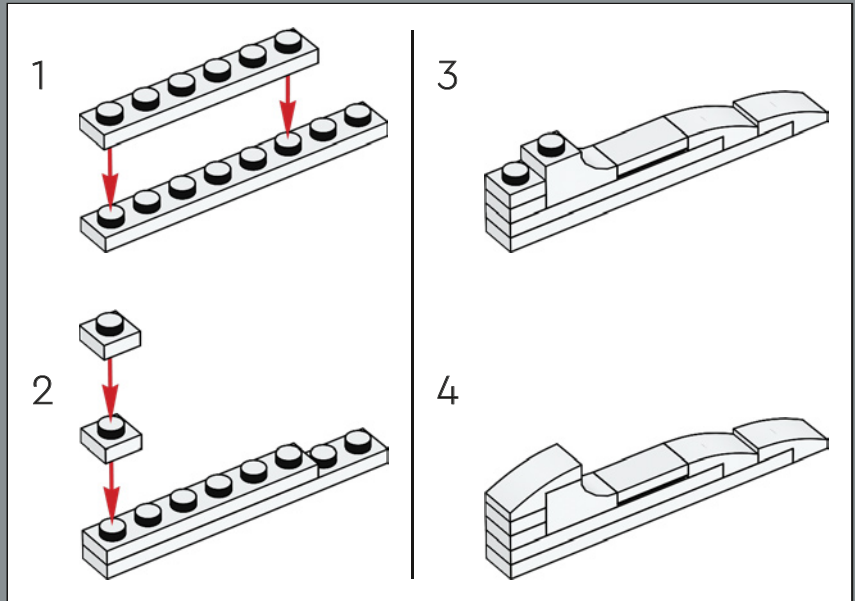

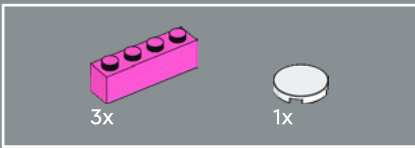

13

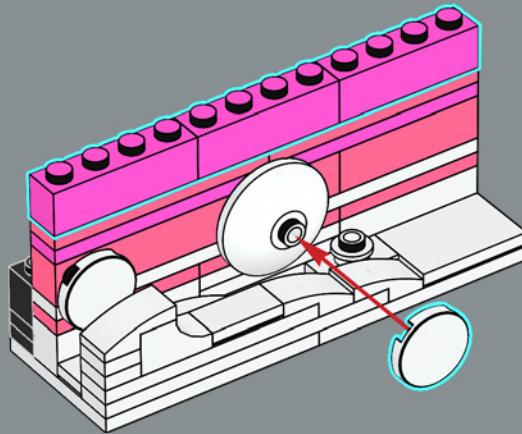
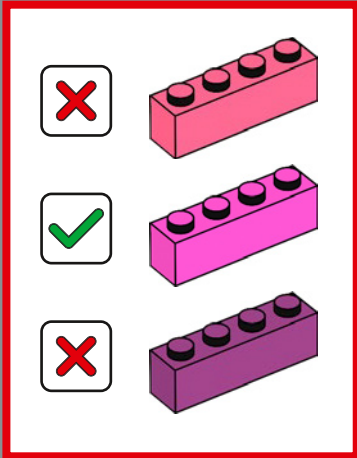

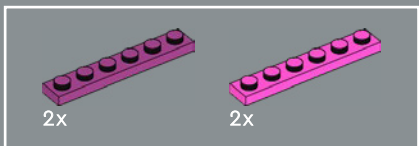

14

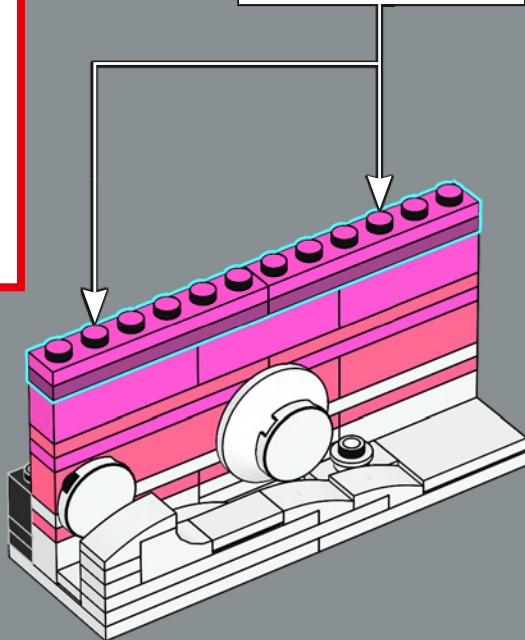
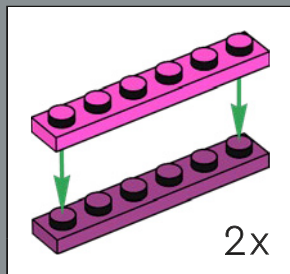
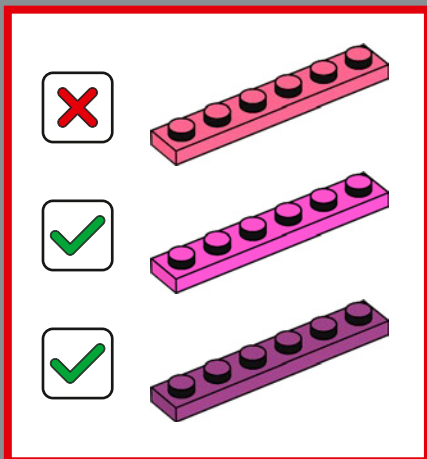

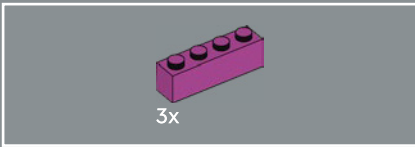

15

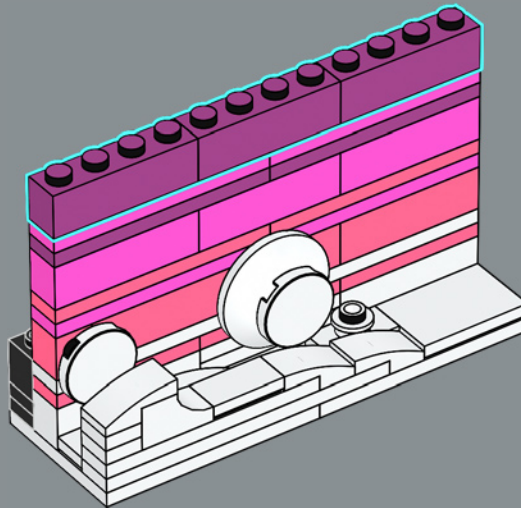
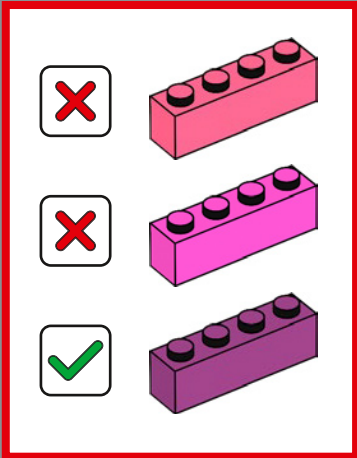

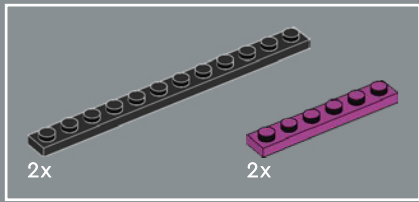

16

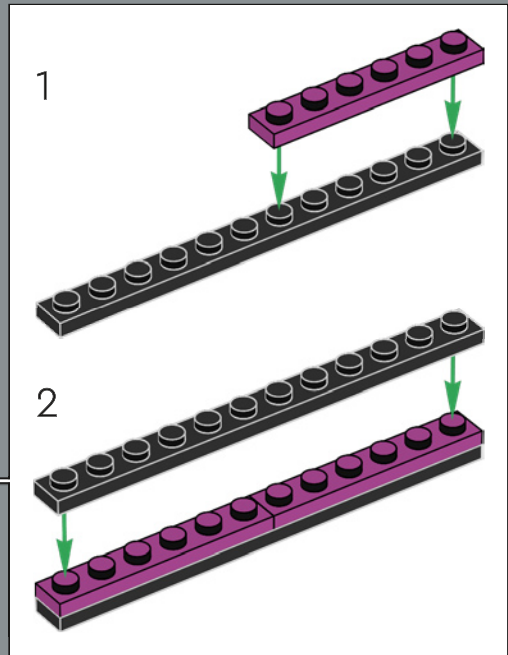
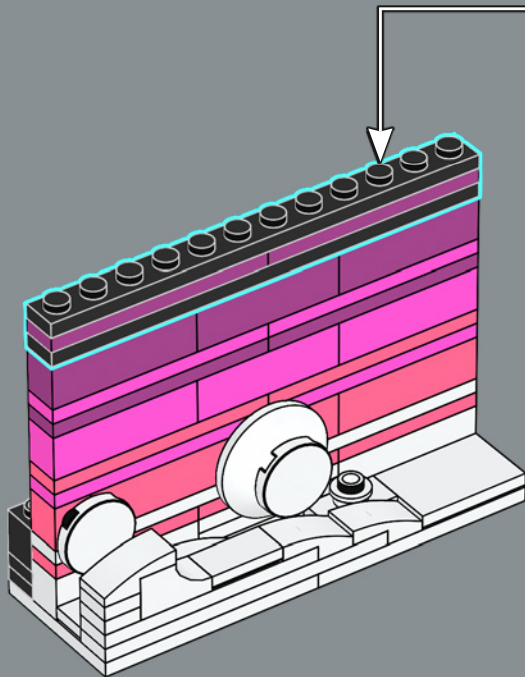

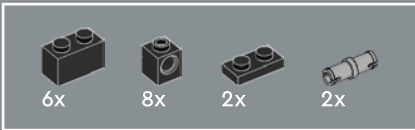

17

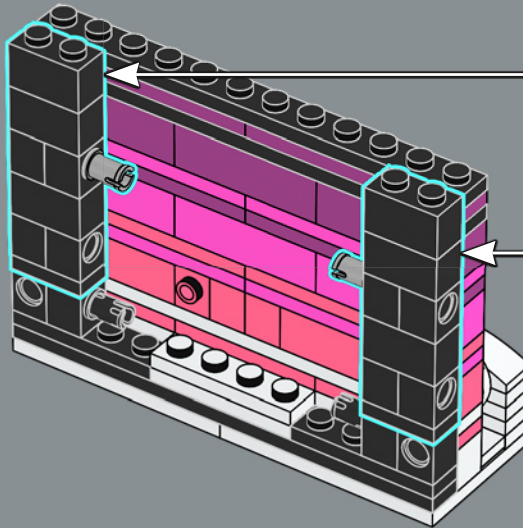
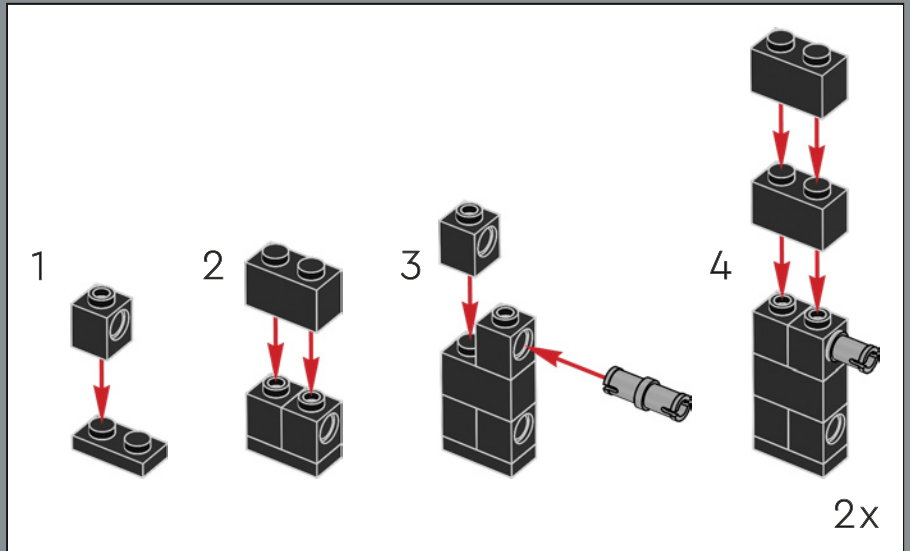

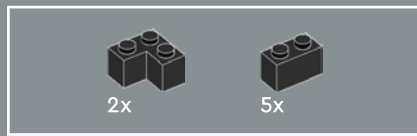

18

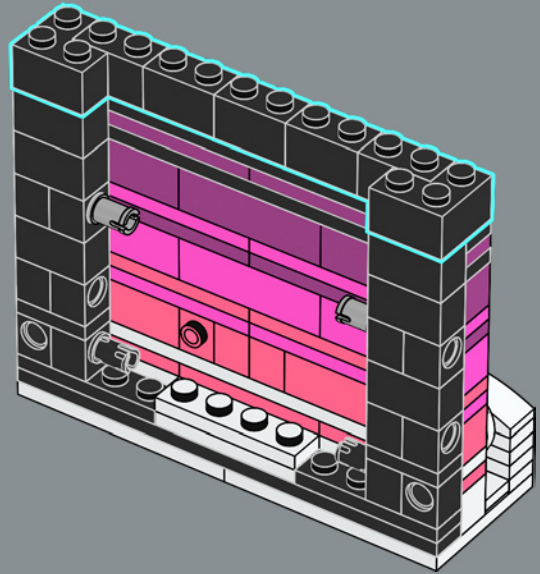



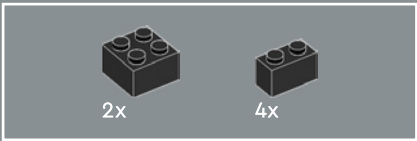

19

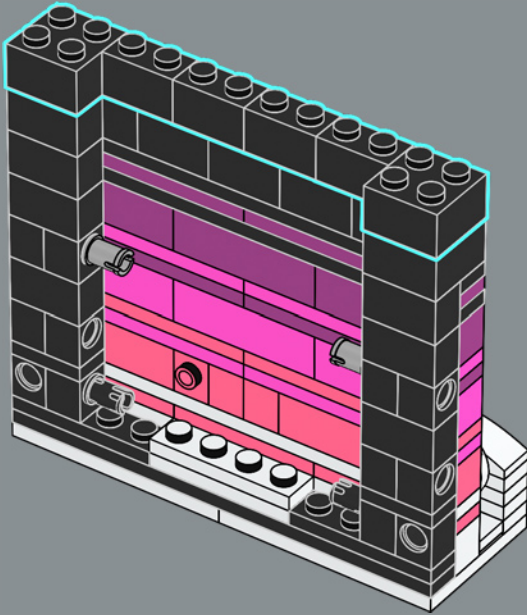

20

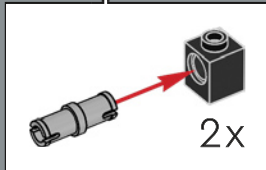
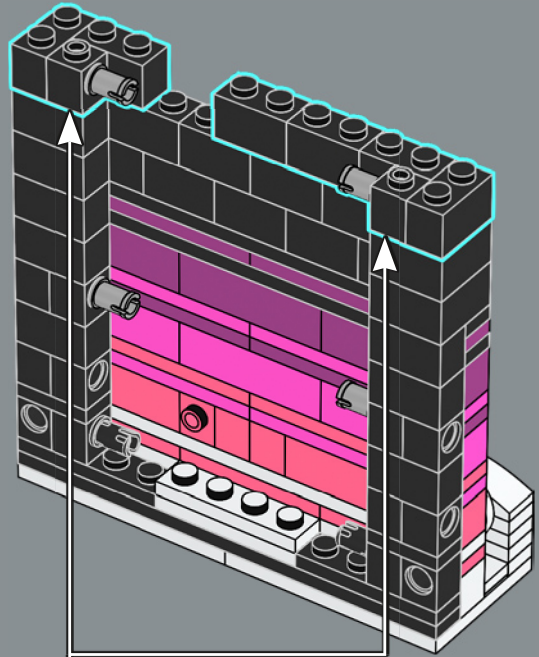

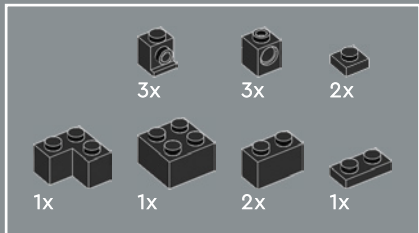

21

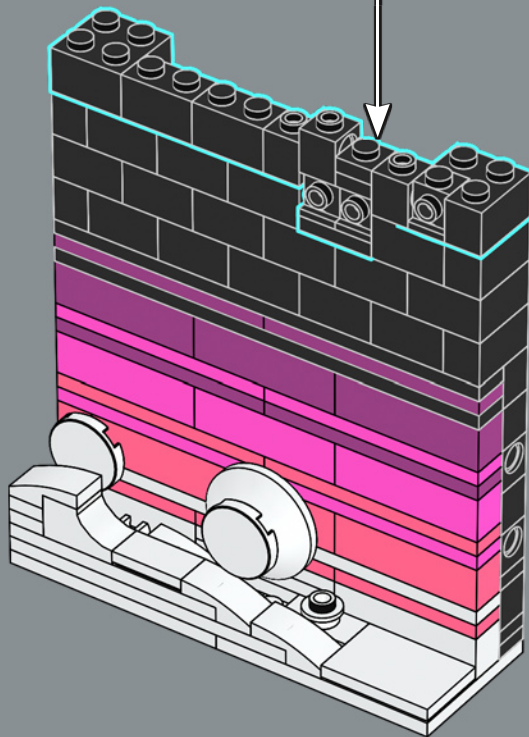
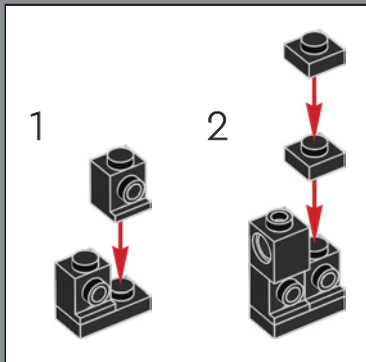

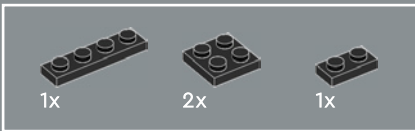

22

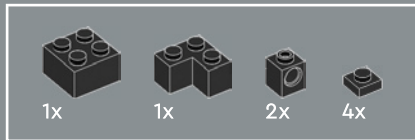
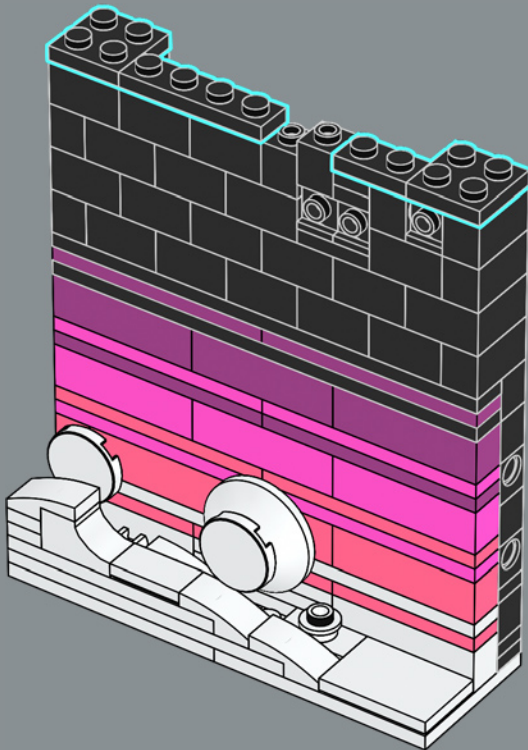

23

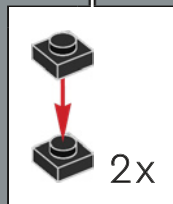
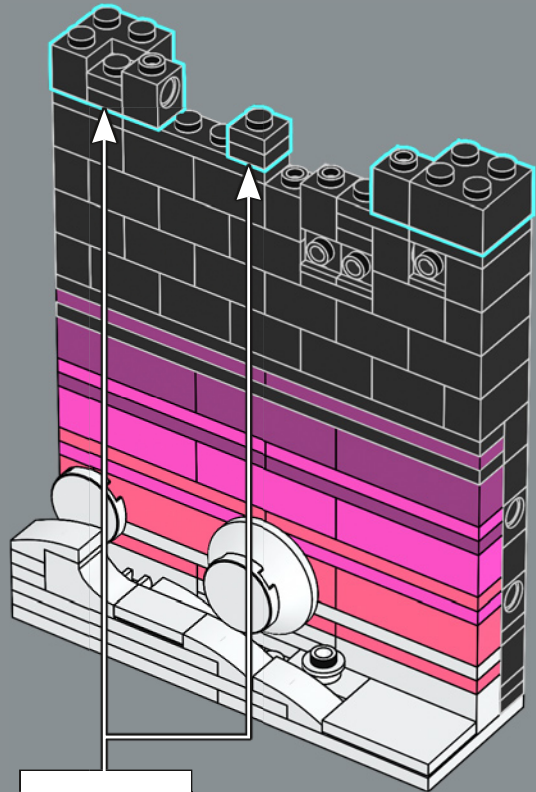



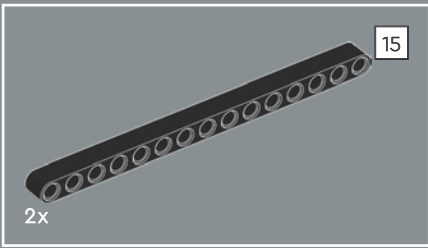

25

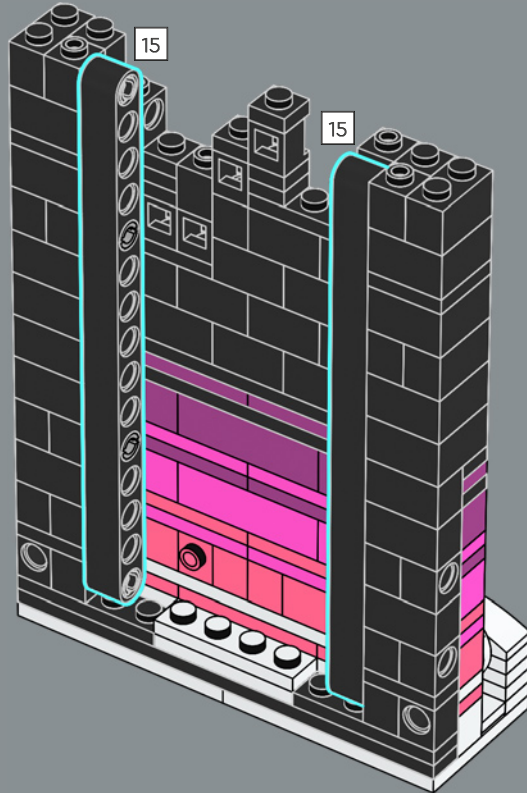



2x

26

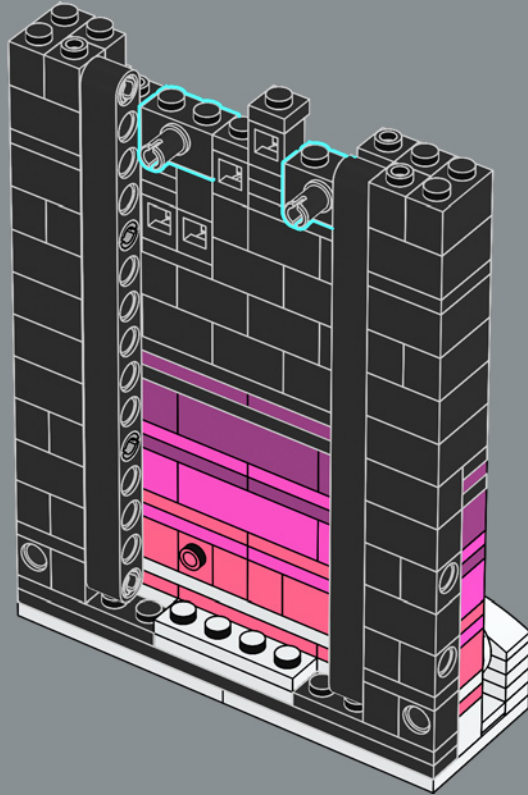



27

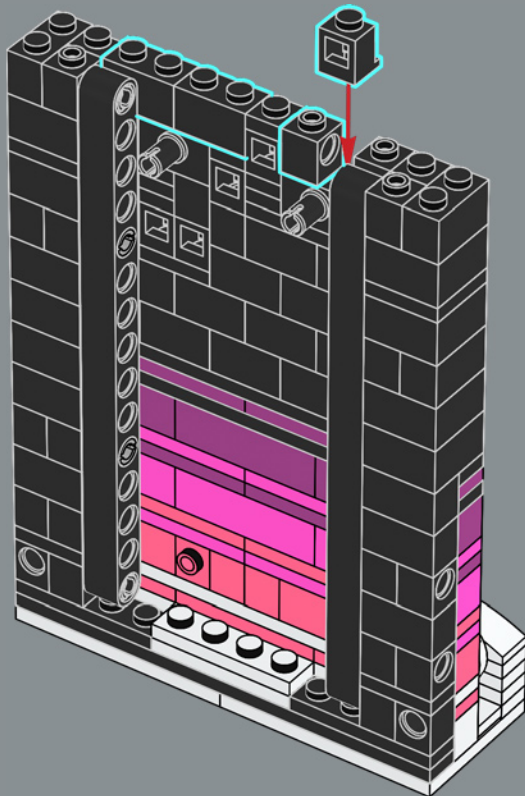

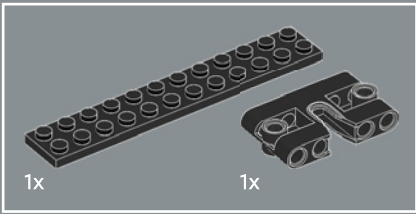

28

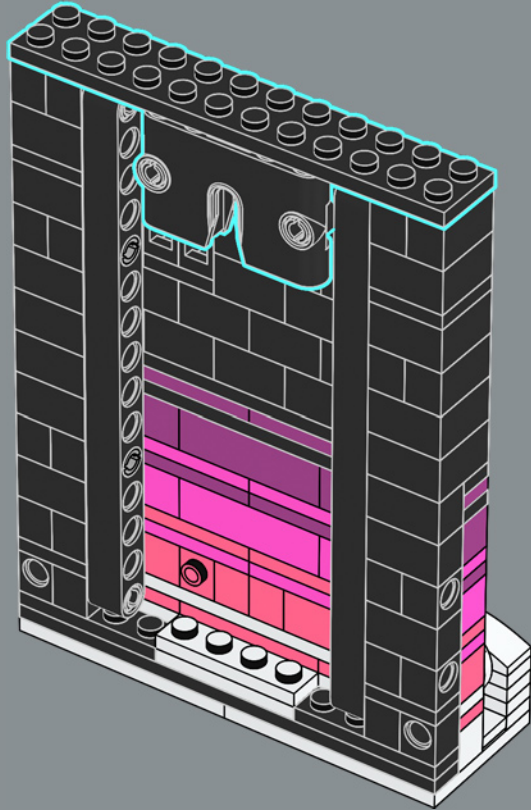



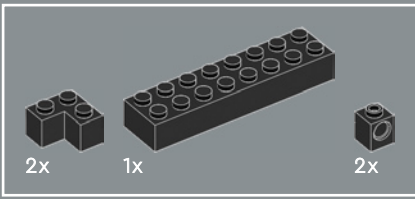

29

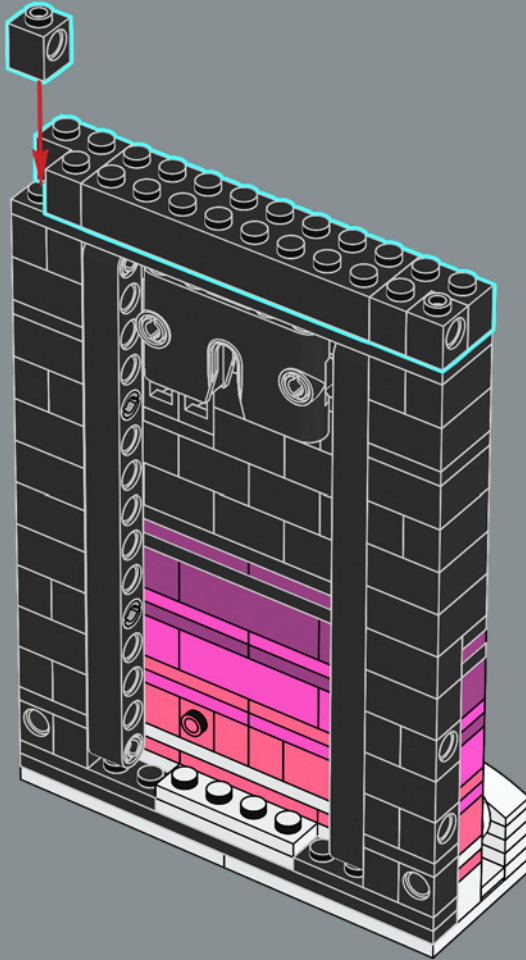

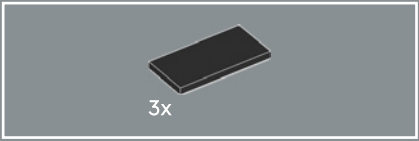

30

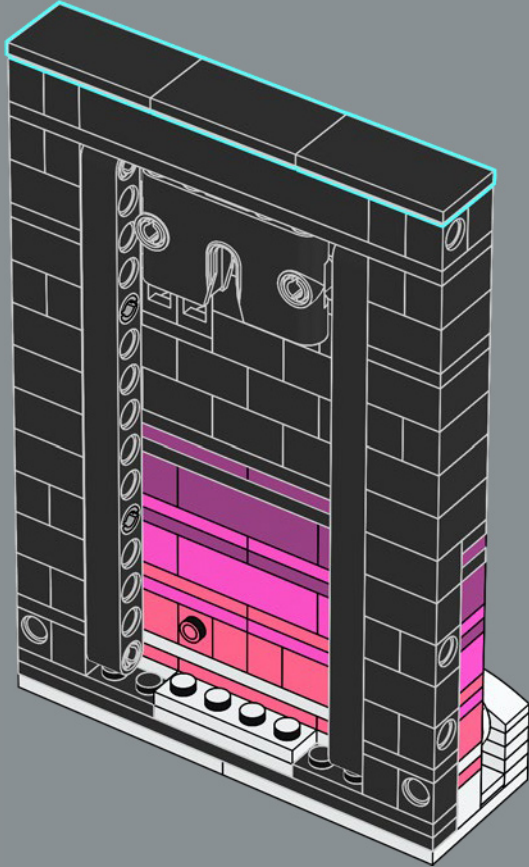

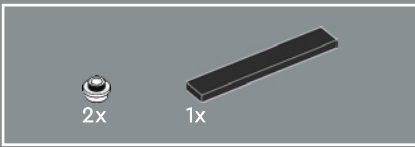

31

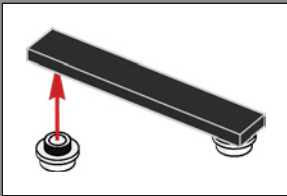

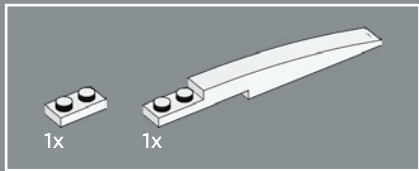

32

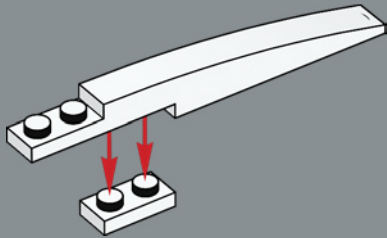

33

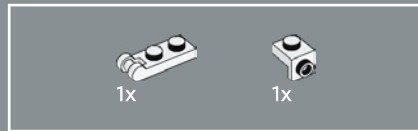
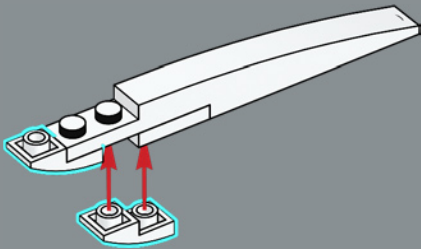

34

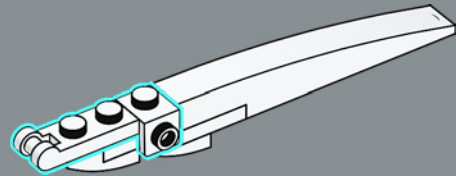

35

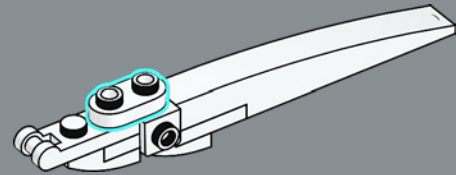



36

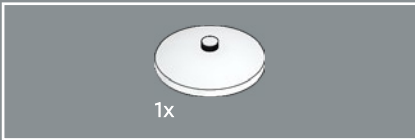
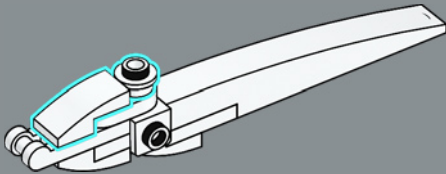

37

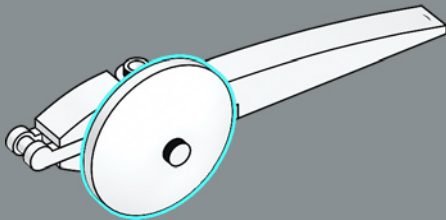

38

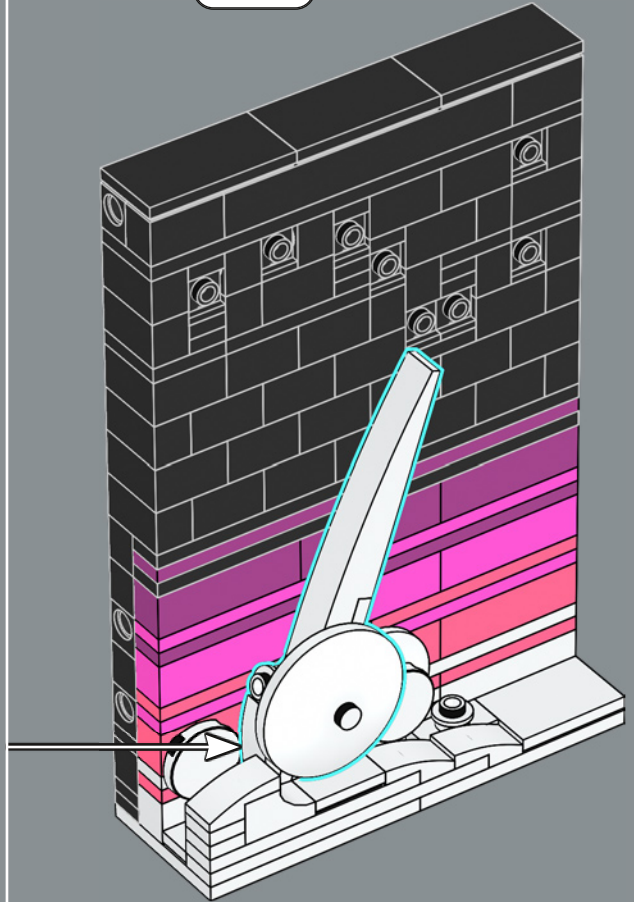

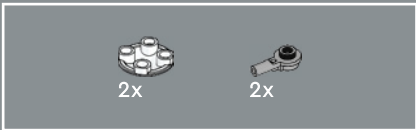

39

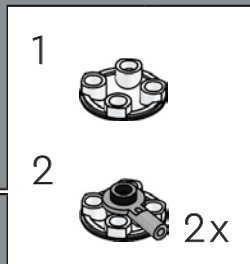
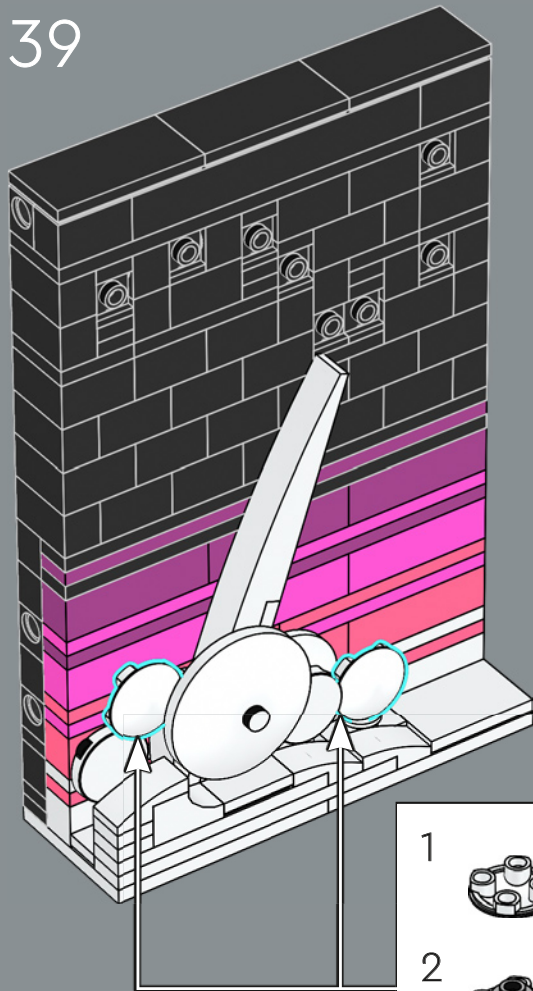

40

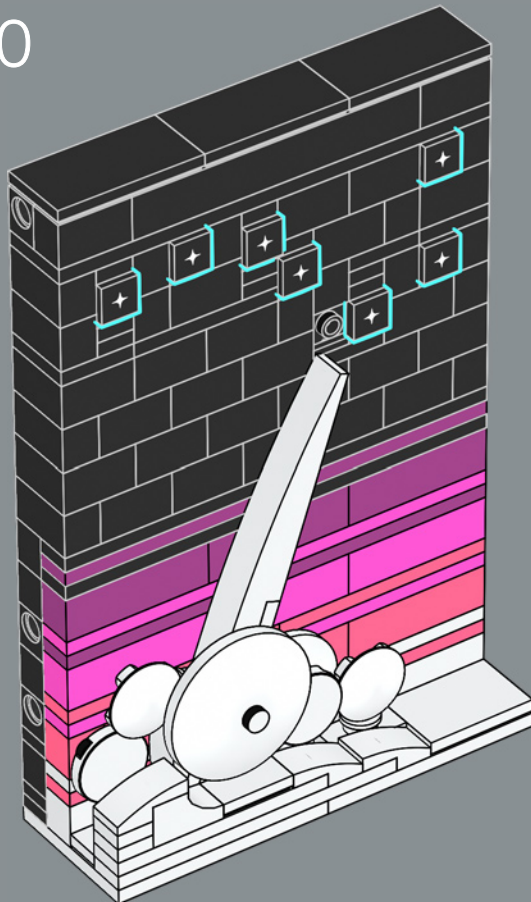



41

