



21348

1



Booklet available in English on  
Heft in deutscher Sprache erhältlich auf  
Livret disponible en français sur

Libretto disponibile in italiano su  
Folleto en español disponible en  
如需中文版手册, 请访问



LEGO® Builder



LEGO.com/sustainable-packaging



FR  
**DONNEZ**  
OU  
**RECYCLEZ**



OU



OU



ASSOCIATION    MAGASIN    DÉCHÈTERIE

Adresses sur [quefairedemesdechets.fr](http://quefairedemesdechets.fr)



# BUILDER



Apple and the Apple logo are trademarks of Apple Inc., registered in the U.S. and other countries and regions. App Store is a service mark of Apple Inc. Google Play and the Google Play logo are trademarks of Google LLC. Tencent and the Tencent logo are trademarks of Tencent Inc.

LEGO.com/devicecheck



LEGO® Builder

## Exclusive DUNGEONS & DRAGONS® Adventure

In 1974, with the roll of a die, a groundbreaking new role-playing game opened the portal to an immersive fantasy world unlike any other game before it. The lure of endless adventures beckoned players to explore their imagination, create their own stories, games, characters and rules in the real world, and form alliances and friendships with new species as they battled monsters in strange realms in the game world. **DUNGEONS & DRAGONS®** invited players of all ages to embrace their inner adventurer, warrior or imaginary creature. In this spirit of creativity and collaboration, Wizards of the Coast has developed a thrilling adventure that takes place in this LEGO® Ideas model.



Before you start playing, scan the QR code to download your copy of the exclusive adventure from our website.



## 50 years of DUNGEONS & DRAGONS®

50 years on, the game is still afoot, and these intricately detailed realms have grown to include millions of players in loyal communities around the world.

## A tribute for players, by players

“In the autumn of 2022, we launched a challenge on ideas.LEGO.com and invited fans to recreate their favourite D&D® storylines, monsters, characters, heroes or locations, using LEGO® bricks, elements and accessories. After a fierce fan vote, this model was selected as the winner to represent the fans’ tribute to 50 years of **DUNGEONS & DRAGONS®**. Partnering with game developer Wizards of the Coast, we are proud to share with you a bespoke adventure module specifically tailored to this LEGO **DUNGEONS & DRAGONS** set! Available on LEGO.com through the LEGO Insiders programme, **DUNGEONS & DRAGONS: A Red Dragon’s Tale**



takes you on an epic journey full of monsters, magic and merriment, blending the creativity of both worlds to offer a truly unique LEGO **DUNGEONS & DRAGONS** experience. We hope you will enjoy the creative storytelling as you build and play through the exclusive adventure with your party. Be inspired to display your passion for LEGO building and D&D, and create your own adventures with the set and its characters.”

*Monica Pedersen, Marketing Director, LEGO® Ideas*

## Meet the model design winner

Lucas Bolt (LEGO® Ideas name BoltBuilds) lives in Amsterdam, The Netherlands, and is no stranger to games. He studied game development and now creates 3D environments for video games.

"This challenge matched my love of LEGO building, classic fantasy, castle architecture and games. The story is based on typical aspects of a **DUNGEONS & DRAGONS**® adventure: a dungeon full of challenges and loot, a roaring dragon to defend it, and a tavern where these stories are told by the adventurers who lived through them. It's also a layout for challenges that could unfold in multiple ways, with some of my favourite creatures from the *D&D*® *Monster Manual*. The dragon in the original submission was done as a homage to the classic LEGOLAND® dragon and the LEGO Castle Dragon Knights theme from 1993. Seeing how the LEGO Ideas designers helped the idea evolve was super rewarding, and it shows how much work really goes into developing a set. To get a look inside the LEGO 'kitchen' has been a wonderful opportunity that I'm very grateful for, and it's all thanks to the fans who helped this set become a reality. Thank you all, and may all your quests be successful!"



*Lucas with his original fan submission*



## Meet the Building Instructions cover design winner

Yu Chun-Te (LEGO® Ideas name chainsaw yu 電鋸鋸鋸鋸), from Taiwan, is a Creative Director at an advertising agency and a talented illustrator. His beautiful artwork won the contest to be featured on the cover of this booklet.

"I thoroughly relish the creative process, brainstorming and experimenting with various possibilities. I often keep an eye on contests on the LEGO Ideas platform, where astonishing creations truly captivate me. I spent a considerable amount of time researching various D&D® artwork to decide on a theme and decided to adopt a relief-like form. Given the nature of this style, I had to balance between avoiding excessive realism and maintaining a clean and concise appearance. I also needed to create an overall sense of antiquity and weathered texture, which wasn't my strong suit. Additionally, recreating the well-known antagonist character posed a difficulty as it required staying faithful to the original design. I hope fans will enjoy the result as well as the model!"



*Yu Chun-Te with his original cover submission*



## Gather your party and venture forth

*It's late when you arrive at the half-empty tavern. The heat from the fireplace soothes your aching bones. A group of your fellow travellers is already seated at the corner table. You're the one they have been waiting for. This is it - your adventure is about to begin.*

To understand why **DUNGEONS & DRAGONS**® has become the global phenomenon it is today, let's start at the beginning. Playing games together as a family, a group of friends, or in tournaments has been part of every known culture for thousands of years. Even now, with millions of digital games available, a fun game night is still a welcome chance to immerse ourselves in a playful activity and connect with each other. But when game developers Gary Gygax and David Arneson released their first version of **DUNGEONS & DRAGONS** in 1974, they entered uncharted territory in the tabletop games category.







## Roll for initiative

The original D&D® system was inspired by the epic scope of fantasy literature and the detailed miniatures of tabletop wargames. These passions were combined to make a revolutionary 'tabletop role-playing game' where players imagined themselves as adventurers questing through fantastical lands. As their characters met challenges – such as monsters or dungeons – they consulted rules and rolled dice to determine

the outcome of their actions. Dice added unpredictability to the story, meaning that no two D&D games could ever be the same. Throughout every iteration over its fifty-year history, D&D's spirit of collaboration and creativity has remained at the core: there are no winners or losers, just players telling an epic story together. The possibilities remain endless.

## Meet your monsters

Some of the most iconic denizens in the worlds of **DUNGEONS & DRAGONS**® are the monsters. From minuscule to magnificent, they take skill, cunning and collaboration to beat. Meet some of the monsters you will encounter in your LEGO® Ideas D&D® adventure – and be inspired to expand with more!





## Skeleton

A solid staple in any D&D campaign, the skeleton may, at first glance, seem simple, with its limited capacity for independent thought or battle skills, but with a creative Dungeon Master, there is no limit to the fun you can have with these spindly creatures.



## Gelatinous cube

Usually found filling corridors or blocking any escape from dungeons, these slow-moving, mindless, amoeba-like beings are completely transparent and difficult to spot. A reflection of light on its surface may give away its position. They can absorb and dissolve most organic matter that gets in their way.



## Owlbear

Living up to its name in terms of both looks and behaviour, the owlbear is one of the most feared predators in the wilderness. With senses as sharp as its talons, and a heightened sense of smell, this unnatural creature is a volatile fighter who likes to hunt its prey for sport.



## Beholder

Feeling watched? Feared by adventurers for its unpredictability and power, this floating spherical creature emits different magical rays from each of its eye stalks to inflict perilous harm on its enemies. The beholder is highly intelligent, ruthless, a fierce opponent and a true test of a party's mettle.



## Displacer beast

This six-legged, tentacled, feline-like beast sometimes hunts in packs but is just as often seen on its own, attacking lone travellers. A displacer beast can bend light to appear to be several feet away from its actual location, allowing it to take enemies by surprise. It is a popular guardian among wizards and others who use magic.



## Mimic

While some mimics are more intelligent than others, they are tough, complex creatures. A fun favourite among Dungeon Masters, the mimic's natural shapes can vary, often resembling a wooden treasure chest or a rock, and they can flawlessly take on any appearance to suit their needs – maybe even a bed!



## Cinderhowl the red dragon

Dragons are powerful spellcasters and more intelligent than any human. A frightful presence, this almighty foe is one of the most daunting monsters you will encounter. Just one beat of its wing can cause calamitous damage, not to mention its claws, bite and devastating fire-spewing. Defeating Cinderhowl the Red Dragon requires a group of highly-trained adventurers. Good luck!

## Chapters from the first 50 years

From its early predecessor to modern editions, the DUNGEONS & DRAGONS® Player's Handbook® provides everything players need to create and navigate intriguing campaigns and role-playing adventures.

After the quite complex and equation-heavy rules in the early editions, later updates became more refined and welcoming to new players.



1974, DUNGEONS & DRAGONS  
By Gary Gygax and Dave Arneson, TSR

With *Rules for Fantastic Medieval Wargames Campaigns Playable with Paper and Pencil and Miniature Figures*, DUNGEONS & DRAGONS® consisted of *Volume 1: Men & Magic*, *Volume 2: Monsters & Treasure* and *Volume 3: The Underworld & Wilderness Adventures*.

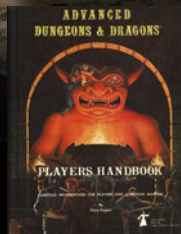

1983, DUNGEONS & DRAGONS Set 1:  
Basic Rules

This iconic rule set included a simpler, clearer version of the rules and story universe to ease in new players. Even today, it remains a popular introduction to the game that new players can study to familiarise themselves with D&D® lore.



1989, Player's Handbook® Second Edition

The Second Edition saw the rise of new, iconic settings, including the Forgotten Realms, Planescape, Dark Sun and Spelljammer. The *Monster Manual* was relaunched as the *Monstrous Compendium*.



2000, *Player's Handbook*® Third Edition

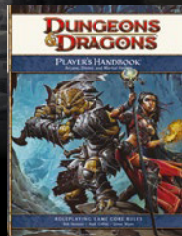

2008, *Player's Handbook*® Fourth Edition



2014, *Player's Handbook*® Fifth Edition

The first edition produced under new owners Wizards of the Coast featured more details of the universe, mechanics and rules. The introduction of the 20-sided die (d20 System) added more depth and story arcs to the gaming experience. It was later revised, based on player feedback, and released as version 3.5. This version still remains popular among fans.

The Fourth Edition took the game through significant gameplay changes, with new combat mechanics, spell changes and skill challenges. It was the first edition to integrate a digital subscription and, although not every change was welcomed by fans, it paved the way for the immensely popular Fifth Edition.

This edition has helped enable a massive surge in the game's popularity, with updated mechanics that streamlined play, including modified skills, spells, feats and the 'advantage/disadvantage' feature. The power system reverted to a more traditional one, with class features gained on character level.

# Meet your heroes

Choose your character and your party wisely, and your riveting adventure can begin!



## Dwarf cleric

A cleric channels divine magic from the god they serve. They are powerful healers who can help their party survive any encounter. In battle, clerics wield a holy symbol and a weapon that shines with radiant light.



## Gnome fighter

Practice makes perfect when you're a fighter. These warriors train with a variety of weapons and armour to become masters of combat. They learn to think clearly in battle and to push themselves beyond normal limits to keep their allies safe.



## Orc rogue

Rogues are masters of stealth who can attack from the shadows or sneak past without a sound. Their clever minds and quick fingers are adept at picking locks and disarming traps. If a rogue is watching, you won't know until it's too late!



## Elf wizard

Wizards study books and scrolls to learn the art of magic. They copy spells into their spellbook, the sum of all their knowledge and their most precious possession. Each wizard specialises in a School of Magic, such as illusion, necromancy or enchantment.



## From niche to global phenomenon

Since the 1970s, the game has spawned tournaments and live-action role-playing events in local and global communities, and the **DUNGEONS & DRAGONS**® universe has expanded into novels, video games, a TV show and films. While D&D® was briefly targeted by the moral panics of the 1980s, research has proven that the game can be a successful therapeutic tool for both adults and children, from advancing social skills and empathy to improving creative thinking, language and problem-solving skills. Many schools around the world even facilitate D&D clubs as an after-school activity.

## Expand the gaming experience

D&D® has inspired pop culture, a myriad of books, and new franchise games, both tabletop and digital. Since the early 2000s, the evolution of the game by Wizards of the Coast has cemented the legacy of D&D as a global phenomenon. Online tools such as D&D Beyond, podcasts, streaming and social media have helped spread the game's reach with a strong, collaborative creator community and accessible entry points for new players. Whether you are new to this incredible world, or already an experienced player, we hope this set will inspire endless new ideas for how you can expand the gaming experience.



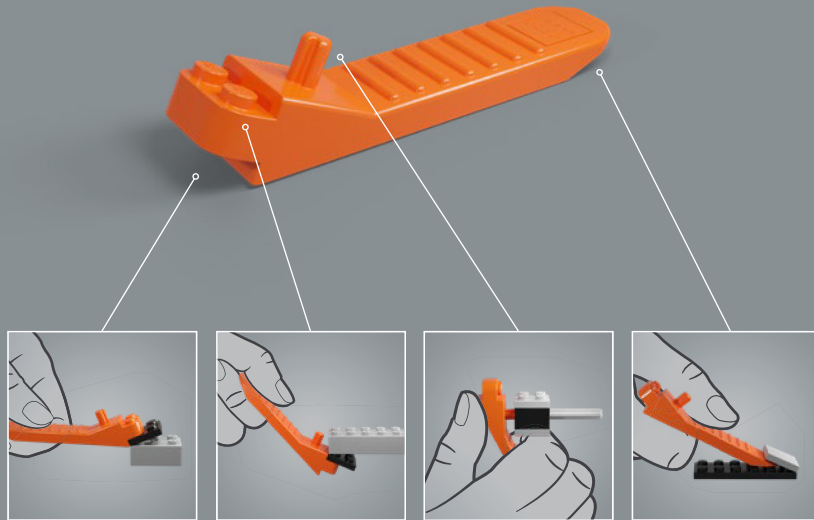

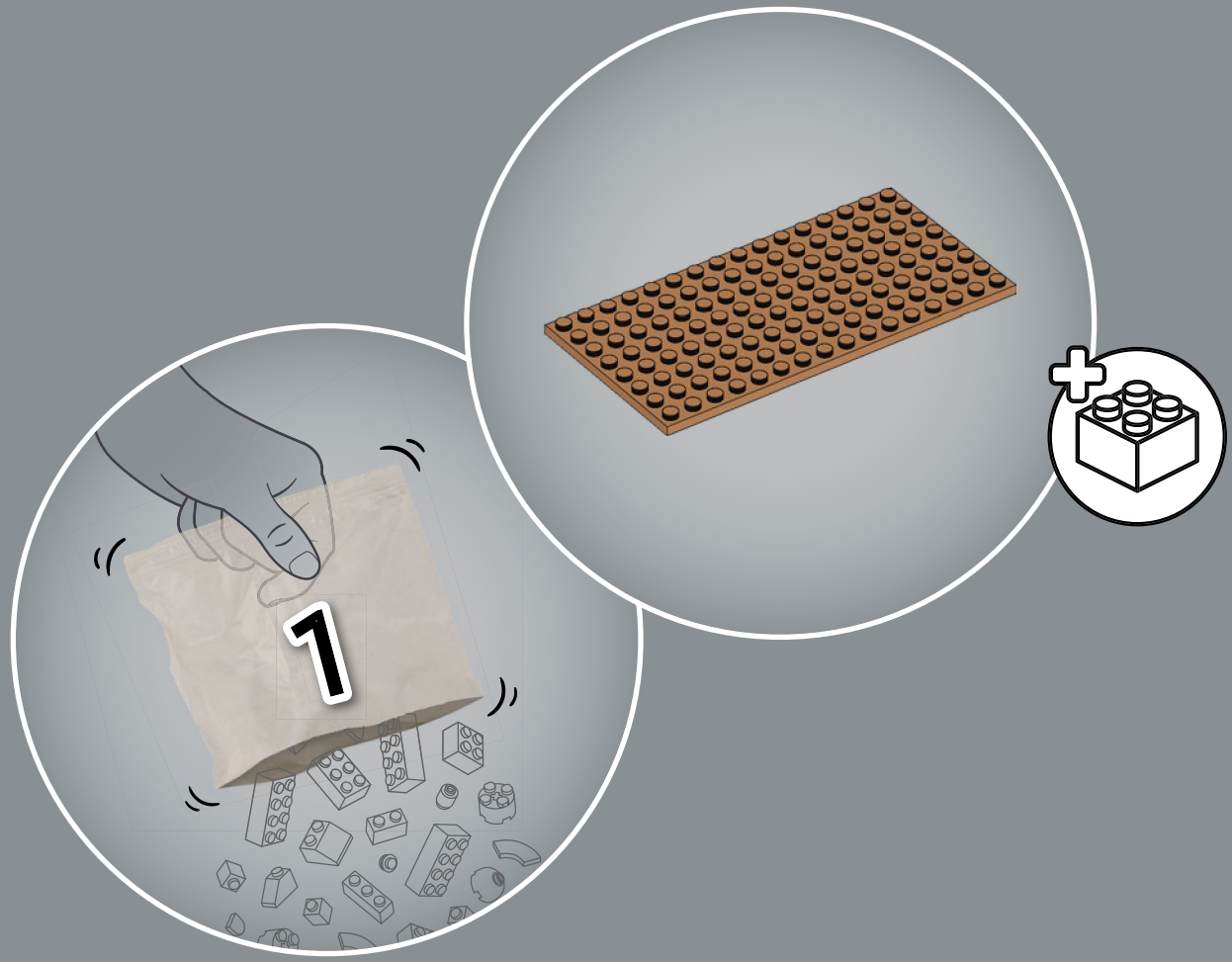

1

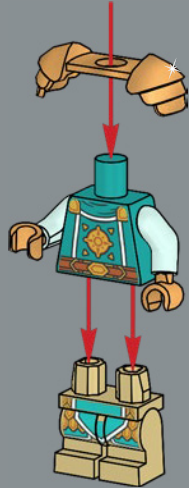

2

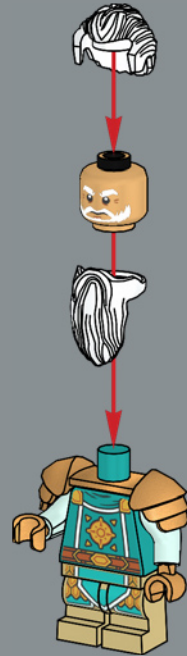

3

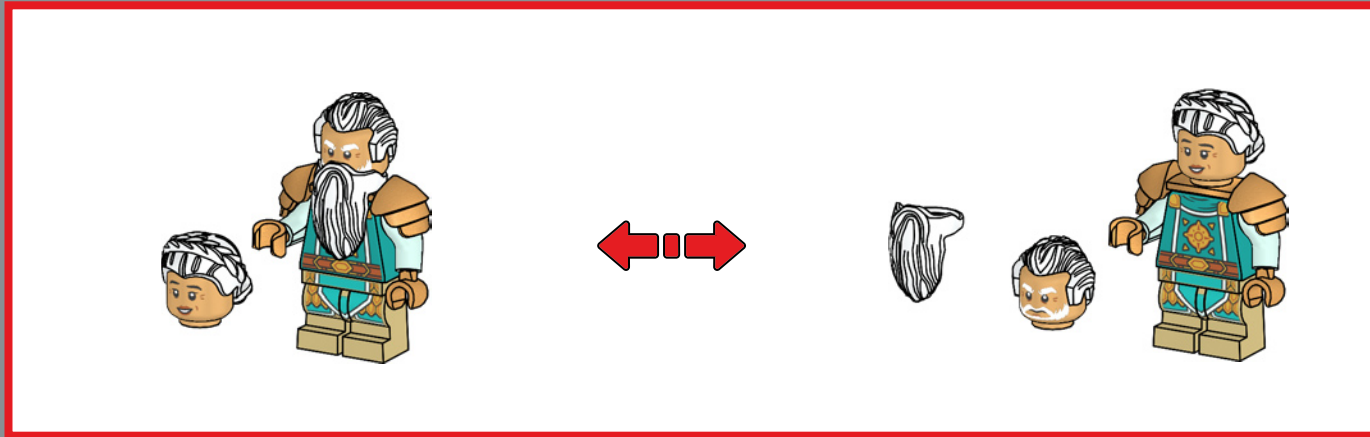
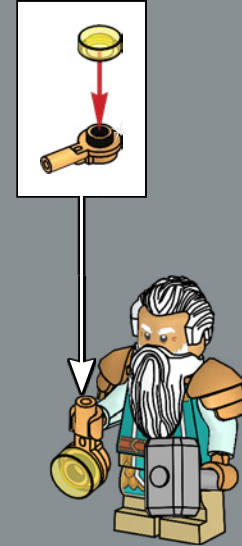

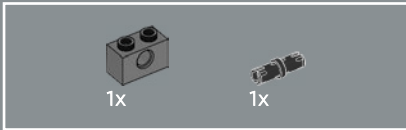
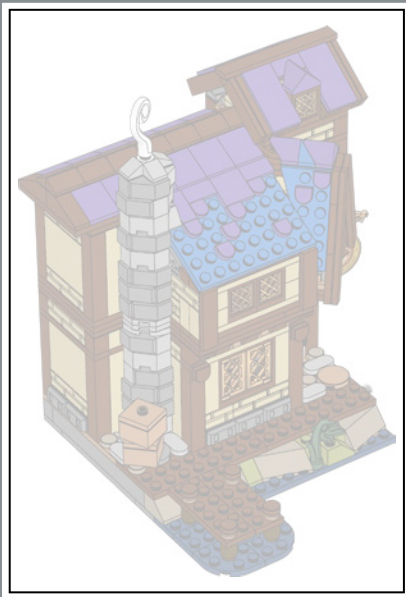

1

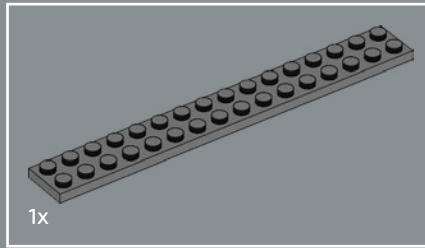
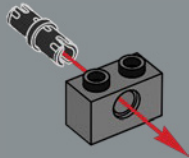

2

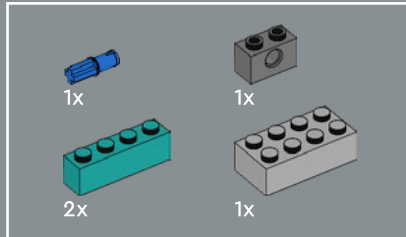
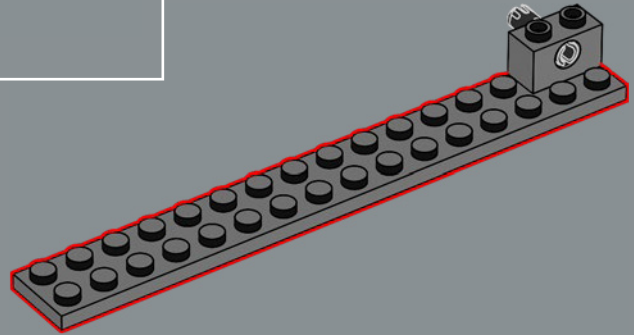

3

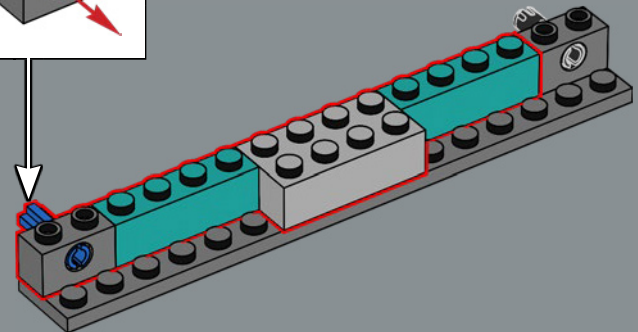
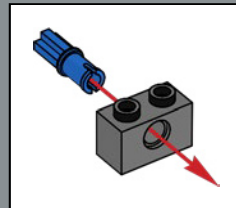

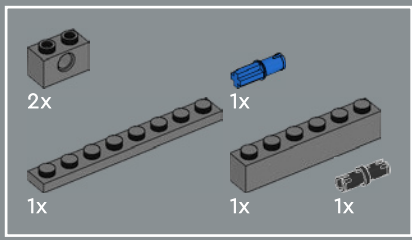

4

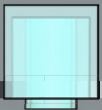
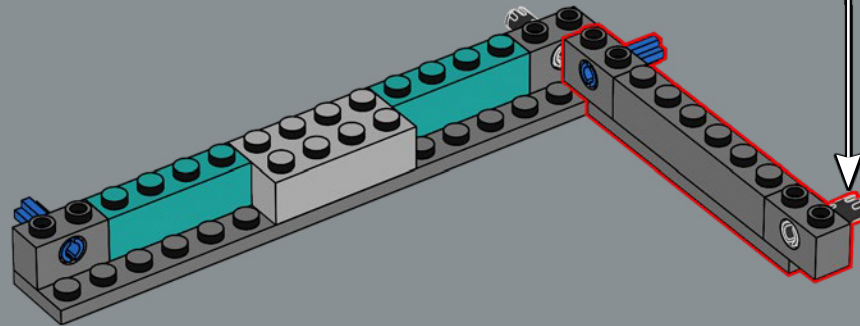
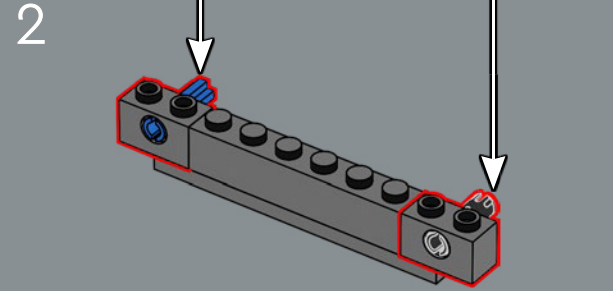
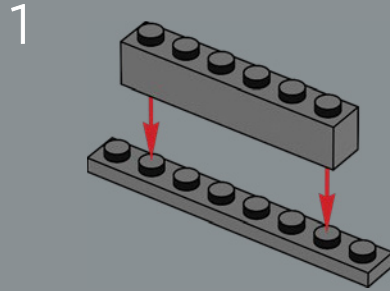

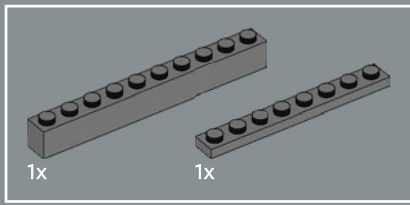

5

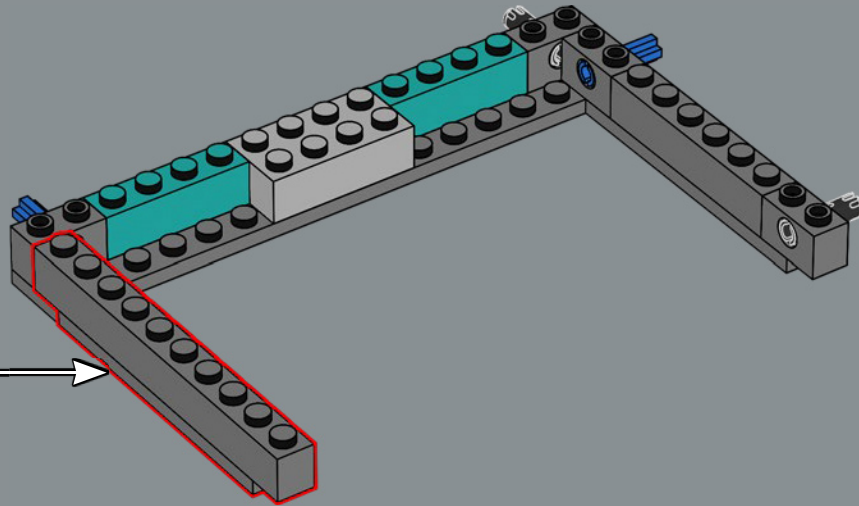
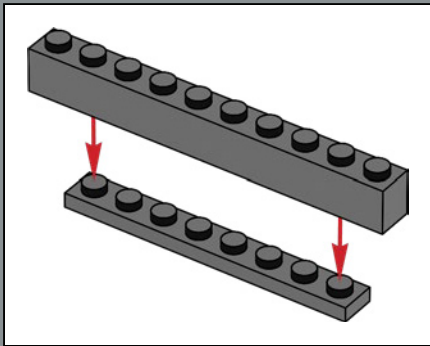

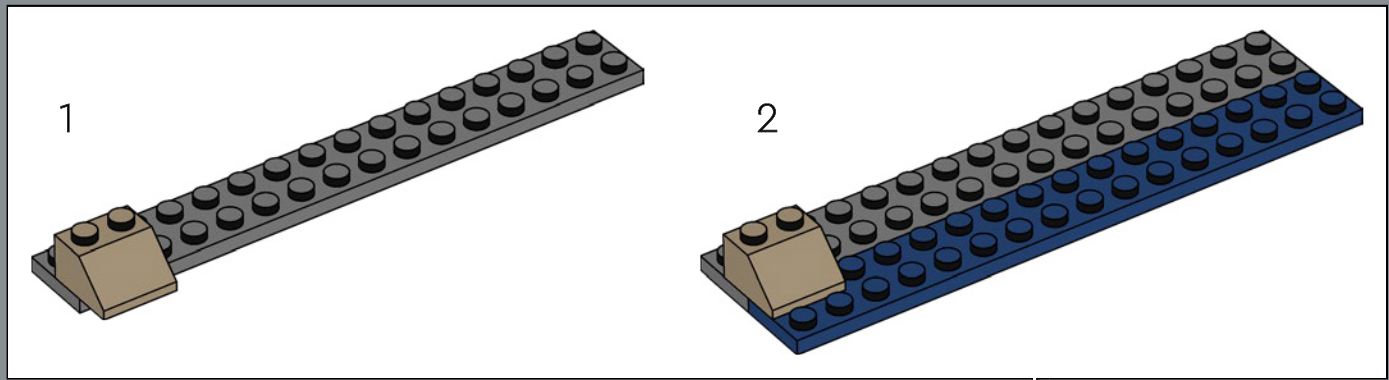
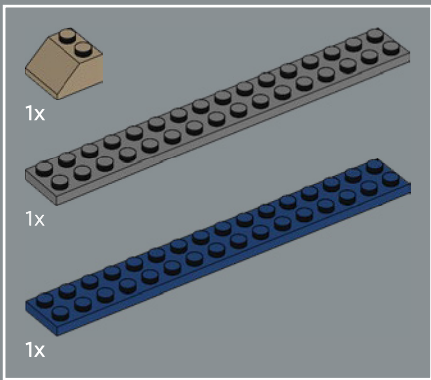

6

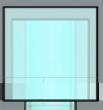
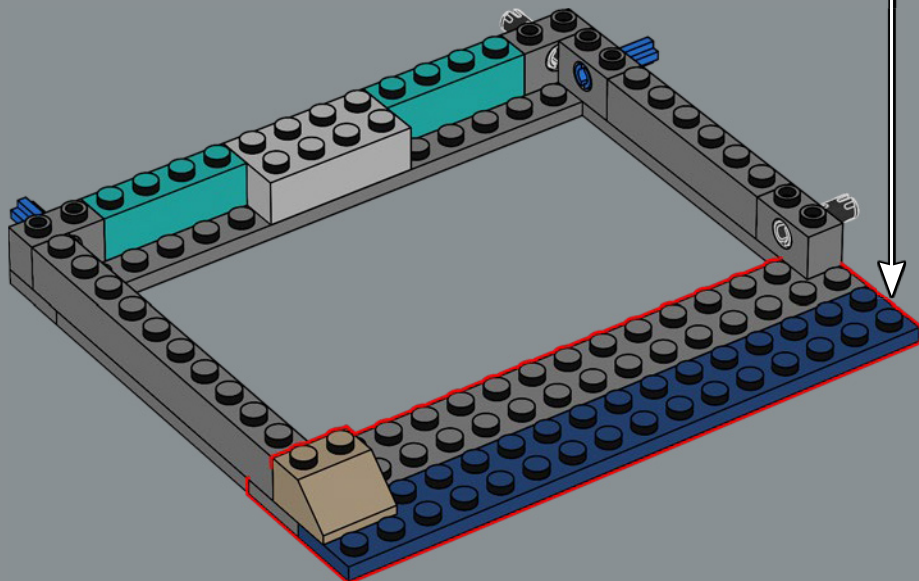



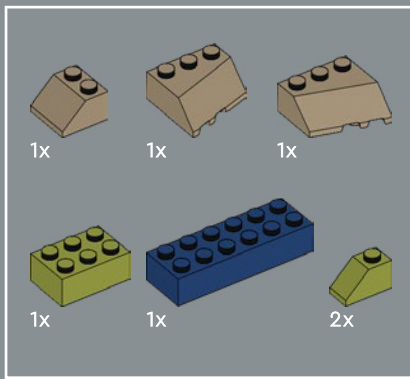

7

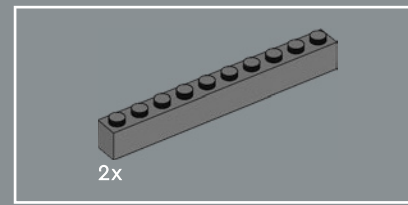
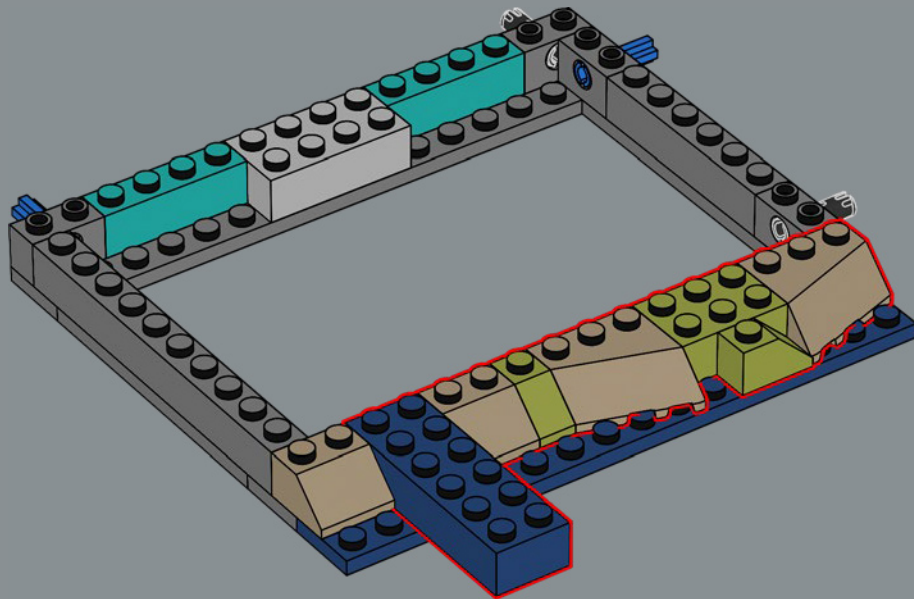

8

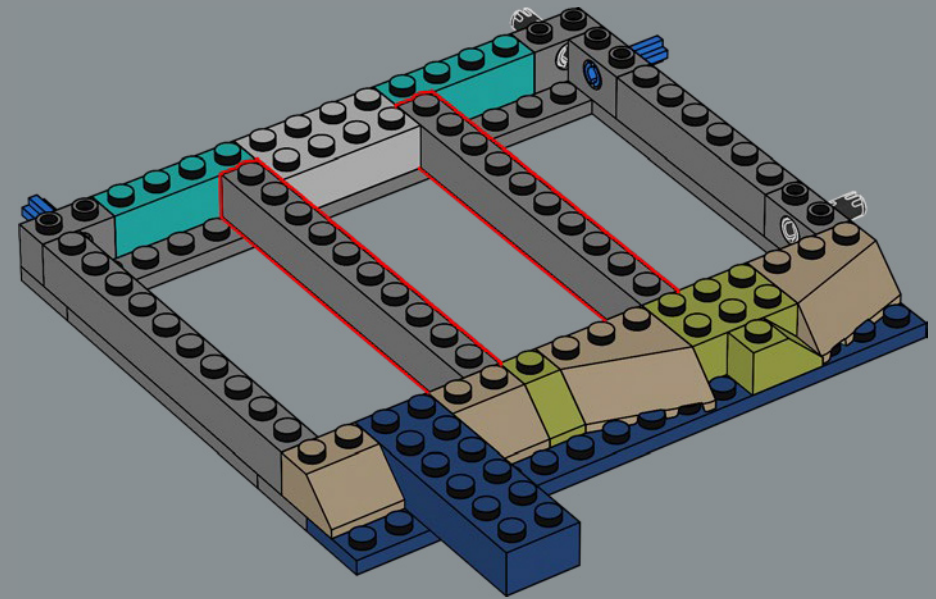

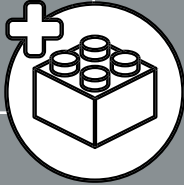
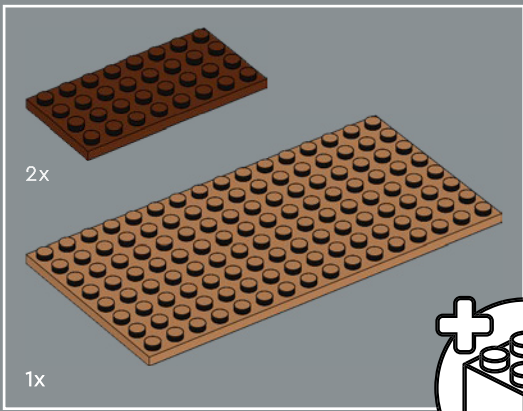

9

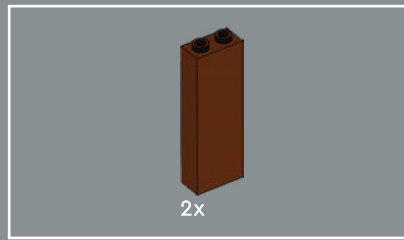
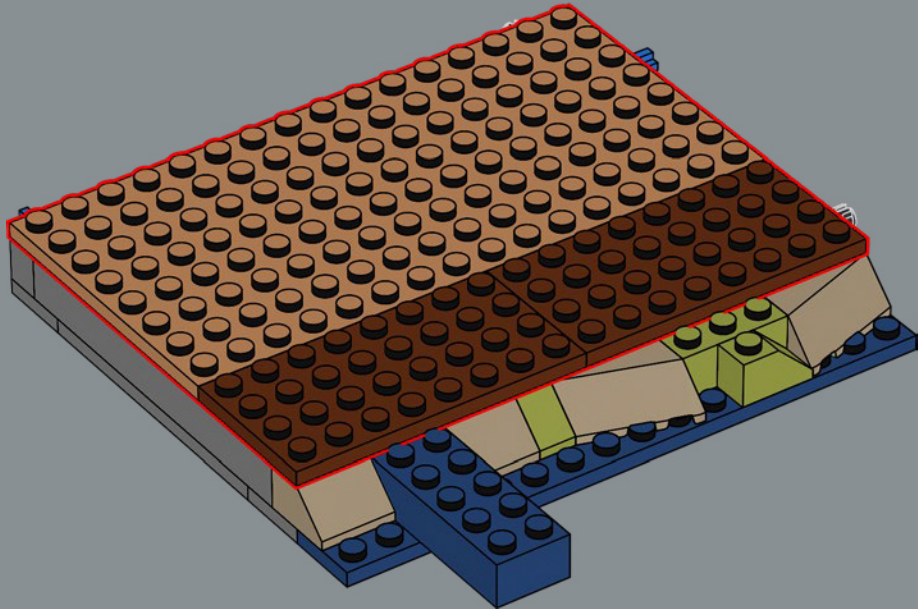

10

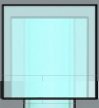
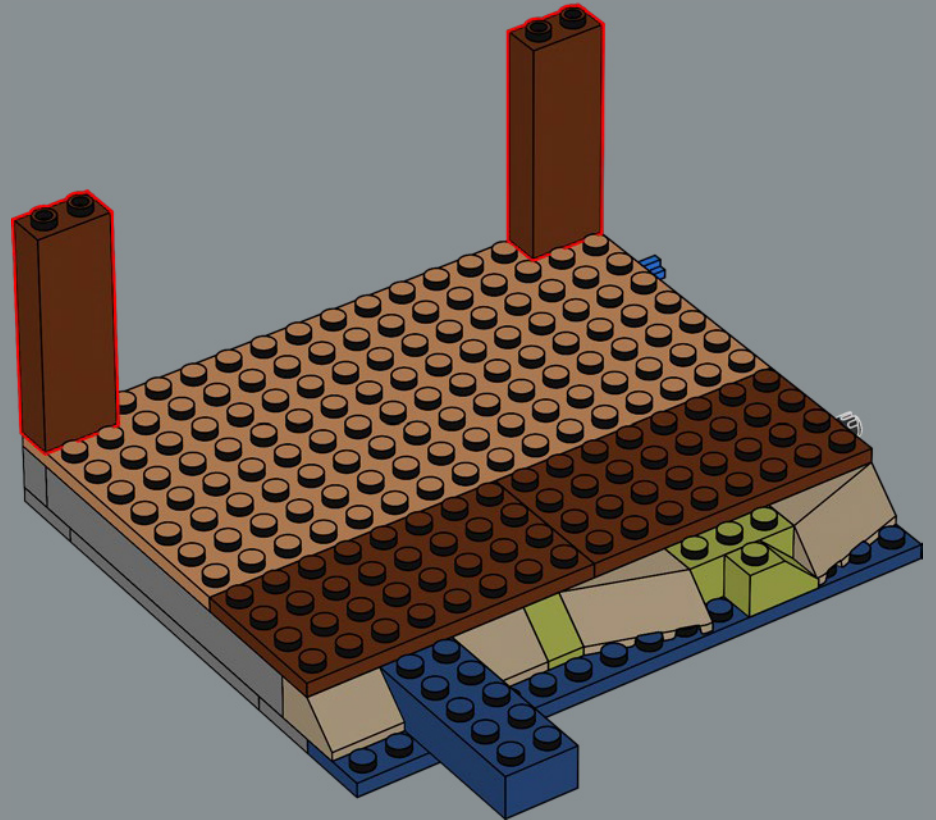

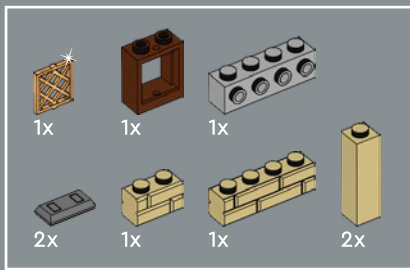

11

1

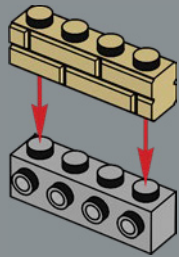

2

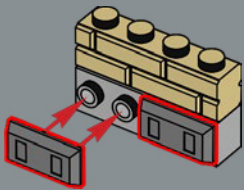

3

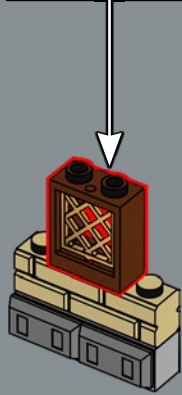
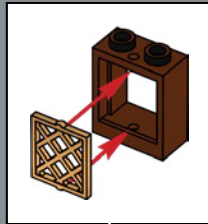

4

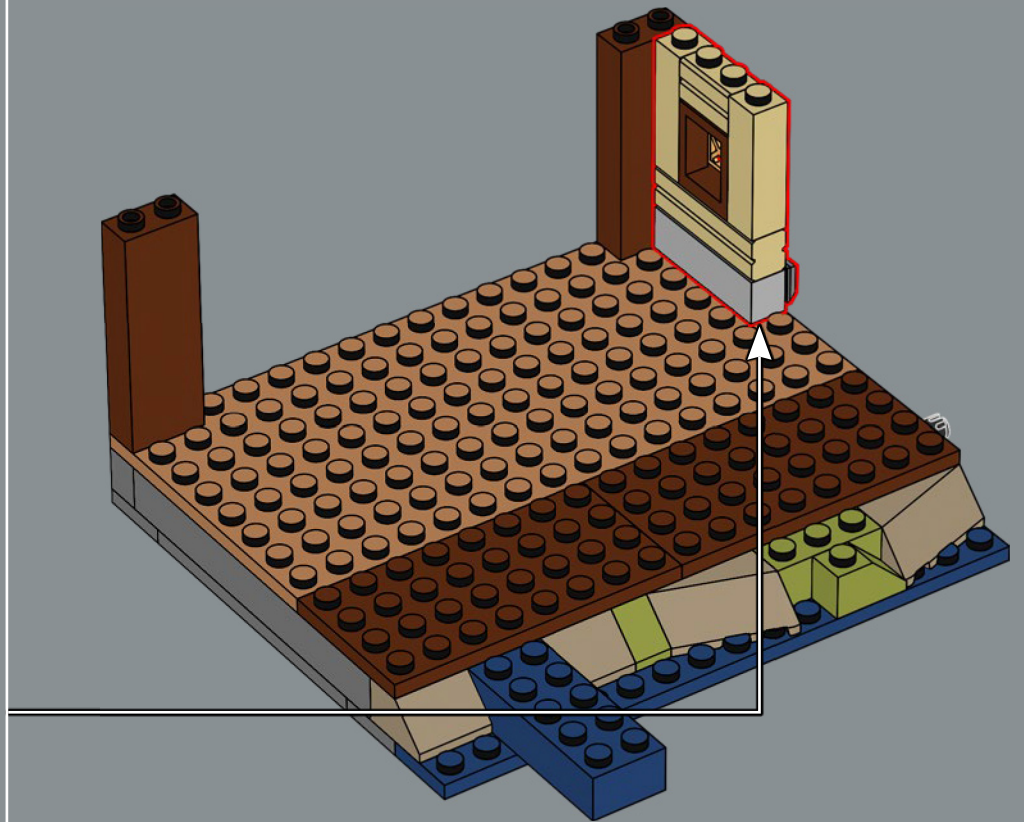

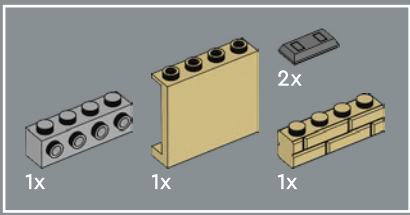

12

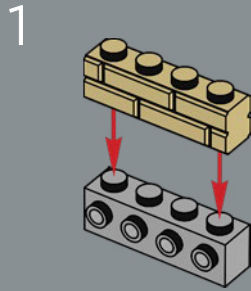

3

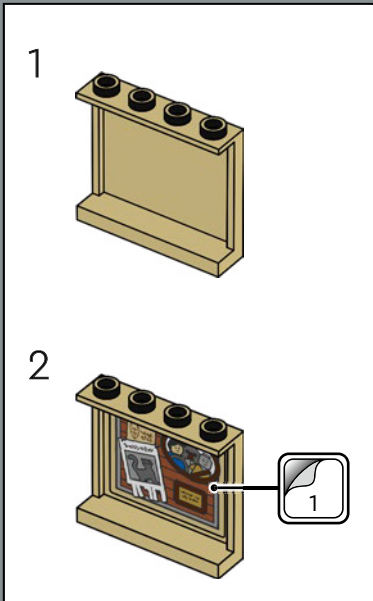
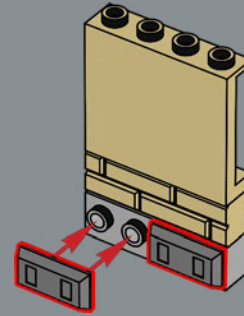

2

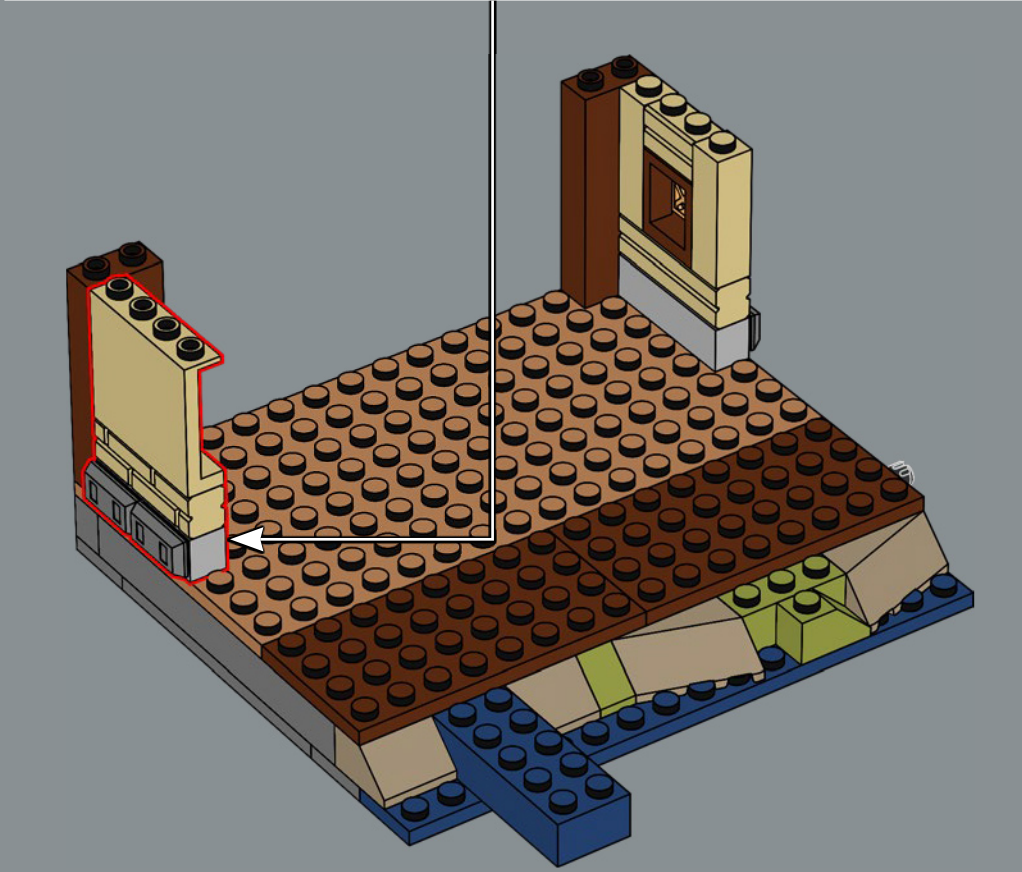
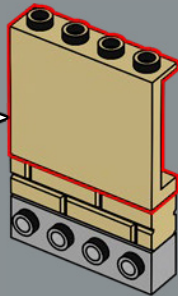



13

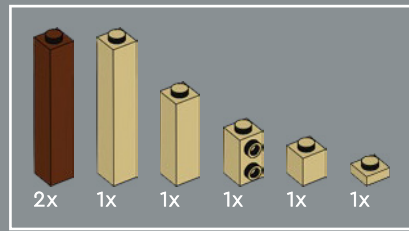
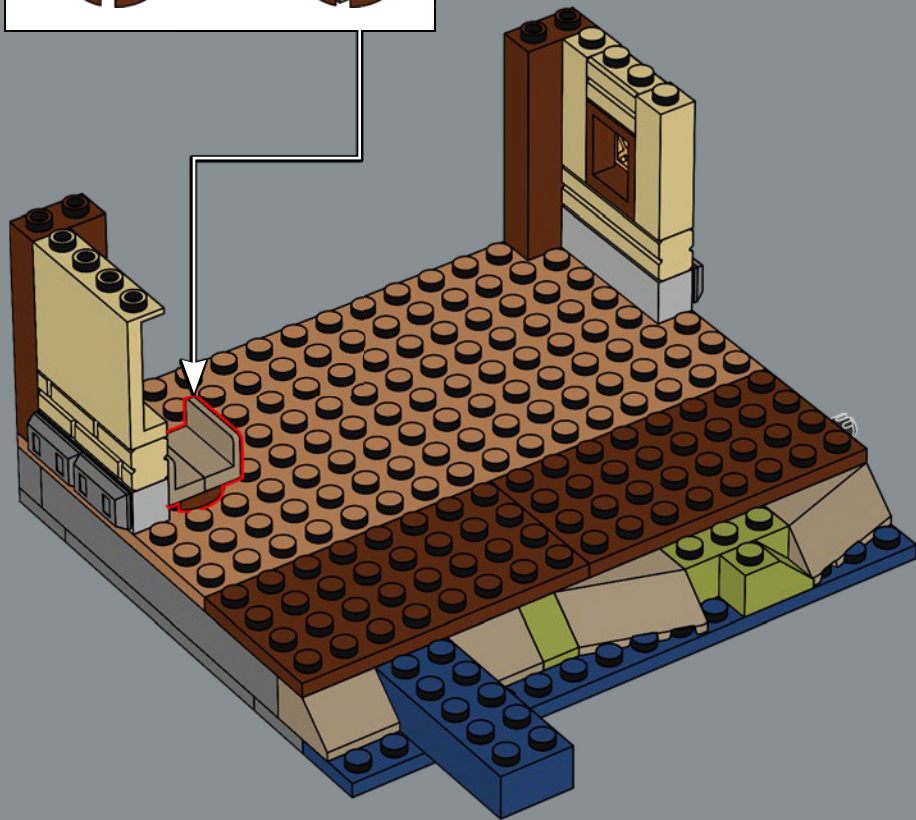
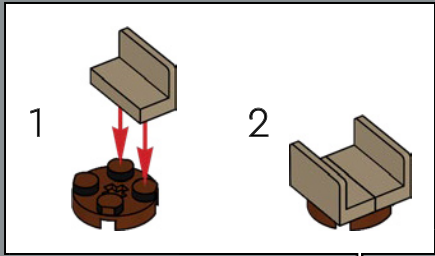

14

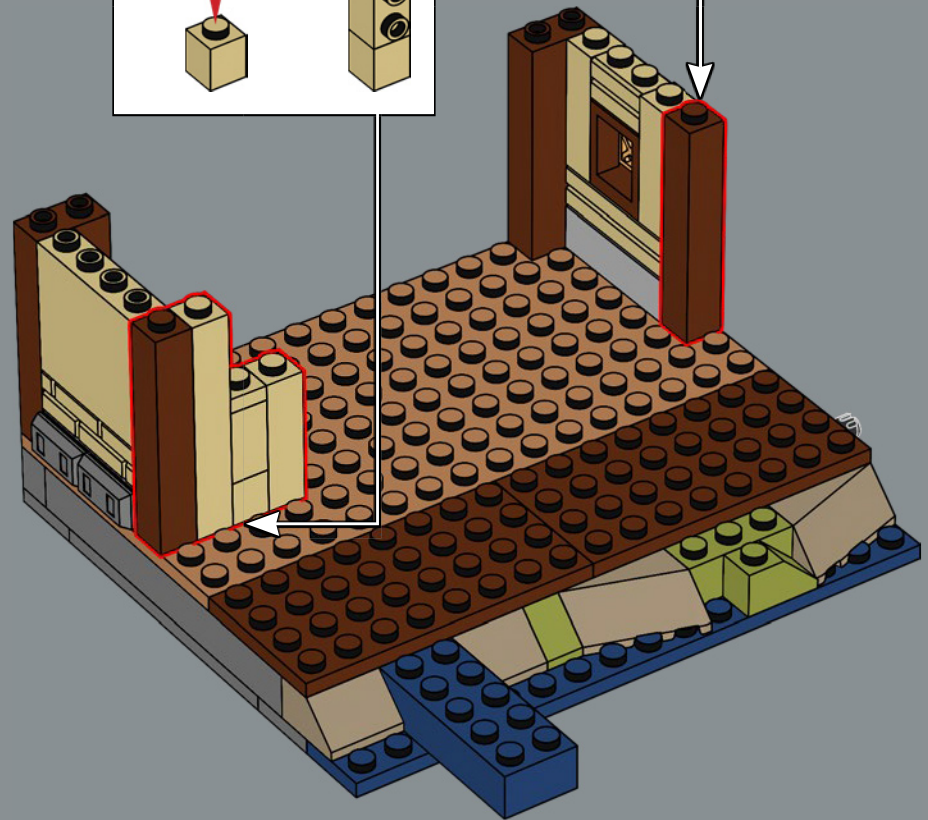
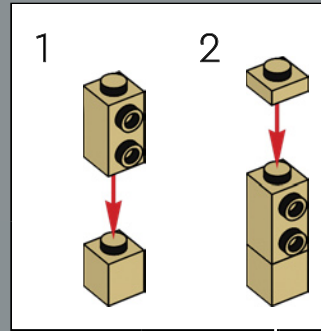

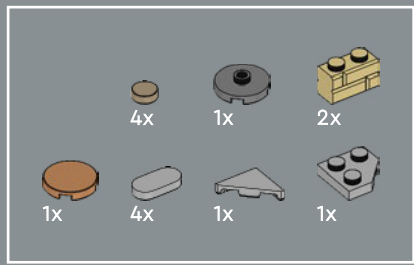

15

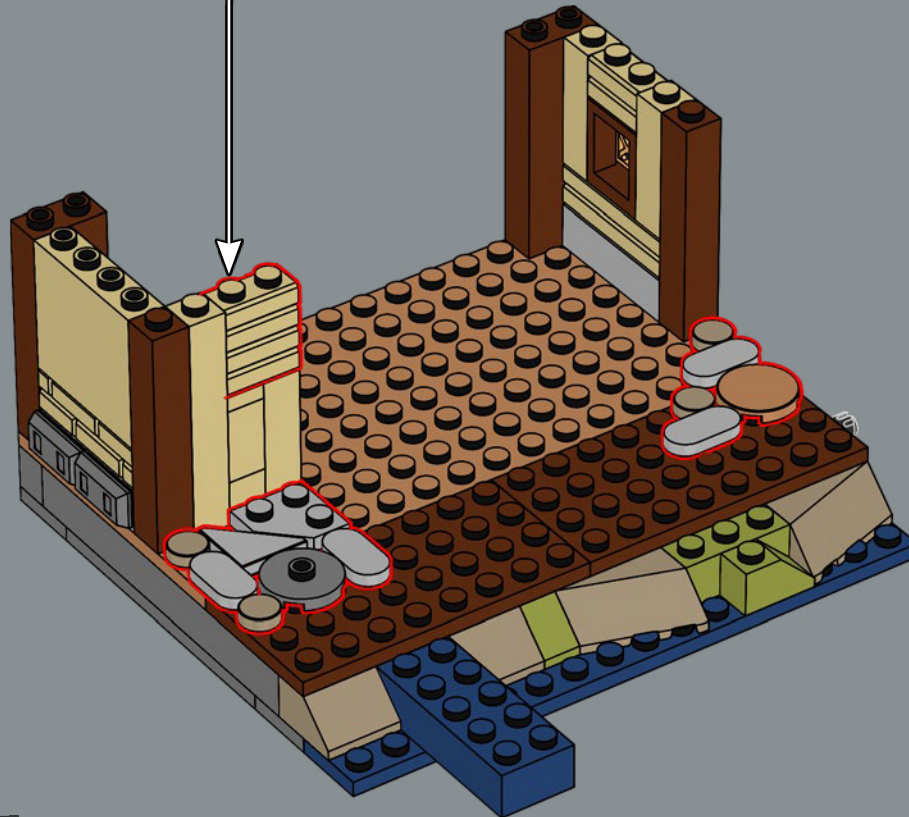
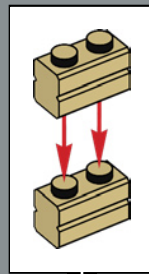

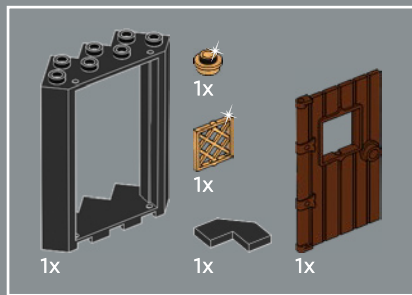

16

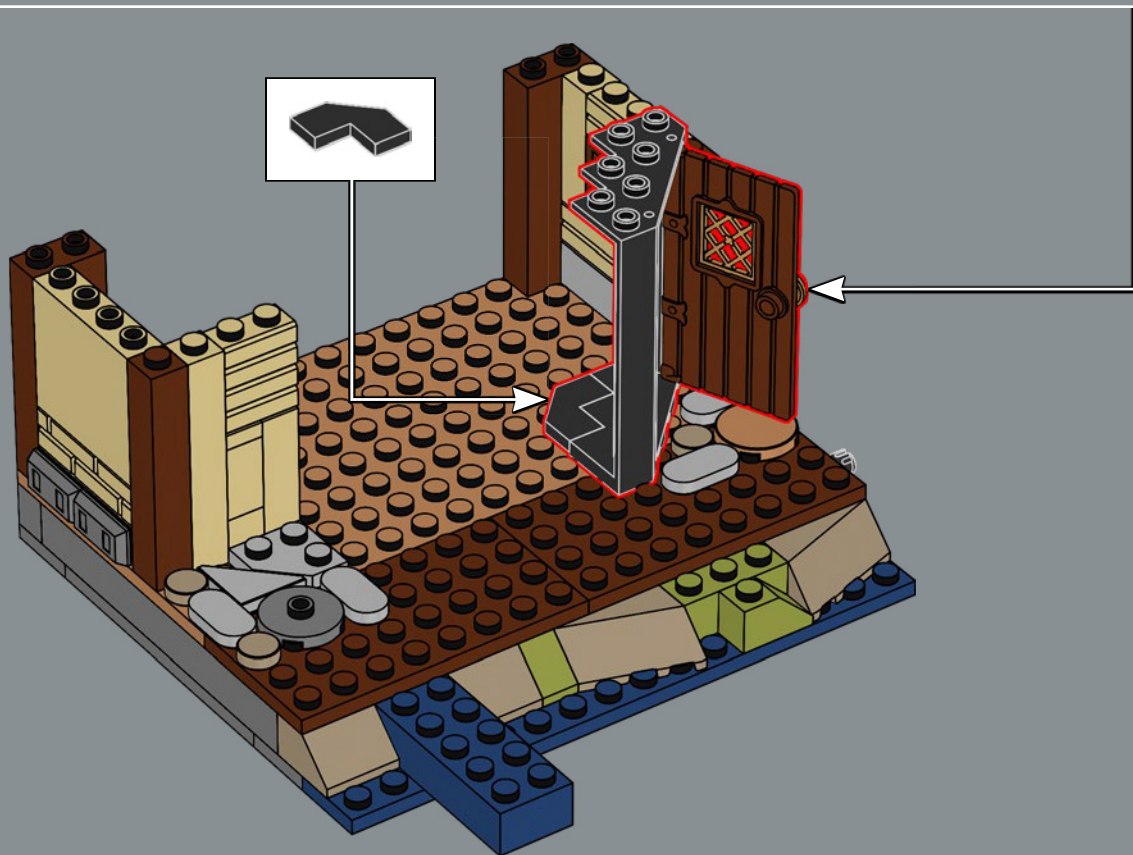
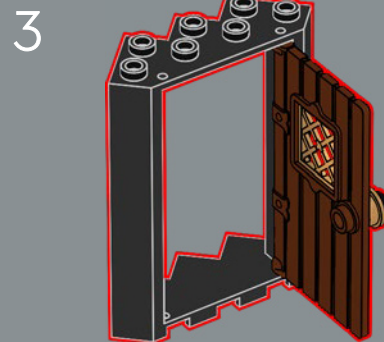
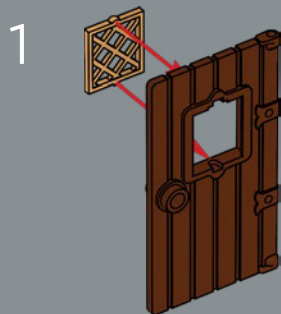

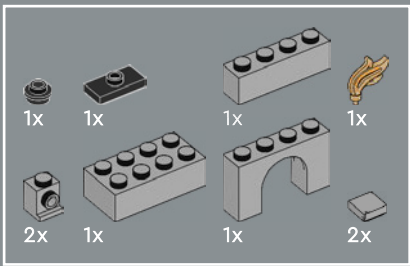

17

1

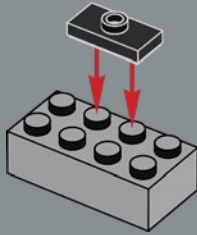

2

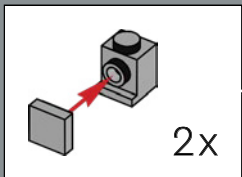
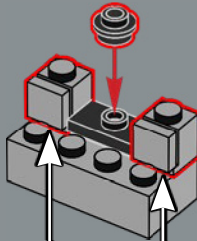

2x

3

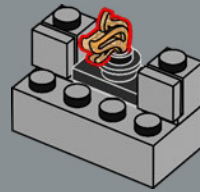

4

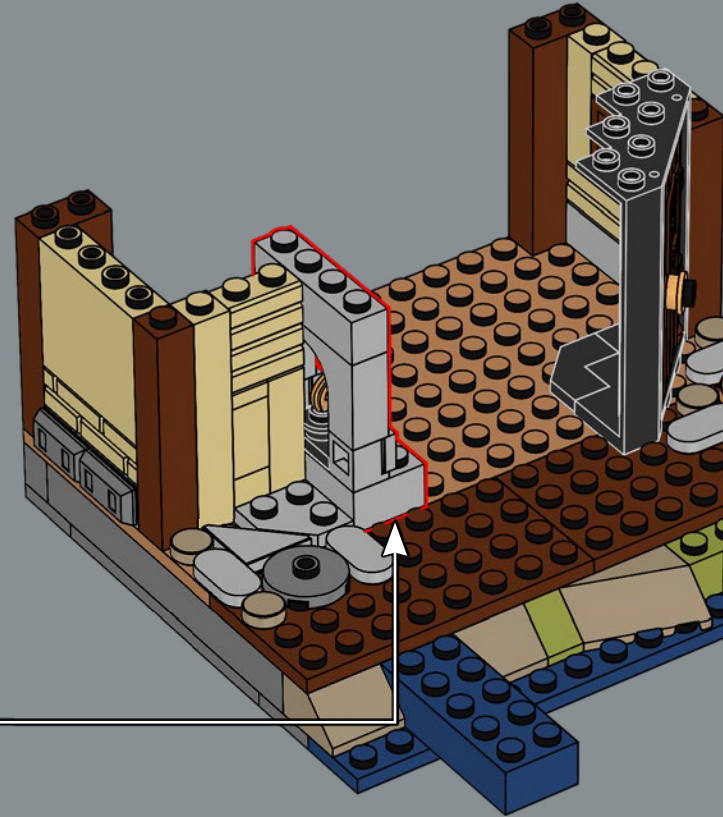
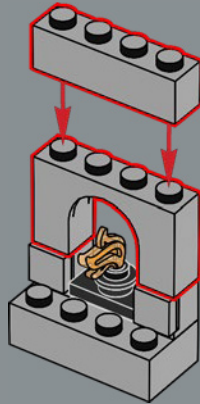



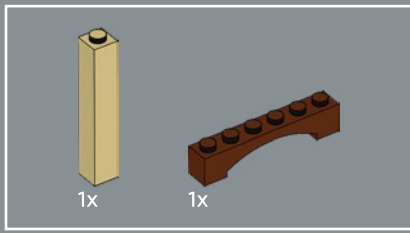

18

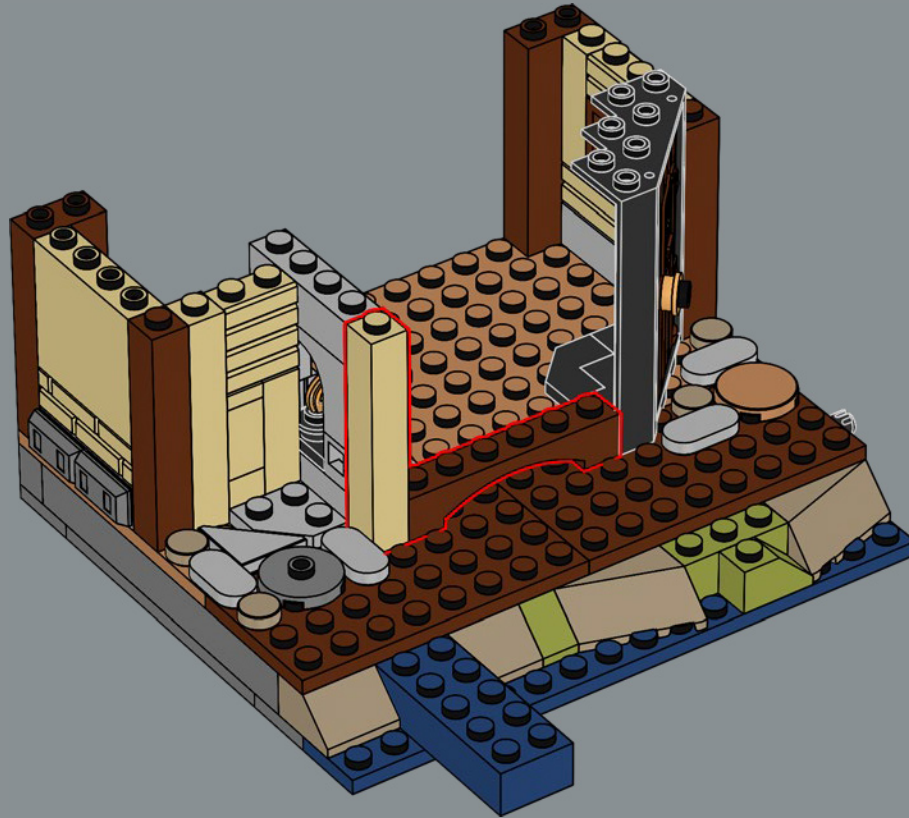

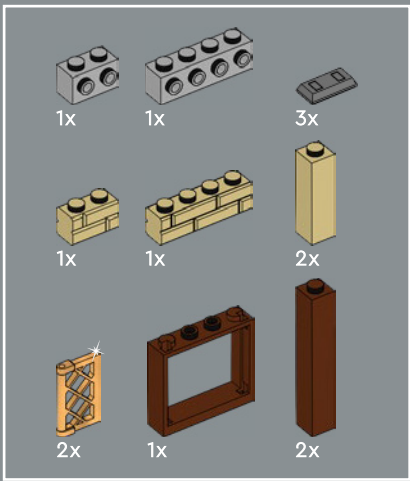

19

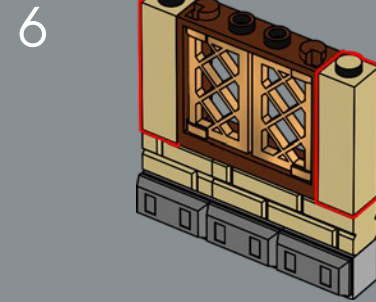
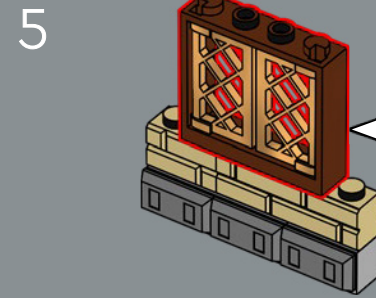
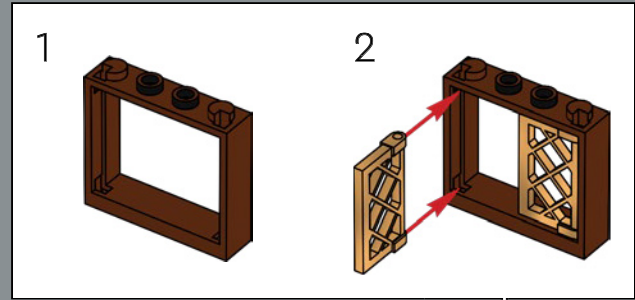
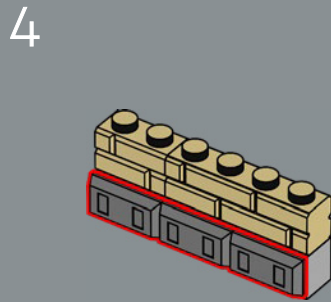
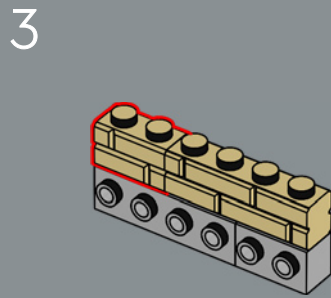
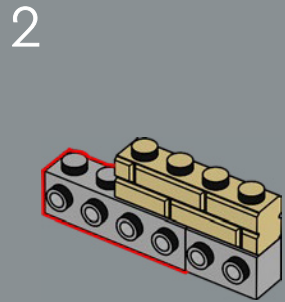
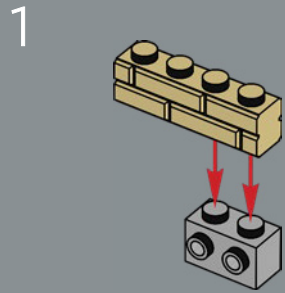

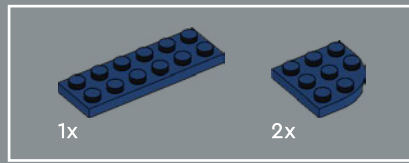
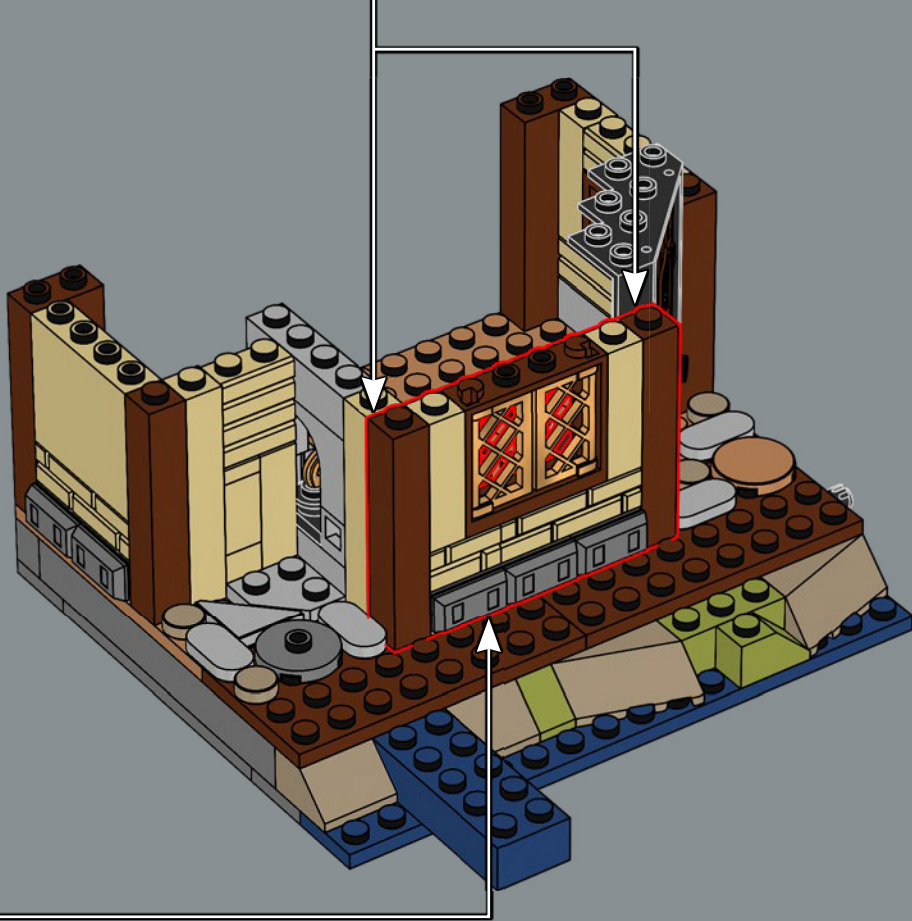
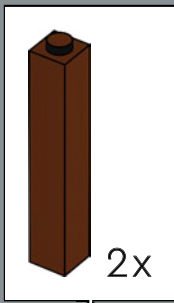

20

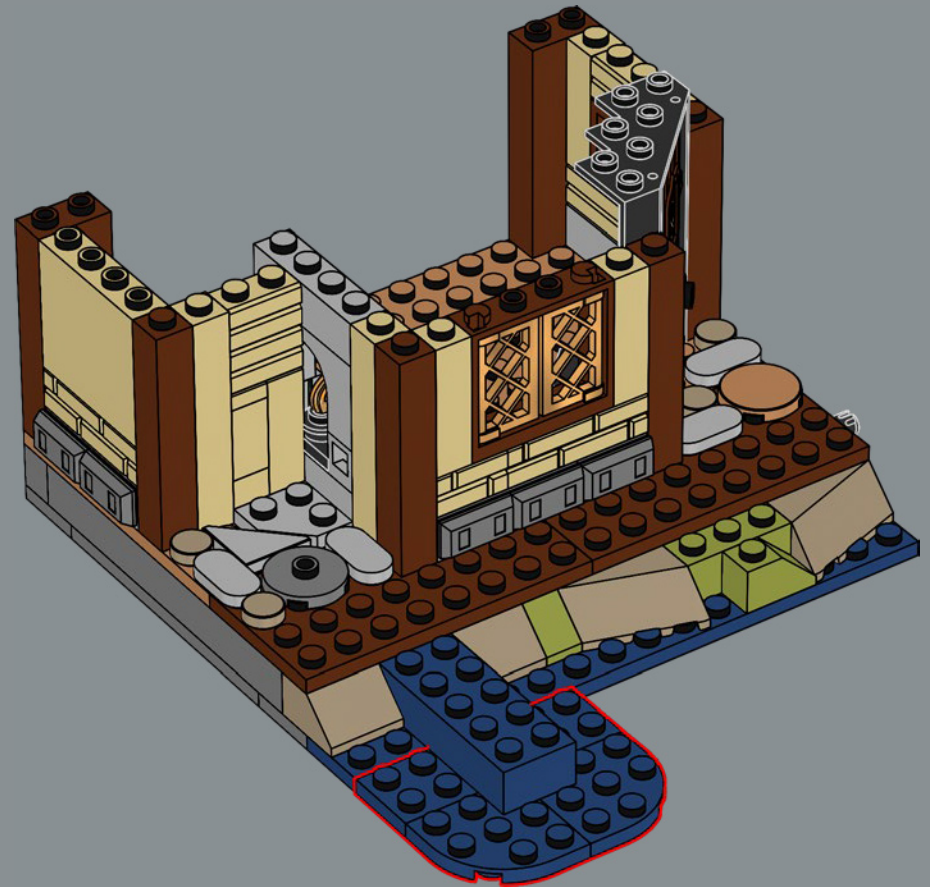



4x

21

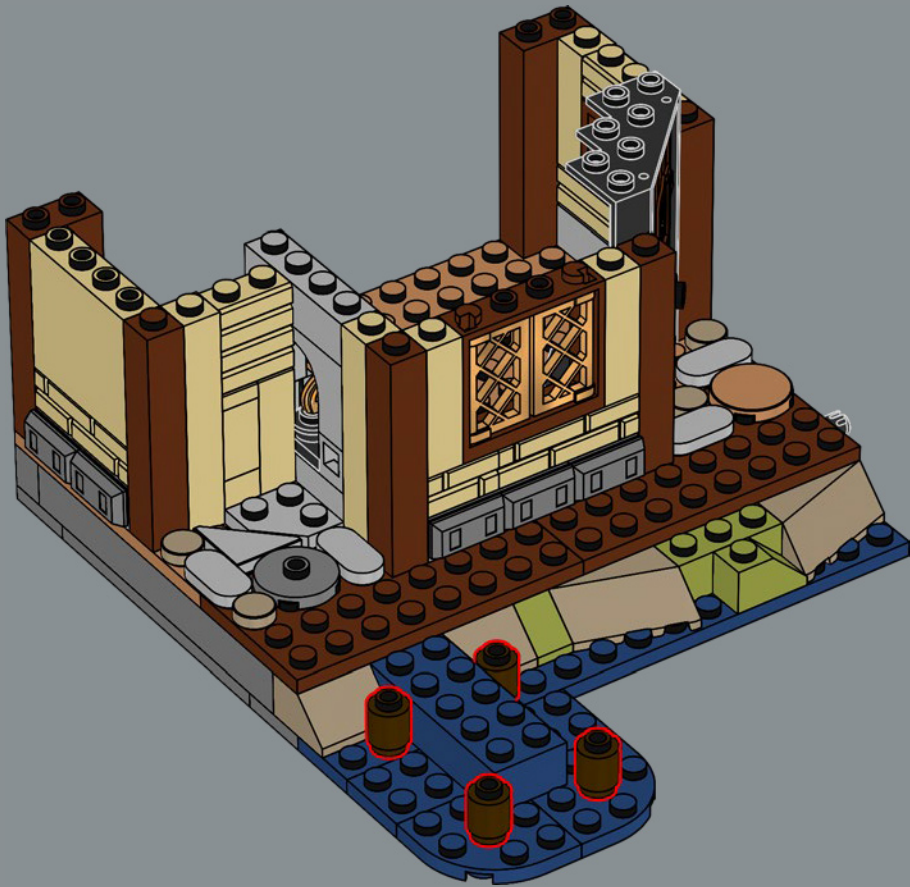

2x



1x

22

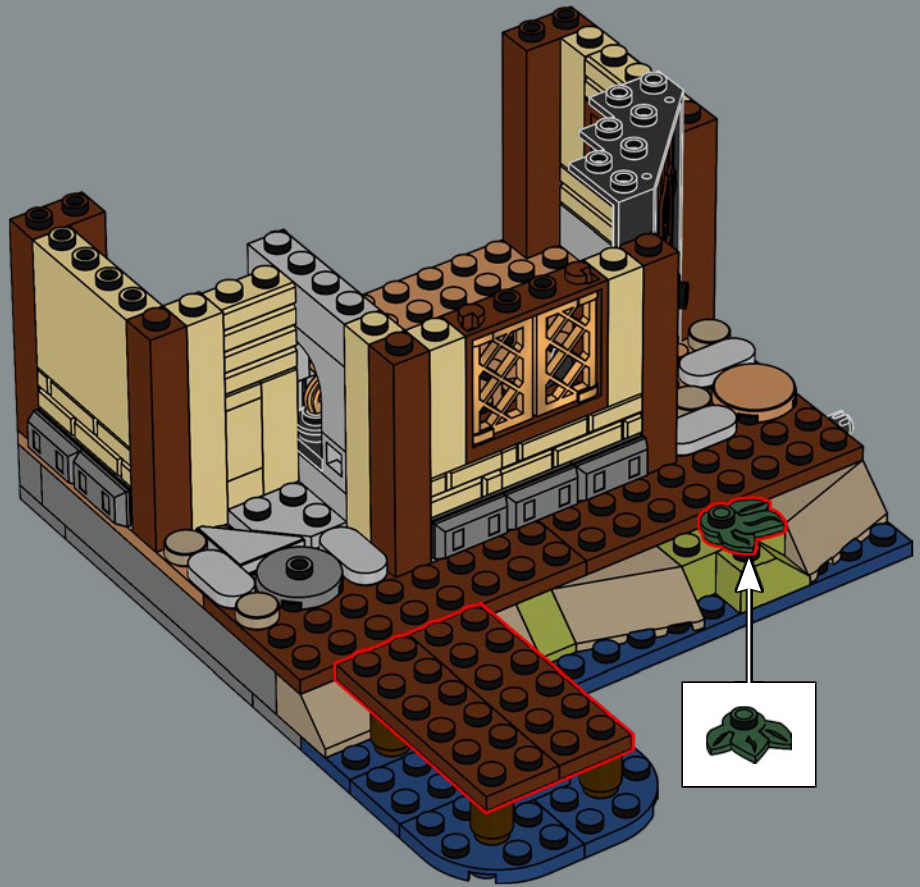

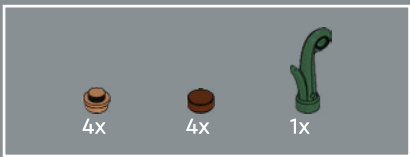

23

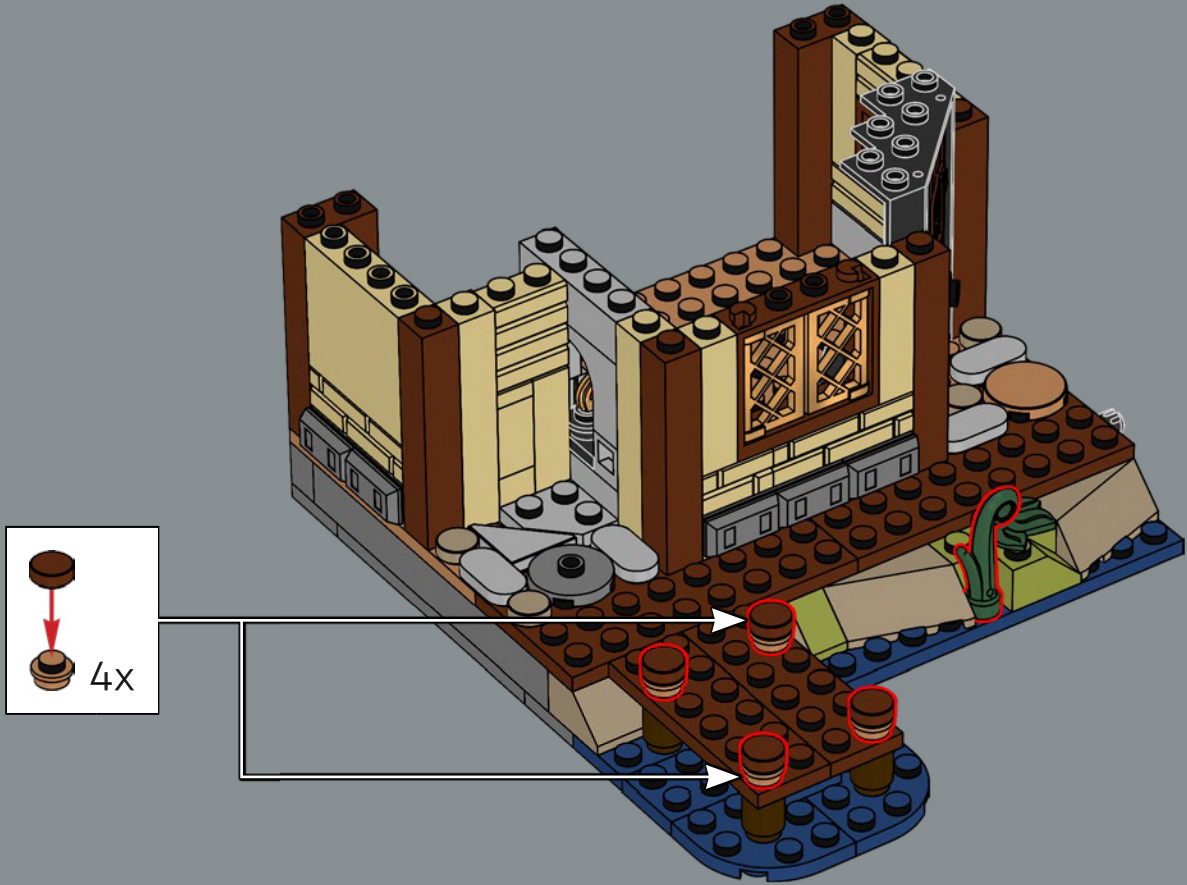

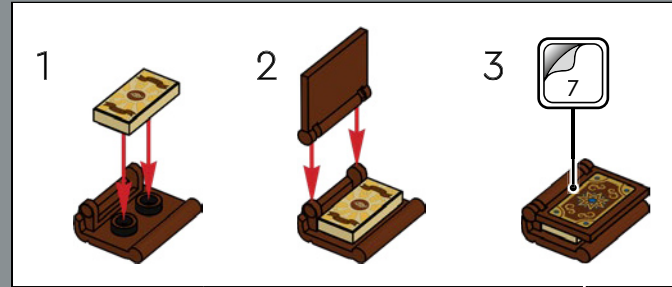
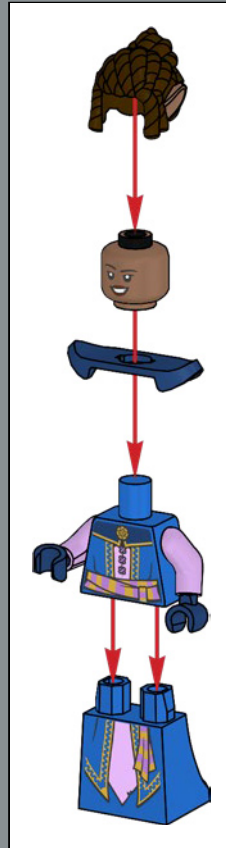

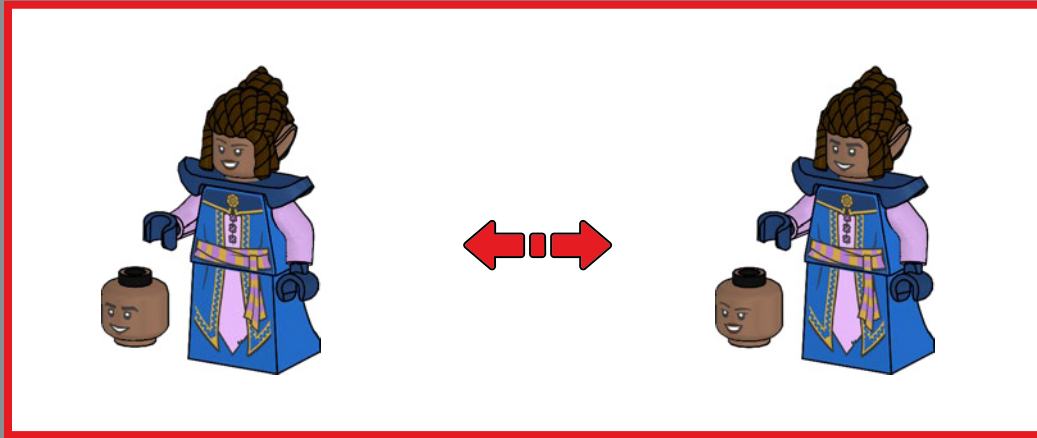

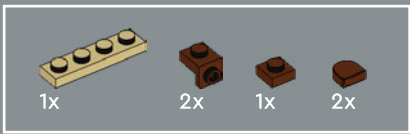

24

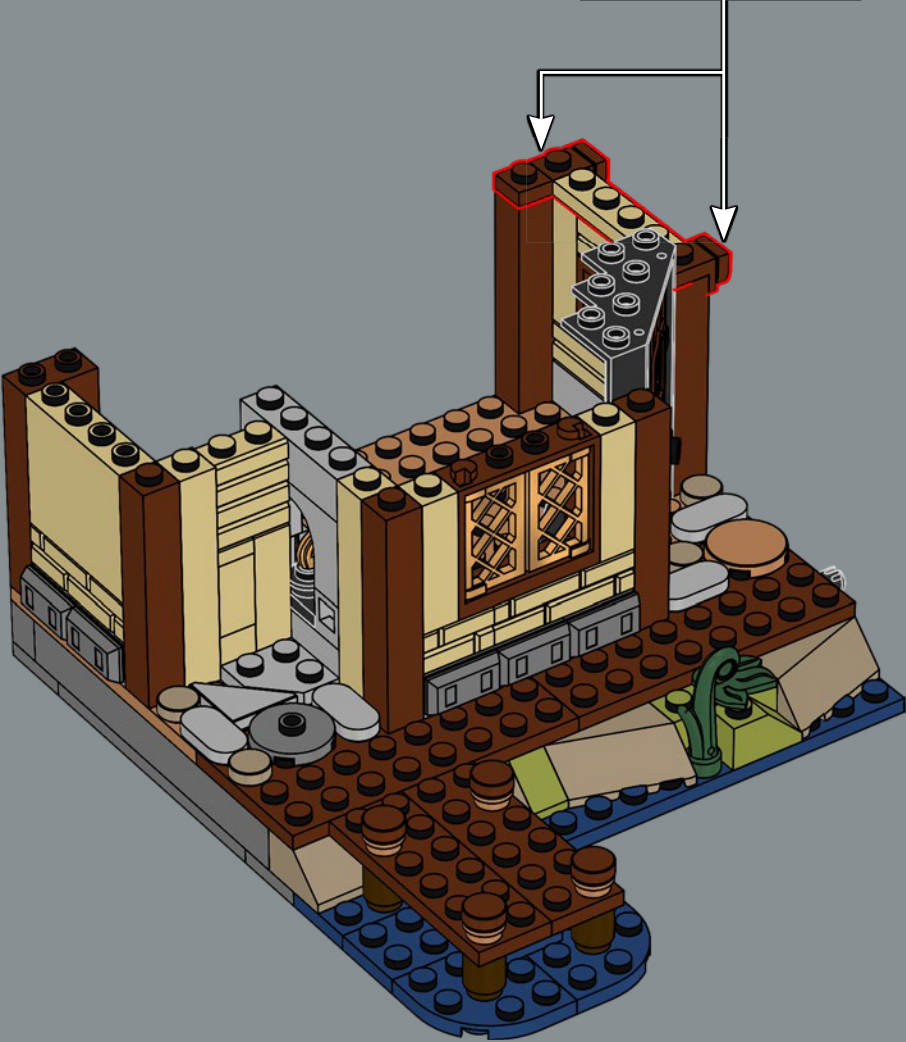
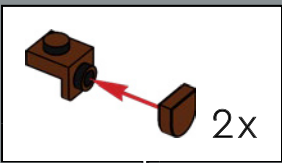



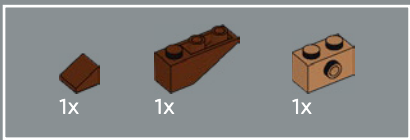

25

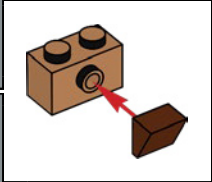

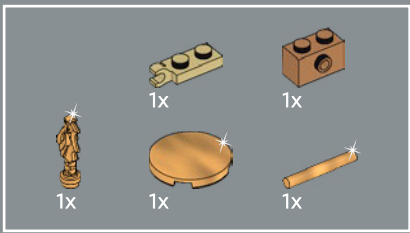

26

1

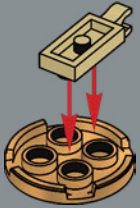

2



3

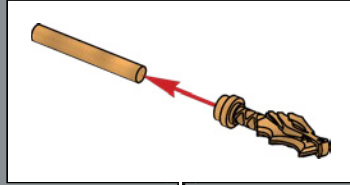

4

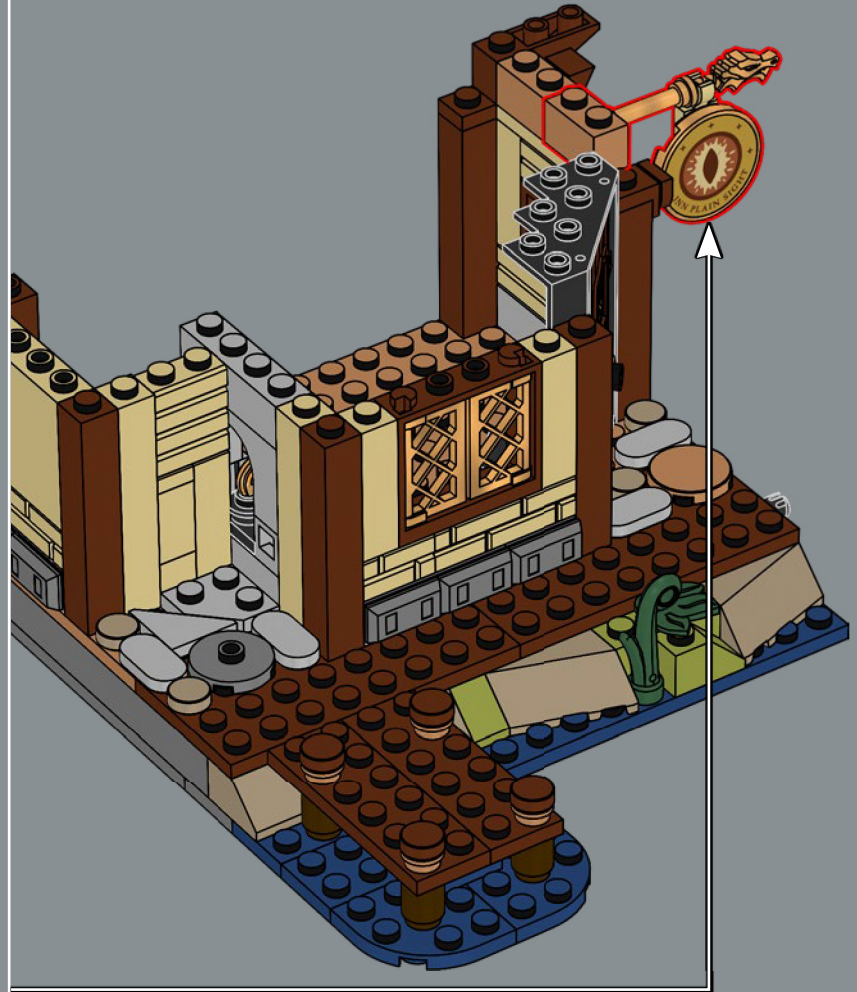
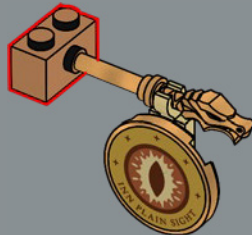

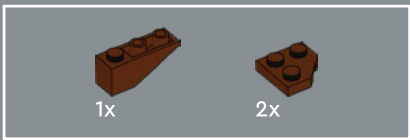

27



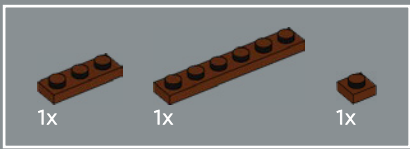

28

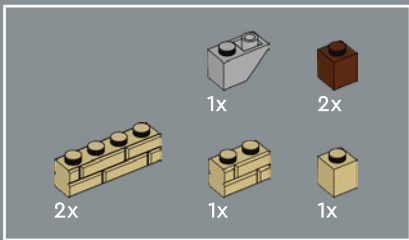
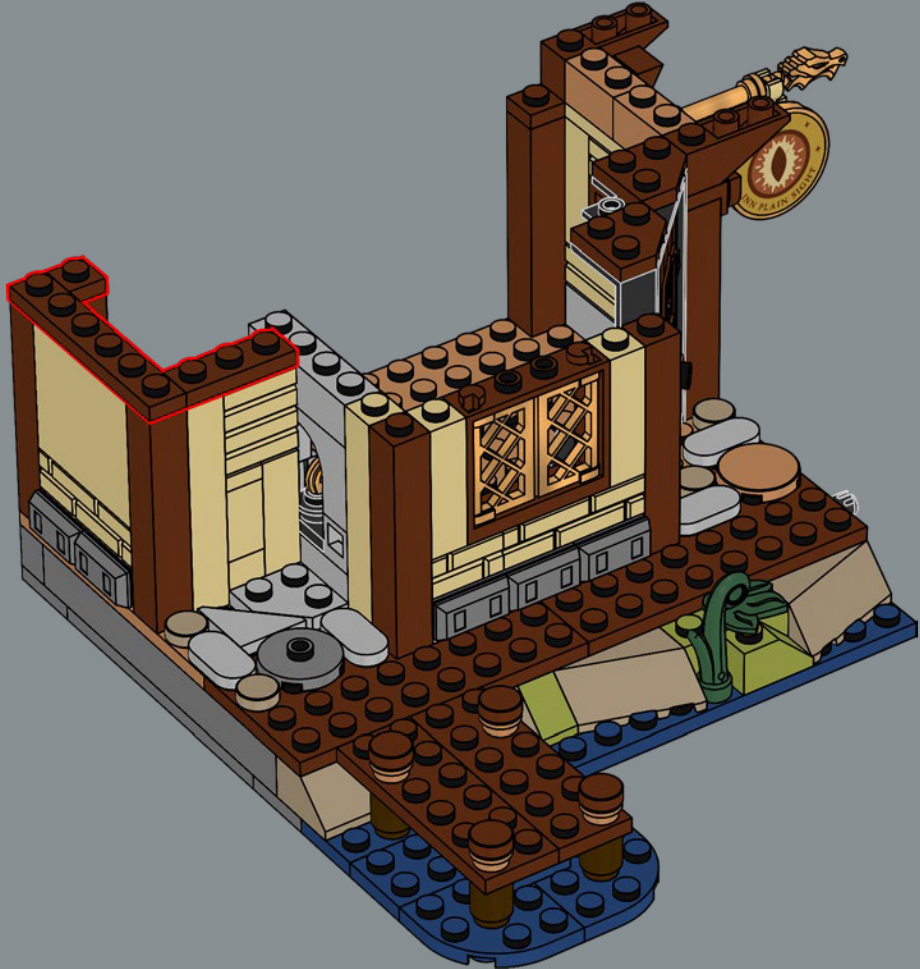

29



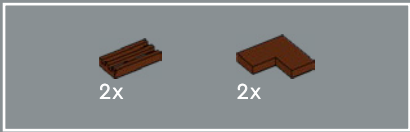

30



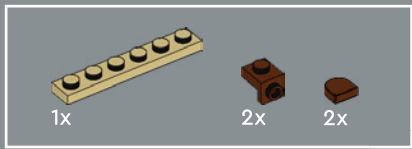

31

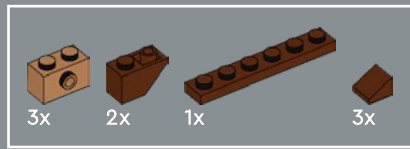
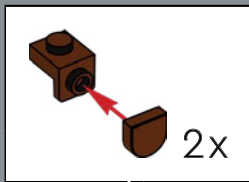

32

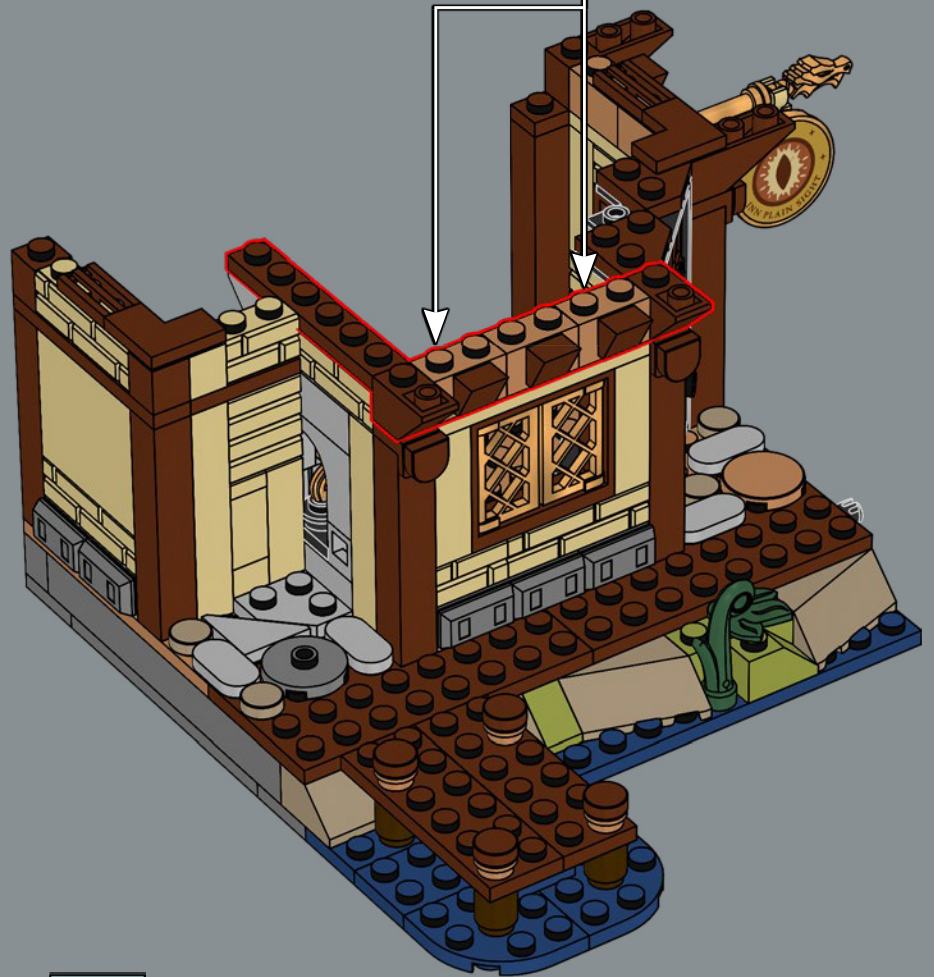
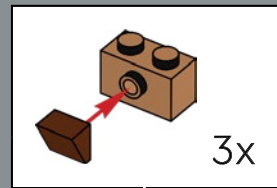

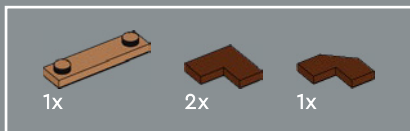

33



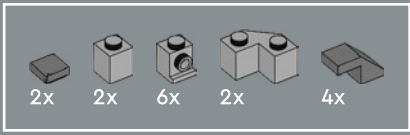

34

1

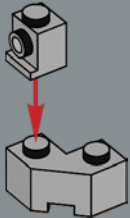

3

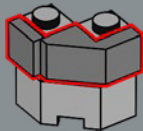

5

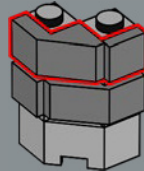

7

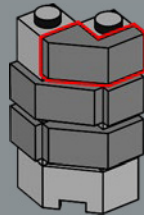

2

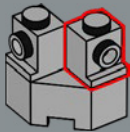

4

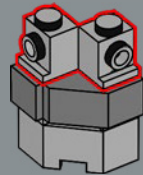

6

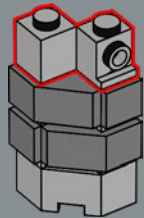

8

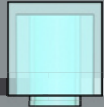
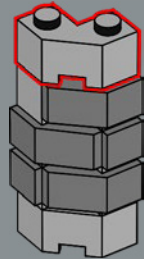



9

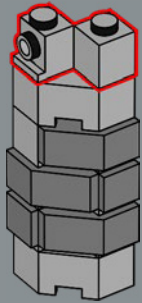

10

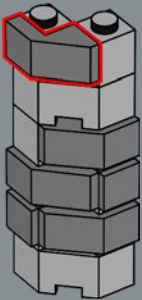

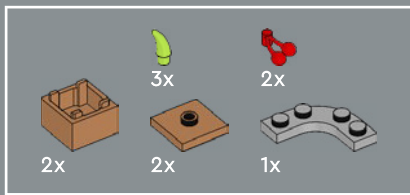

35

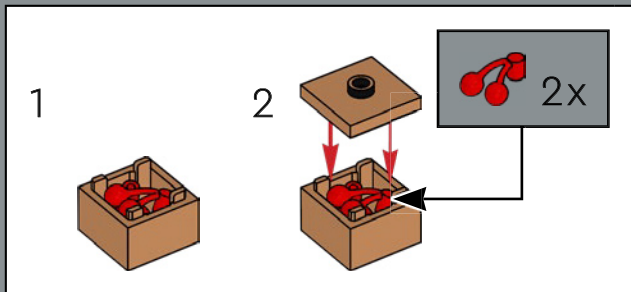
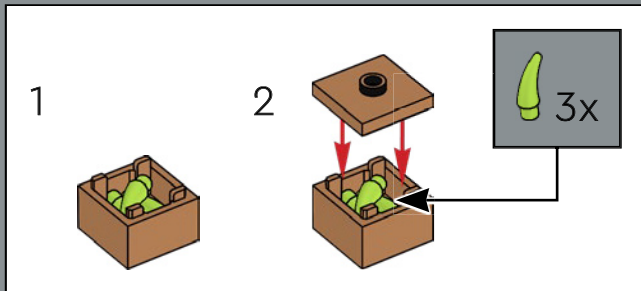

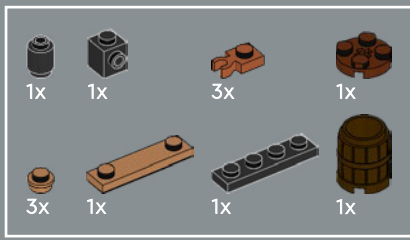

36

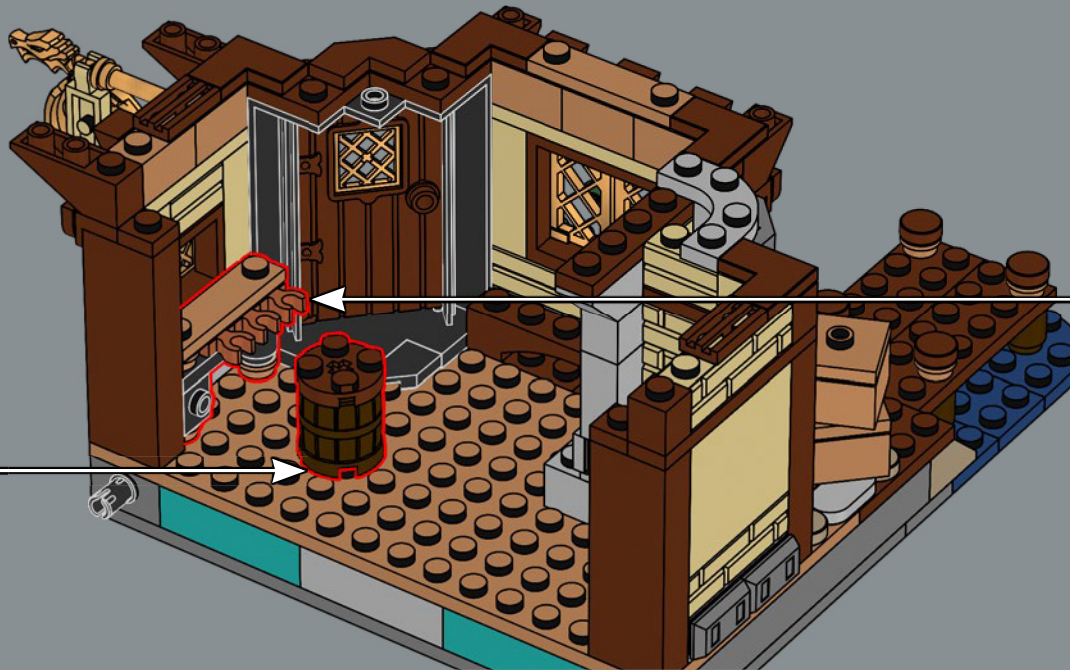
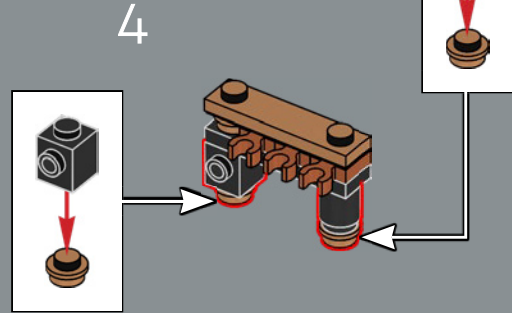
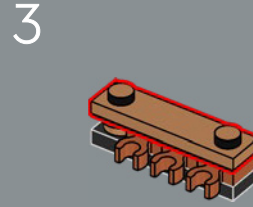
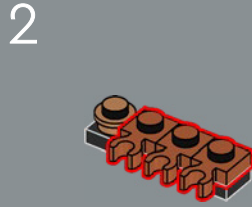
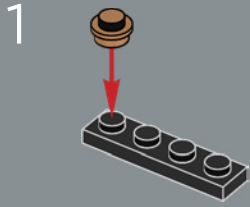

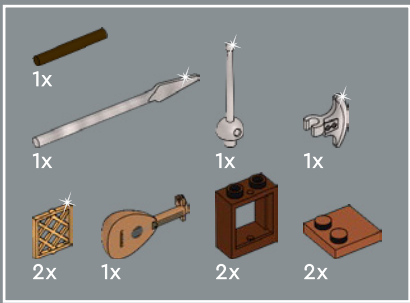

37

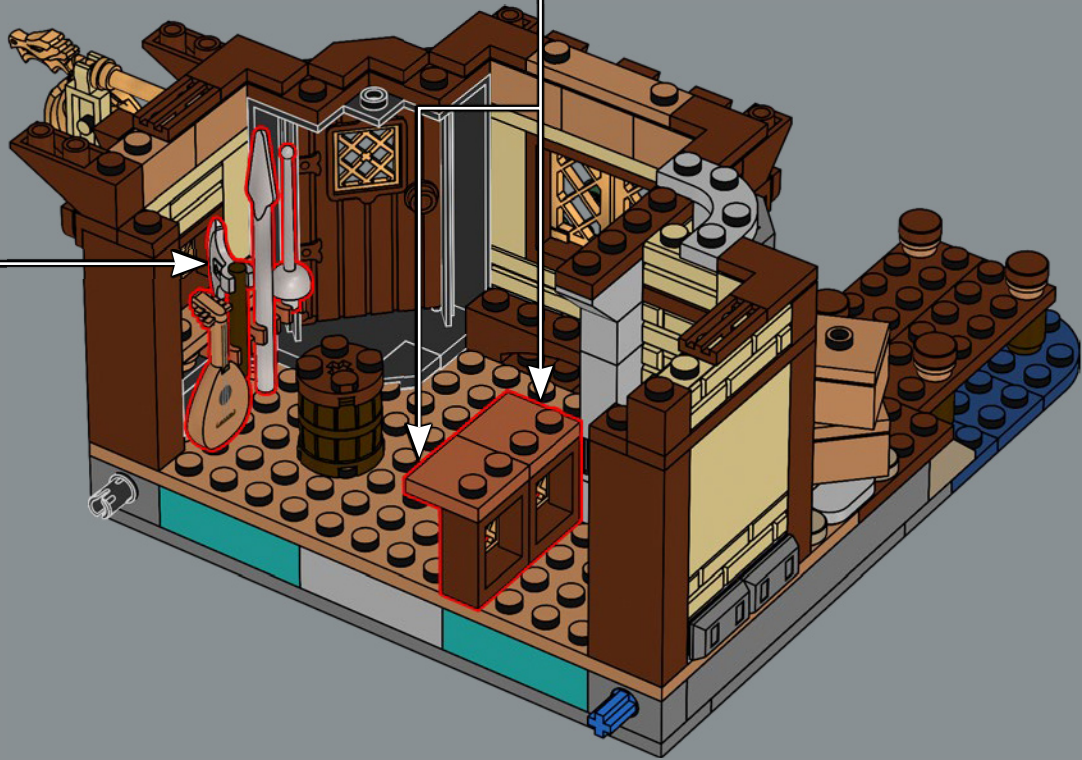
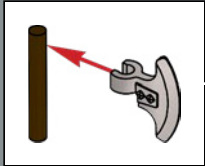
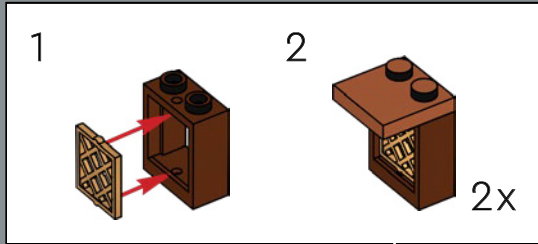

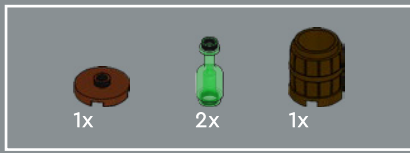

38

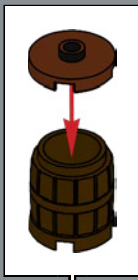

39

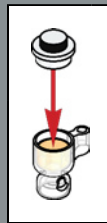
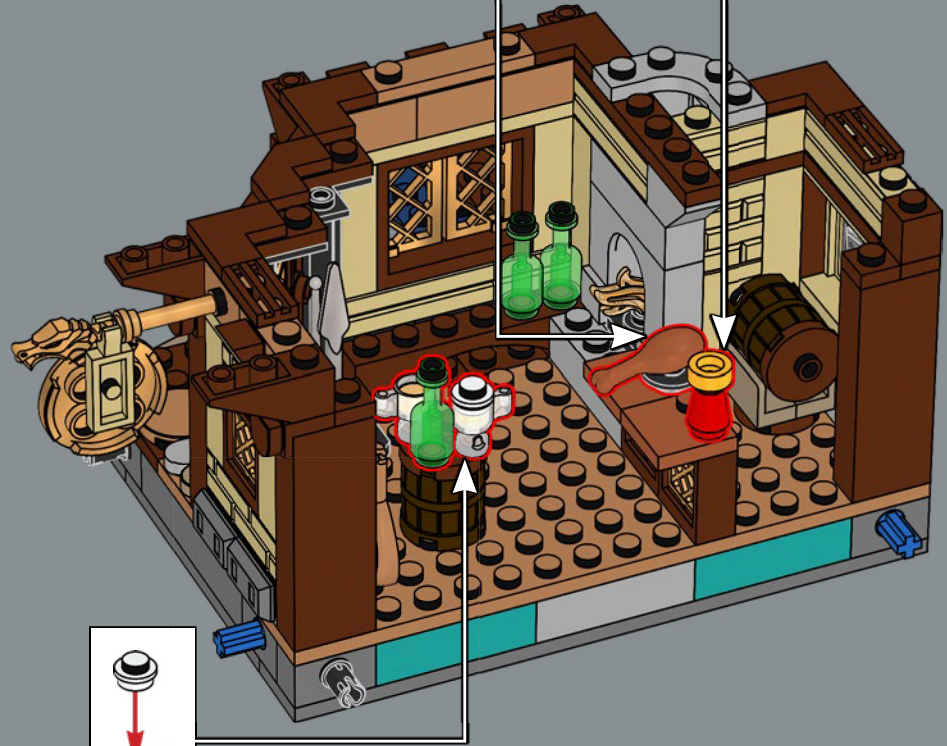
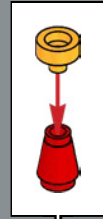
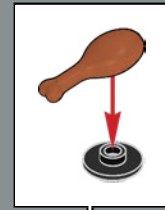

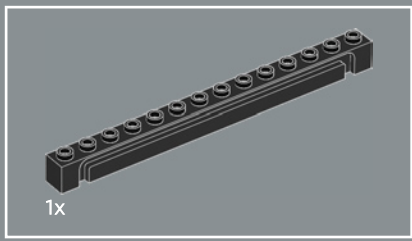

40

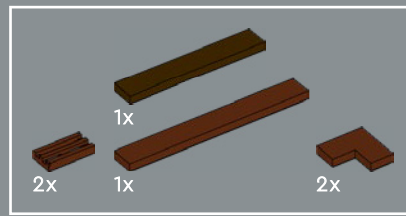
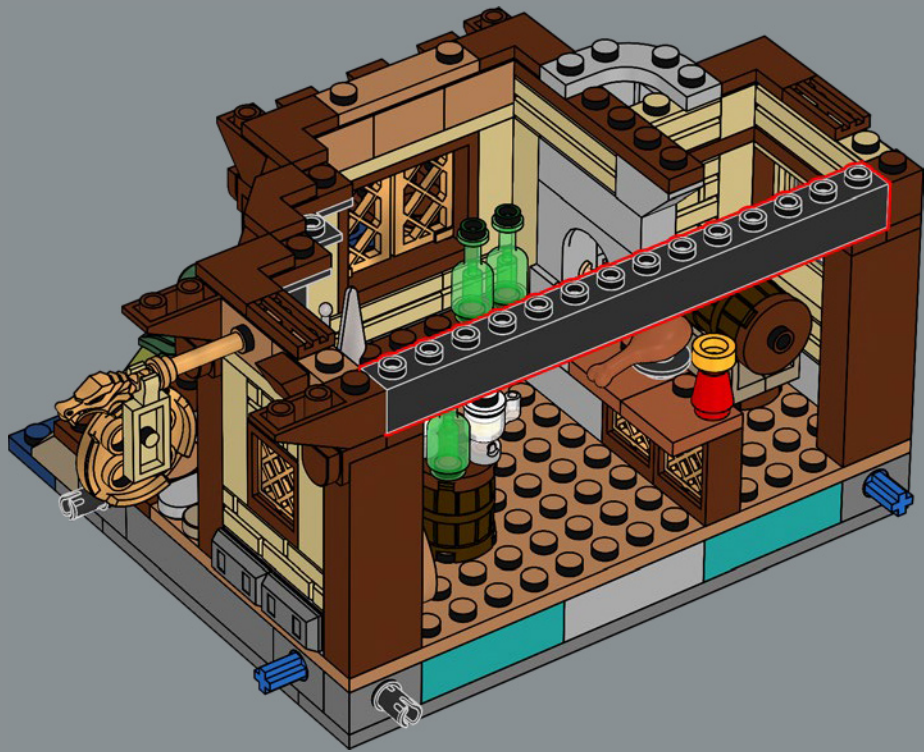

41

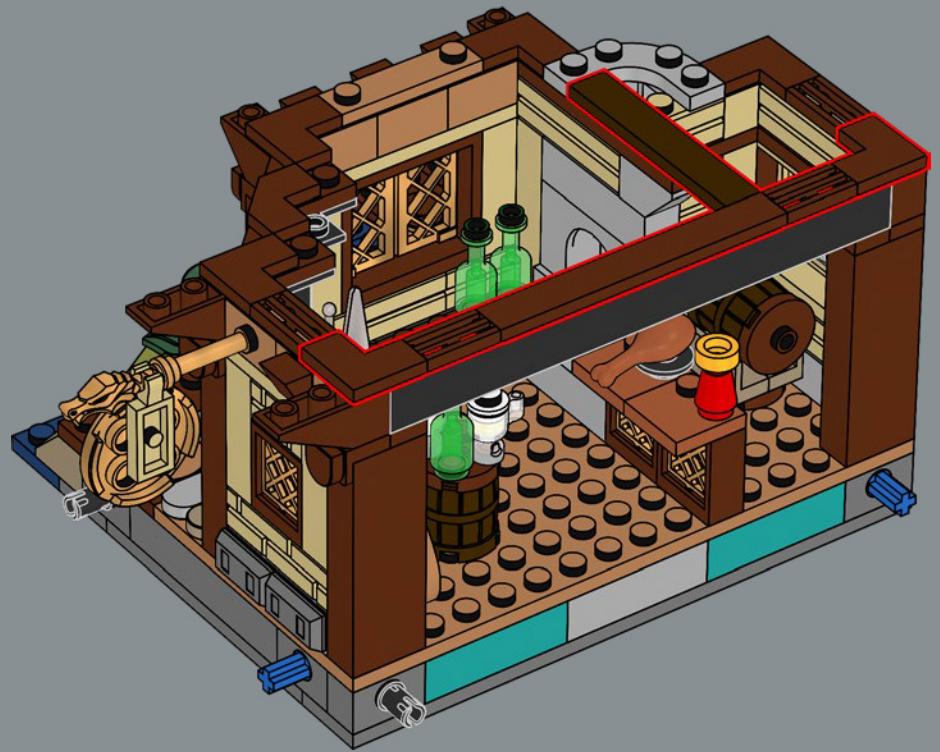

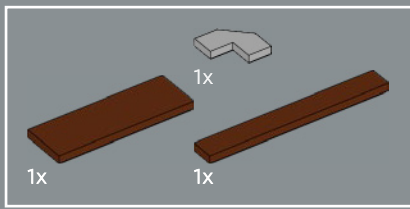

42

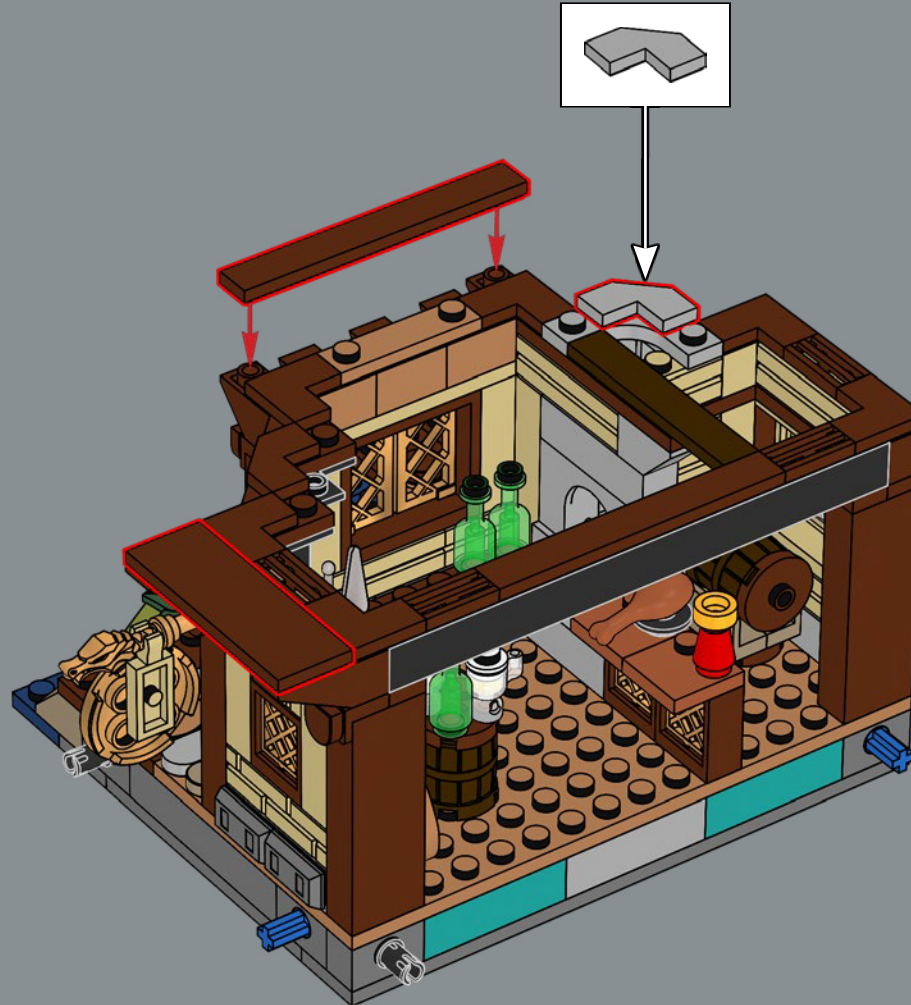

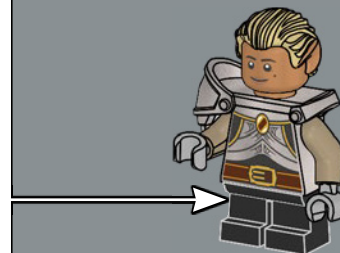
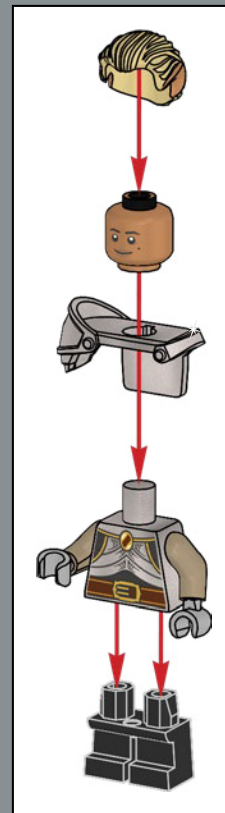



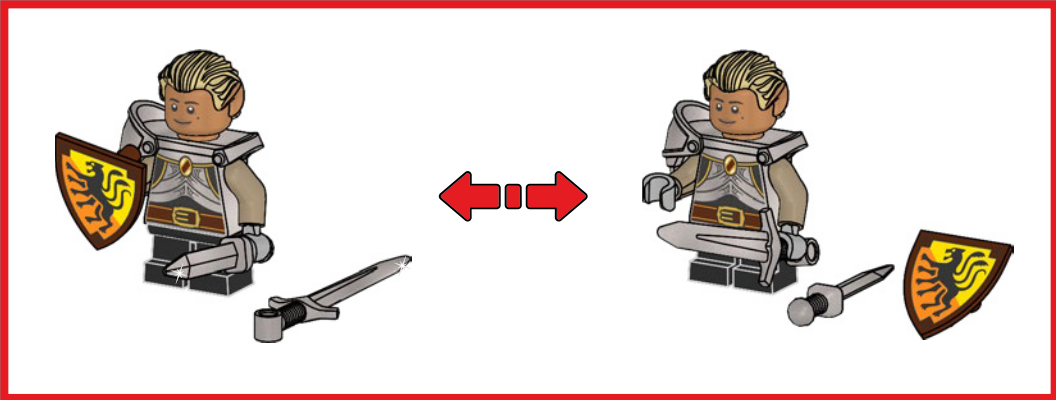
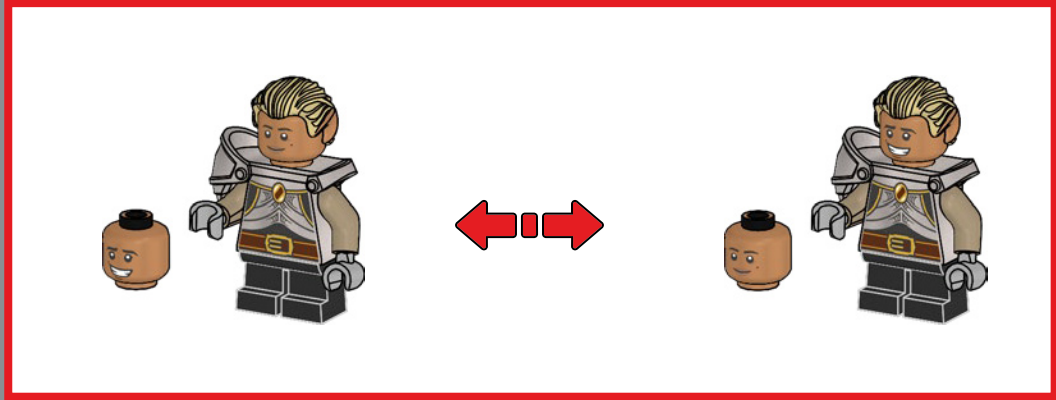

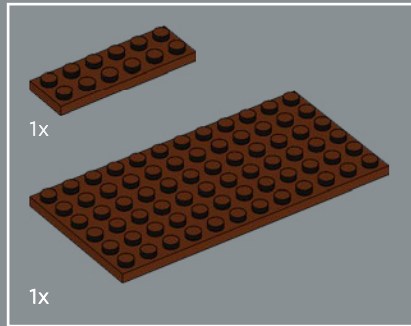
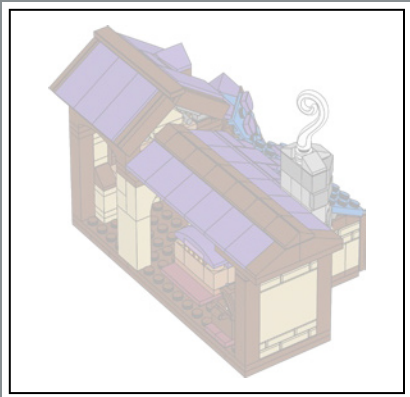

43

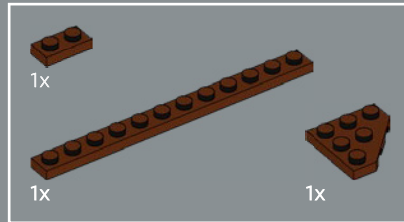
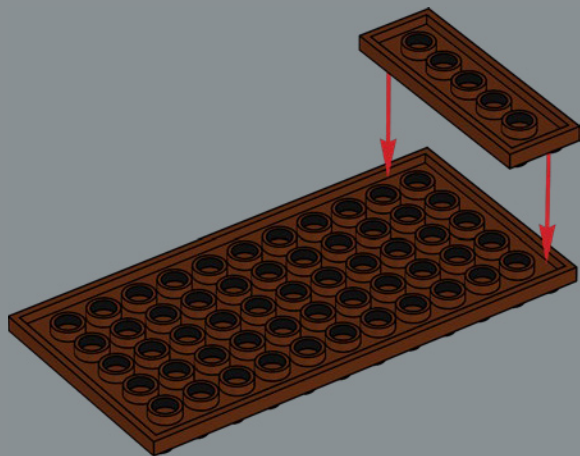

44

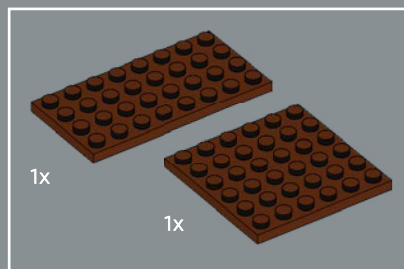
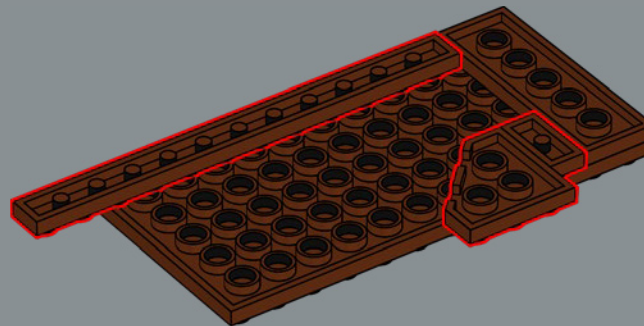

45

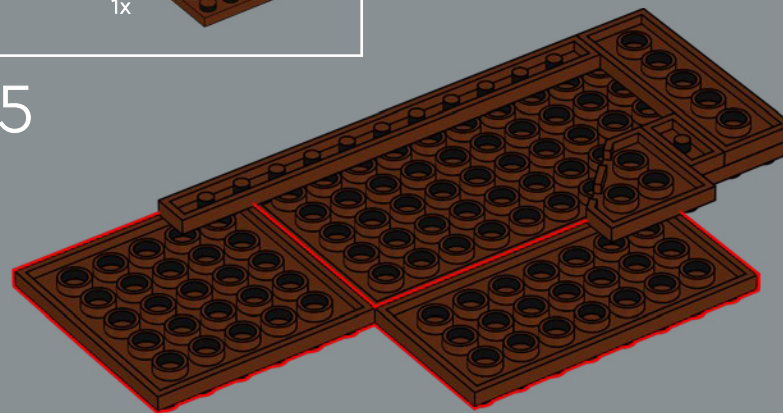

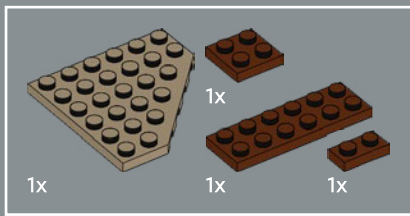

46

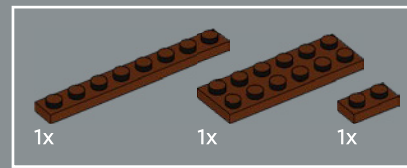
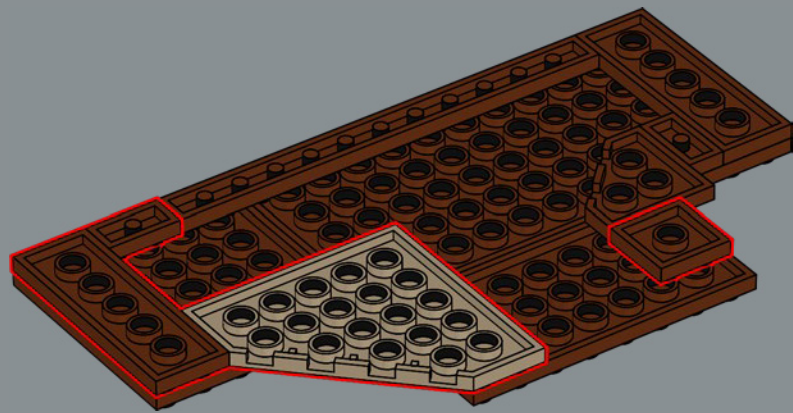

47

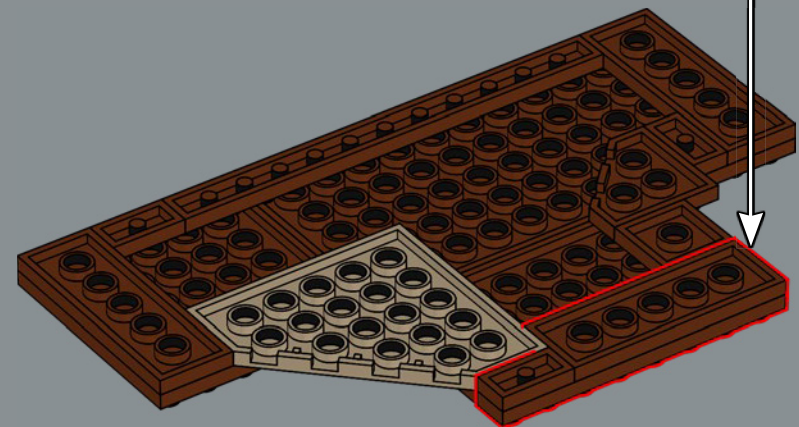
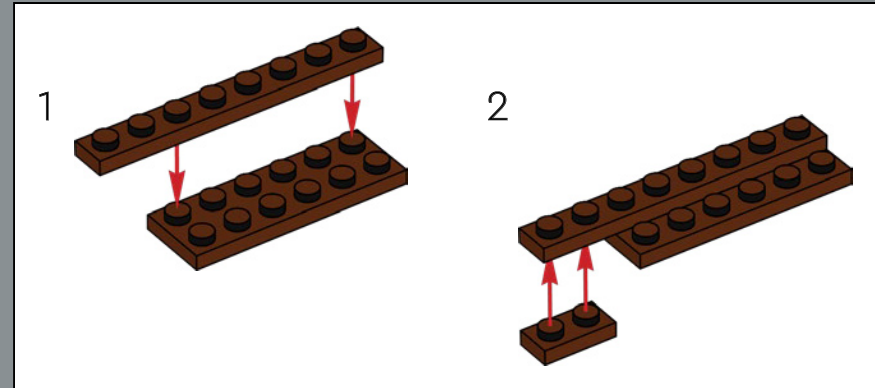

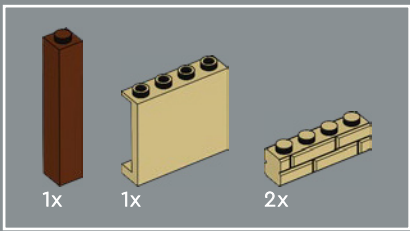

48

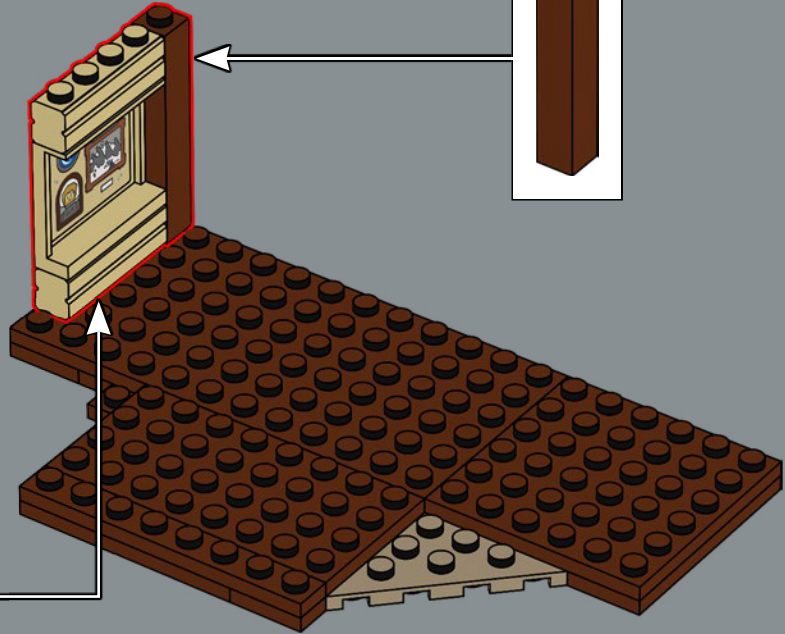
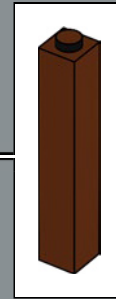
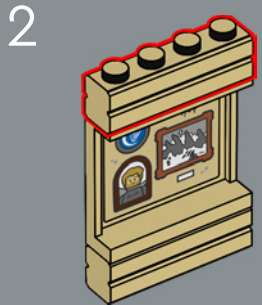
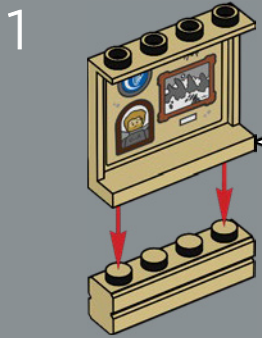
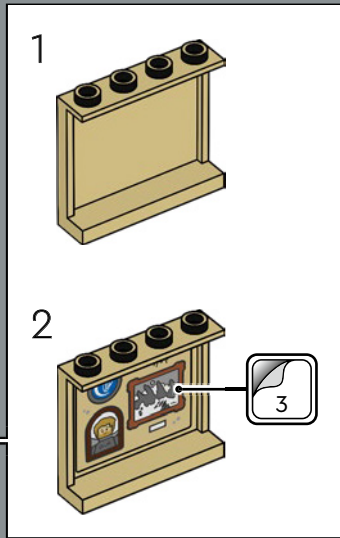

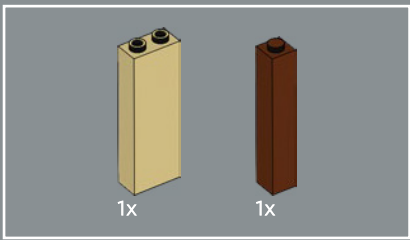

49

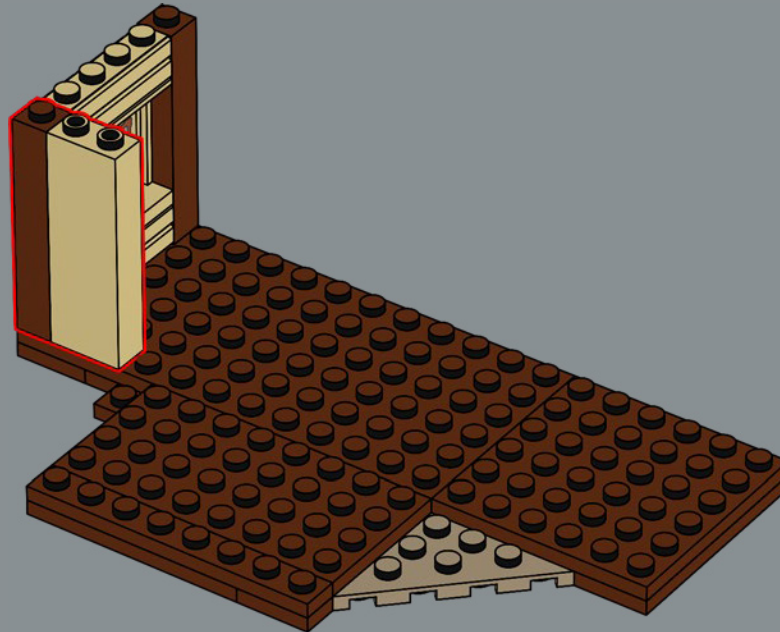

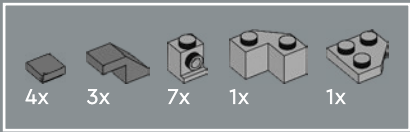

50

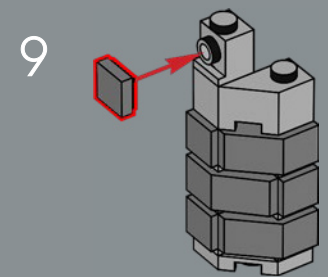
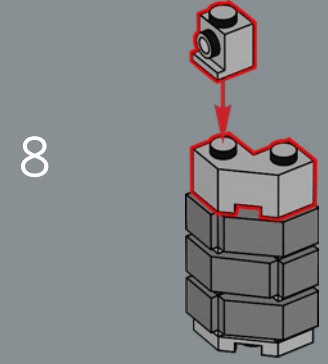
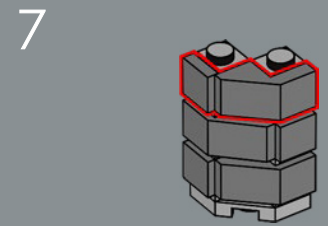
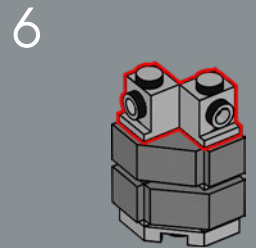
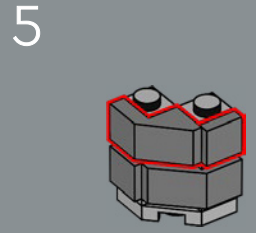
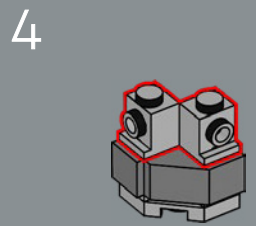
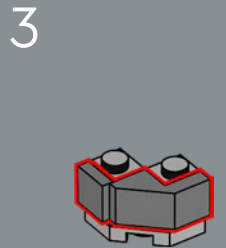
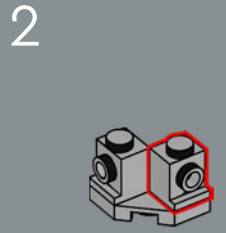
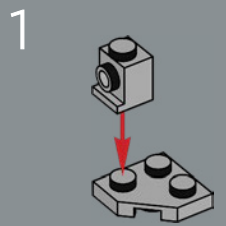

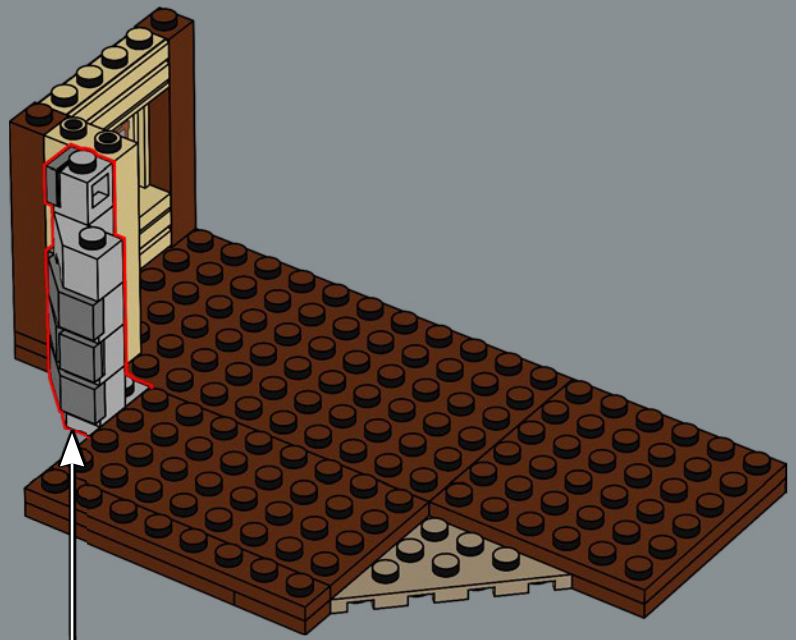

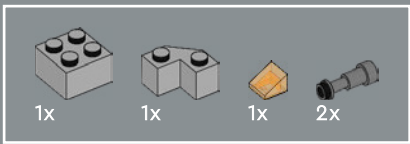

51

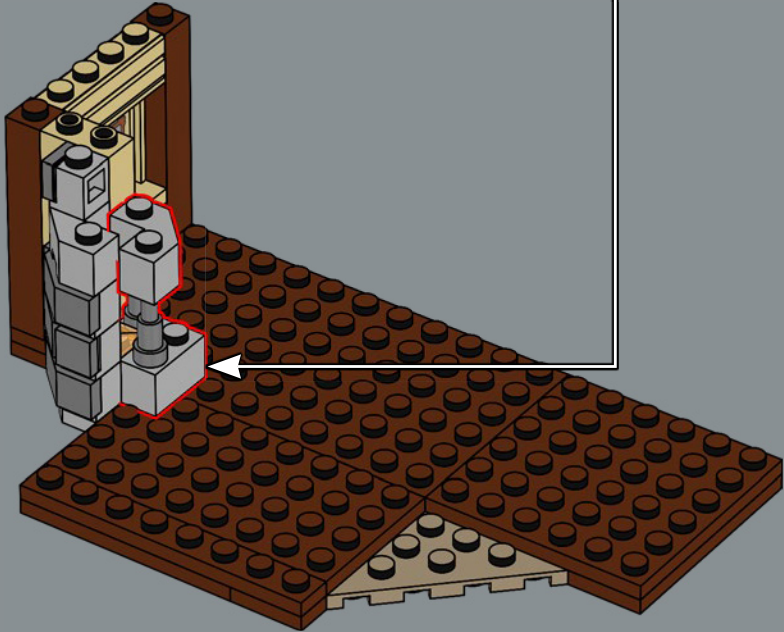
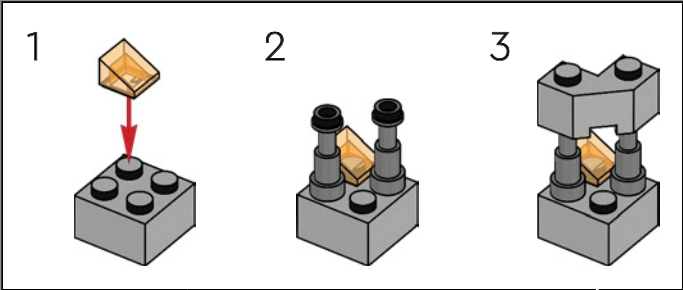



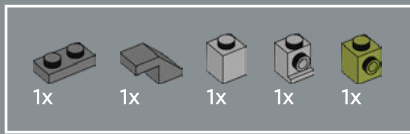

52

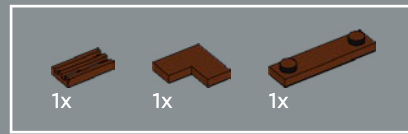
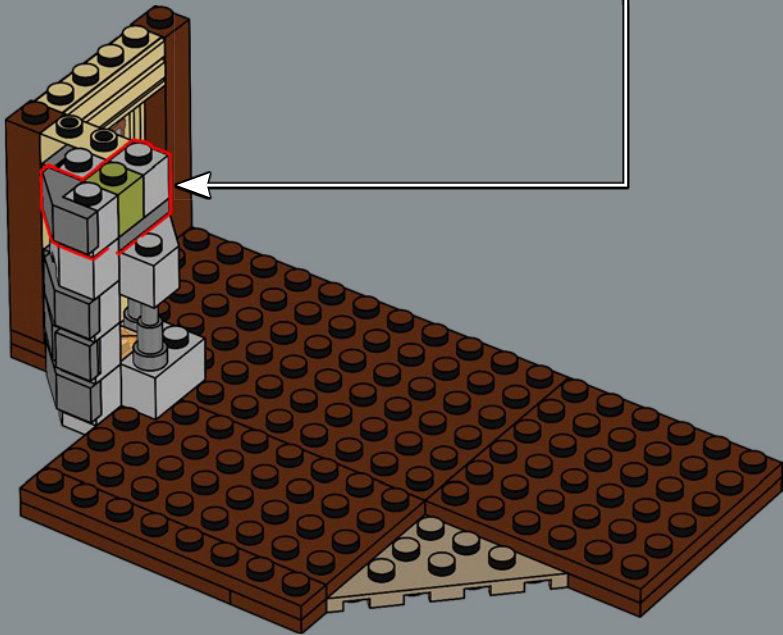
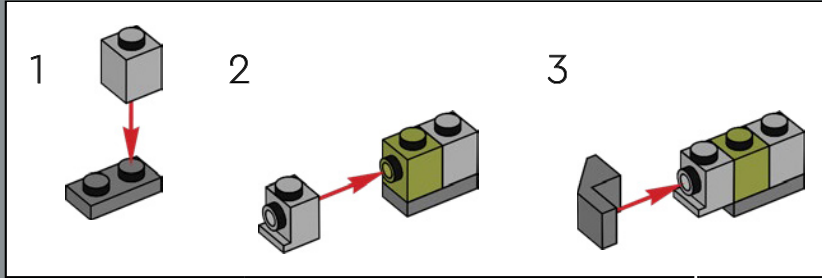

53

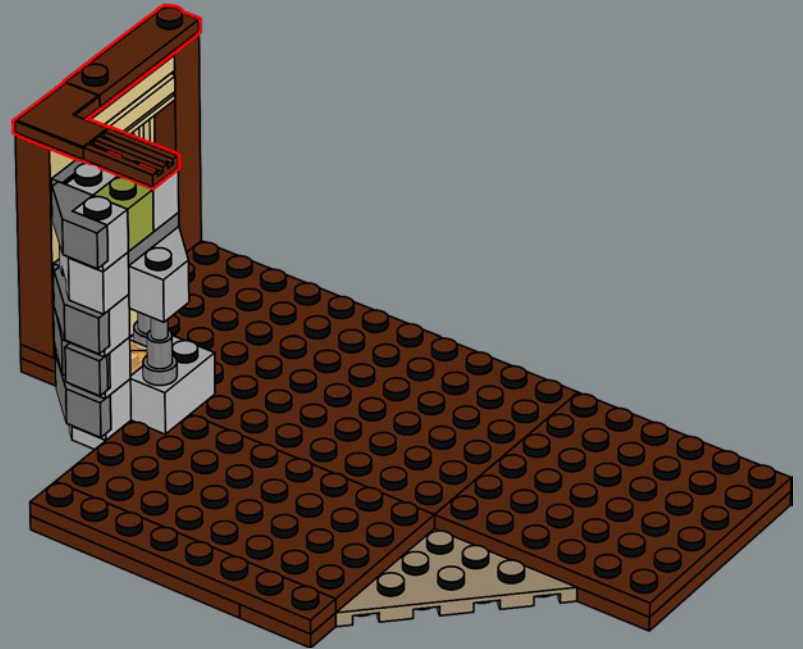

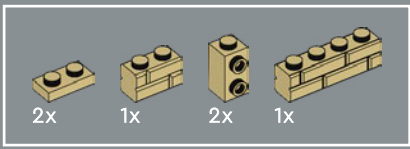

54

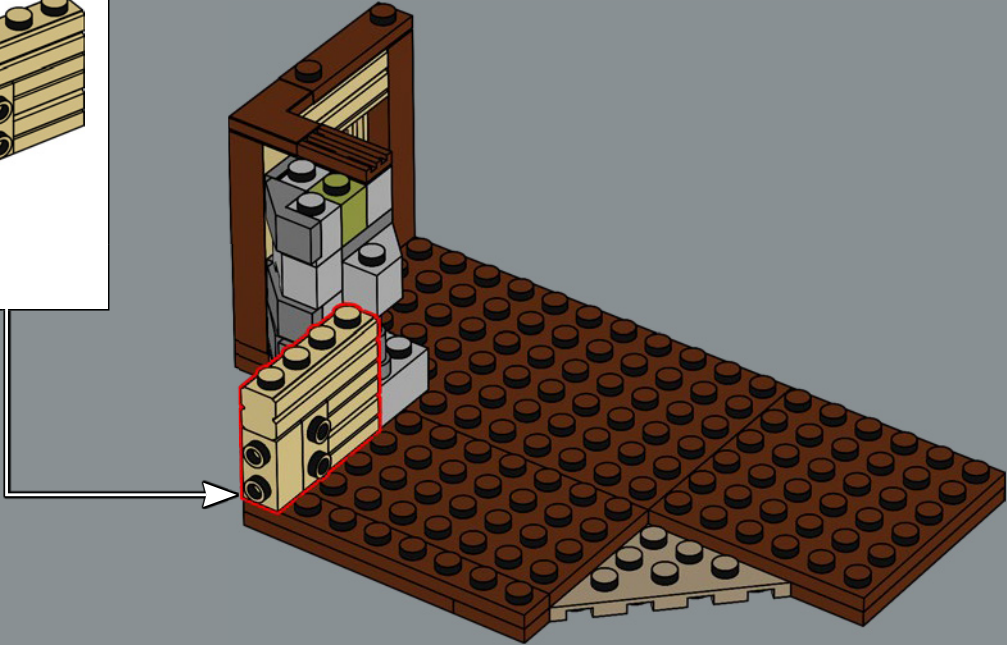
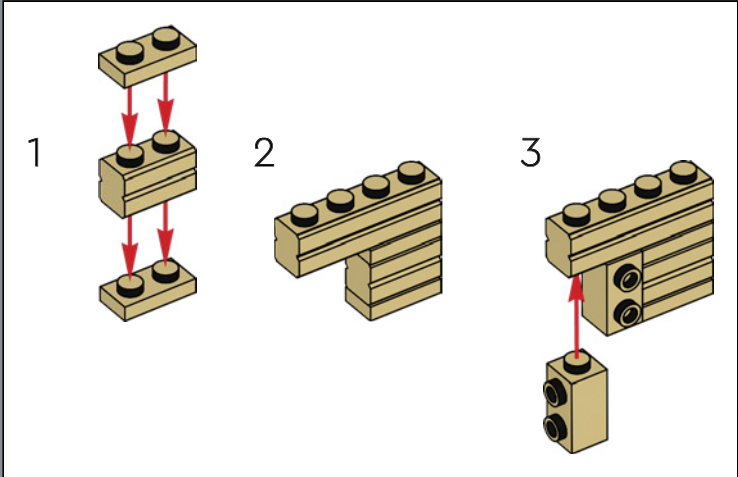

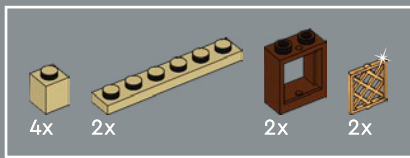

55

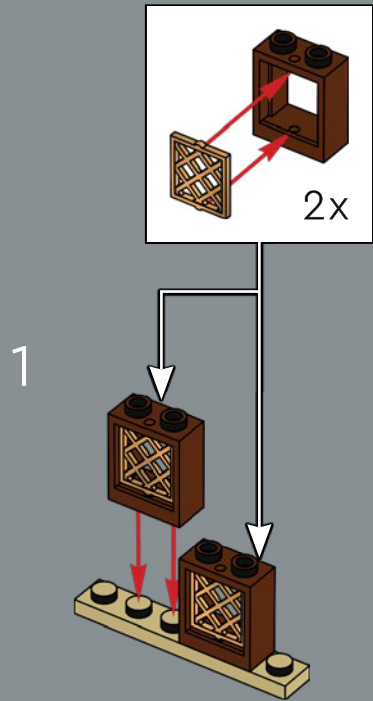

2

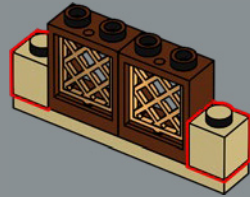

3

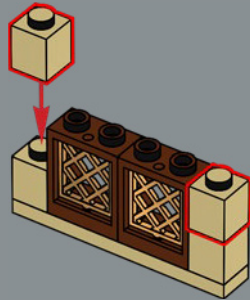

4

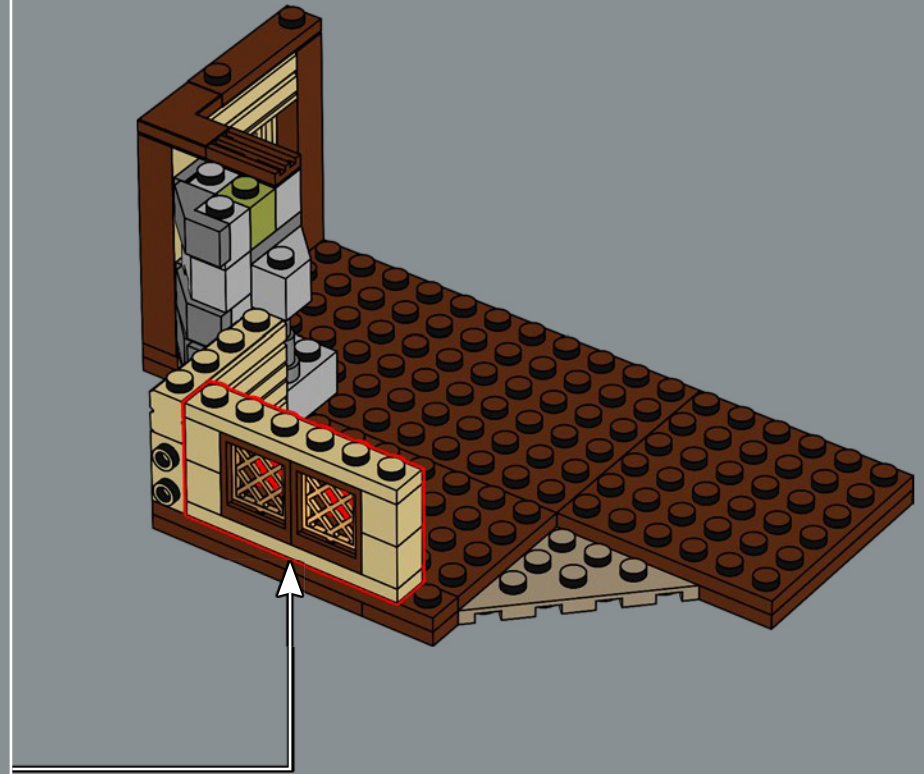
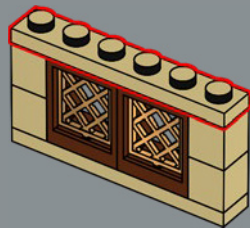



56

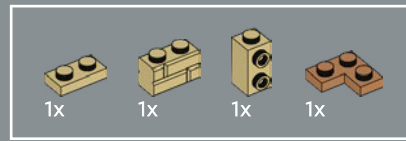
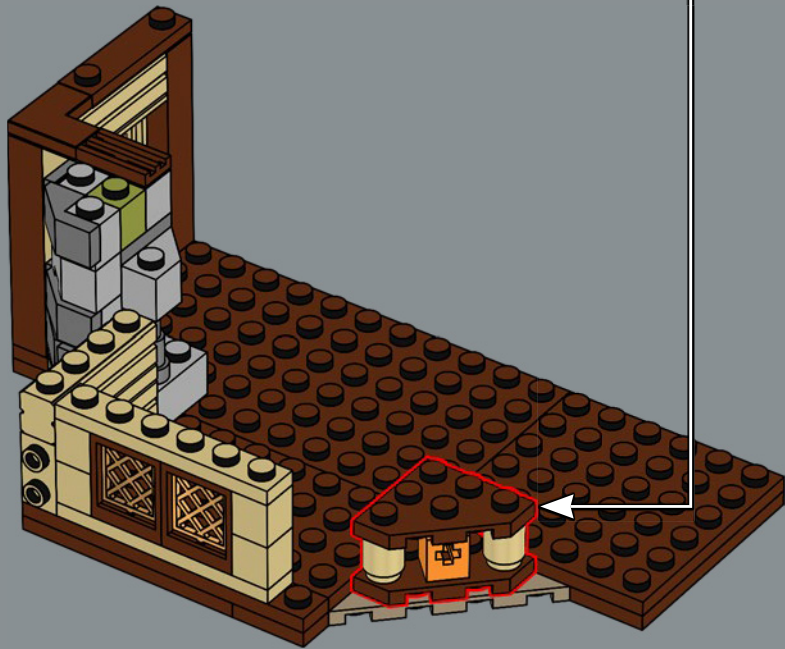
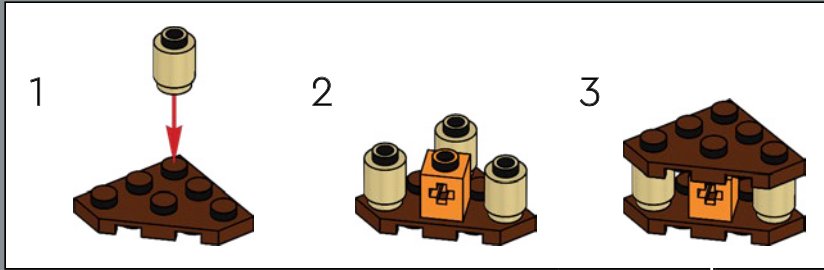

57

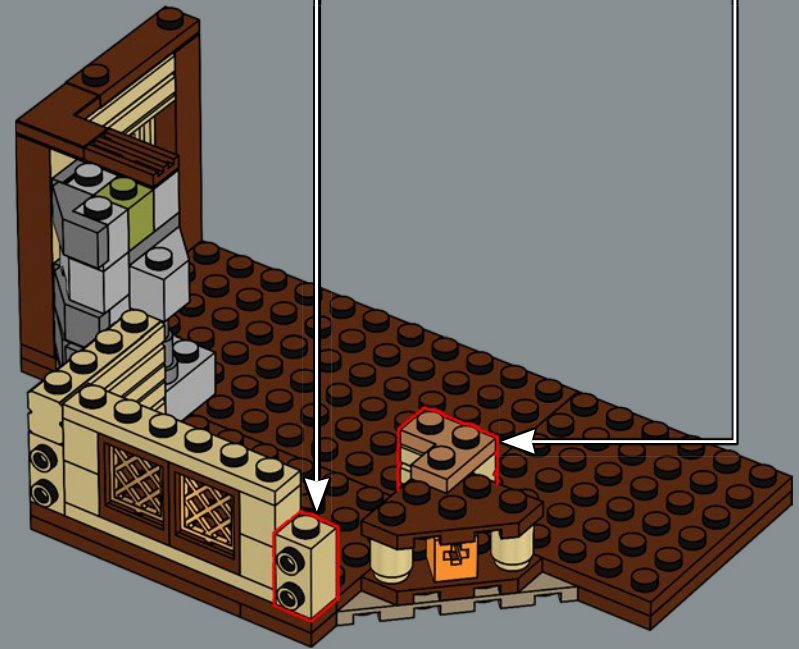
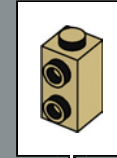
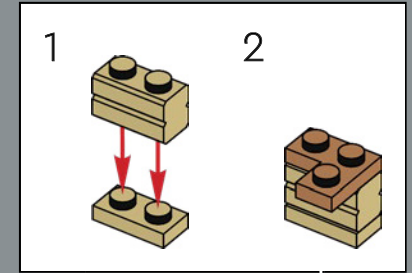

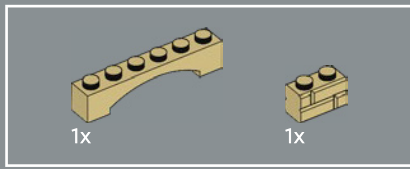

58

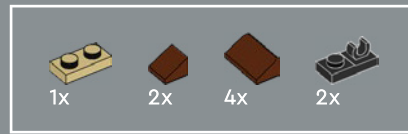
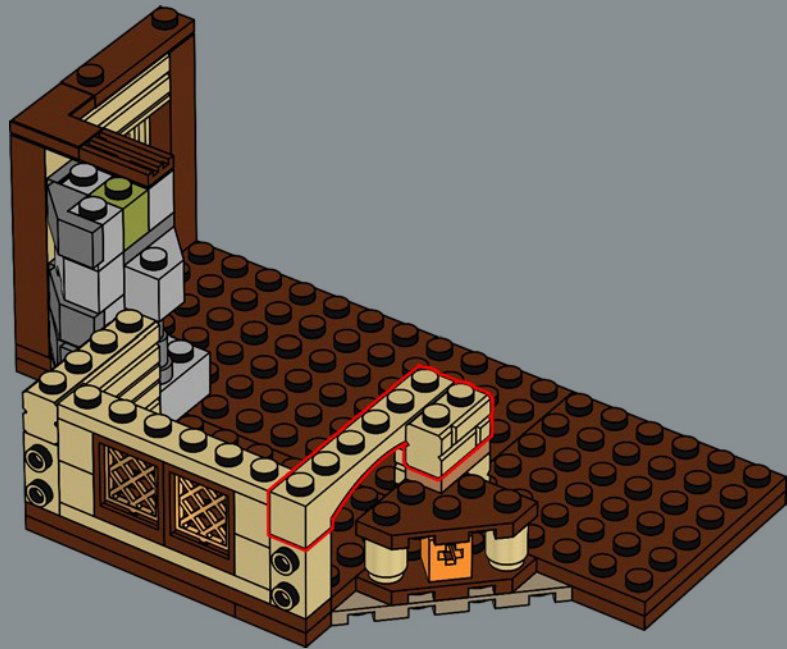

59

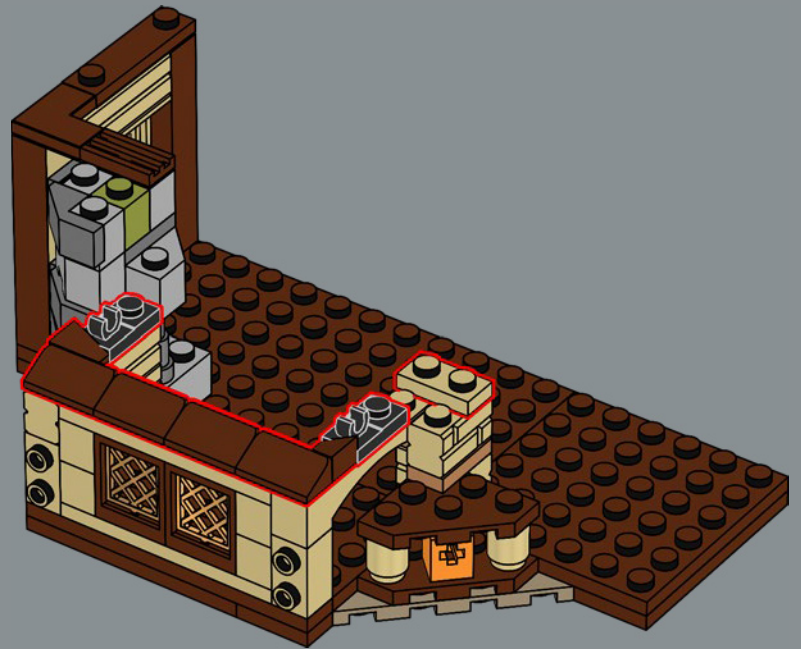

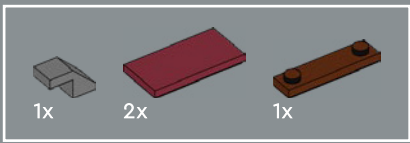

60

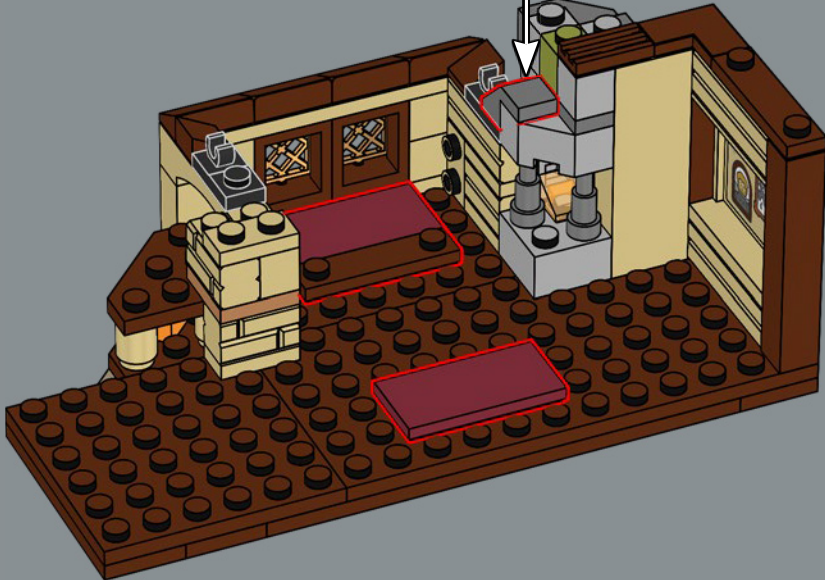
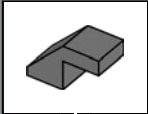

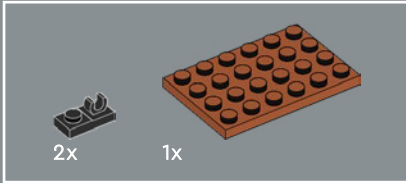
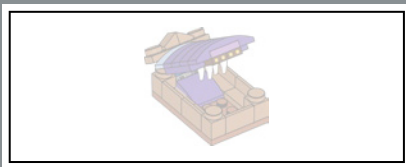

61

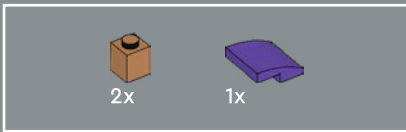
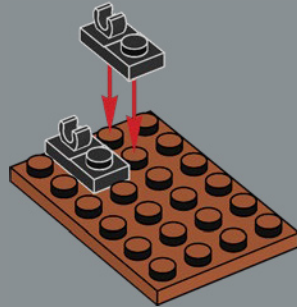

62

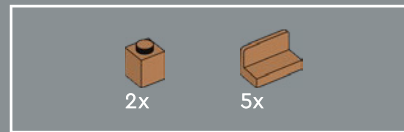
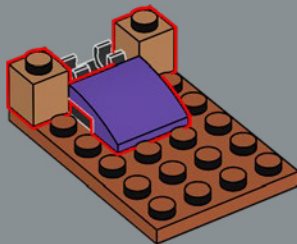

63

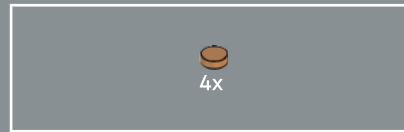
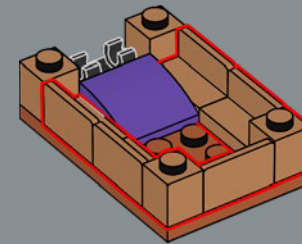

64

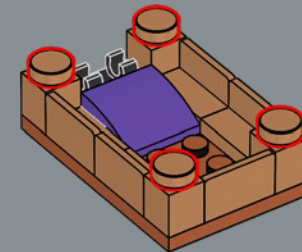

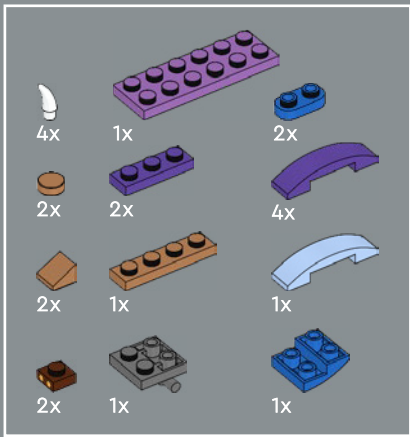
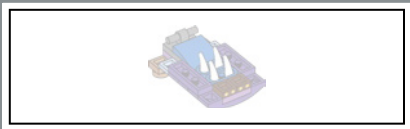

65

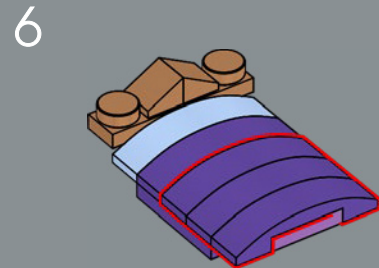
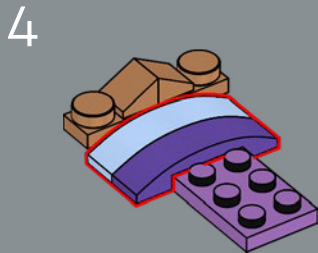
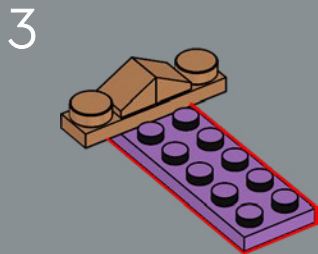
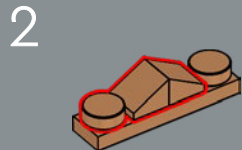
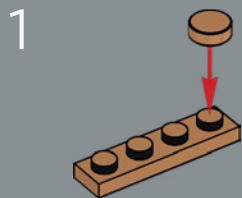



7

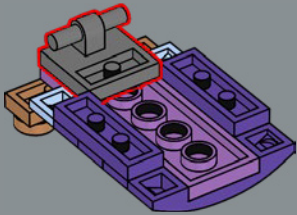

8

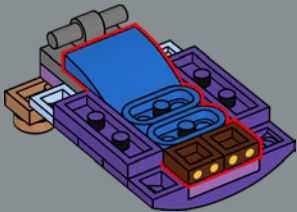

9

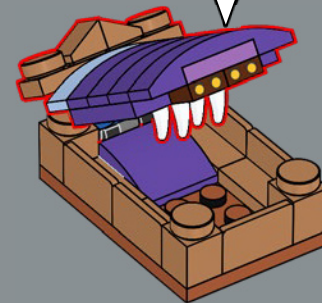
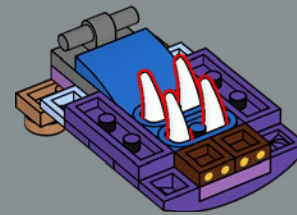

66





1

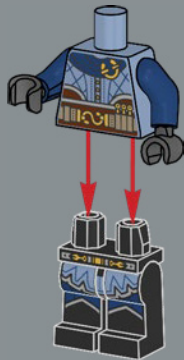

2

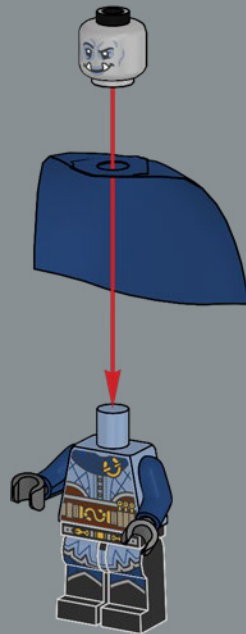

3



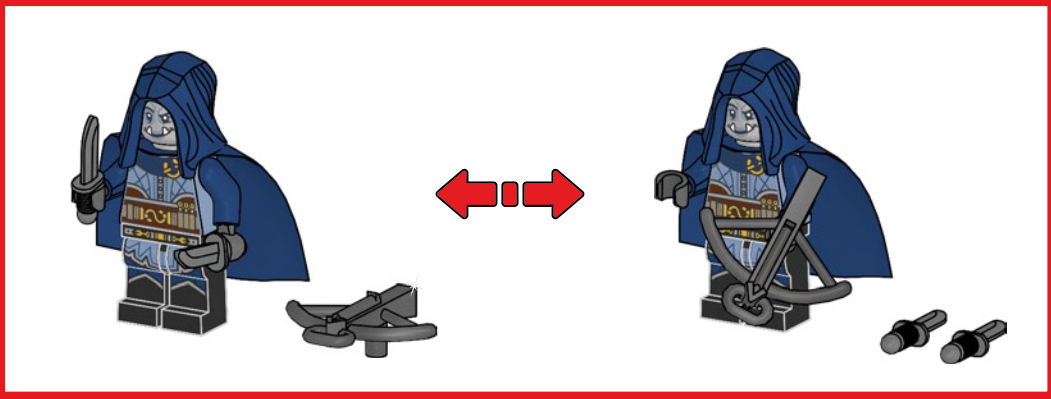
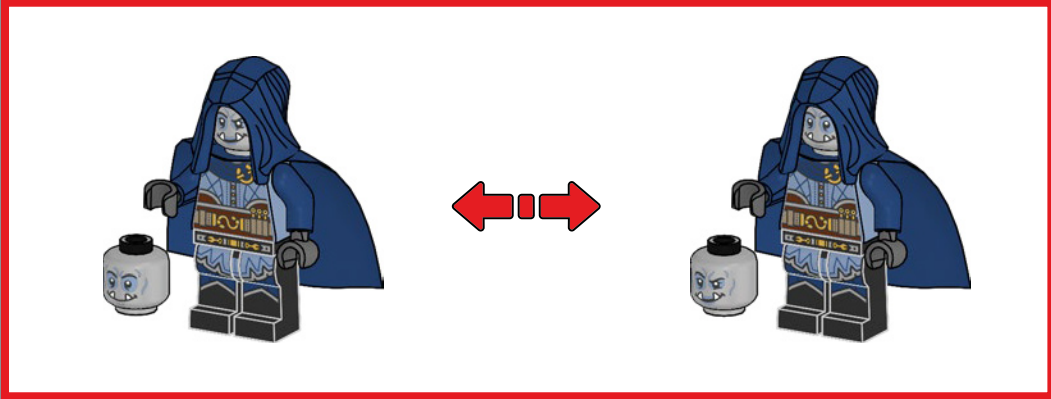

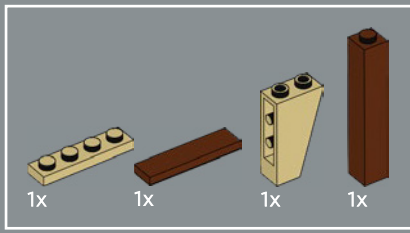

67

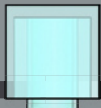

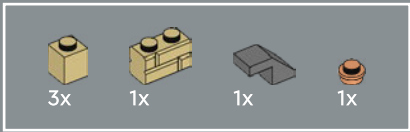

68

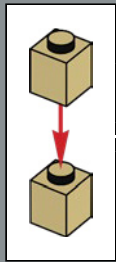
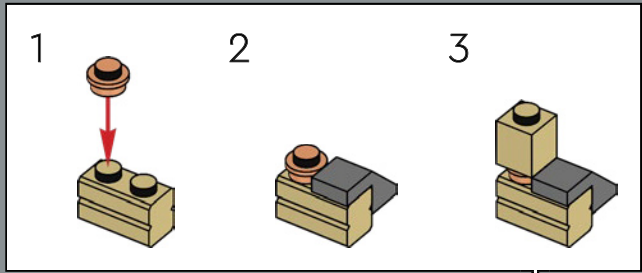

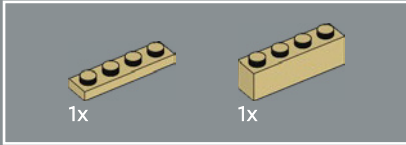

69

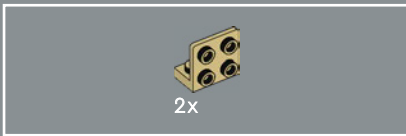
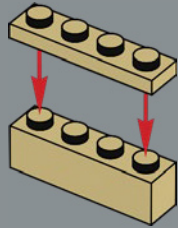

70

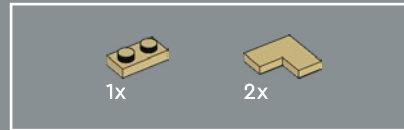
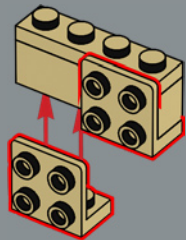

71

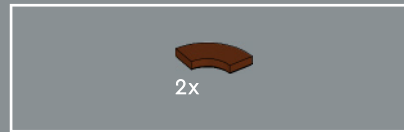
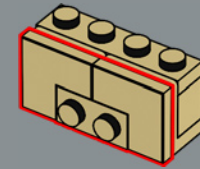

72

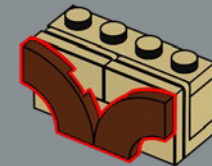



73

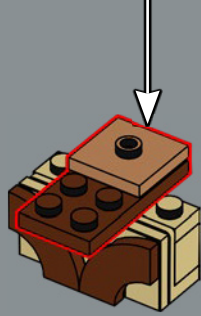
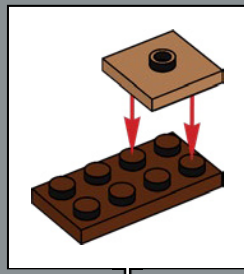

74

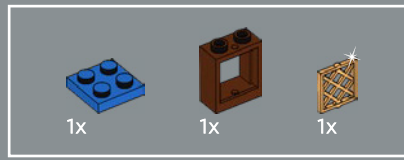
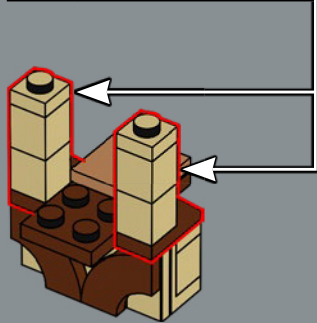
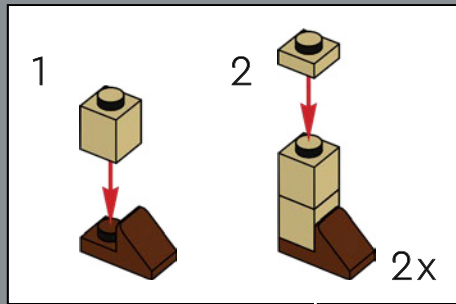

75

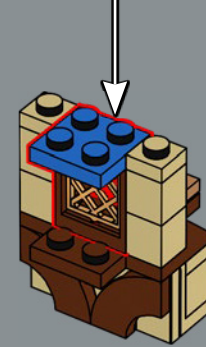
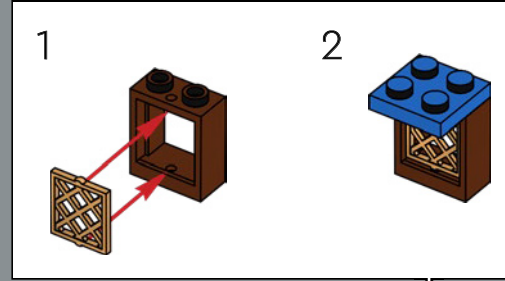





76

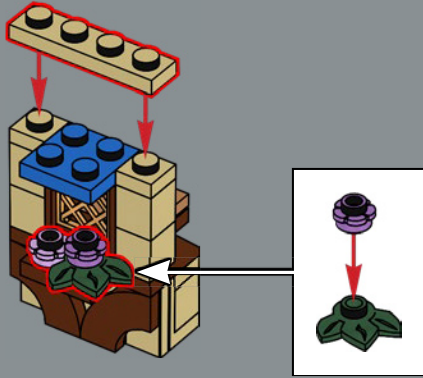

77



78



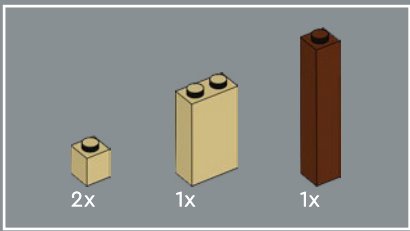

79

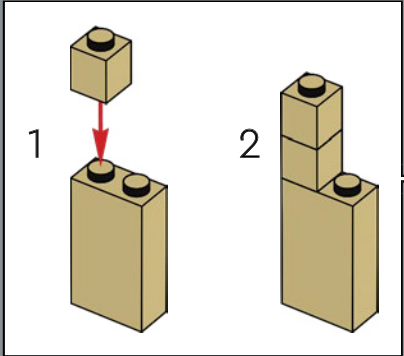
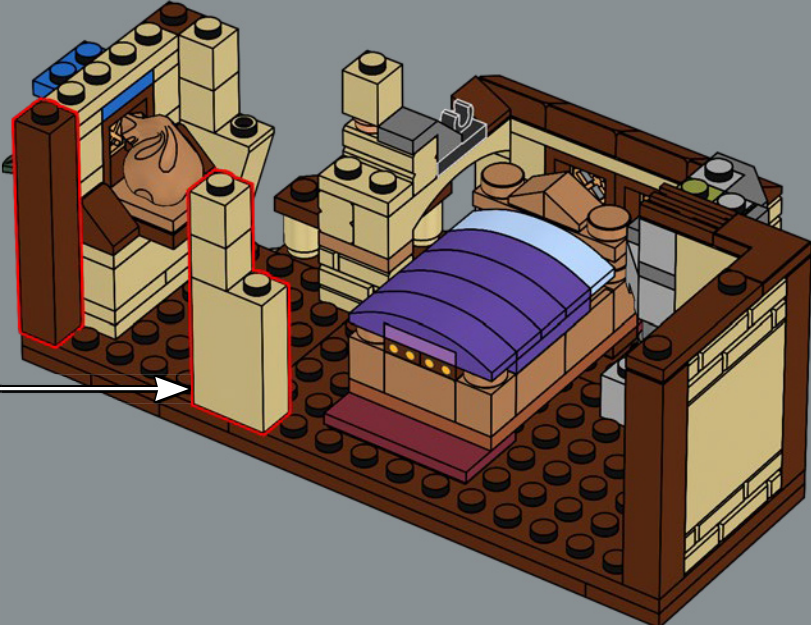

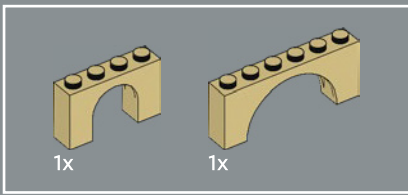

80

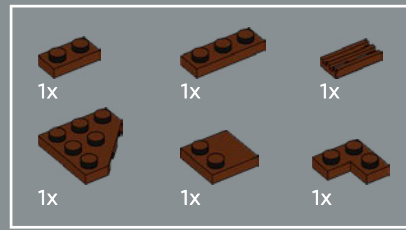
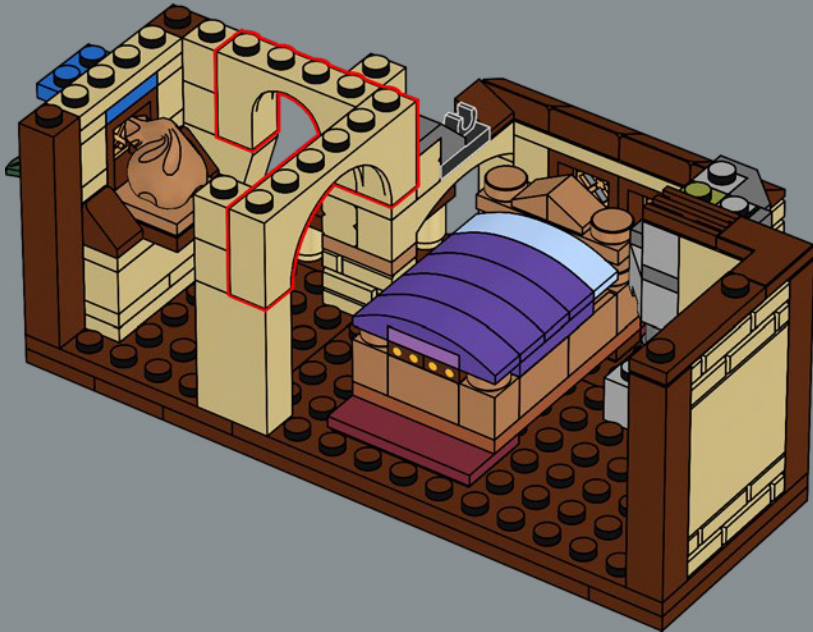

81



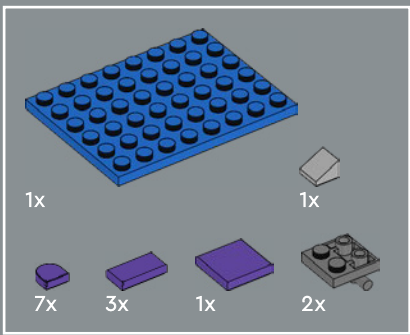

82

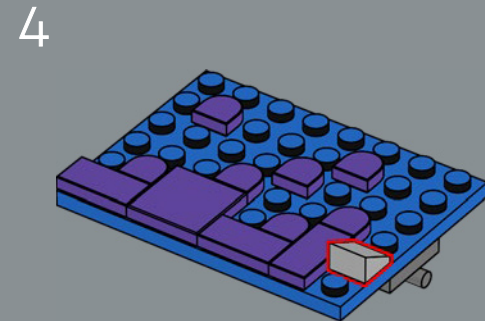
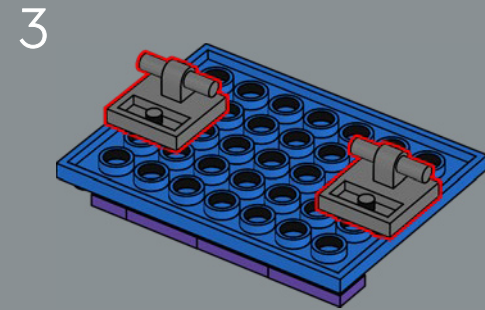
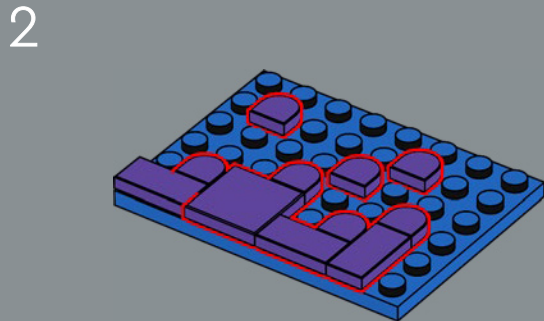
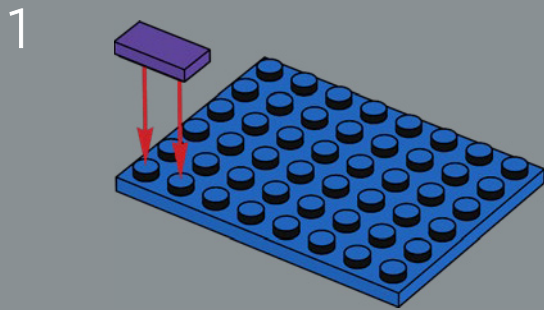

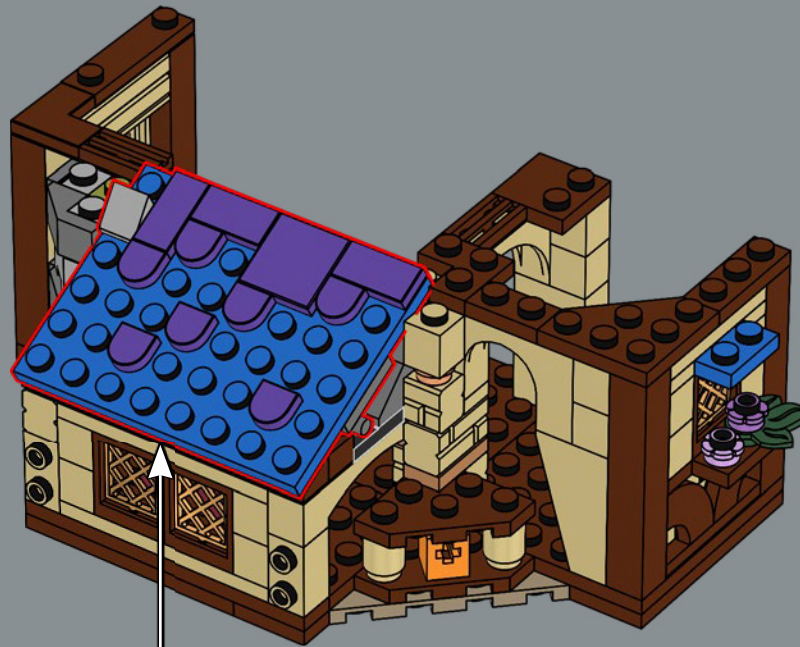

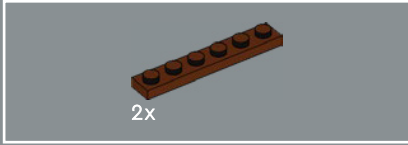
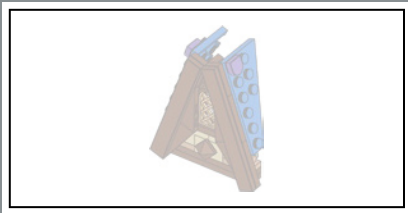

83

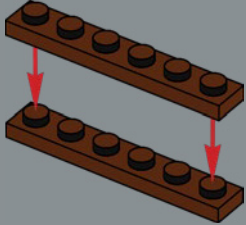

84

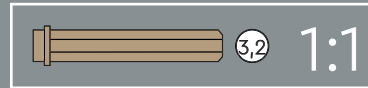
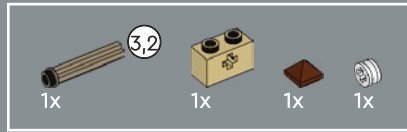
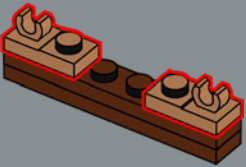

85

1

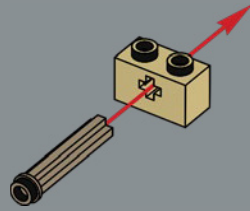

2

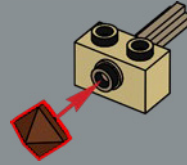

3

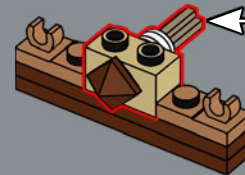
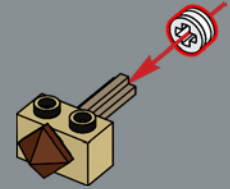



86

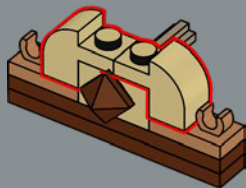

87

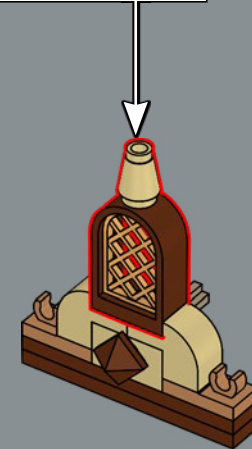
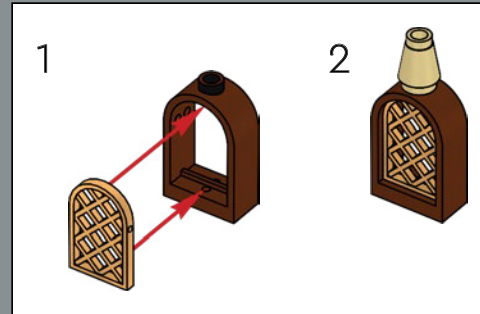

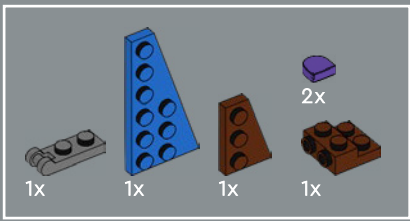

88

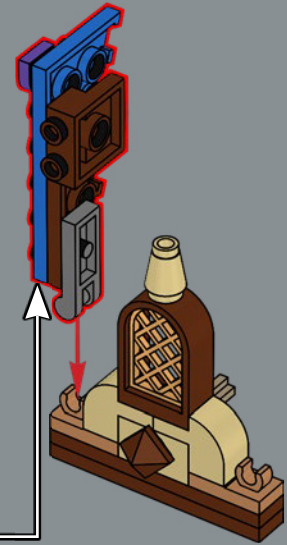
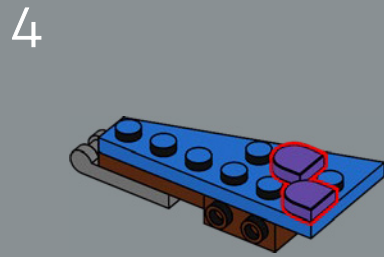
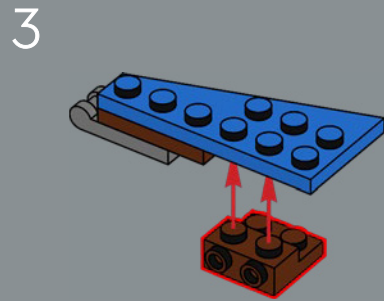
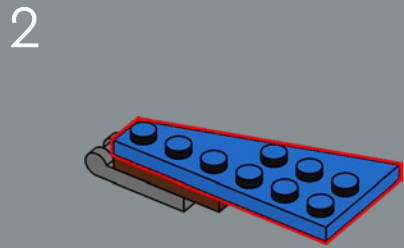
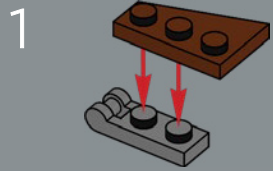



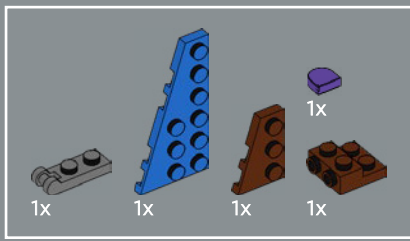

89

1

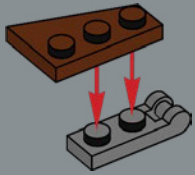

2

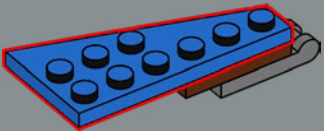

3

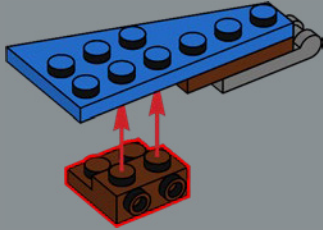

4

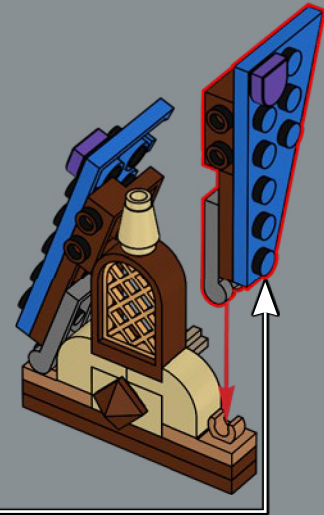
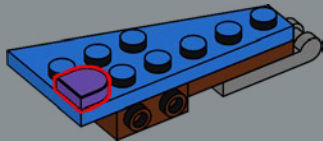

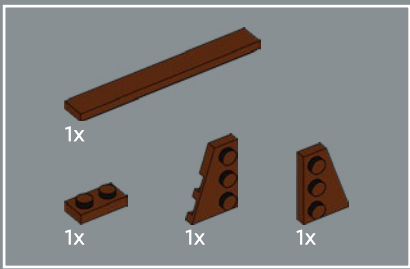

90

1

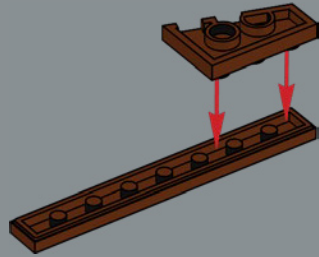

2

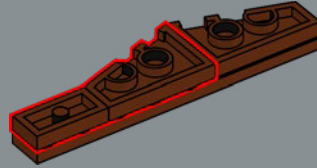

3

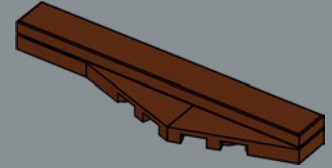

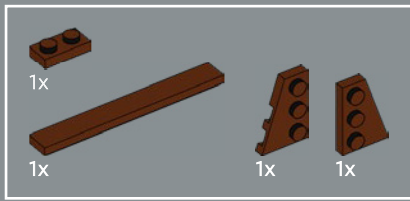

91

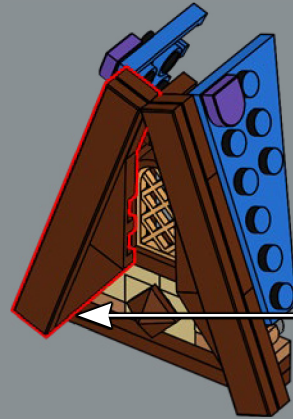
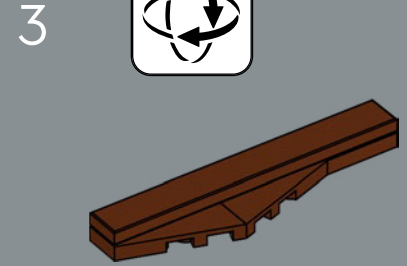
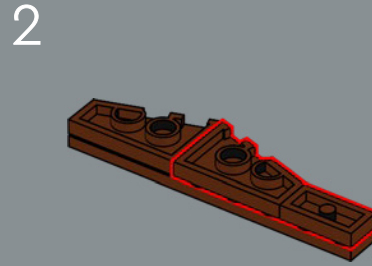
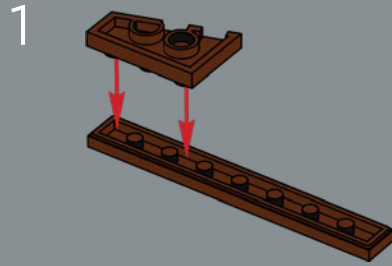

92

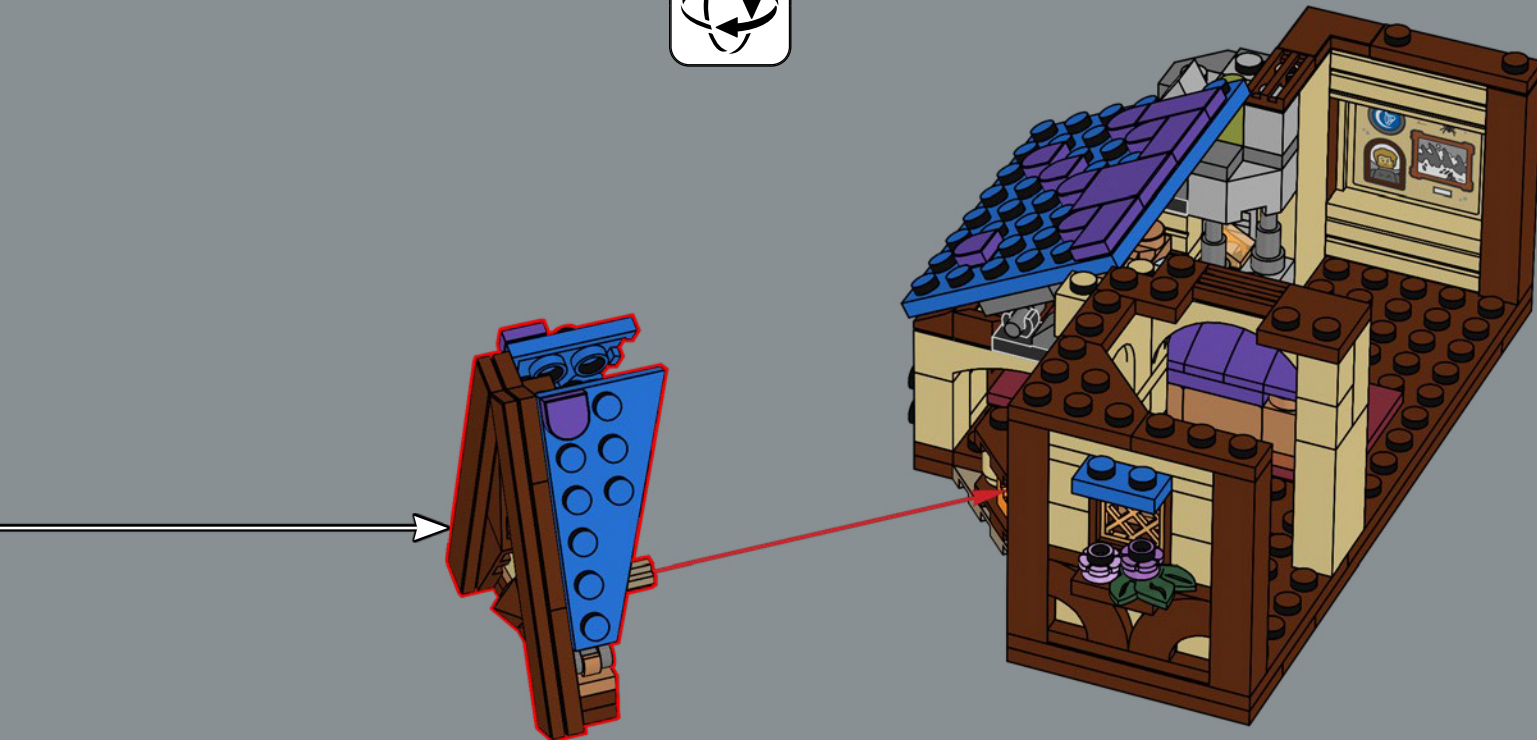



93

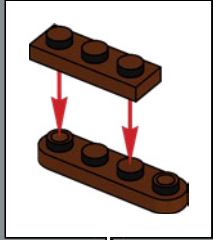

94



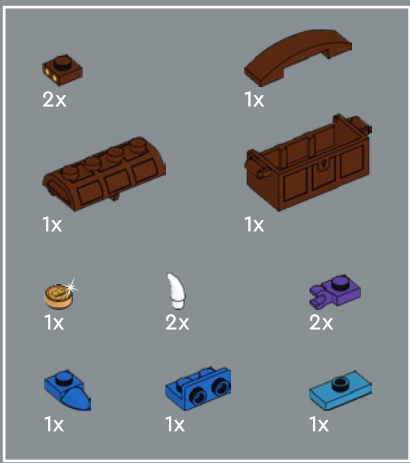

95

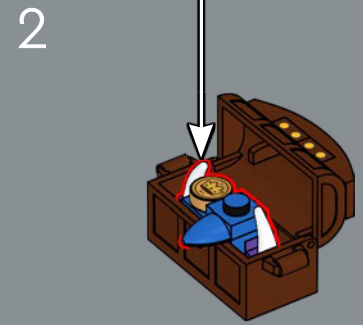
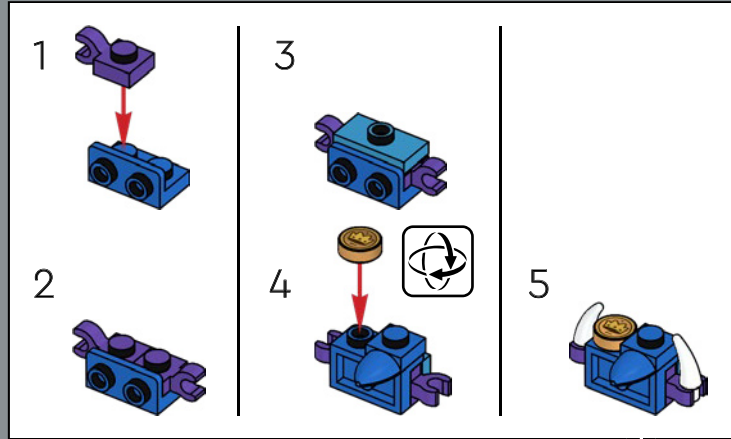
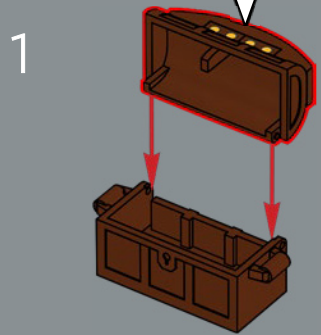
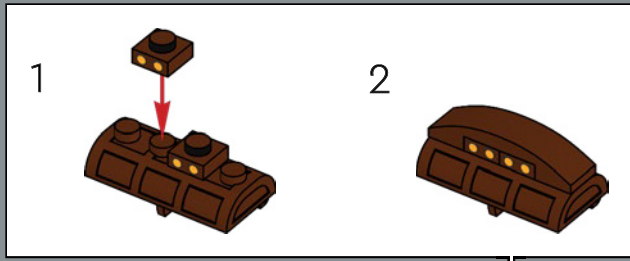







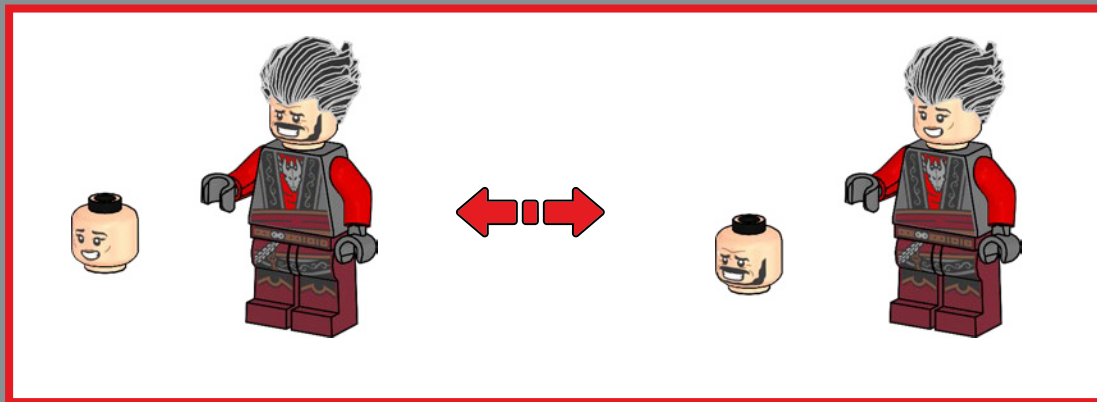
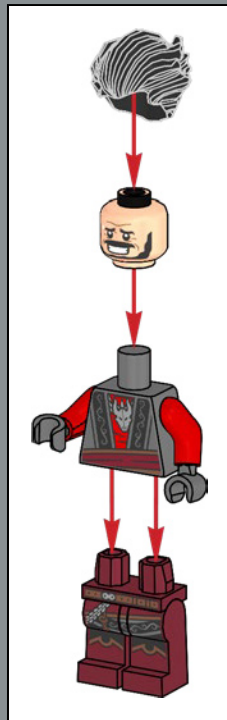

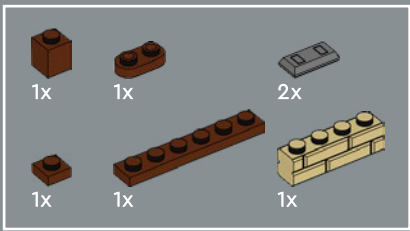

97

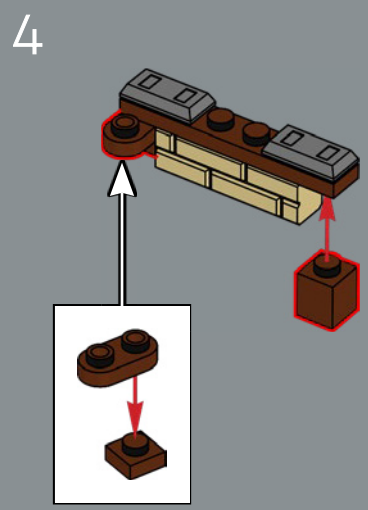
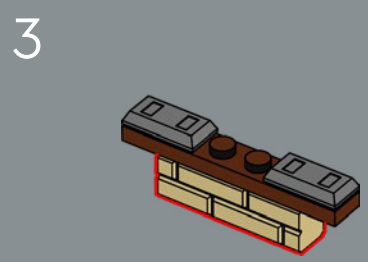
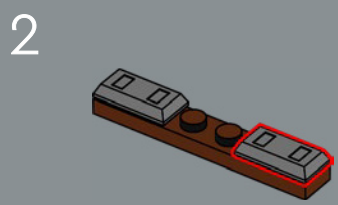
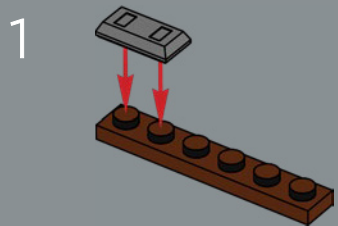

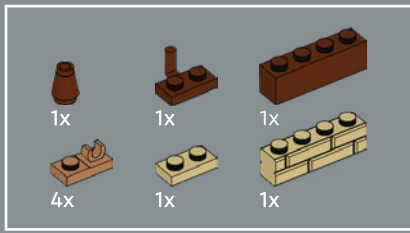

98

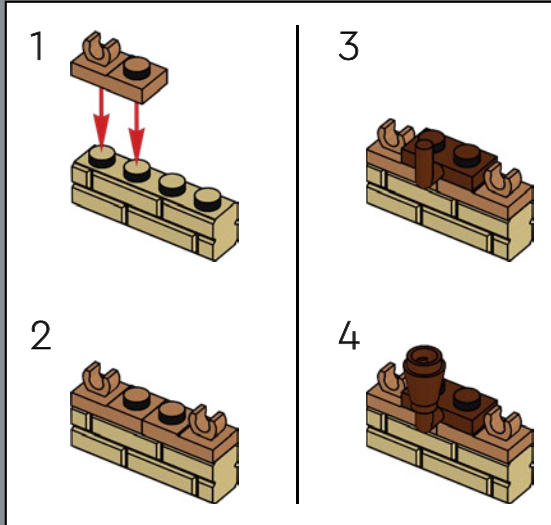
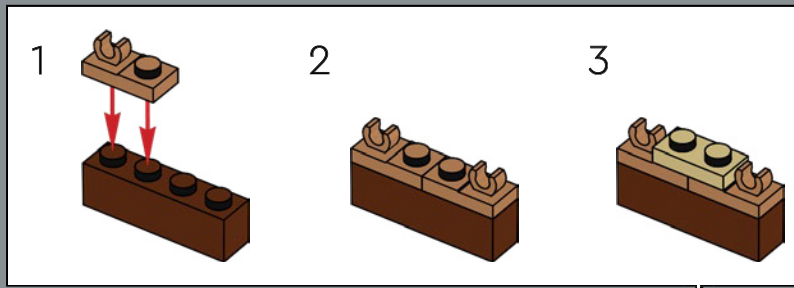

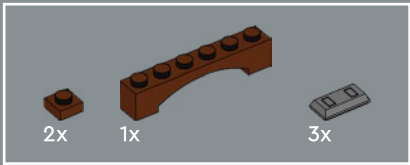

99

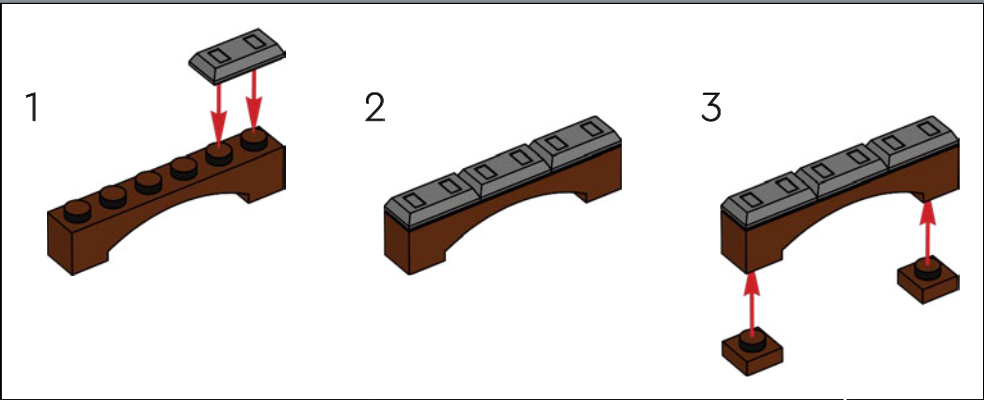

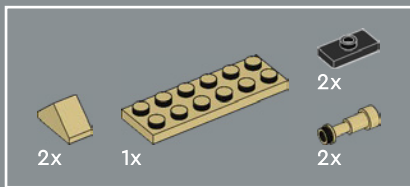

100

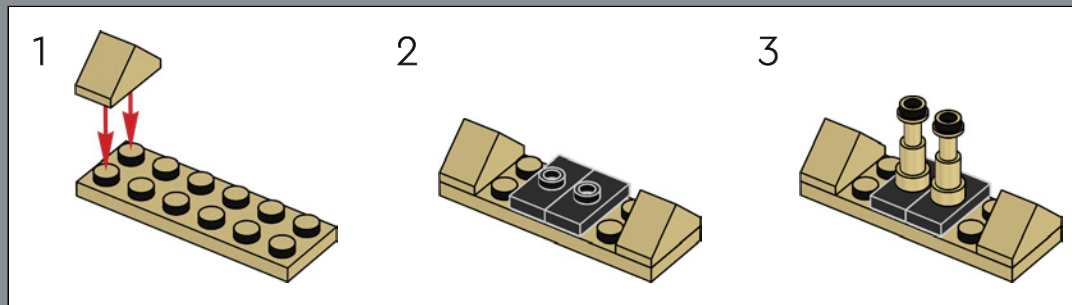

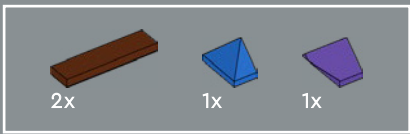

101

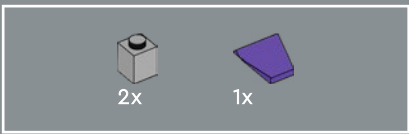
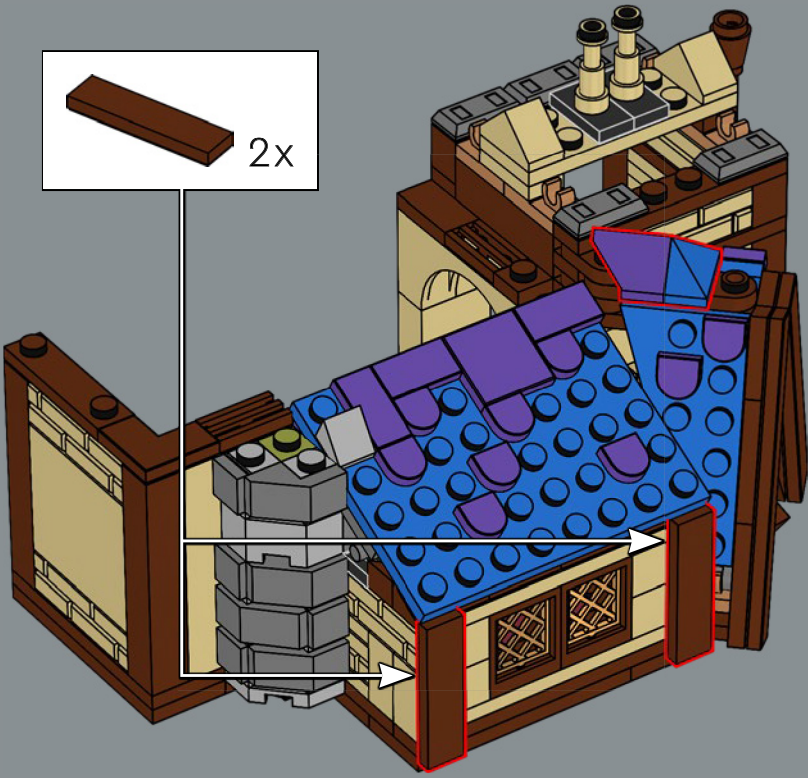
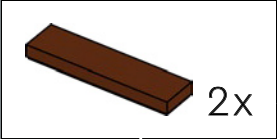

102

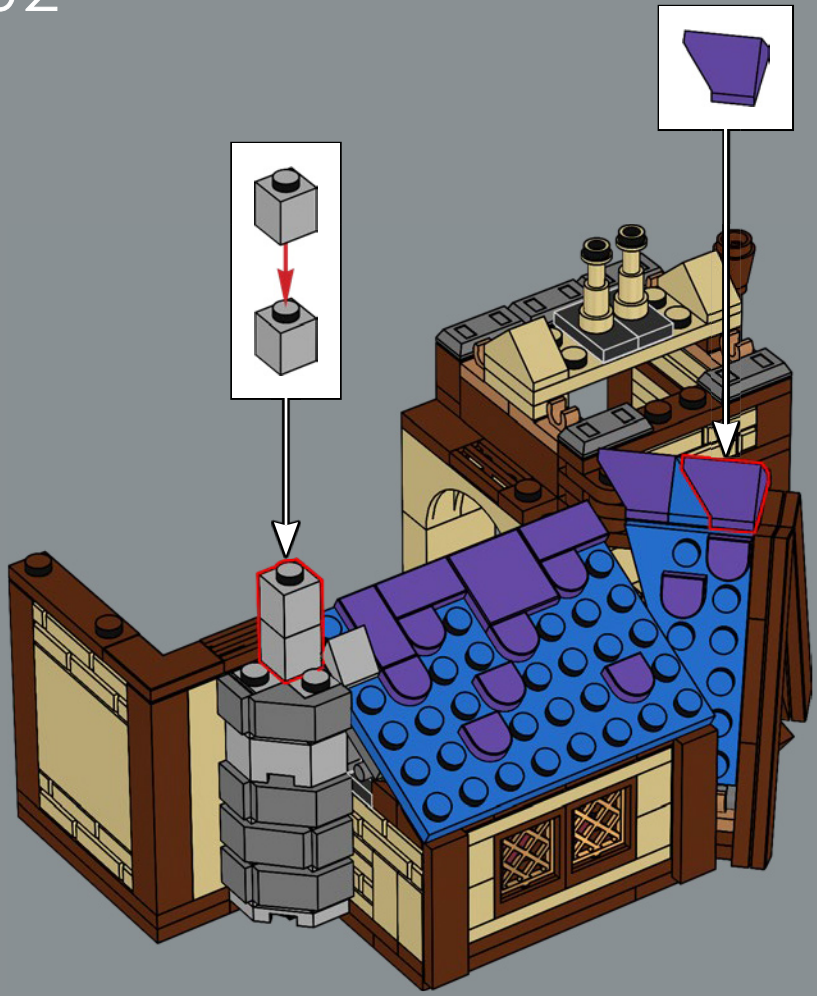
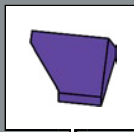
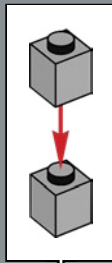

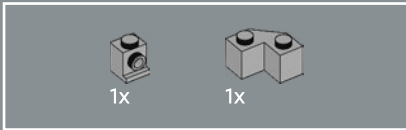

103

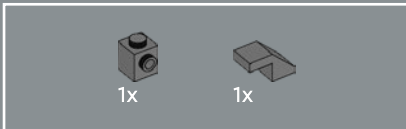
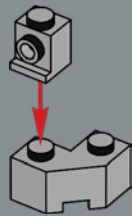

104

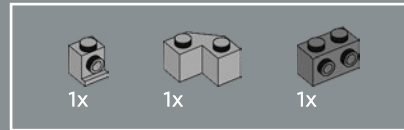
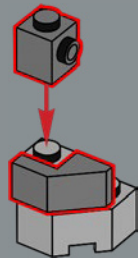

105

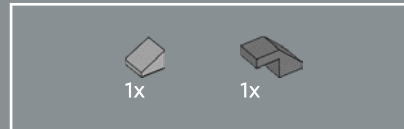
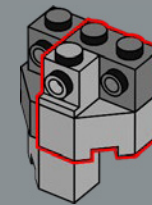
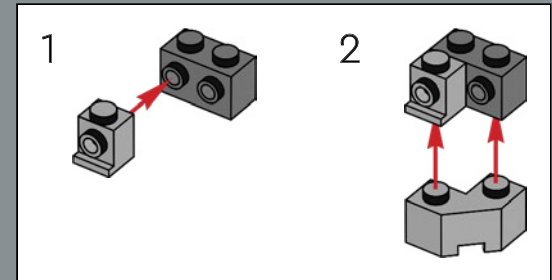

106

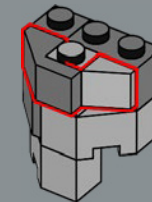



2x

107

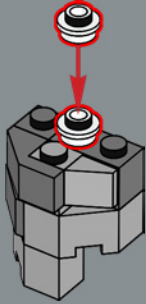

3x

108

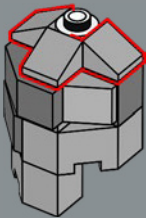

1x

109



1x

110

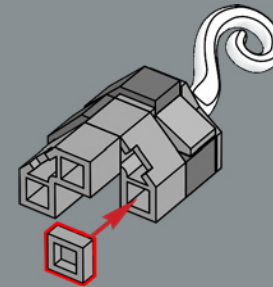



111

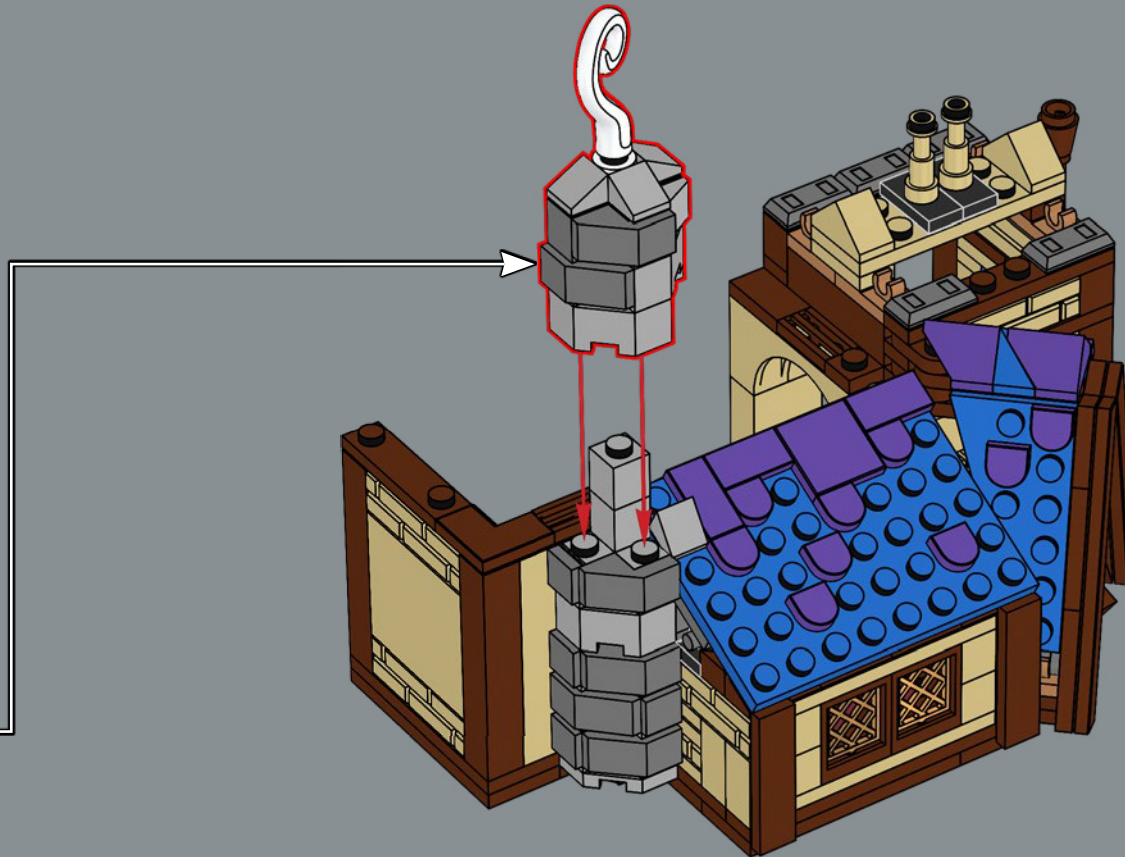

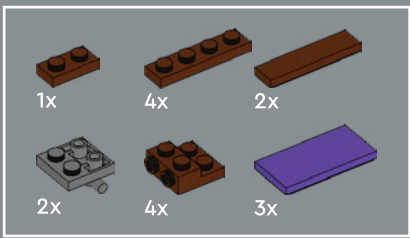

112

1

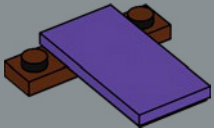

2

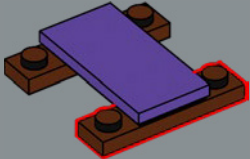

3

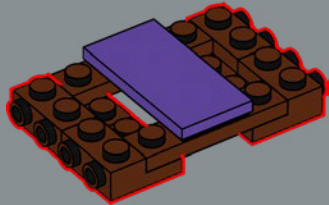

4

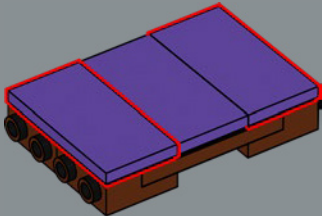

5

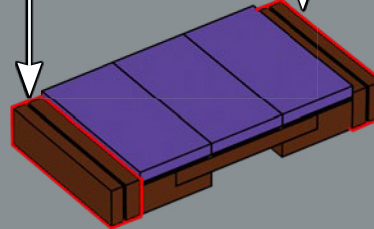

6

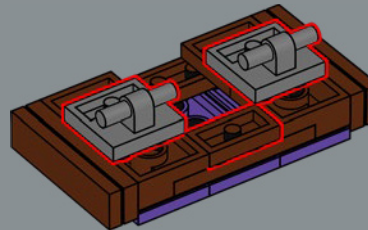

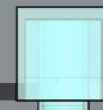

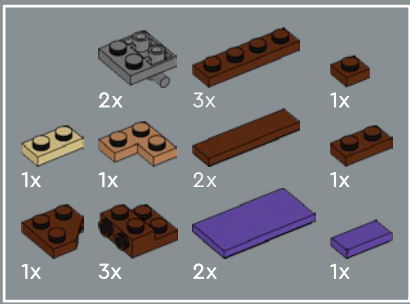

113

1

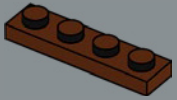

2

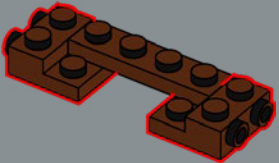

3

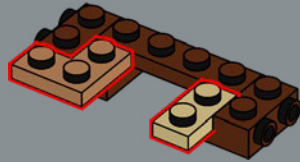

4

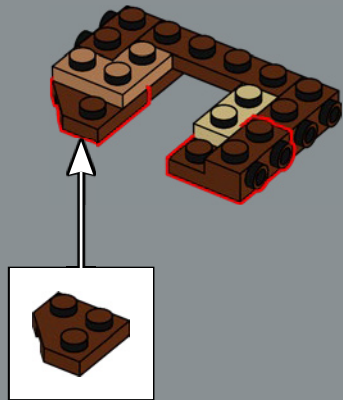

5

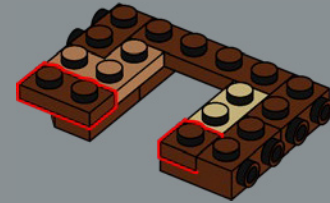

6

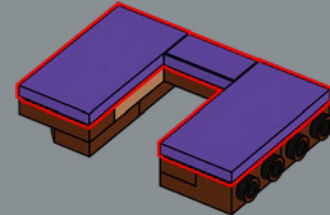

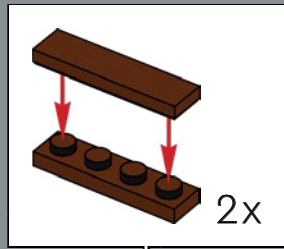

7

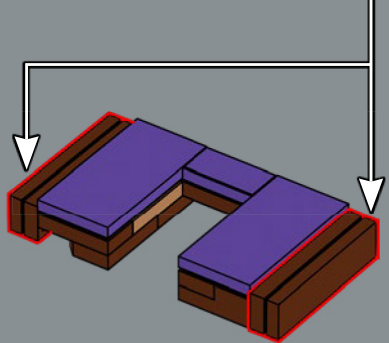

8

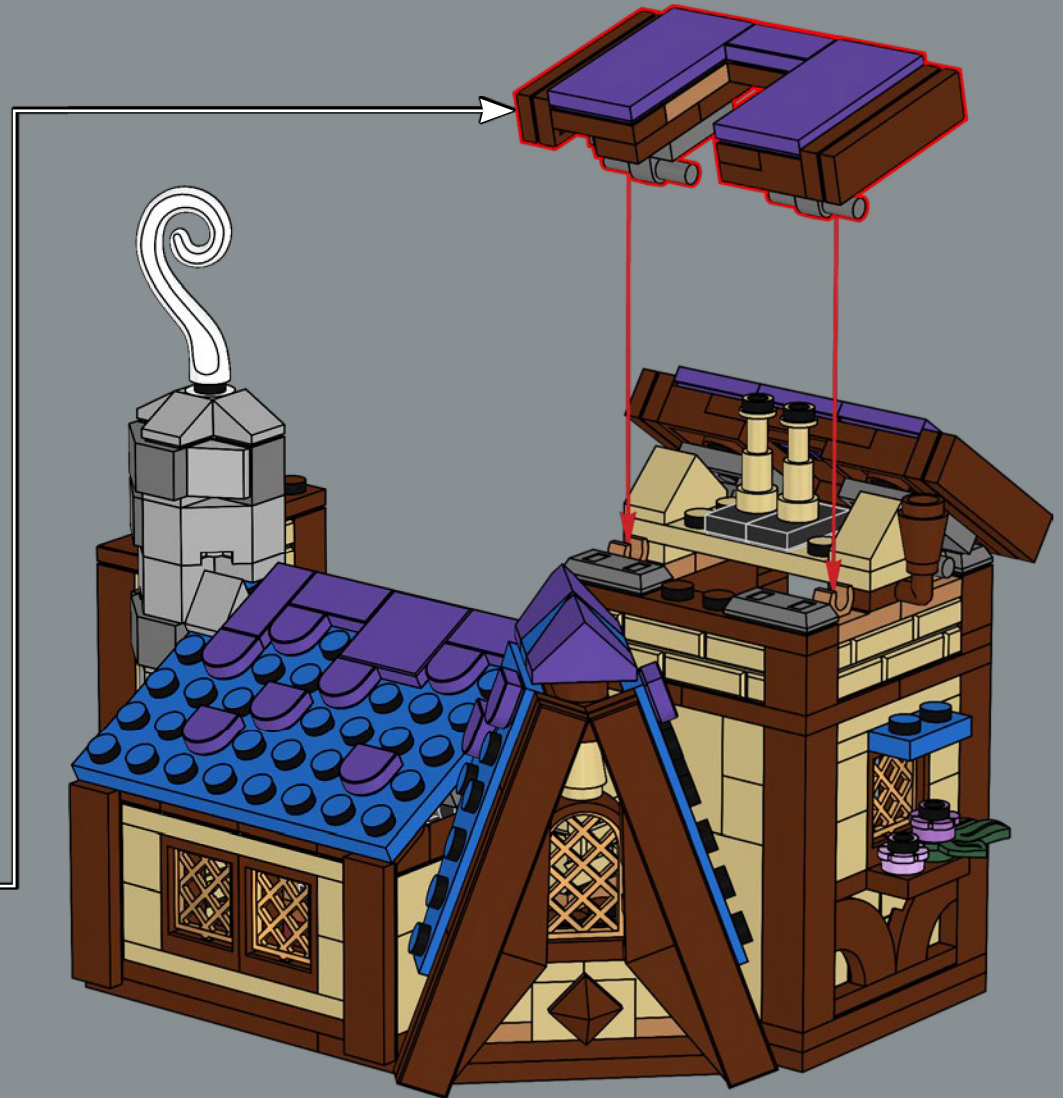
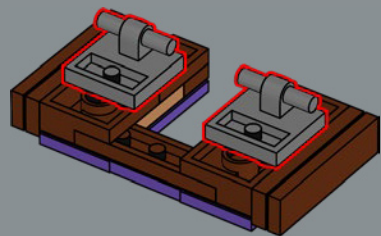

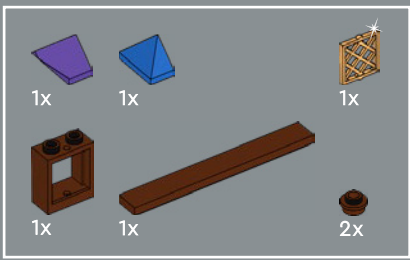

114

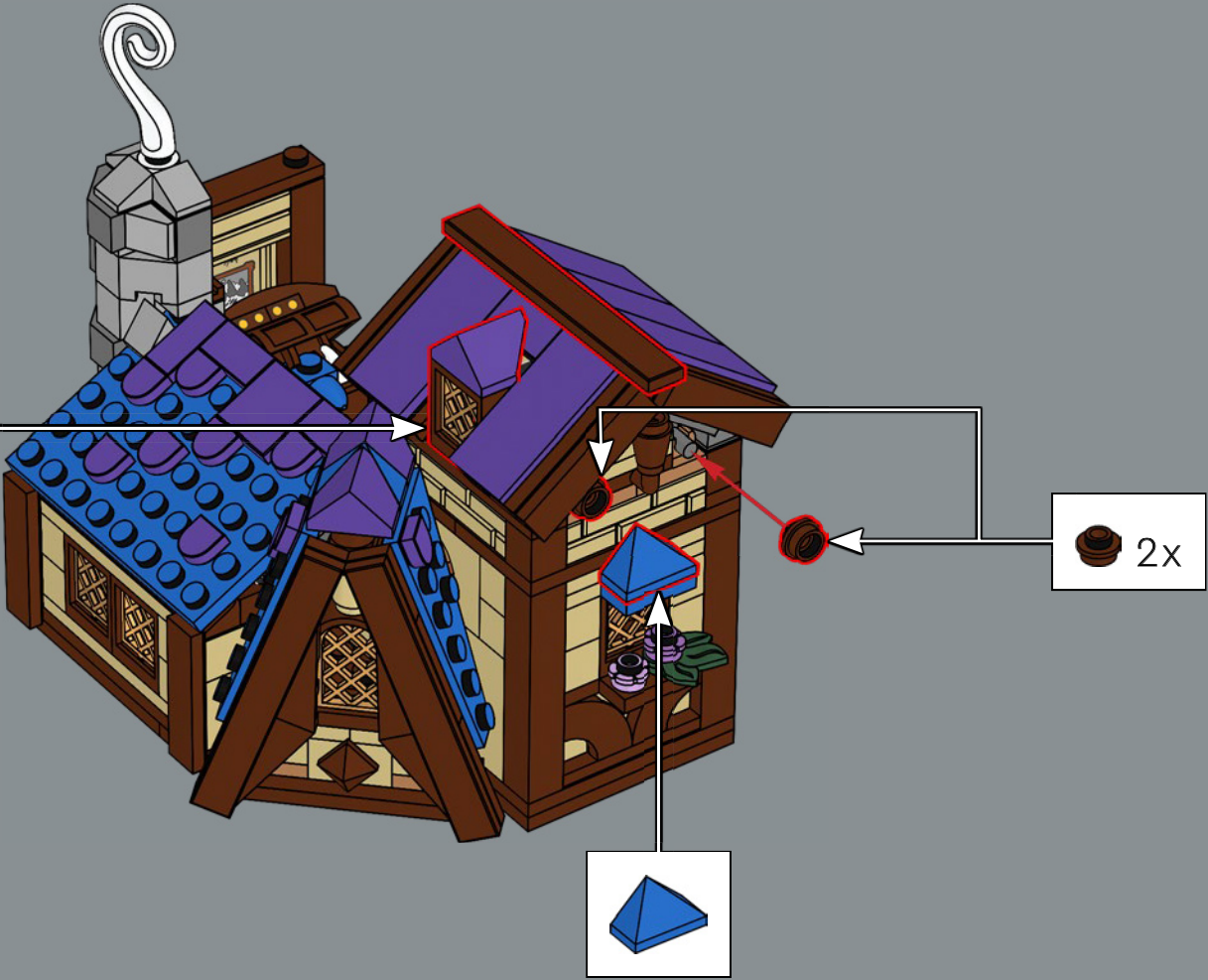
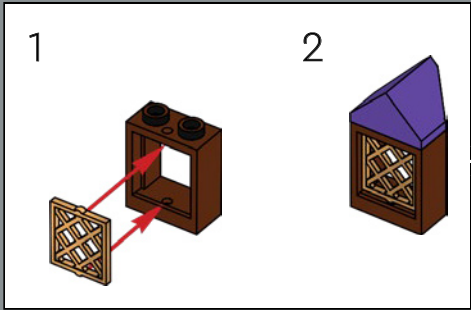

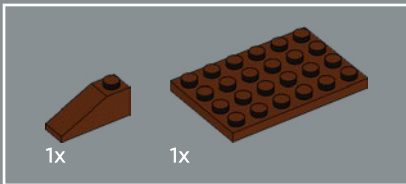
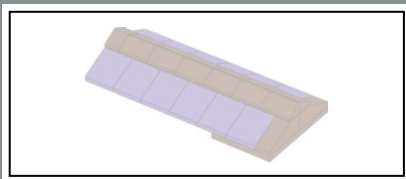

115

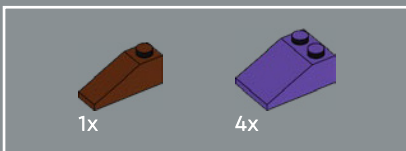
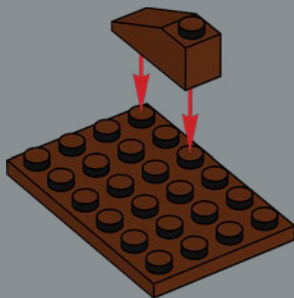

116

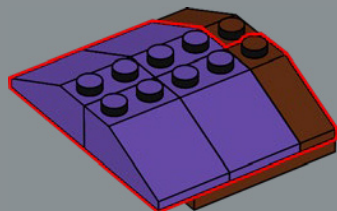

117

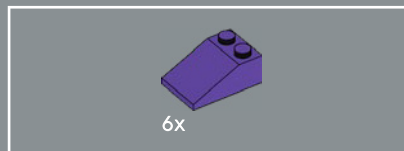
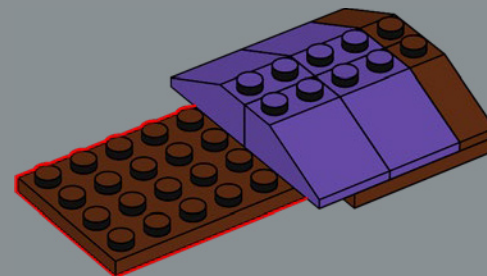

118

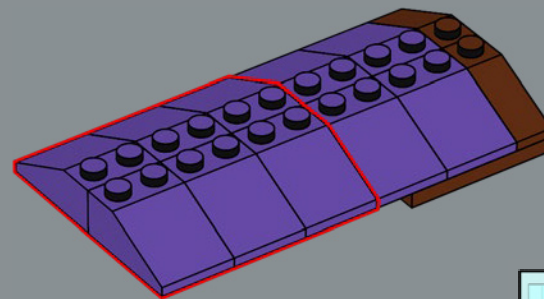



119

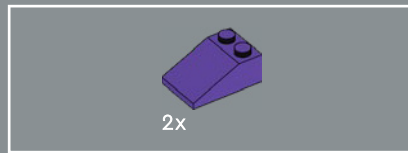
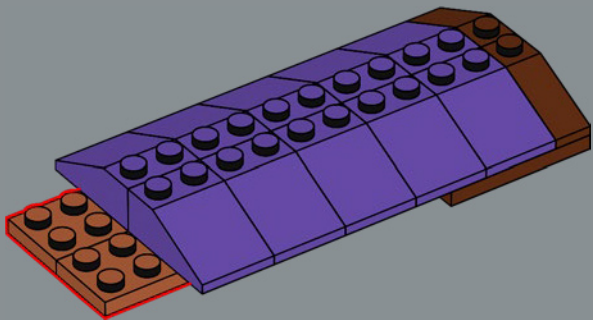

120

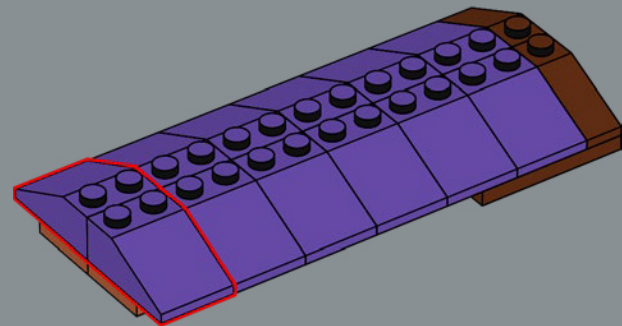



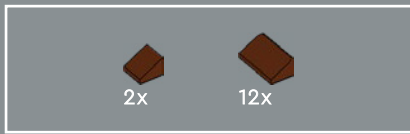

121

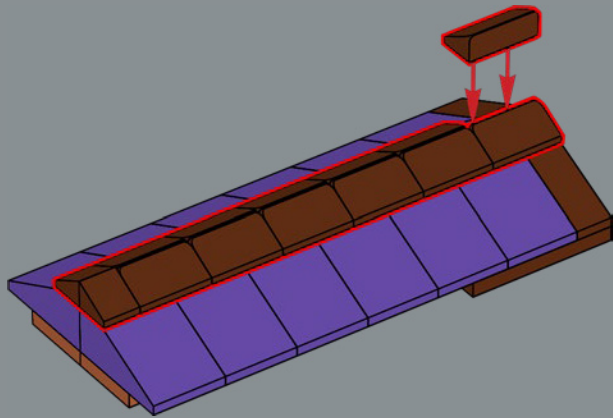

122

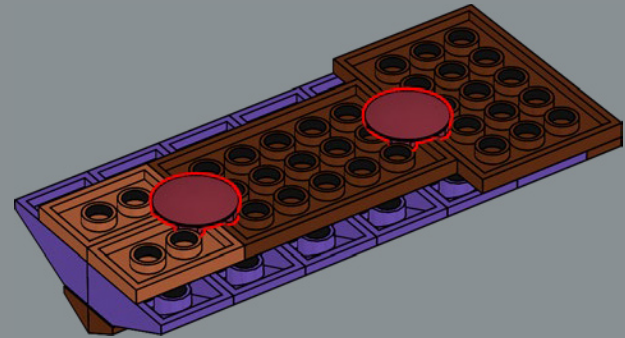

123

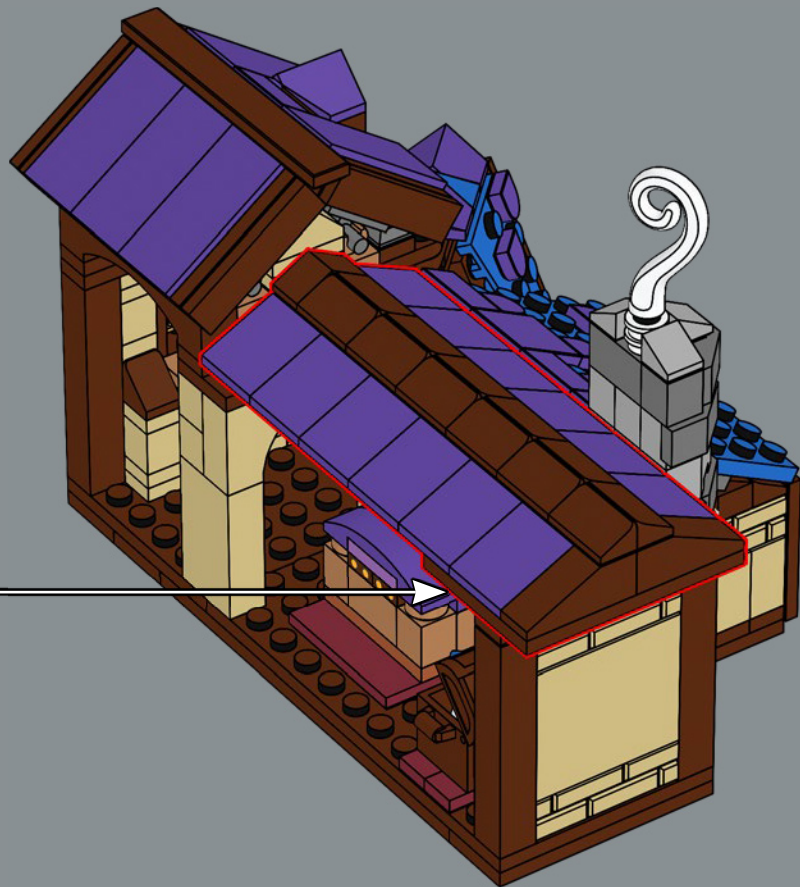

124

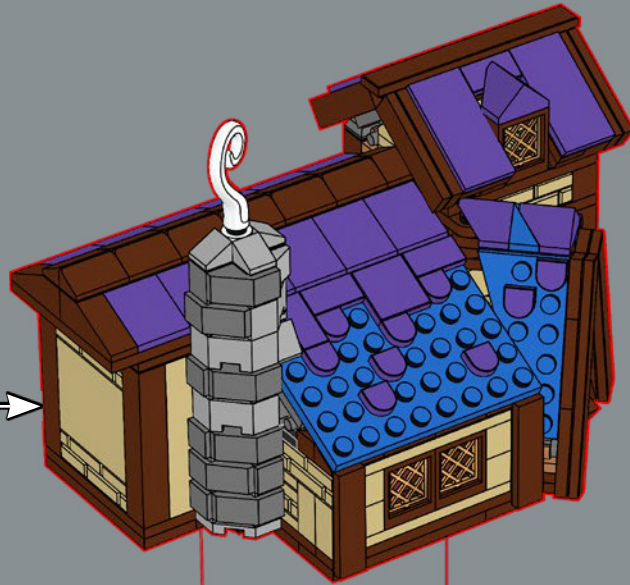



LEGO and the LEGO logo are trademarks of the LEGO Group. ©2024 The LEGO Group. 6515793  
DUNGEONS & DRAGONS is a trademark of Wizards of the Coast LLC and is used with permission. ©2024 Wizards of the Coast.