

**LEGO**

# NINJAGO

Masters of Spinjitzu

2259



1

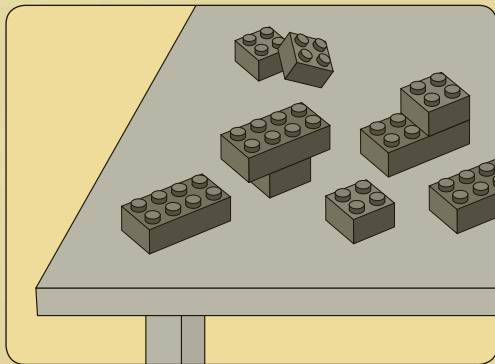
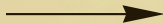
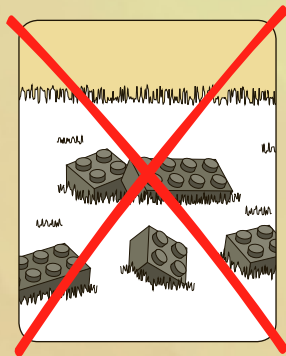

2

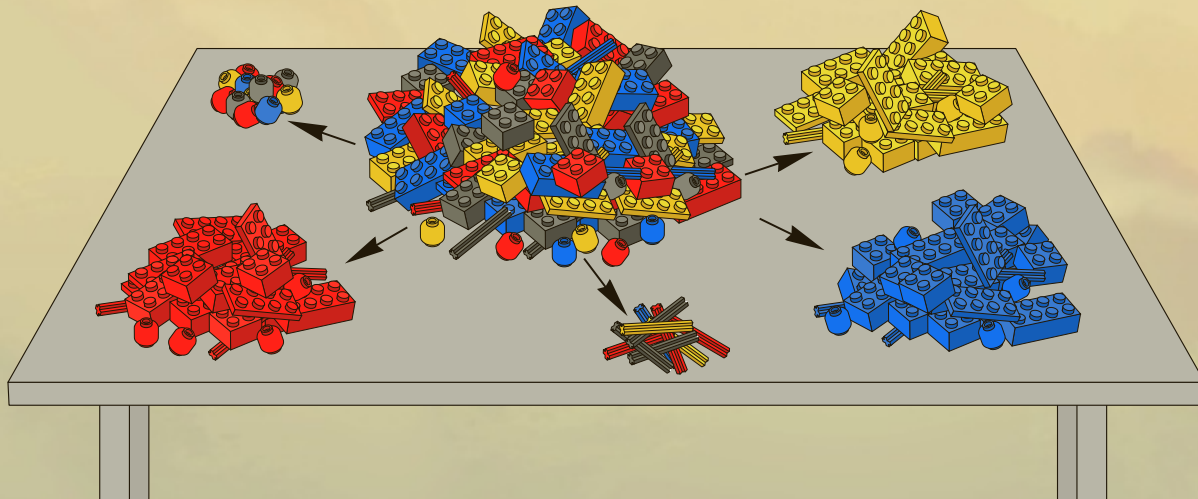

2

1



2

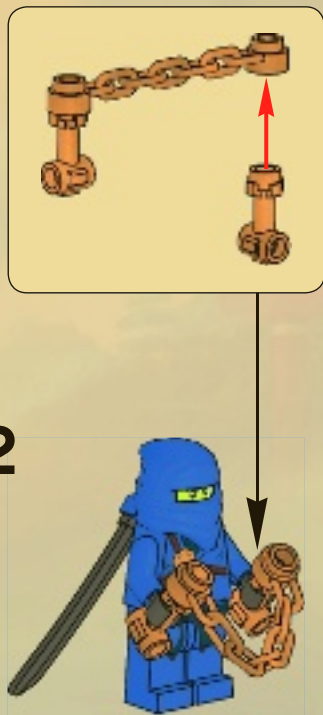

1

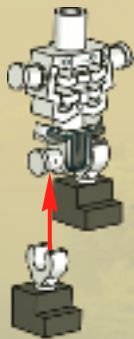

2

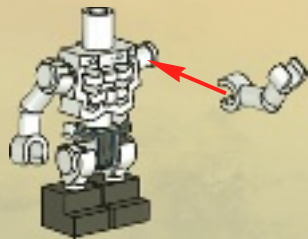

3

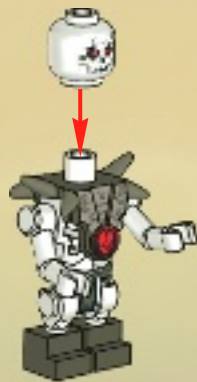

4



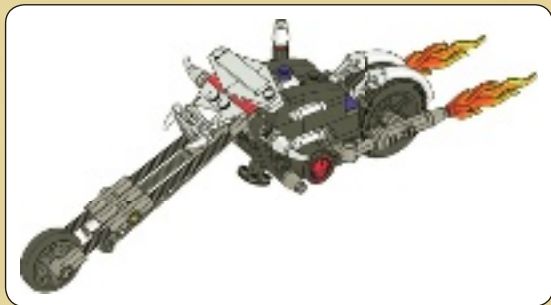

1x

1

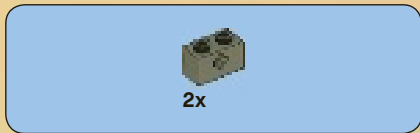

2x

2

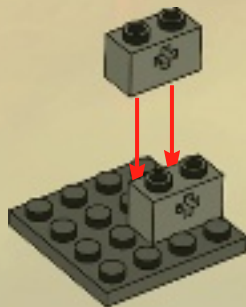



2x

3



1x

4



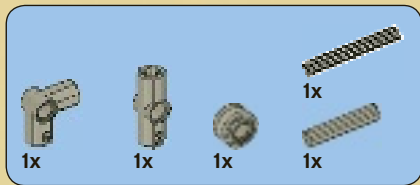

5

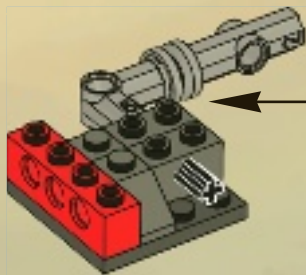
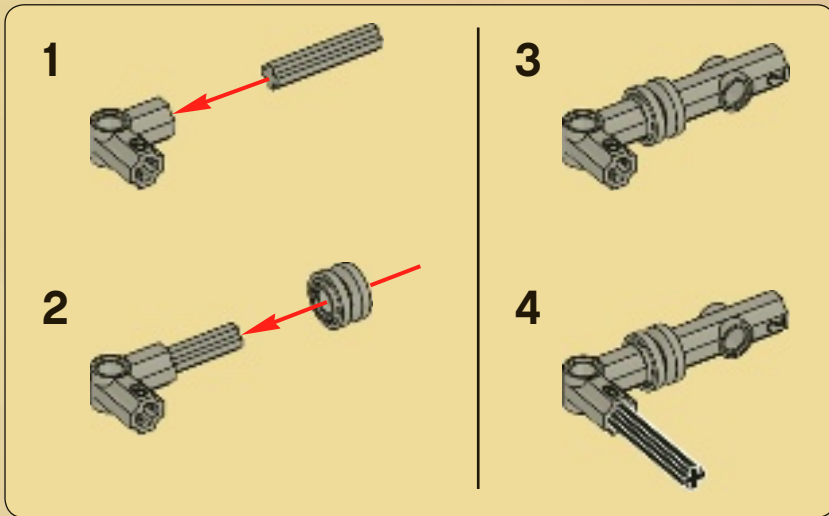



1x

6



8



2x



1x

7

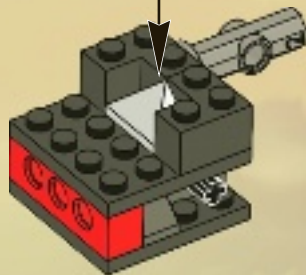
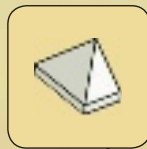



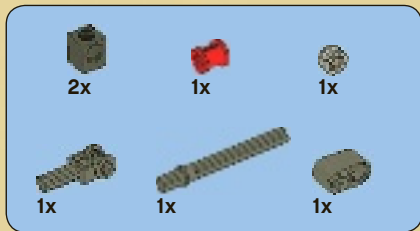

8

1

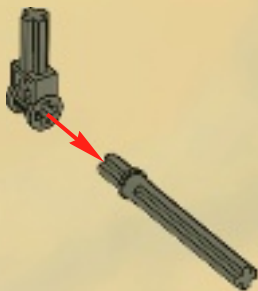

2

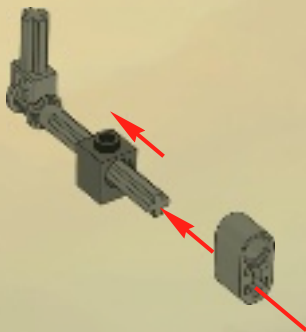

3

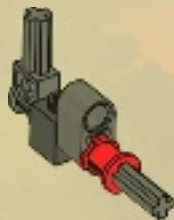

4

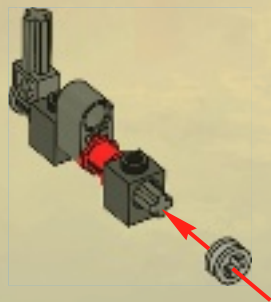

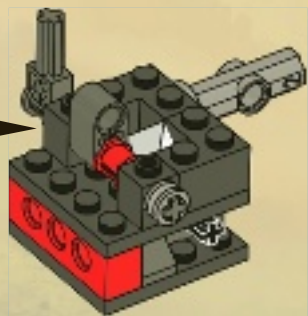

9

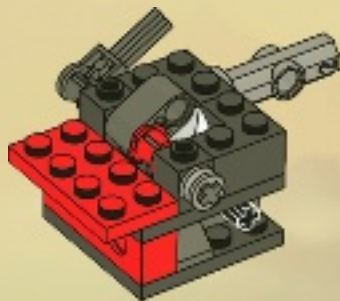



2x



1x

# 10

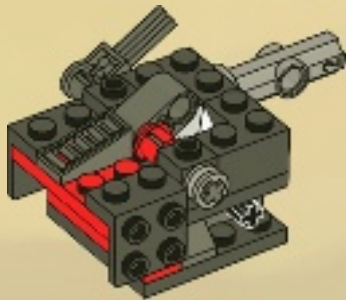

2x



2x

# 11

1



2



2x

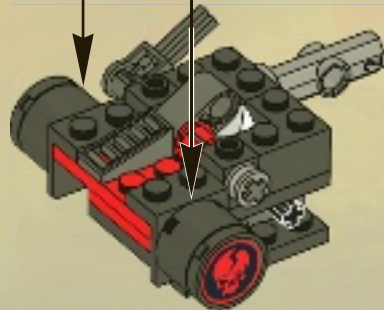



2x

# 12

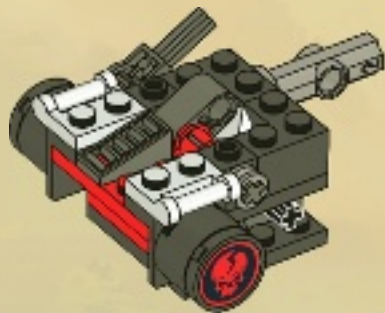

2x



1x



2x



2x

# 13

1

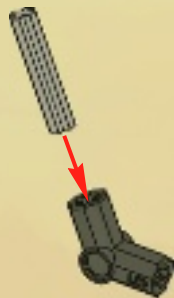

2



3



4

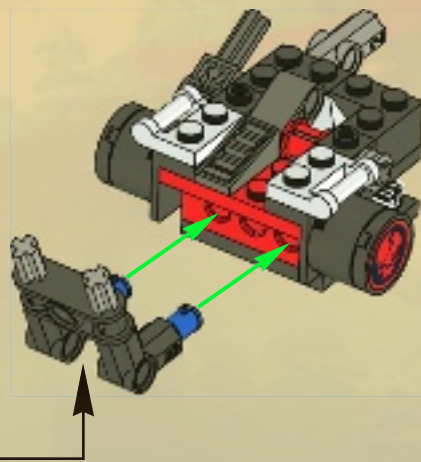
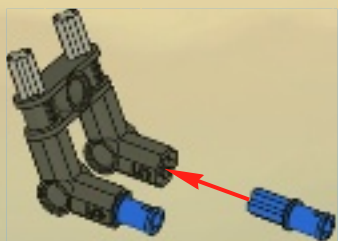



14

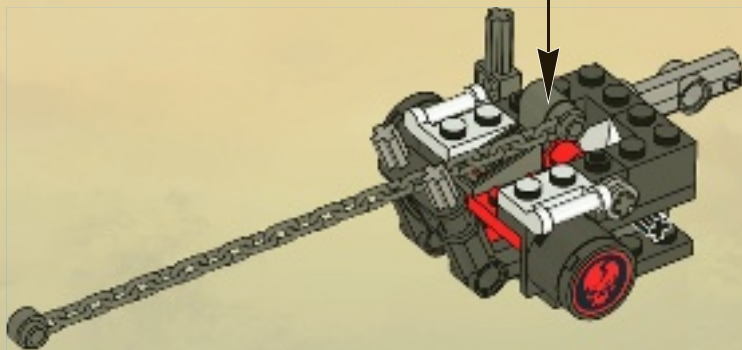
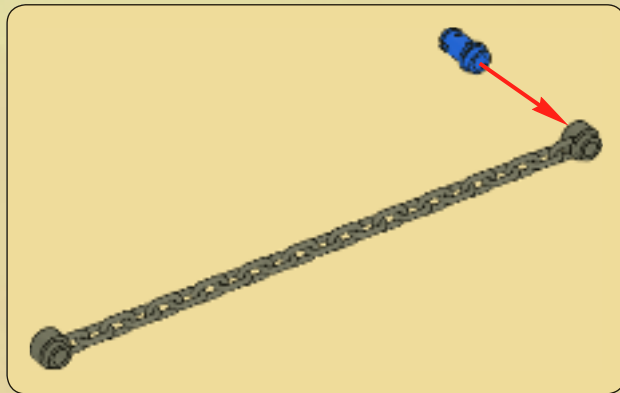



2x



2x

# 15

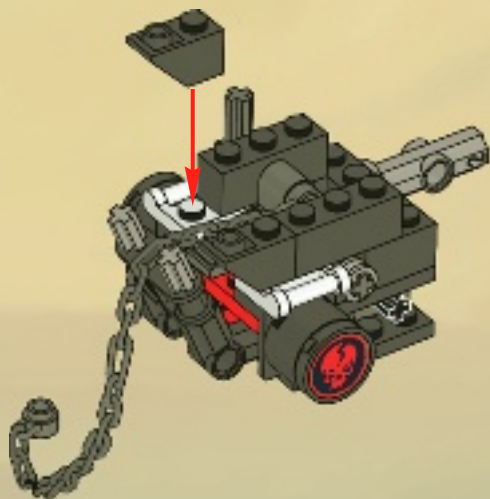

1x

# 16

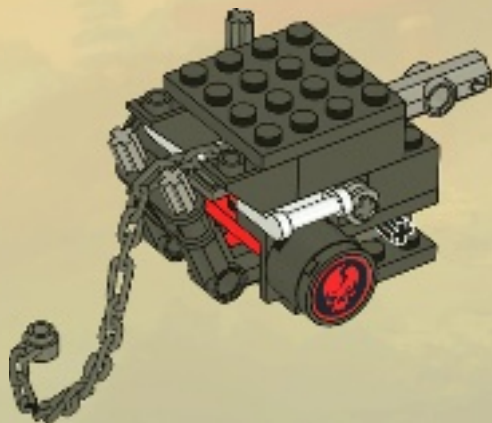



1x



1x



1x

# 17

1



2

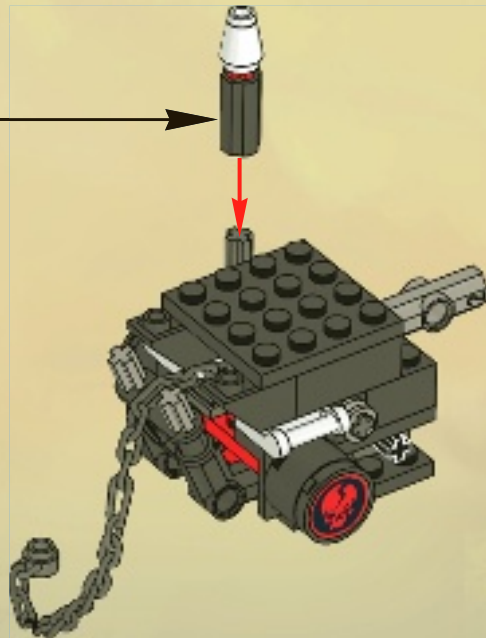





2x

18



2x

19





2x

# 20



# 21



1x



1x



2x



1x



1x

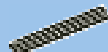

1x

1

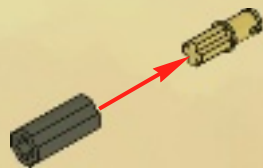

2



3



4

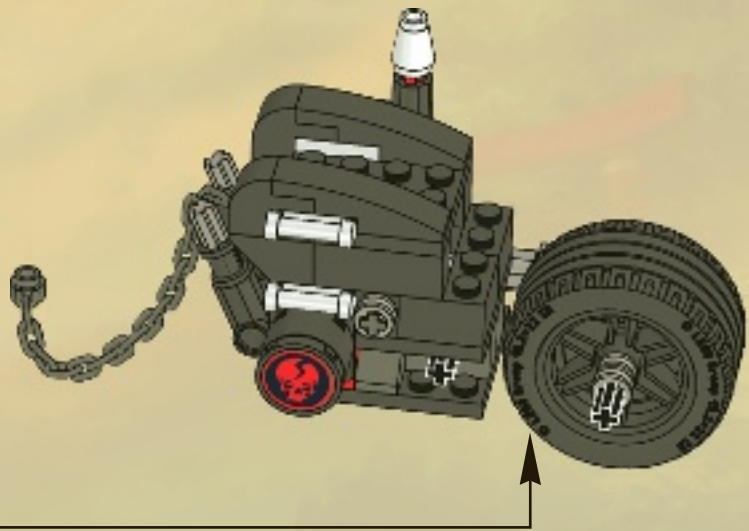
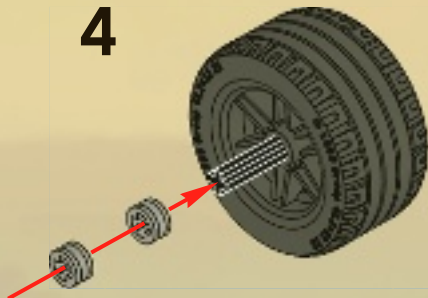

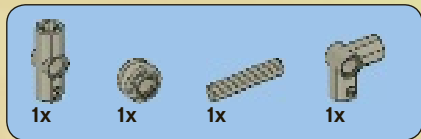

22

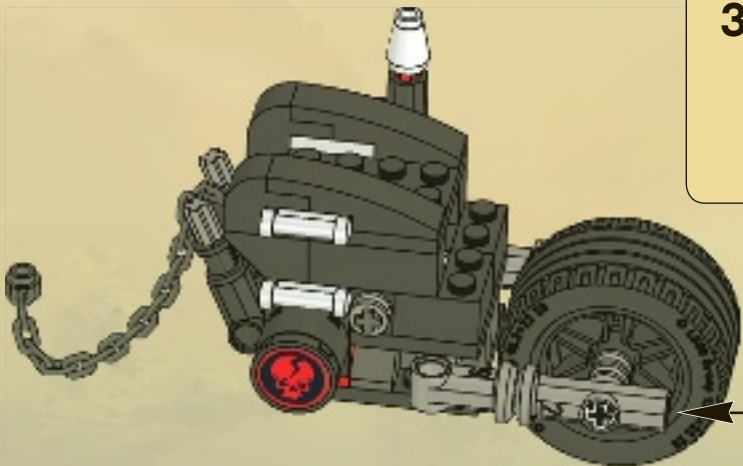
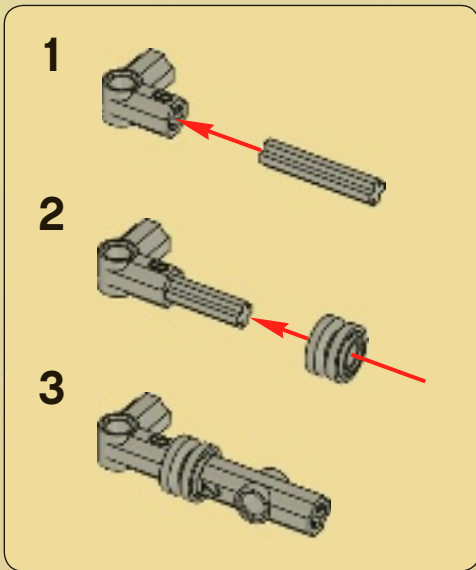



23

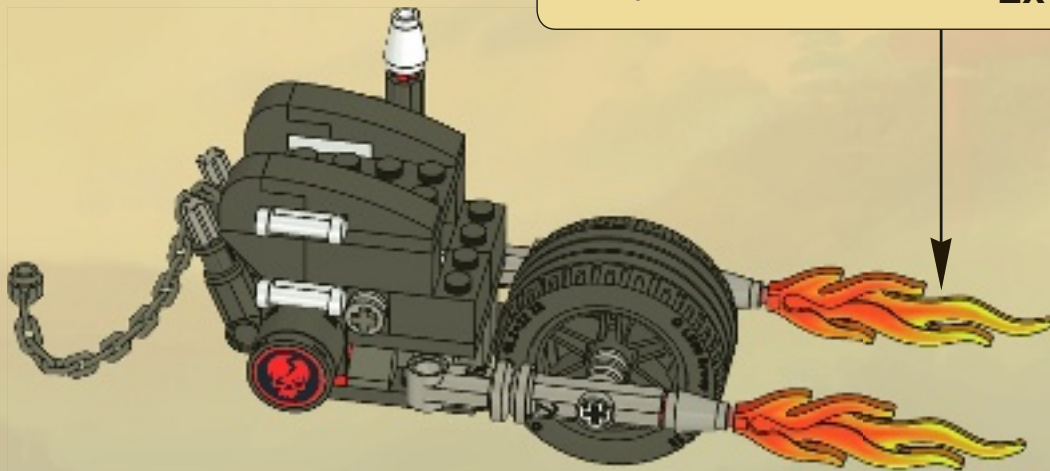
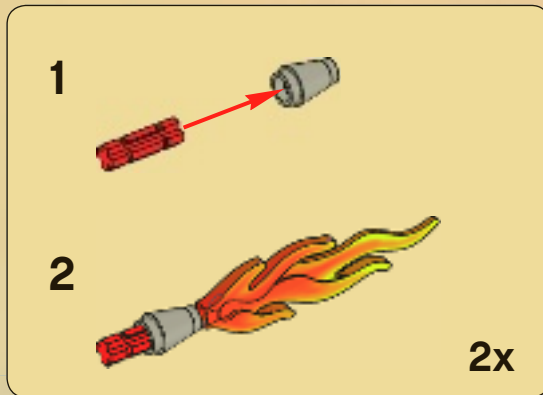

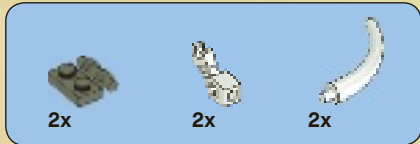

24

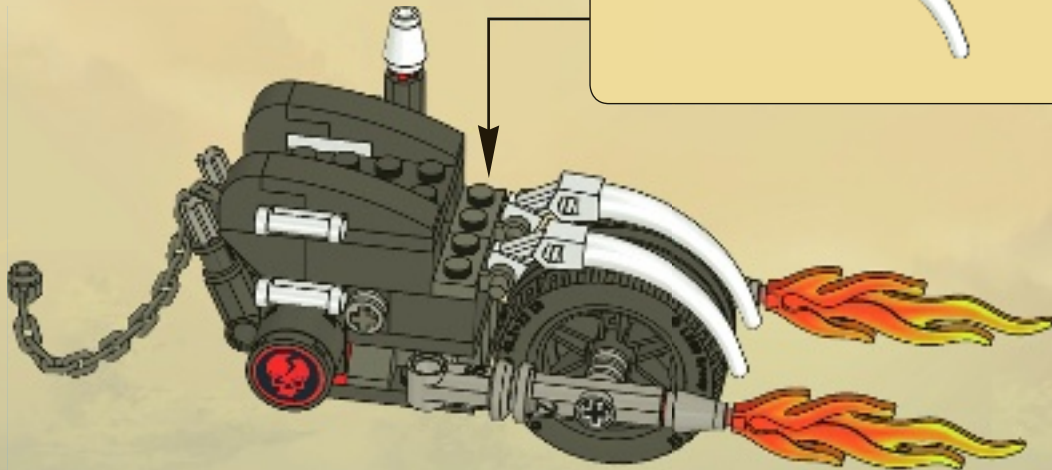
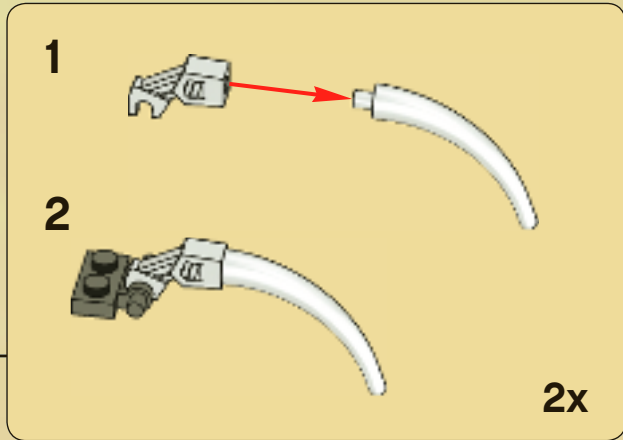



2x

25

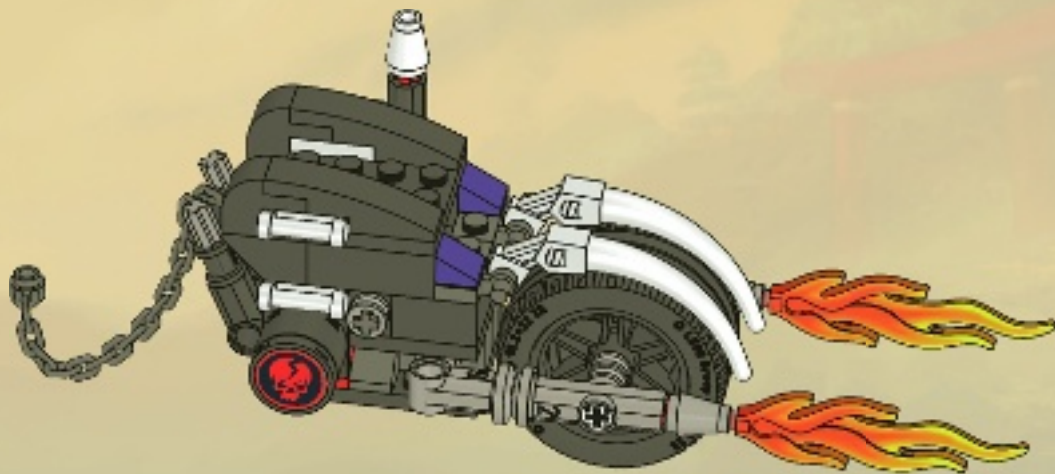



2x

# 26

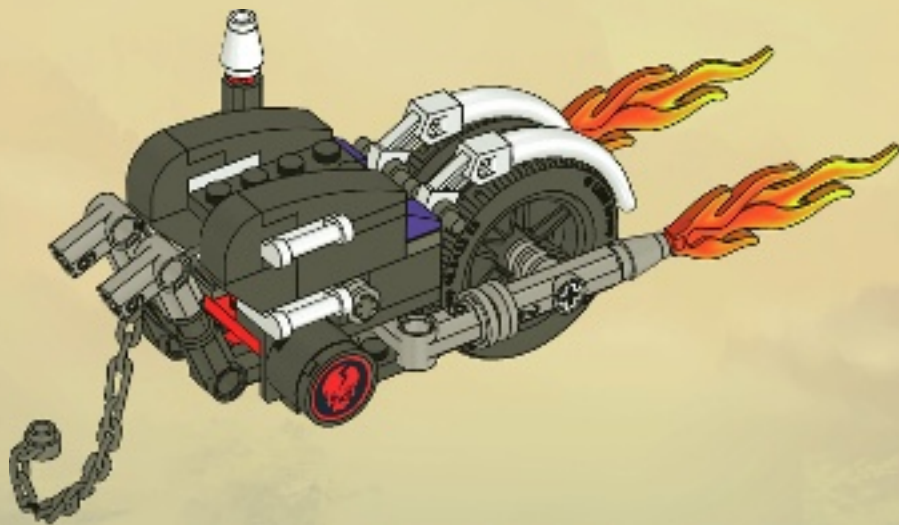



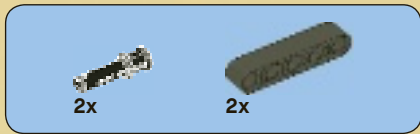

27

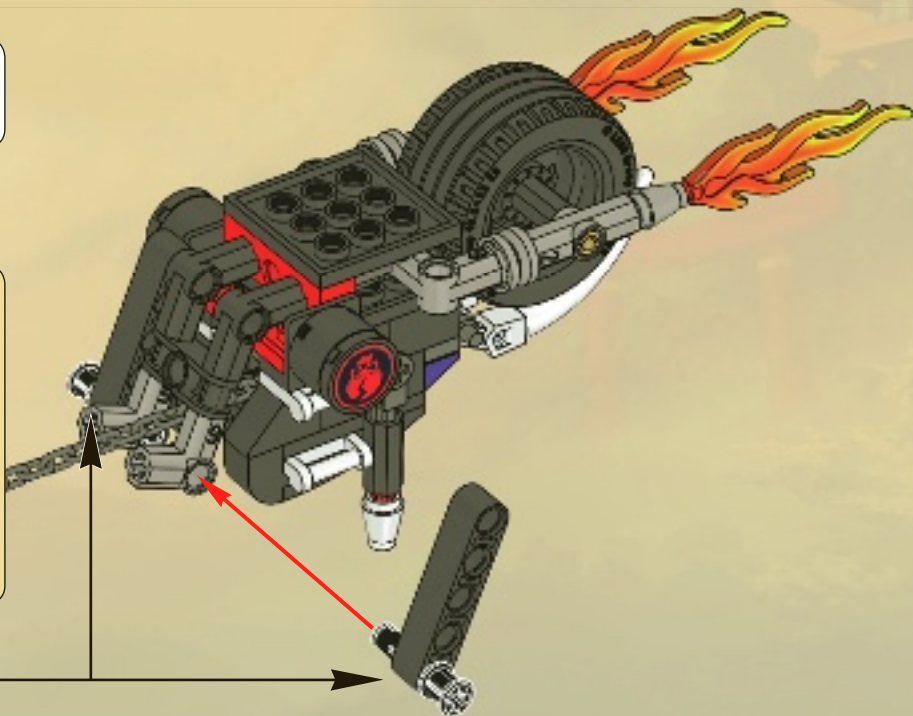
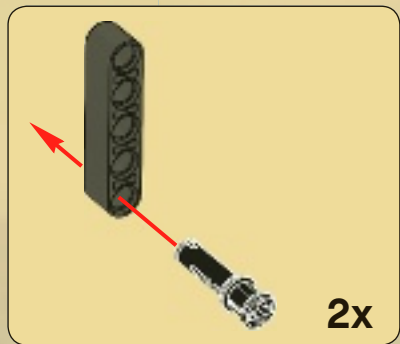



# 28

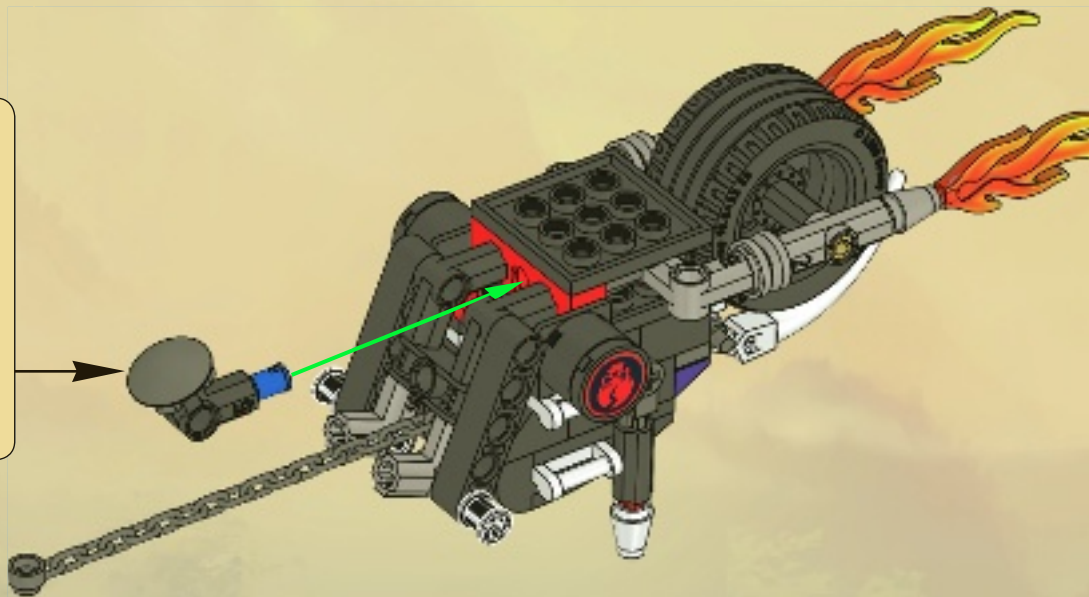
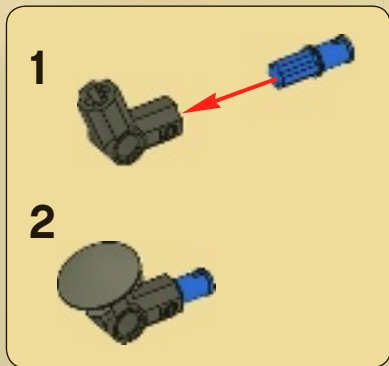

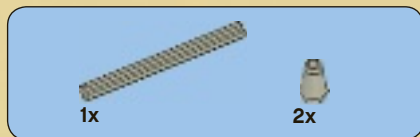

29

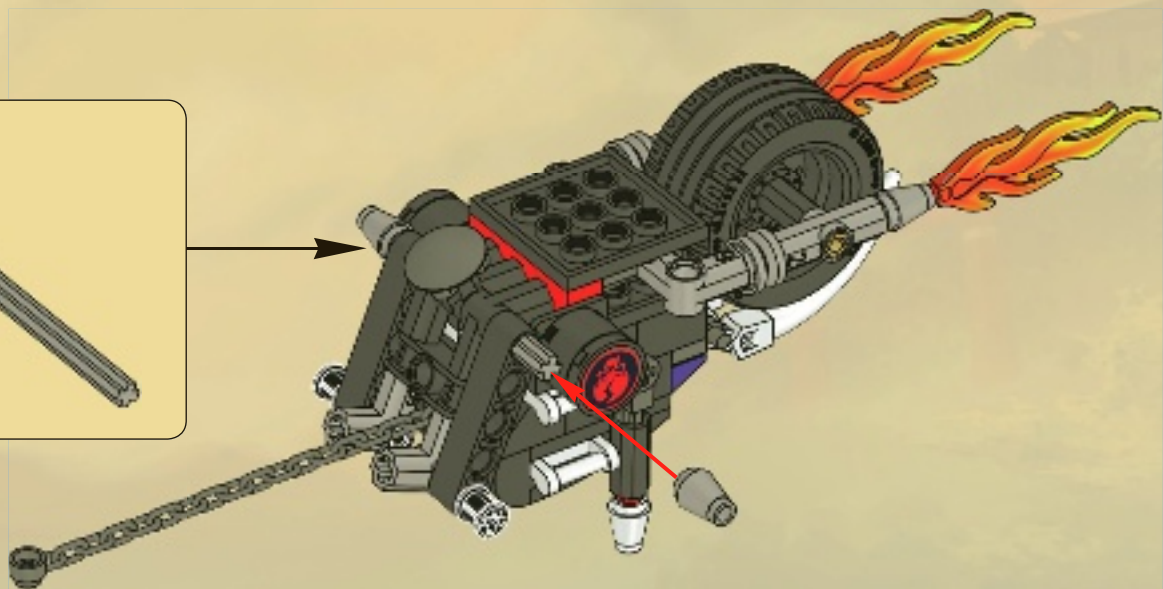
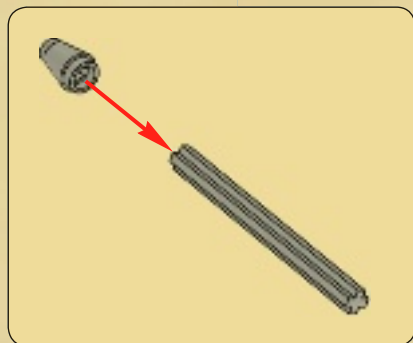

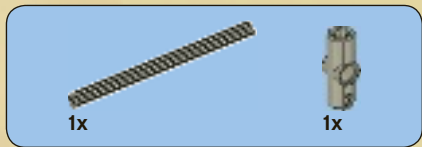

1

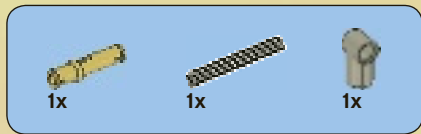

2

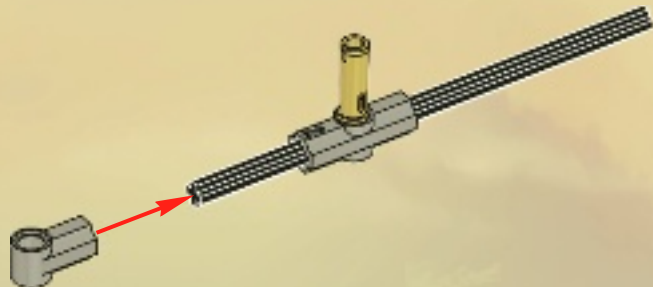

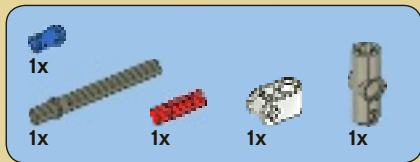

3

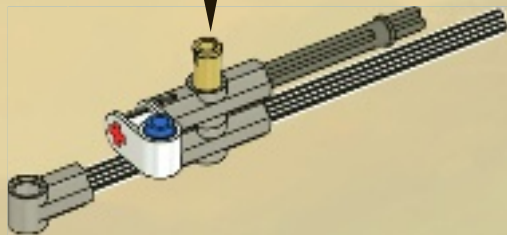
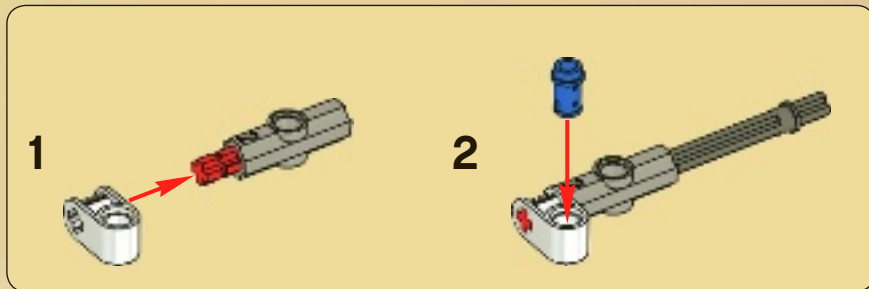



4



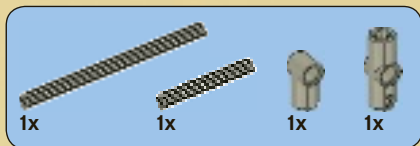

5

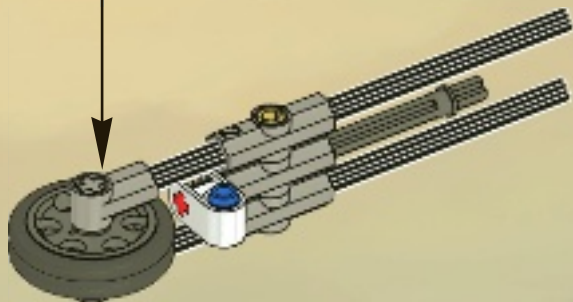
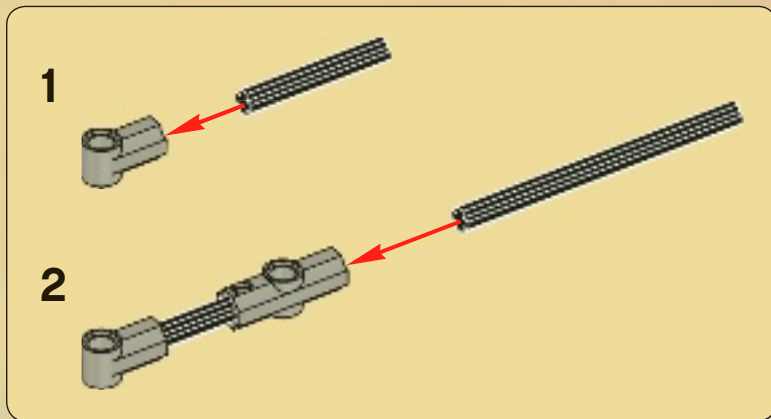

6

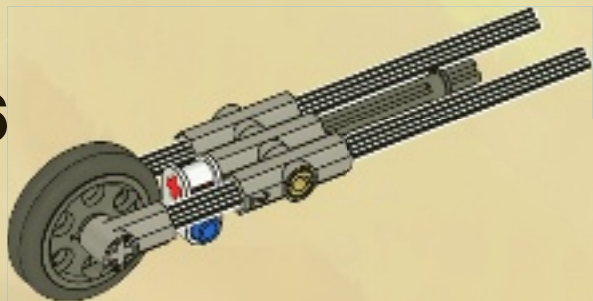

30

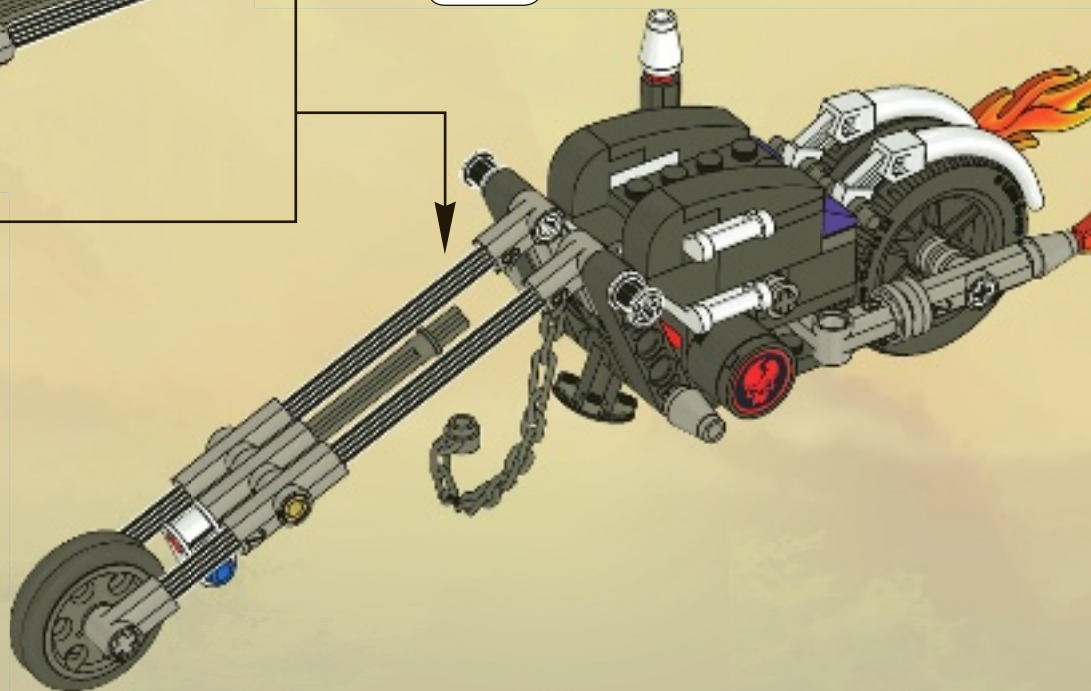



31

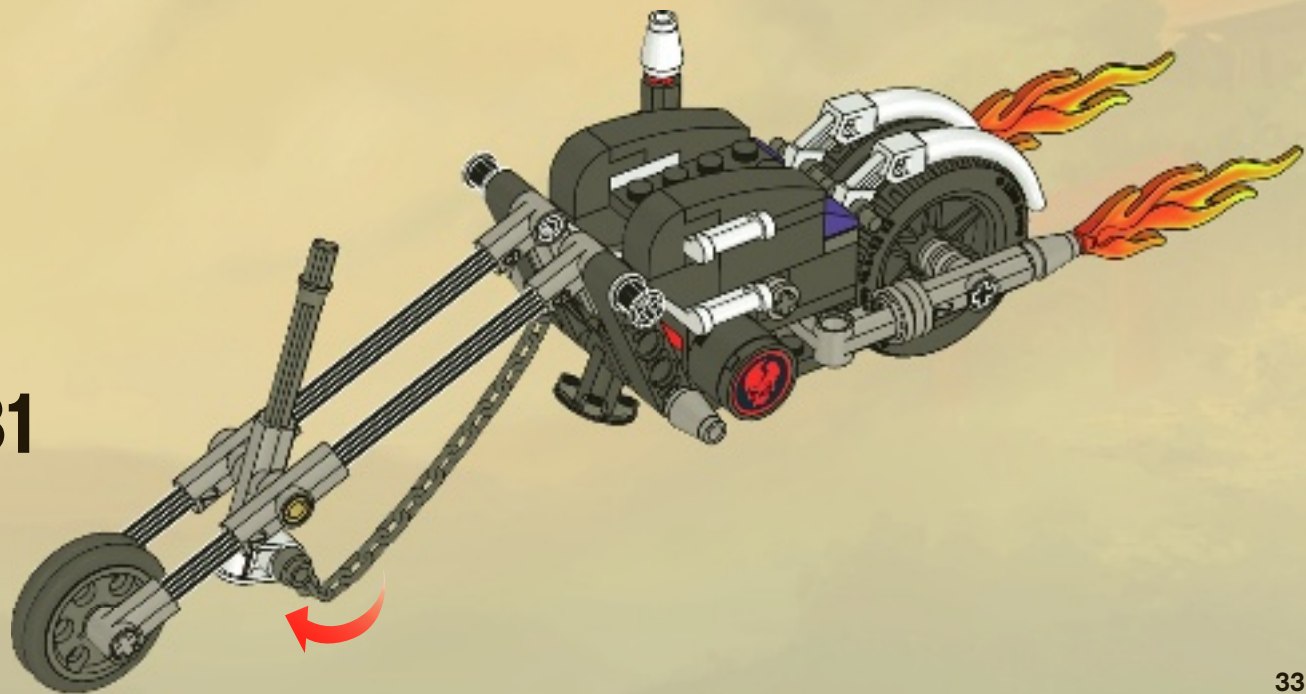



1x



1x

# 32



34



2x



2x



2x

# 33

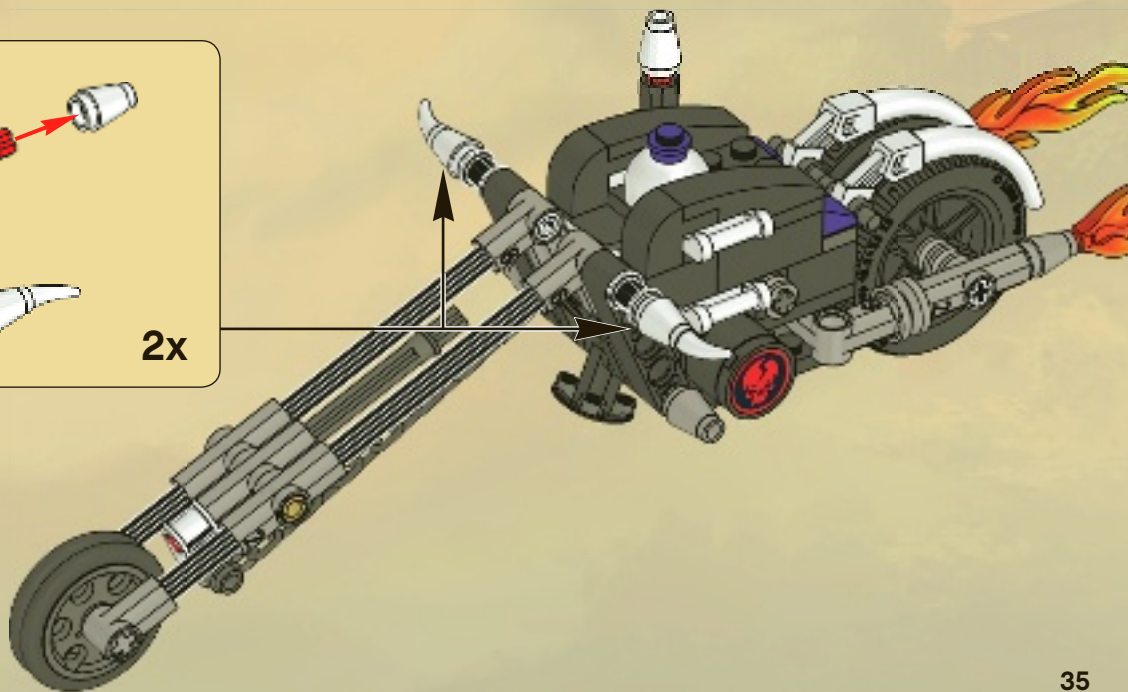
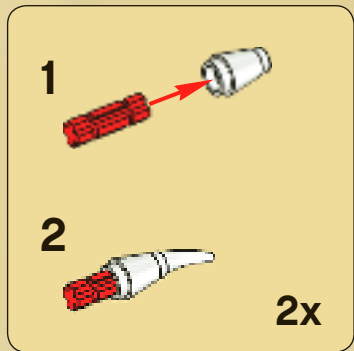



1x

1

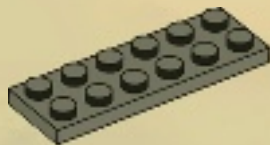

1x



1x

2





1x



1x

3



2x

4





1x



1x

5



1x



1x

6

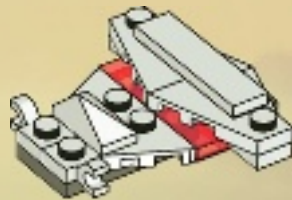



1x



2x

7

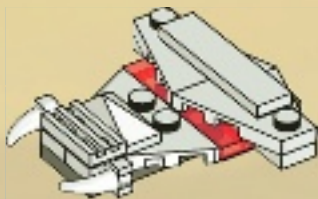

2x

8





9

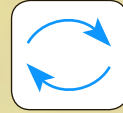
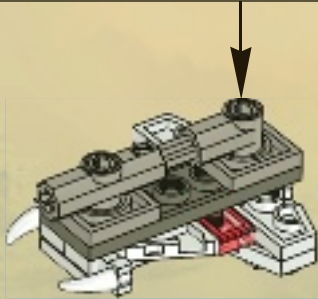
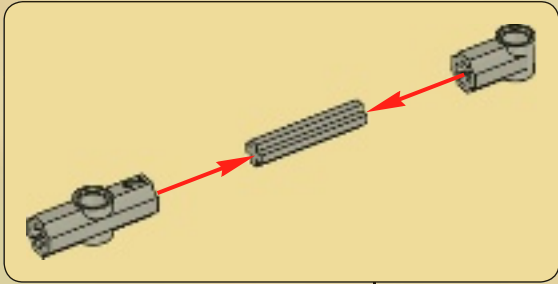

10

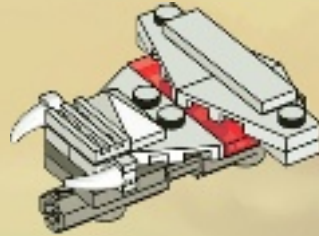



34

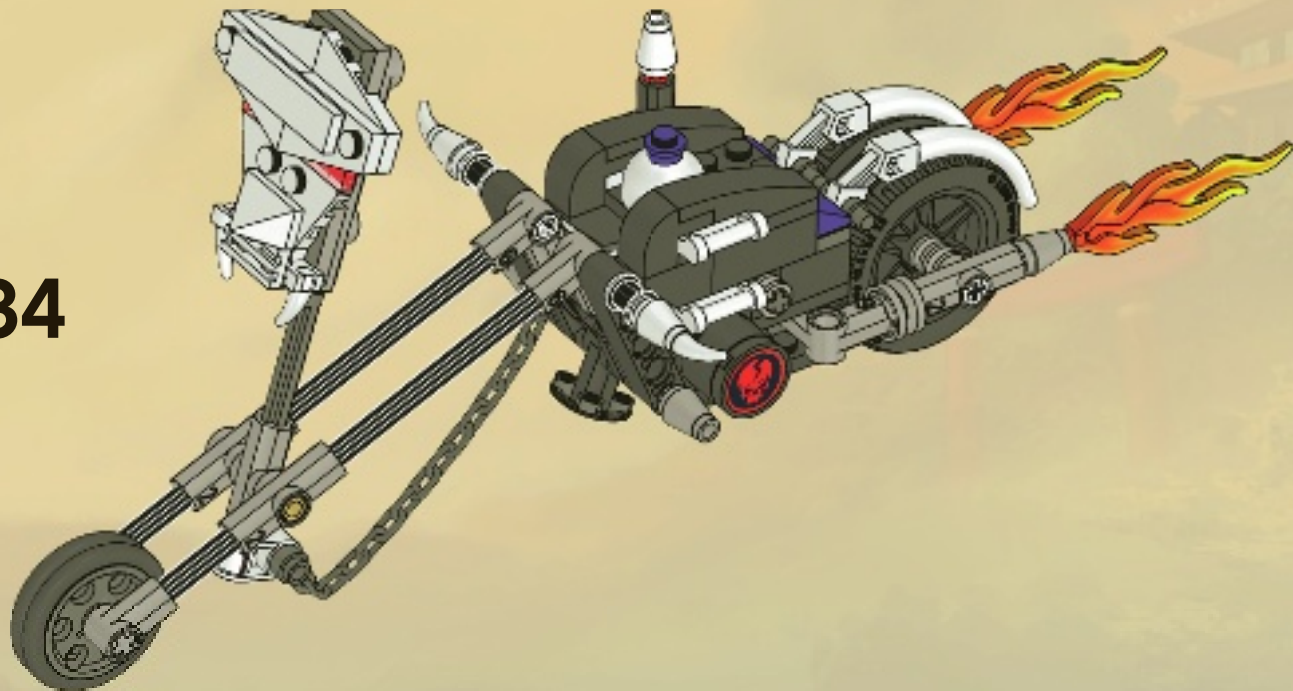

35





2x 235726	2x 4522034	1x 4184286	3x 4107084	1x 4610824	1x 241201	1x 4611434	1x 4186017	1x 4515183	4x 4529241
2x 362226	1x 4121667	1x 4299389	2x 4140801	2x 4143005	4x 4222017	4x 4568387	1x 4514554	1x 4278274	2x 4237084
2x 614326	2x 4277932	1x 4299389	4x 370526	3x 4206482	2x 4179874	1x 4600307	2x 4210935	2x 4587275	3x 4211573
2x 654126	2x 415026	2x 4142135	2x 370726	1x 4612323	2x 4179875	2x 4508454	1x 4540386	1x 4210665	3x 4211550
2x 366526	1x 4614391	2x 281526	1x 4614488	1x 4612649	1x 4179875	1x 4173670	2x 4211135	1x 4210665	6x 4211567
2x 609126	1x 4114206	3x 4243819	1x 4611427	3x 4518400	1x 4249506	1x 370121	2x 4210660	2x 4600271	2x 4211758
	2x 4512363		1x 4611427	1x 4216652	2x 4609295	1x 302021	1x 4210660	1x 4600501	2x 4211758
			2x 4567509	2x 4191825	2x 4602970	1x 4227155	1x 4211002	2x 4548009	4x 4509886
			1x 4566522	1x 4191825	2x 4622904	6x 4142865	2x 4508553	2x 4548009	6x 4211815
				2x 4191825	1x 243101	1x 4142865	1x 4516456	1x 4590990	6x 4211805
				1x 4191825	2x 4538353	1x 4594655			

Customer Service

Kundenservice

Service Consommateurs

Servicio Al Consumidor

[www.lego.com/service](http://www.lego.com/service) or dial



00800 5346 5555 :



1-800-422-5346 :



LEGO

NINJAGO  
Masters of Spinjitzu



2263



2260







[www.LEGOclub.com](http://www.LEGOclub.com)



LEGO® Club Email



LEGO® Club Magazine

SIGN UP ONLINE!

[www.LEGOclub.com](http://www.LEGOclub.com)

**LEGO club**

**FREE! GRATIS! GRATUIT!**



00800 5346 5555\*



1-866-534-6258 • 1-877-518-5346

US & Canada only

Canada seulement

- \* Freephone. Mobile charges may apply.
- \* Numéro sans frais. Des frais peuvent s'appliquer avec les téléphones cellulaires.
- \* Gebührenfrei. Kosten für Anrufe aus Mobilfunknetzen können abweichen.
- \* Gratis telefoonnummer vanaf vaste lijn.
- \* Det er et gratis nummer, når du ringer fra fasttelefon.
- \* Det är gratis, när du ringer från en fast telefon.
- \* Numéro sans frais. Des frais peuvent s'appliquer avec les téléphones portables.



↑ [www.LEGO.com](http://www.LEGO.com)

# WIN!

Go to [www.LEGOsurvey.com/product](http://www.LEGOsurvey.com/product) to fill out a survey for a chance to win a cool LEGO® Product.

No purchase necessary.

Open to all residents where not prohibited.



## [www.LEGOsurvey.com/product](http://www.LEGOsurvey.com/product)

### GEWINNE!

Nimm an der Umfrage auf [www.LEGOsurvey.com/product](http://www.LEGOsurvey.com/product) teil und hab die Chance ein cooles LEGO® Produkt zu gewinnen!

Die Teilnahme am Gewinnspiel führt zu keinerlei Kaufverpflichtungen. Teilnahme in allen nicht ausgeschlossenen Ländern möglich.

4625556

### WIN!

Ga naar [www.LEGOsurvey.com/product](http://www.LEGOsurvey.com/product), vul een enquêteformulier in en maak kans op een cool LEGO® product.

Geen aankoopverplichting. Iedereen mag deelnemen, uitgezonderd ingezetenden van landen waar een enquêteverbod geldt.

LEGO and the LEGO logo are trademarks of the LEGO Group. ©2011 The LEGO Group. ©2011 LucasFilm Ltd. & TM. All rights reserved.

### GAGNE!

Visite [www.LEGOsurvey.com/product](http://www.LEGOsurvey.com/product) pour répondre à un questionnaire et avoir une chance de gagner un produit LEGO® très cool!

Aucune obligation d'achat. Ouvert à tous les résidents des pays autorisés.

### 当てよう!

[www.LEGOsurvey.com/product](http://www.LEGOsurvey.com/product) にアクセスして、アンケートにご記入ください。当選者にはレゴ®製品を差し上げます。

お買い上げの必要はありません。禁止されていない限り、すべての皆様にご利用いただけます。