

LEGO

NINJAGO

Masters of Spinjitzu



2263





3



1x



1x

30

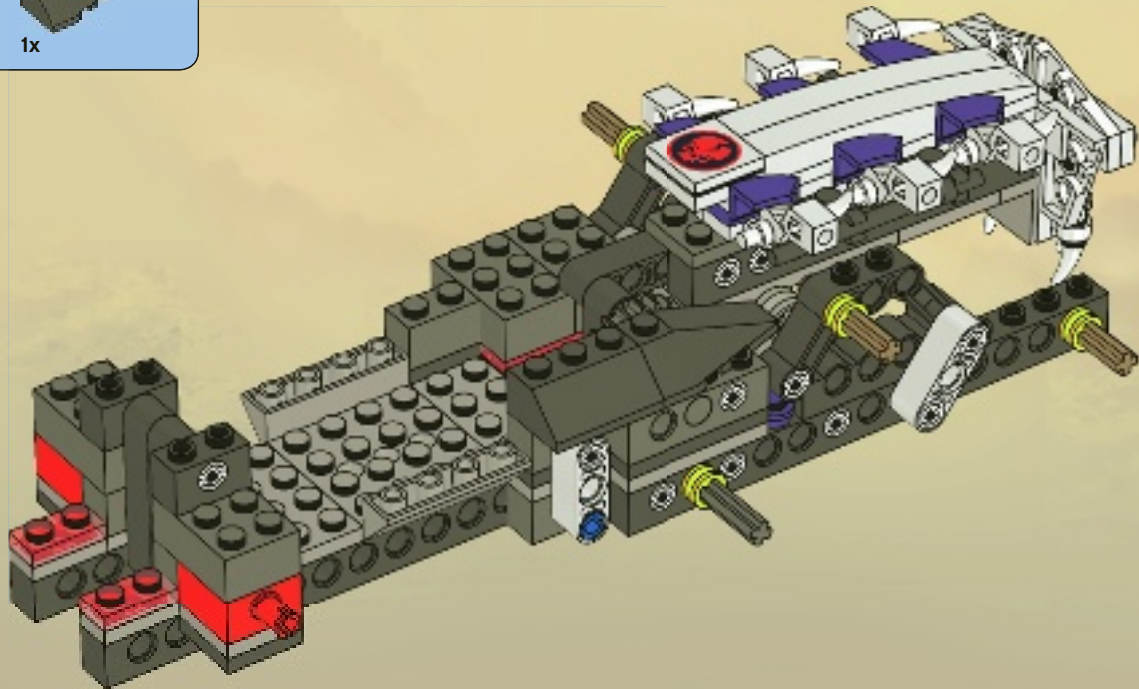

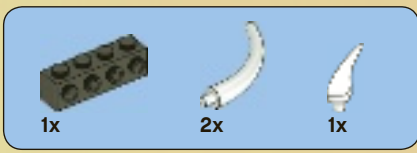

31

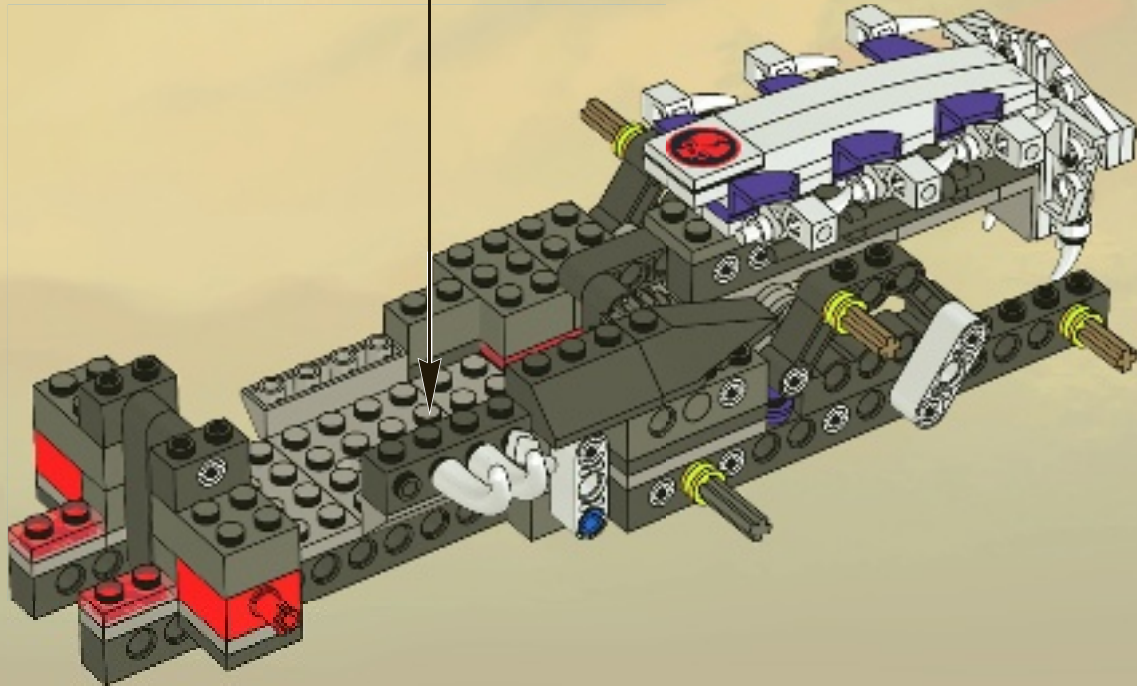



32

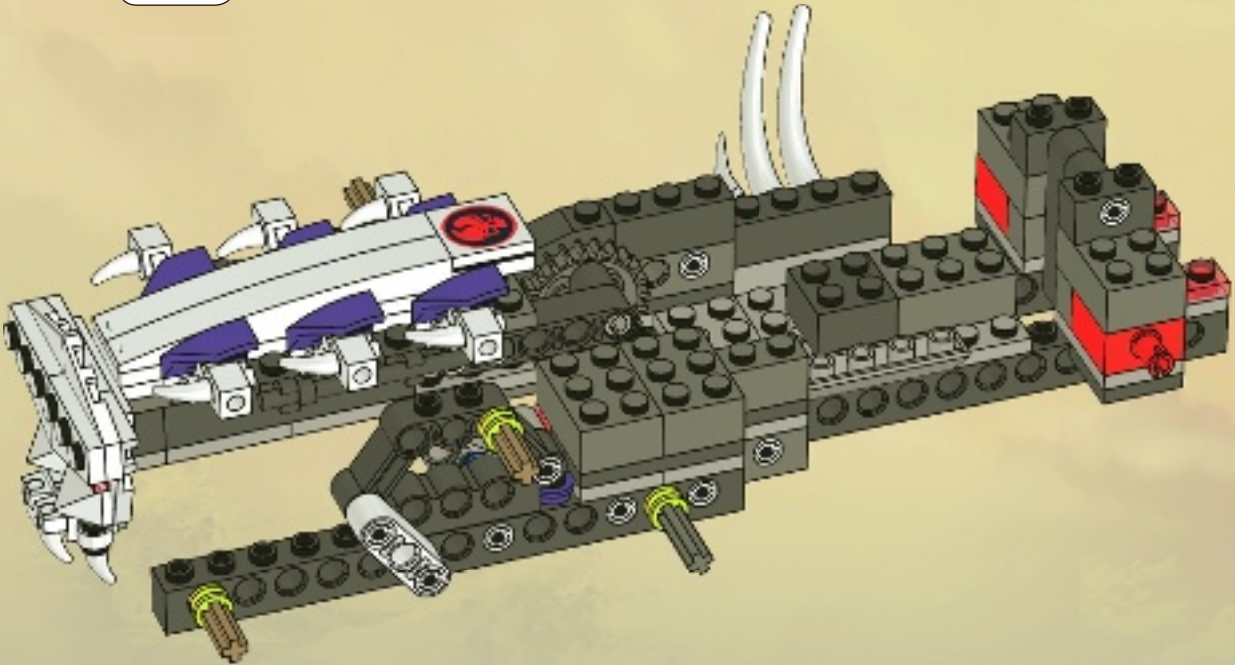

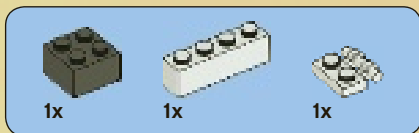

33

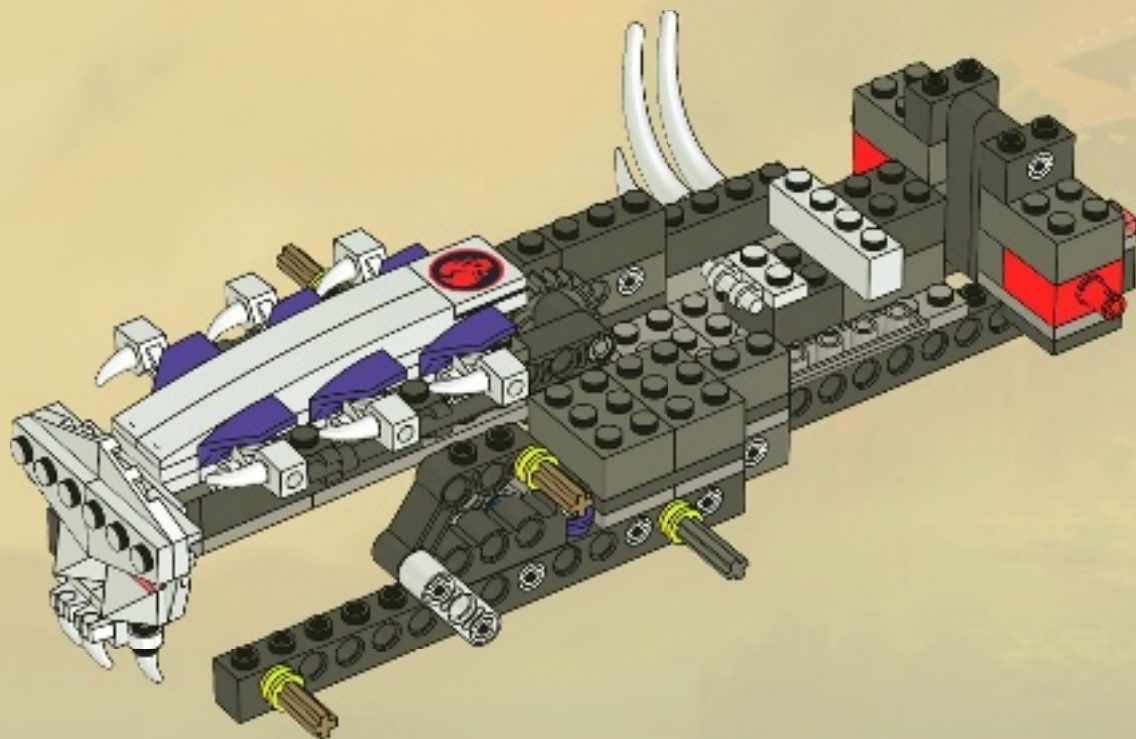

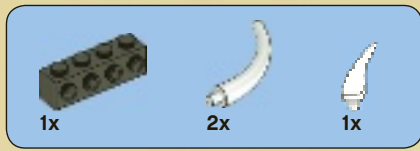

34

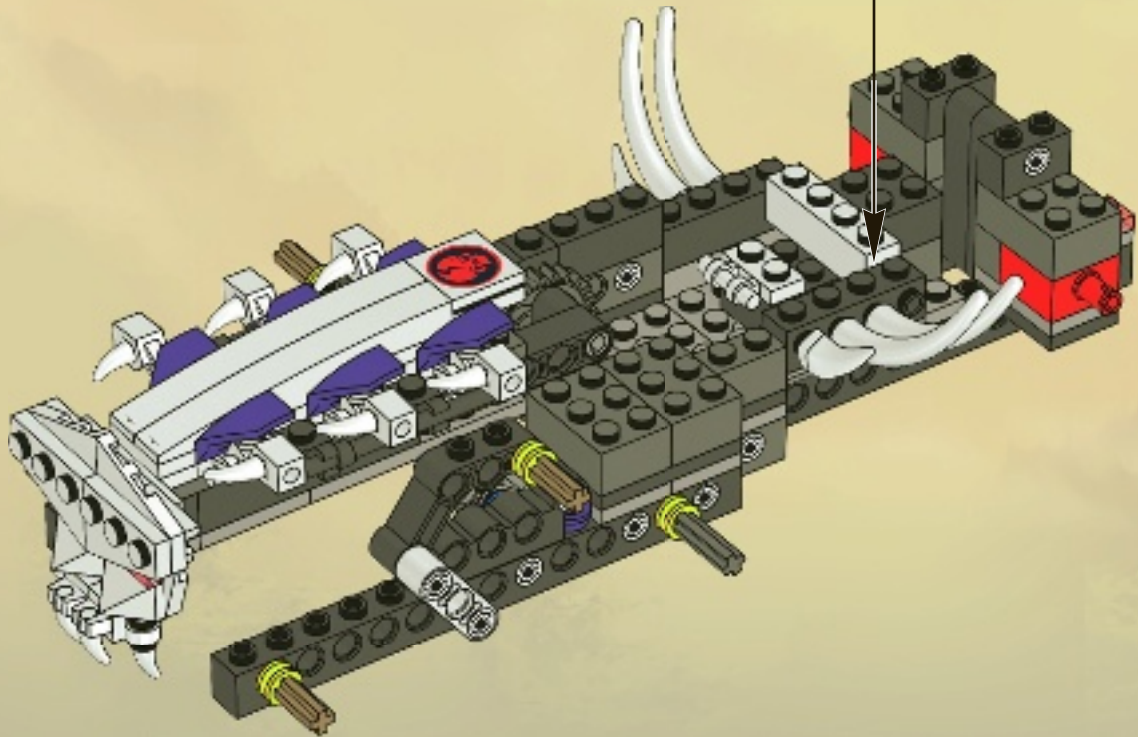
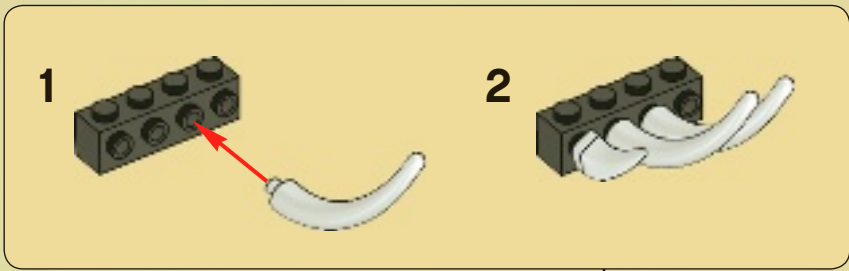



1x



1x

35

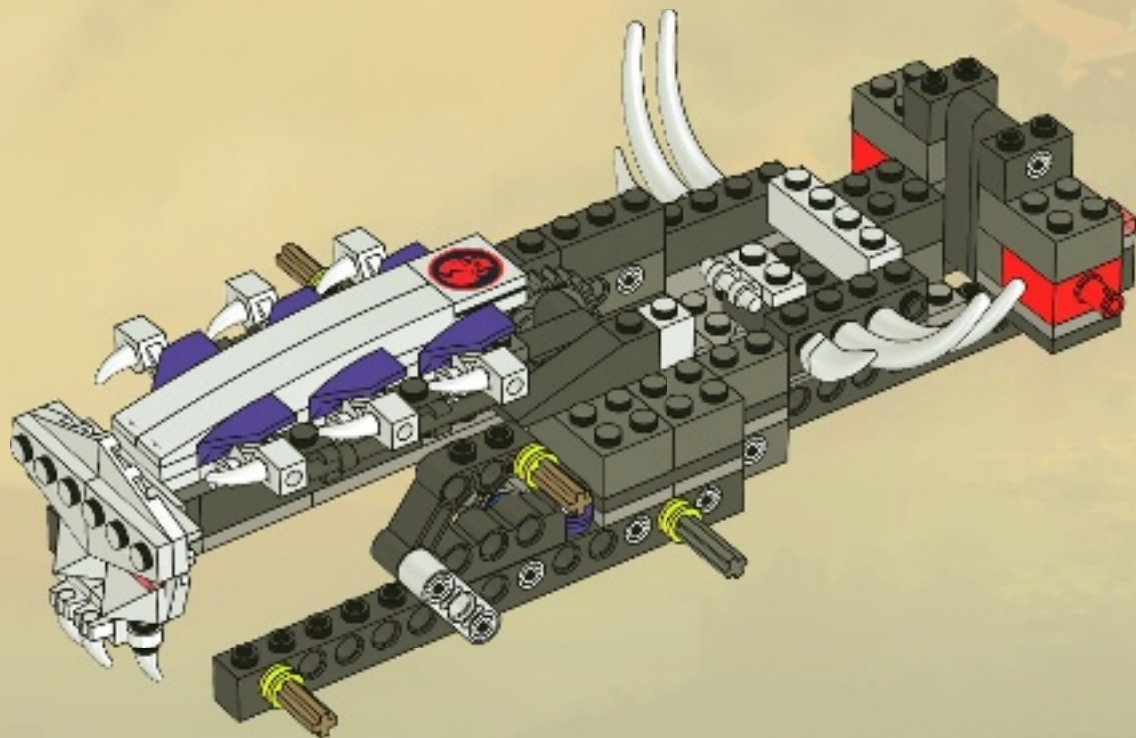

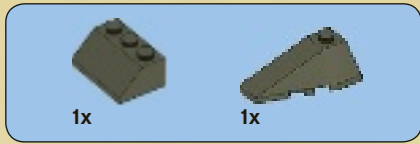

36

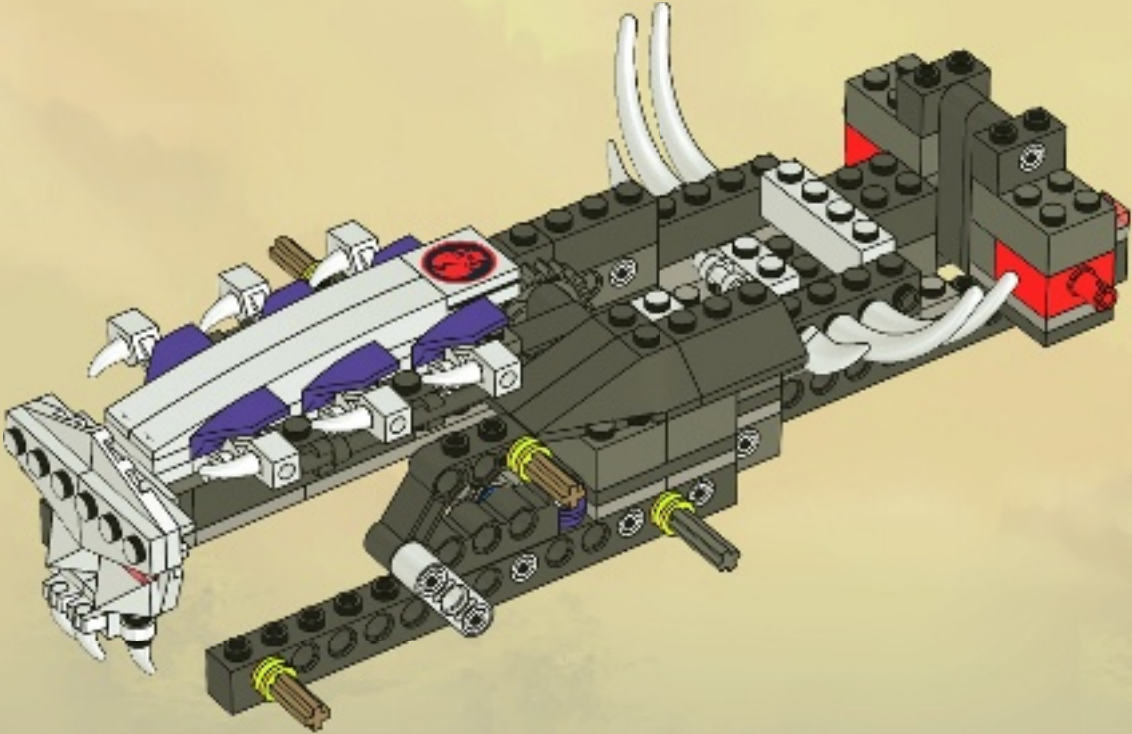

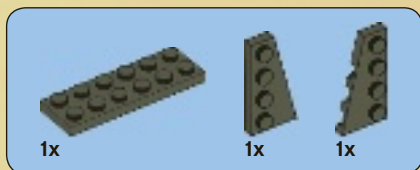

37

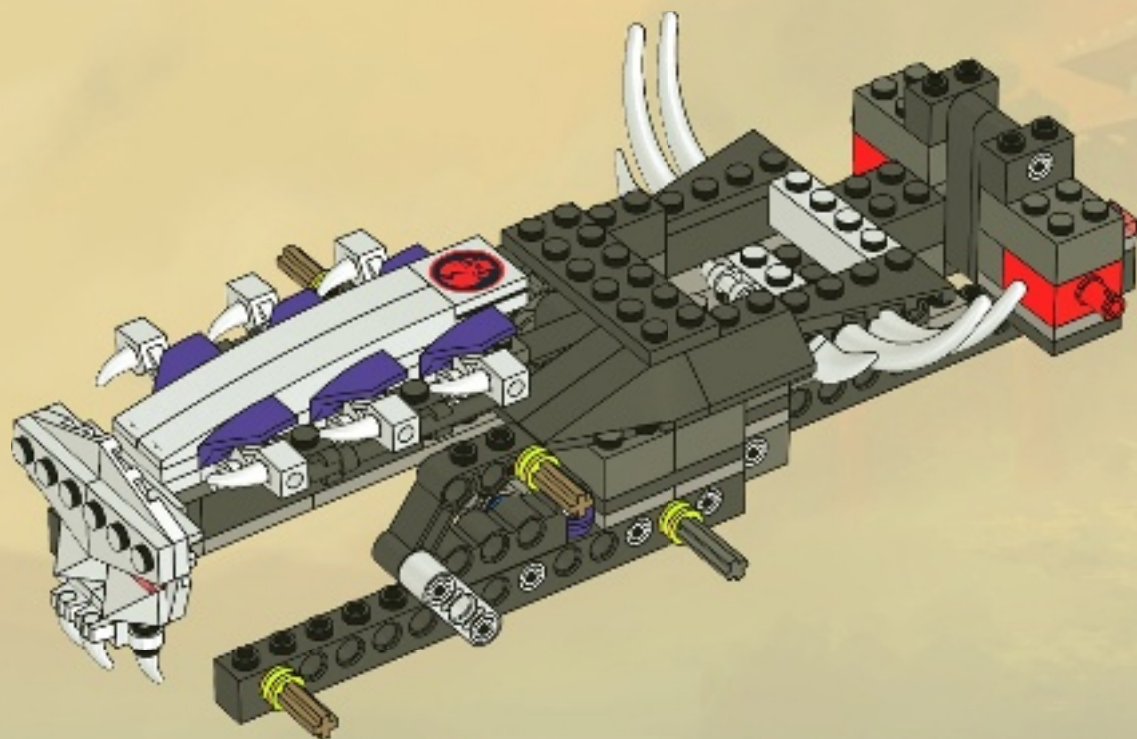



2x



2x

38

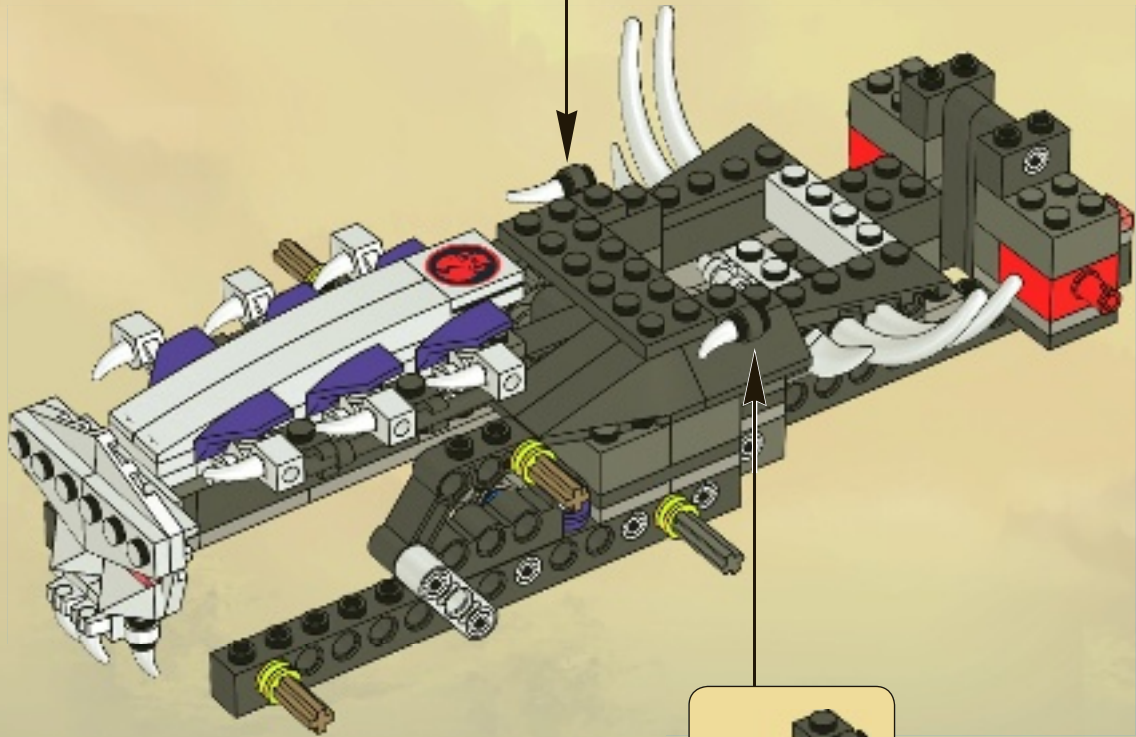
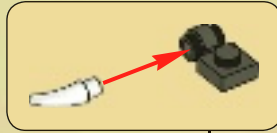



1x



1x

39

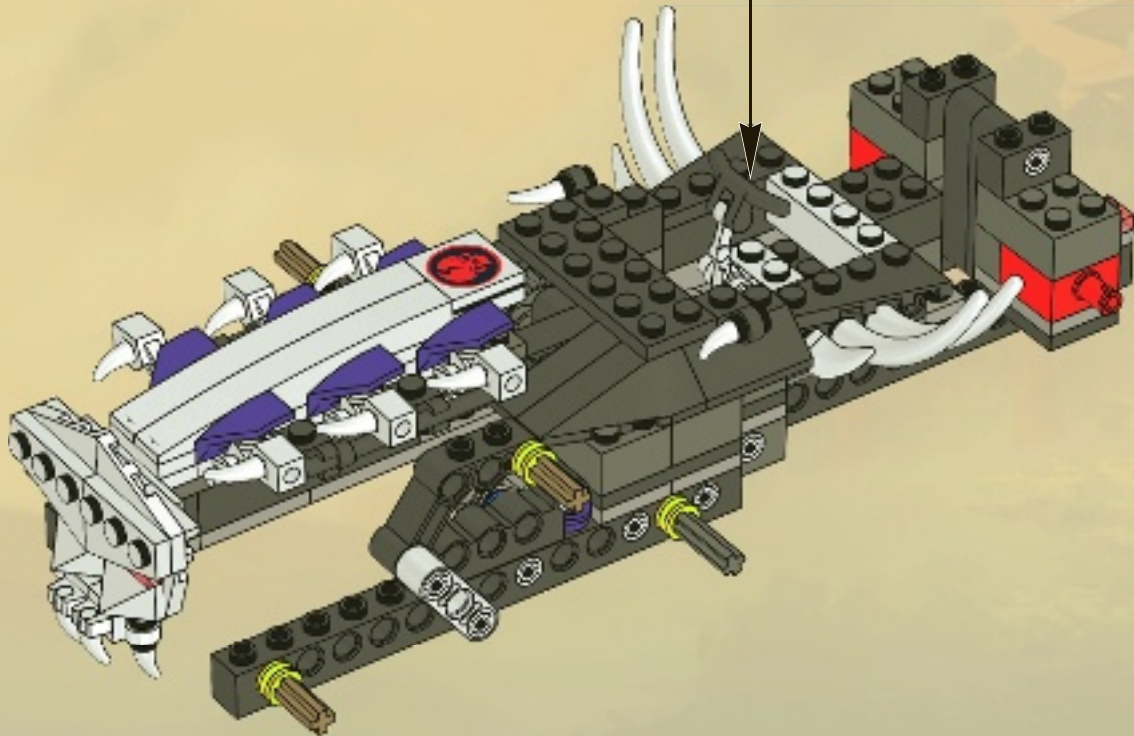
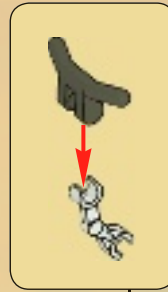



40

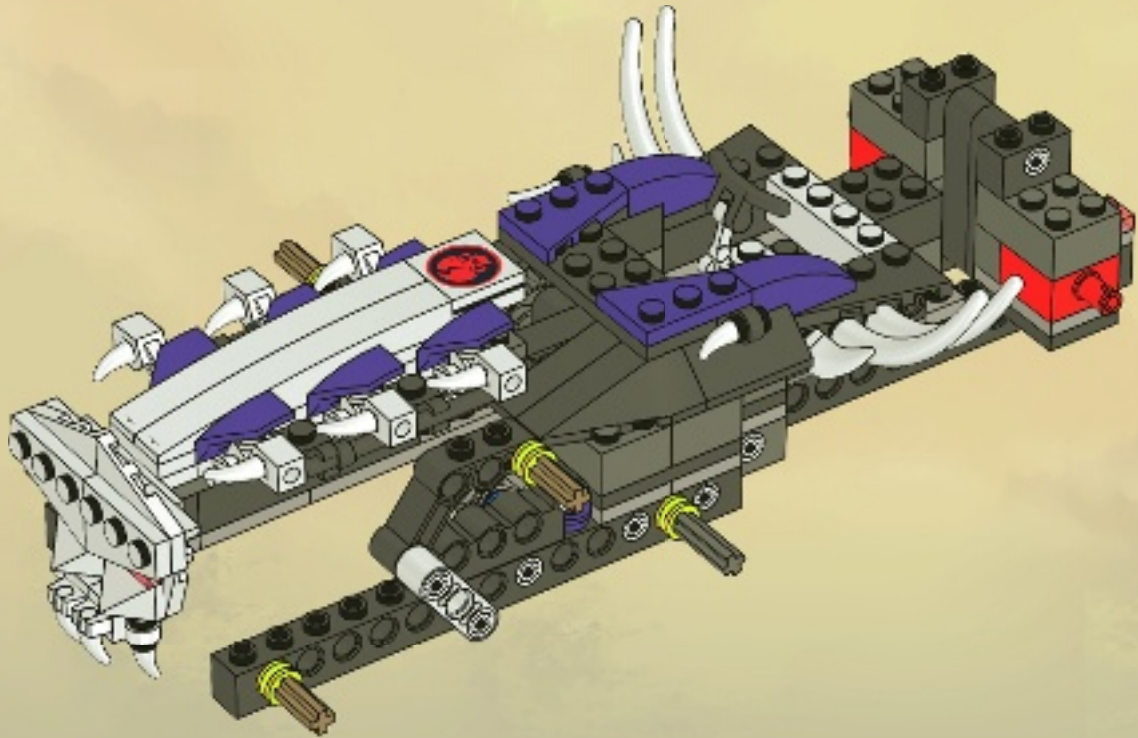



41

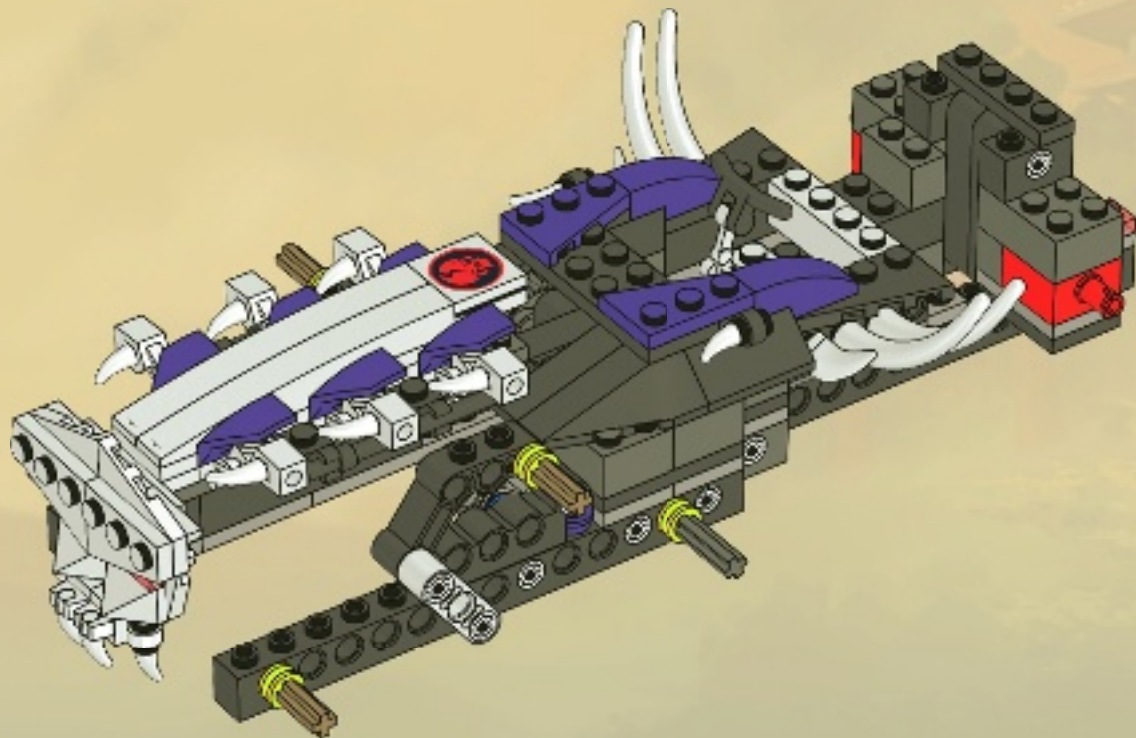



2x

42



2x

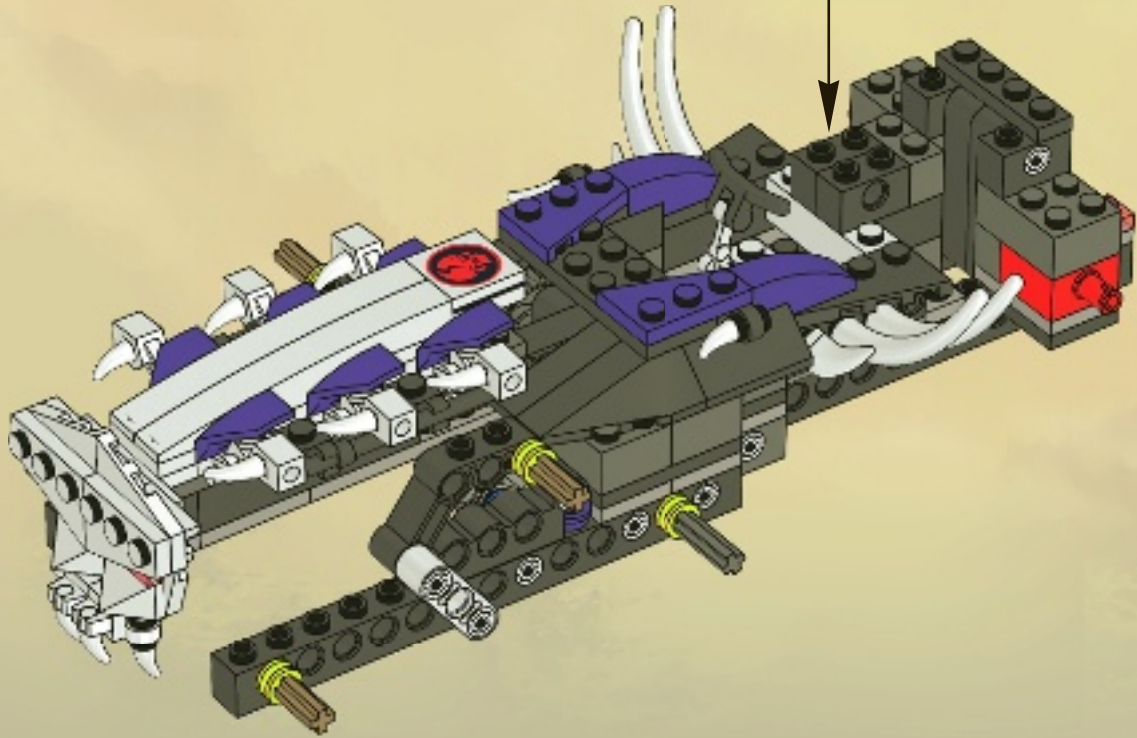

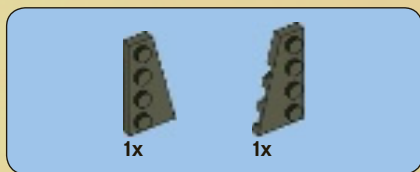

43

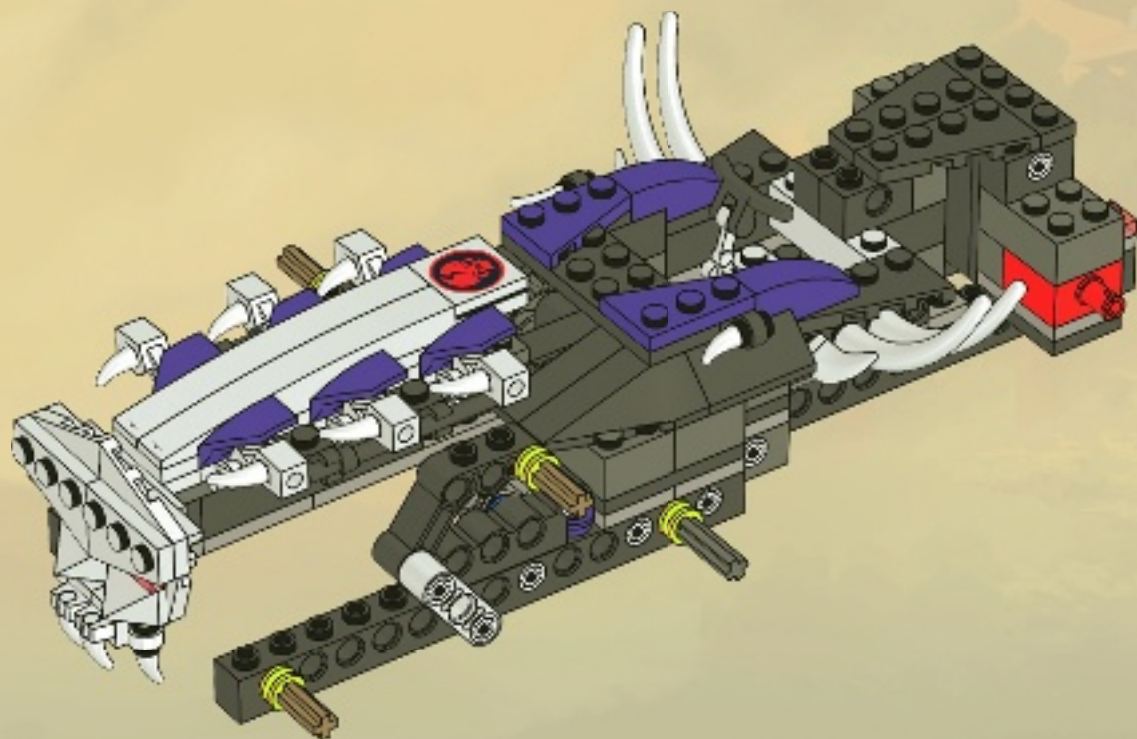

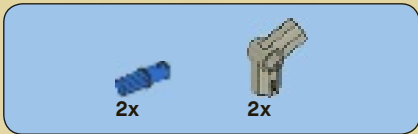

44

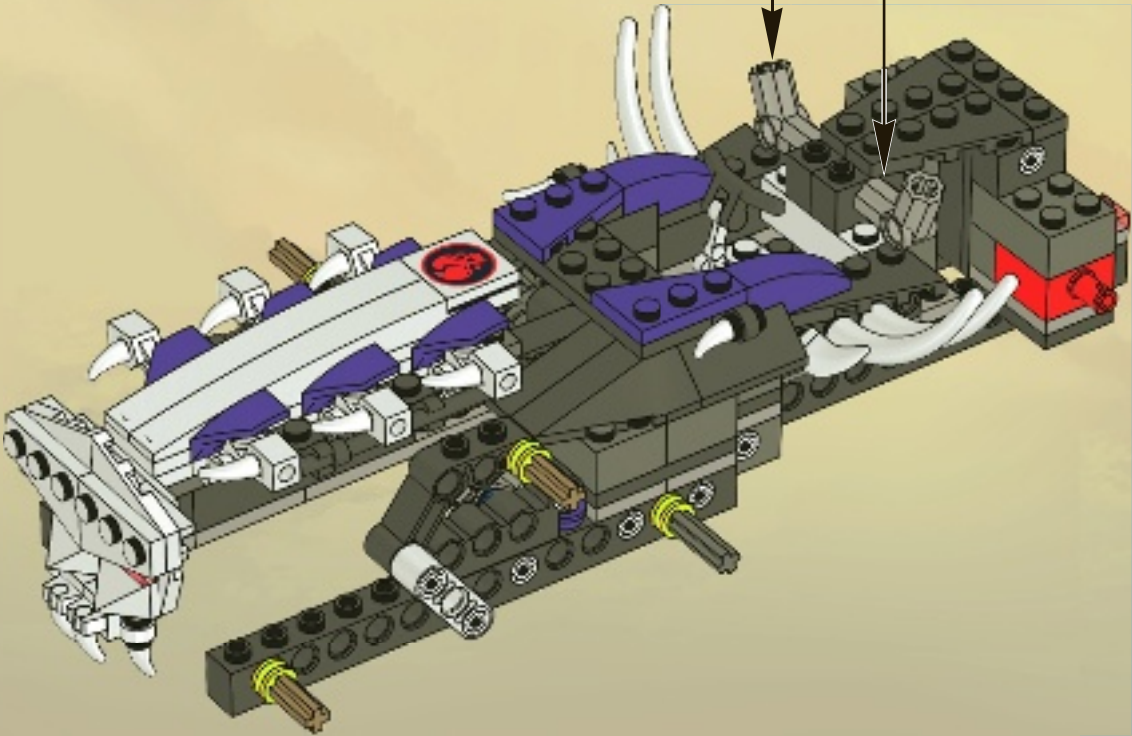
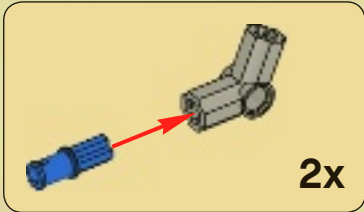

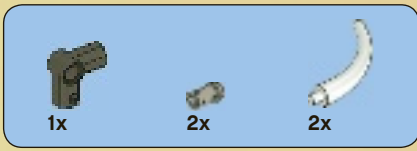

45

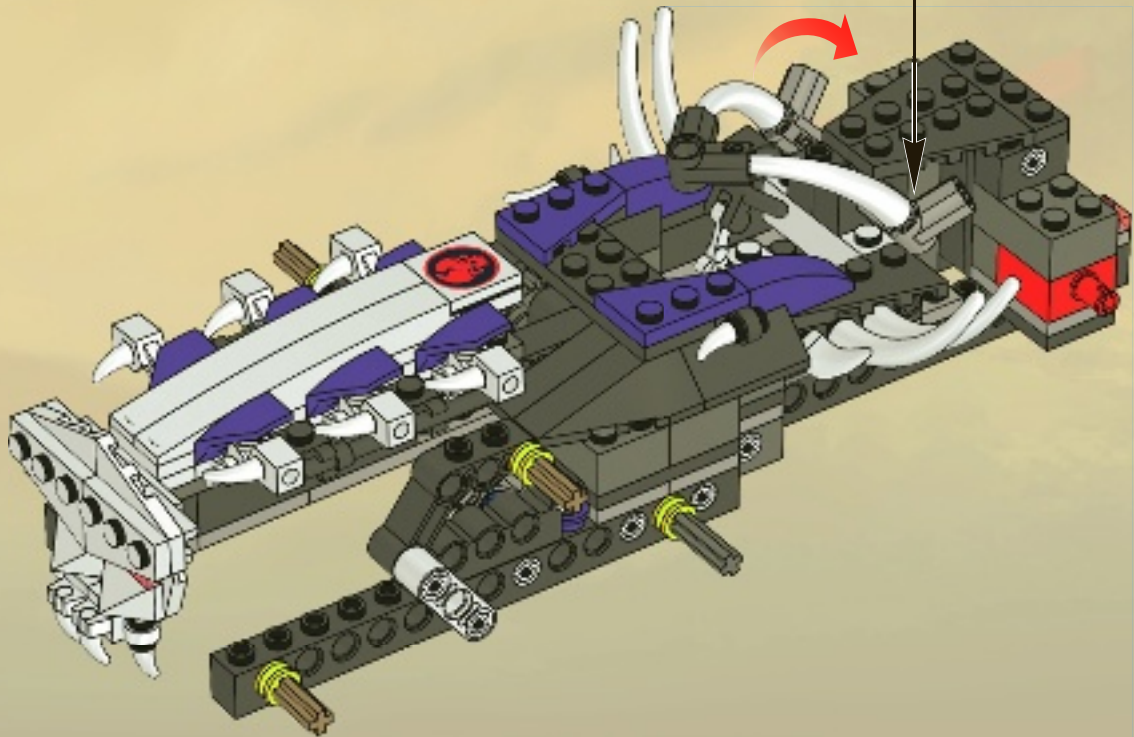
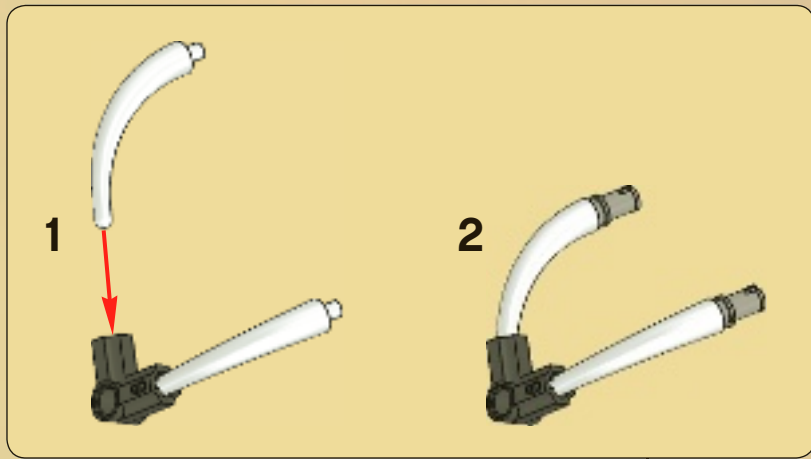



1x



1x

1

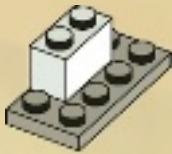

1x

2

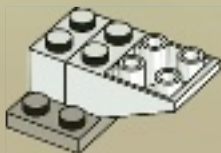

1x

3

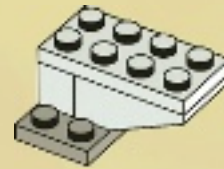

1x



1x

4

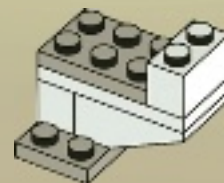



4x

5

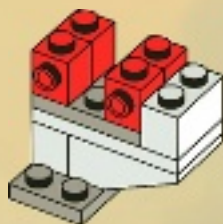

1x

6

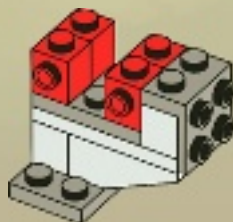

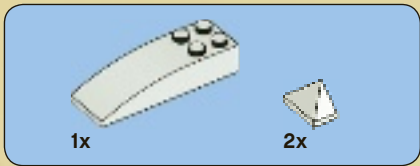

7

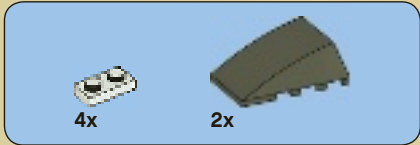
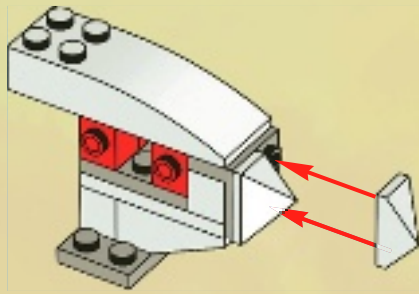

8

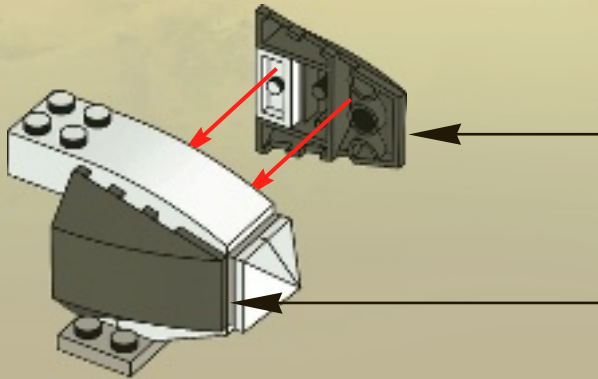
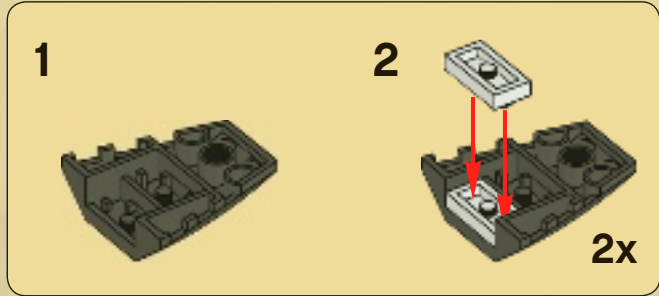

46

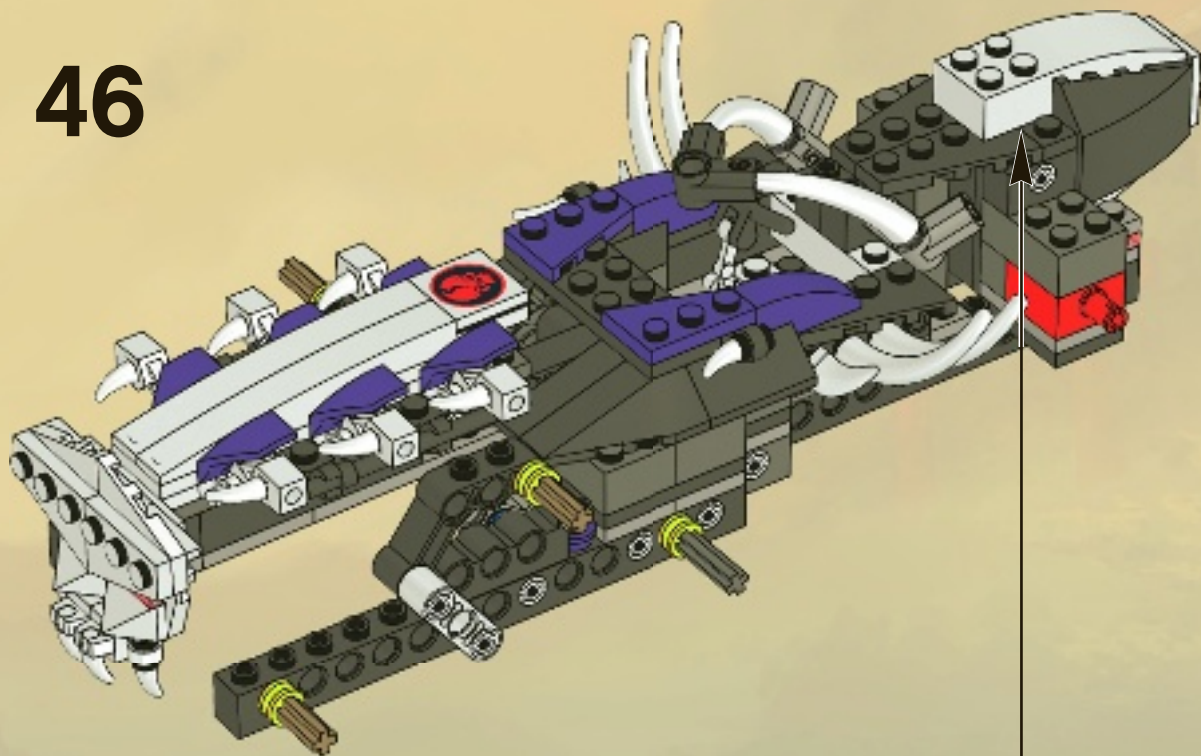



2x



2x

47

1



2



3

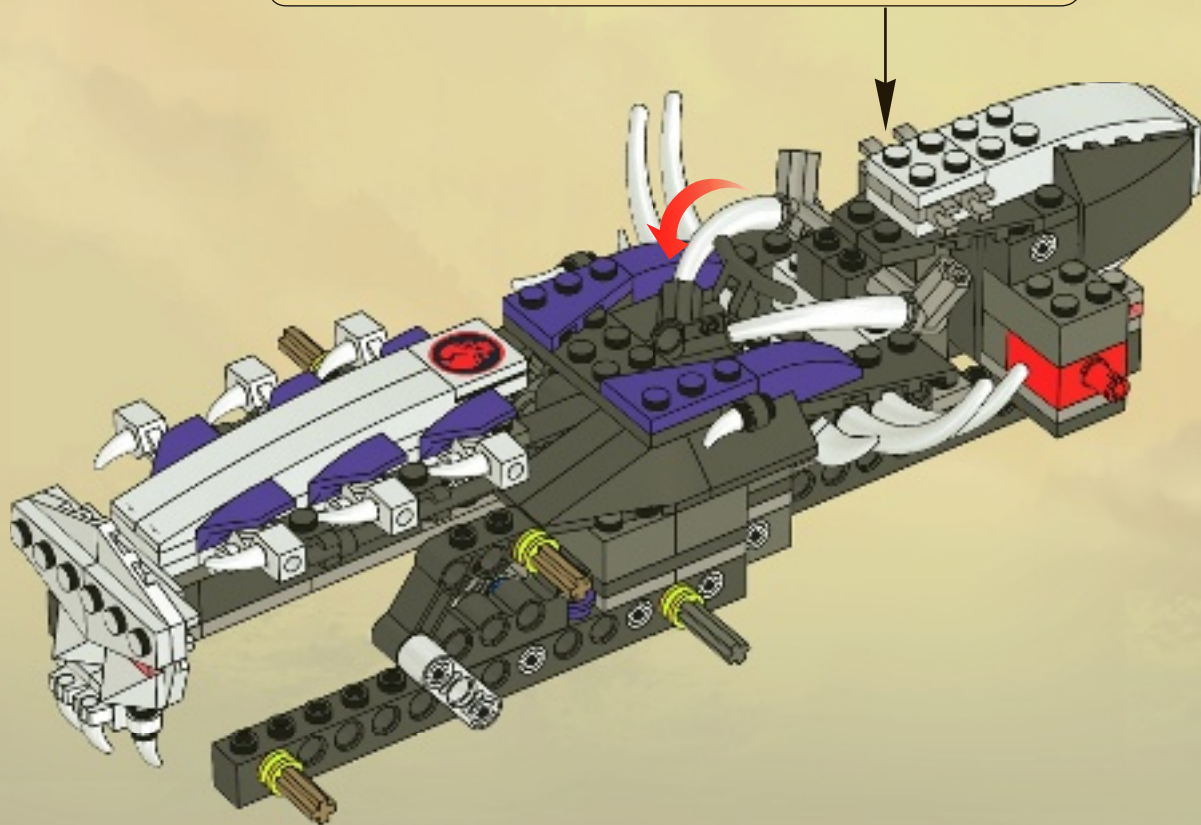
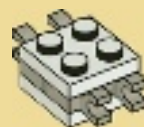



1x



2x

48

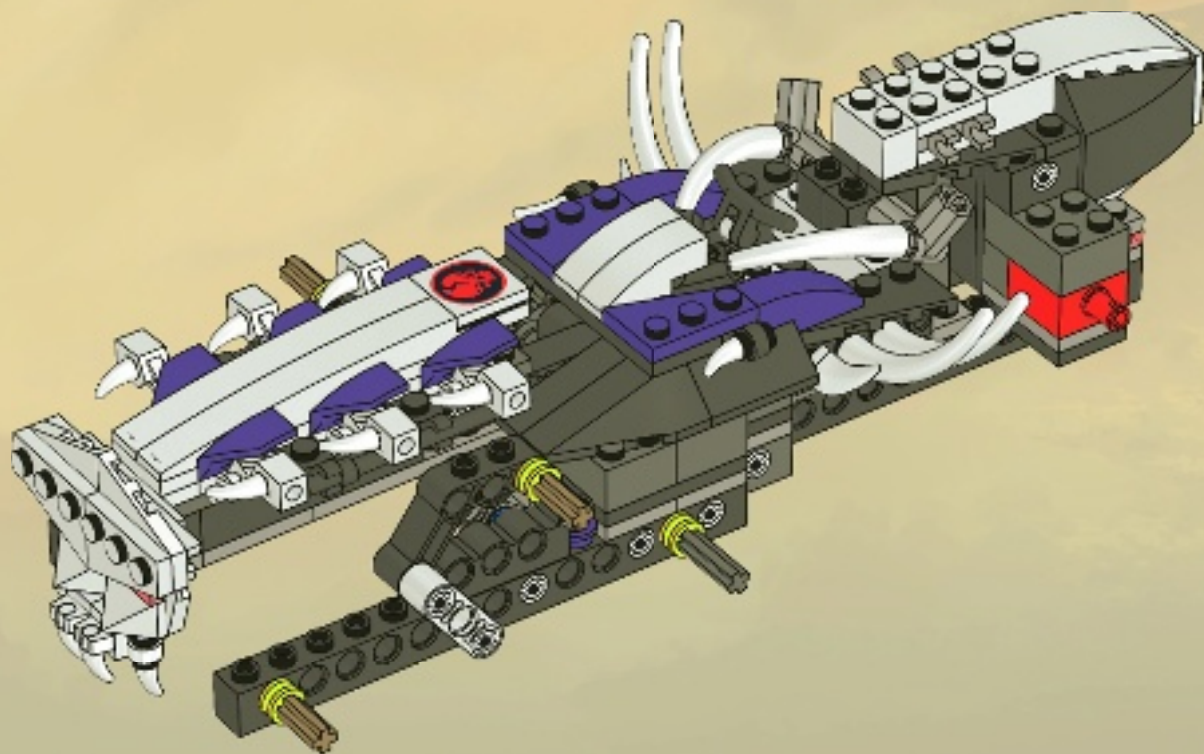



49

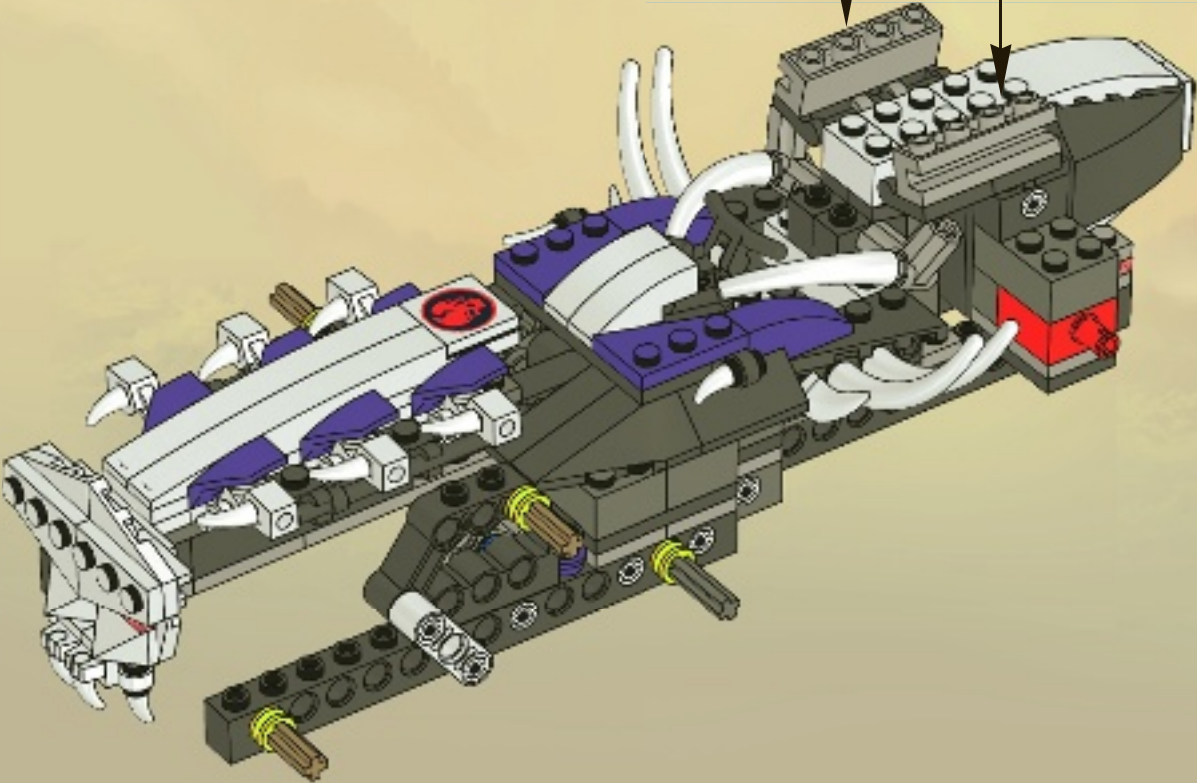
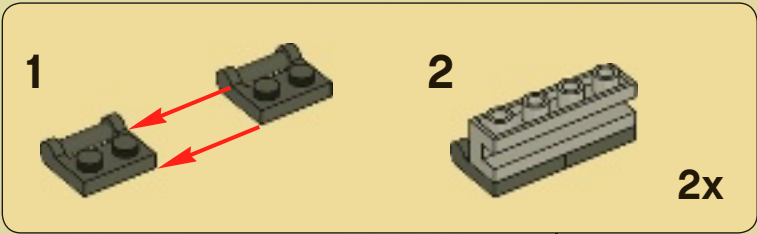

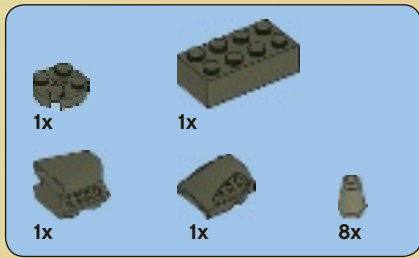

50

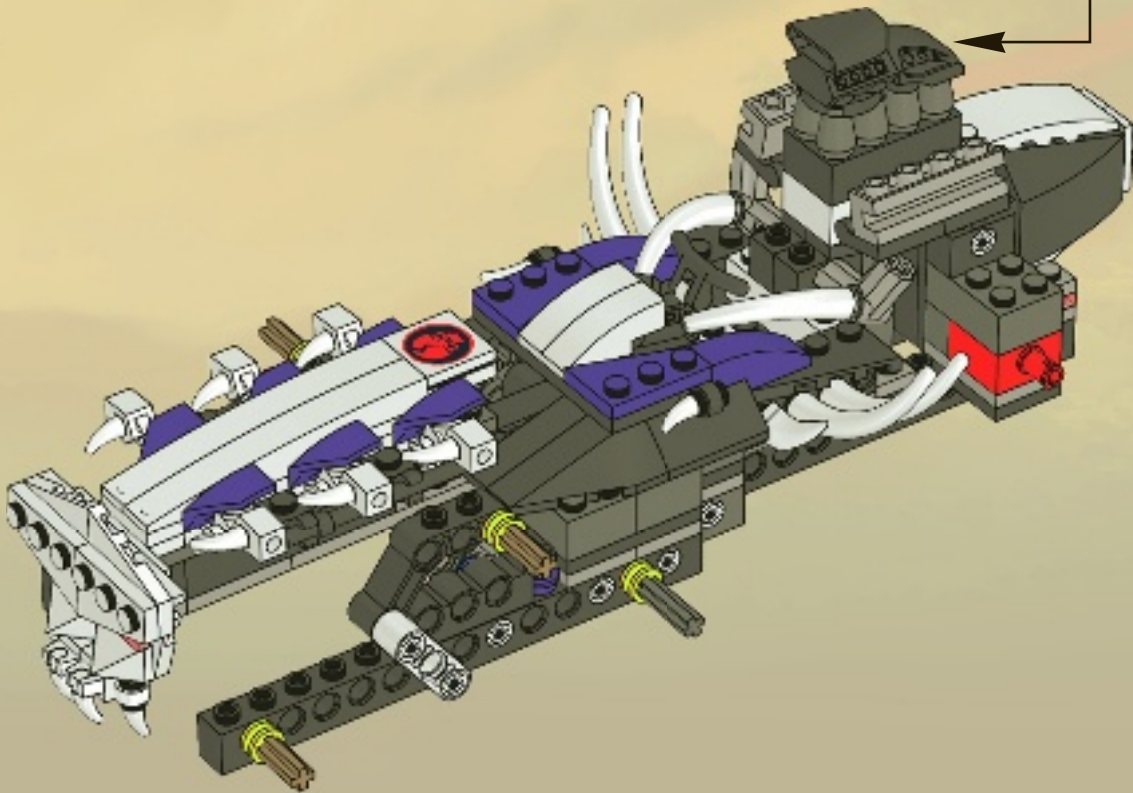
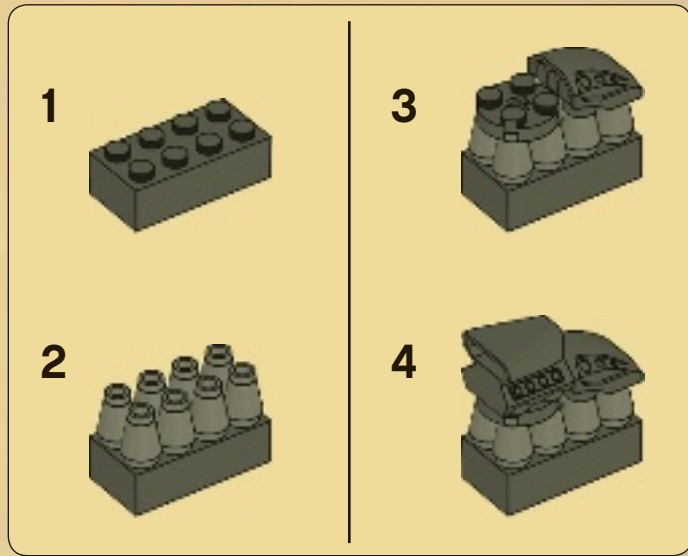



51

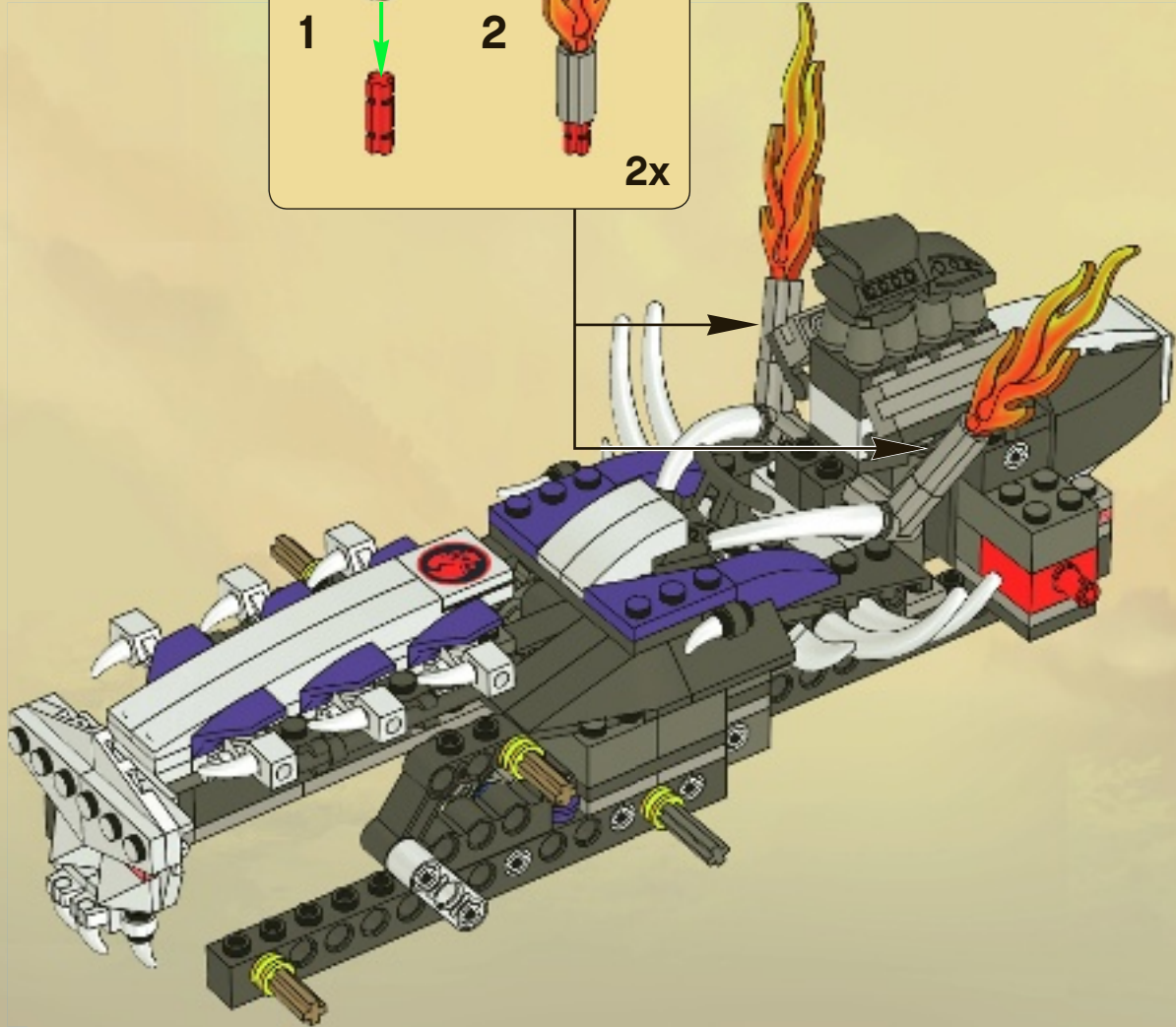
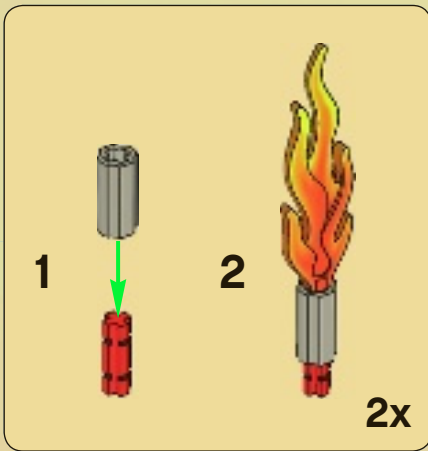



6x

52

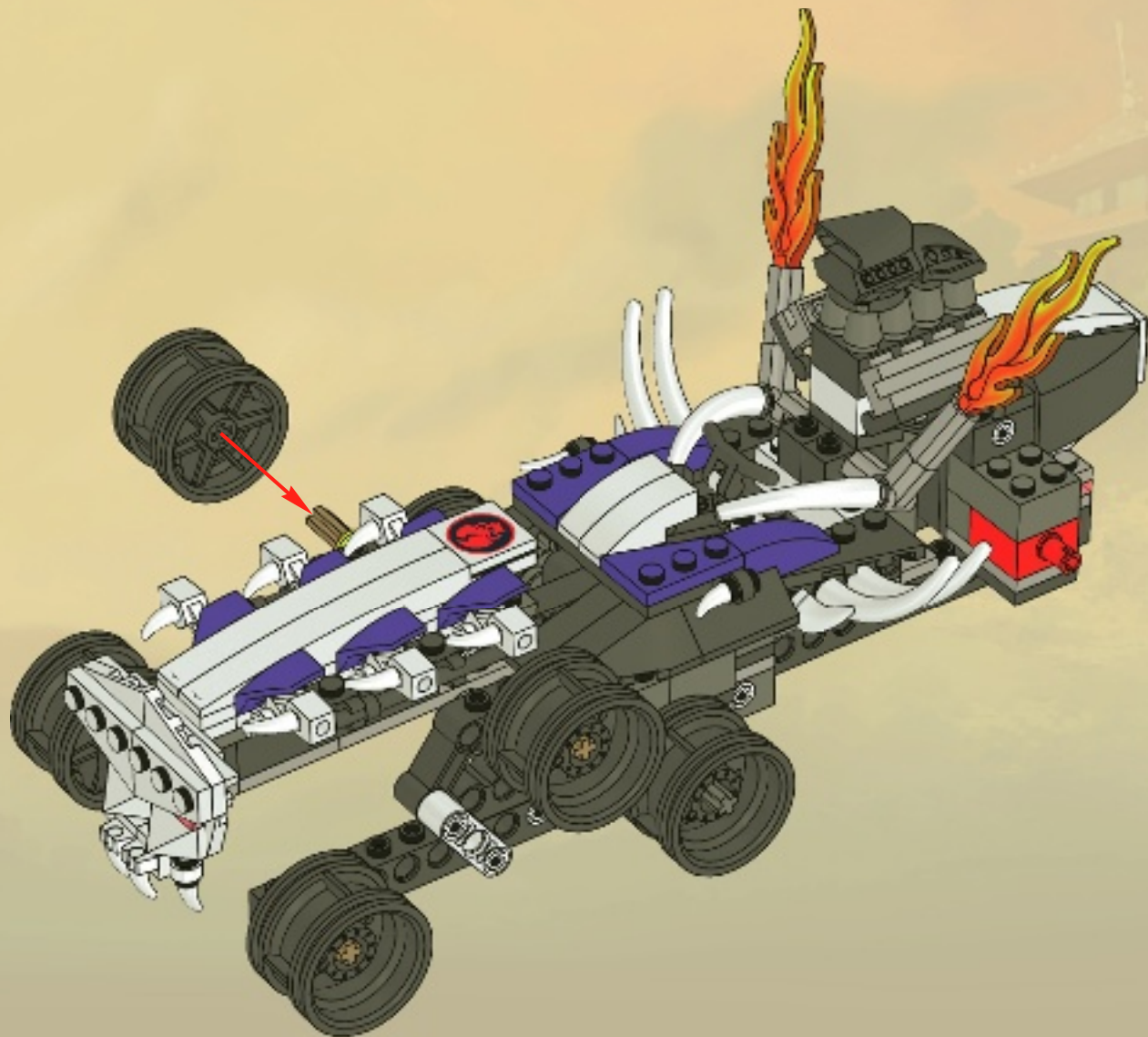

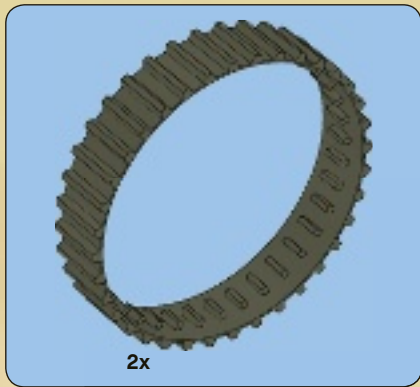

53

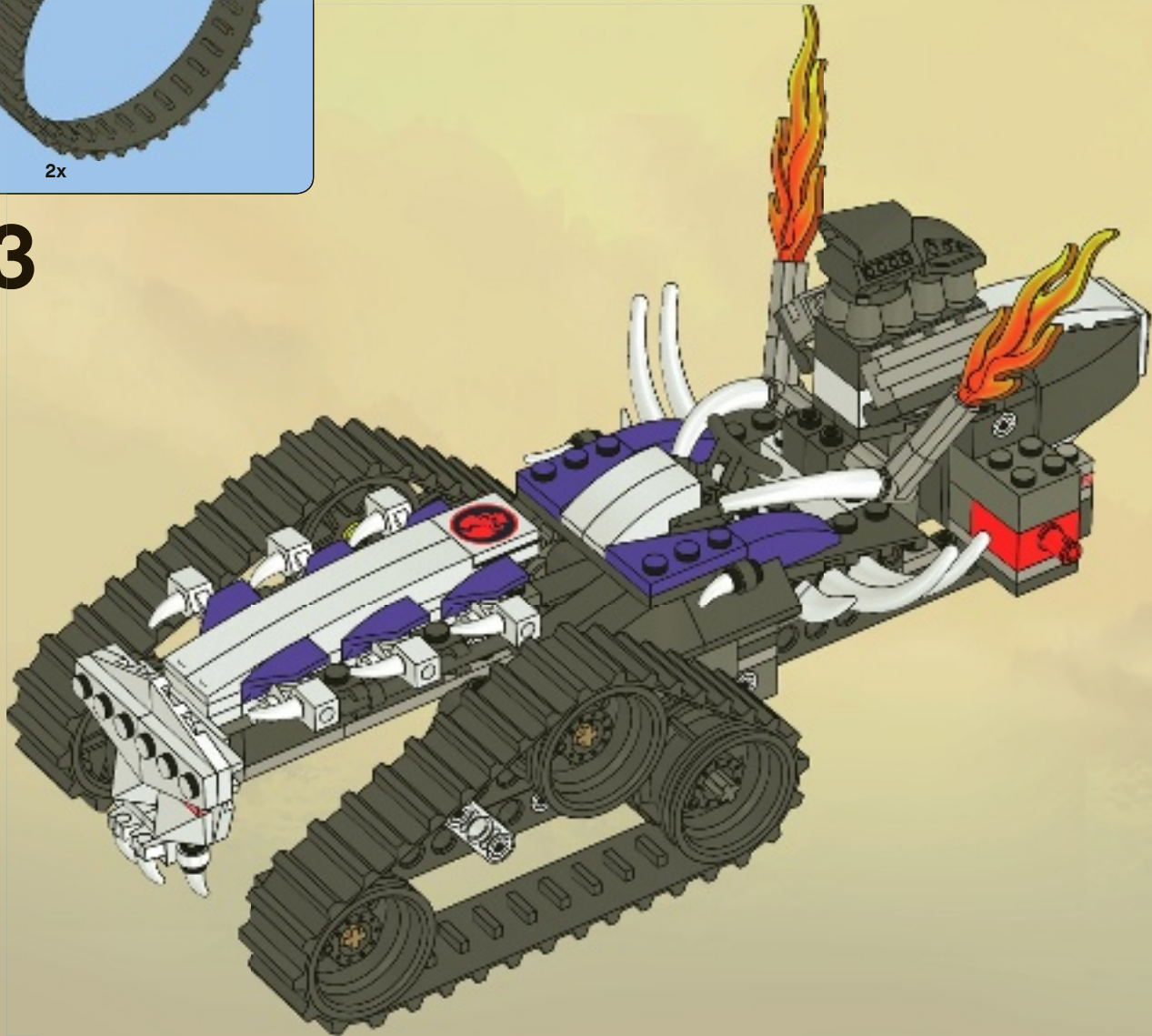

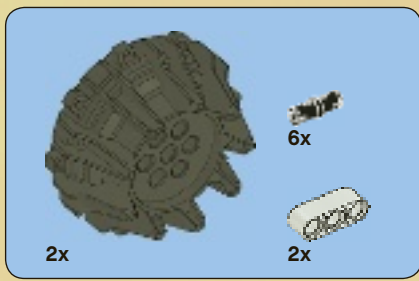

54

1

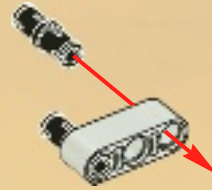

2

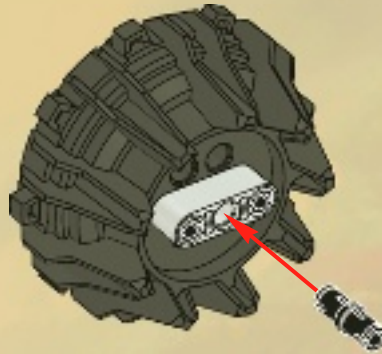

3



2x

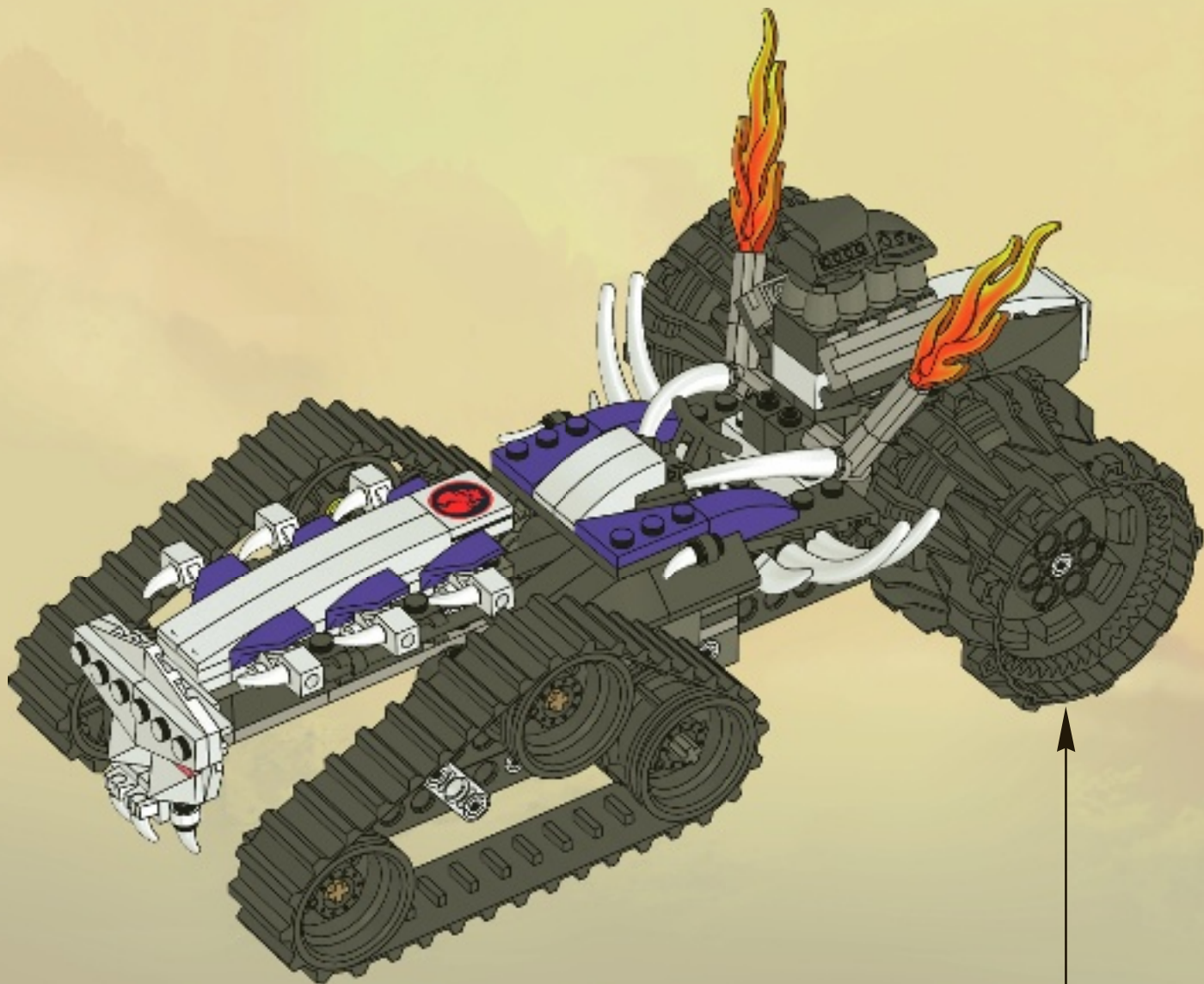







1x
235726



1x
300126



1x
300926



2x
4162443



4x
370026



2x
4141810



1x
370226



4x
4107558



1x
4515362



2x
303826



1x
4180423



1x
4180413



2x
4219107



3x
371026



2x
366626



1x
379526



2x
408126



4x
4225201



4x
4535739



2x
244426



2x
4161332



2x
4160869



1x
403226



1x
403226



2x
4538722



1x
4612327



2x
300326



2x
4502834



1x
4612652



1x
4551359



1x
4613453



6x
4299389



1x
3003126



1x
4585748



1x
4185272



1x
4515185



3x
4142135



26x
4121715



1x
4107767



2x
4502834



4x
4538782



1x
4609291



4x
4558886



2x
623221



2x
4142865



1x
4140806



1x
4612323



1x
4612649



1x
4610824



2x
4206482



7x
4514553



2x
4556157



2x
4552348



2x
4211758



1x
4211807



2x
4211551



2x
4512360



2x
4211483



2x
4211613



1x
4549997



2x
4211398



1x
4211397



5x
4211396



3x
4211395



2x
4211452



2x
4277927



1x
4611426



1x
4611427



6x
4239601



2x
4201019



2x
4590990



1x
4549898

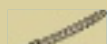

1x
4612900



2x
4548009



4x
4566927



4x
4211088



5x
4211105



8x
4529240



1x
4213607



3x
4210917



1x
4210678



1x
4560177



2x
4508553



1x
4514559



1x
4514558



2x
4578772



3x
4566804



2x
4566522



1x
4616558



1x
4616557



1x
4600267



1x
4600271



1x
4611904



5x
4208160



2x
4526981



2x
255501



7x
408101



7x
4140583



1x
300501



3x
300401



1x
301001



4x
4191825



1x
4500469



2x
4249112



1x
4179870

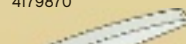

2x
4547368



7x
302301



2x
302201



1x
4612858



1x
302101



2x
302001



1x
4282737



3x
4179874



3x
4179875



2x
4609295



2x
4602970



1x
4260649



1x
4602984



6x
4622904



1x
4612984



12x
4568387



2x
4566256



6x
4508454



Customer Service

Kundenservice

Service Consommateurs

Servicio Al Consumidor

www.lego.com/service or dial



00800 5346 5555 :



1-800-422-5346 :





NINJAGO

Masters of Spinjitzu



2505



2504



2263



2260





NINJAGO

Masters of Spinjitzu

NINJAGO.COM





NINJAGO

Masters of Spinjitzu



2111



2257



2112



2113



2114



2115



2116



NINJAGO
Masters of Spinjitzu





UNIVERSE

www.LEGOuniverse.com



www.pegi.info



MASSIVELY MULTIPLAYER ONLINE GAME
MEHRSPIELER ONLINE SPIEL
JEU EN LIGNE MASSIVEMENT MULTIJOUEUR
VIDEOJUENGO MULTIJUGADOR MASIVO EN LÍNEA
JOGO MULTIJOGADOR ONLINE EM MASSA
NAGYON SOK SZEREPLŐS ONLINE JÁTÉK



Einstufung
ausstehend

USK

Rating pending



WIN!

Go to www.LEGOsurvey.com/product
to fill out a survey for a chance
to win a cool LEGO® Product.
No purchase necessary.
Open to all residents where not prohibited.

 www.LEGO.com



www.LEGOsurvey.com/product

GEWINNE! WIN!

Nimm an der Umfrage auf
www.LEGOsurvey.com/product
teil und hab die Chance ein cooles
LEGO® Produkt zu gewinnen!
Die Teilnahme am Gewinnspiel führt zu keinerlei
Kaufverpflichtungen. Teilnahme in allen nicht
ausgeschlossenen Ländern möglich.

Ga naar www.LEGOsurvey.com/product,
vul een enquêteformulier
in en maak kans op een
cool LEGO® product.
Geen aankoopverplichting.
Iedereen mag deelnemen, uitgezonderd
ingezetenden van landen waar een
enquêteverbod geldt.

GAGNE! 当てよう!

Visite www.LEGOsurvey.com/product
pour répondre à un
questionnaire et avoir une chance de
gagner un produit LEGO® très cool!
Aucune obligation d'achat.
Ouvert à tous les résidents des pays
autorisés.

www.LEGOsurvey.com/product にアクセスして、
アンケートにご記入ください。当選者にはレゴ®
製品を差し上げます。
お買い上げの必要はありません。
禁止されていない限り、すべての皆様にご利用いただけます。