



CITY

3367



WARNING: CHOKING HAZARD.
Toy contains small parts and a small ball.
Not for children under 3 years.

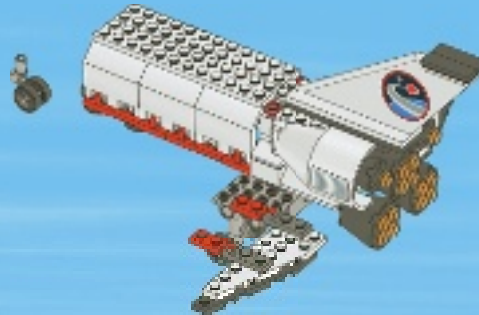
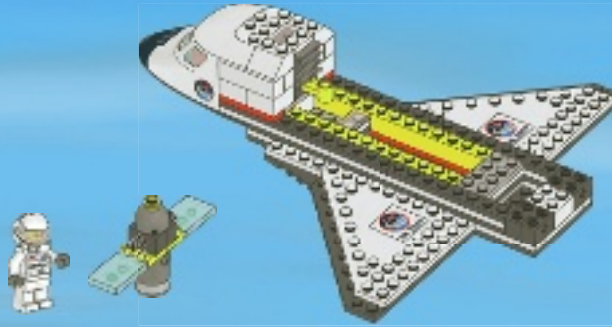

AVERTISSEMENT : RISQUE D'ÉTOUFFEMENT.
Le jouet contient des petites pièces ainsi qu'une petite boule.
Il ne convient pas aux enfants de moins de 3 ans.



ADVERTENCIA: PELIGRO DE ASFIXIA.
Juguete que contiene partes pequeñas y una pelota pequeña.
No recomendado para niños menores de 3 años.

1

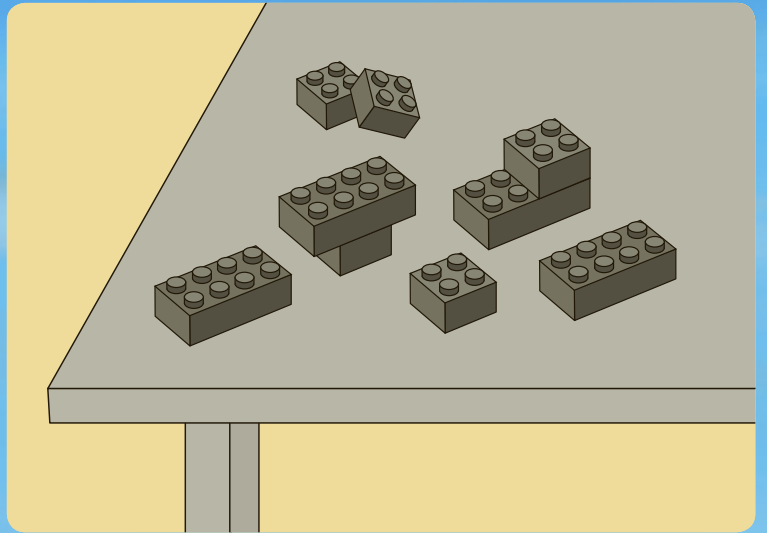
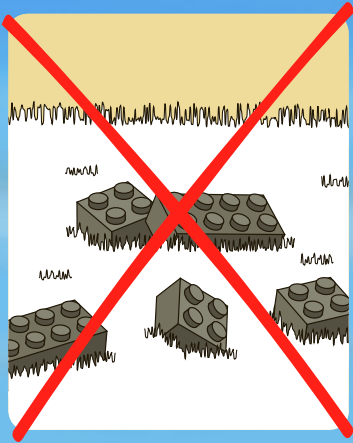

2



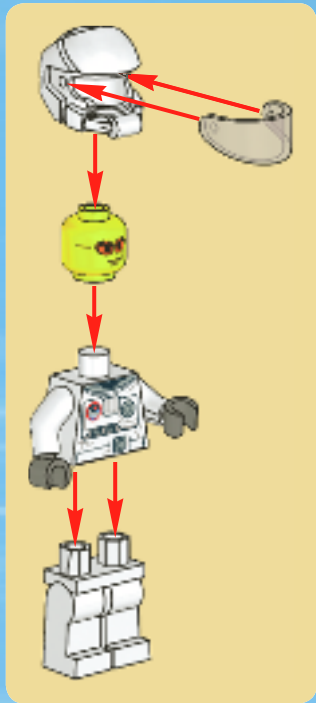
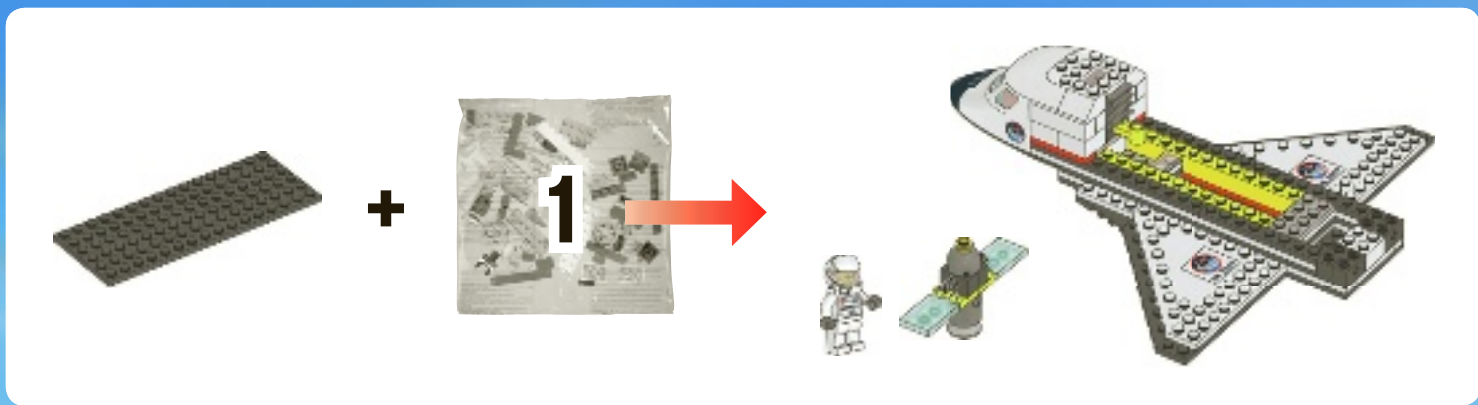

1



2



3

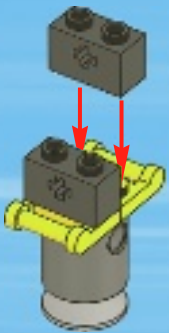

4

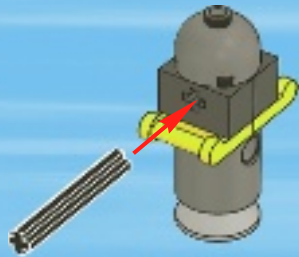

5



6



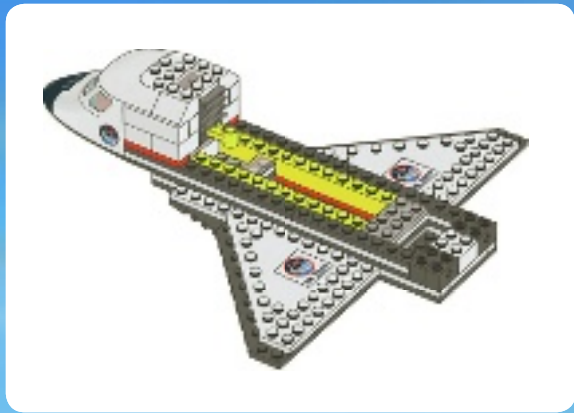

1



2



3



4

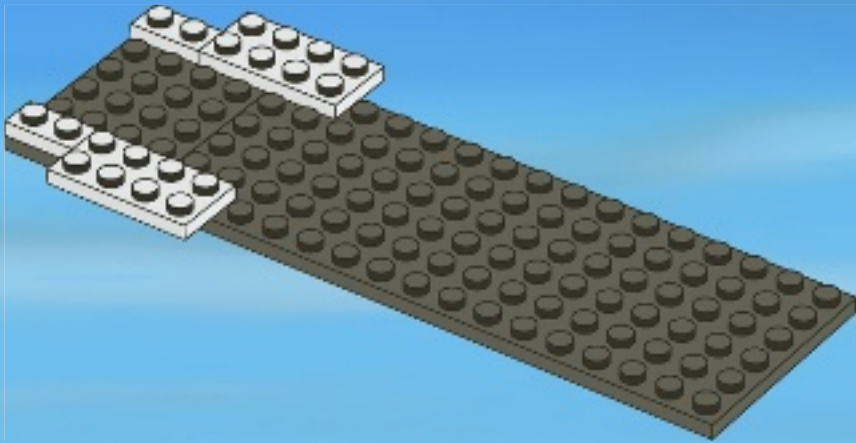

5

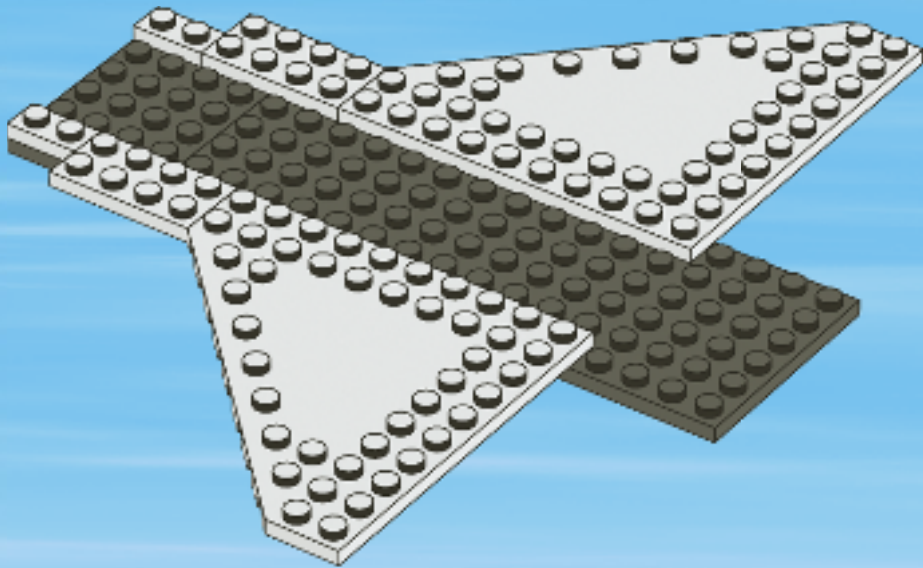

6

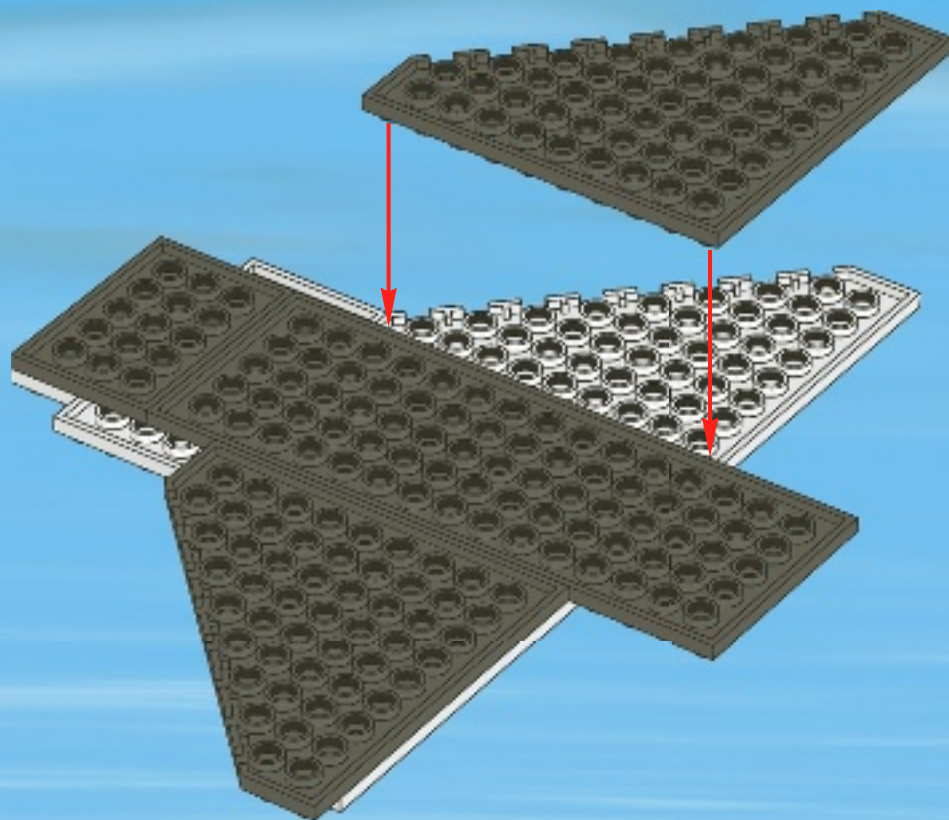

7

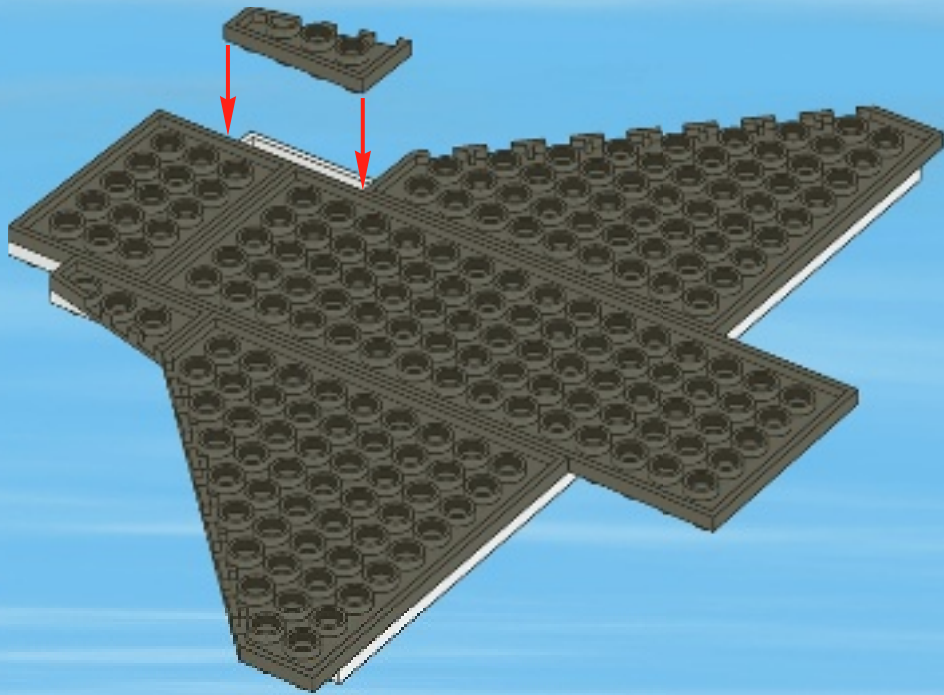



1

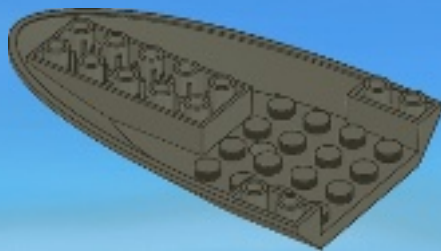

2

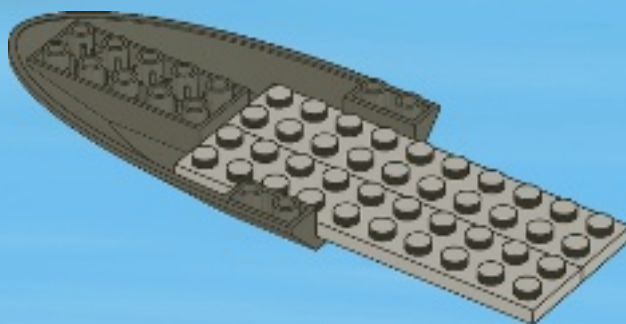

3

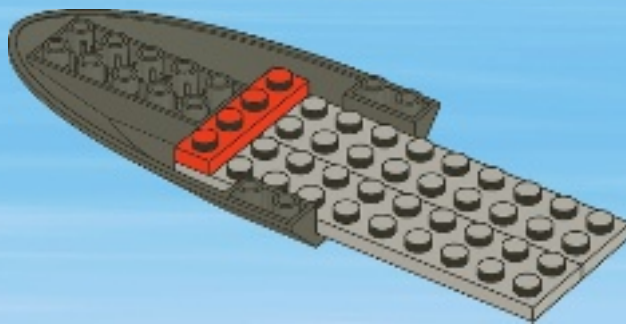

4

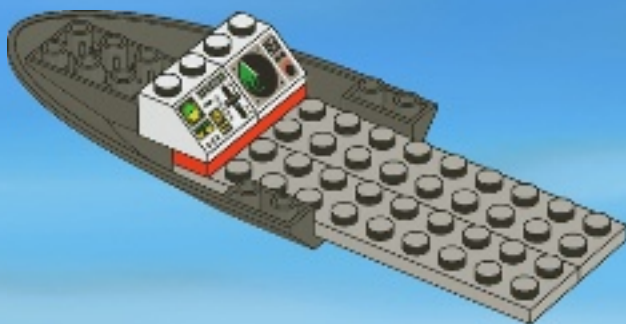

5

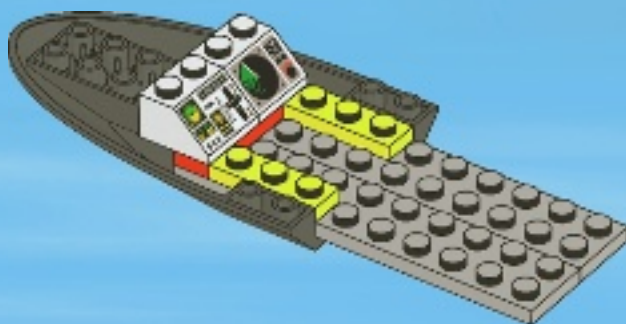

6

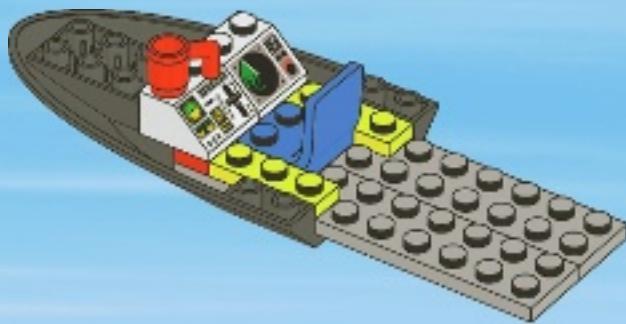

8

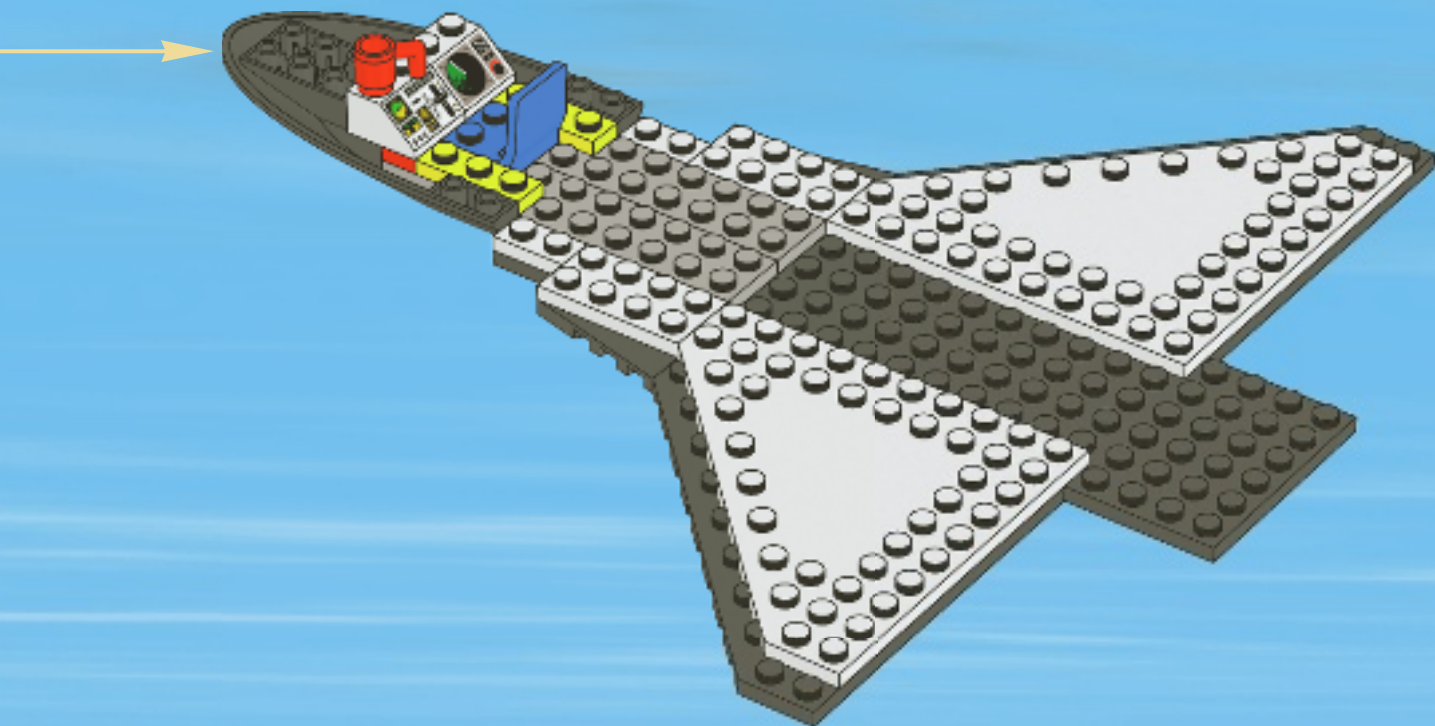

9

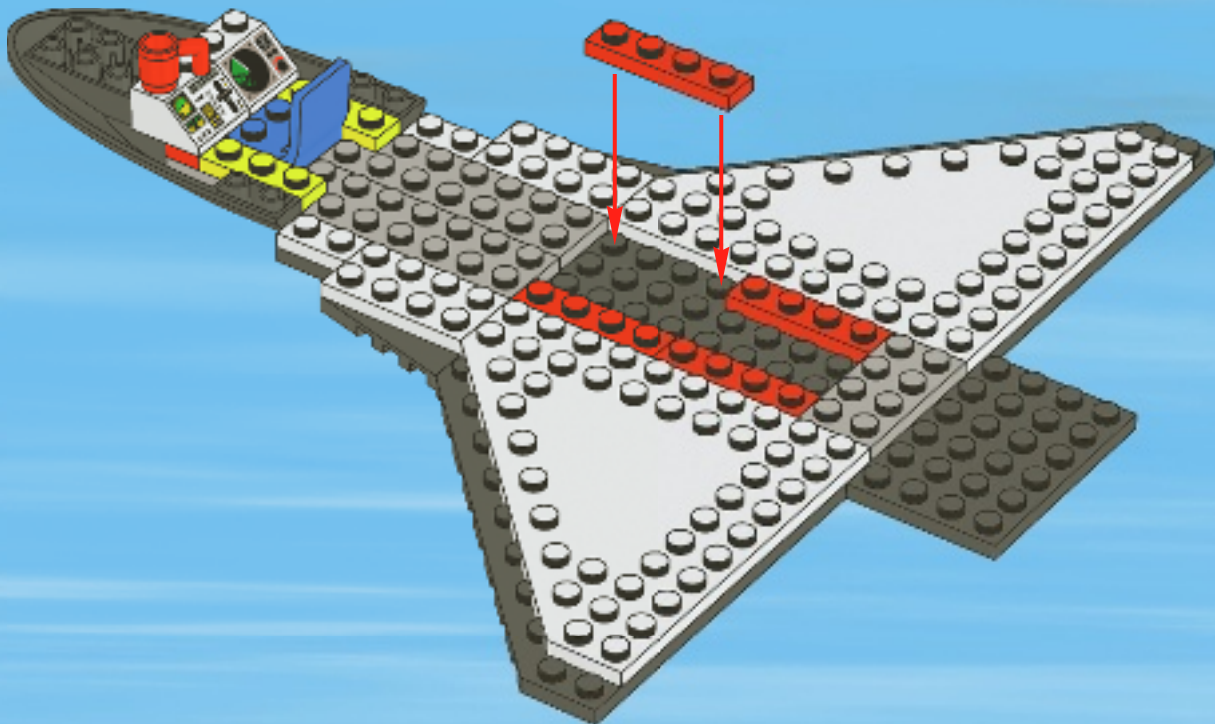

10

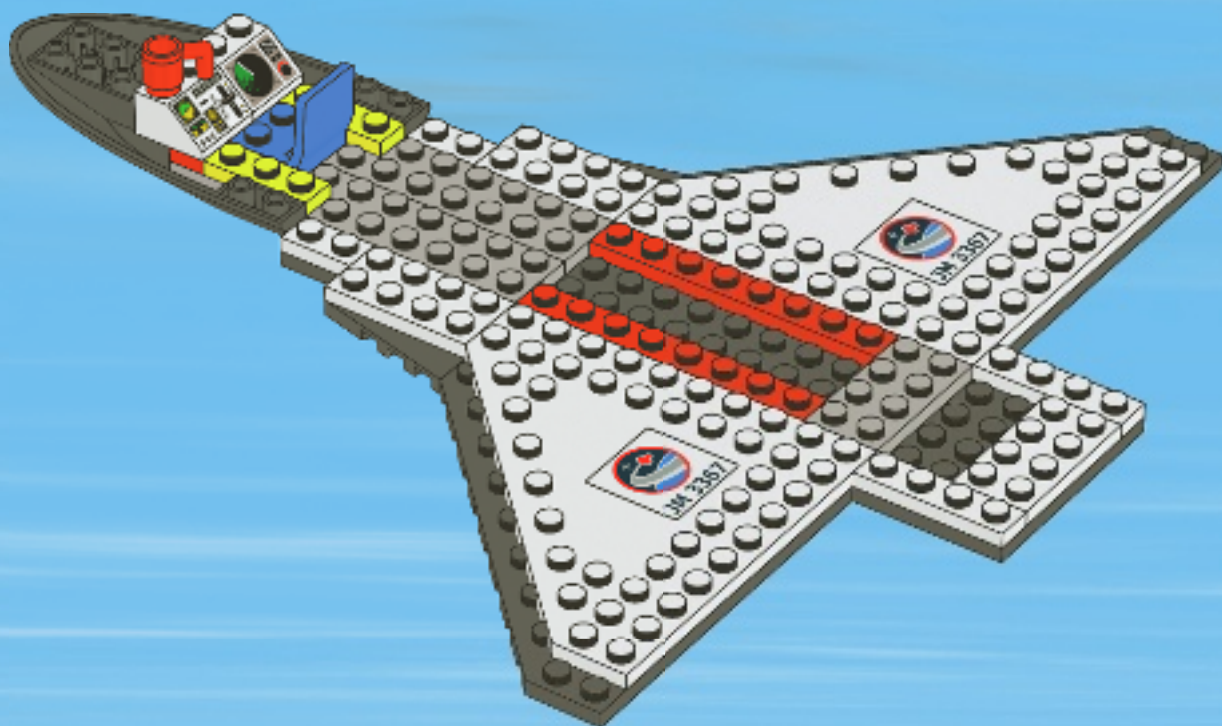

11

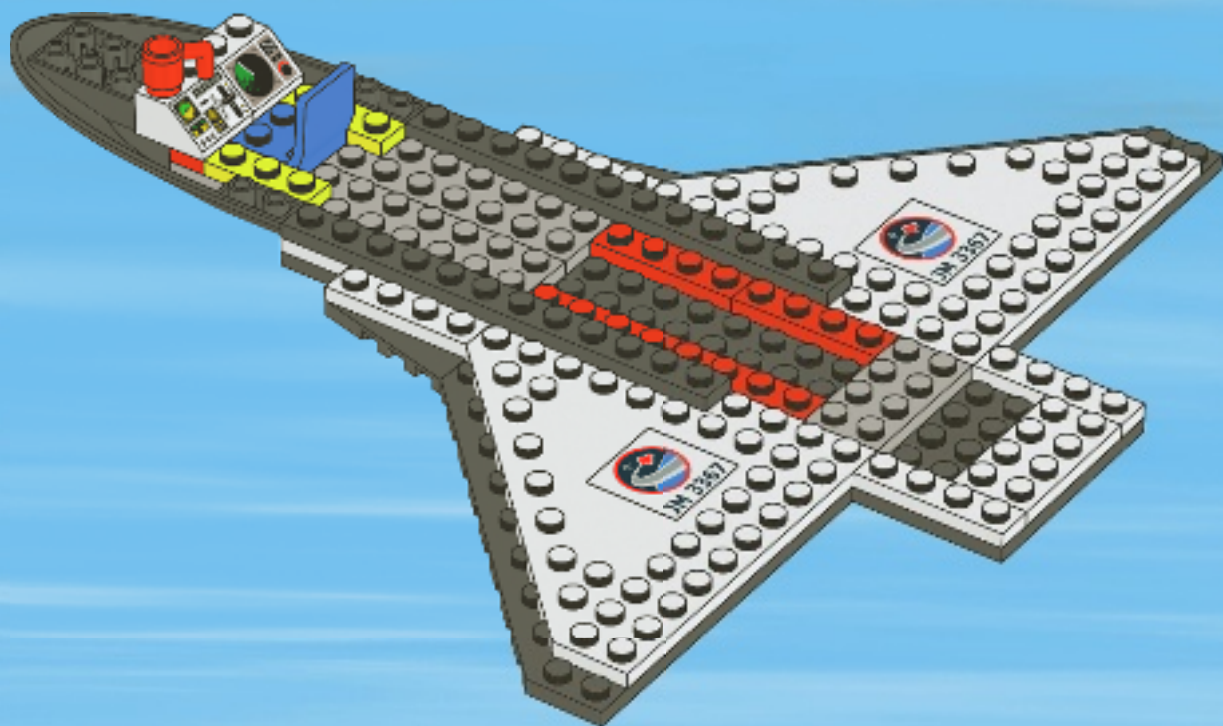

12

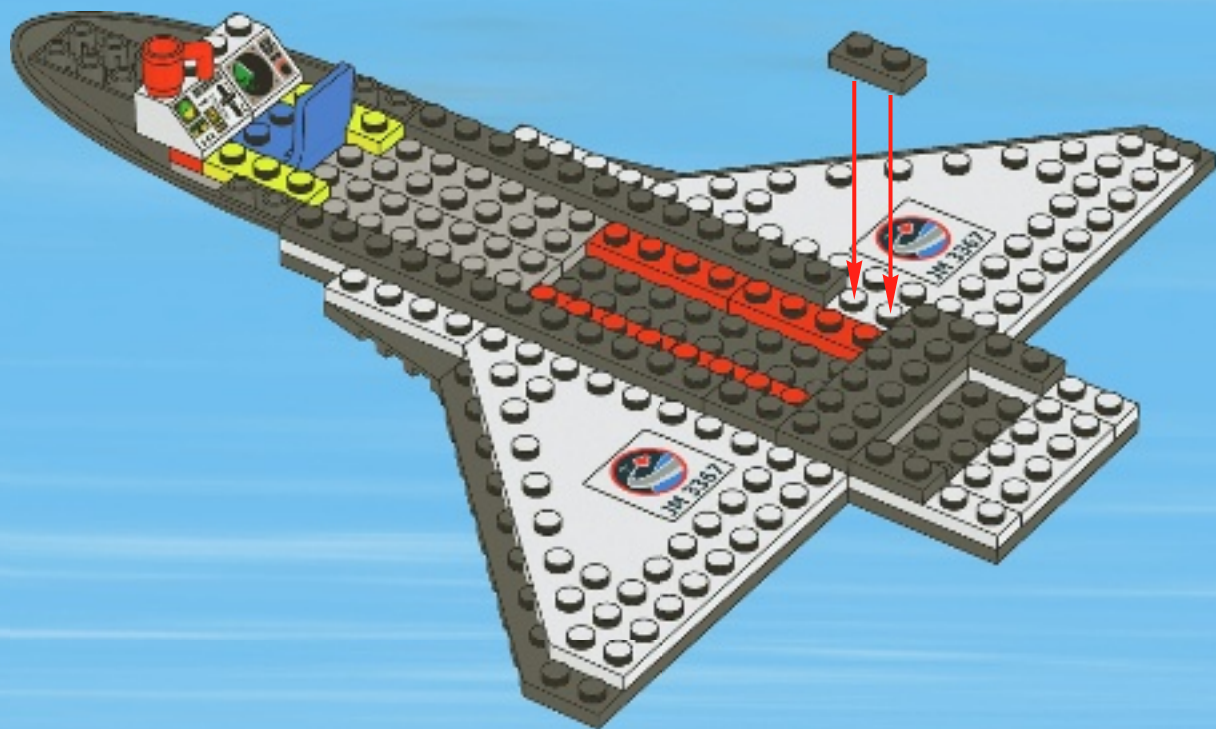

13

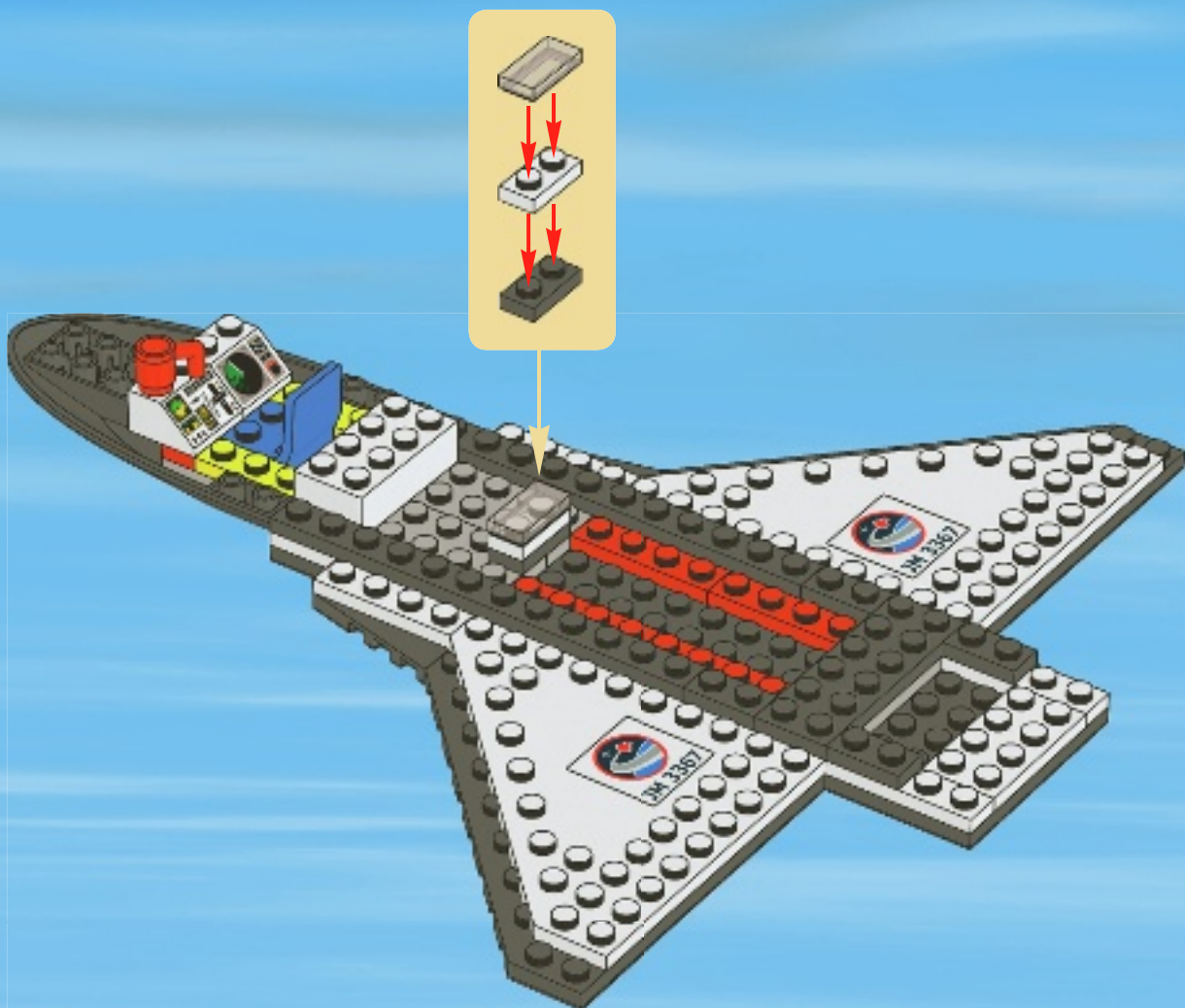

14

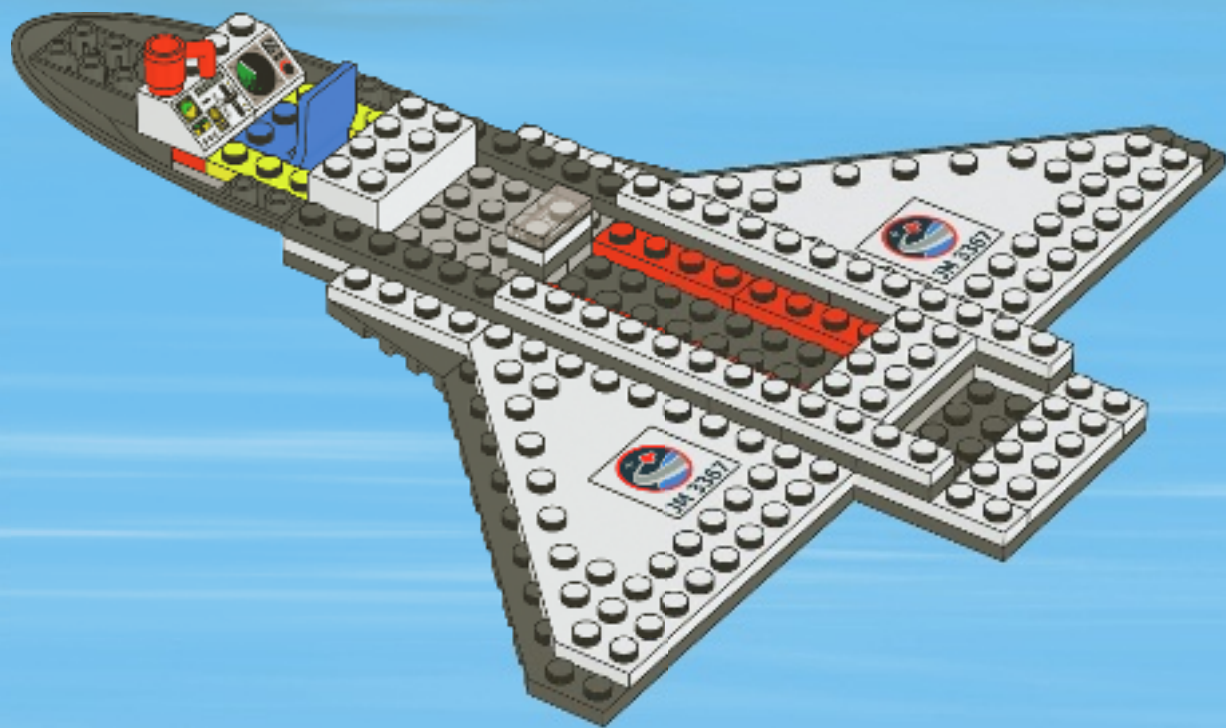

15

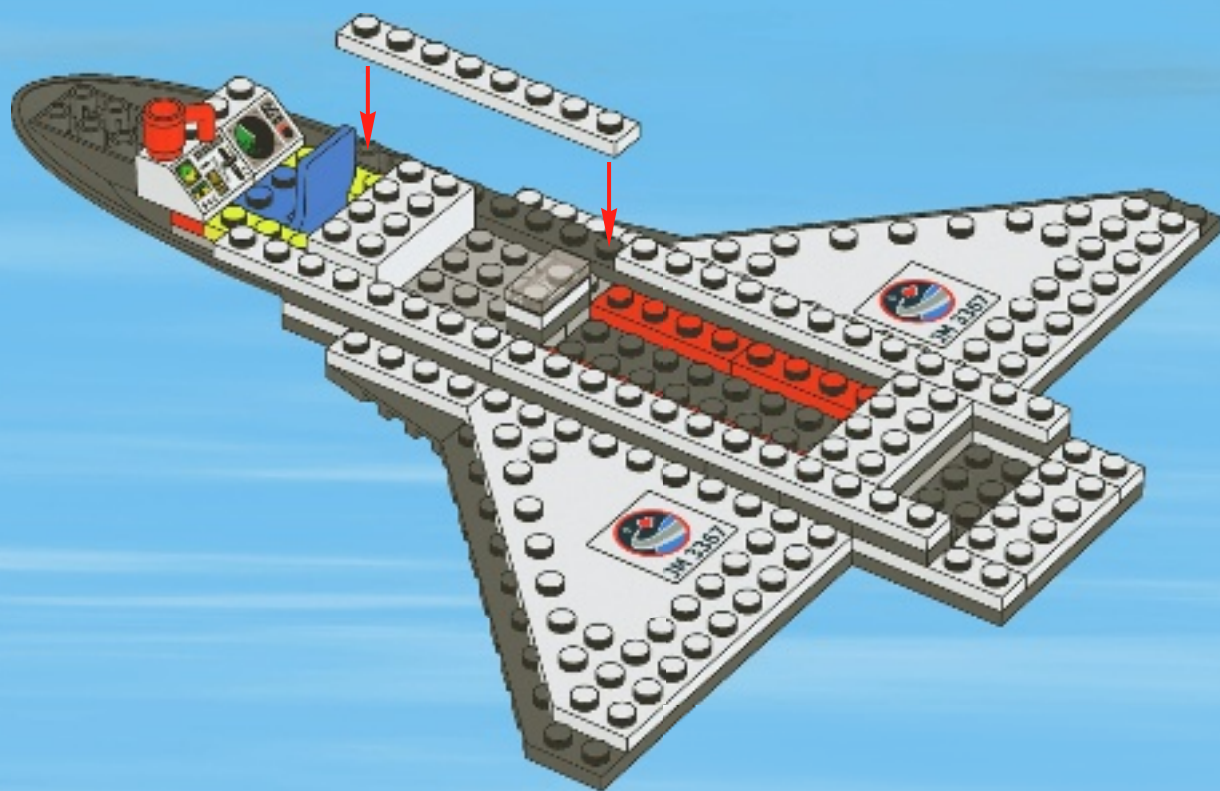

16

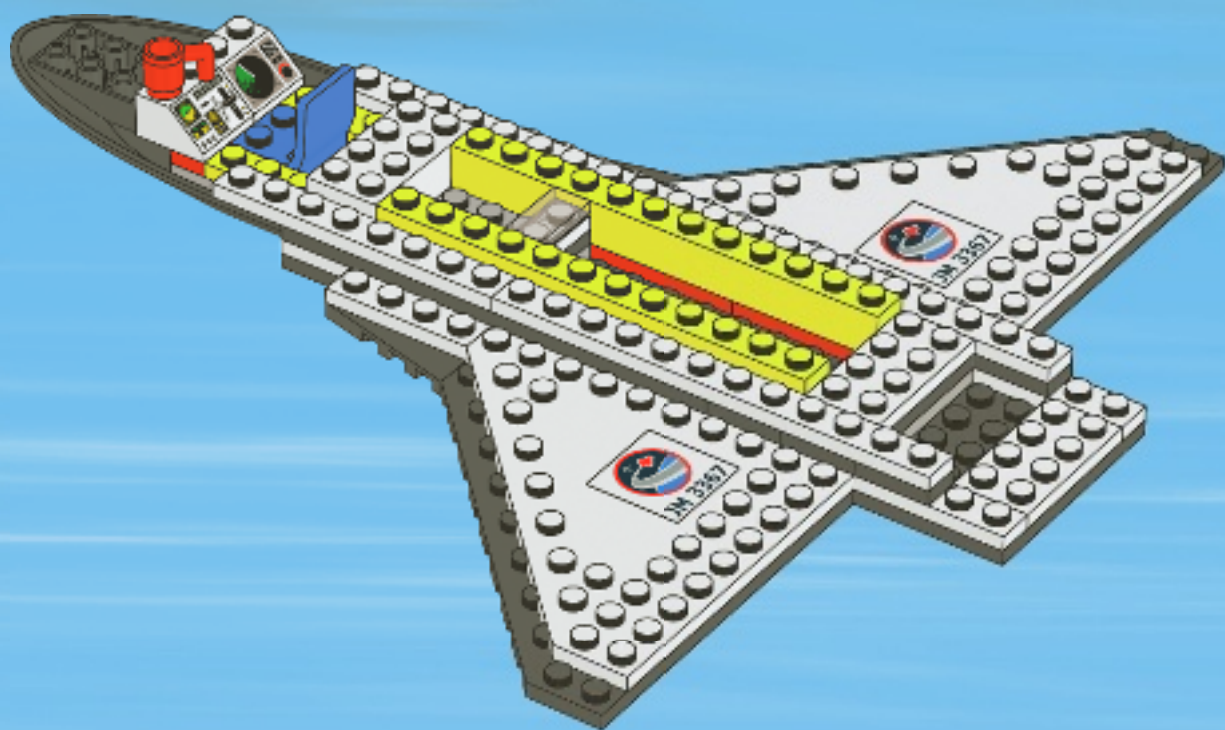

17

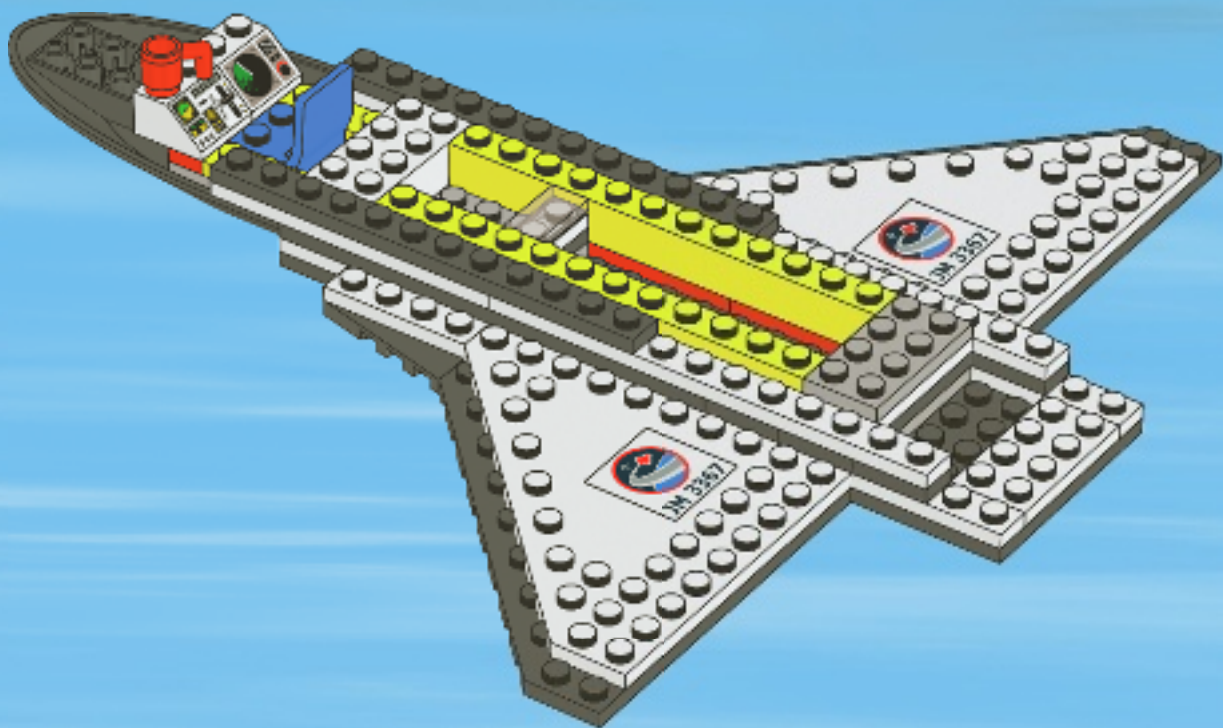

18

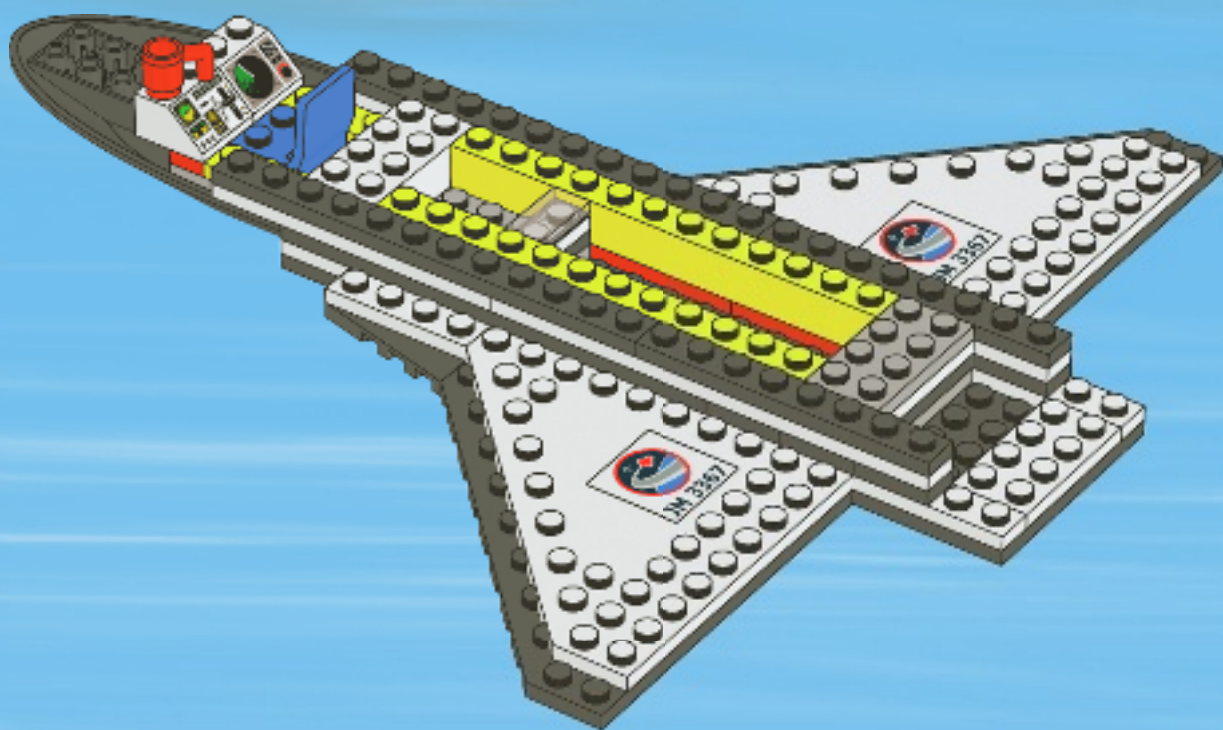

19

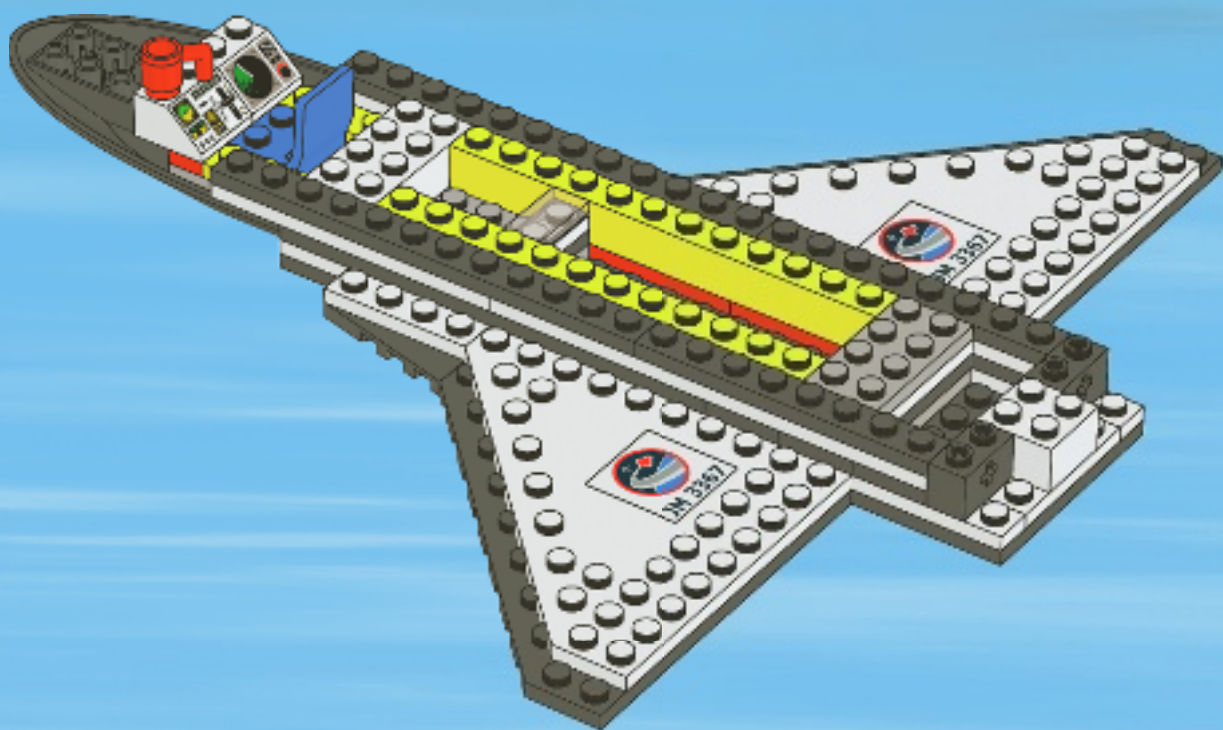

20

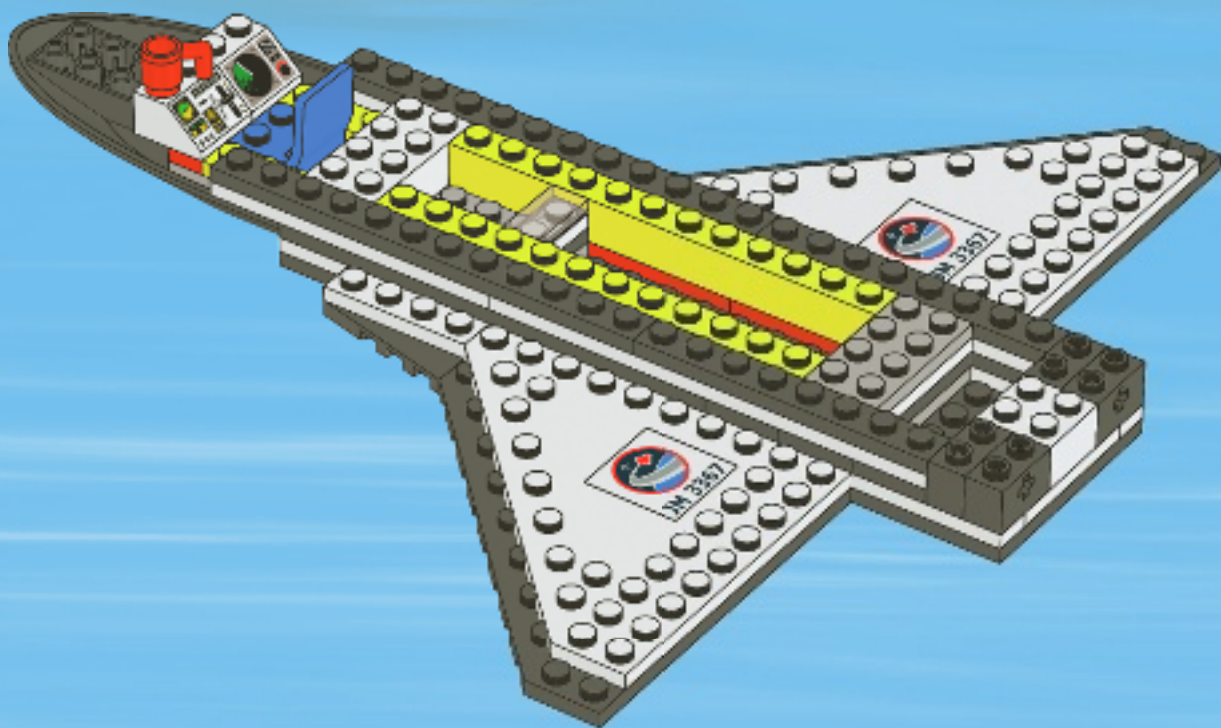

21

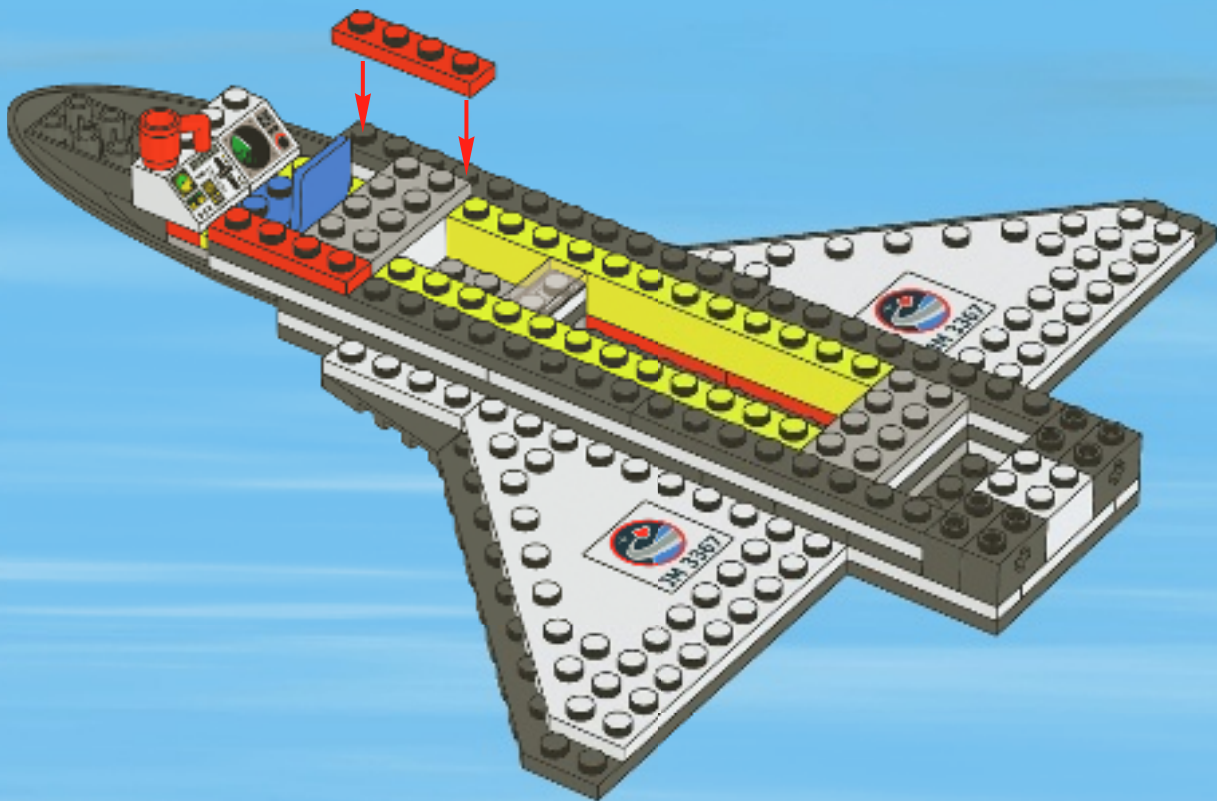

22

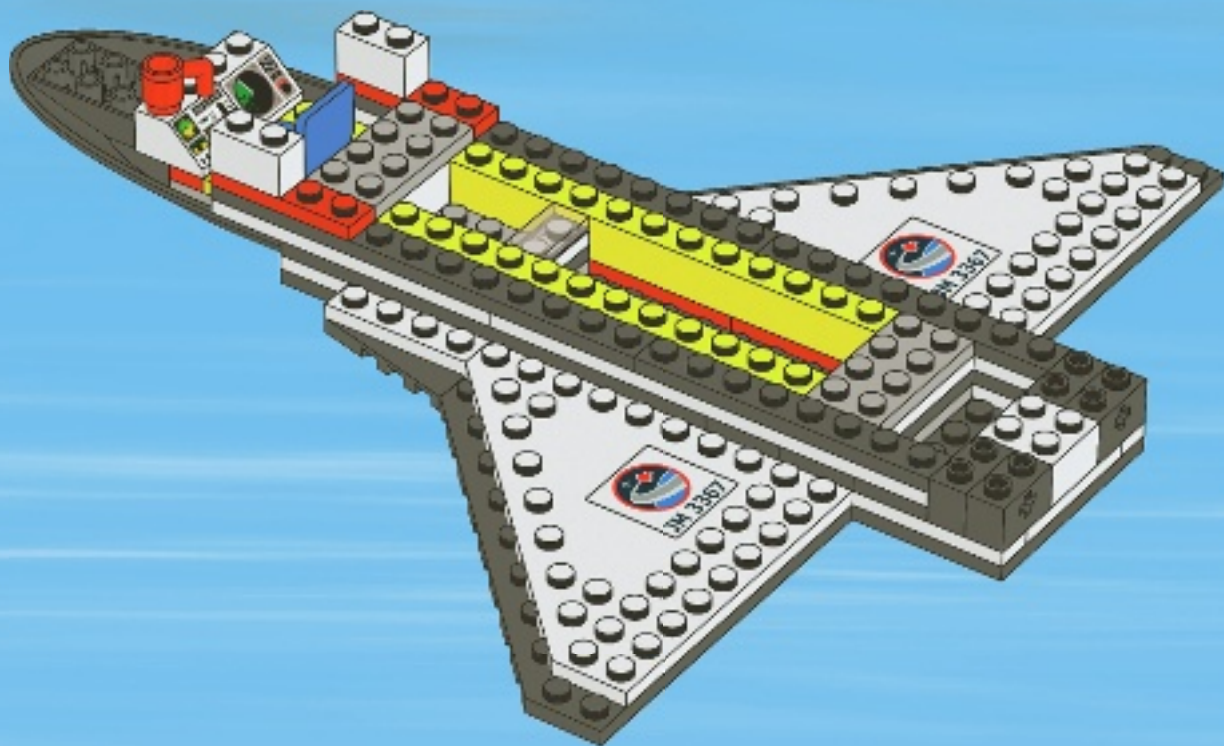

23

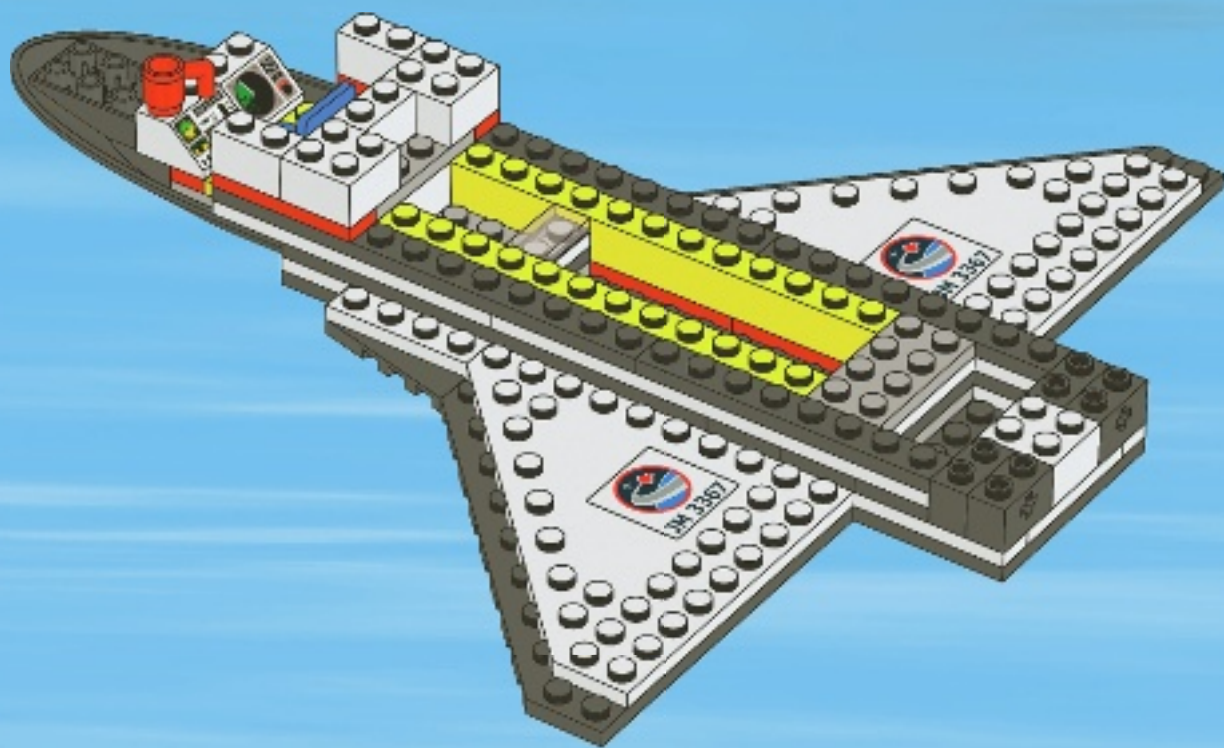

1

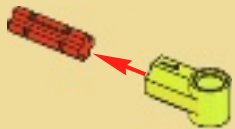

2

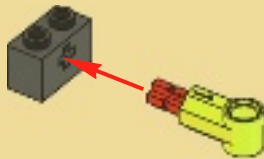

3



24

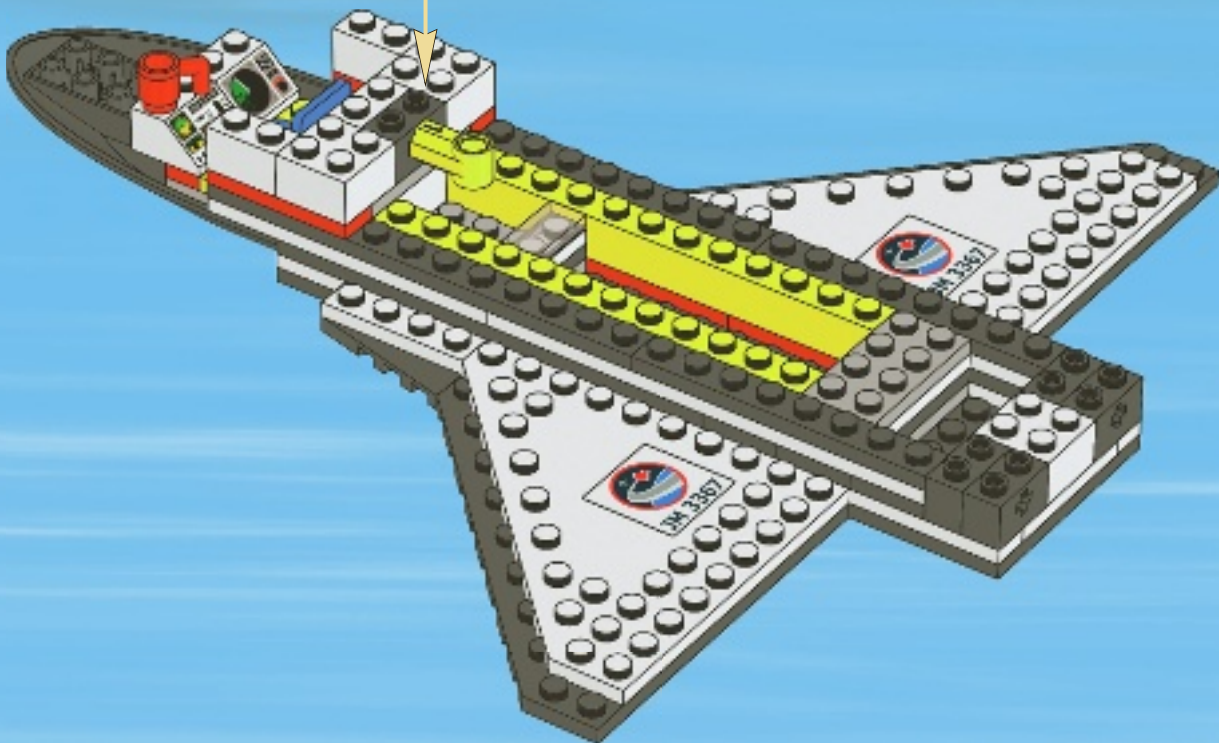

25

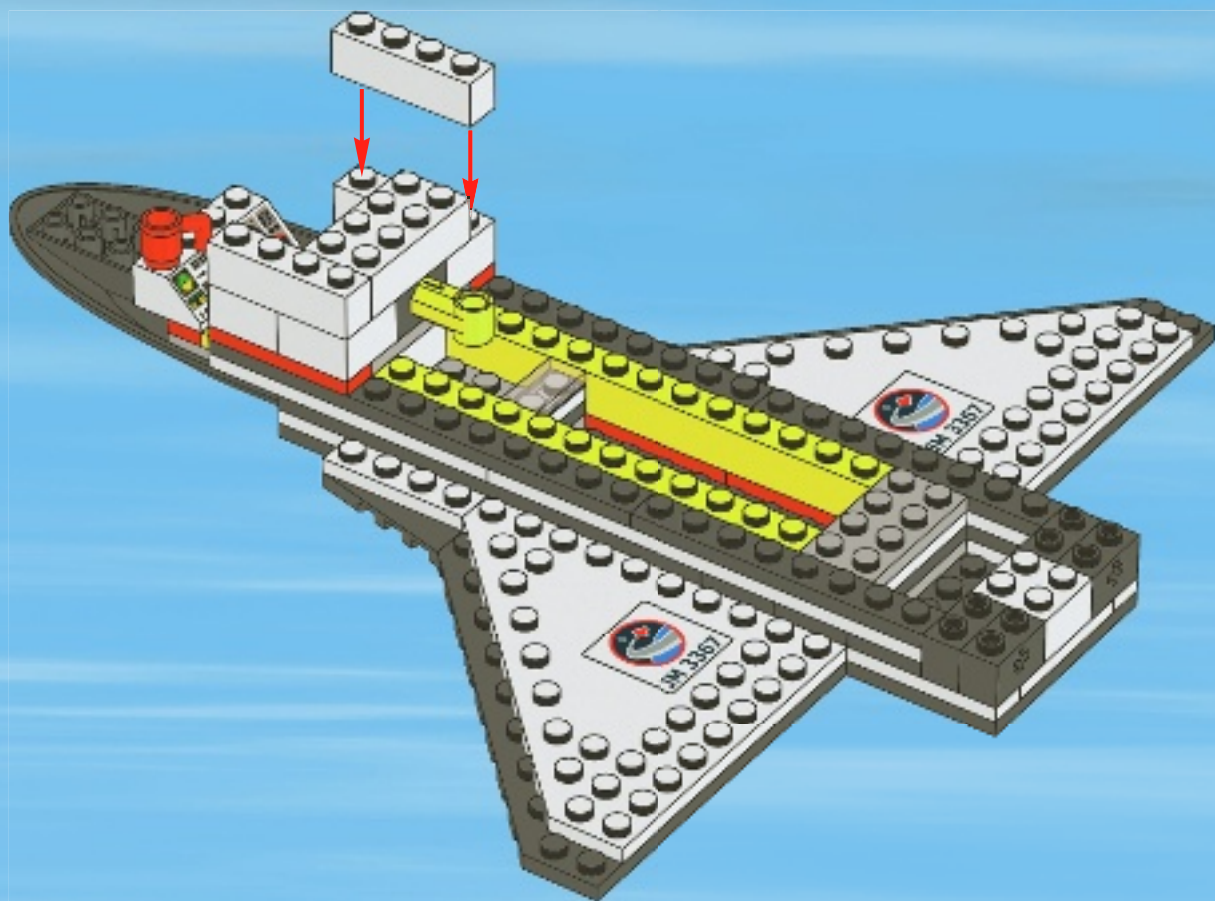

26

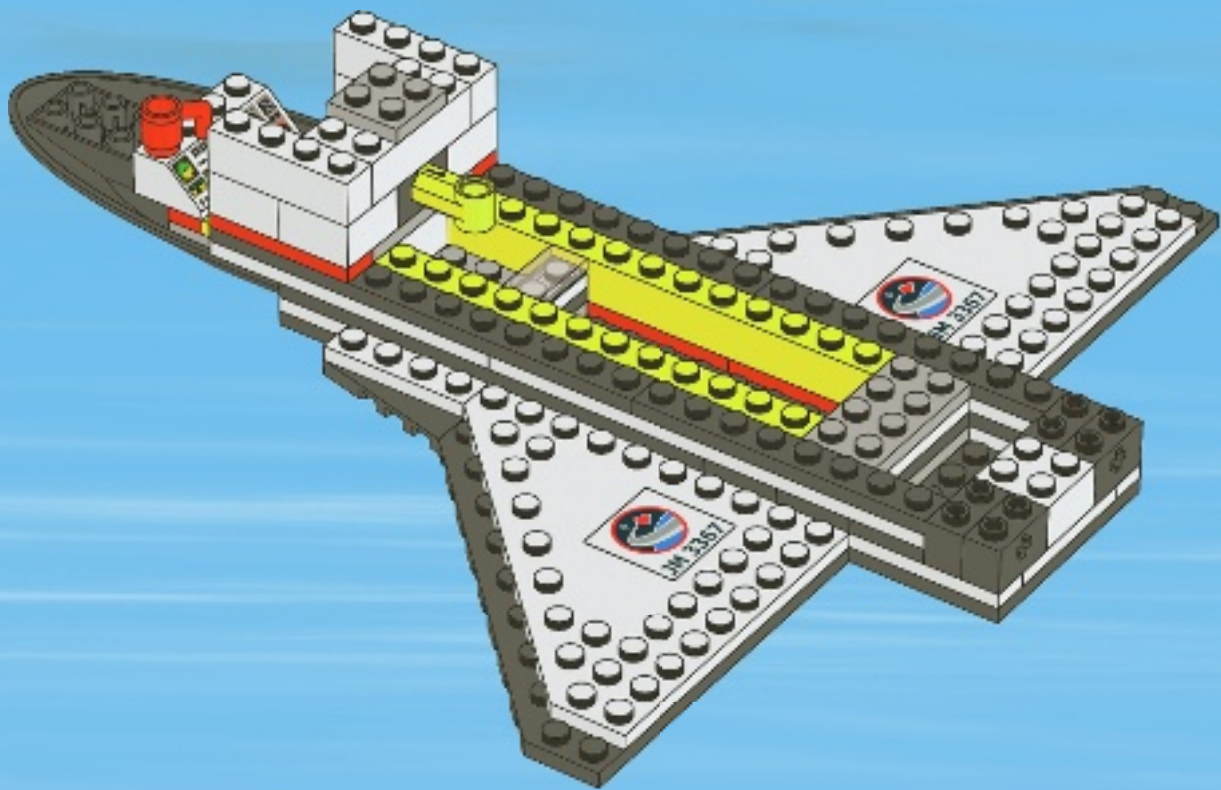

27

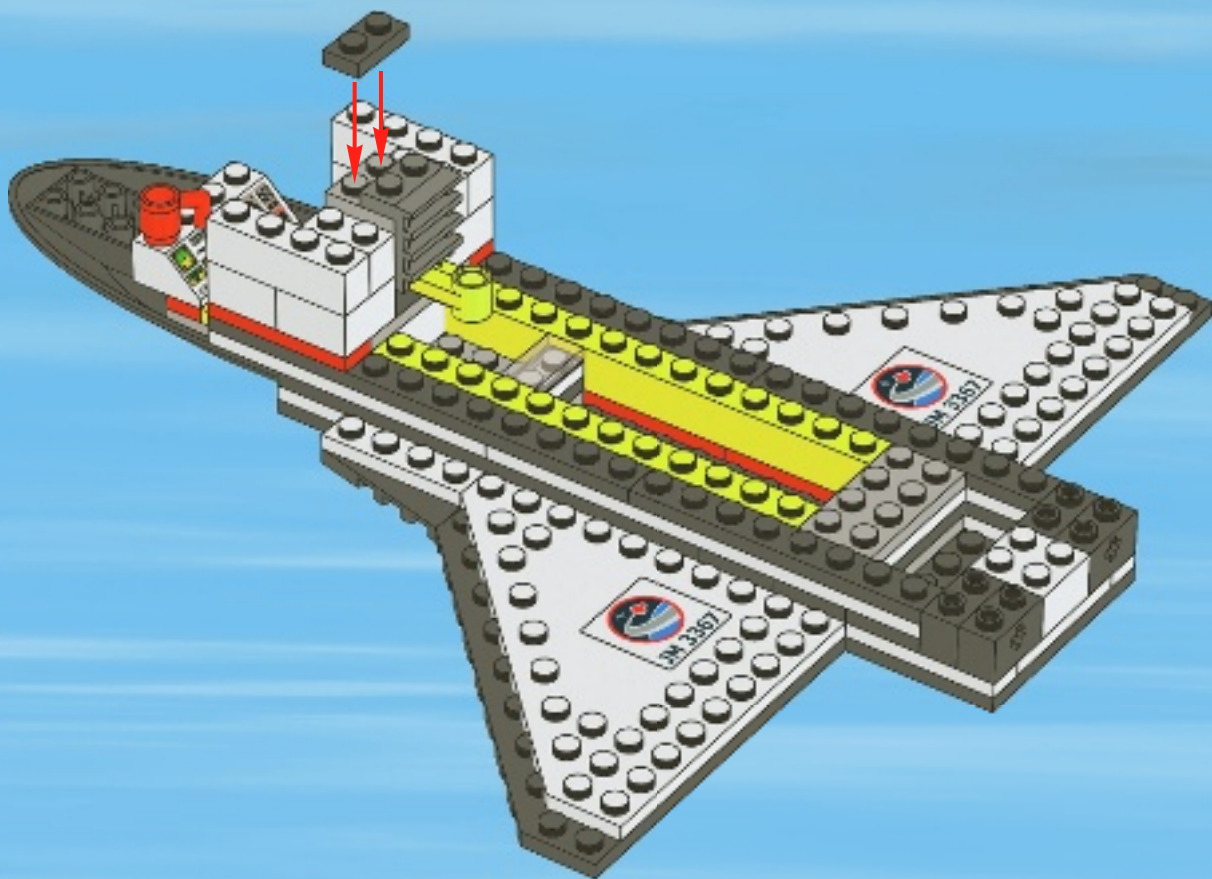

28

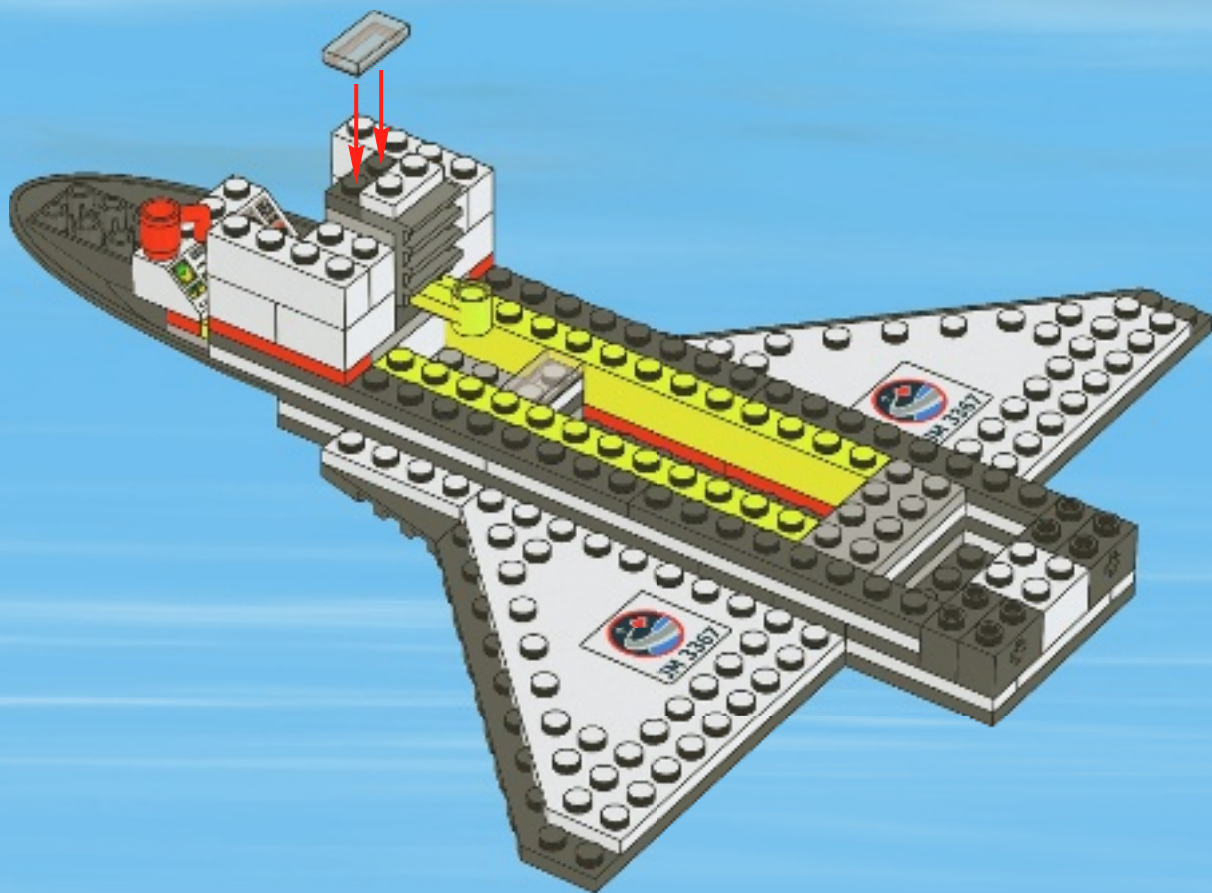

29

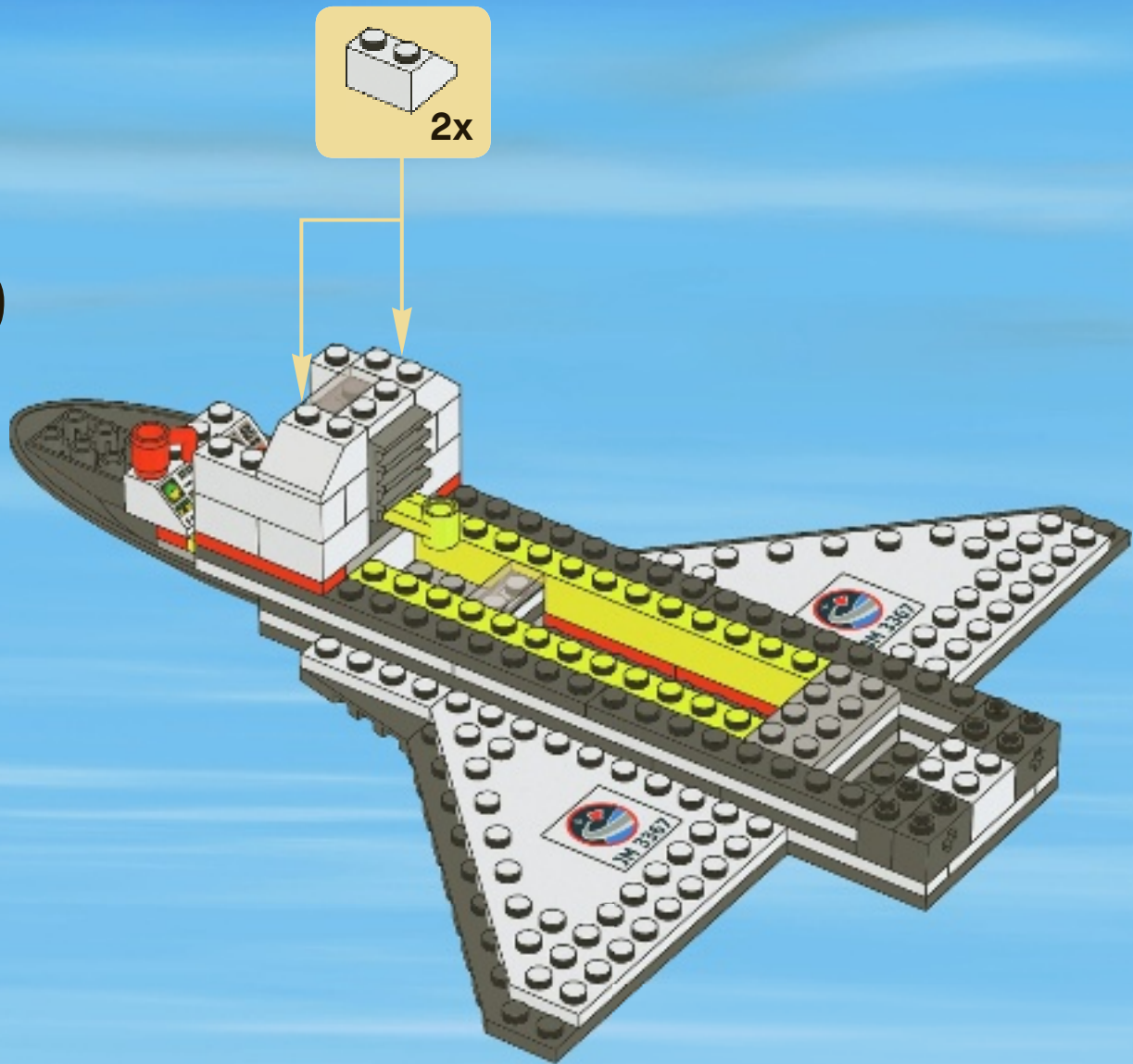

1

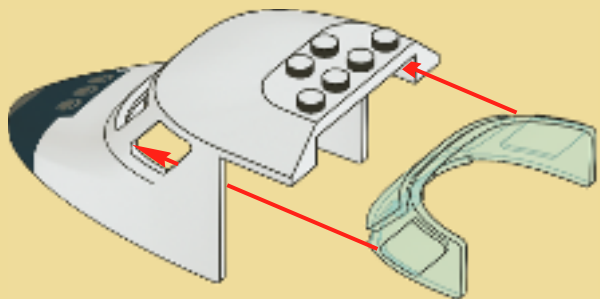

2

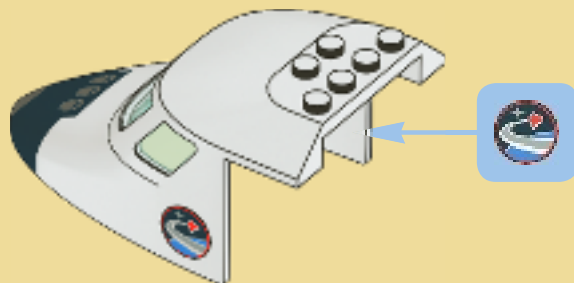

30

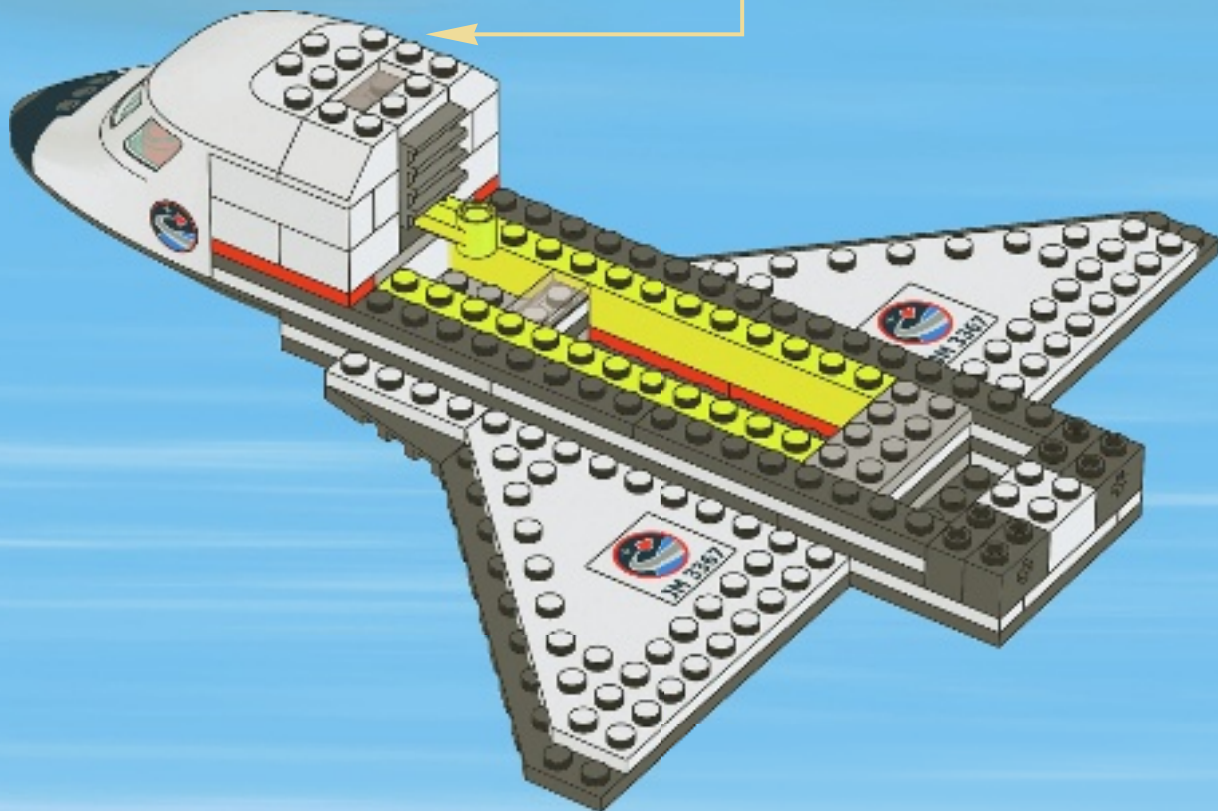



2

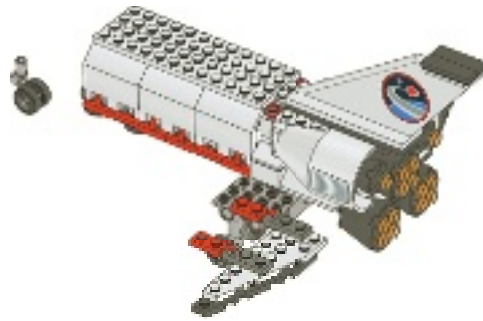

31

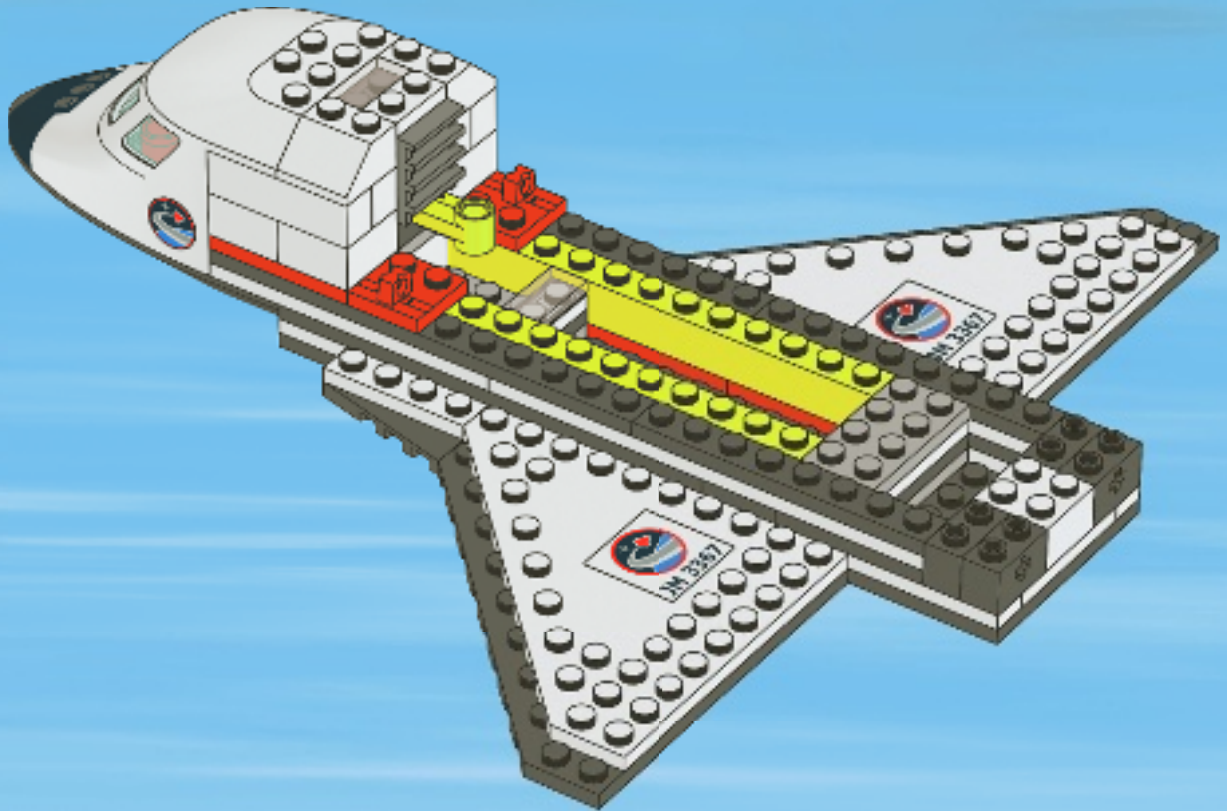

32

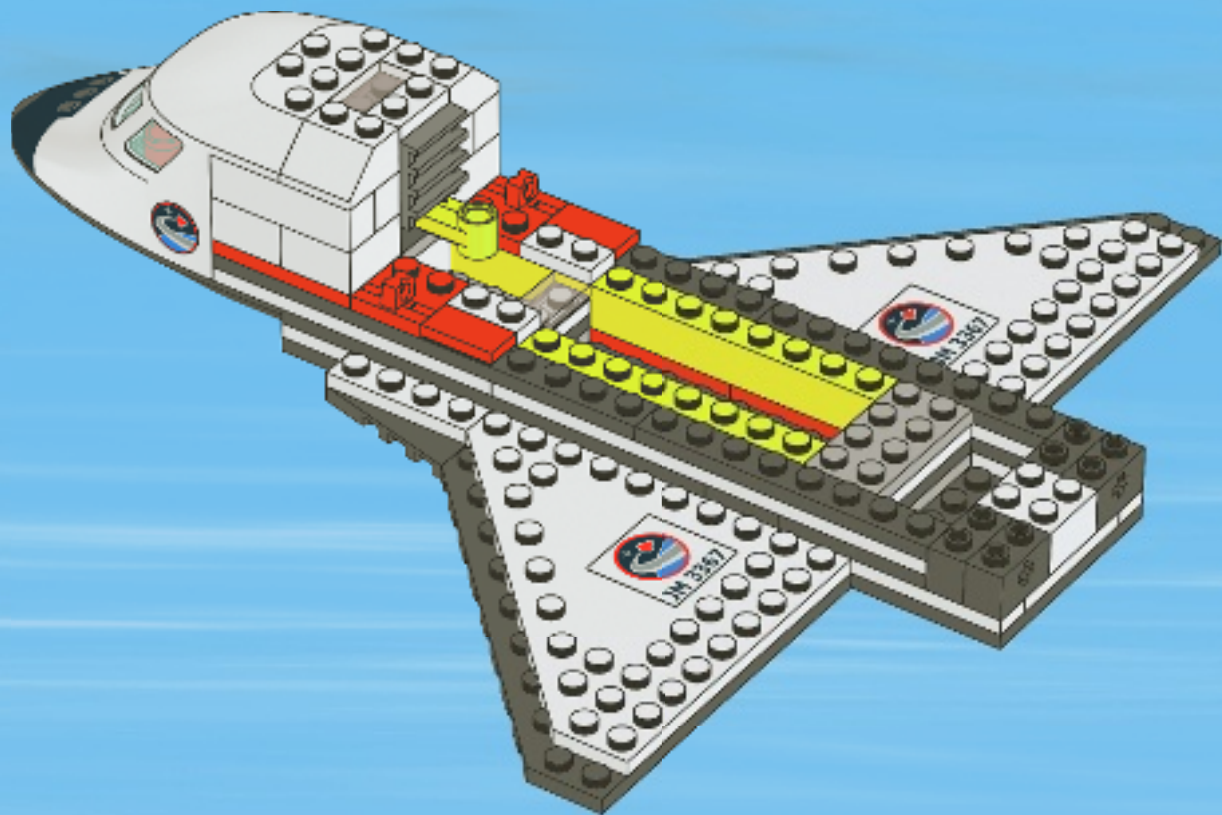

33

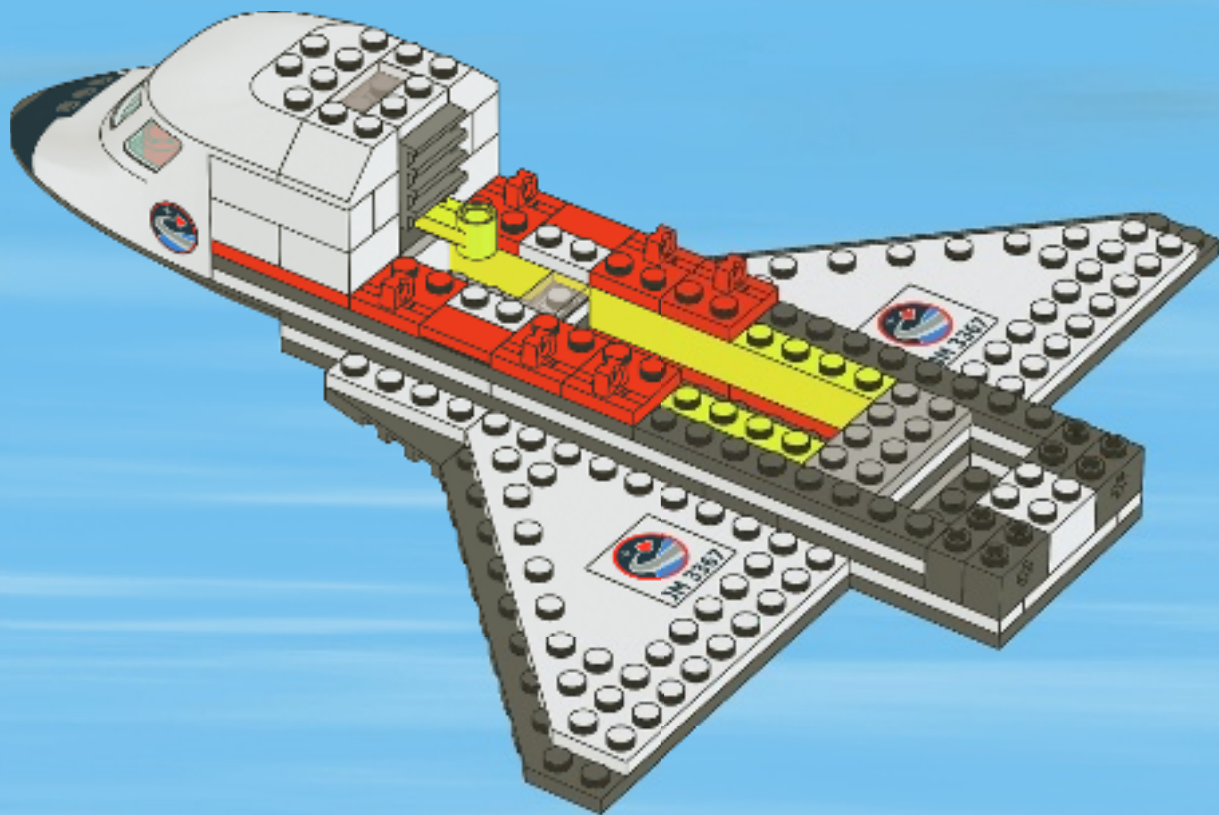

34

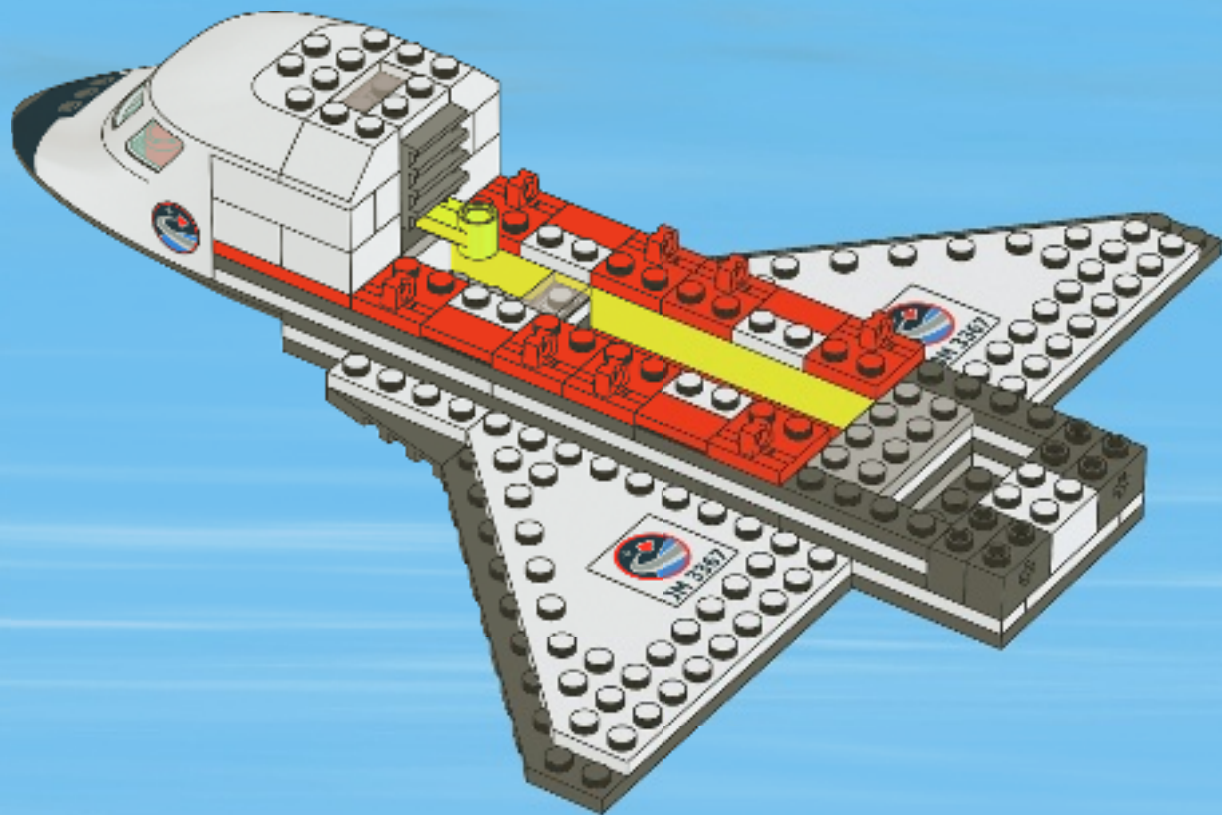

35

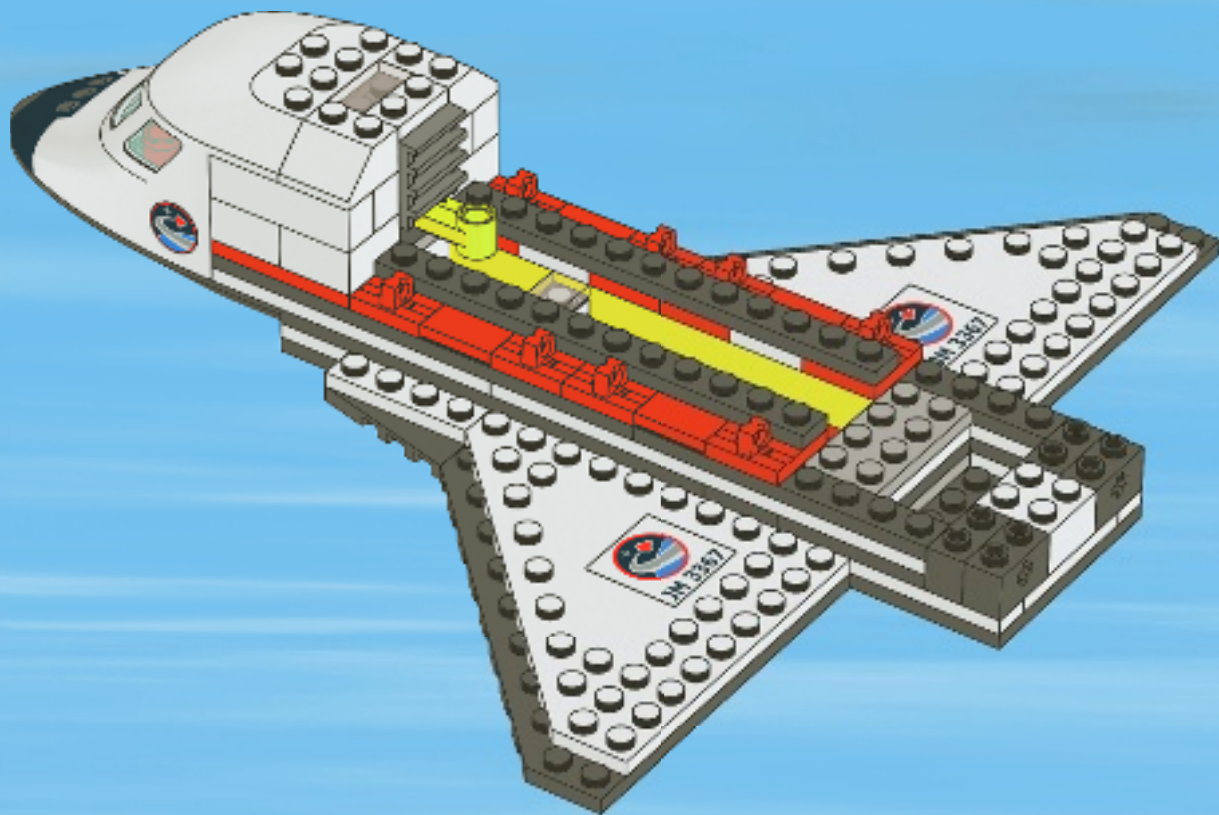

36

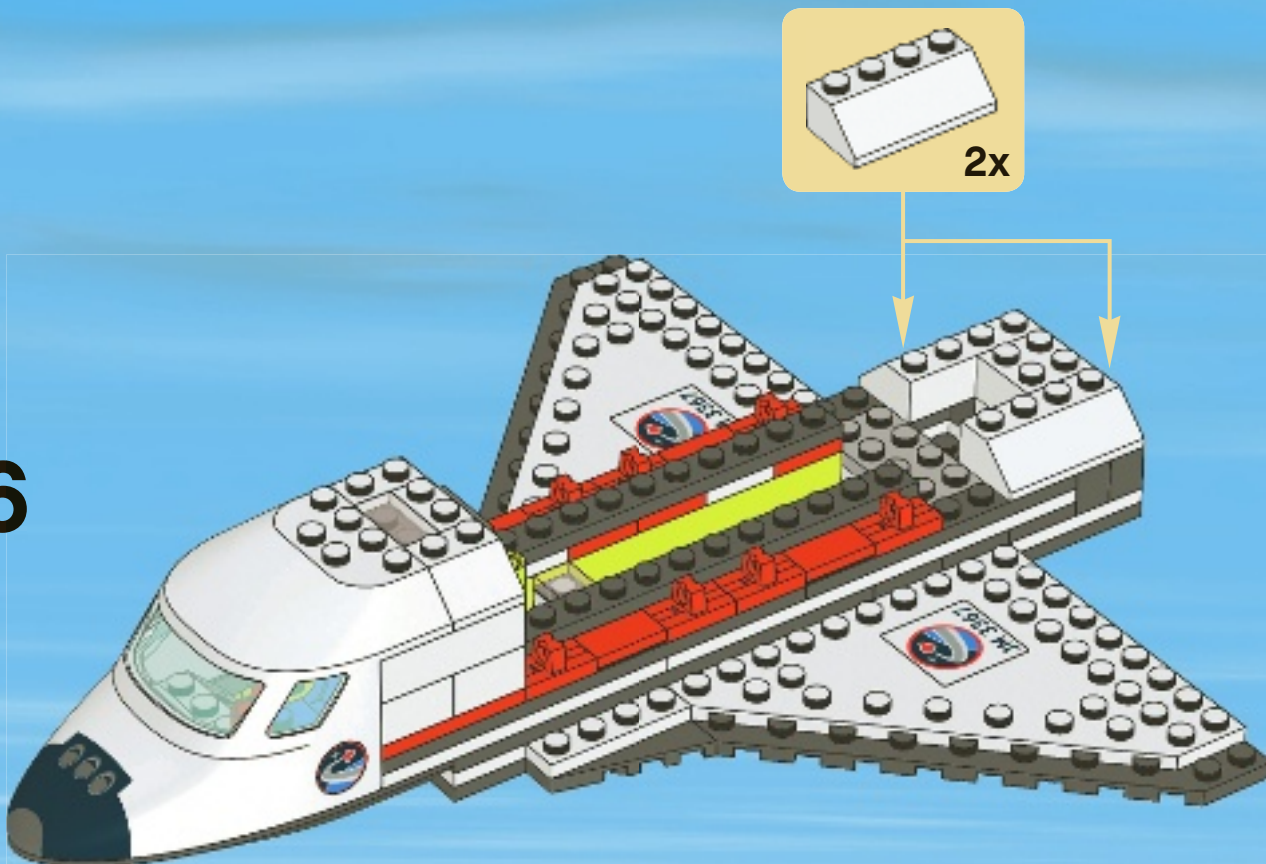

1

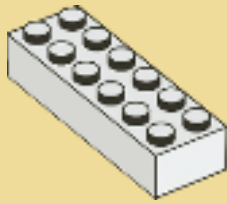

2

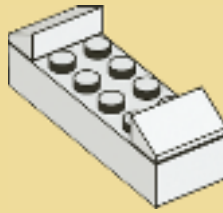

37

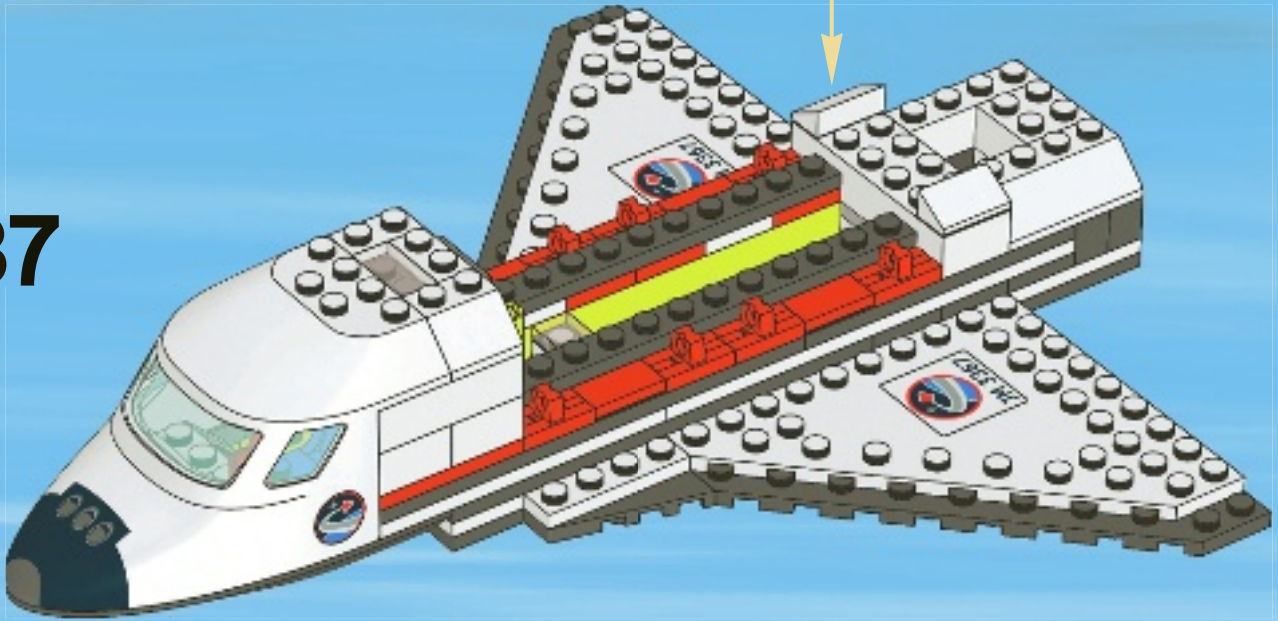

38

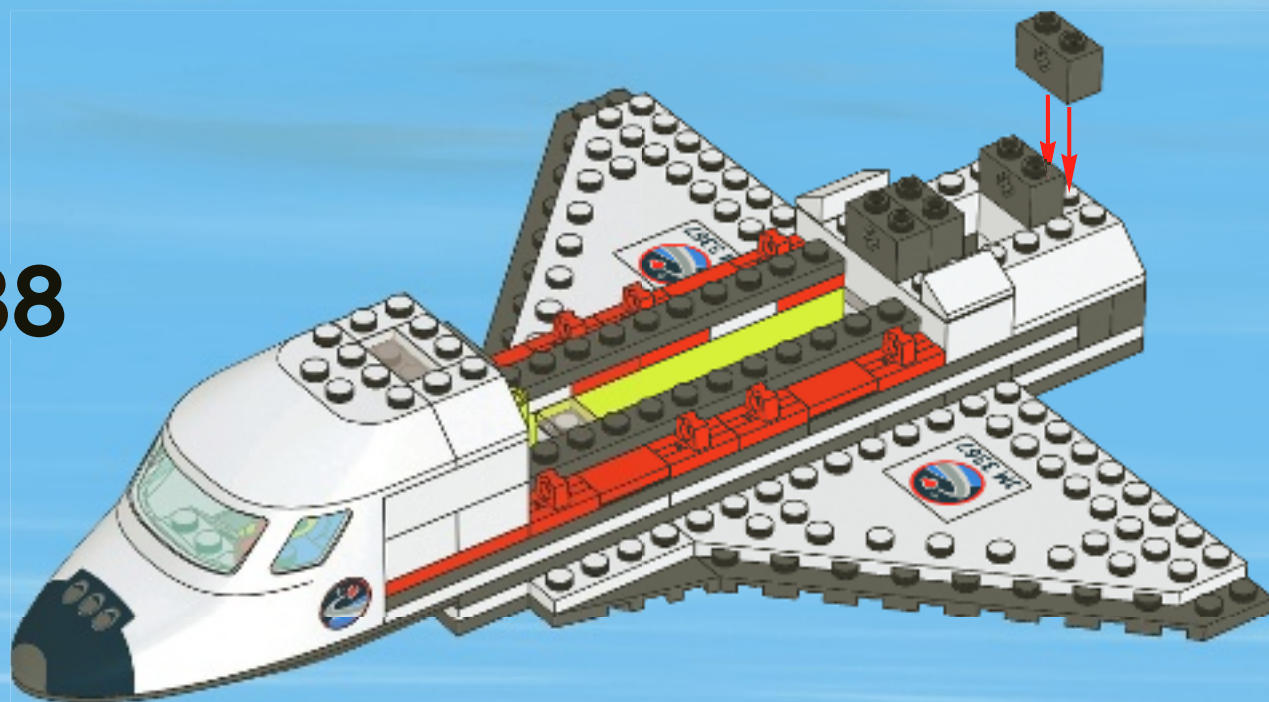

39

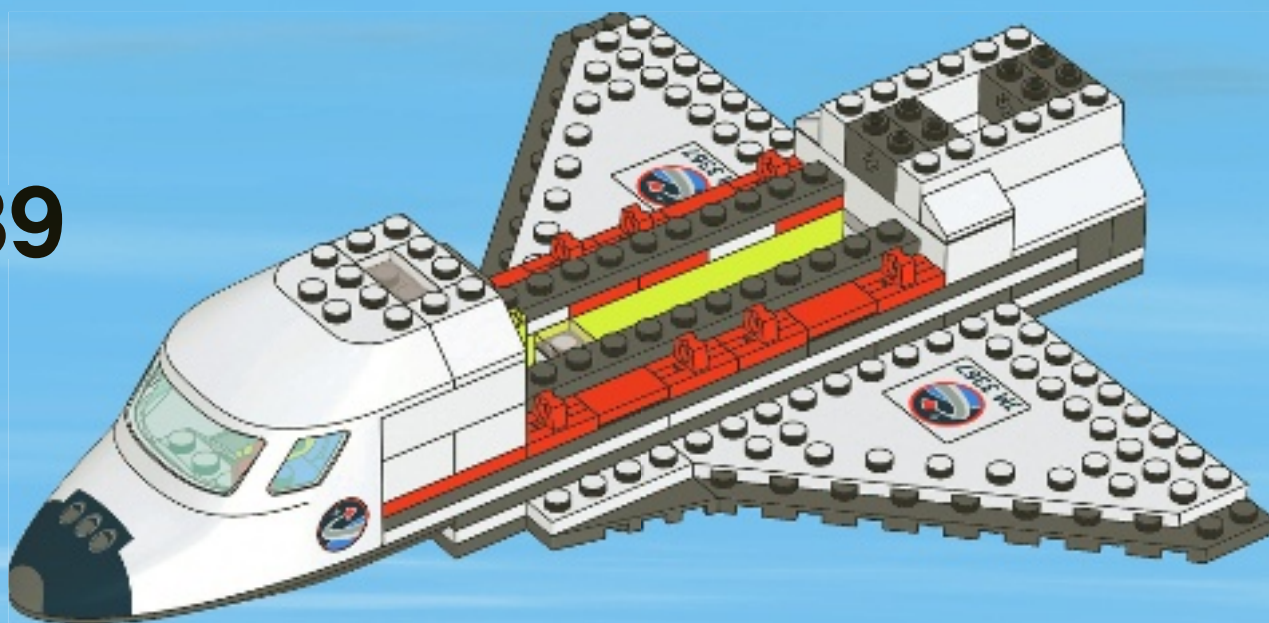

1



2

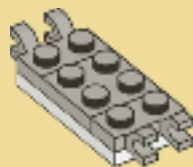

3

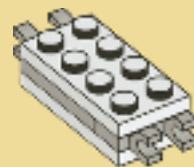

40

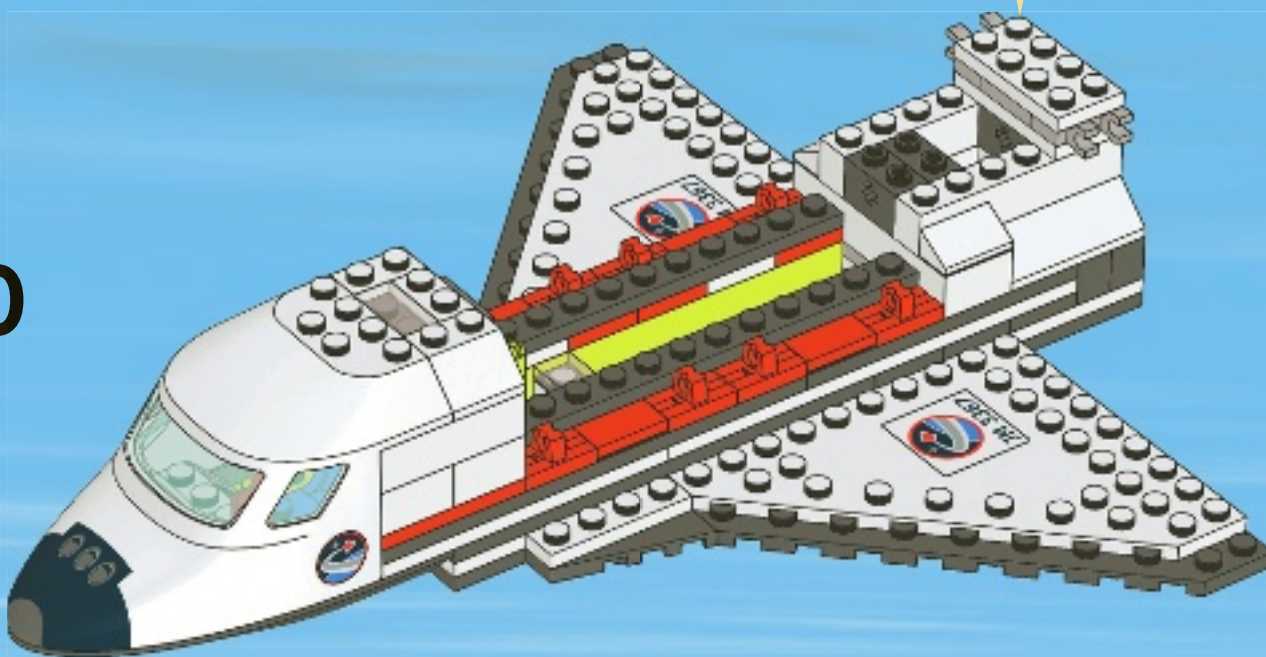

41

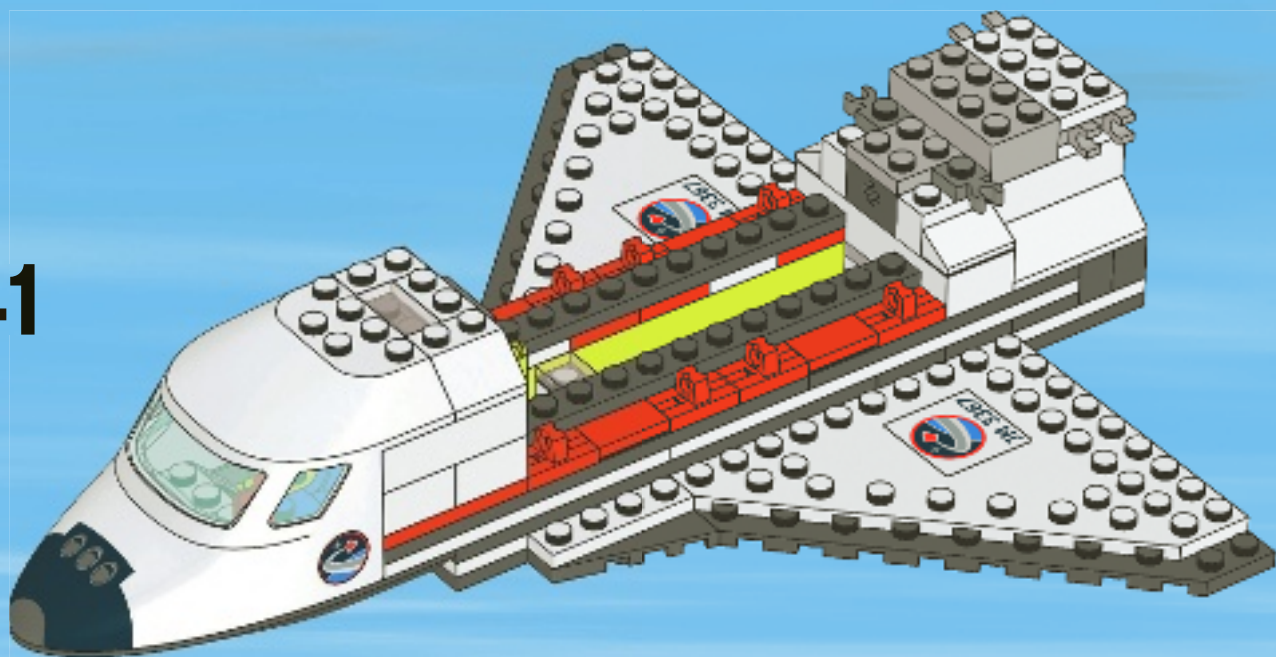

42

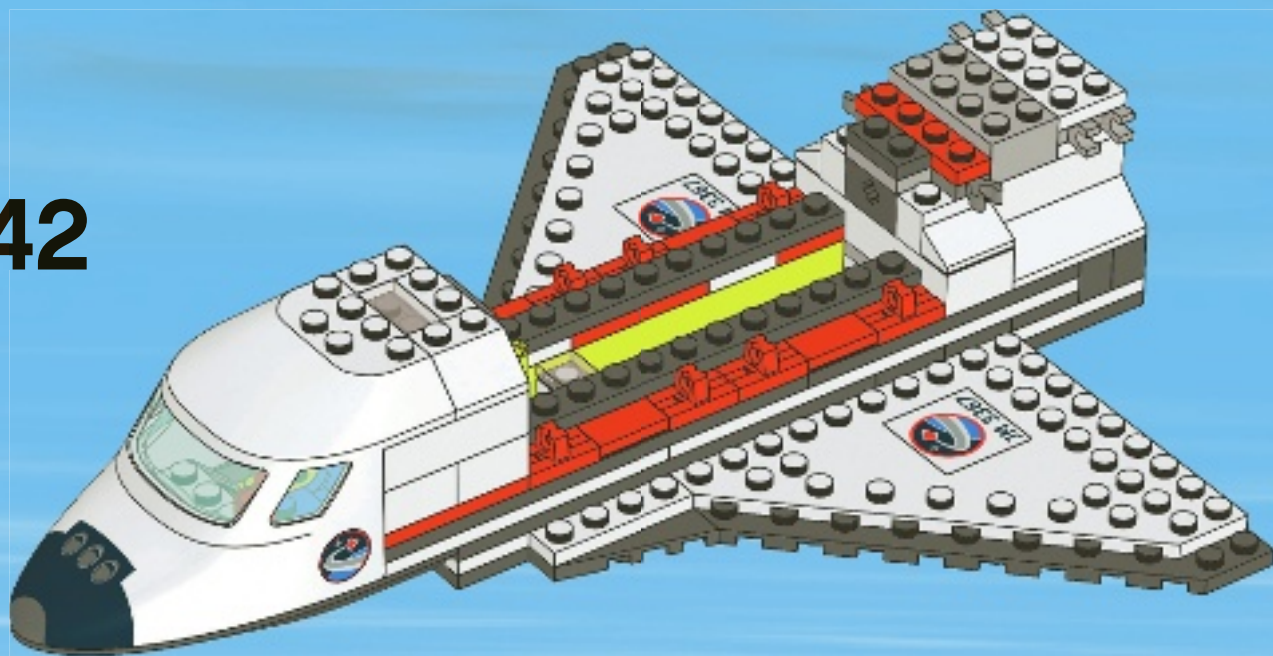

43

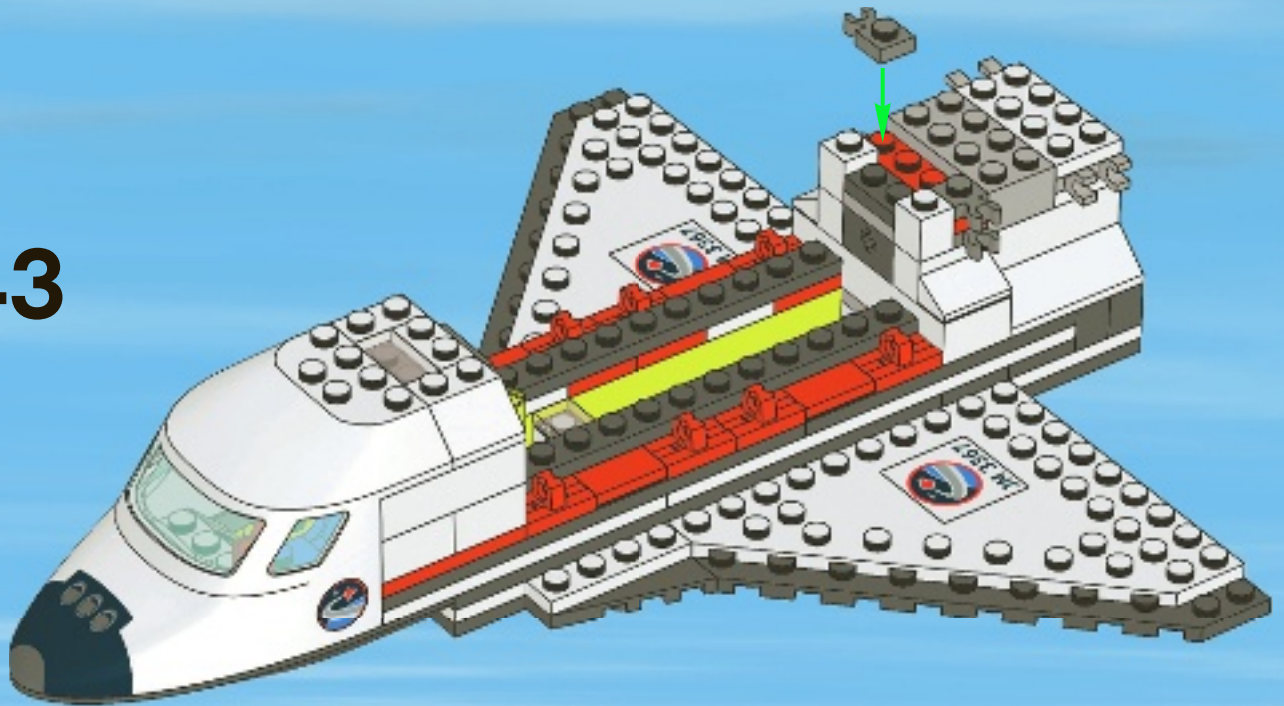

44

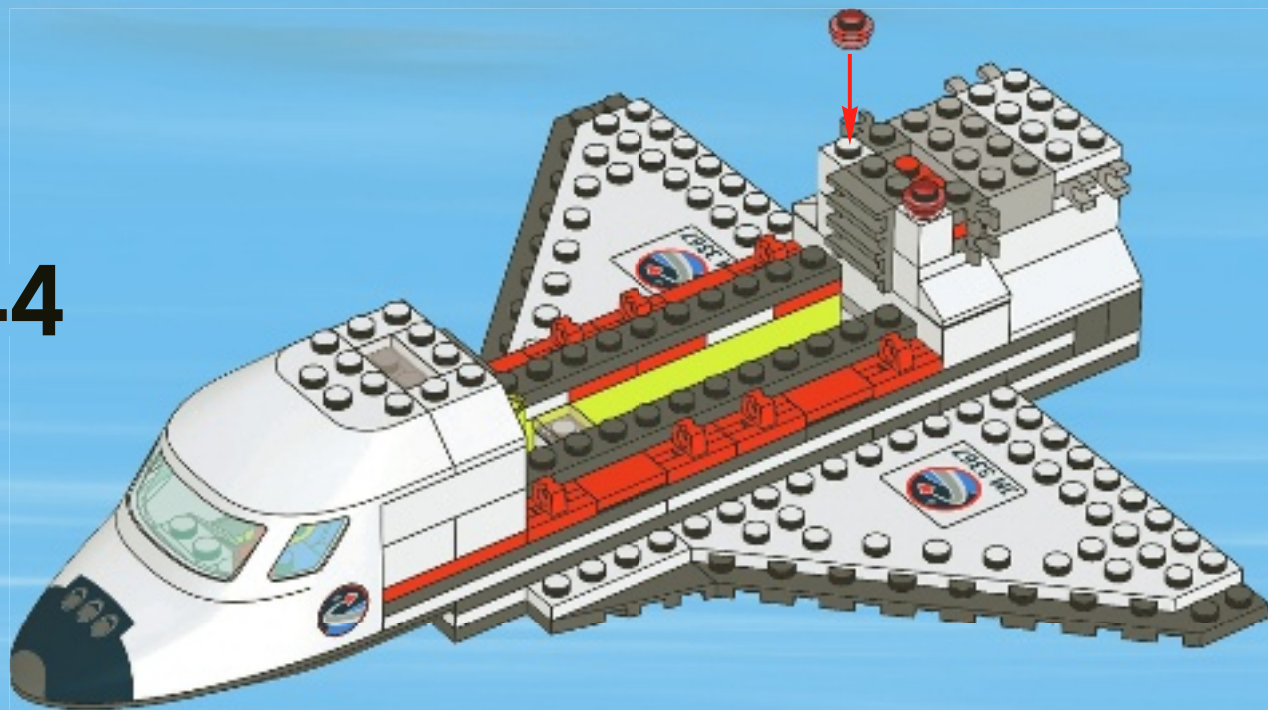

45

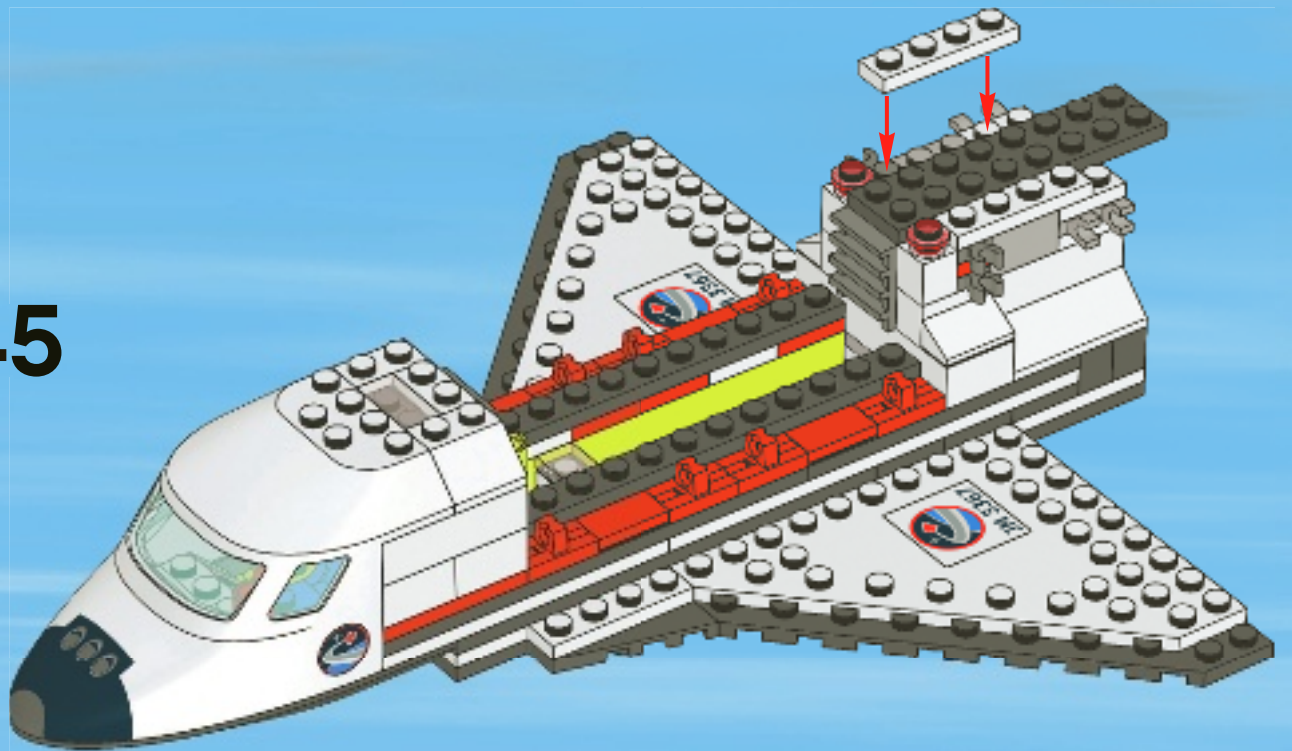

46

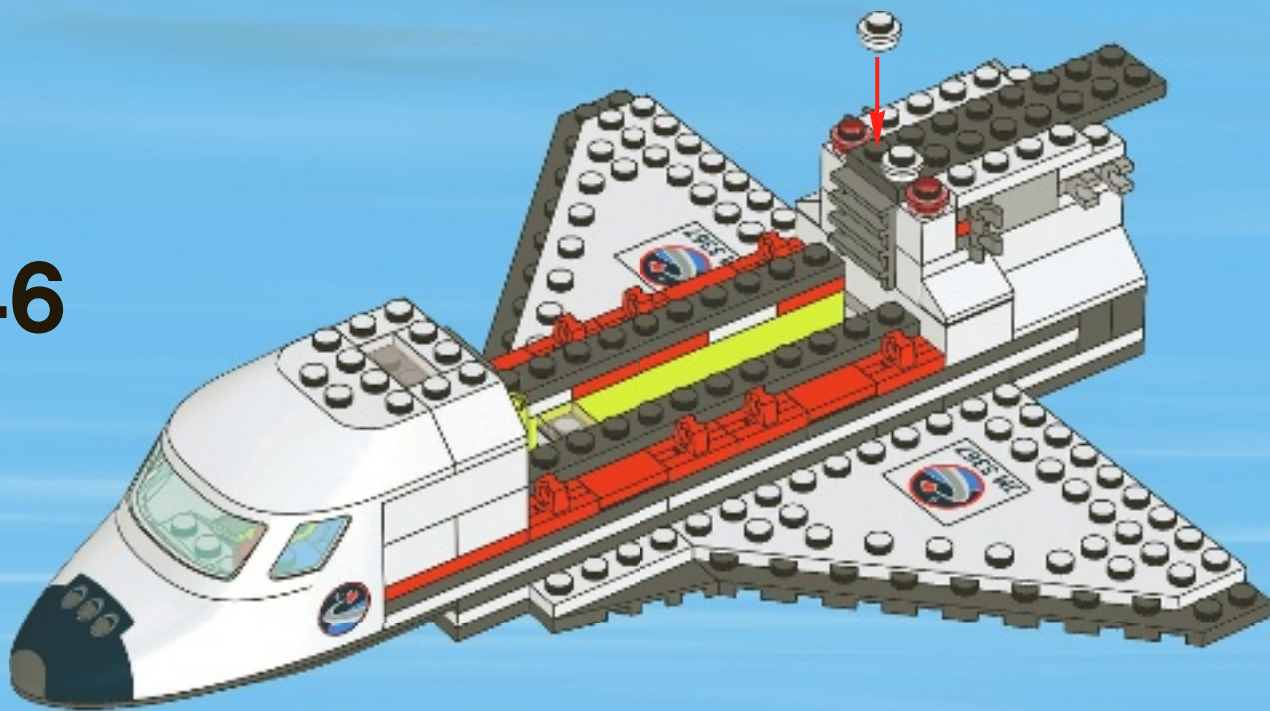

47

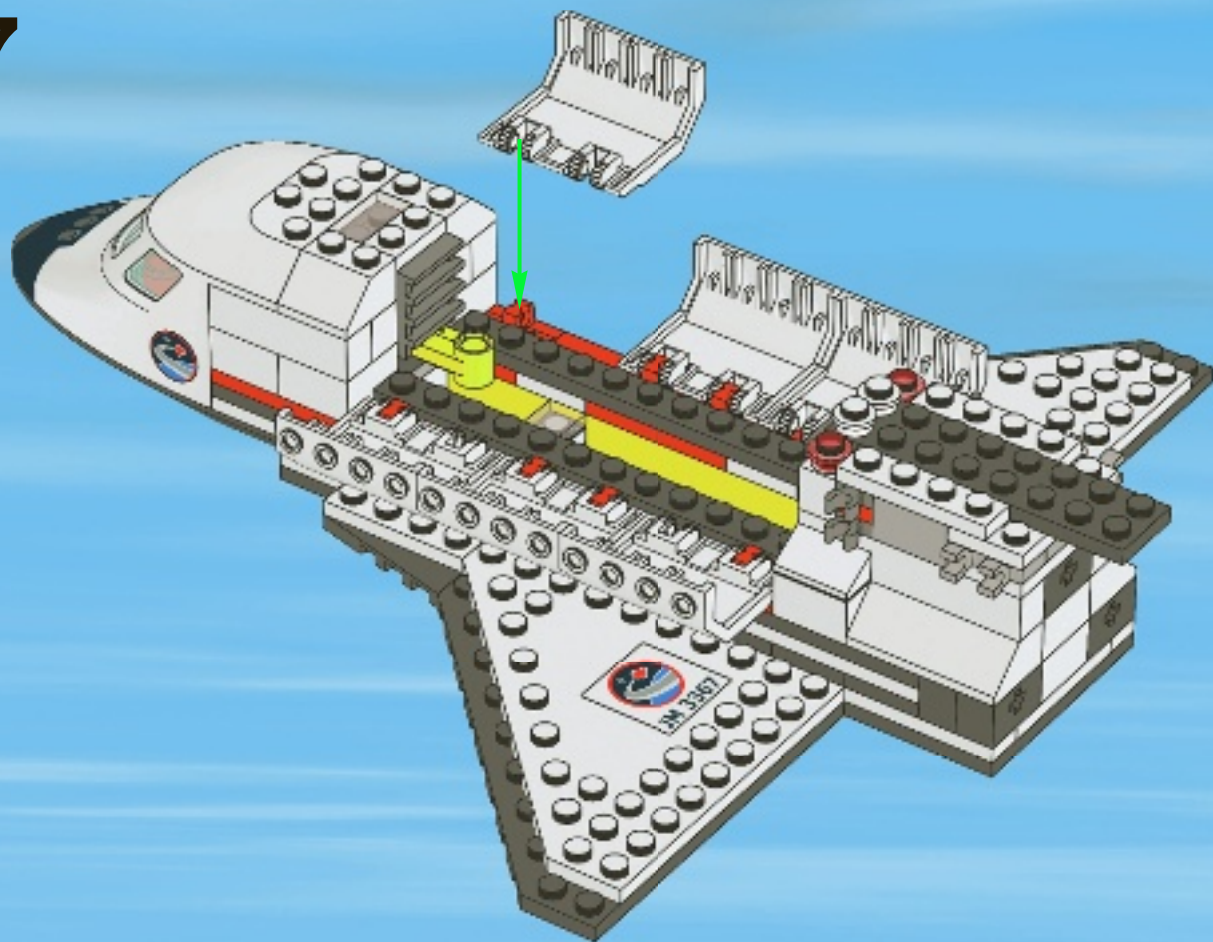

48

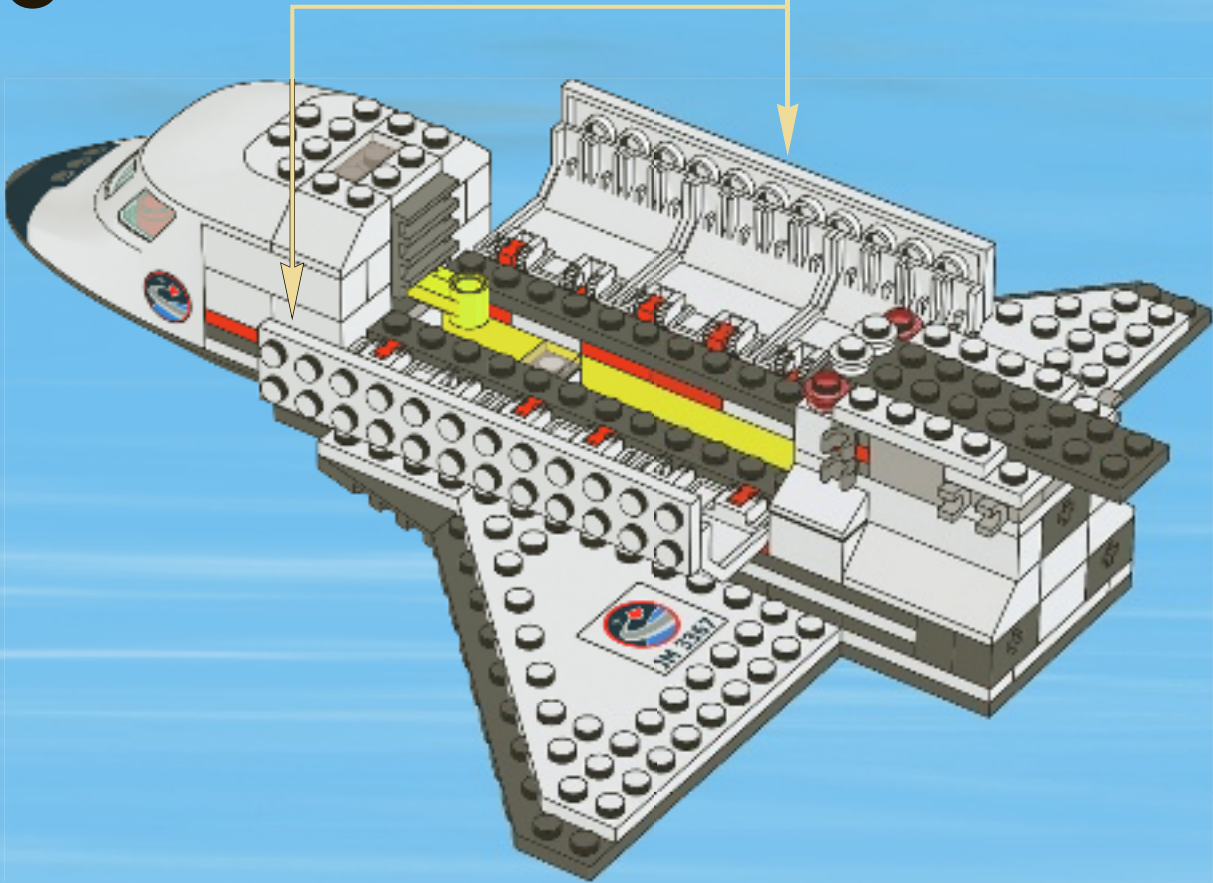
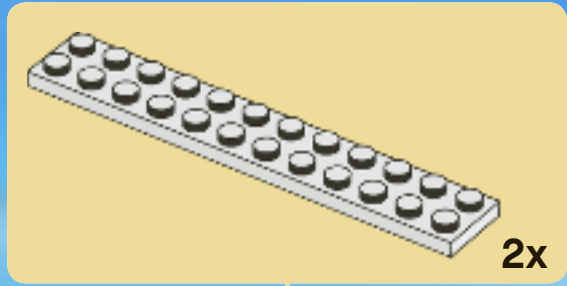

49

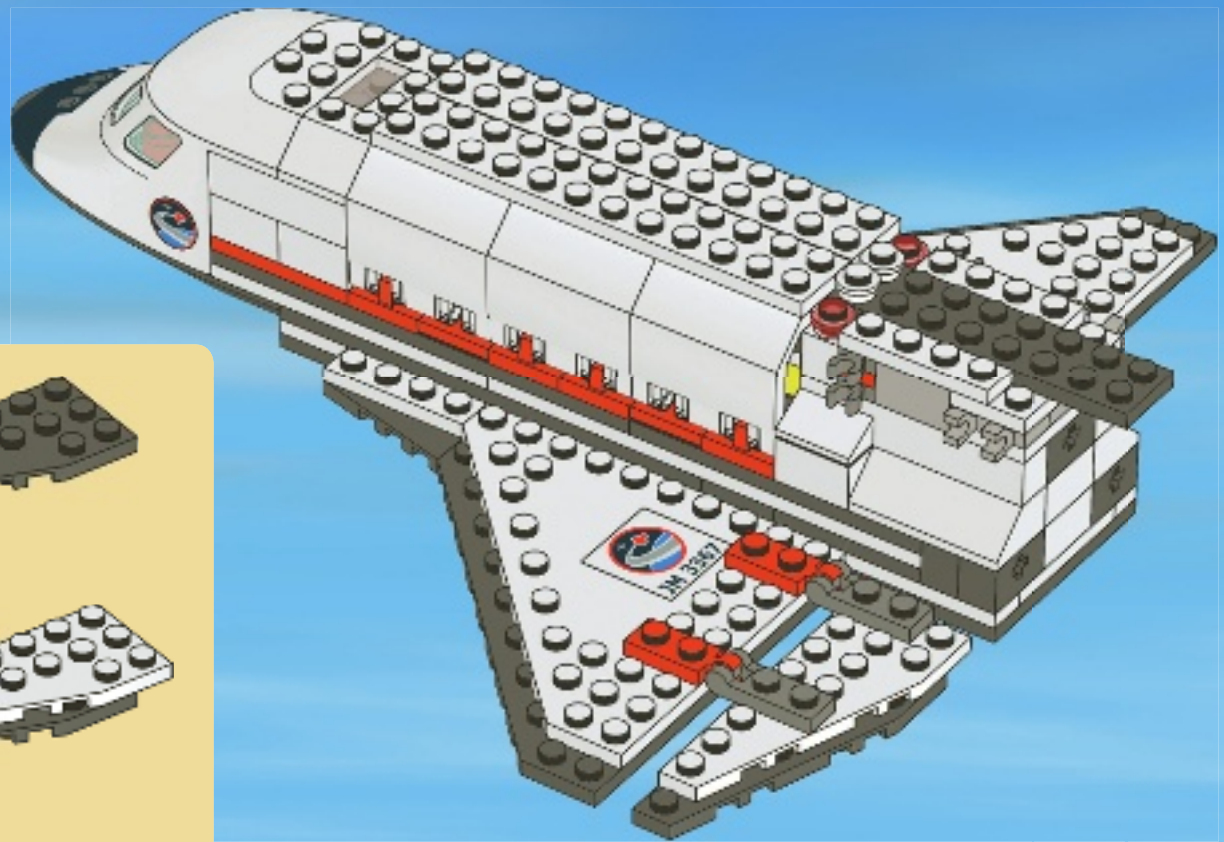

1



2

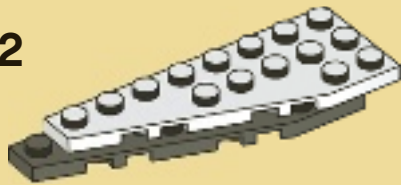

3

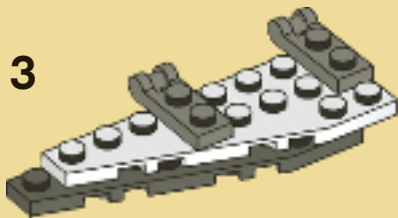

4

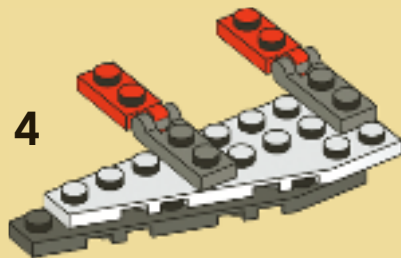

50

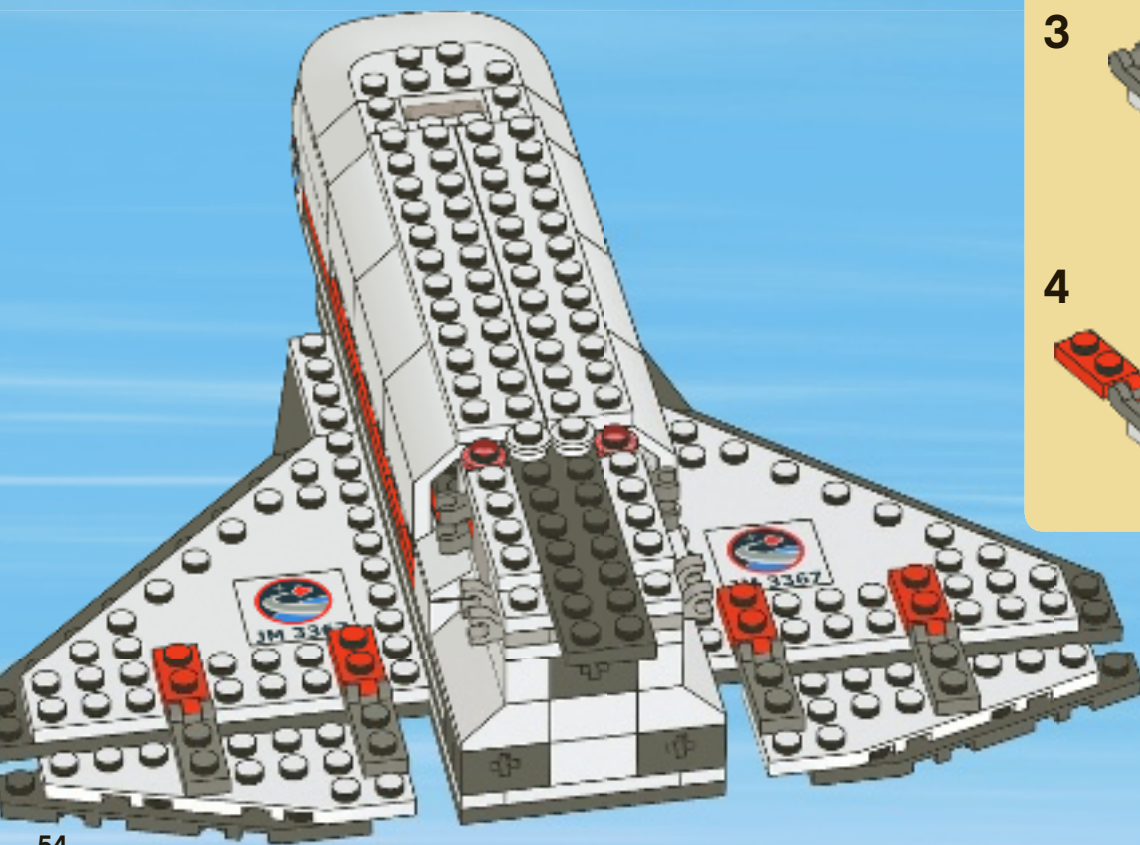

1



2

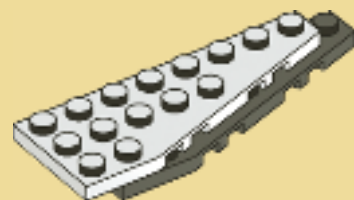

3



4



51

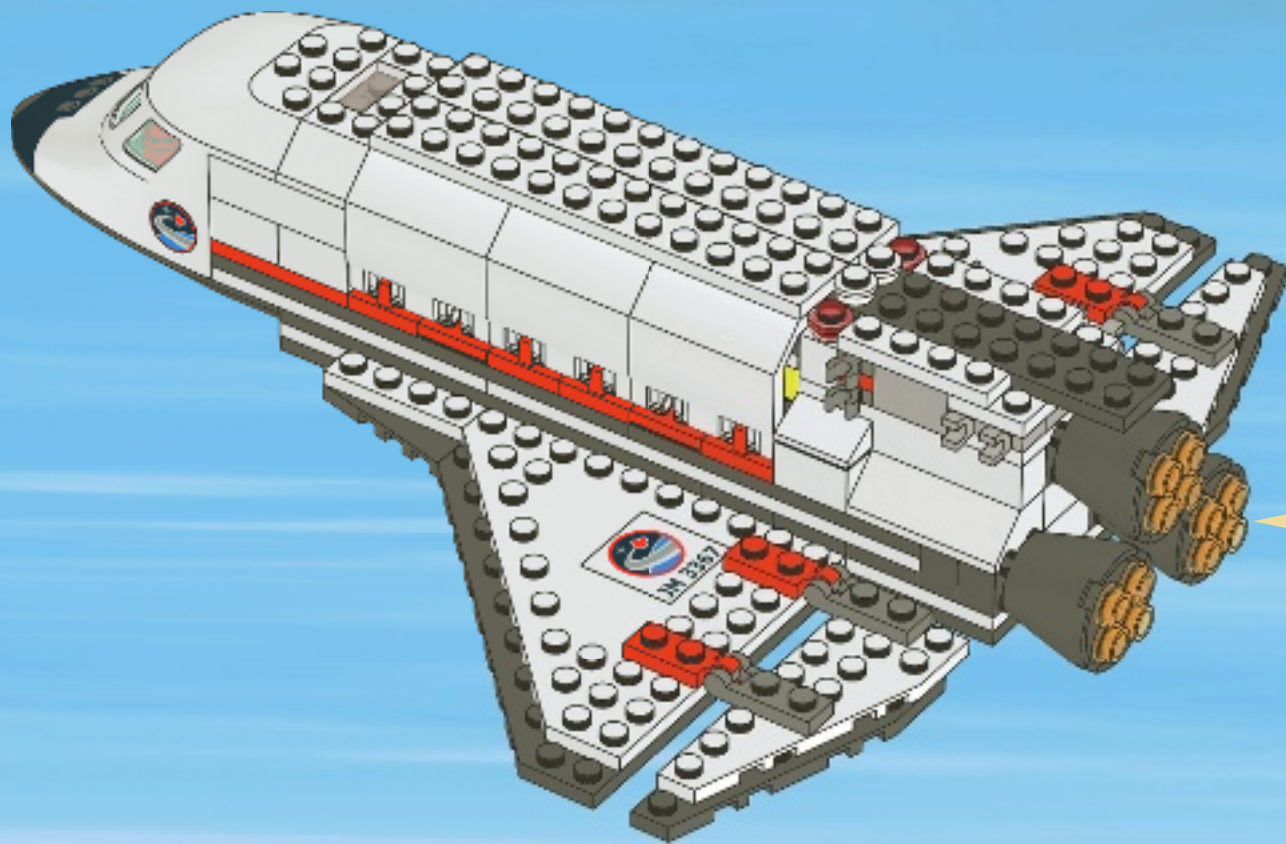

52

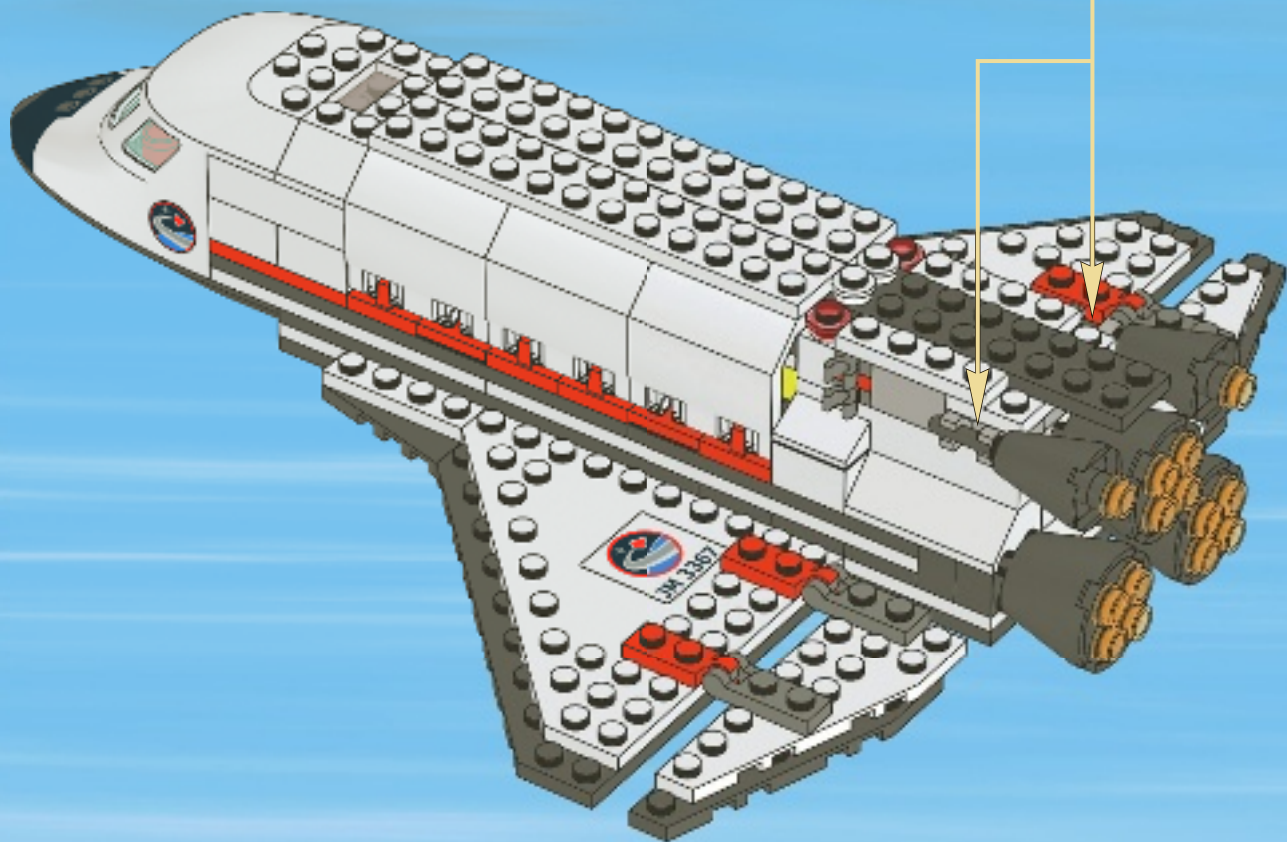

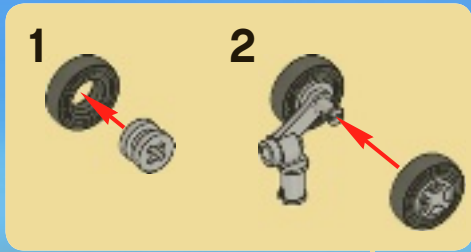

53

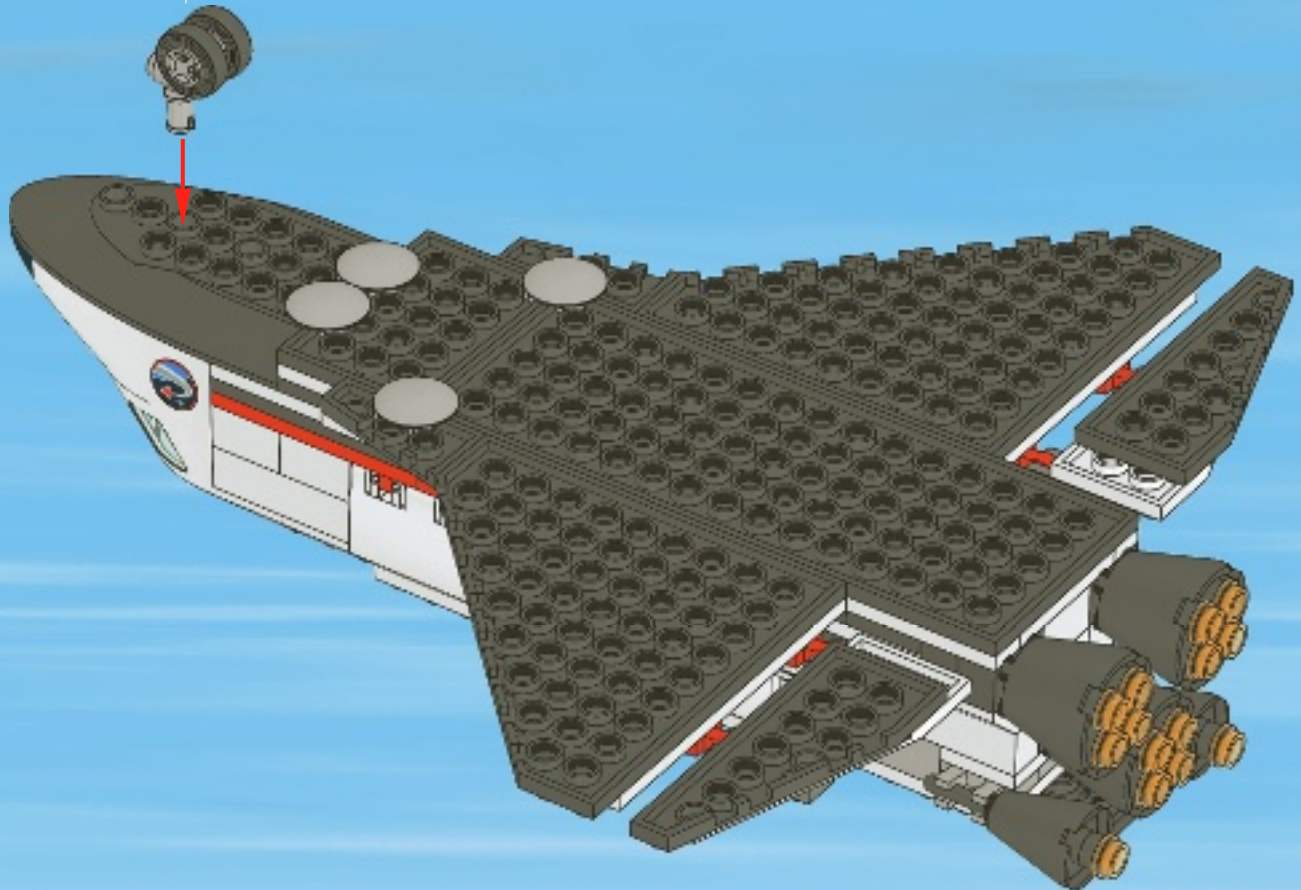

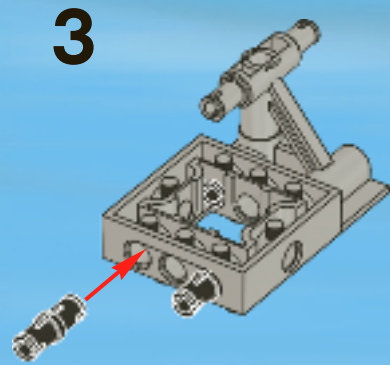
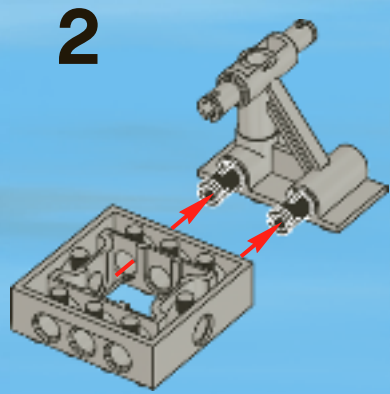
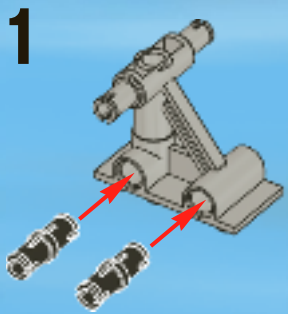

4

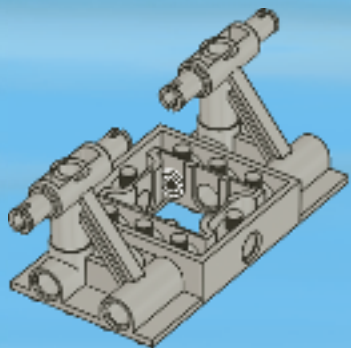

5

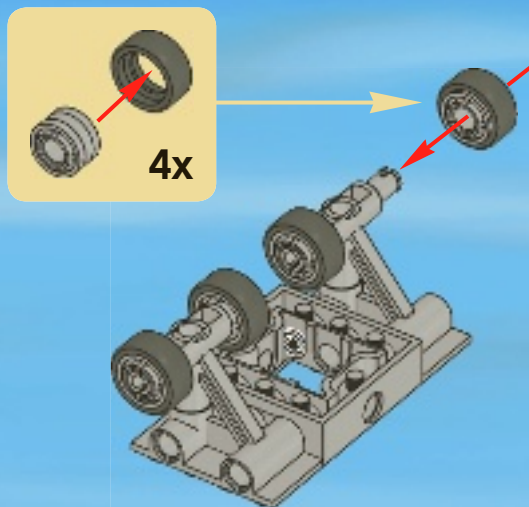

54

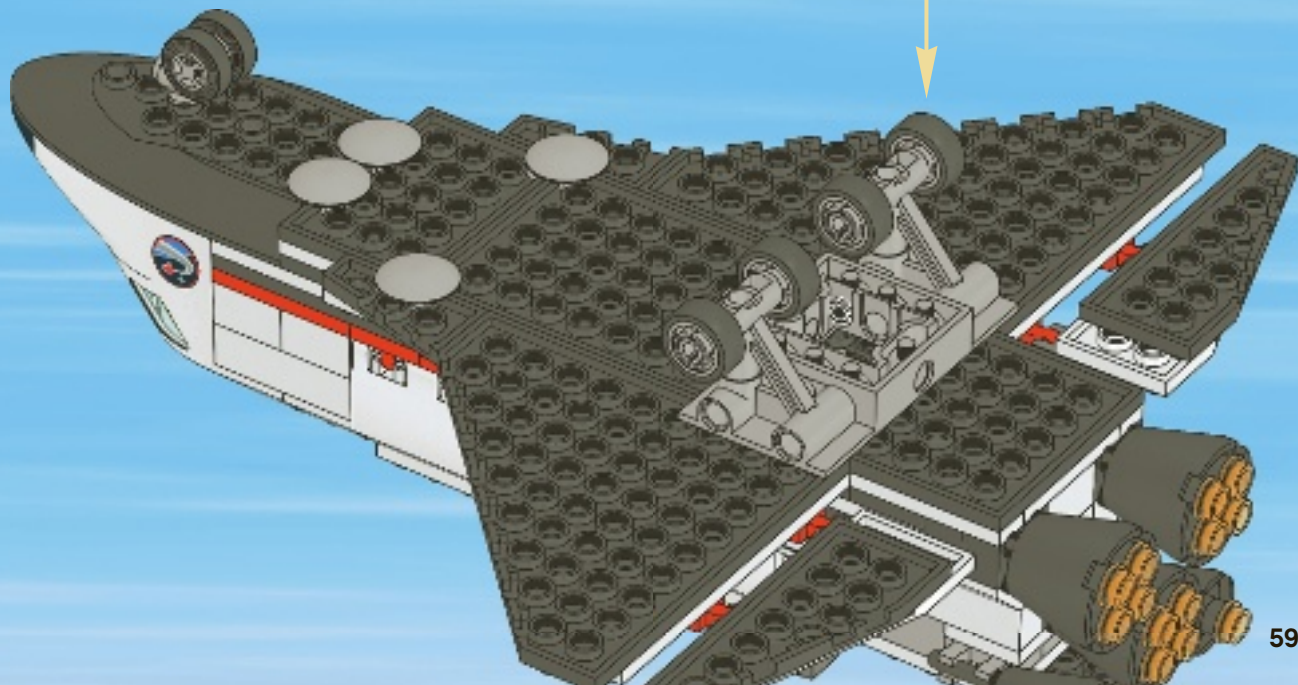

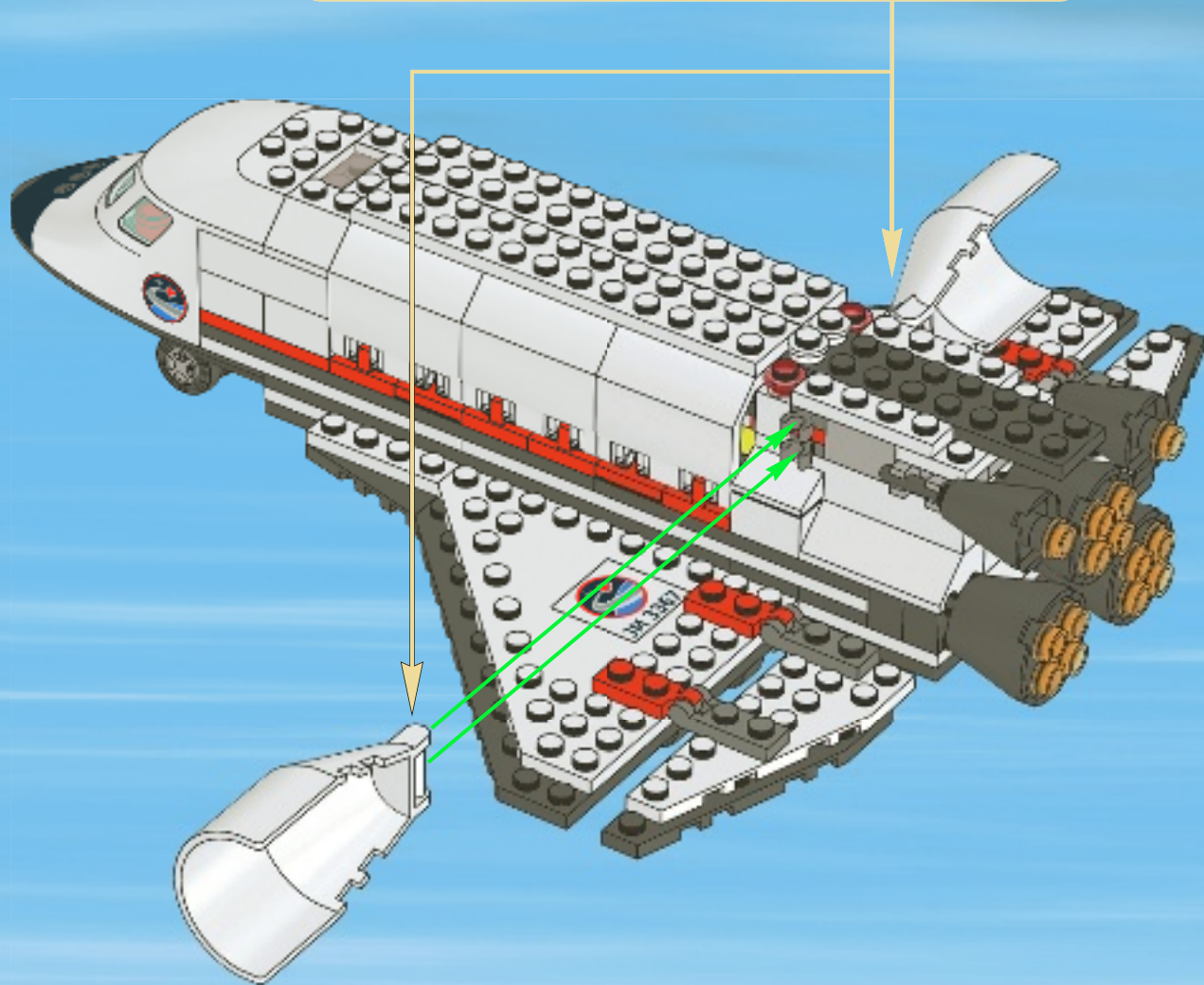
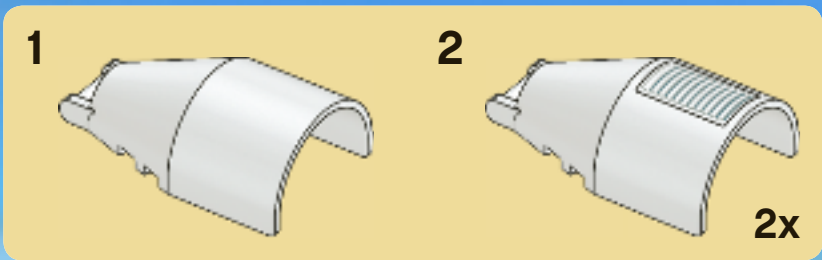

1

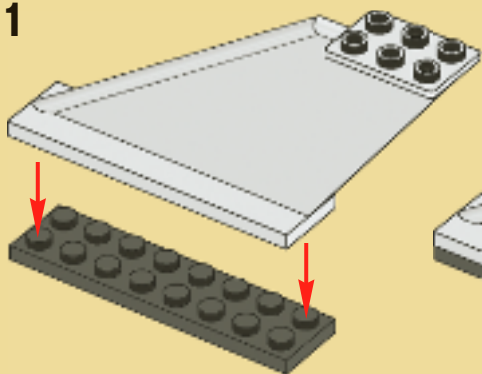

2

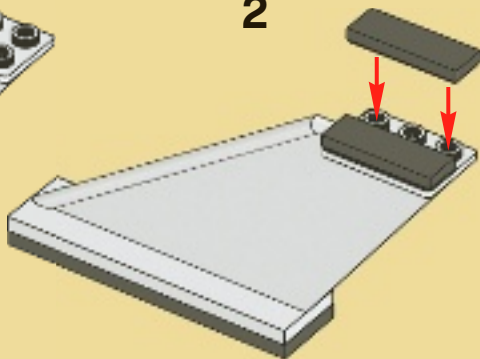

3

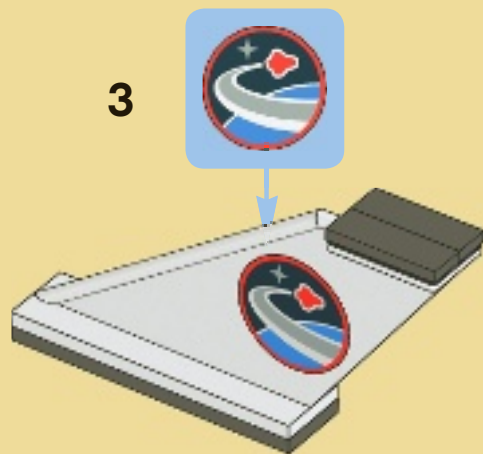

56

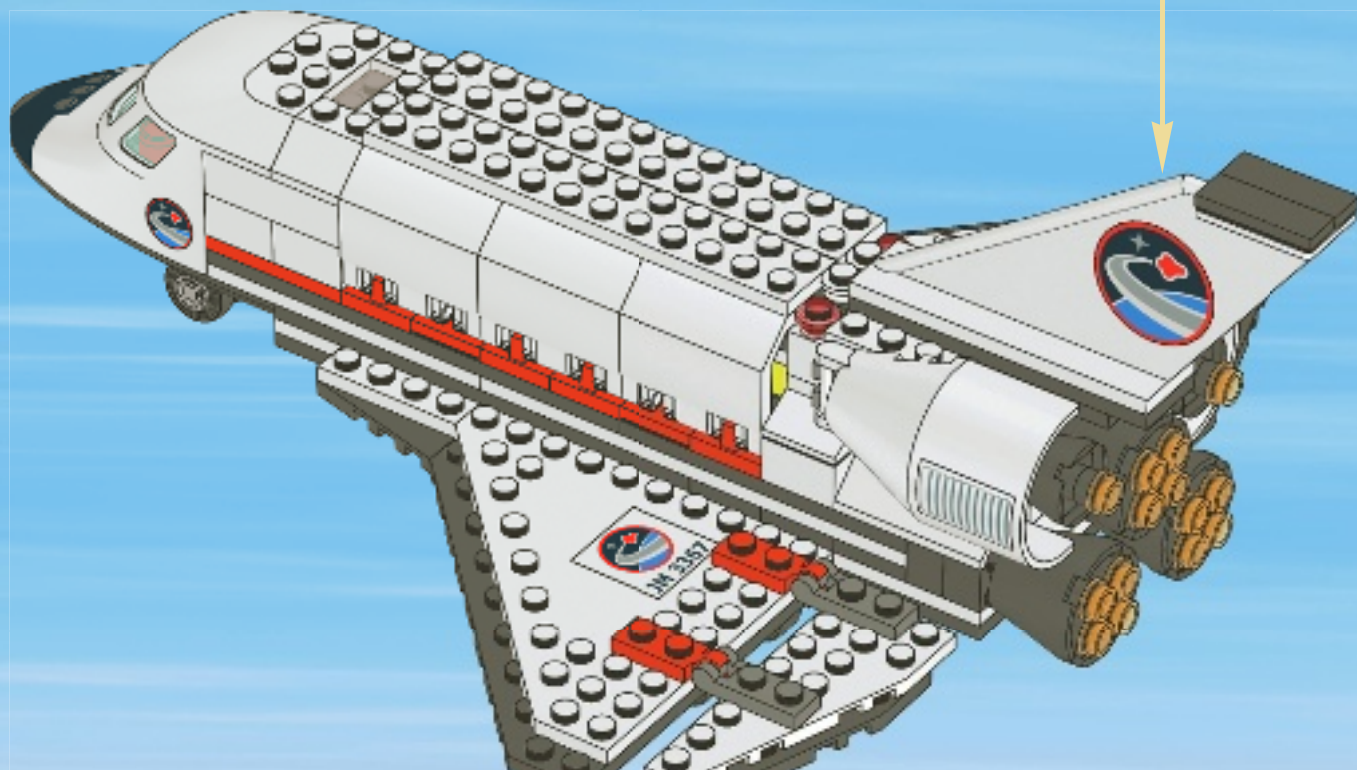

1

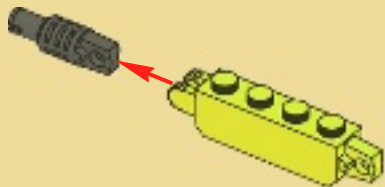

2

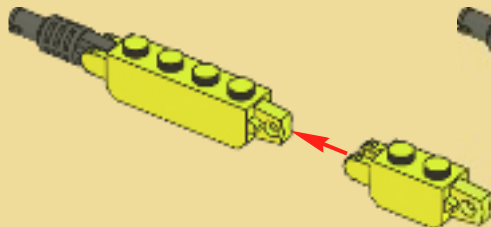

3

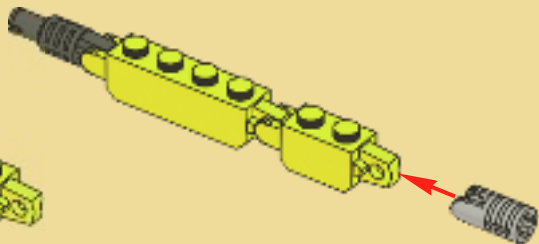

57

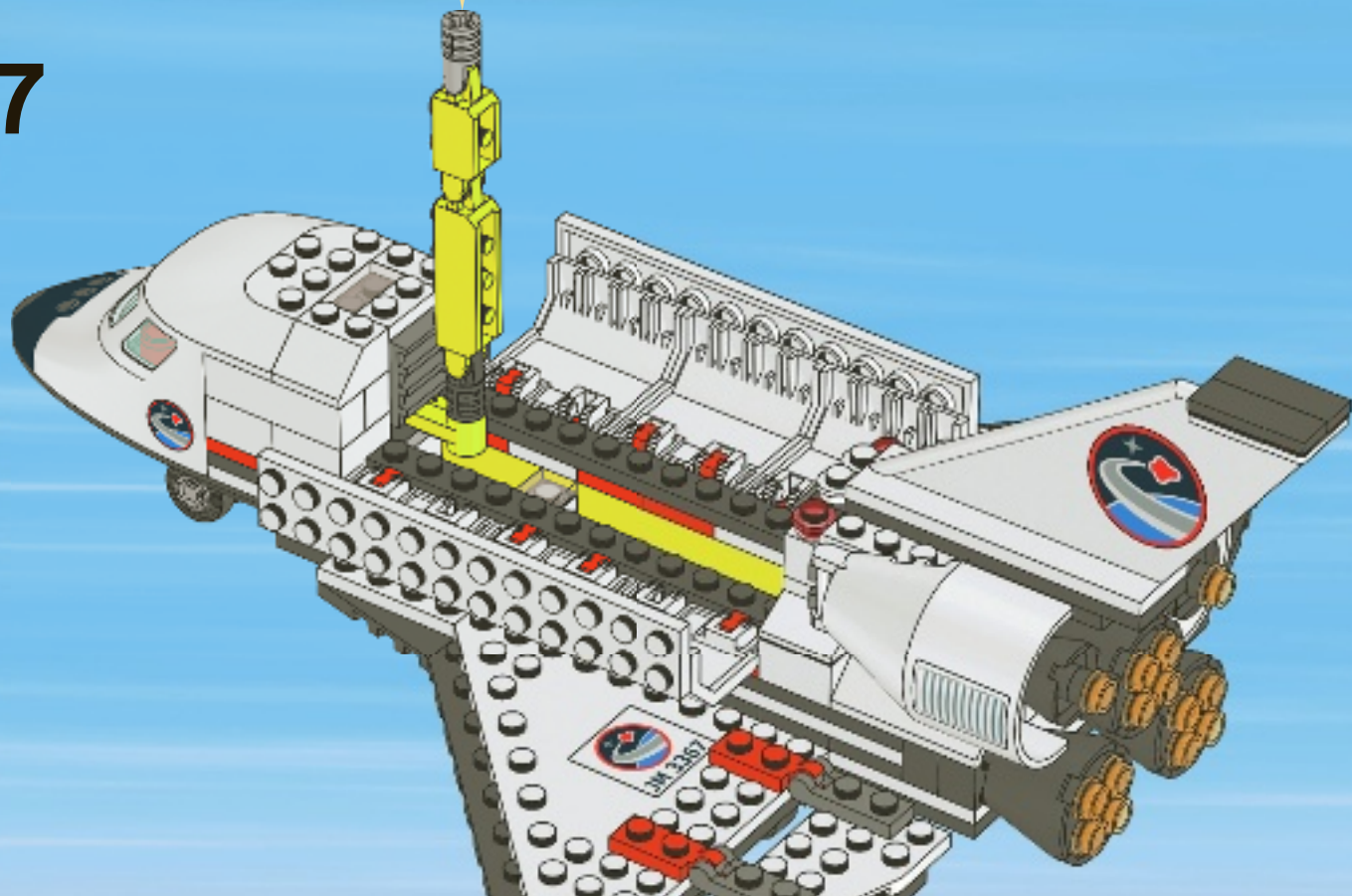

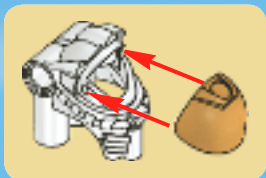
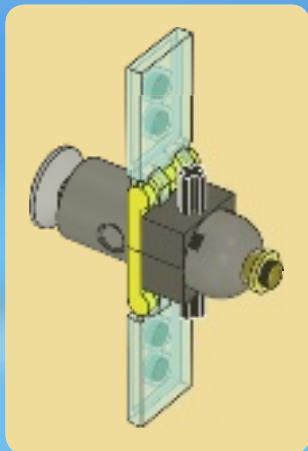

58

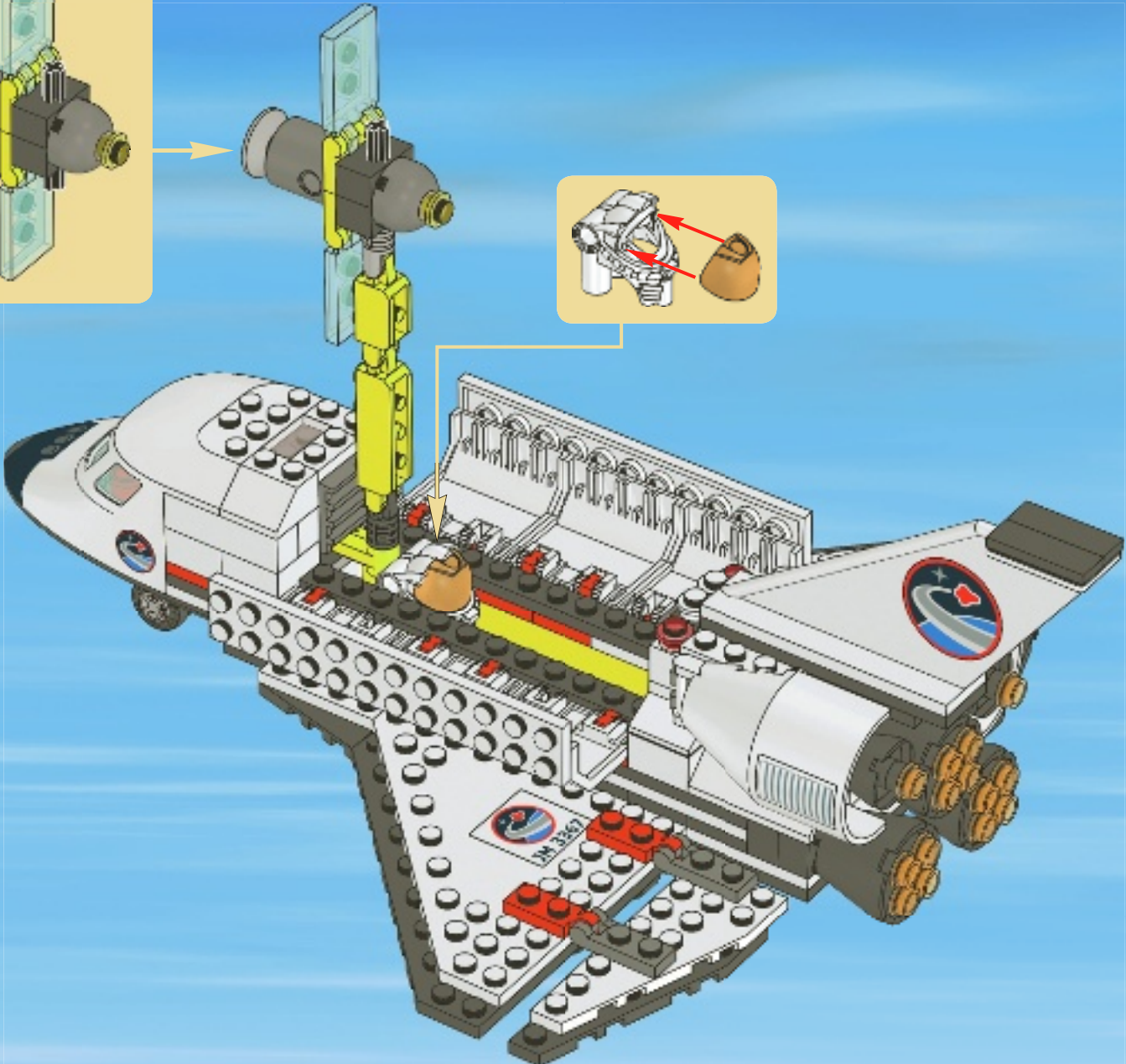

59

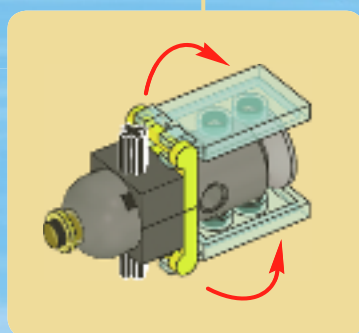

60

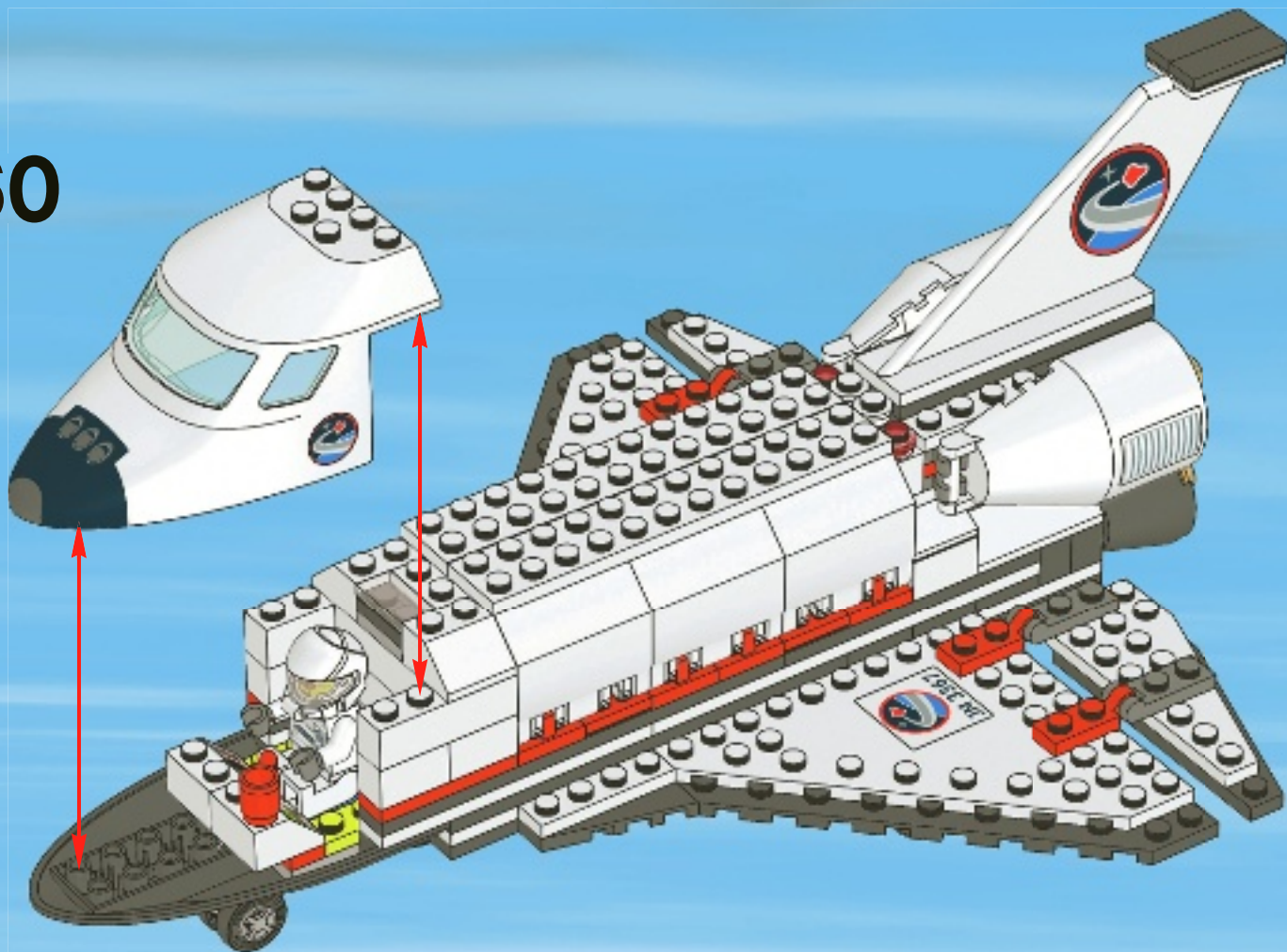

The LEGO CITY logo is located in the top left corner. It consists of the word "LEGO" in its signature white font on a red background, followed by the word "CITY" in a blue, stylized font.The word "CITY" is part of the LEGO CITY logo, rendered in a blue, stylized font.

An astronaut's Feet can be attached to the end of the Canadian arm to position him or her at a specific location for work in space.

Les pieds d'un astronaute peuvent être attachés à l'extrémité du Bras Canadien afin de le positionner à l'endroit précis où il doit travailler dans l'espace.

Los astronautas pueden sujetar sus pies al extremo de un brazo mecánico denominado Canadarm para alcanzar una posición específica y llevar a cabo su labor en el espacio.

NASA Astronaut



LEGO

CITY



438 days was the longest duration for single human space mission.

La mission spatiale humaine la plus longue en un seul vol a été de 438 jours.

La misión espacial más larga en la que han intervenido seres humanos duró 438 días.

“Happy Birthday” was the first song to be performed in space.

« Happy Birthday » a été la première chanson chantée dans l'espace.

La primera canción que se cantó en el espacio fue “Cumpleaños Feliz”.

NASA Space Shuttle





The Space Shuttle's total thrust at liftoff is 7.8 million pound-force.

La poussée totale de la navette spatiale lors du décollage est de 7,8 millions de livre-force.

Al despegar, una lanzadera espacial desarrolla un empuje total de 34,7 millones de newtons.

NASA Space Shuttle



The LEGO CITY logo is located in the top left corner. It consists of the word "LEGO" in its signature yellow font on a red background, followed by the word "CITY" in a blue, stylized font.The word "CITY" is part of the LEGO CITY logo, rendered in a blue, stylized font.

**If someone next to you
shouted in the vacuum of space you wouldn't be able
to hear them.**

Si une personne située à côté de vous dans le vide spatial crieait,
vous ne pourriez pas l'entendre.

Si alguien gritara junto a ti en el vacío del espacio, no podrías oírle.



A Space Shuttle is used to launch satellites, space telescopes and to fix other spacecraft.

Une navette spatiale sert à lancer des satellites, des télescopes spatiaux et à réparer les autres vaisseaux spatiaux.

Un transbordador espacial sirve para lanzar satélites y telescopios espaciales, así como para solucionar los problemas de otras naves.



A School bus can fit in the payload bay of the Space Shuttle.

Un bus scolaire peut entrer dans la soute de la navette spatiale.

La bodega de carga de un transbordador espacial podría albergar un autobús escolar.

NASA Space Shuttle



NASA Astronaut



Astronauts are up to 2 inches taller while they are in space. This is due to lack of spinal compression by gravity.

Les astronautes sont jusqu'à 5 cm plus grands lorsqu'ils sont dans l'espace. Ceci est dû à l'absence de compression de la colonne vertébrale par la gravité.

La altura de los astronautas aumenta hasta 5 centímetros durante su estancia en el espacio. Ello se debe a que la columna vertebral no sufre la compresión que la gravedad causa sobre ella.





CITY



3365



3366



3367



3368

LEGO CITY



7279



7285



7286



7287



7288



7498



www.LEGOclub.com



LEGO® Club Email

LEGO club™

FREE! GRATIS! GRATUIT!



LEGO® Club Magazine

SIGN UP ONLINE!

www.LEGOclub.com



00800 5346 5555*



1-866-534-6258 • 1-877-518-5346

US & Canada only

Canada seulement

* Freephone. Mobile charges may apply.
* Numéro sans frais. Des frais peuvent s'appliquer avec les téléphones cellulaires.
* Gebührenfrei. Kosten für Anrufe aus Mobilfunknetzen können abweichen.
* Gratis telefonnummer vanaf vaste lijn.
* Det er et gratis nummer, når du ringer fra fasttelefon.
* Det är gratis, när du ringer från en fast telefon.
* Numéro sans frais. Des frais peuvent s'appliquer avec les téléphones portables.



Customer Service
Kundenservice
Service Consommateurs
Servicio Al Consumidor

www.lego.com/service or dial



: 00800 5346 5555
 : 1-800-422-5346



WIN!

Go to www.LEGOsurvey.com/product to fill out a survey for a chance to win a cool LEGO® Product. No purchase necessary. Open to all residents where not prohibited.

 www.LEGO.com



www.LEGOsurvey.com/product

GEWINNE! WIN!

Nimm an der Umfrage auf www.LEGOsurvey.com/product teil und hab die Chance ein cooles LEGO® Produkt zu gewinnen!

Die Teilnahme am Gewinnspiel führt zu keinerlei Kaufverpflichtungen. Teilnahme in allen nicht ausgeschlossenen Ländern möglich.

Ga naar www.LEGOsurvey.com/product, vul een enquêteformulier in en maak kans op een cool LEGO® product.

Geen aankoopverplichting. Iedereen mag deelnemen, uitgezonderd ingezetenden van landen waar een enquêteverbod geldt.

GAGNE! 当てよう!

Visite www.LEGOsurvey.com/product pour répondre à un questionnaire et avoir une chance de gagner un produit LEGO® très cool!

Aucune obligation d'achat. Ouvert à tous les résidents des pays autorisés.

www.LEGOsurvey.com/product にアクセスして、アンケートにご記入ください。当選者にはレゴ®製品を差し上げます。

お買い上げの必要はありません。

禁止されていない限り、すべての皆様にご利用いただけます。