

**LEGO**

**SPORTS**

3429



4195742

 **NBA**



3427



3432



3430



3431







3560



3561



3562



3563



3564



3565



3566



3567



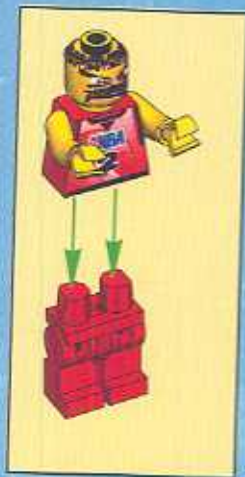

1

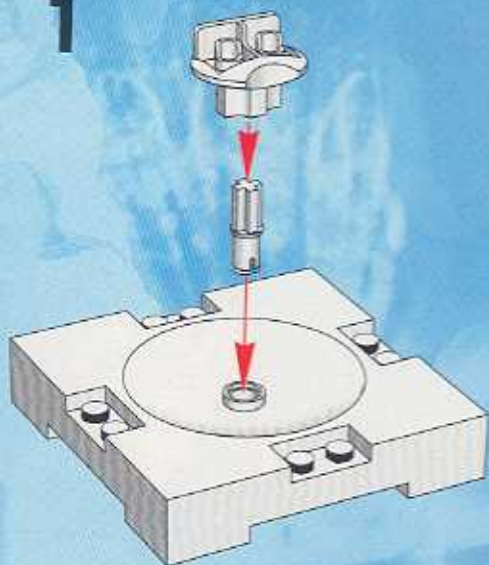



2



3



4

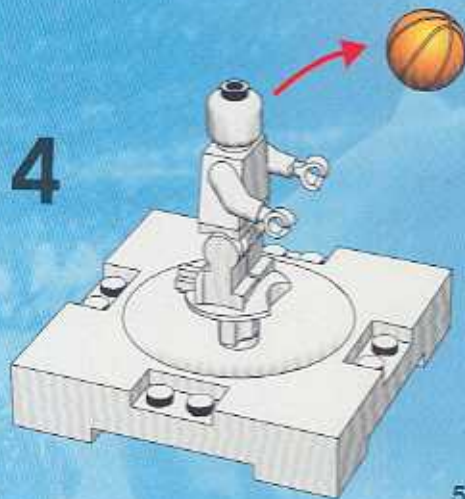

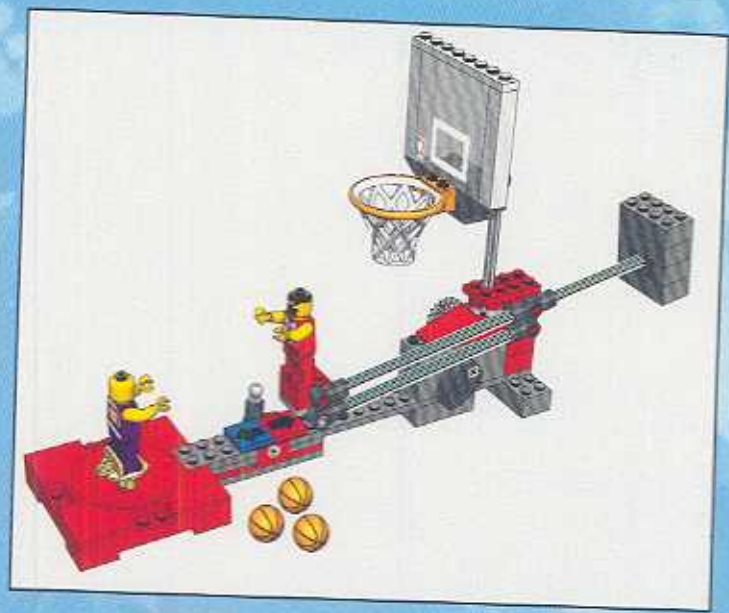

1

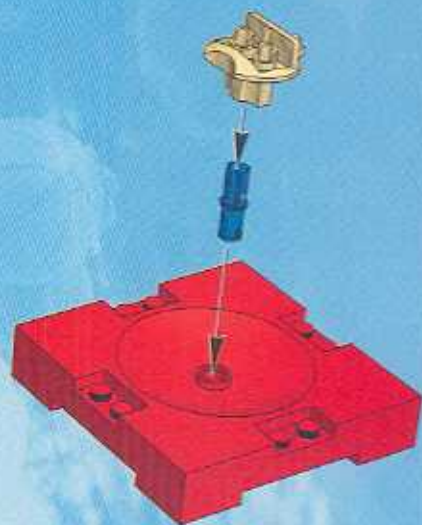

2

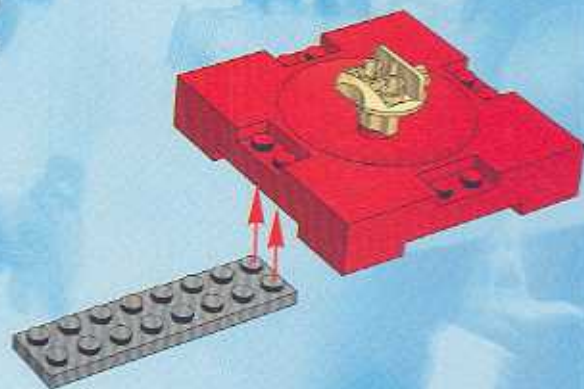



3

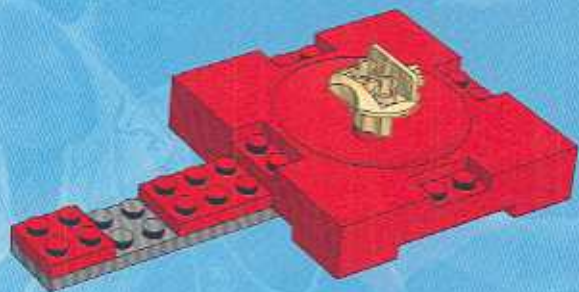

4

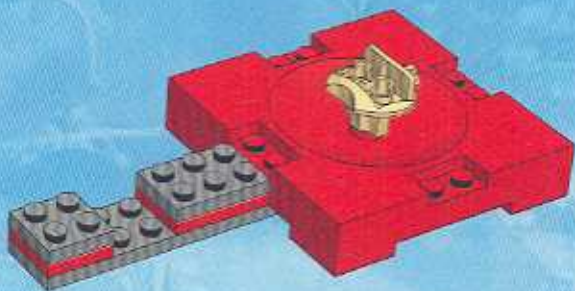

5

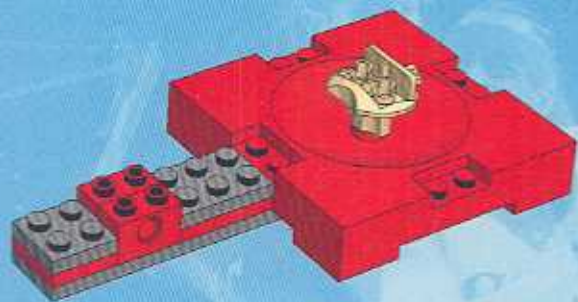

6

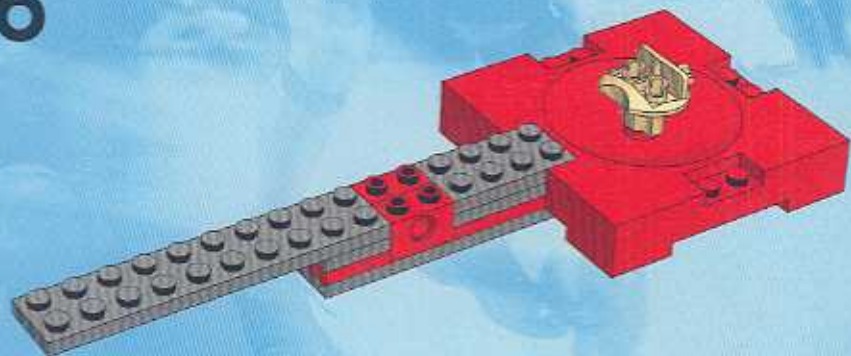



1



2

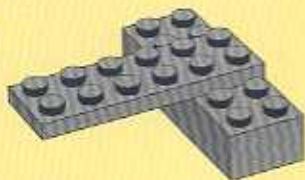

3

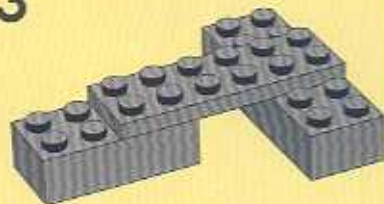

7

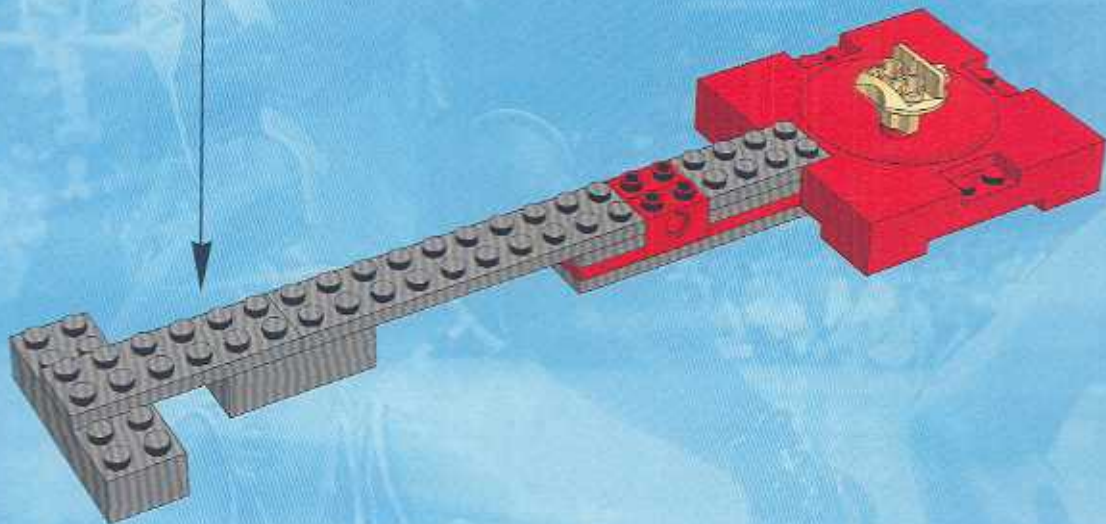

8

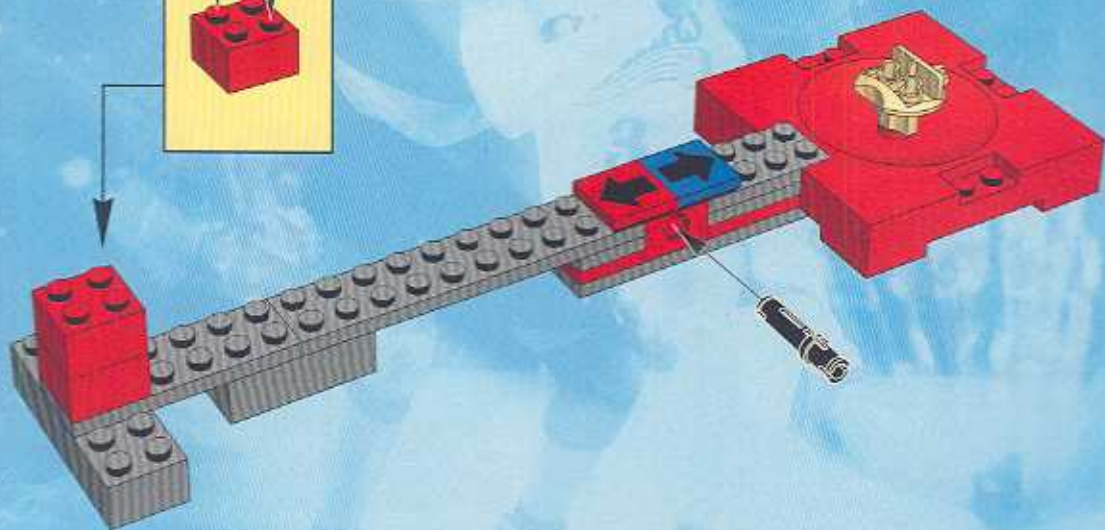
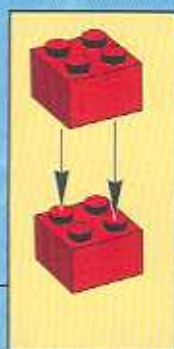



9

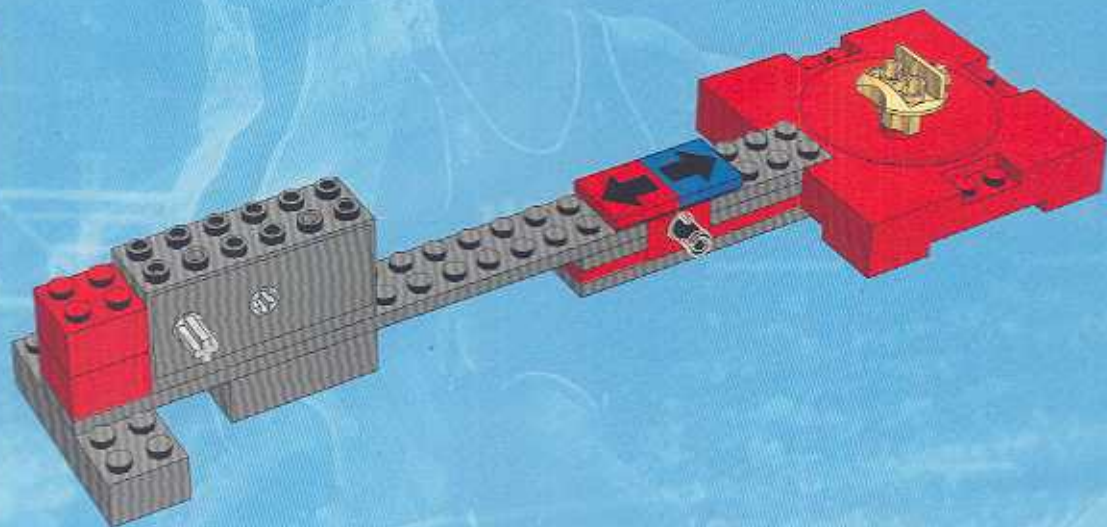

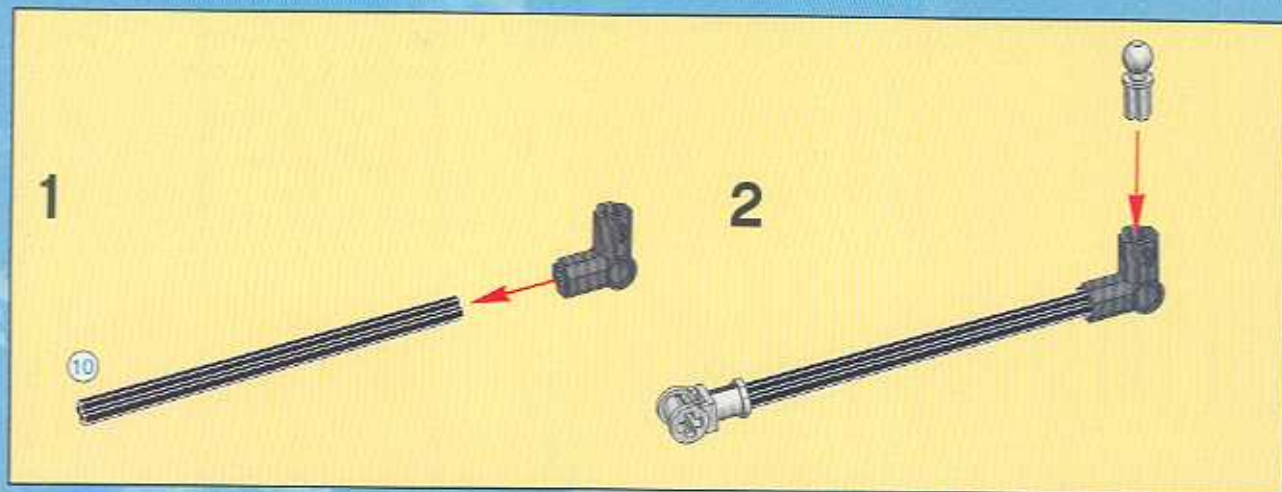

10

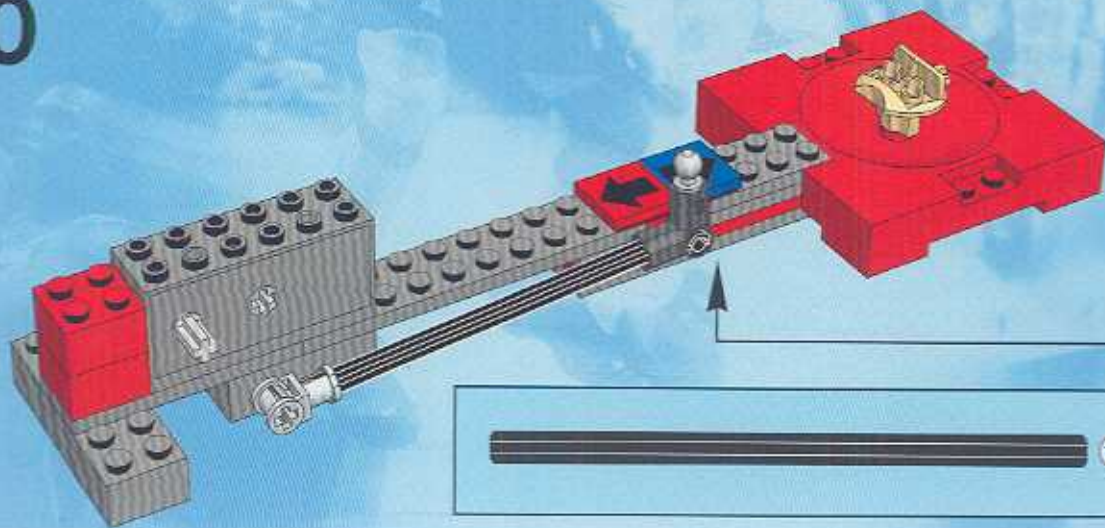



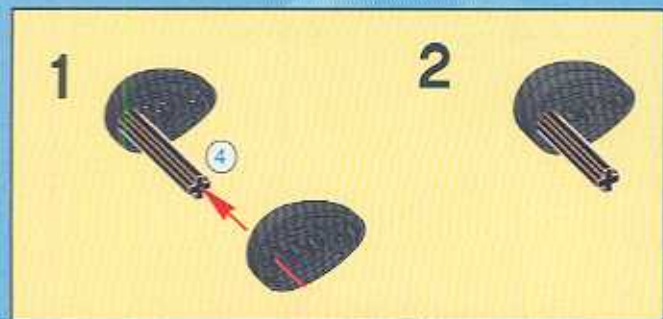

11

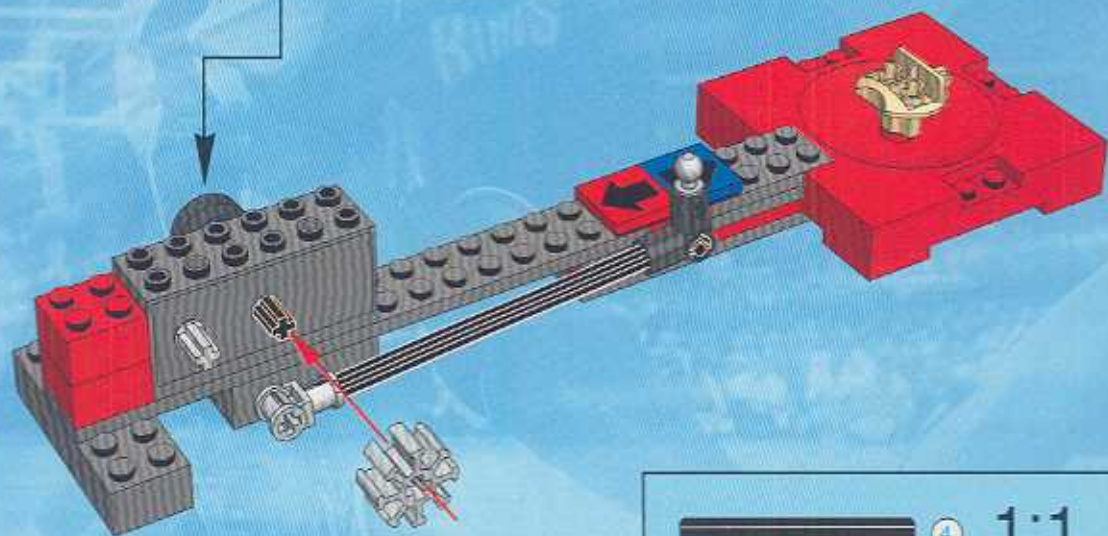

12

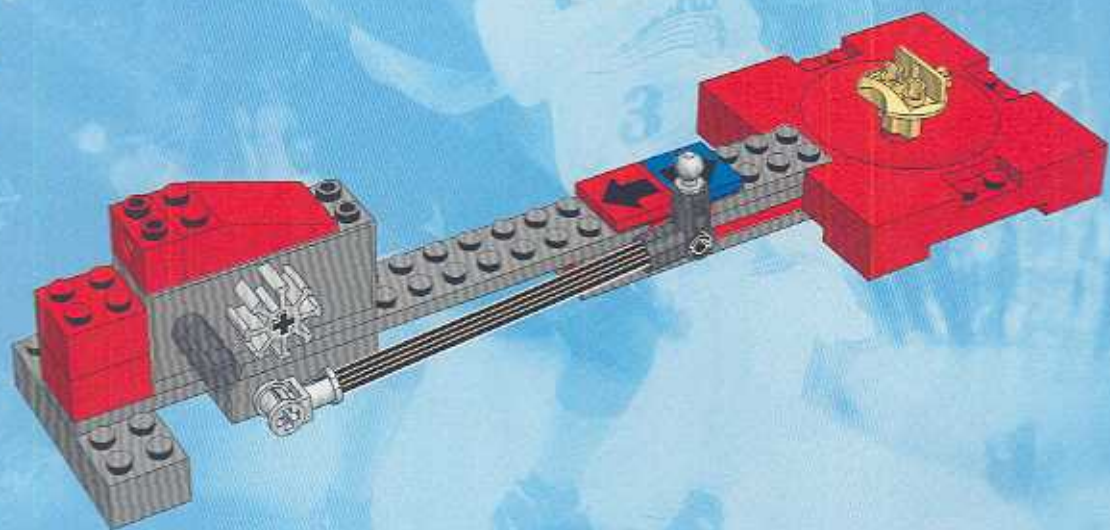



13

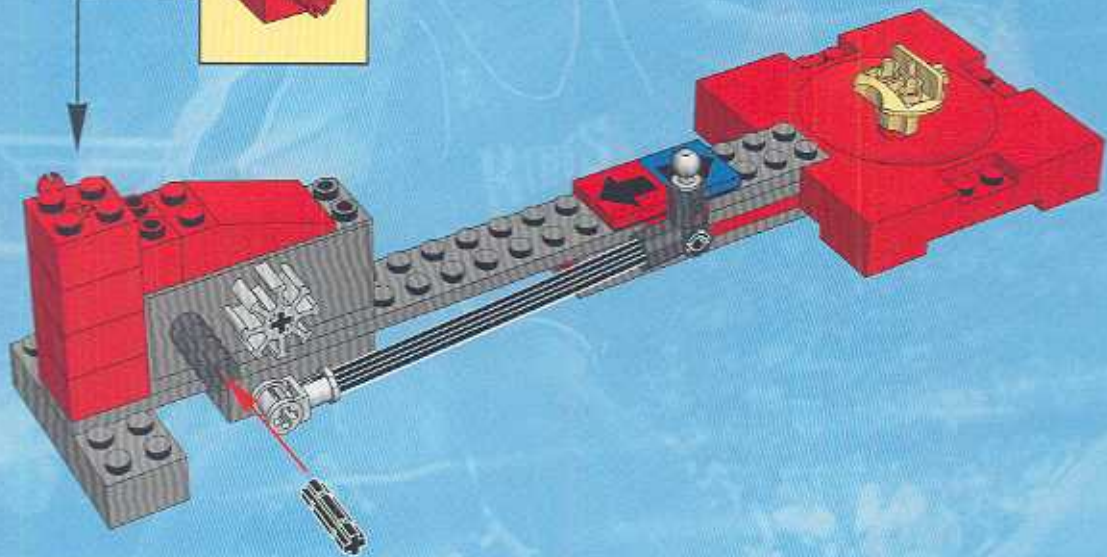

14

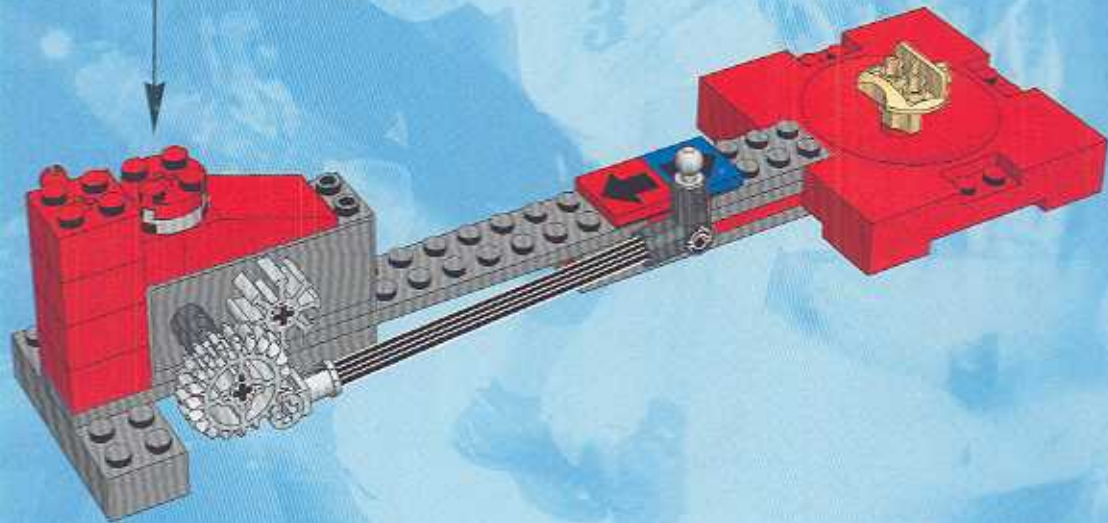



15

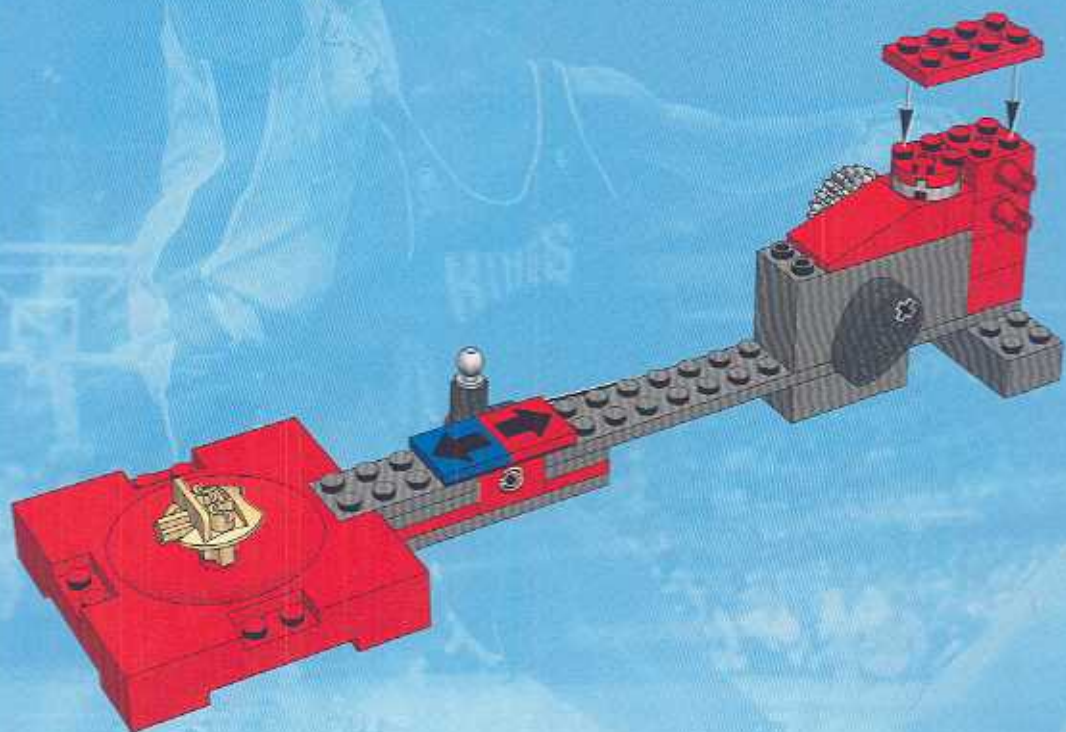

16

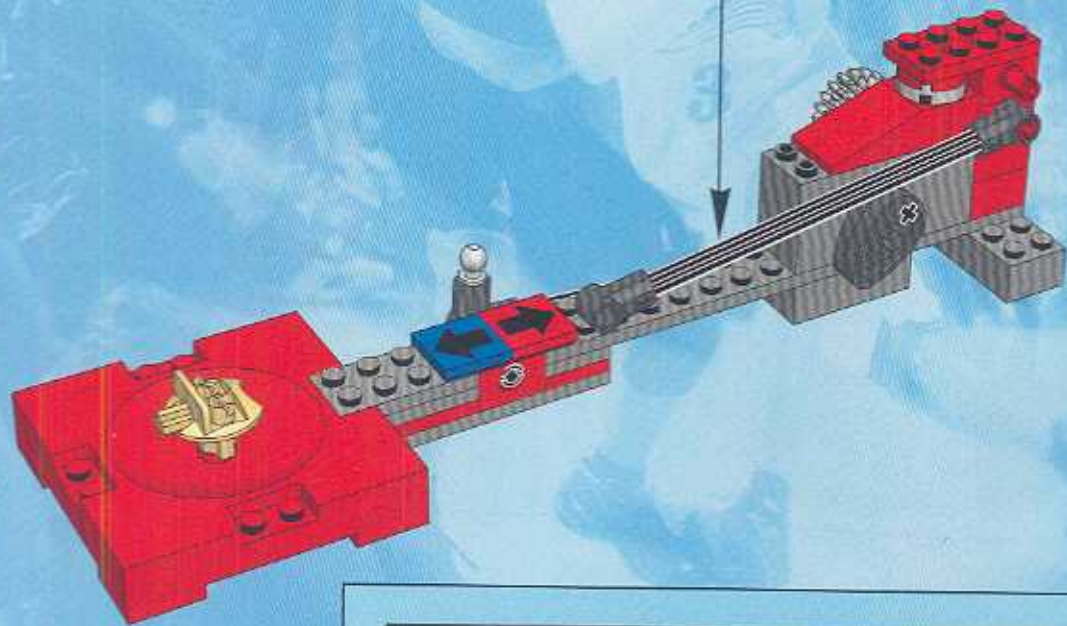
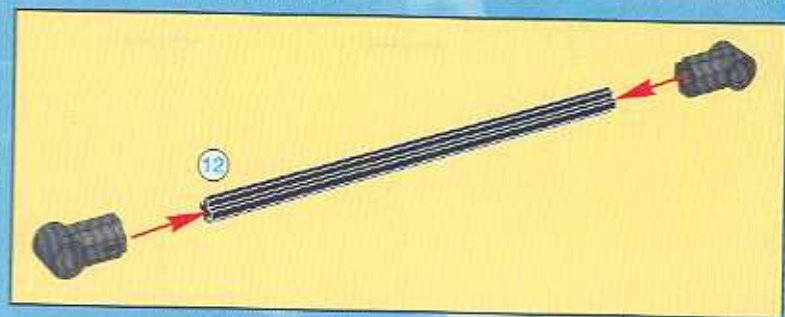



17

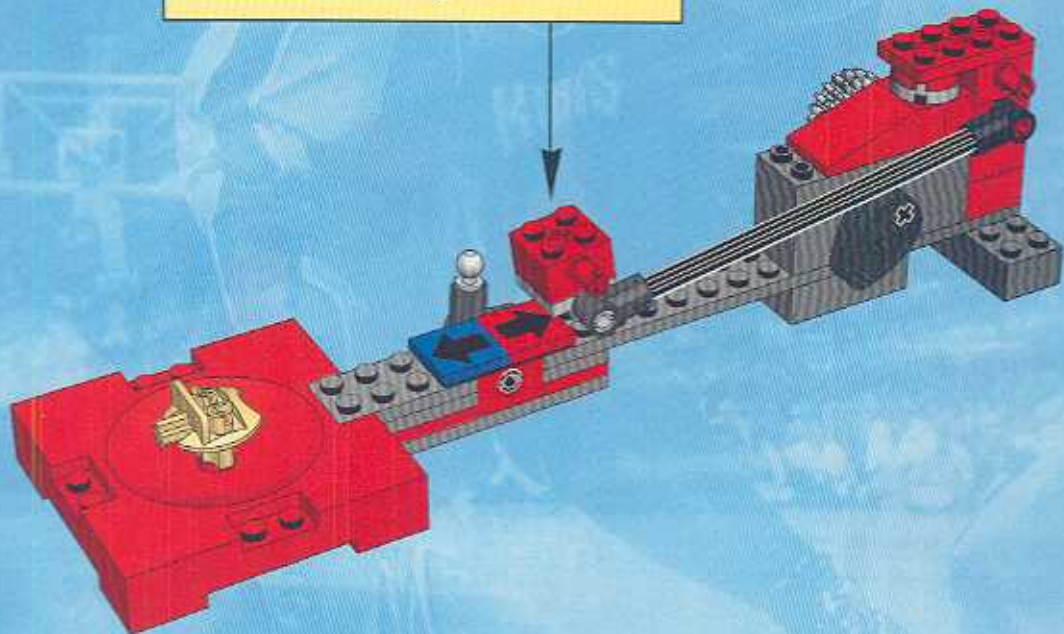
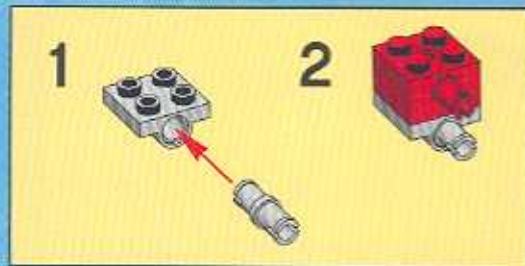

1

12

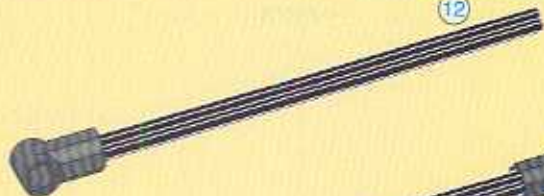

8



2



18

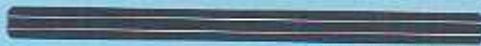
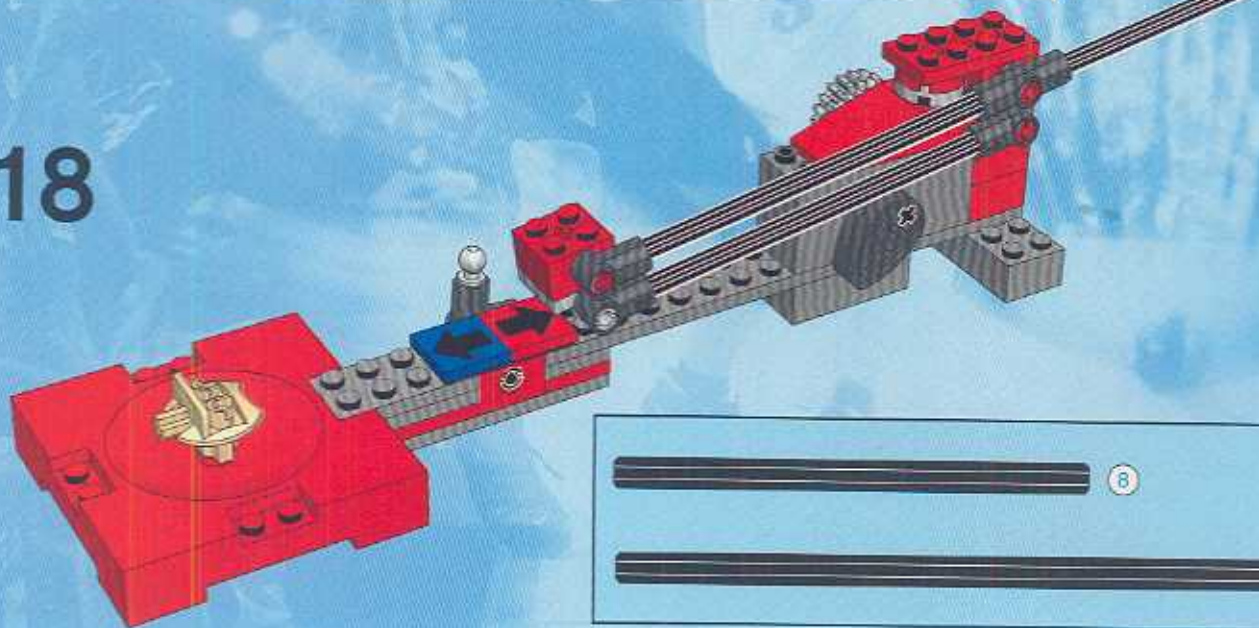

8

1:1



12



19

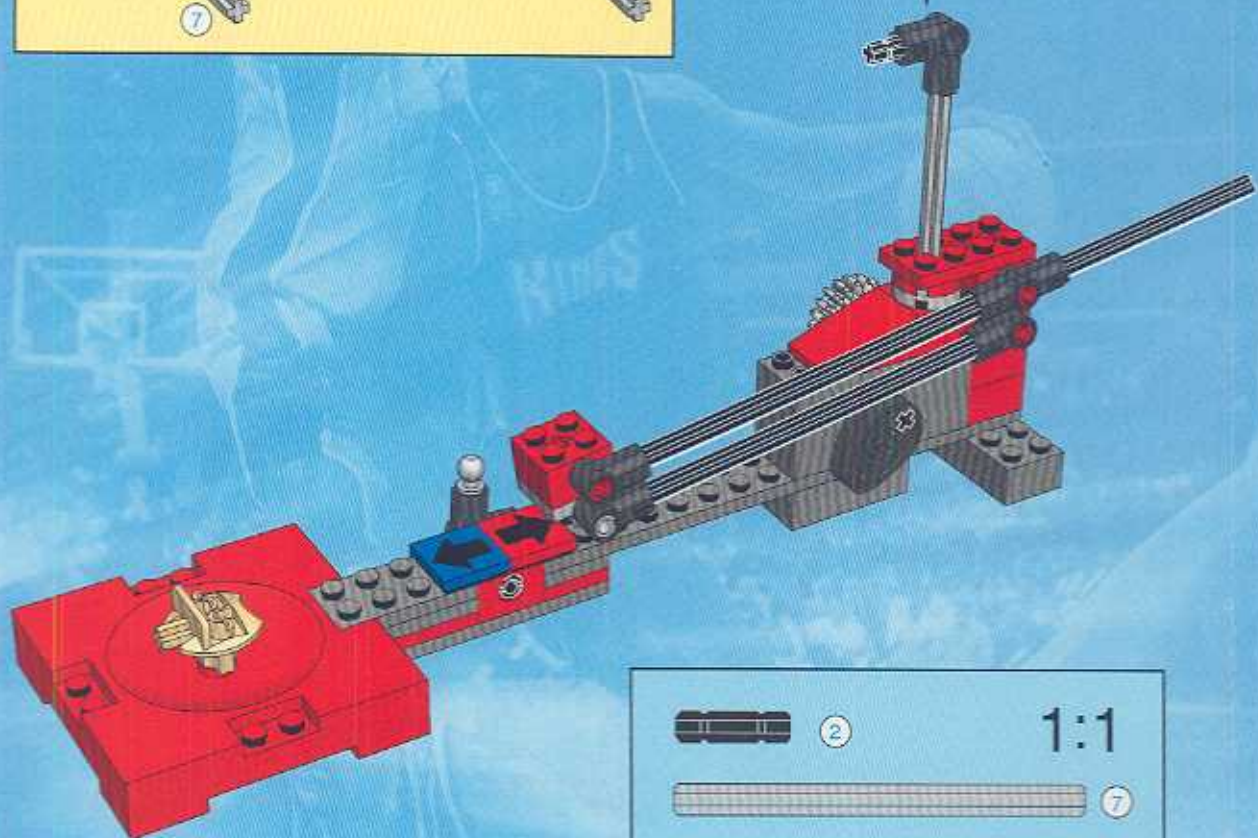
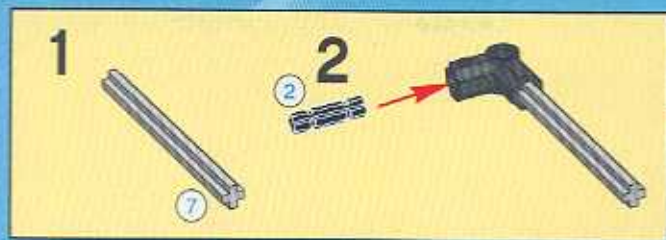

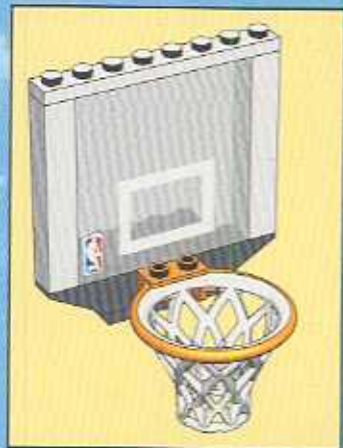

1



2



3



4



5



6





20

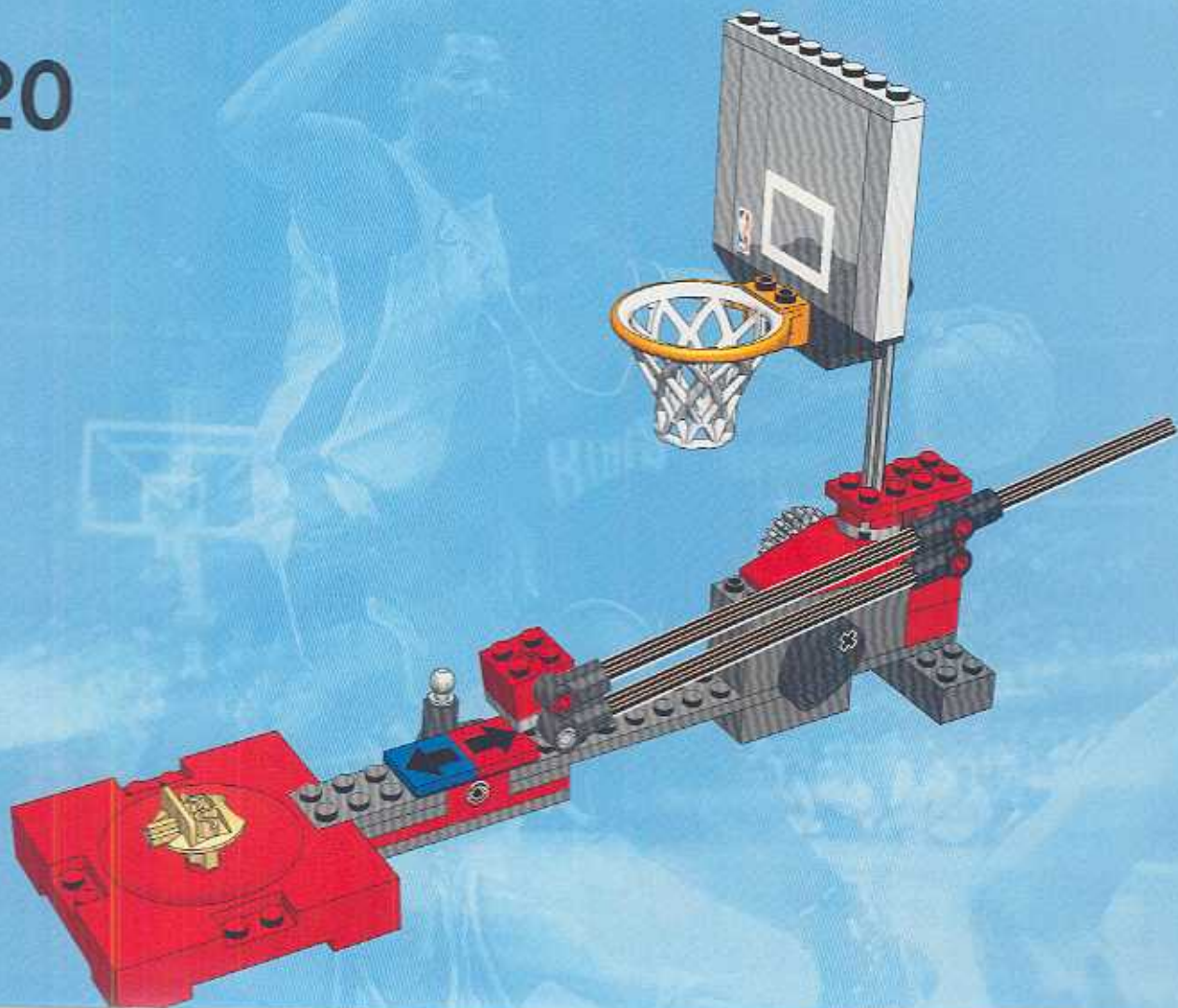

# 21

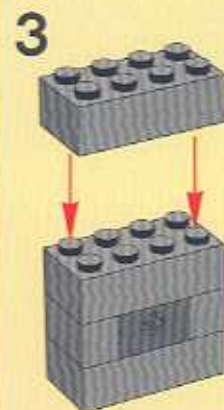
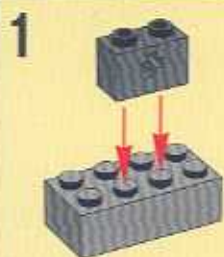
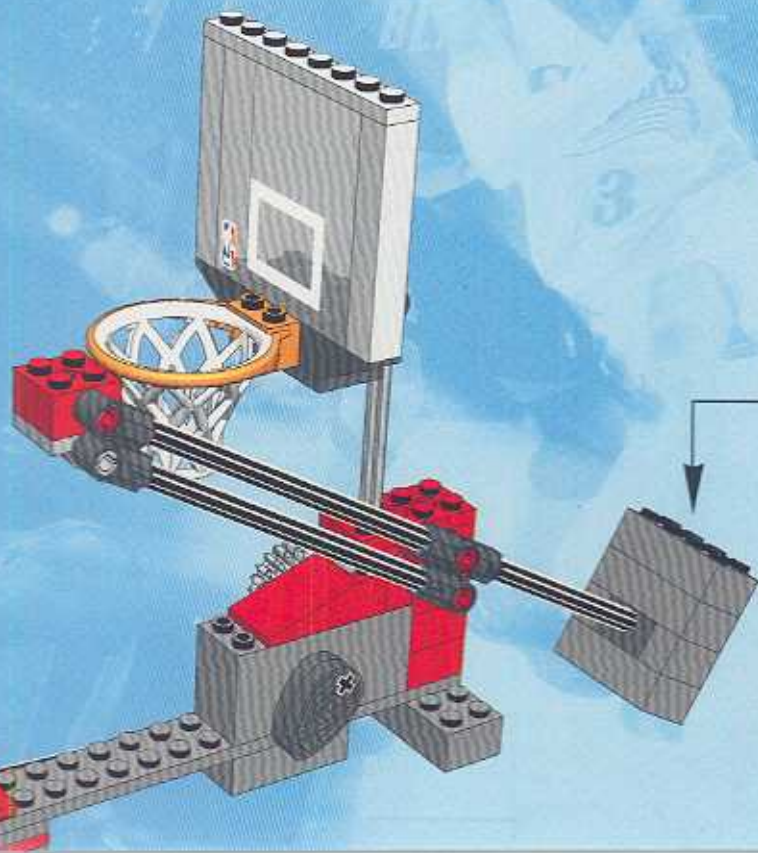



22







**LEGO**



[www.LEGO.com](http://www.LEGO.com)

**NBA**  **.COM**



**NBA**



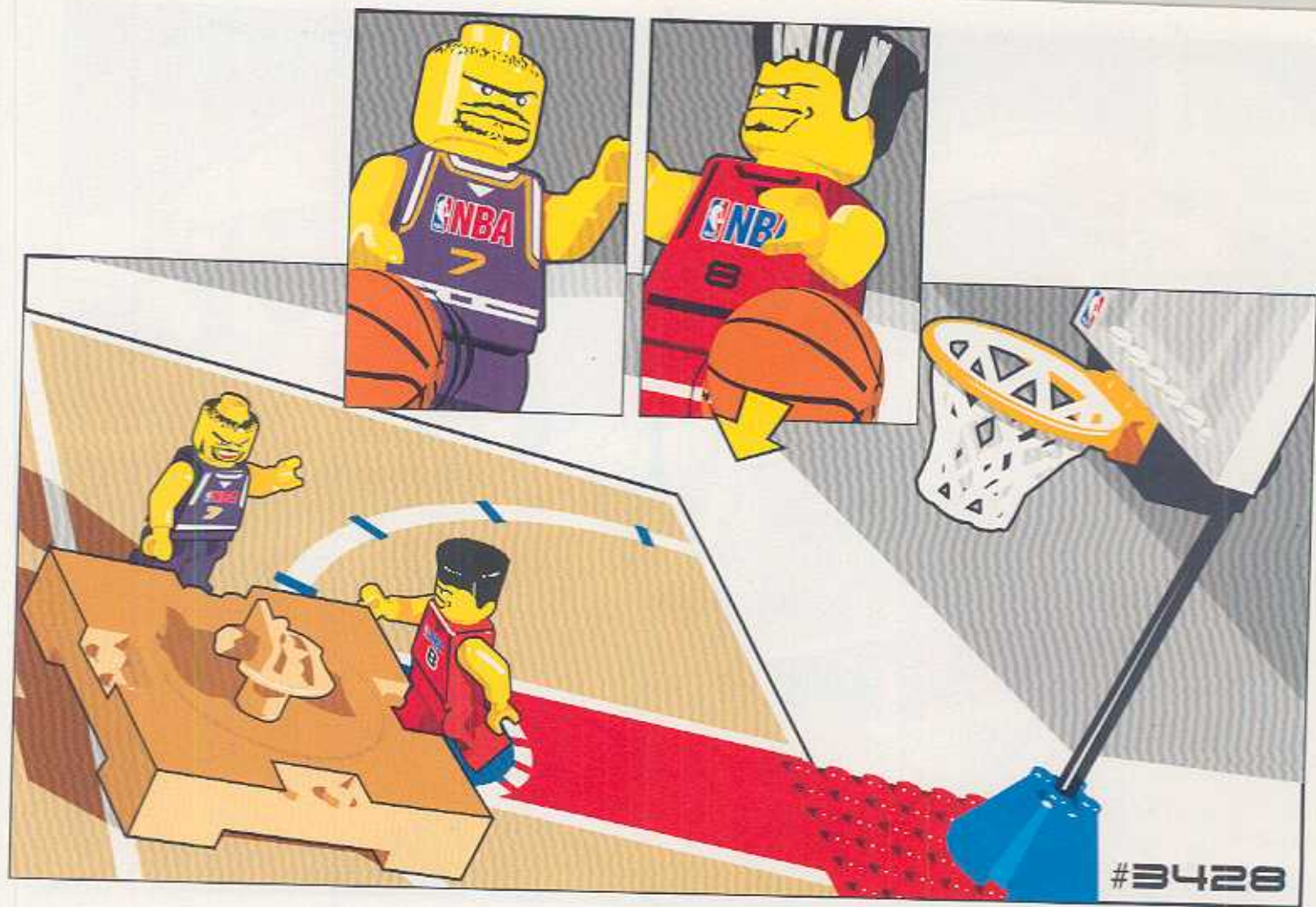

#3428

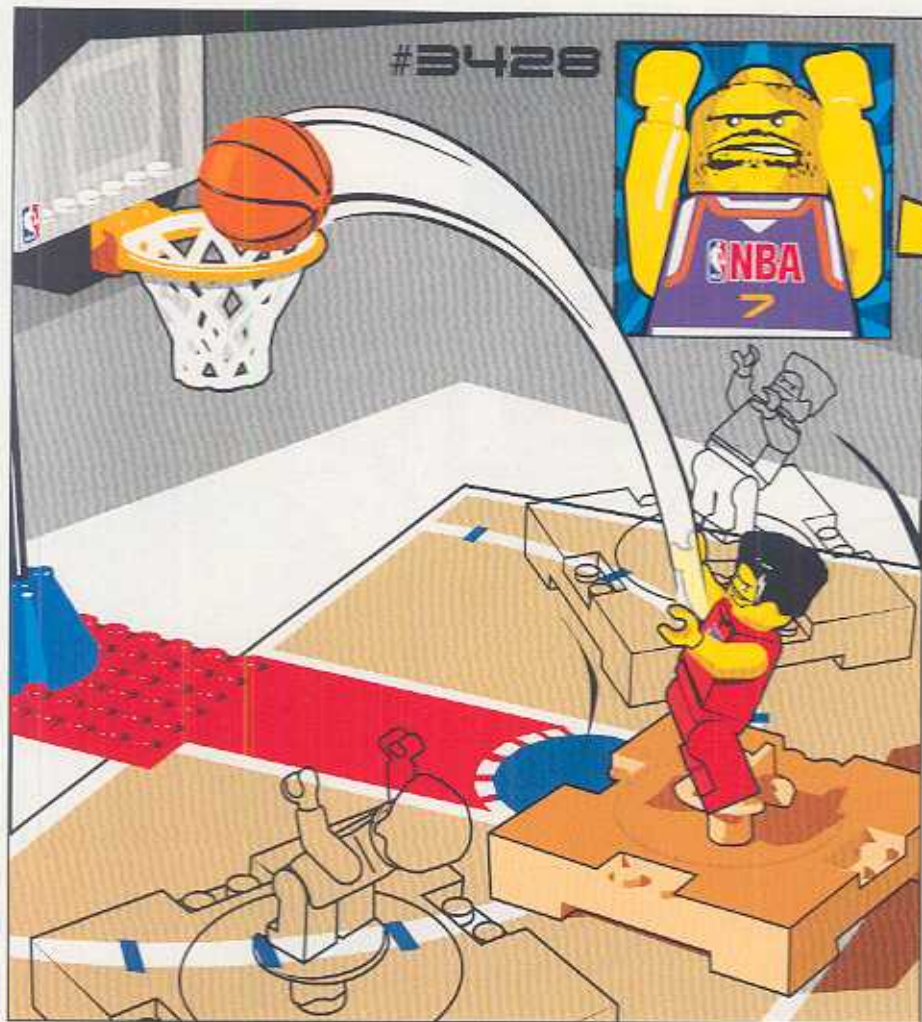



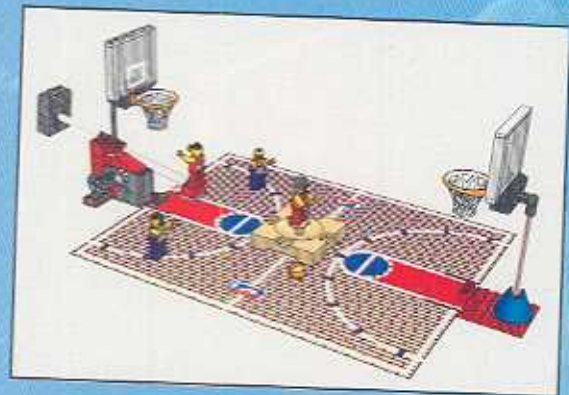

1

3428+3429

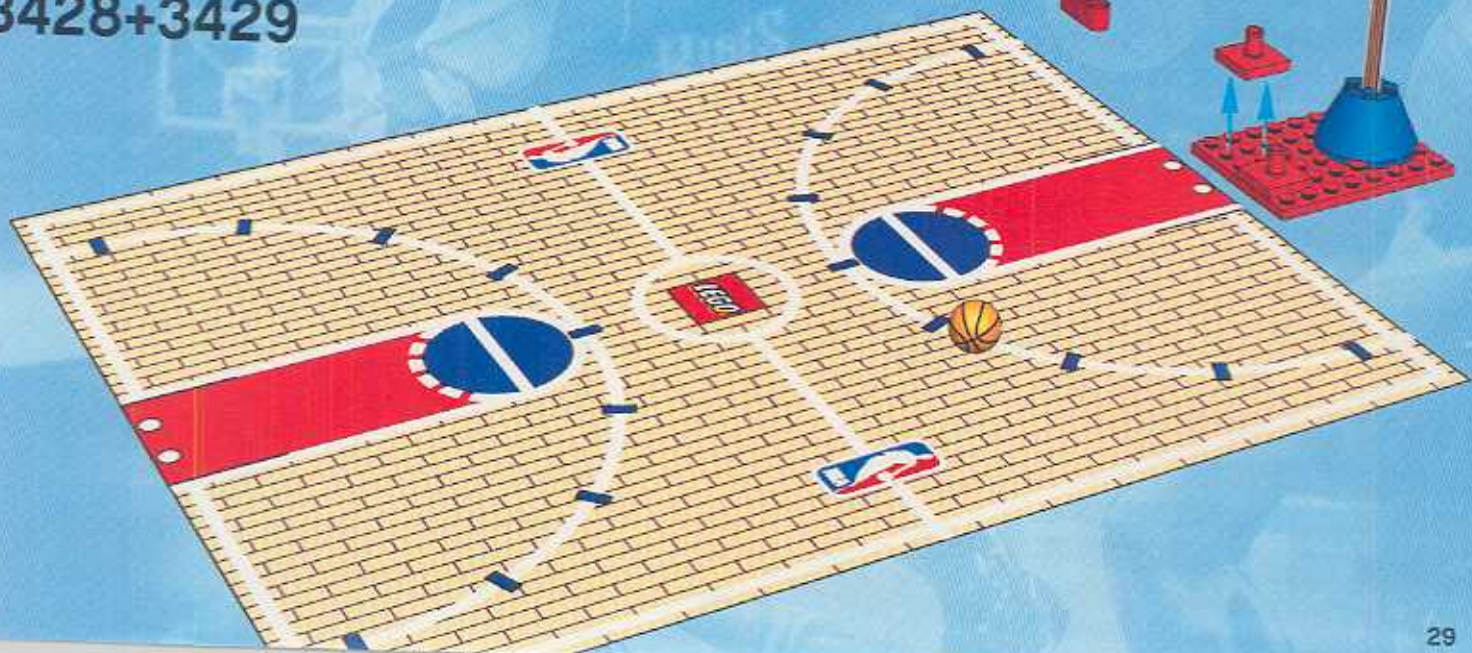



2

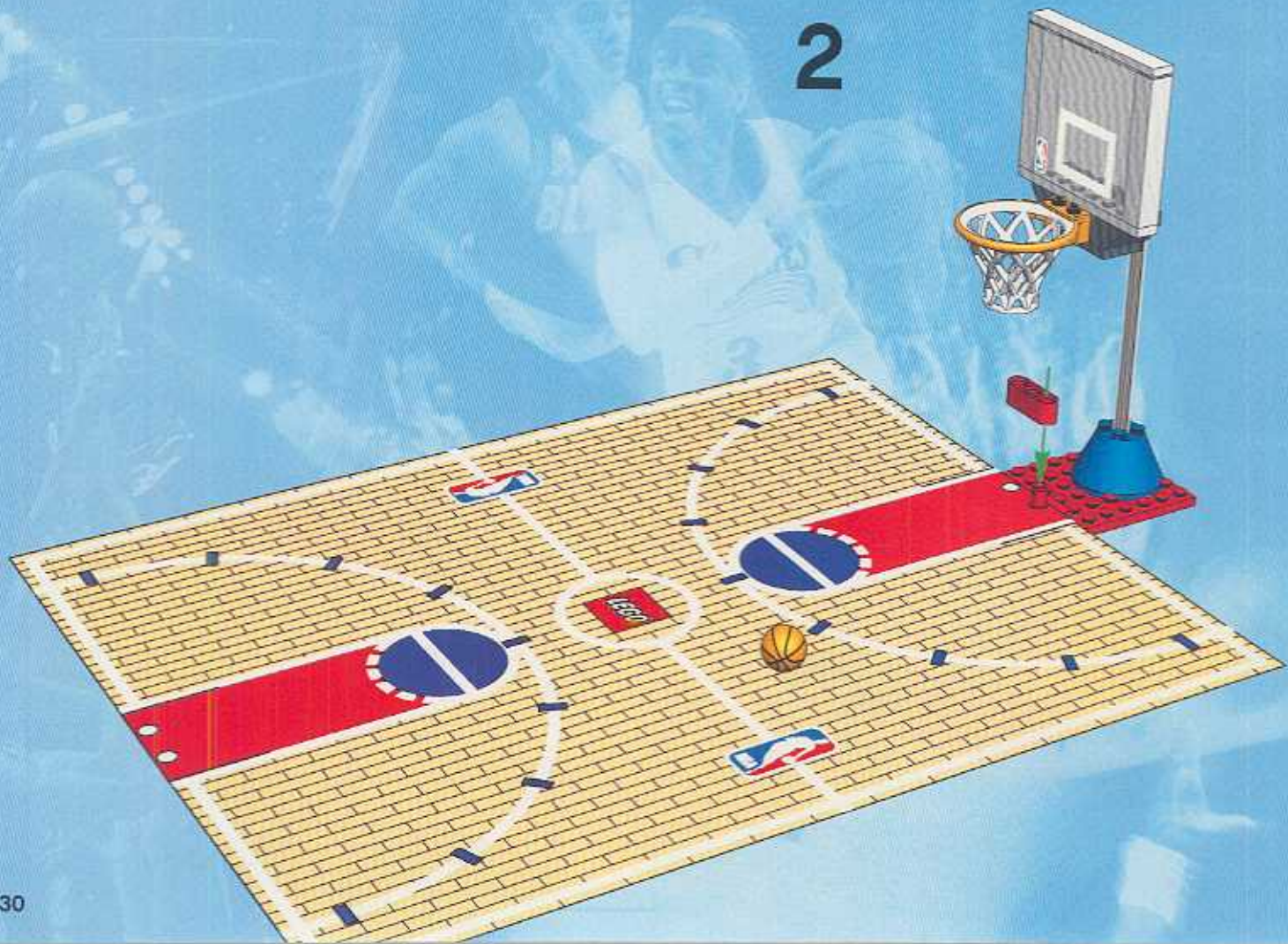



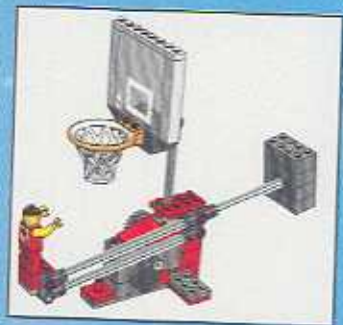

1



2

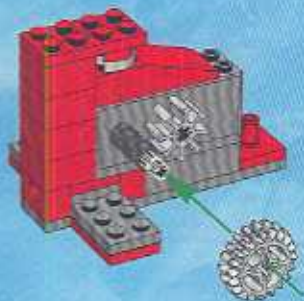

3

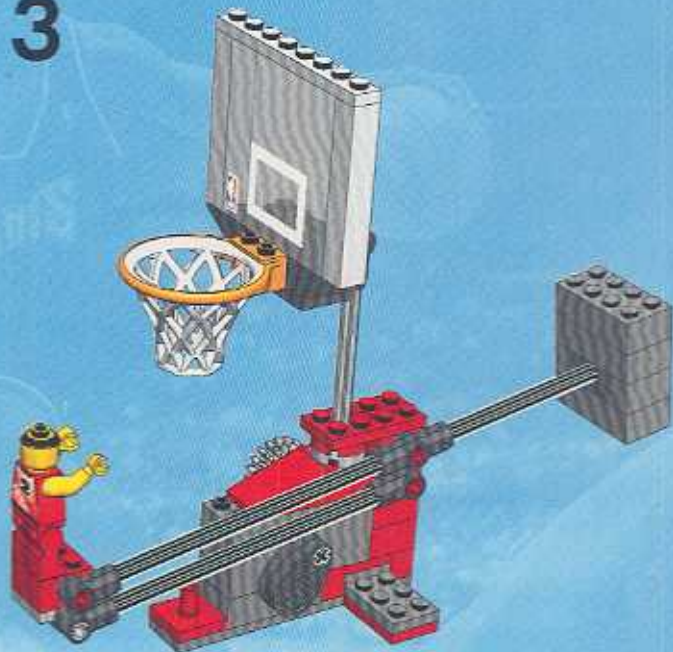

3





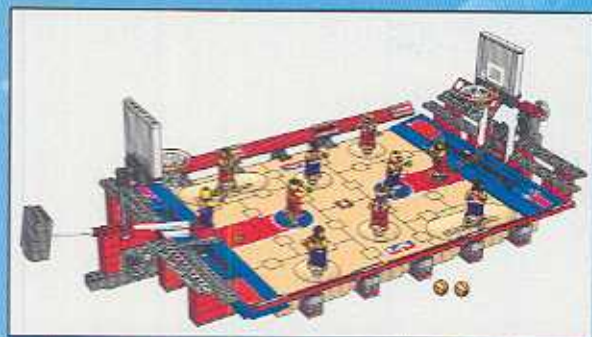

3429+3432

1



1



2

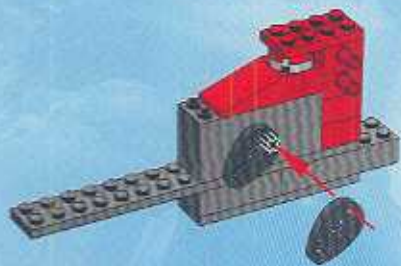

3

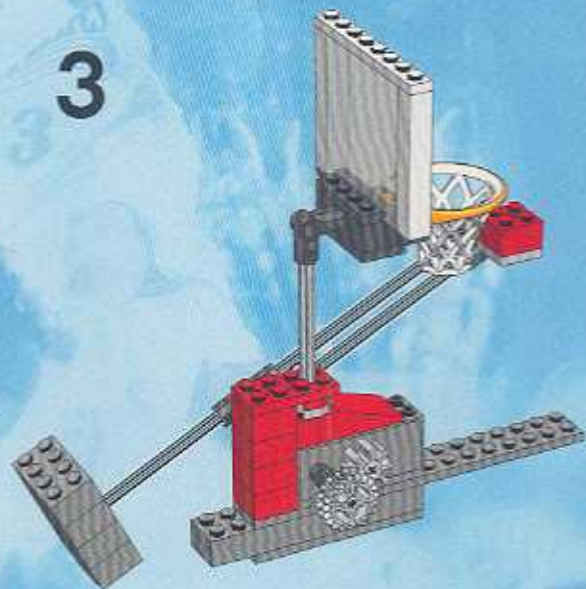



2



LEGO

SPORTS



adidas, the adidas logo and the three stripe trademark are registered trademarks of the adidas-Salomon group, used with permission. Fovernova and the Trigon logo are trademarks of the adidas-Salomon group, used with permission.



SERVICE  
www.lego.com



www.LEGO.com

SPALDING is a trademark of Spalding Sports Worldwide, Inc. of Liaco Sports, Inc., a Spalding affiliate.  
© Spalding Sports Worldwide, Inc. 2002.

NBA identifications depicted are the exclusive property of NBA Properties, Inc. and/or the NBA Member Teams, and are used with permission.

LEGO and the LEGO logo are trademarks of the LEGO Group.  
©2002 The LEGO Group.