

LEGO

SPORTS

3431



 **WARNING: CHOKING HAZARD.**
Toy contains small parts and a small ball.
Not for children under 3 years.







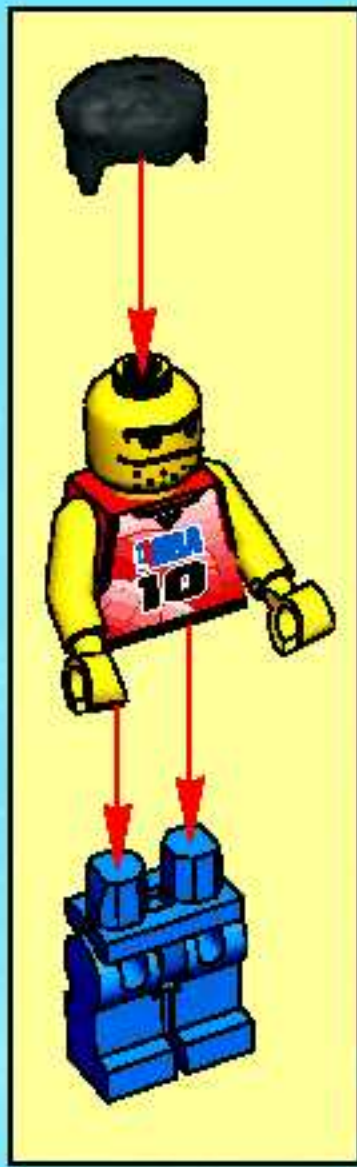

⚠ AVERTISSEMENT : RISQUE D'ÉTOUFFEMENT.

Le jouet contient des petites pièces ainsi qu'une petite boule.
Il ne convient pas aux enfants de moins de 3 ans.

⚠ ADVERTENCIA: PELIGRO DE ASFIXIA.

Juguete que contiene partes pequeñas y una pelota pequeña.
No recomendado para niños menores de 3 años.



1

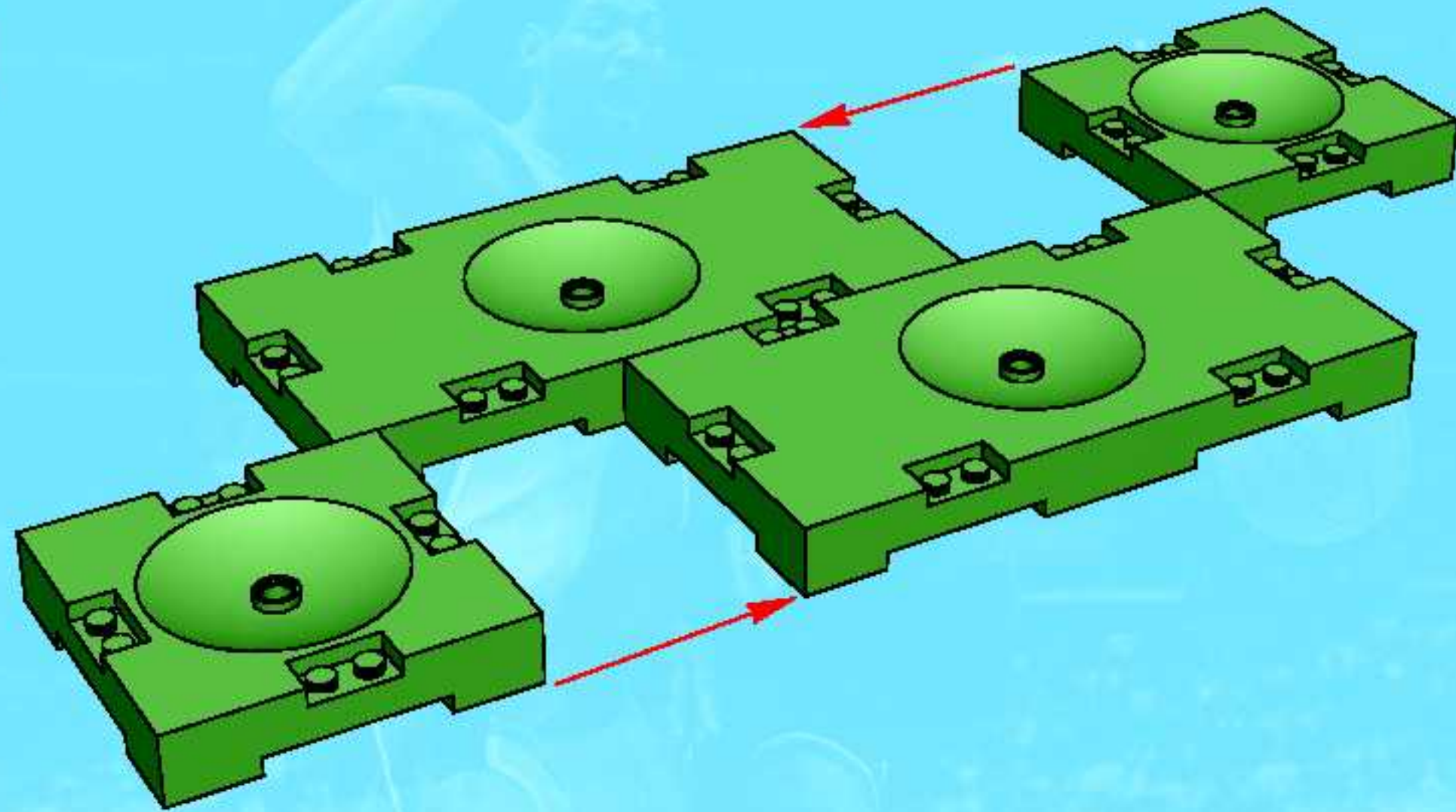

2

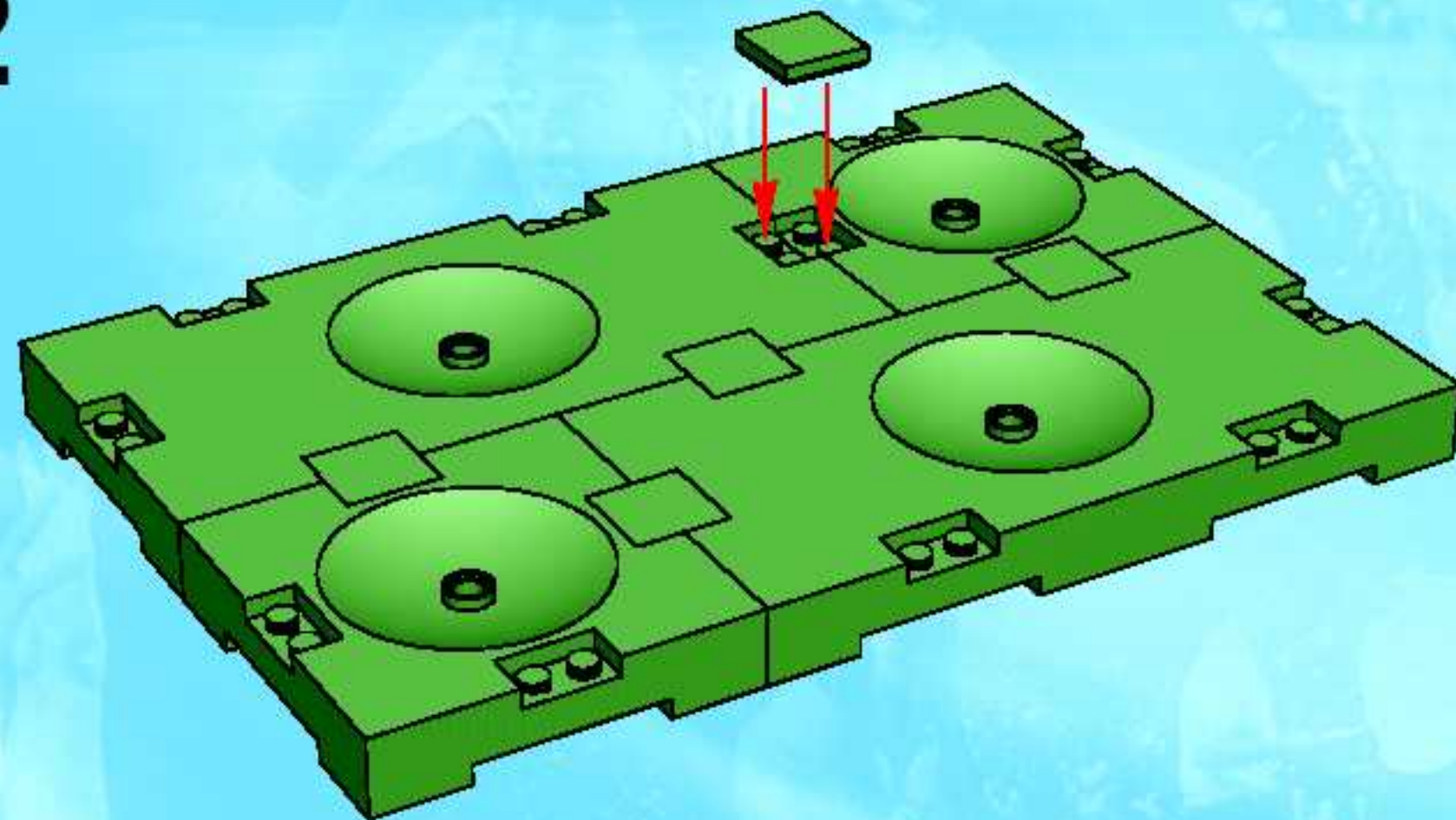

3

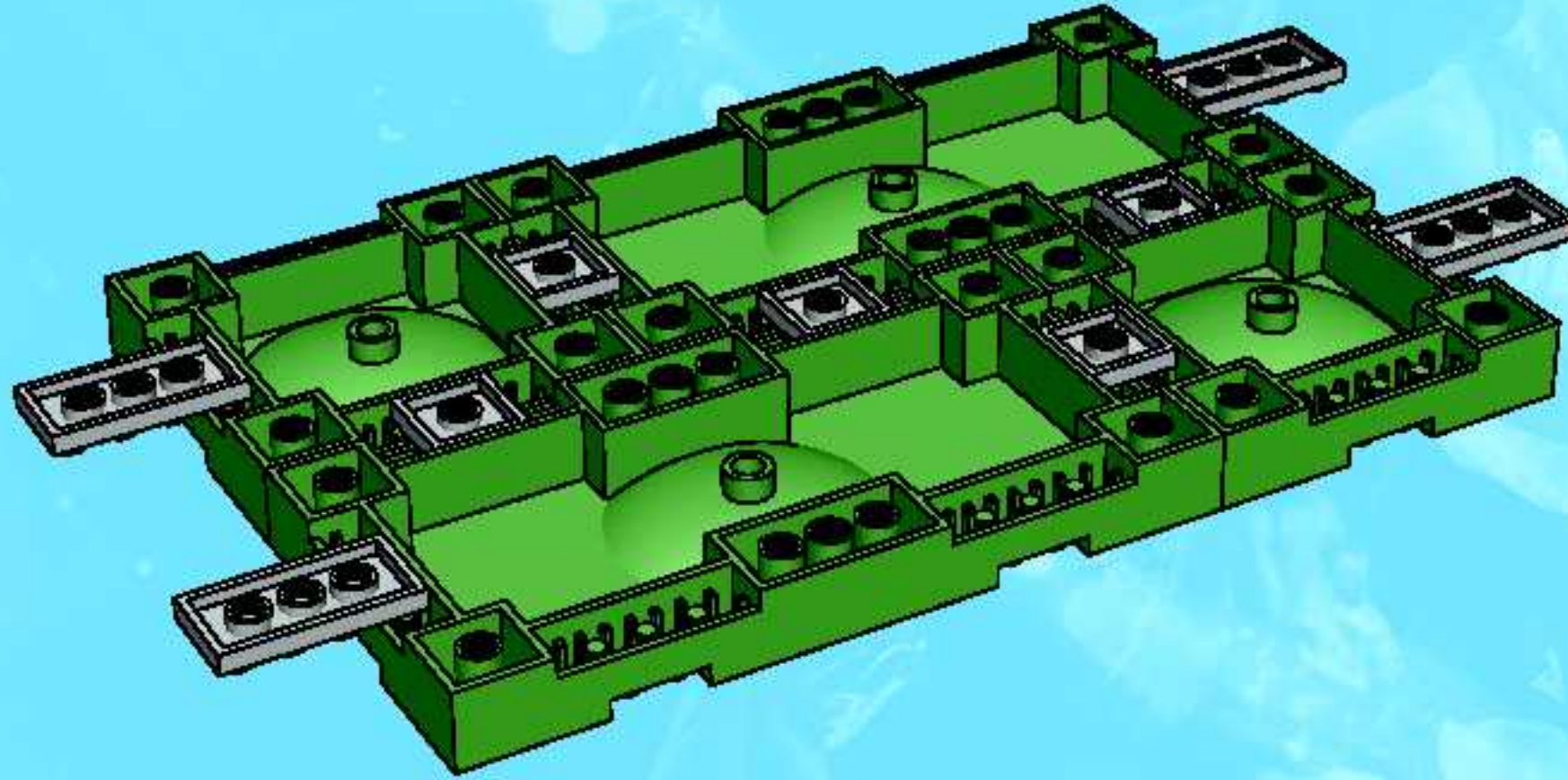

4

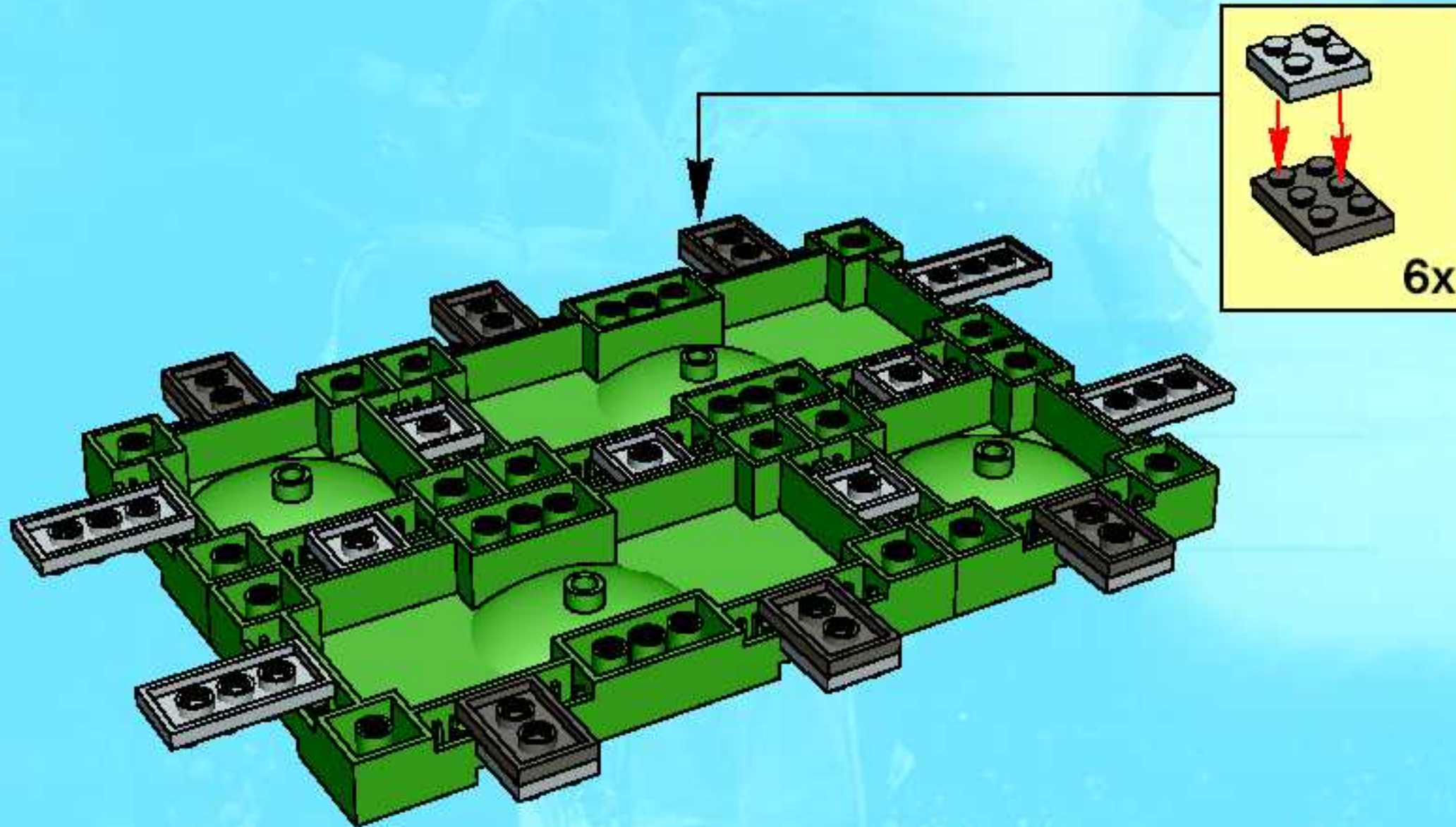

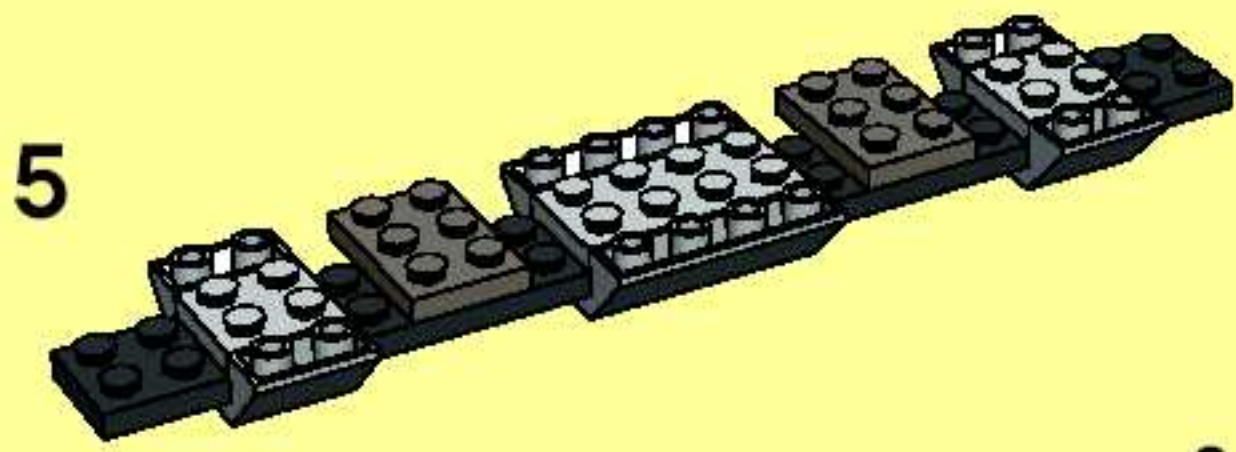
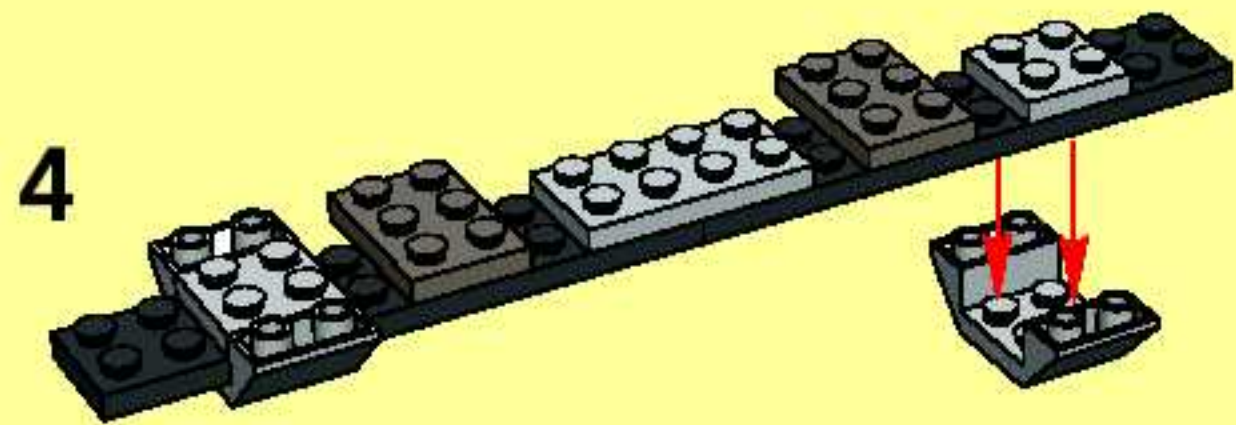
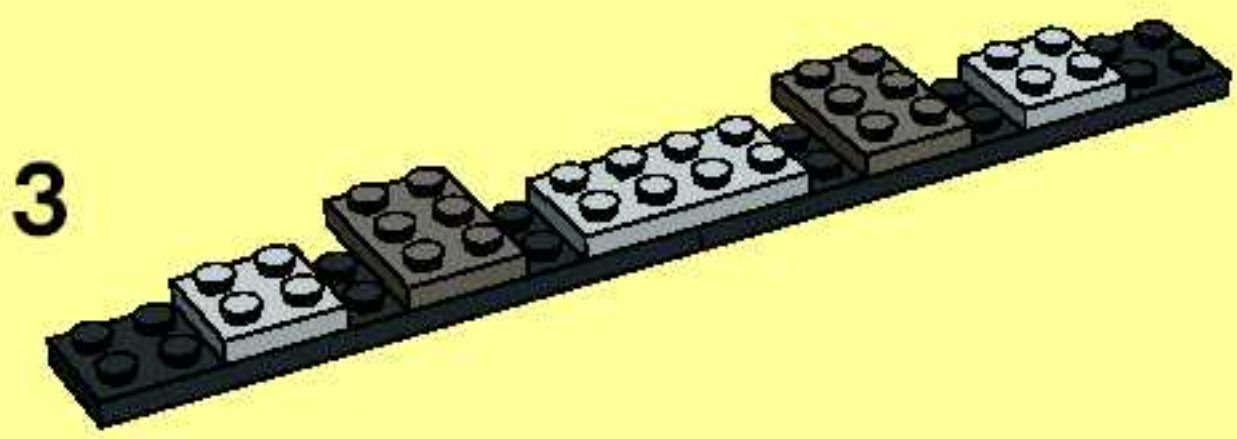
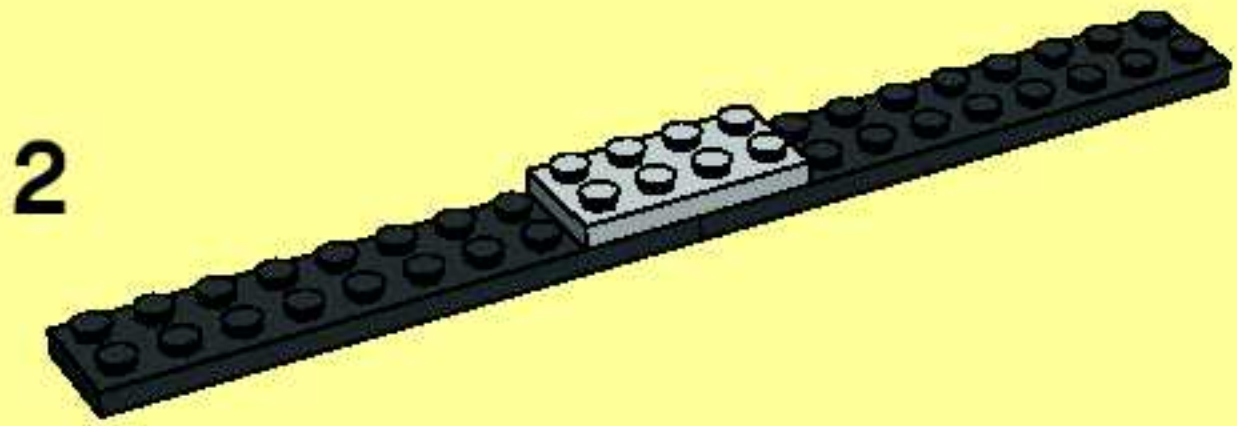
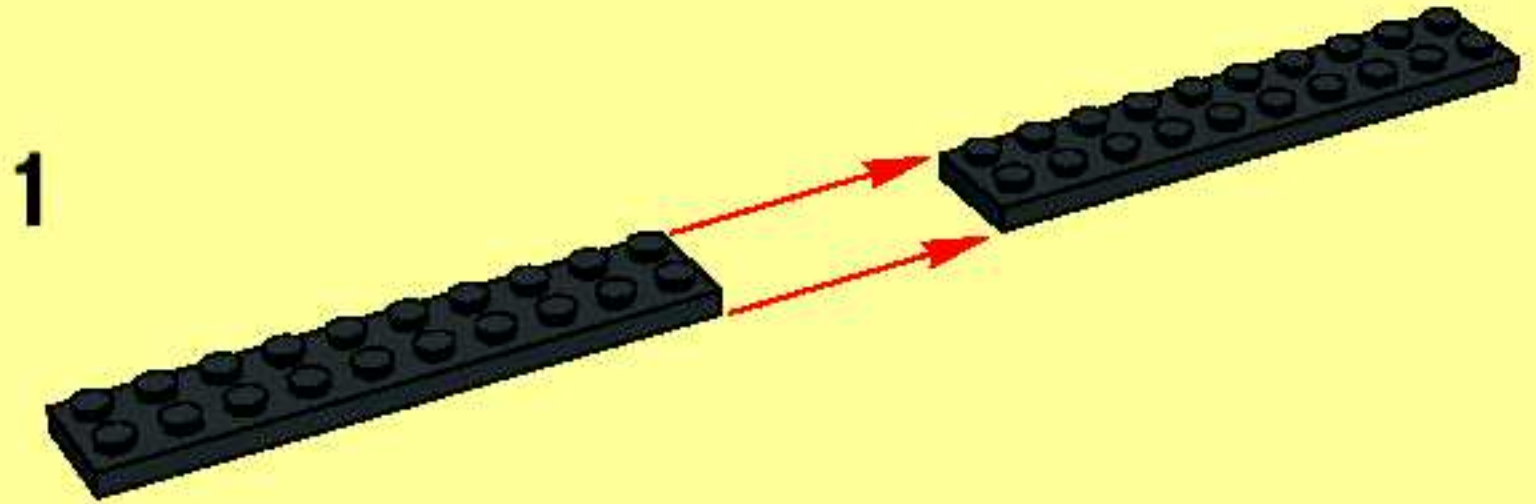

2x

5

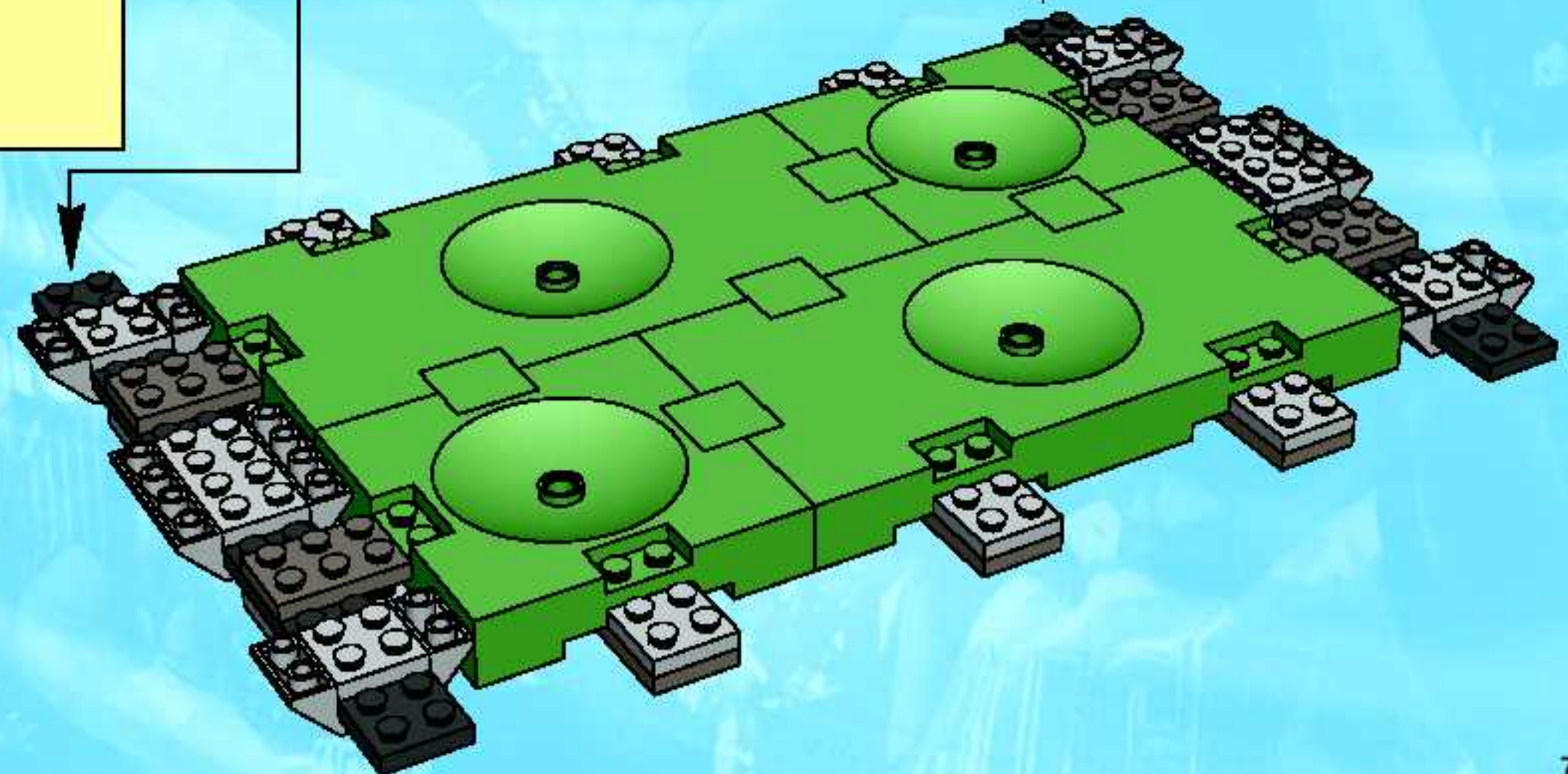

6

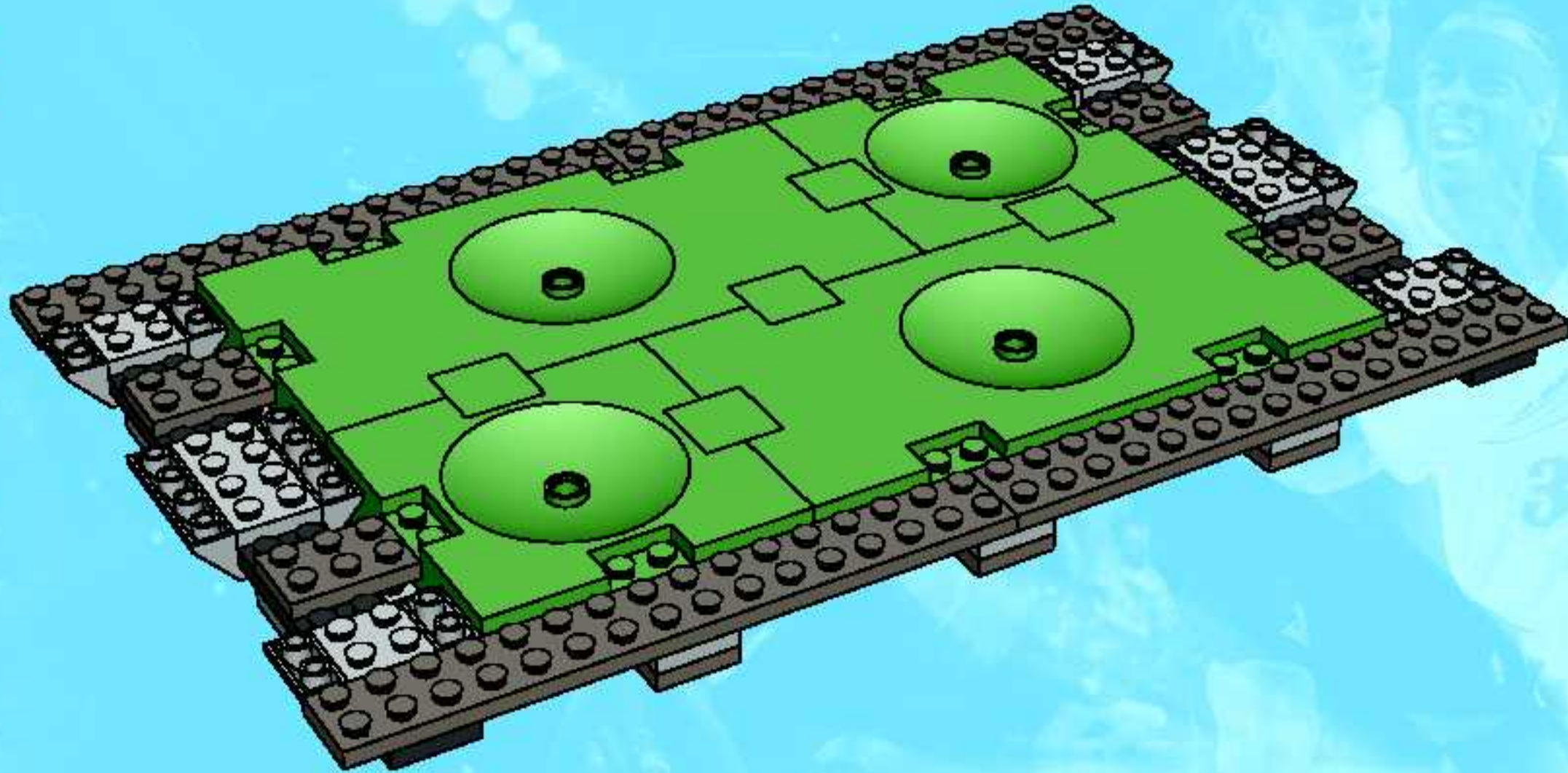

7

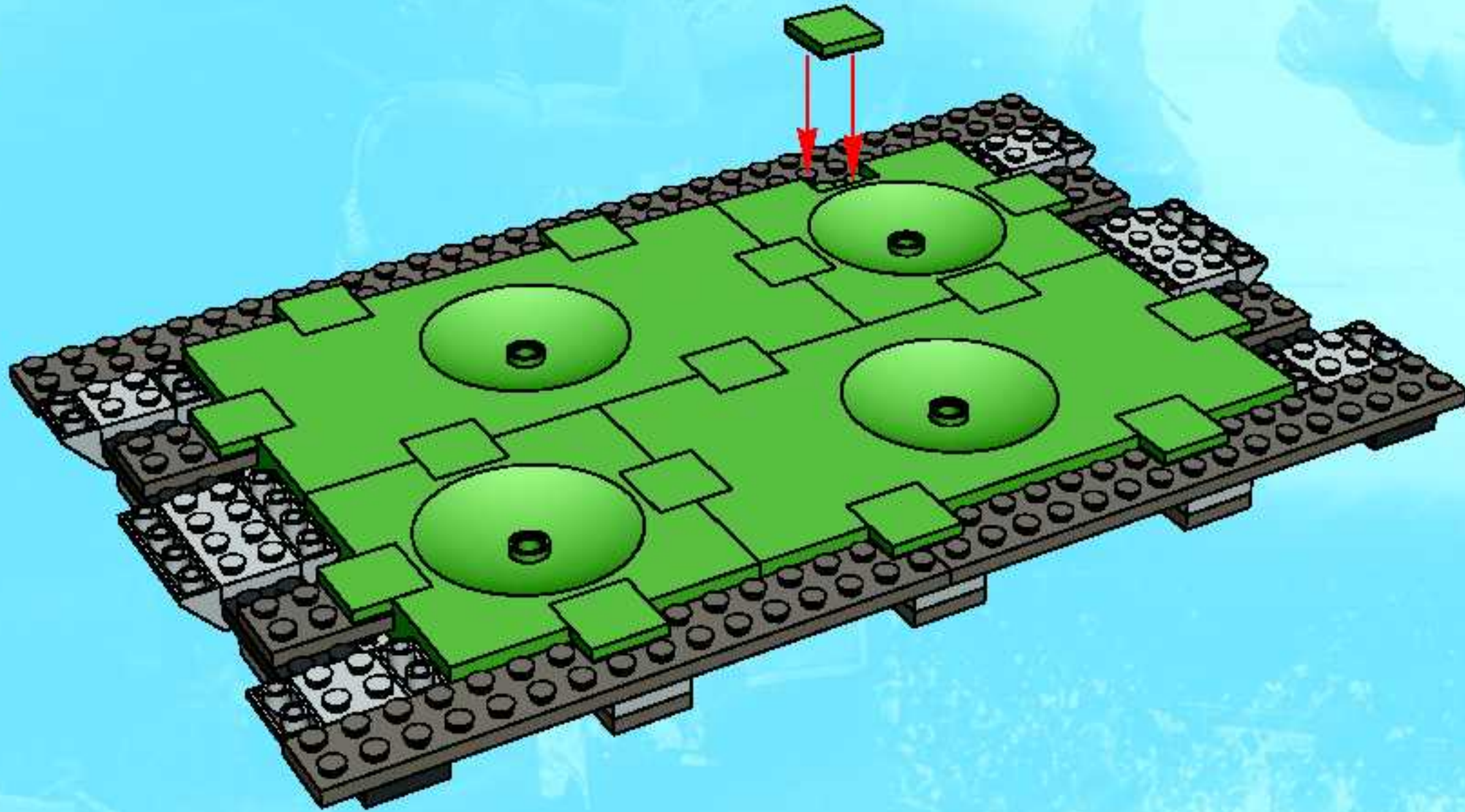

8

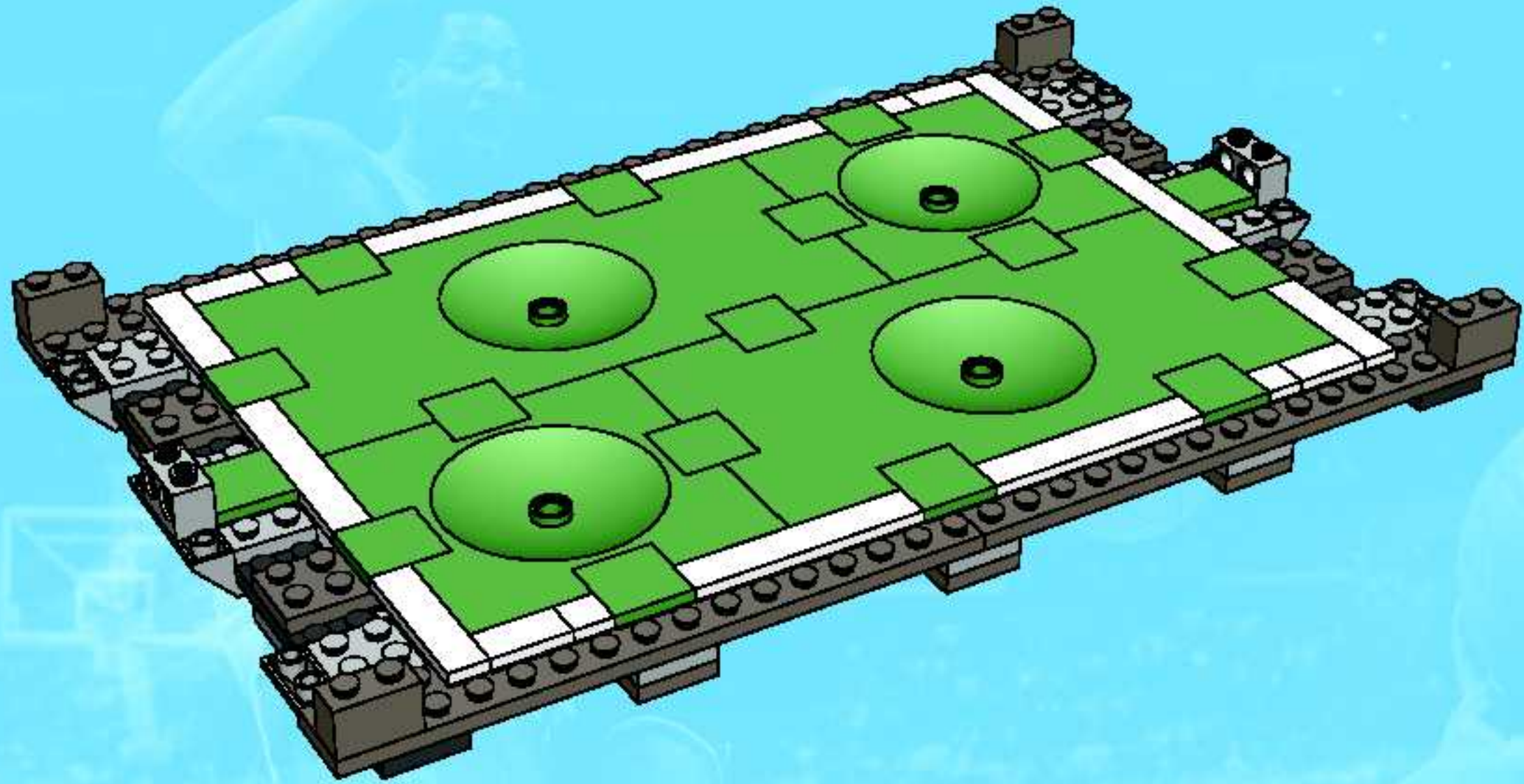

9

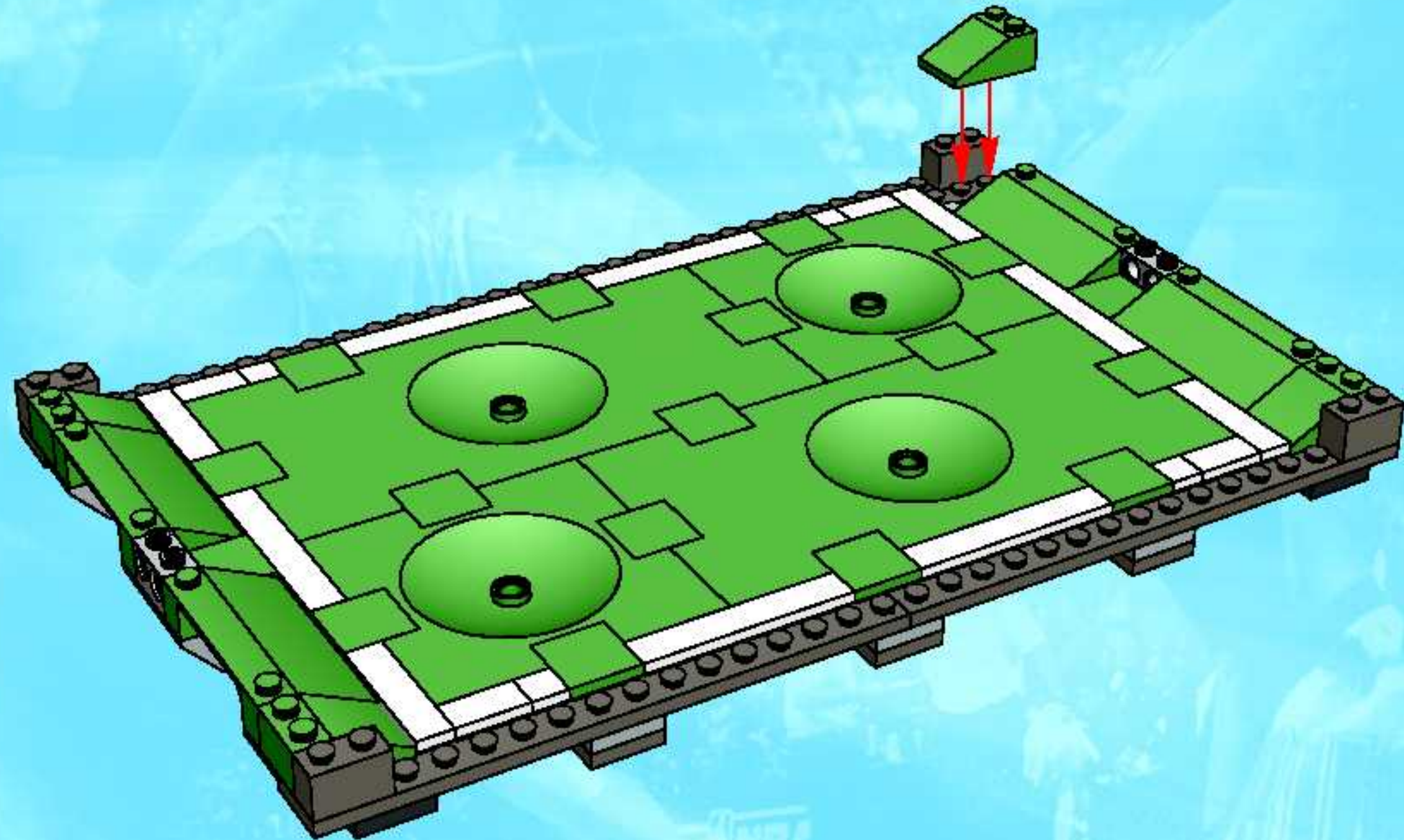

10

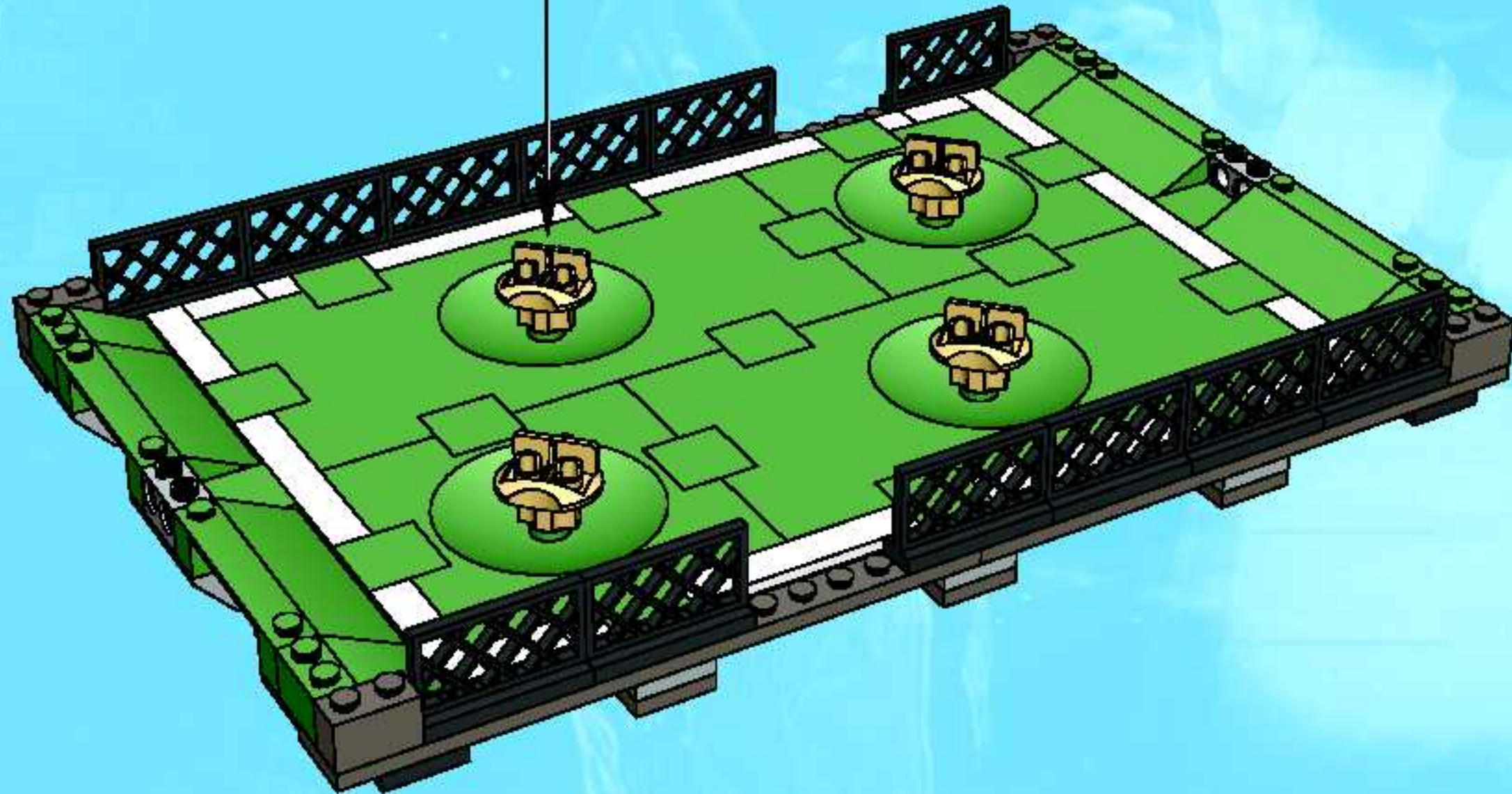
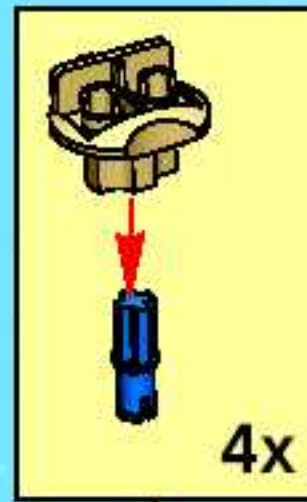

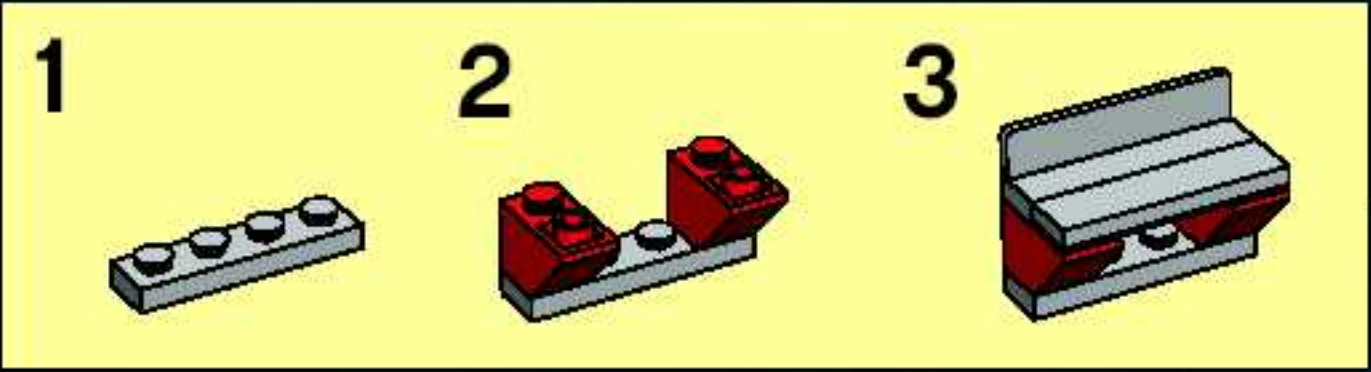

11

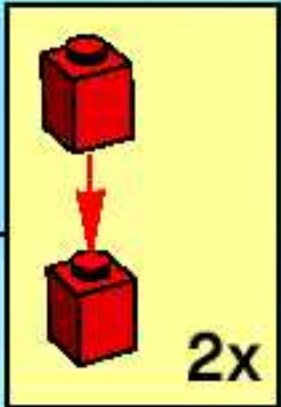
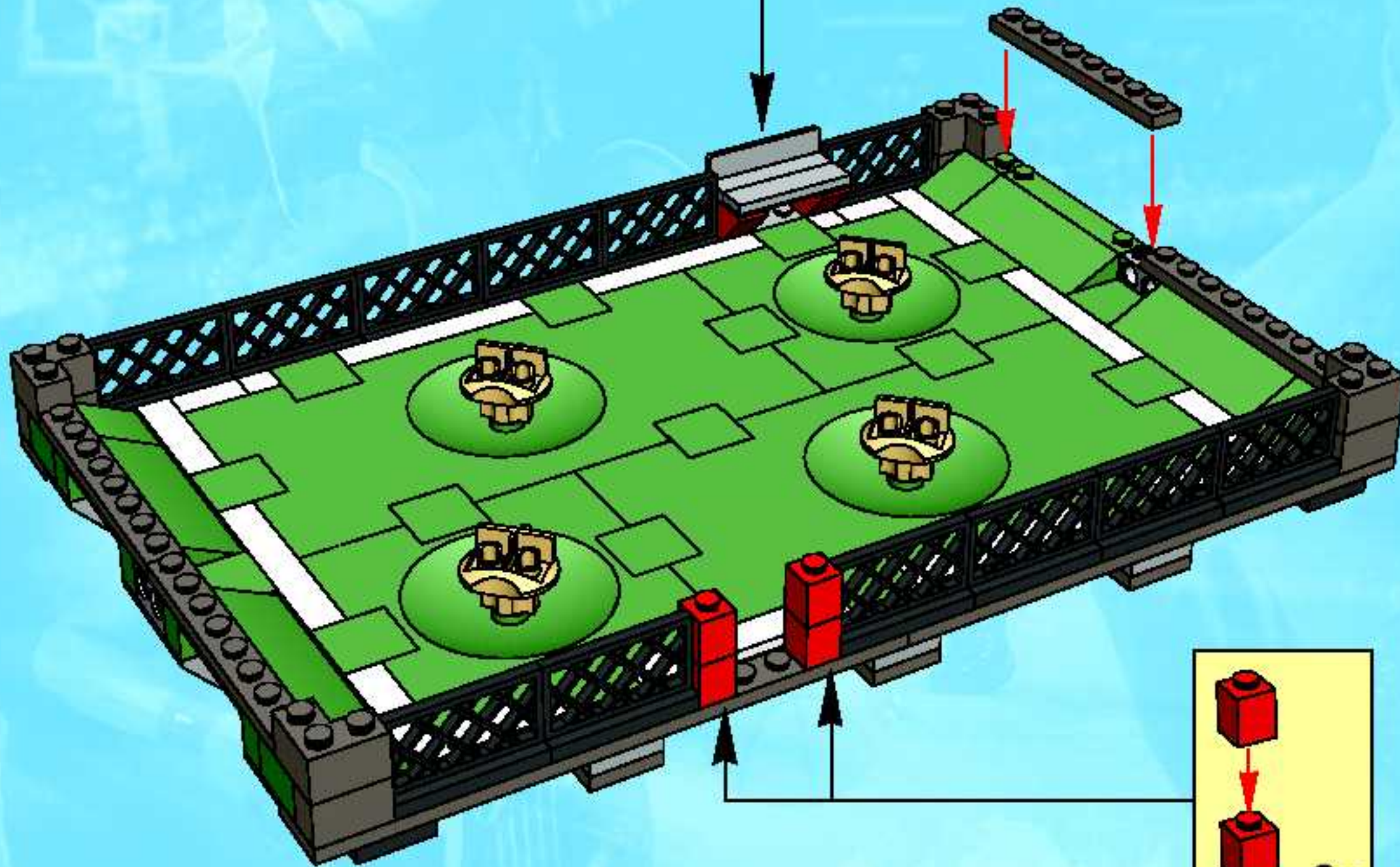

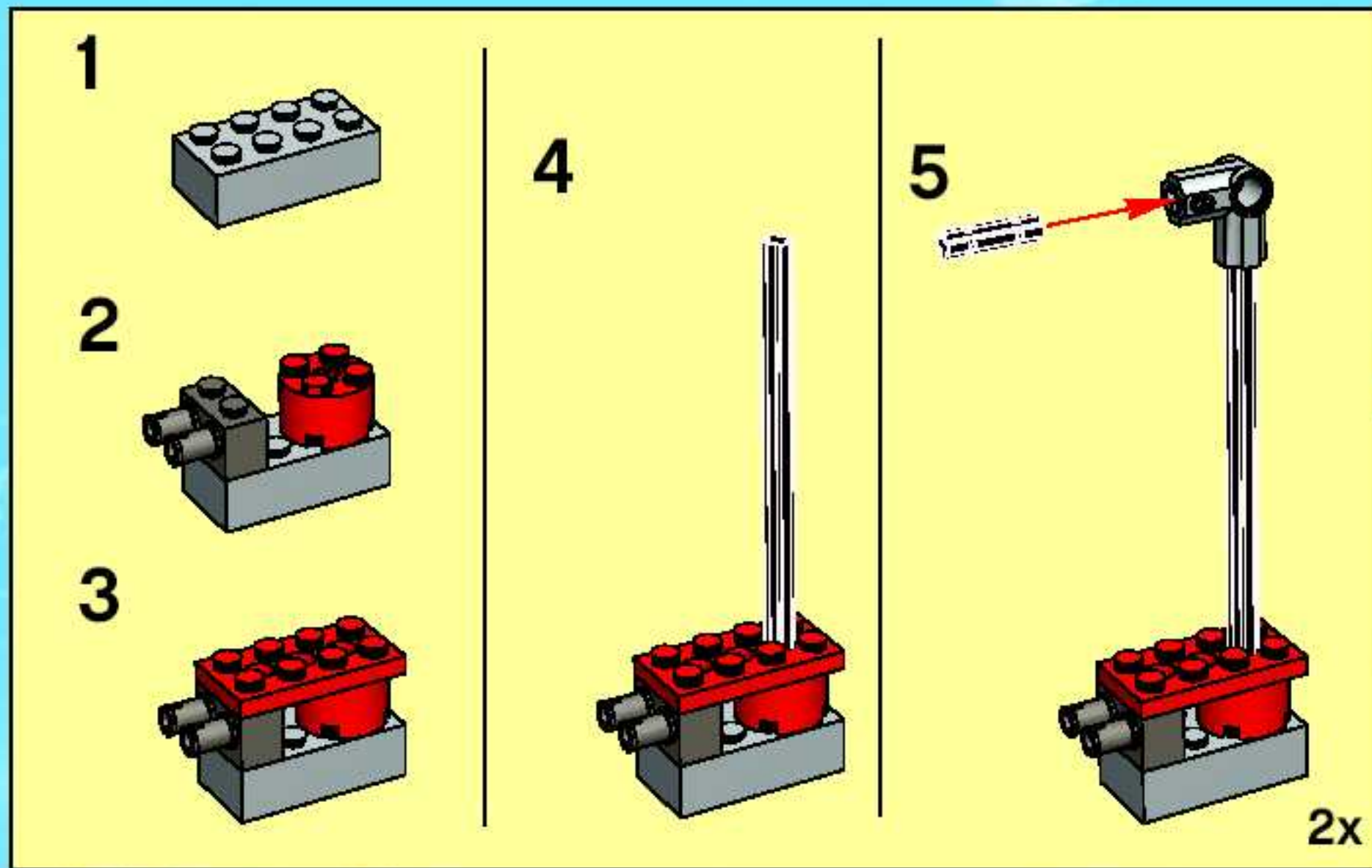

12



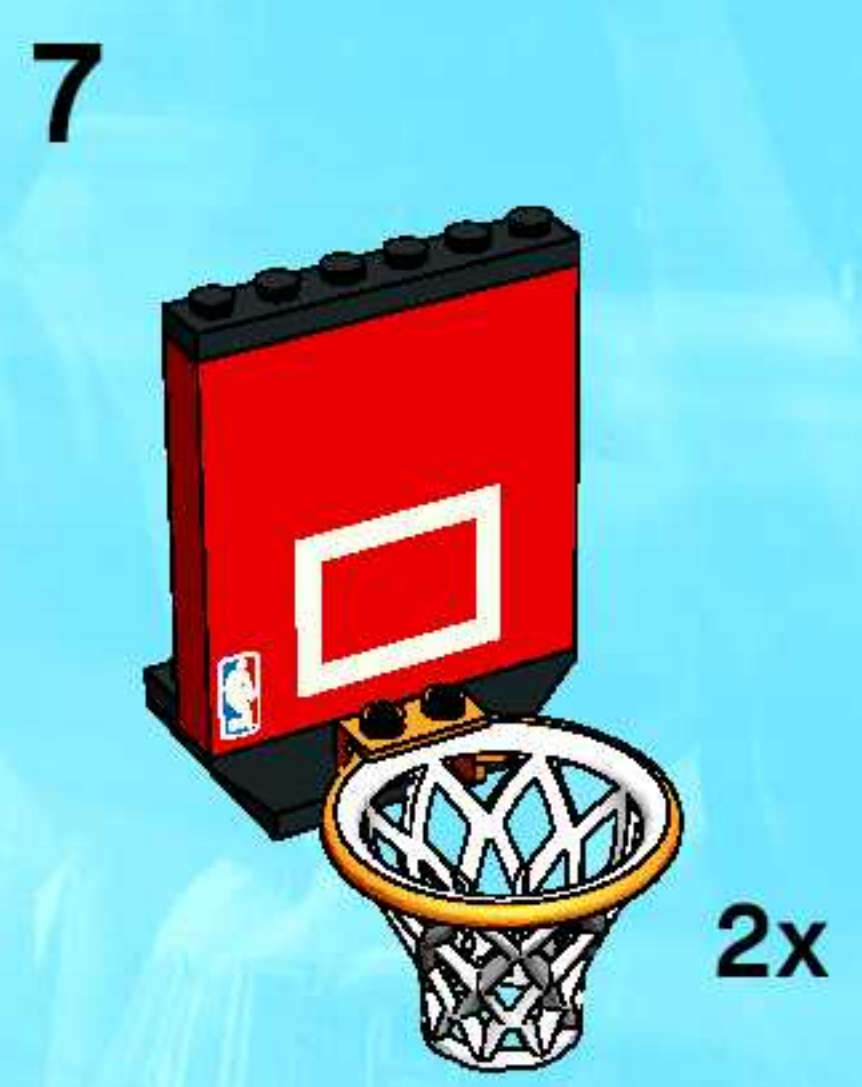
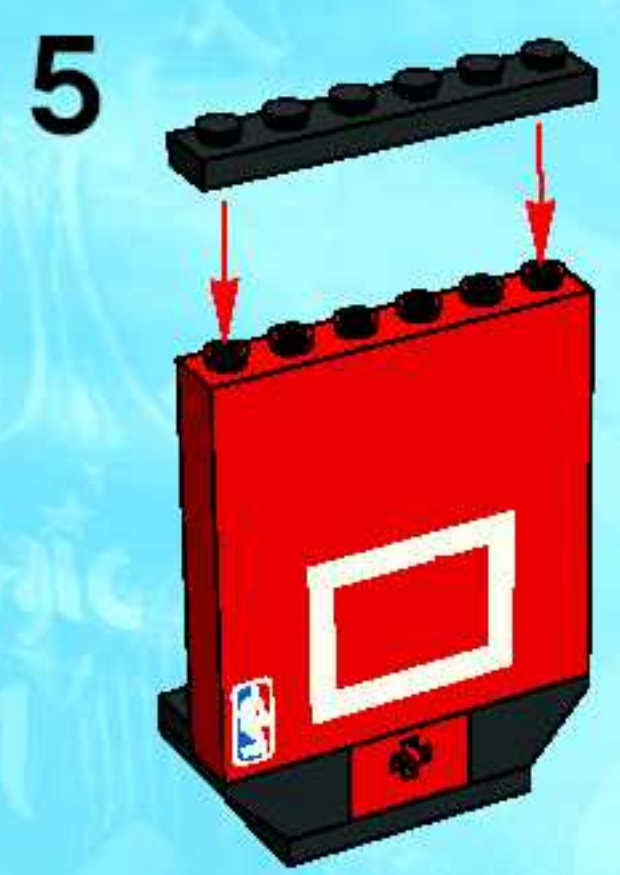
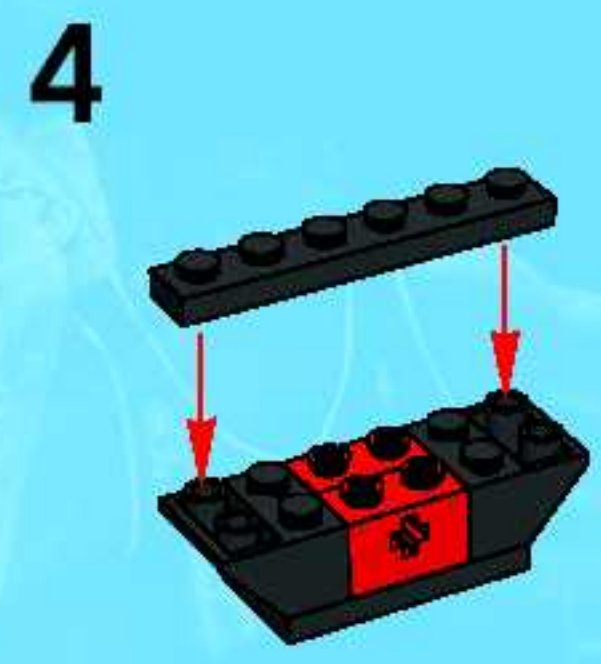
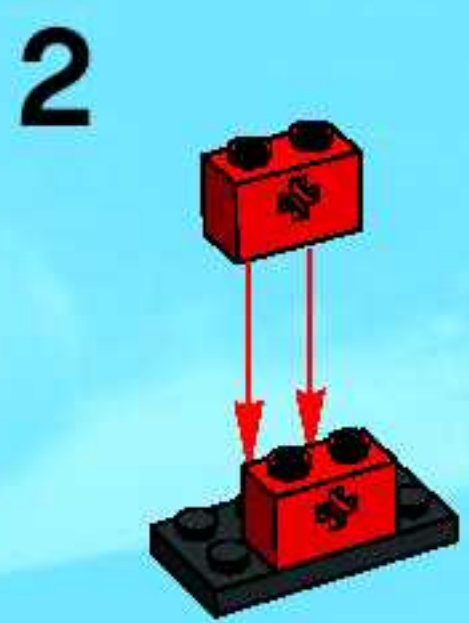

13



14





 www.LEGO.com/sports

 **NBA**
.COM

 **NBA**



© 2005 NBA Entertainment.
Photo by Rocky Winstrom/NBAE/Getty Images.

© 2003 NBA Entertainment.
Photo by Jesse D. Garrabrant
NBAE/Getty Images.

© 2003 NBA Entertainment.
Photo by Jesse D. Garrabrant
NBAE/Getty Images.

© 2004 NBA Entertainment.
Photo by Getty Images.

© 2004 NBA Entertainment.
Photo by Doug Peltier/NBAE/Getty Images.

© 2003 NBA Entertainment.
Photo by Rocky Winstrom/NBAE/Getty Images.



#3431

#3428



#3427 + #3428





3431+3430

1

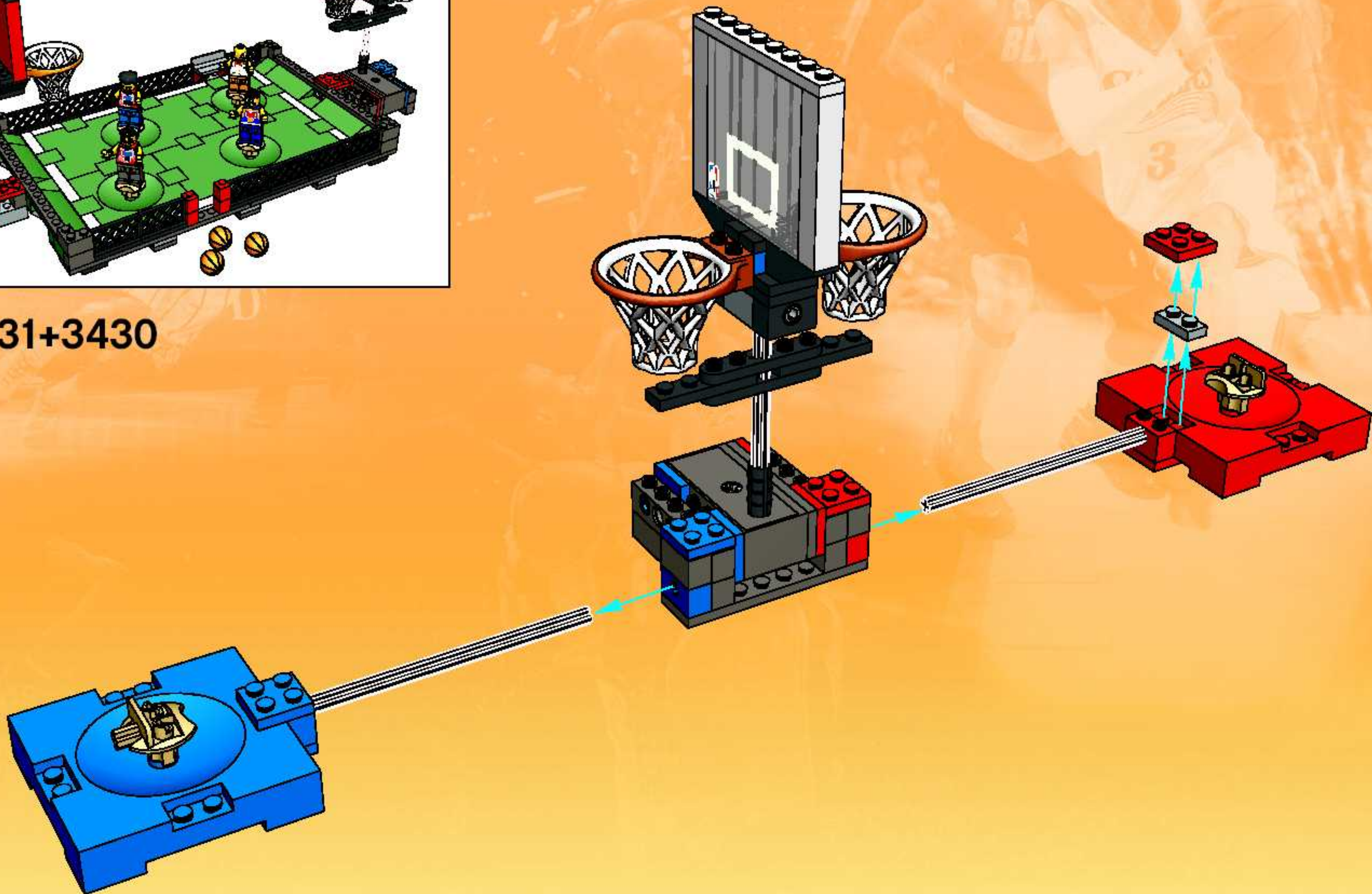

2



3



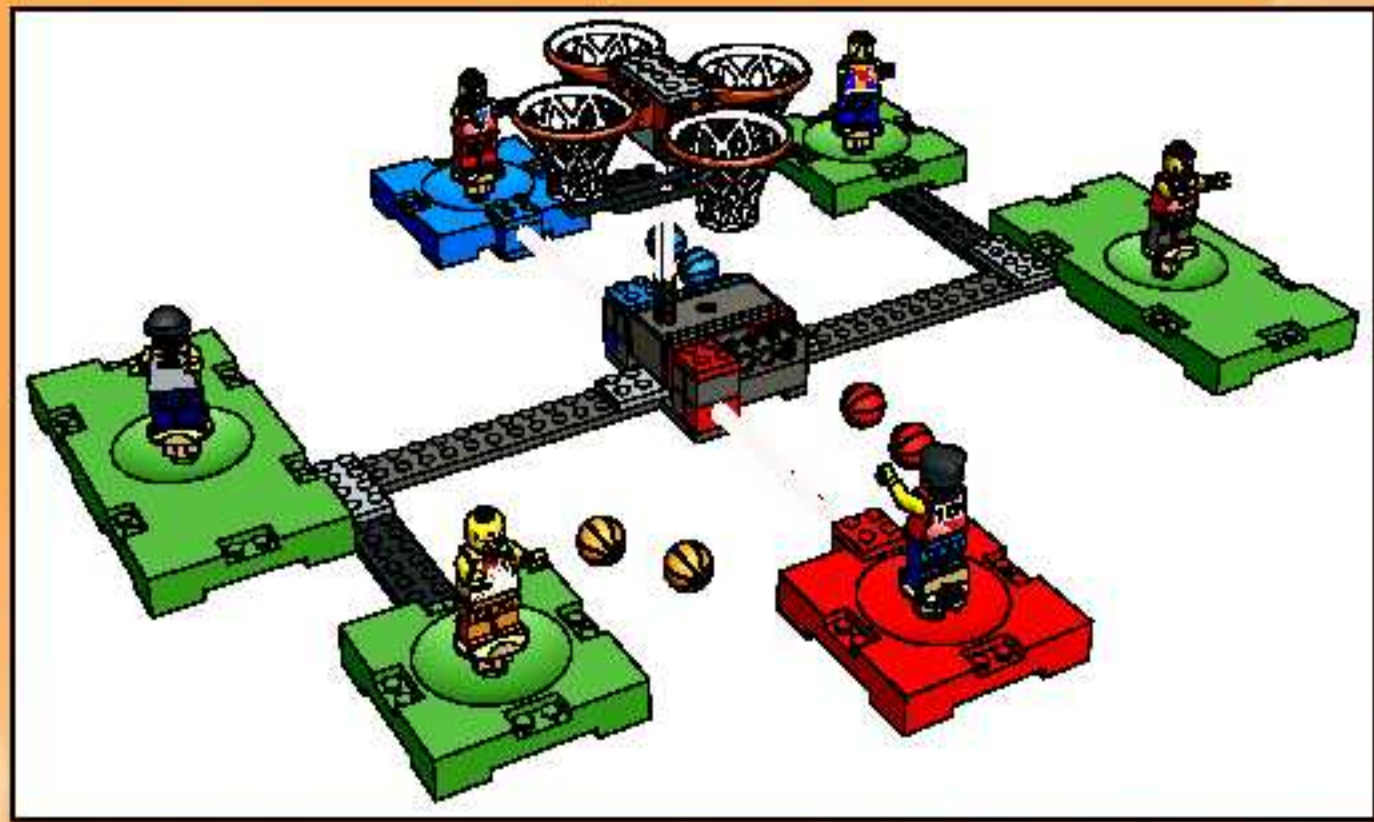

3431+3430

1

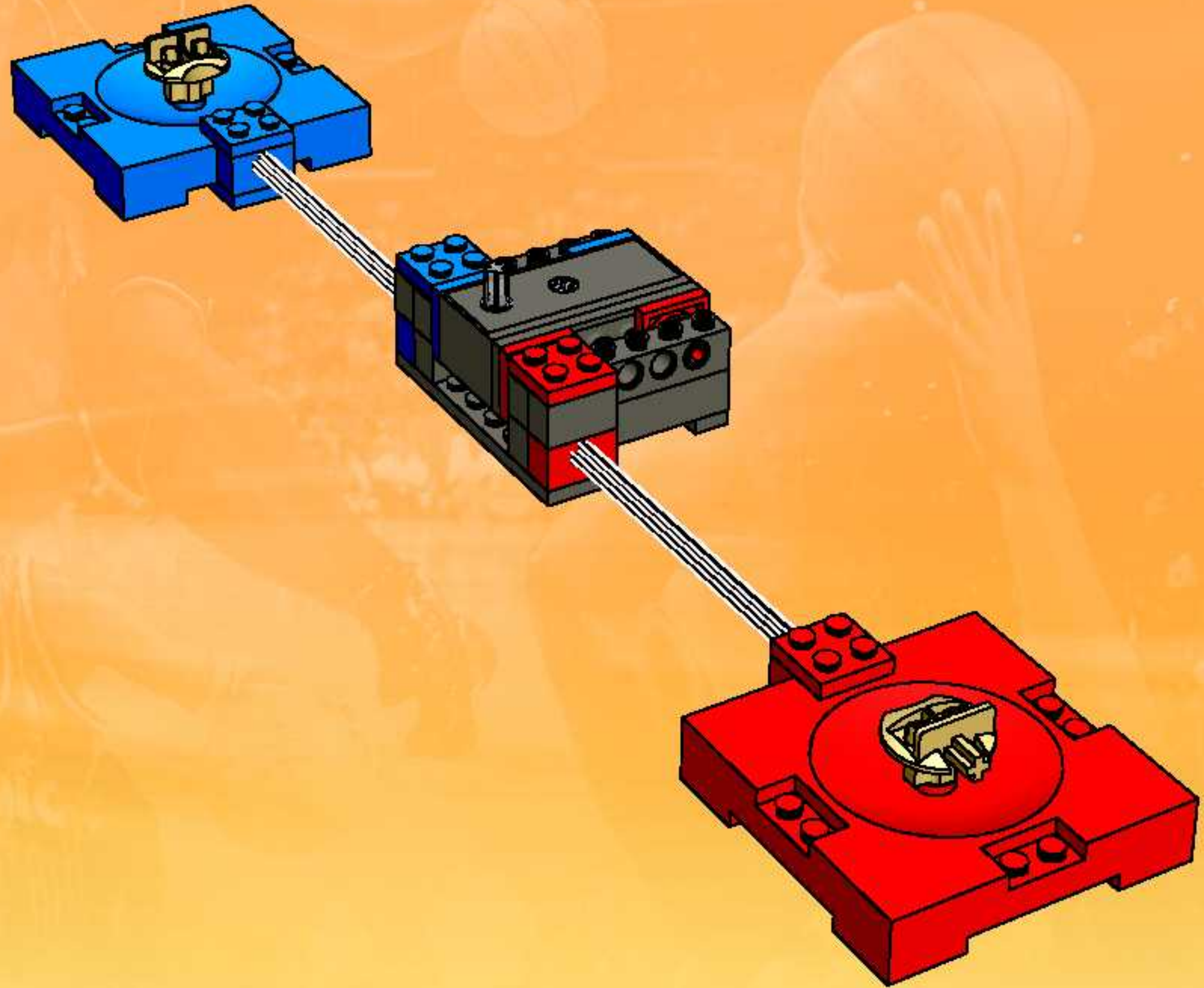

1

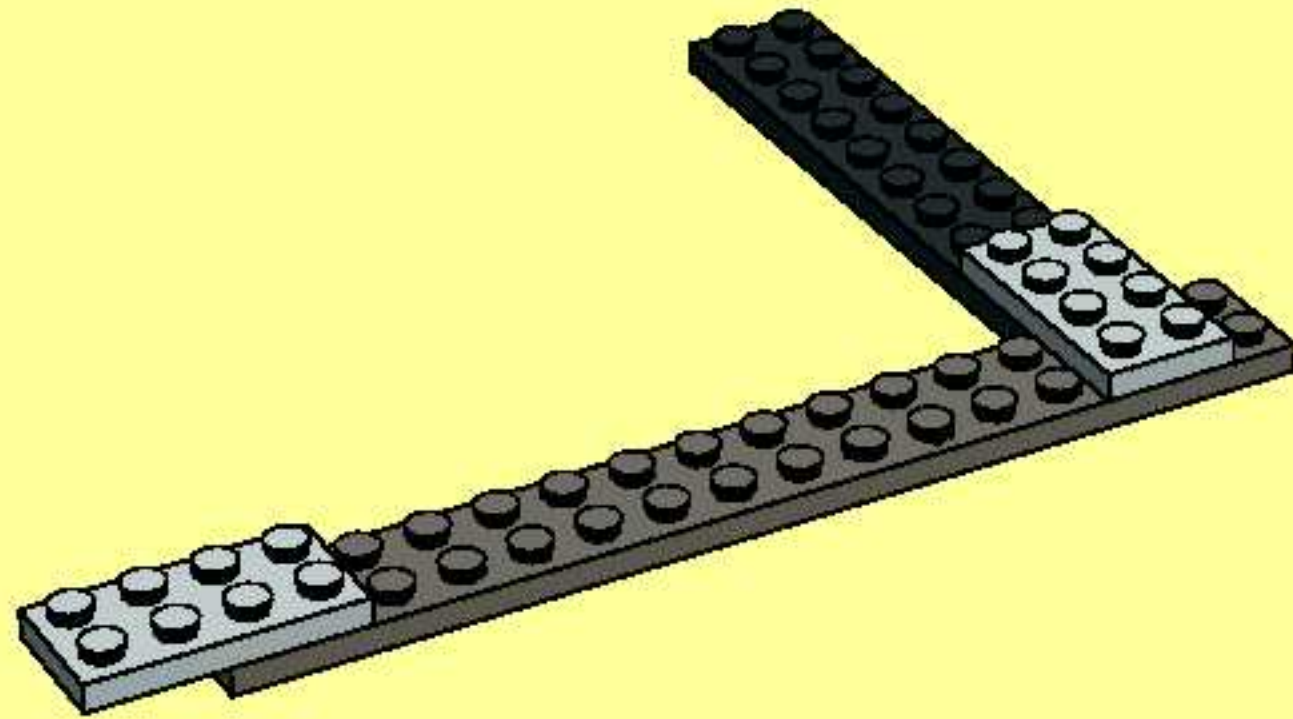

2

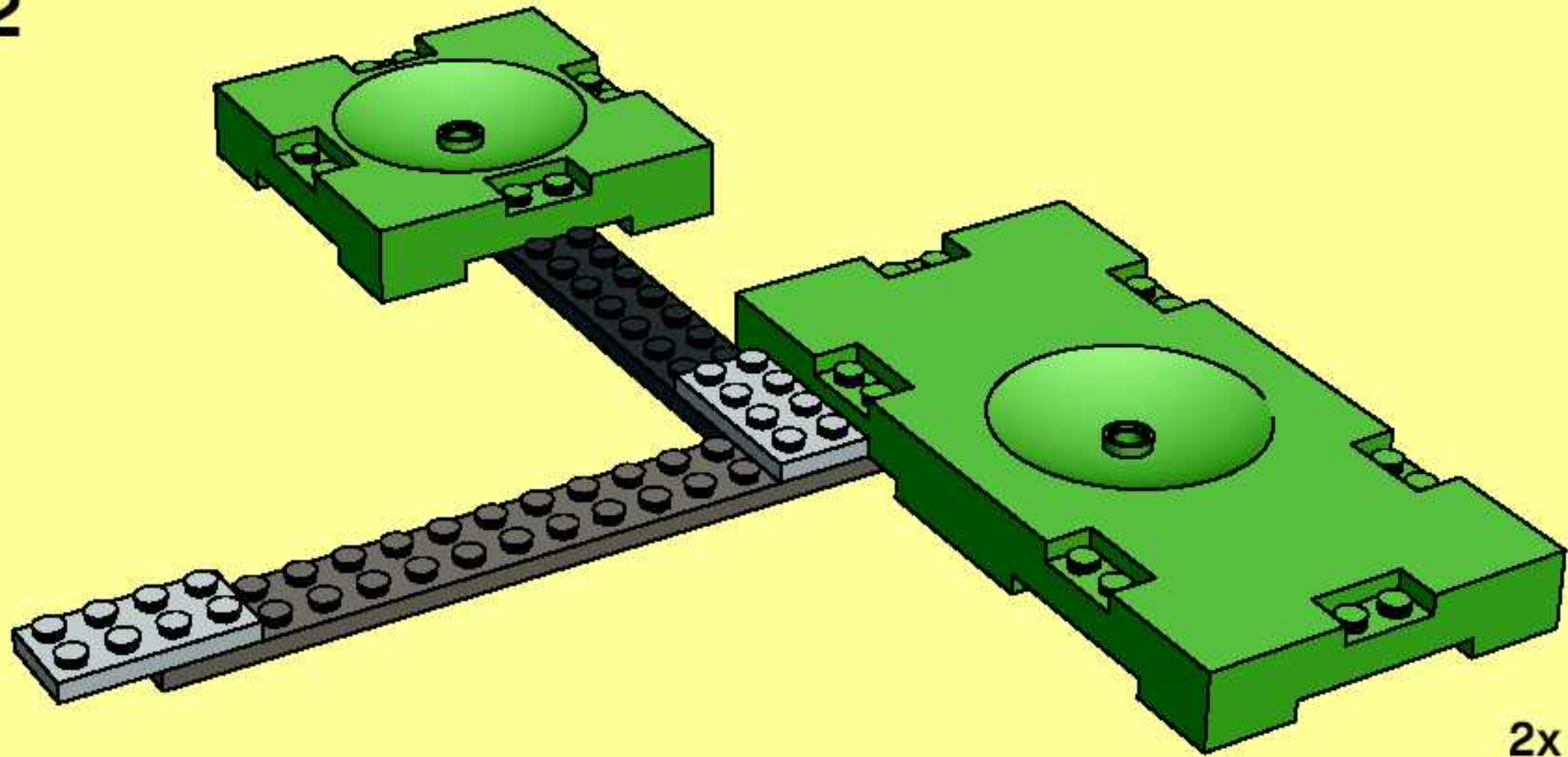

2x

2

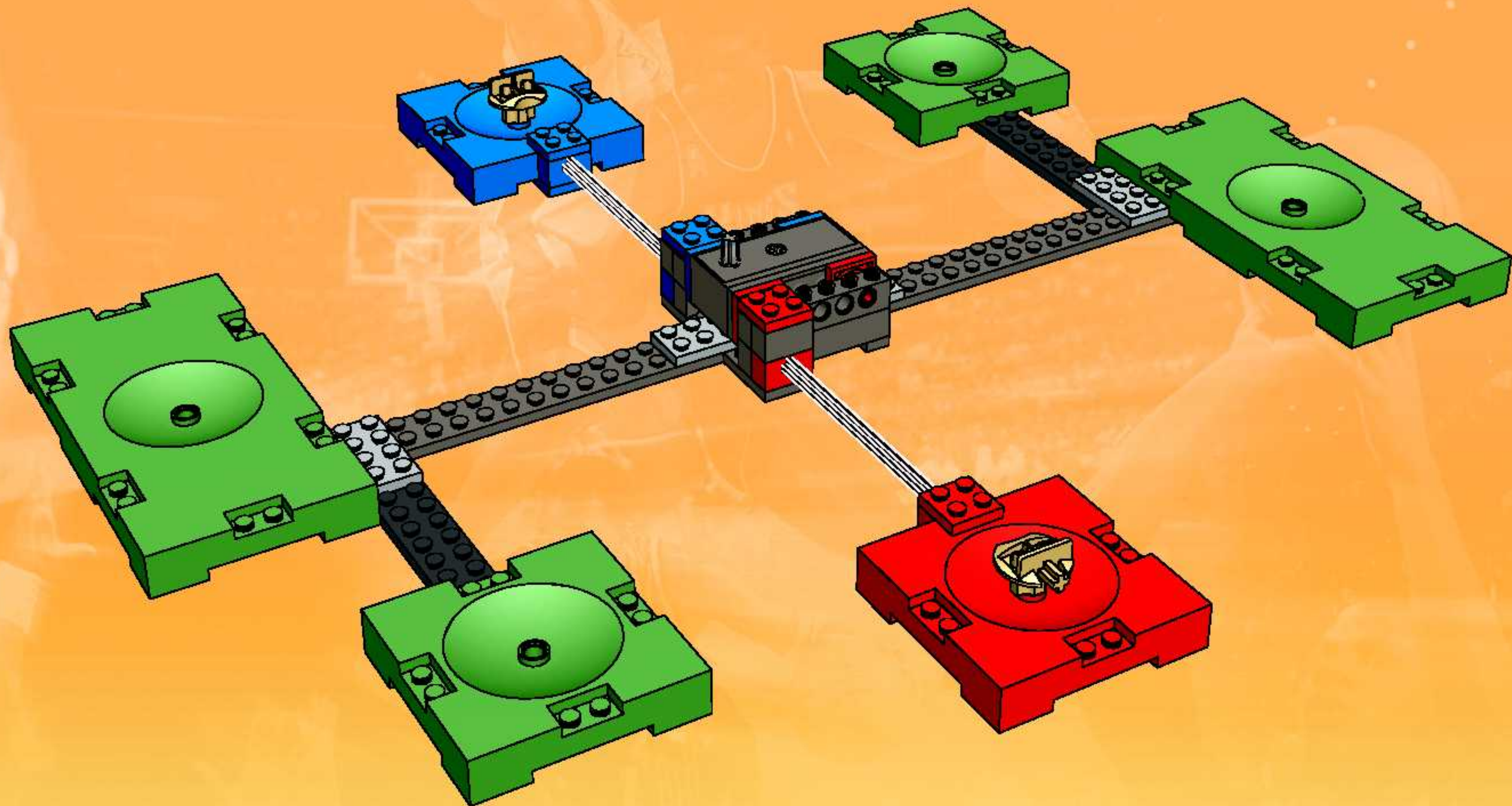

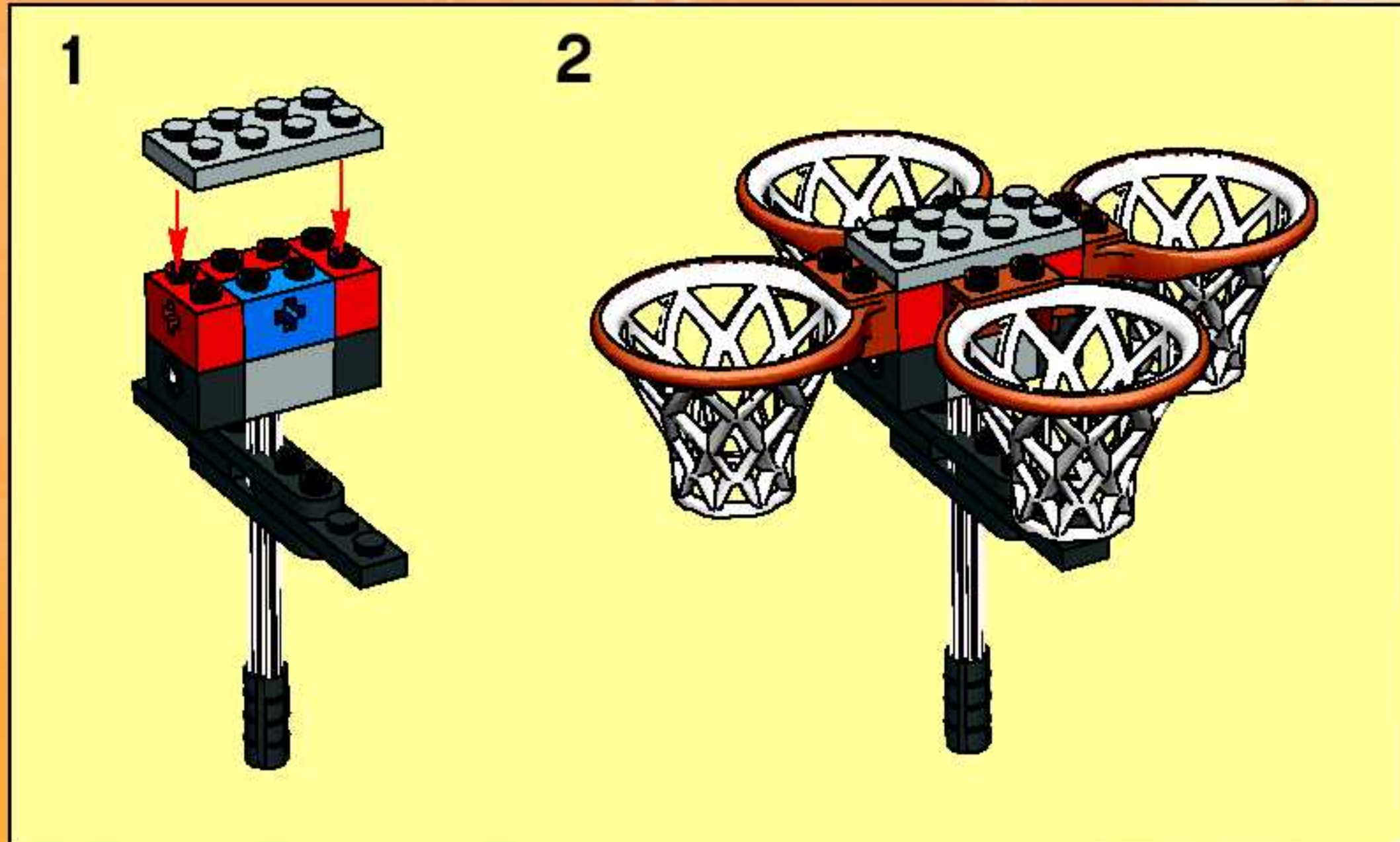

3

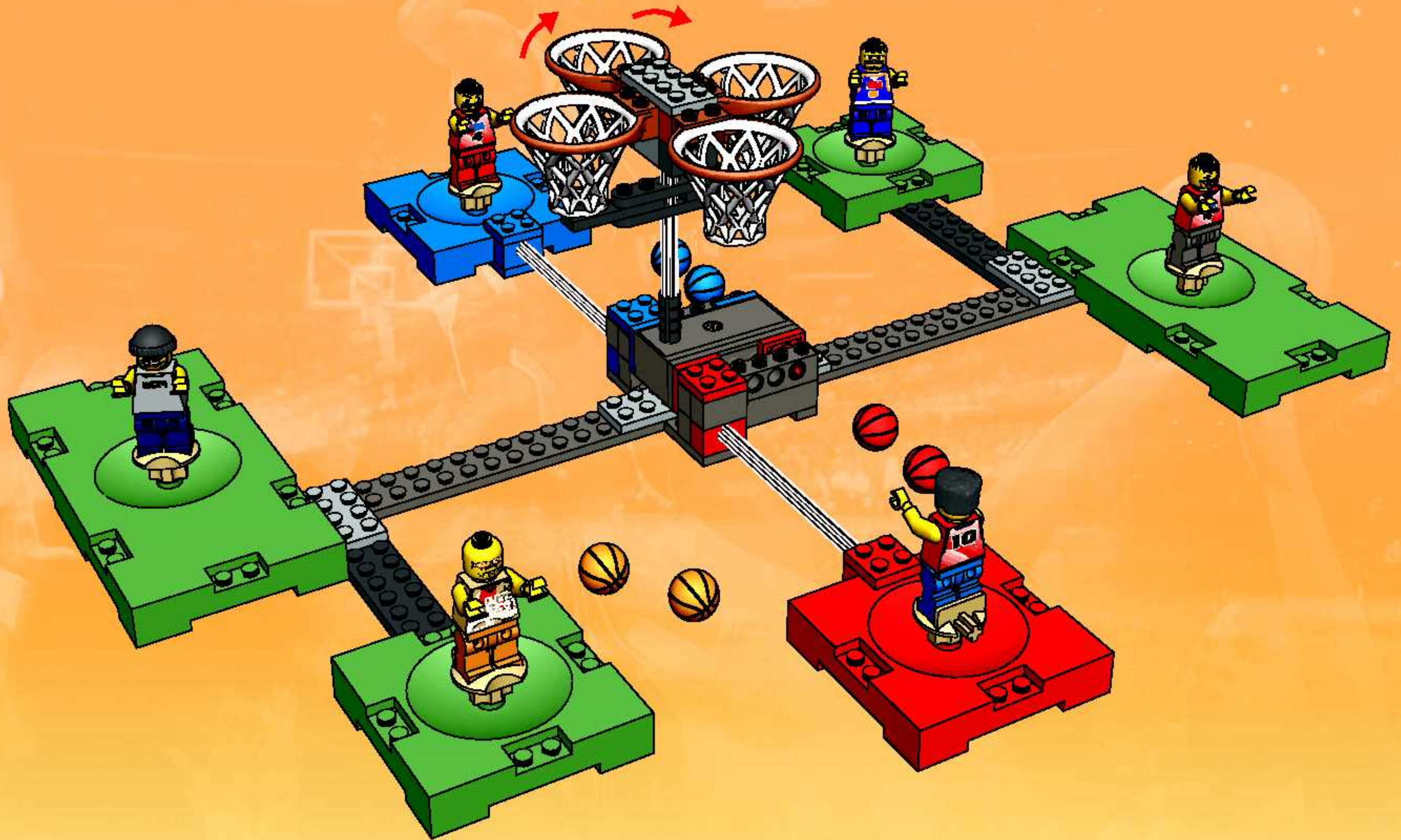

LEGO SPORTS



NBA identifications depicted are the exclusive property of NBA Properties, Inc. and/or the NBA Member Teams, and are used with permission.

Les identifications NBA reproduites sont la propriété exclusive de NBA Properties, Inc. et/ou des équipes membres de la NBA et sont reproduites sous autorisation.

Las identificaciones retratadas de la NBA son propiedad exclusiva de NBA Properties, Inc. y/o de los miembros de los equipos de la NBA, y son usados bajo permiso.

SPALDING is a trademark of/ est une marque de commerce de/ es una marca registrada de Spalding Sports Worldwide, Inc. or/ou/ Lisco Sports, Inc., a Spalding affiliate/une filiale de Spalding/un afiliado de Spalding. © Spalding Sports Worldwide, Inc. 2003.

 www.LEGO.com/sports

LEGO and the LEGO logo are trademarks of/son marcas registradas de LEGO Group. ©2003 The LEGO Group.

NHL and the NHL Shield are registered trademarks of the National Hockey League. All NHL logos and marks and team logos and marks depicted herein are the property of the NHL and the respective teams and may not be reproduced without the prior written consent of NHL Enterprises, L.P. © NHL 2003. All Rights Reserved.

LNH et le Sigle LNH sont des marques déposées de la Ligue Nationale de Hockey. Tous les logos et marques de ses équipes sont la propriété de LNH et des équipes respectives et ne peuvent pas être reproduits sans le consentement préalable par écrit de LNH Enterprises, L.P. © LNH 2003. Tous droits réservés.

NHL y el escudo de la NHL son marcas registradas de la Liga Nacional de Hockey. Todos los logotipos, marcas y logotipos de los equipos de la NHL representados en el mismo son propiedad de la NHL y de sus respectivos equipos y no deberán ser reproducidos sin el consentimiento escrito de NHL Enterprises, L.P. © NHL 2003. Todos los Derechos Reservados.

adidas, the adidas logo and the three stripe trademark are registered trademarks of the adidas-Salomon group, used with permission. Fevernova and the Trigon logo are trademarks of the adidas-Salomon group, used with permission.

adidas, le logo adidas et la marque aux trois bandes sont des marques déposées du groupe adidas-Salomon, utilisées avec sa permission. Fevernova et le logo Trigon sont des marques déposées du groupe adidas-Salomon, utilisées avec sa permission.

adidas, el logotipo adidas y el símbolo de tres bandas son marcas registradas del grupo adidas-Salomon y se utilizan con autorización. Fevernova y el logotipo Trigon son marcas registradas del grupo adidas-Salomon y se utilizan con autorización.