

# RAMSES'S Pyramid



3843





1

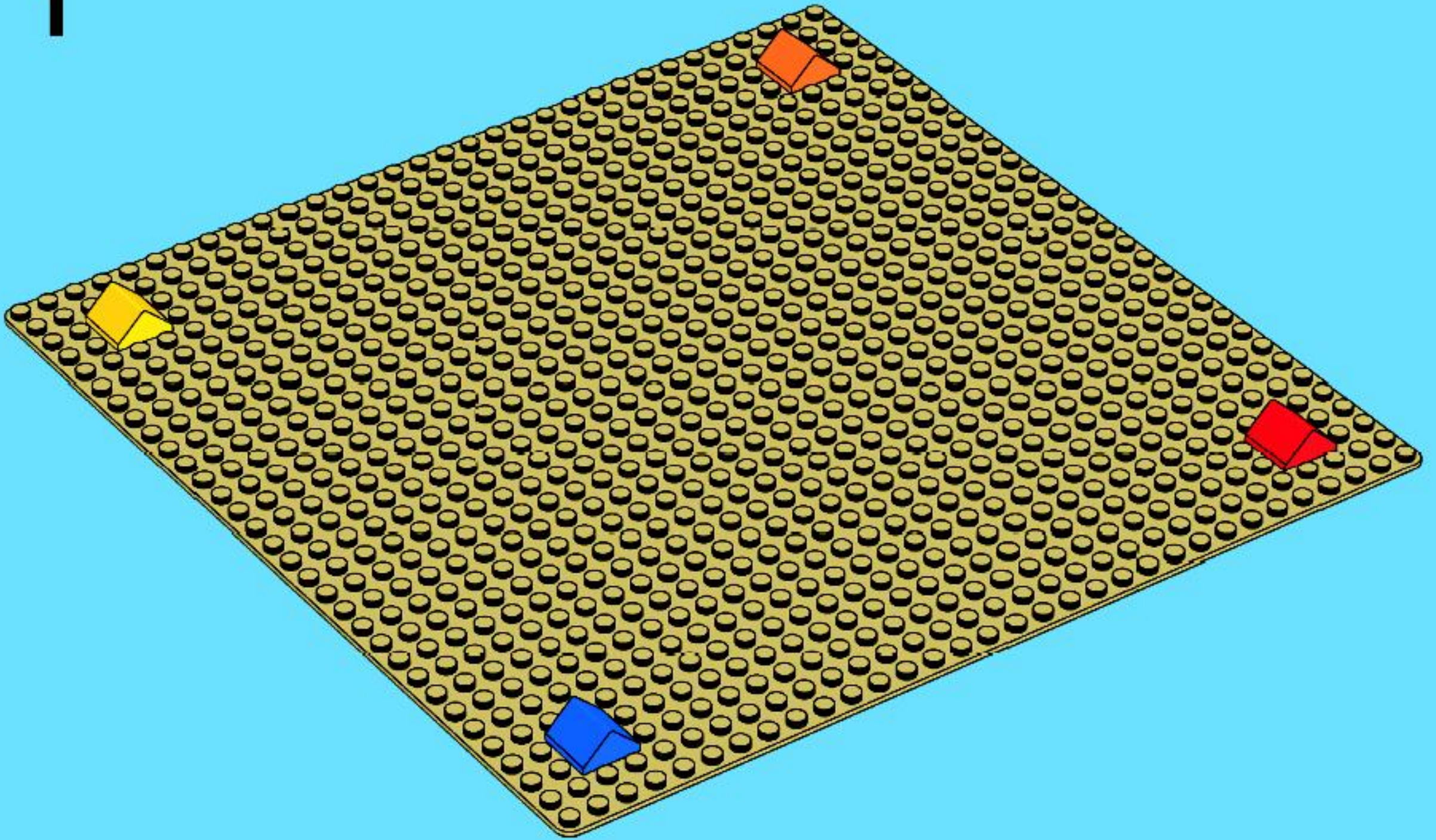

2

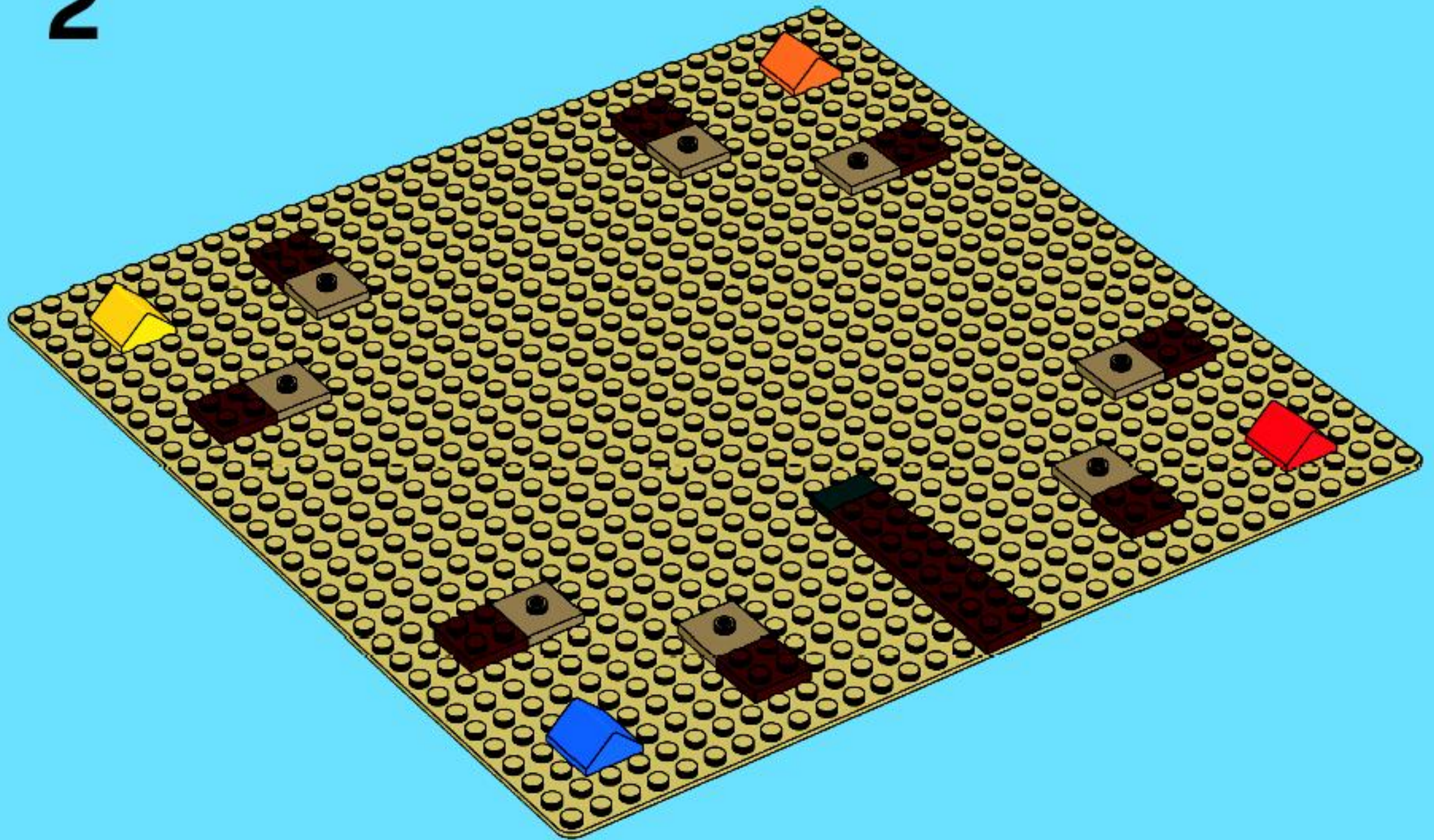

3

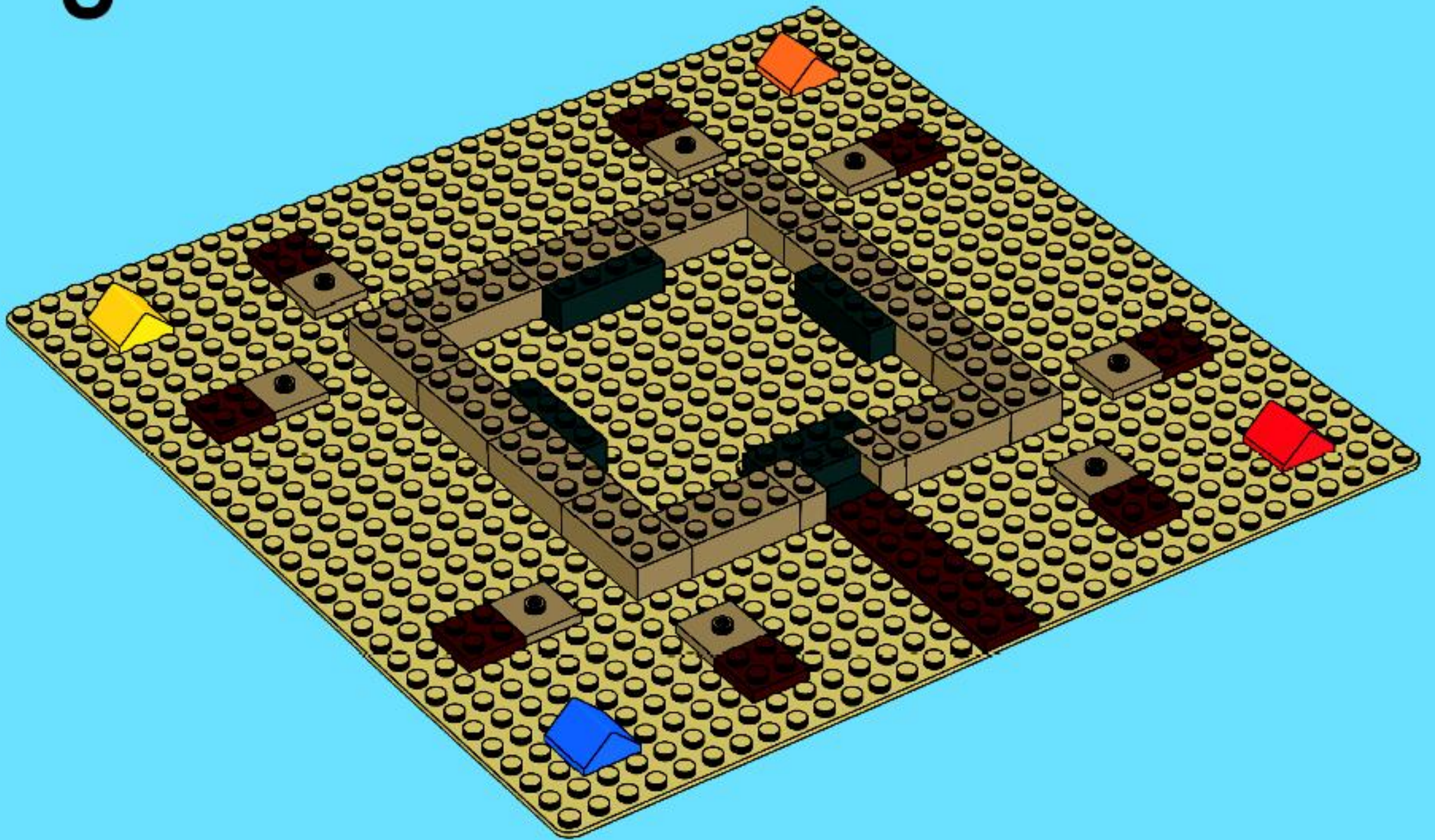

4

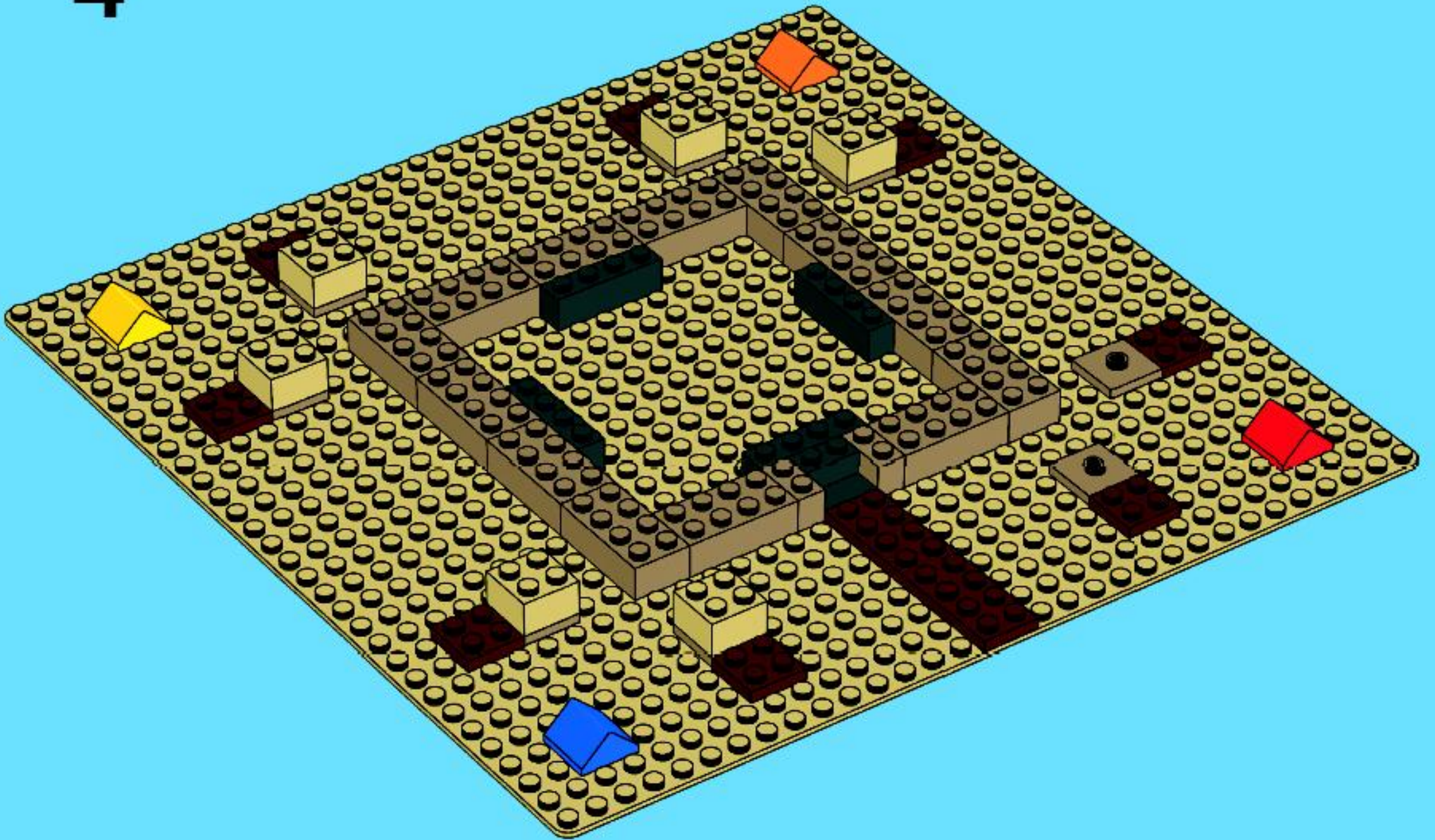

5



6



7





1



2



3



8



1

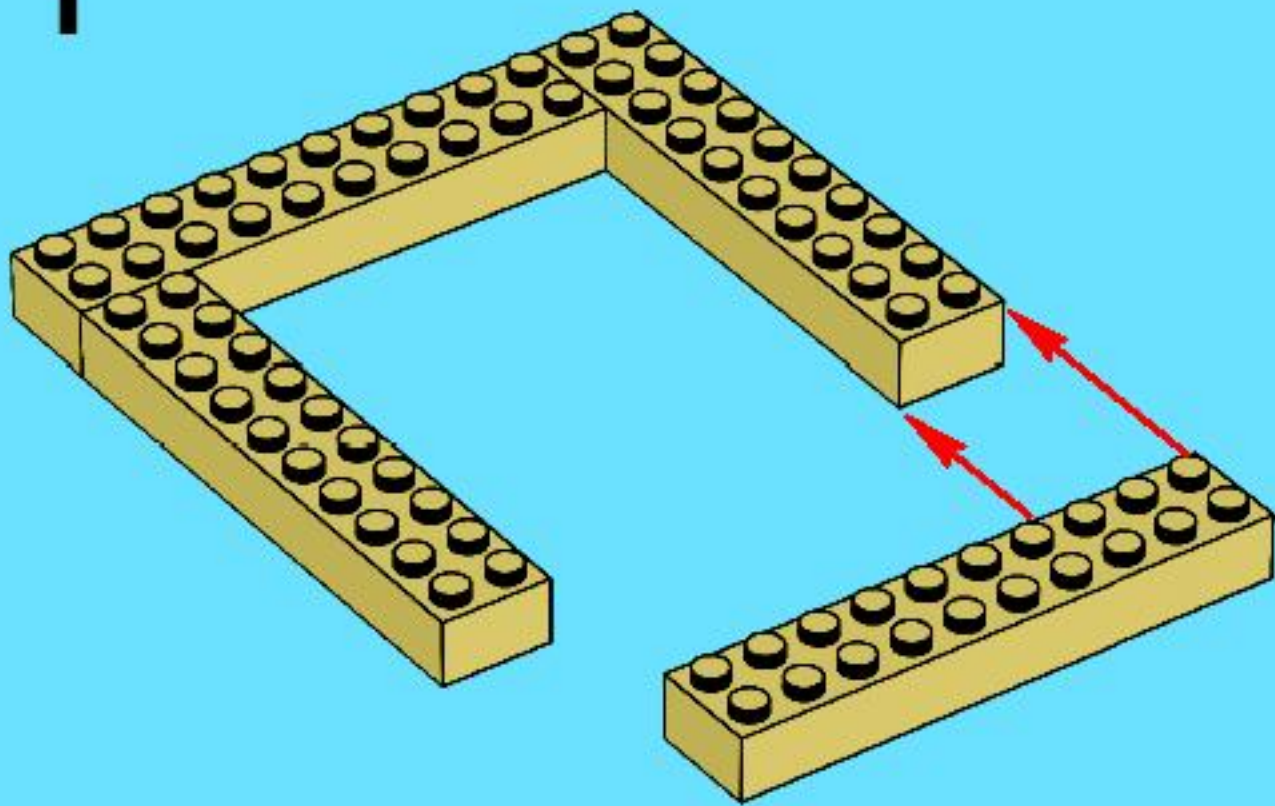

3

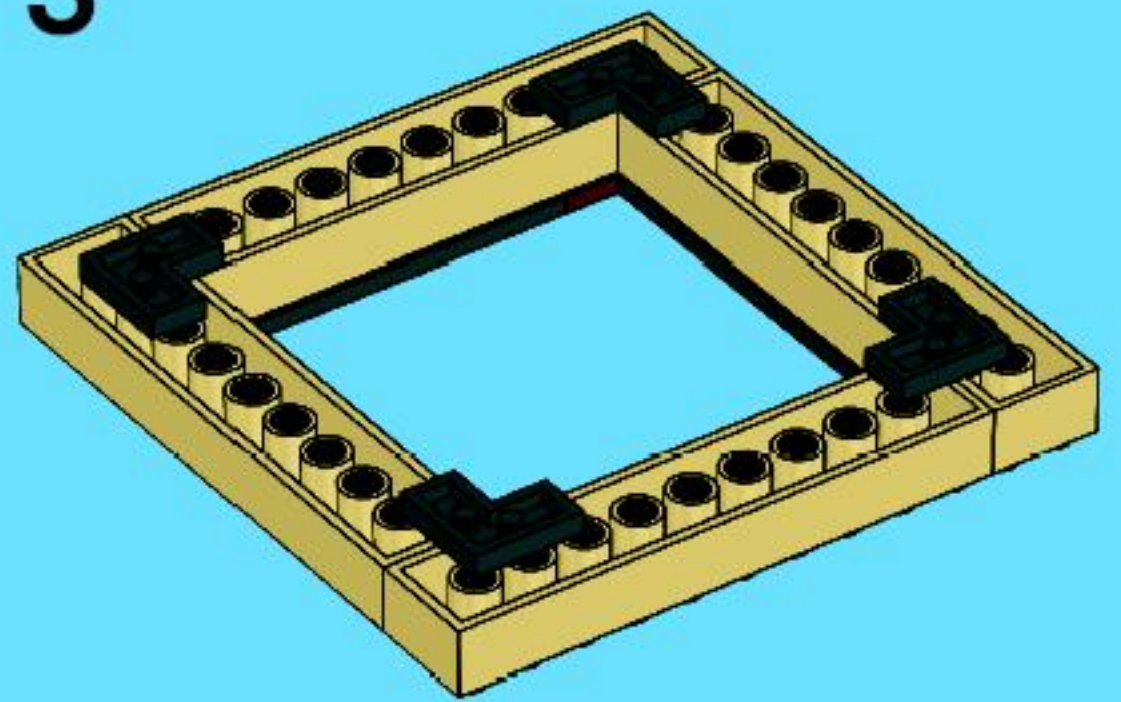

2

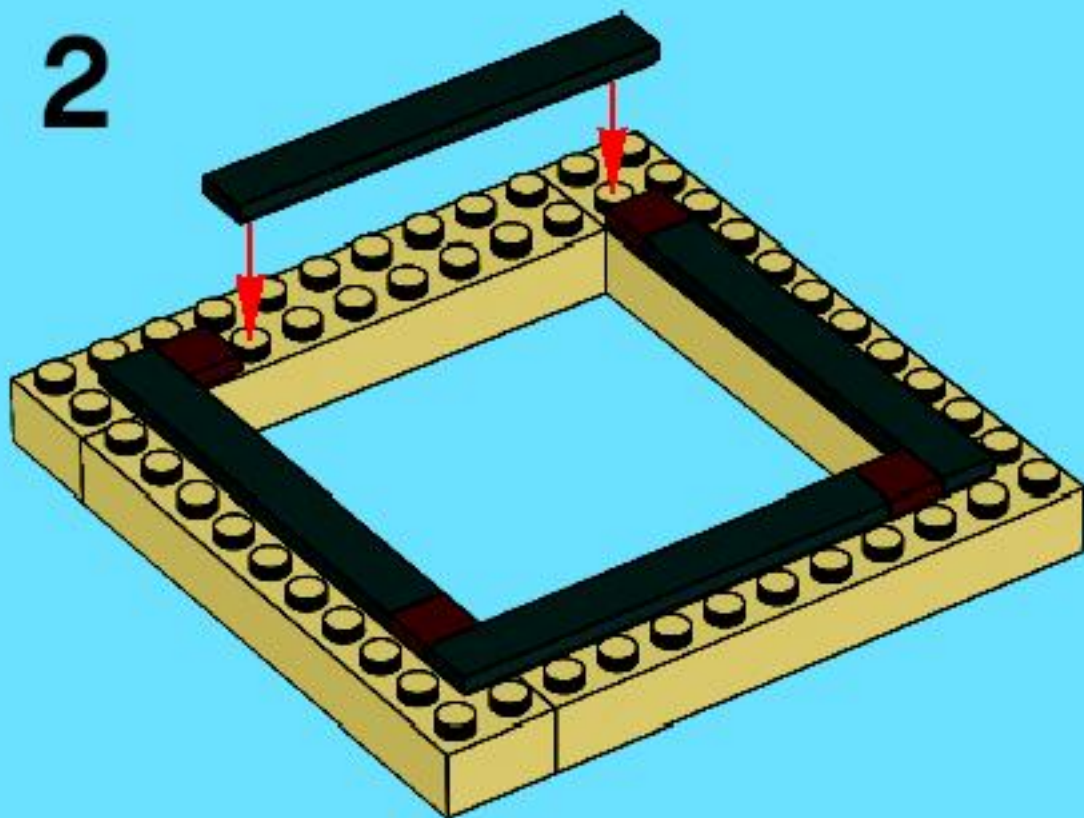

4

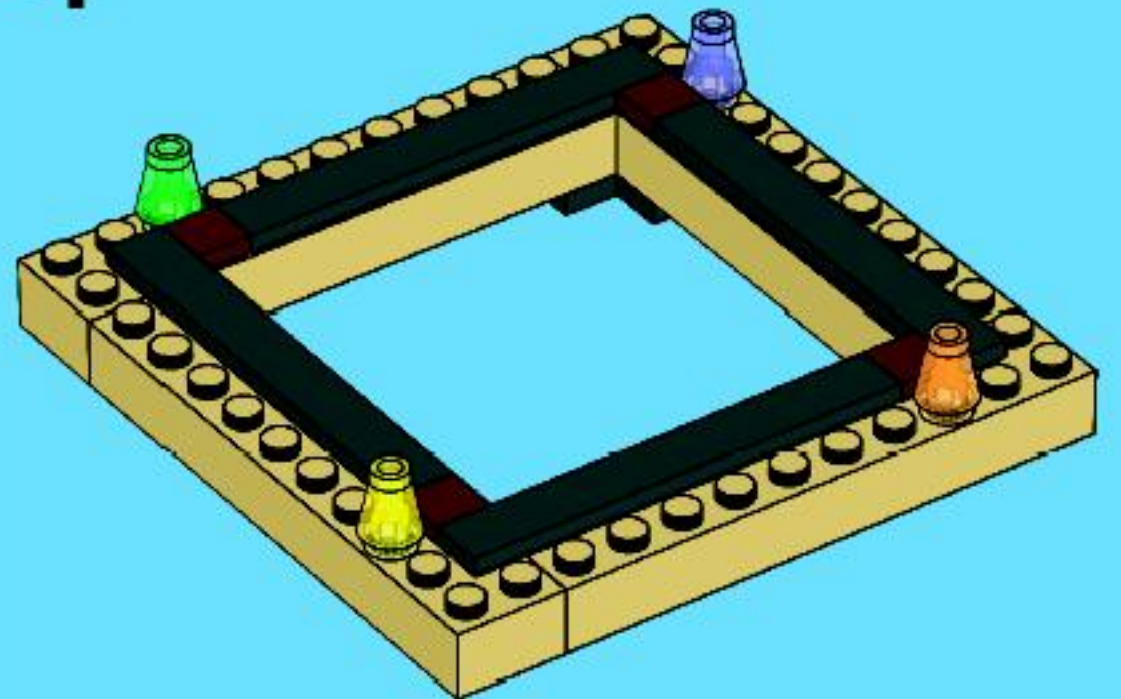

9



1

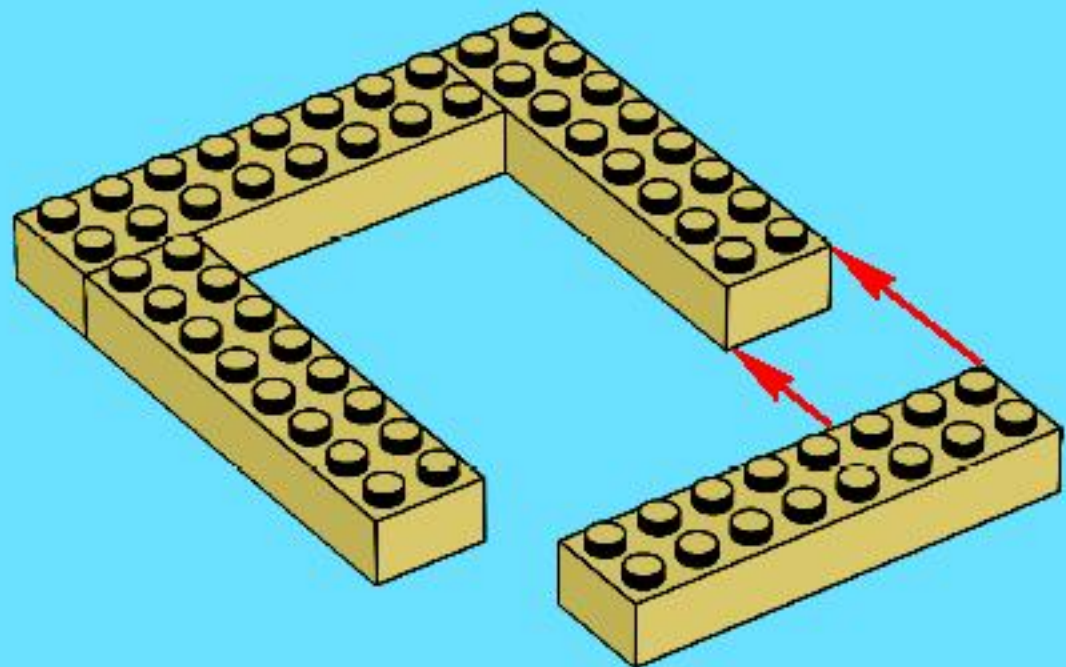

2

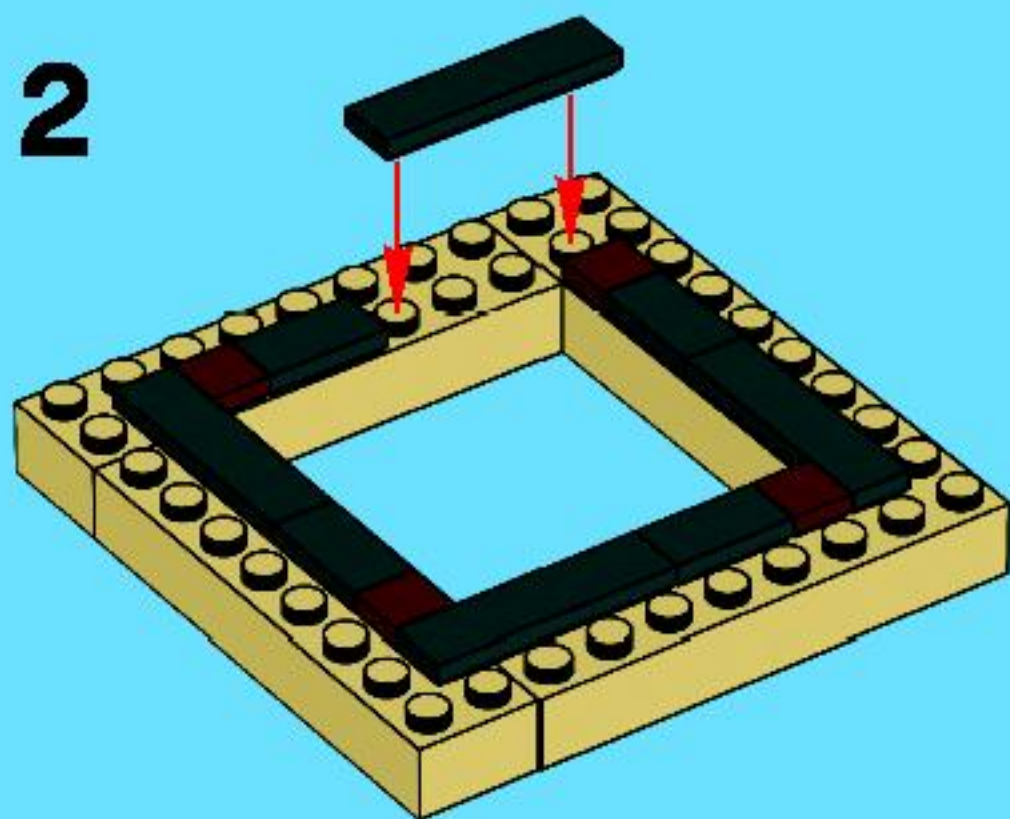

3

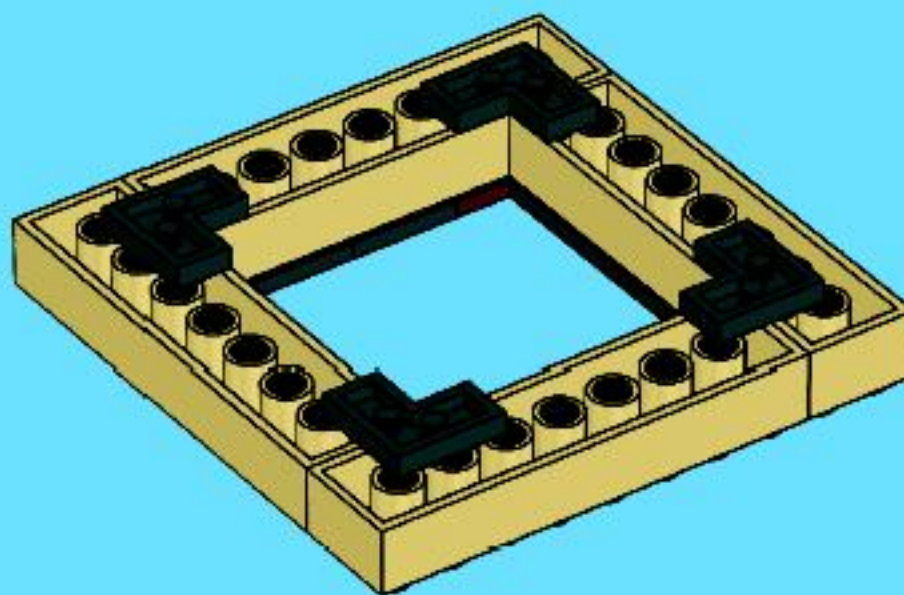

4

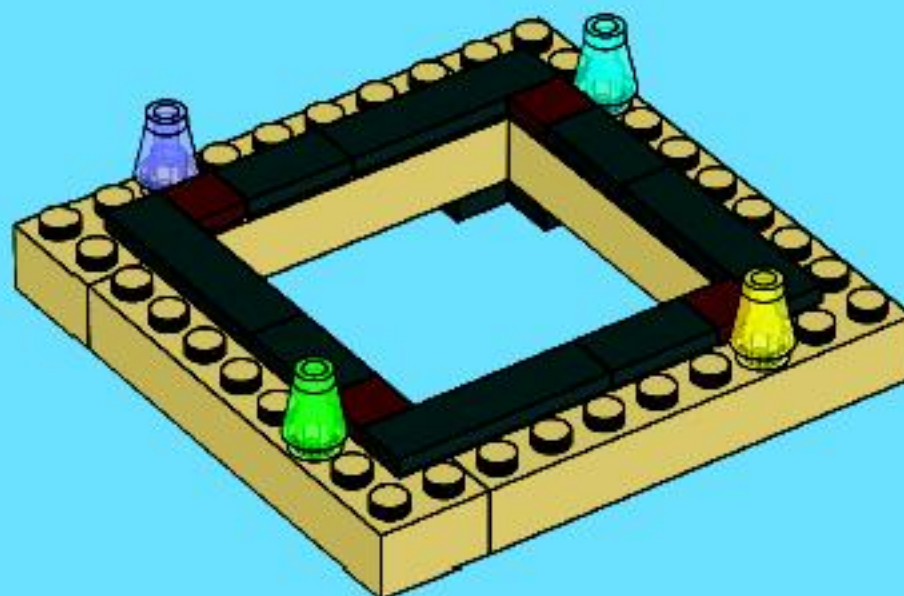

10



1

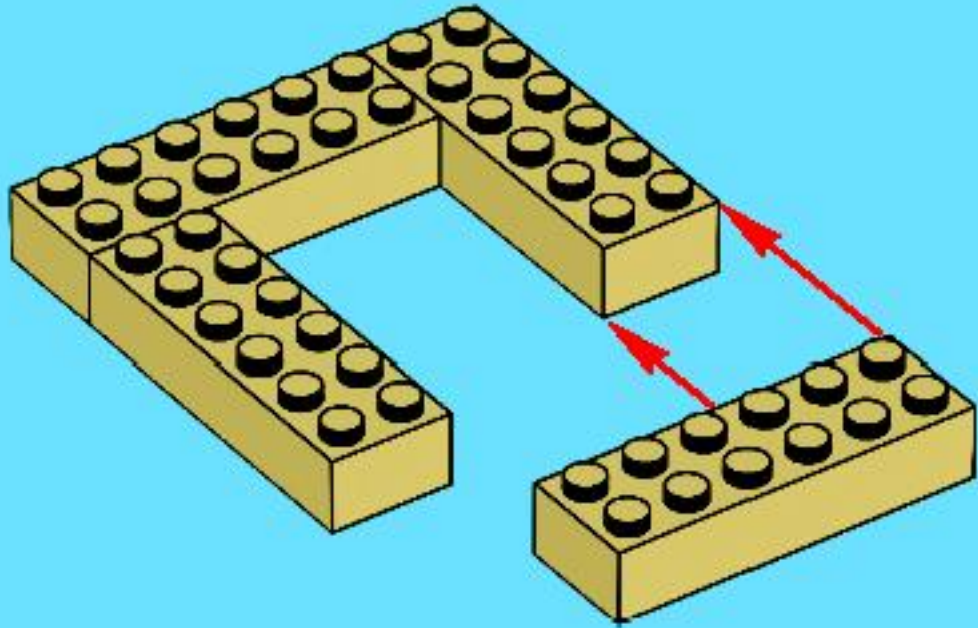

2

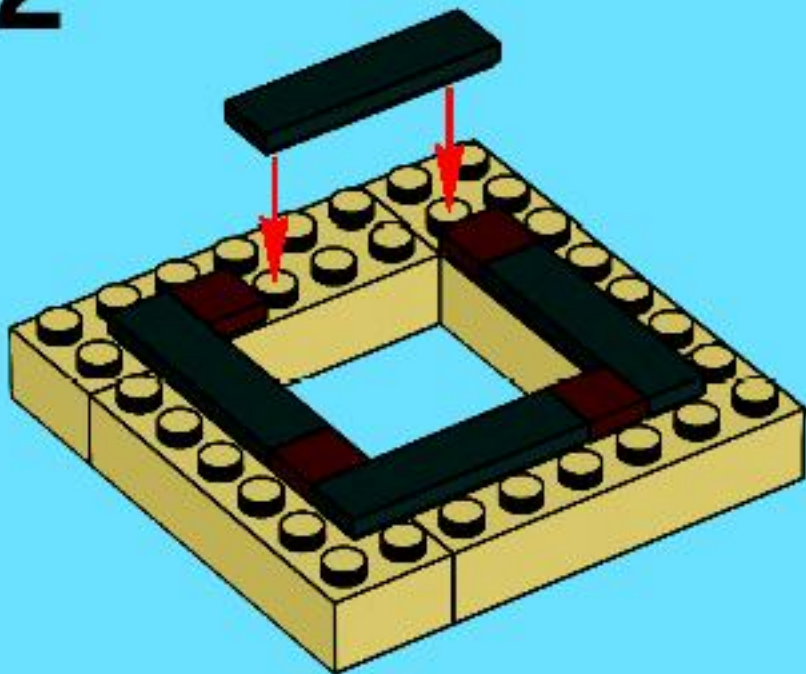

3

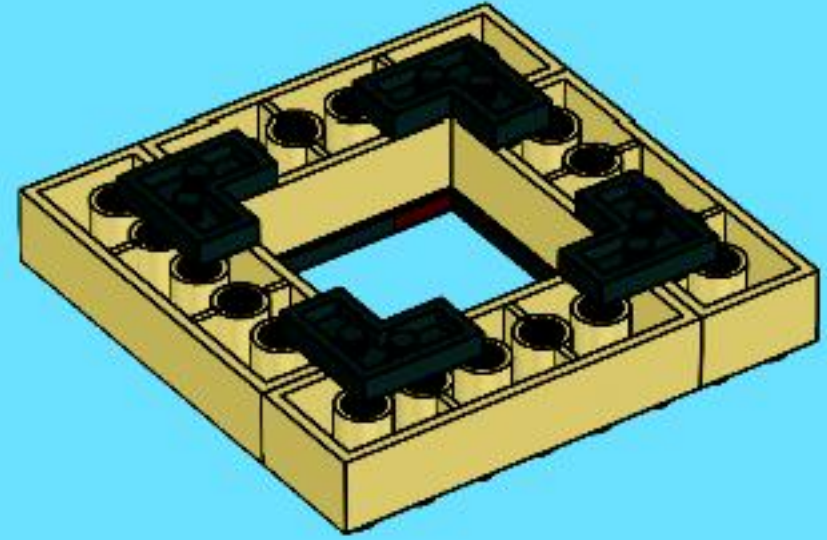

4

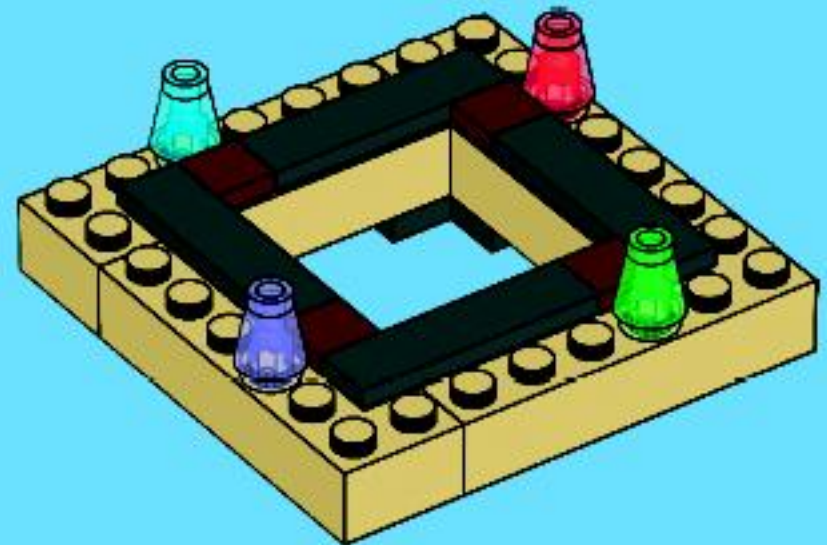

11

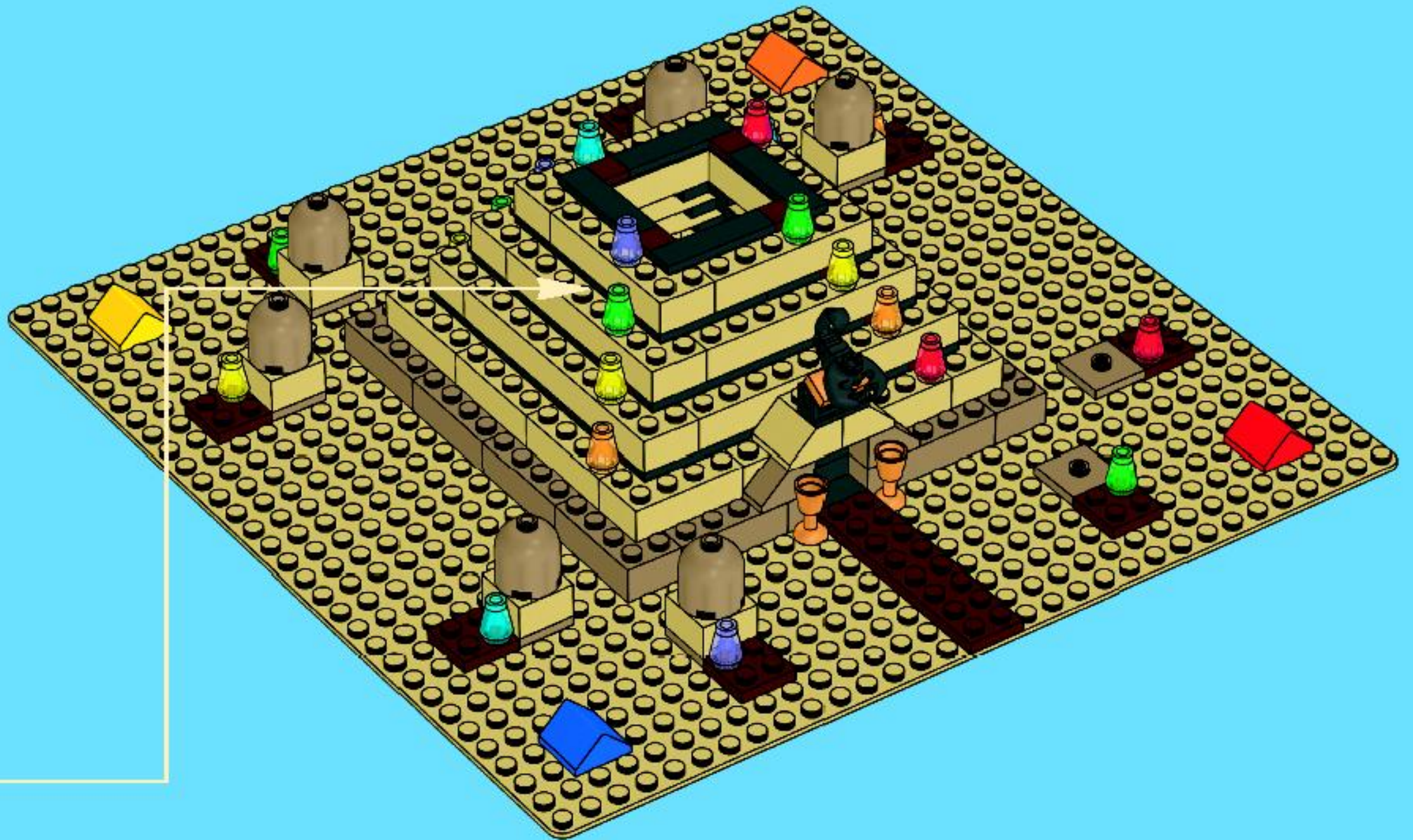

1

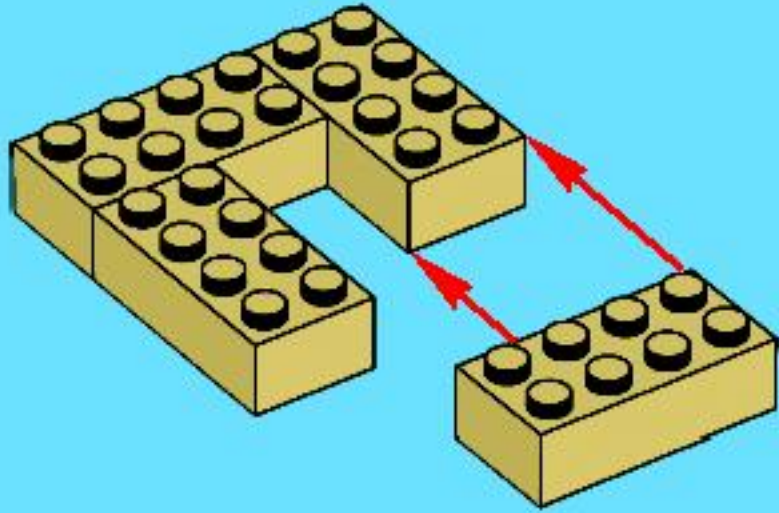

2

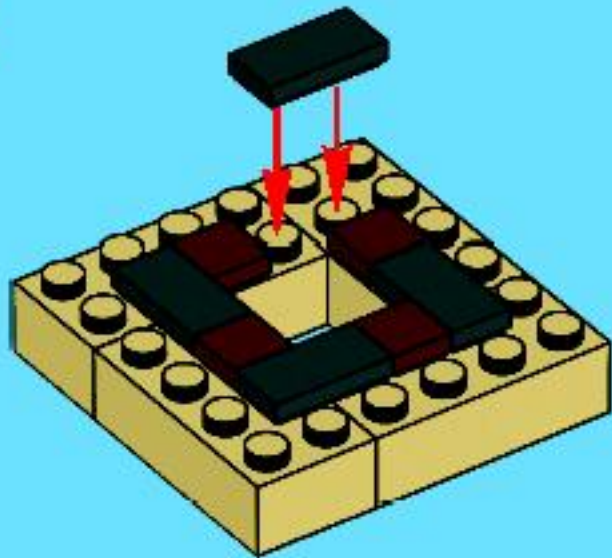

3

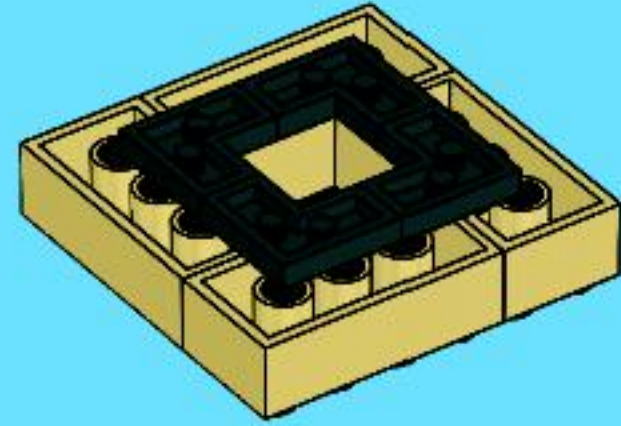

4





12



1

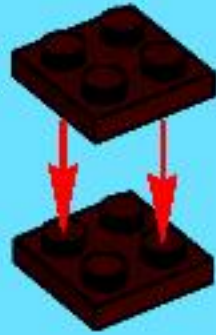

2

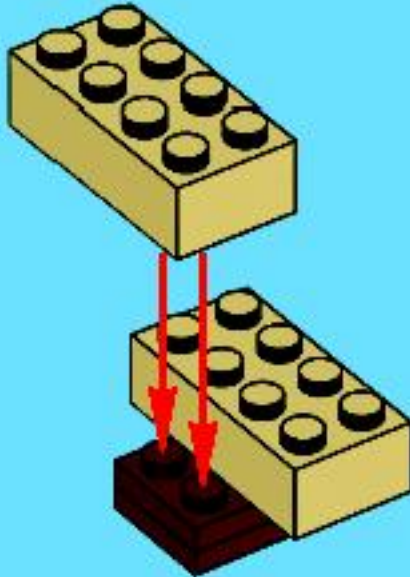

3

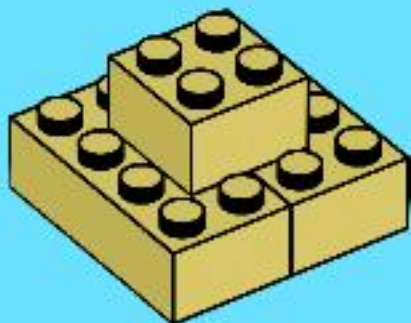

4

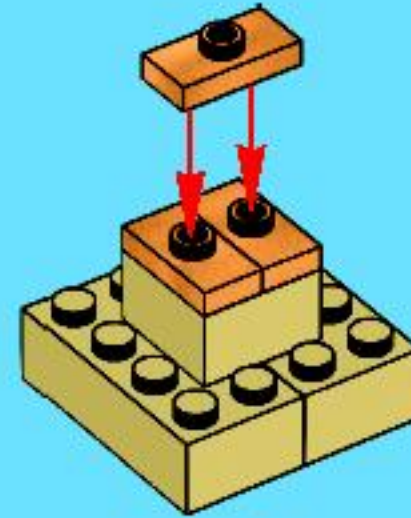

5



6





- 1x 4560463
- 8x 4560464
- 1x 4560473
- 1x 4540383
- 2x 4560815
- 2x 4560646
- 20x 4211288
- 10x 4216695
- 1x 4211211
- 8x 4114306
- 17x 4114319
- 4x 4181134
- 4x 4141533
- 4x 4522675
- 2x 4114322
- 1x 4560460
- 1x 4560575
- 6x 4567332
- 7x 4567333
- 2x 4521914
- 13x 4247145
- 6x 4558697
- 2x 4530678
- 8x 4560545
- 1x 4560434
- 1x 4560461
- 1x 304321
- 6x 4544720
- 1x 4560462
- 4x 4523157
- 6x 4505990
- 1x 4516816
- 1x 4557385
- 6x 4567338
- 1x 300426
- 4x 301026
- 1x 300326
- 16x 242026
- 13x 306926
- 8x 243126
- 8x 416226
- 1x 4551360
- 1x 393826
- 1x 400626
- 1x 393726
- 1x 4539364
- 7x 4567340
- 6x 4567331
- 1x 4560573
- 1x 4560459

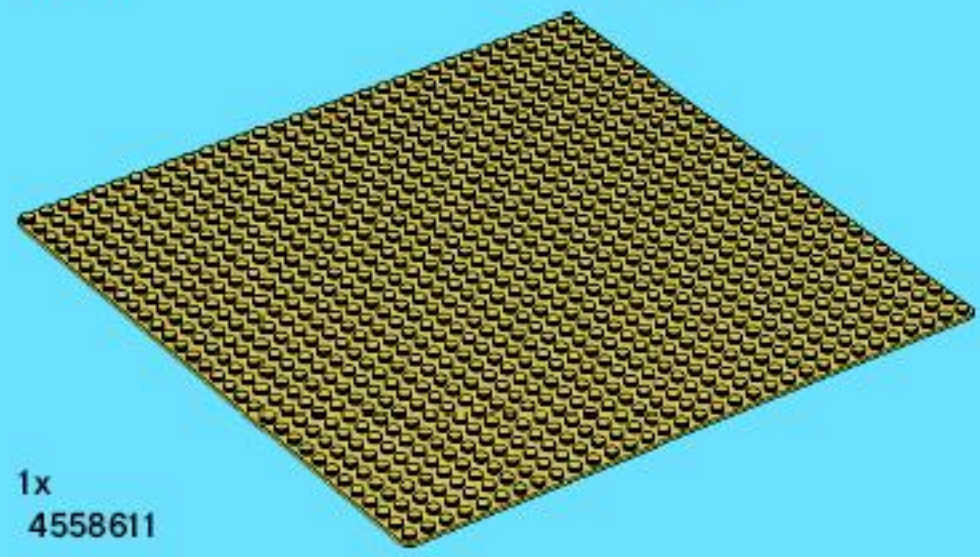

1x 4558611

 Customer Service  
 Kundenservice  
 Service Consommateurs  
 Servicio Al Consumidor  
[www.lego.com/service](http://www.lego.com/service) or dial  
 00800 5346 5555 :   
 1-800-422-5346 : 

FREE! GRATIS! GRATUIT!



club MAGAZINE™

www.LEGOclub.com



00800 5346 5555\*

1-866-534-6258 • 1-877-518-5346

US & Canada only

Canada seulement

VISIT THE WORLD'S BIGGEST LEGO® SHOP!

www.LEGOshop.com

\* FreePhone. Mobile charges may apply. \* Numéro sans Frais. Des Frais peuvent s'appliquer avec les téléphones cellulaires. \* Gebührenfrei. Kosten für Anrufe aus Mobilfunknetzen können abweichen. \* Gratís telefontelefonívonalról csak a hívás díja van. \* Het er ebt gratis nummer, når du ringer fra mobiltelefon. \* Det är gratis, när du ringer från en mobiltelefon.

# MINOTAURUS



3841 Minotaurus

2-4 7+ 20-30



3839 Race 3000  
(Course 3000)

2-4 7+ 20-30



3840 Pirate Code  
(Code Pirate)

2-4 8+ 15-25

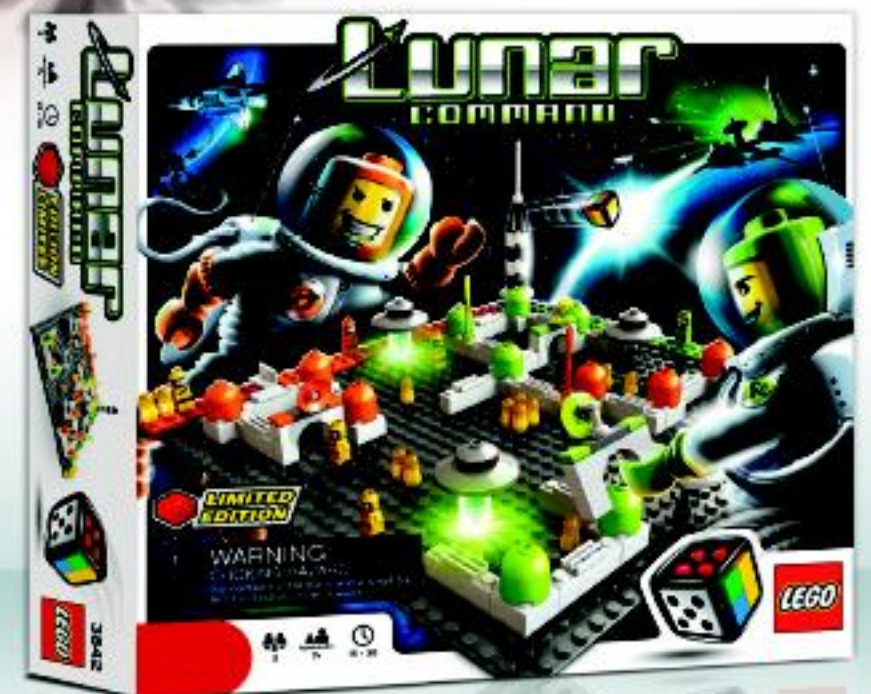

3842 Lunar Command  
(La fusée lunaire)

2 7+ 15-30



3835 Robo Champ  
(Le champion des robots)

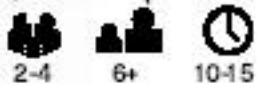

3836 Magikus



3837 Monster 4  
(Monstre 4)



3838 Lava Dragon  
(Le dragon de lave)



3843 Ramses Pyramid  
(La pyramide Ramsès)

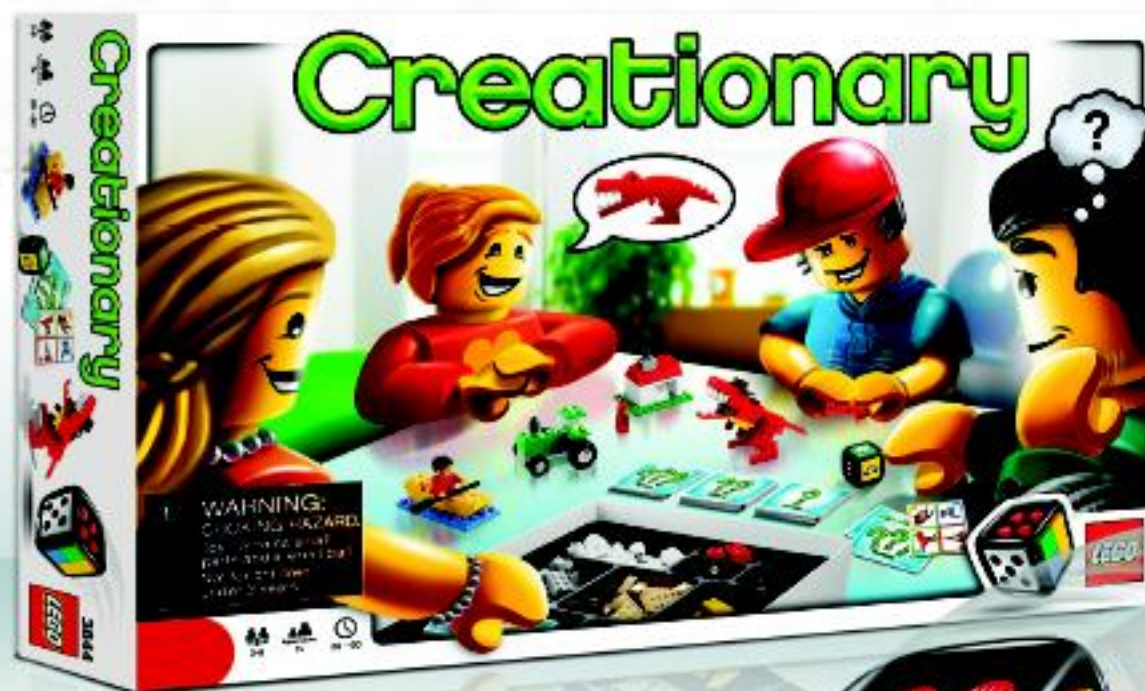

3844 Creationary





# WIN!

Go to [www.nielsen.com/LEGO](http://www.nielsen.com/LEGO)  
to fill out a survey for a chance  
to win a cool LEGO® Product.  
No purchase necessary.  
Open to all residents where not prohibited.



## [www.nielsen.com/LEGO](http://www.nielsen.com/LEGO)

### GEWINNE! WIN!

Nimm an der Umfrage auf [www.nielsen.com/LEGO](http://www.nielsen.com/LEGO) teil und hab die Chance ein cooles LEGO® Produkt zu gewinnen!

Die Teilnahme am Gewinnspiel führt zu keinerlei Kaufverpflichtungen. Teilnahme in allen nicht ausgeschlossenen Ländern möglich.

Ga naar [www.nielsen.com/LEGO](http://www.nielsen.com/LEGO), vul een enquêteformulier in en maak kans op een cool LEGO® product.

Geen aankoopverplichting. Iedereen mag deelnemen, uitgezonderd ingezetenden van landen waar een enquêteverbod geldt.

### GAGNE! 当てよう!

Visite [www.nielsen.com/LEGO](http://www.nielsen.com/LEGO) pour répondre à un questionnaire et avoir une chance de gagner un produit LEGO® très cool!

Aucune obligation d'achat. Ouvert à tous les résidents des pays autorisés.

[www.nielsen.com/LEGO](http://www.nielsen.com/LEGO)にアクセスして、アンケートにご記入ください。当選者にはレゴ製品を差し上げます。

お買い上げの必要はありません。

禁止されていない限り、すべての国域にご利用いただけます。