

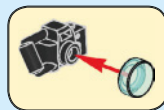

40345

6289792

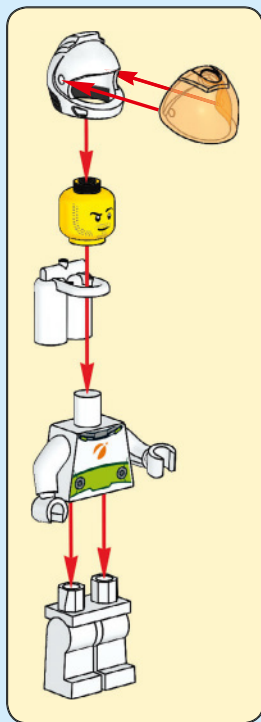

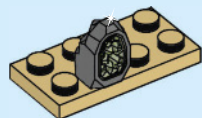
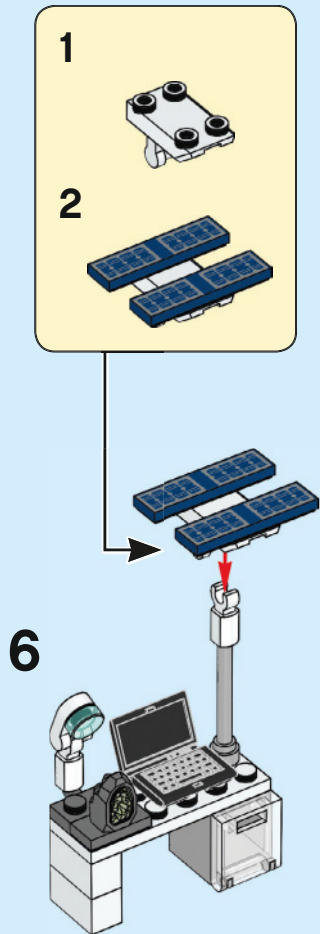
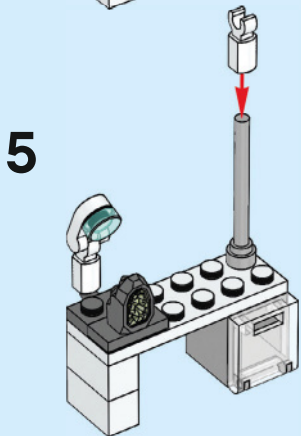
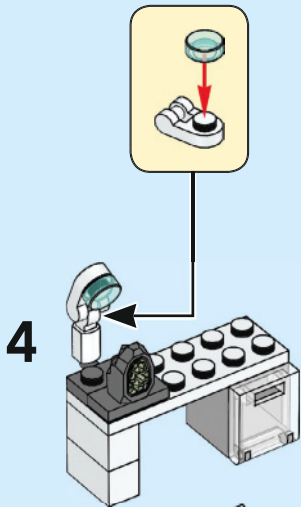
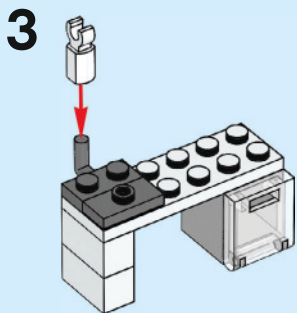
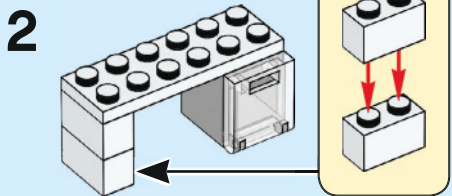
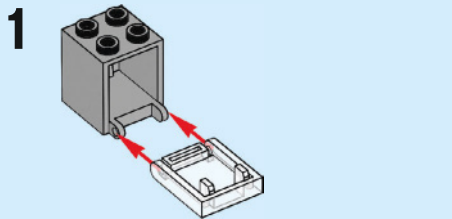

LEGO and the LEGO logo are trademarks of the/son/ des marques de commerce du/son marcas registradas de LEGO Group. ©2019 The LEGO Group. 6289792

LEGO.com/service

LEGO.com/city