



BRICK 'HEADZ

40495



Harry Potter

WIZARDING
WORLD

 [LEGO.com/brickheadz](https://www.lego.com/brickheadz)

HARRY POTTER™

139

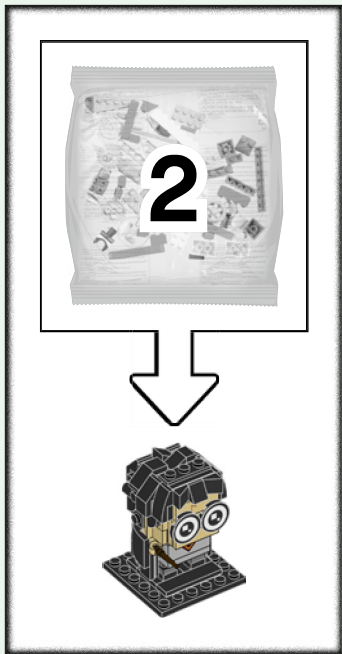

2

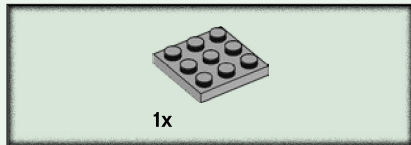

1



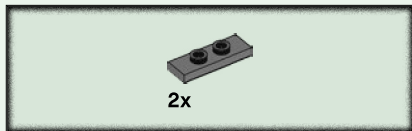

2

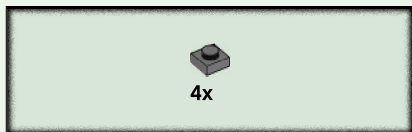
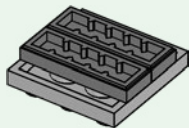

3

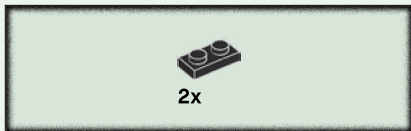
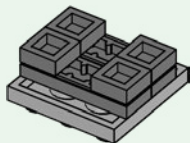

4

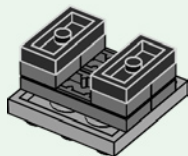

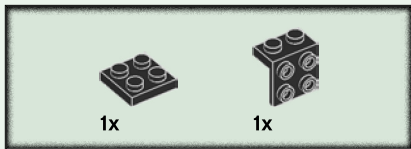

5

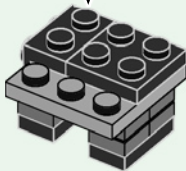
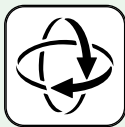
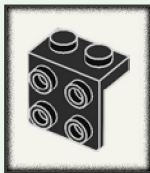

4

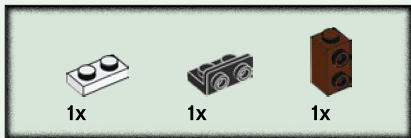

6

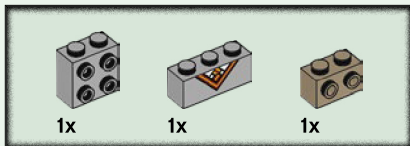
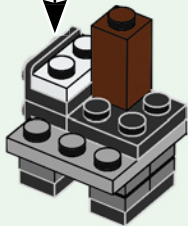
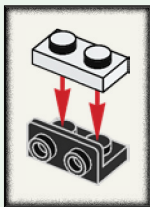

7

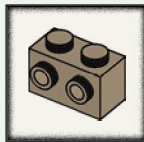

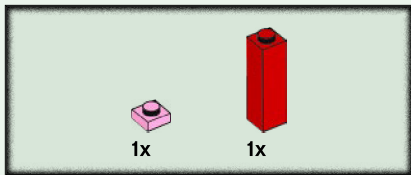

8

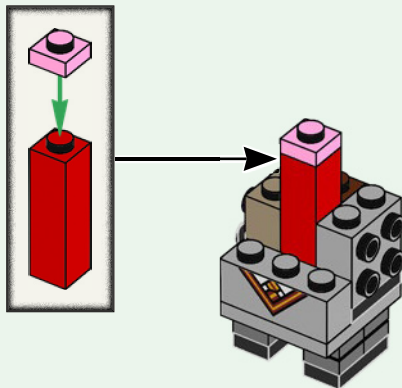

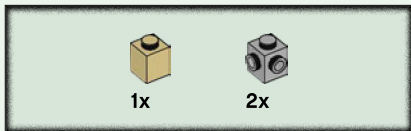

9

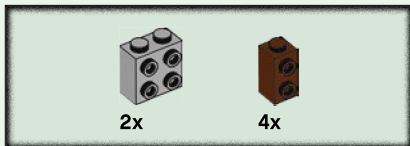
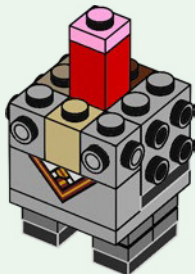

10

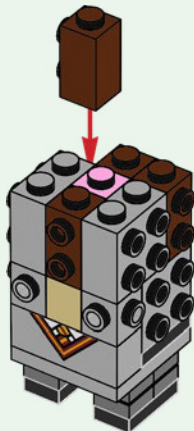

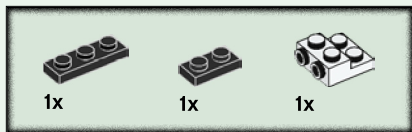

11





12

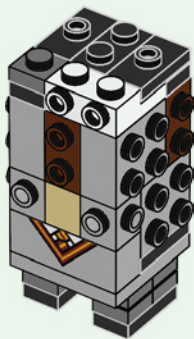

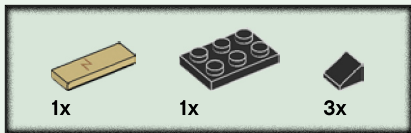

13

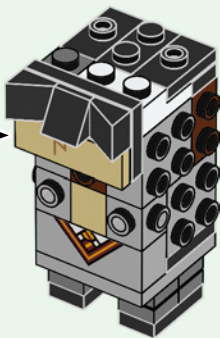
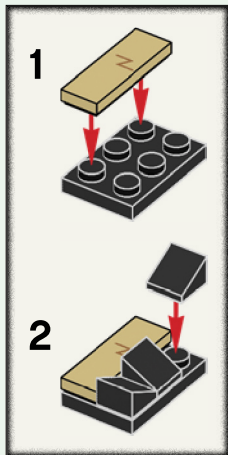

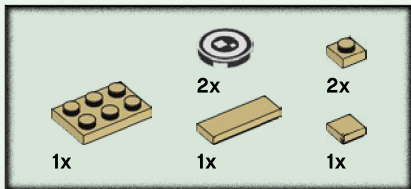

14

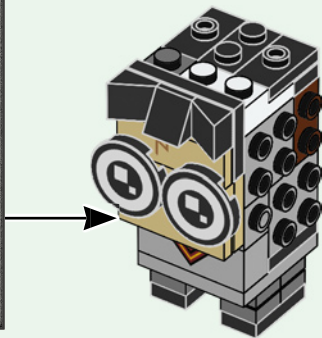
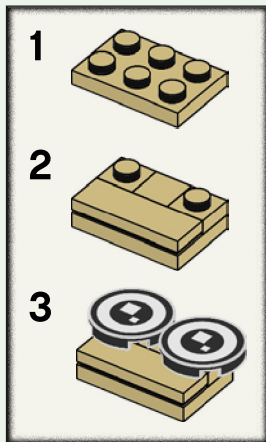



2x

15

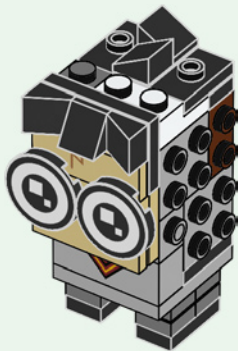

12



2x

16

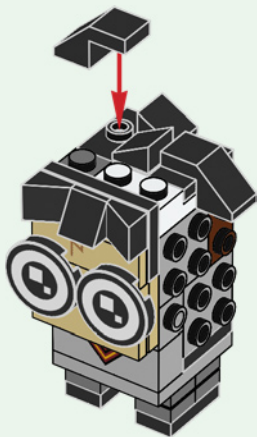

1x

17

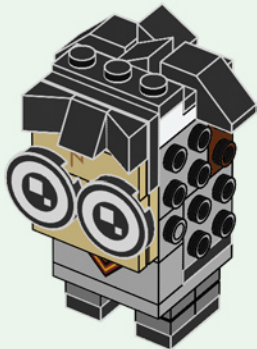

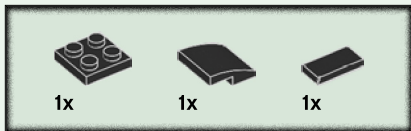

18

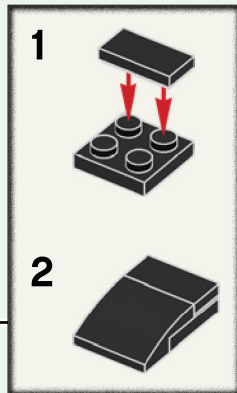
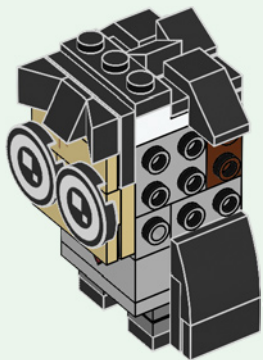

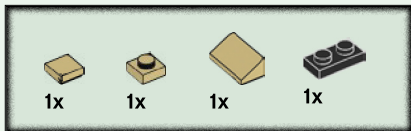

19

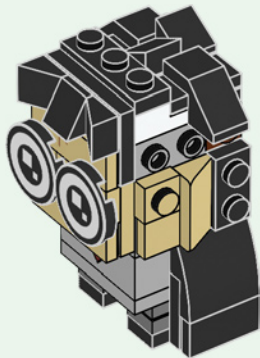



20

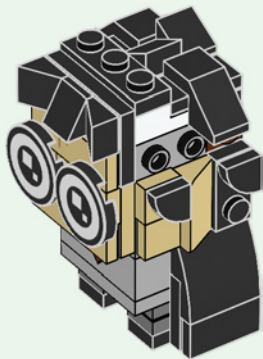

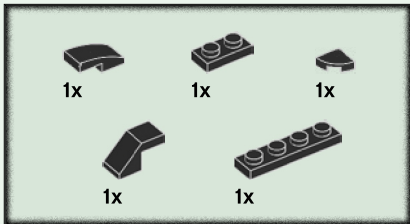

21

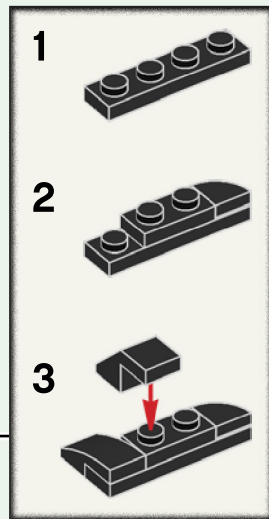
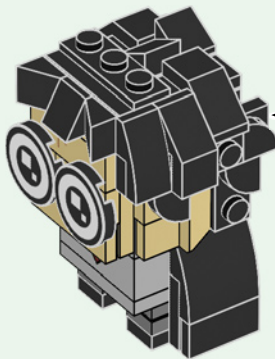

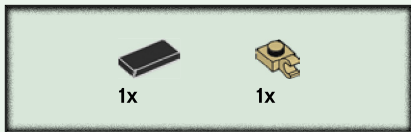

22

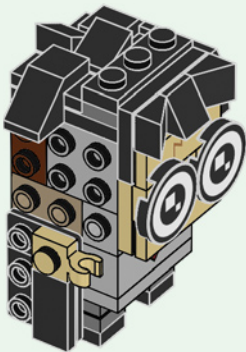
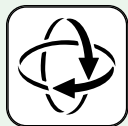



23

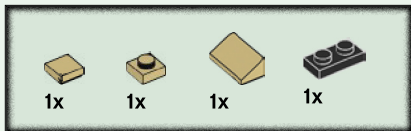
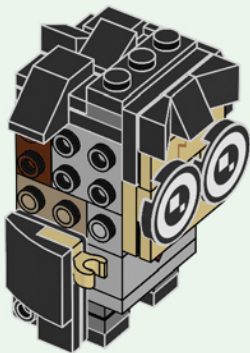

24

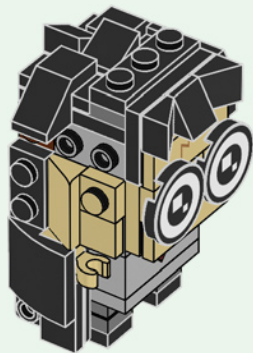



2x

25

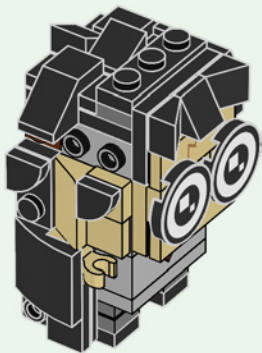

20

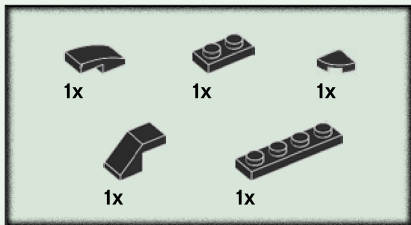

26

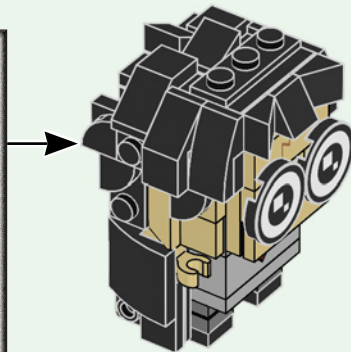
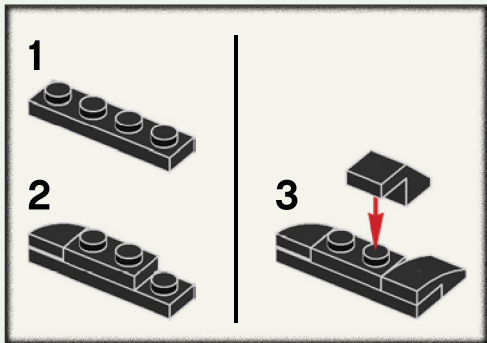

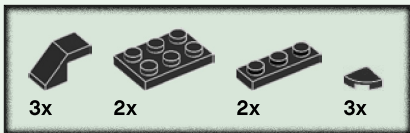

27

1

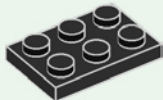

2

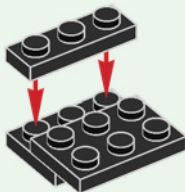

3

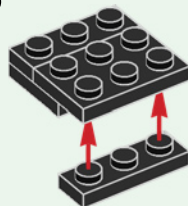

4

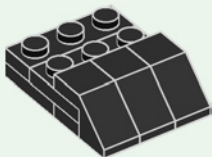

5

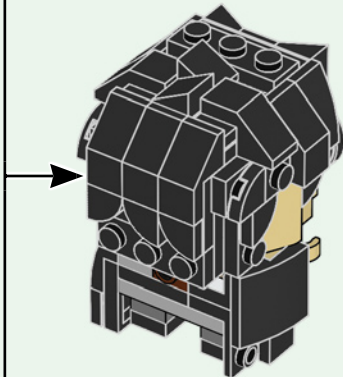
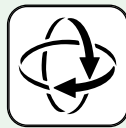
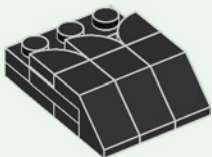

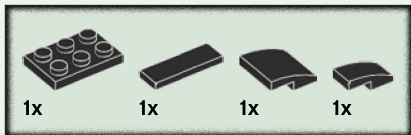

28

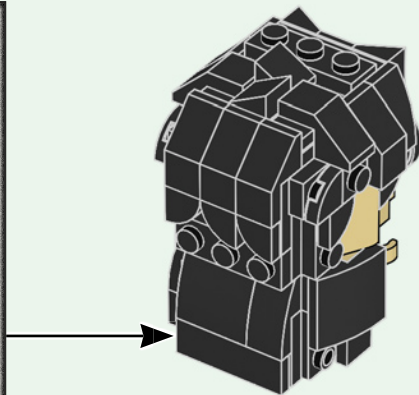
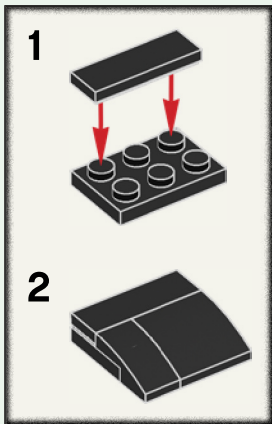

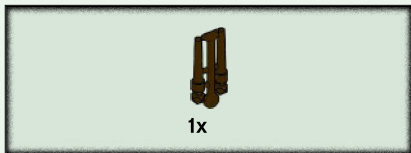

29

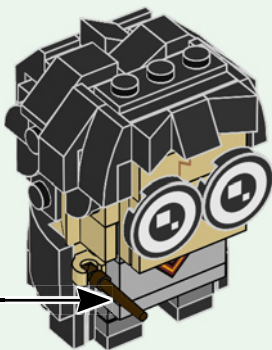

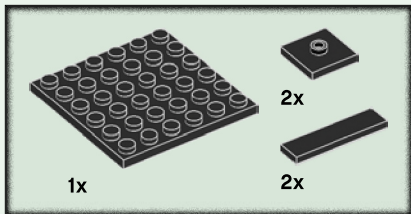

30

1

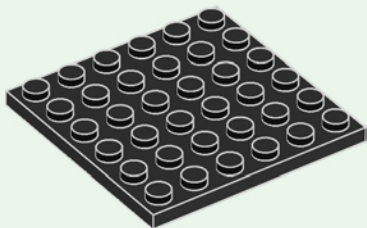

26

2

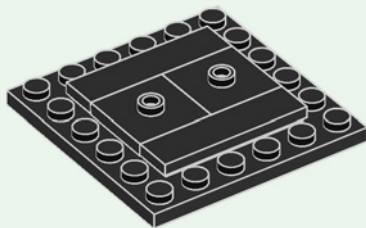

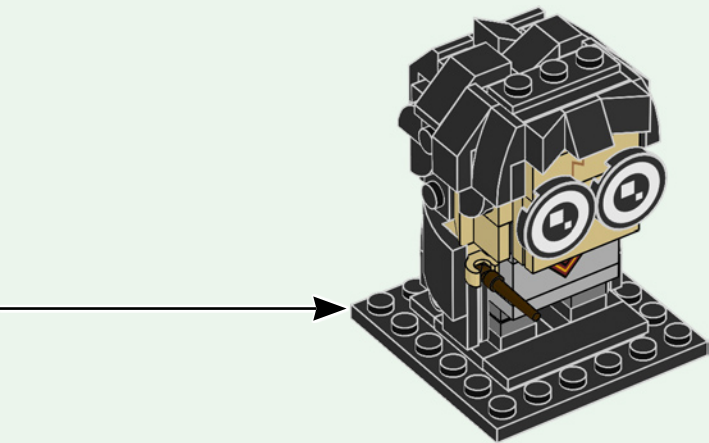



Harry Potter



Build & Swap
 Construis et interchange
 Construye y cambia



76389 +



76386 +



76387

LEGO and the LEGO logo are trademarks of the/son
 des marques de commerce du/son marcas registradas
 de LEGO Group. ©2021 The LEGO Group. 6373326

WIZARDING WORLD characters, names
 and related indicia are © & ™ Warner
 Bros. Entertainment Inc. WB SHIELD:
 © & ™ WBEI. Publishing Rights © JKR. (s21)



Each set sold separately and available for
 different periods of time.
 Les ensembles sont vendus séparément et à
 des périodes différentes.
 Cada set se vende por separado y está
 disponible durante un cierto período de tiempo.