



MYTHICA™



LEGOLAND®

40556



Booklet available in English on
Heft in deutscher Sprache erhältlich auf
Livret disponible en français sur
Libretto disponibile in Italiano su
Folleto disponible en español en
如需中文版手册, 请访问

 LEGOLAND.com

LEGO.com/service/buildinginstructions



MYTHICA™

WELCOME TO LEGO® MYTHICA

For the first time ever, the portal to LEGO® MYTHICA has opened!

And you're about to discover a land full of wonderful creatures and epic adventure. LEGO MYTHICA is five realms in one world, each bursting with colour and characters you've never seen before.

LEGO MYTHICA can only exist and thrive as long as children keep creating. Children's imaginations are the life force of this previously undiscovered world. Every time a child builds a new LEGO creature, it comes to life in LEGO MYTHICA and helps to keep this magical world in balance.

But there's a problem and LEGO MYTHICA needs your help!



HELP SAVE LEGO® MYTHICA

Now the Guardians of LEGO® MYTHICA have opened the portal – they need your help! Never before have they allowed humankind access to their precious home. But never has LEGO MYTHICA been in such peril.

Their world is withering, realms are slowly dying and creatures are behaving strangely. There's not enough creativity flowing into their world to keep LEGO MYTHICA alive. That's why the Guardians are asking children like you to build new creatures, reignite their imaginative powers and breathe new life into LEGO MYTHICA.

Are you ready to get creative, start building and become a LEGO MYTHICA HERO?



Meet the Characters



Maximus

Maximus is strong and majestic and can always make others feel brave in the face of danger. He looks after everyone in LEGO® MYTHICA and wants to encourage children to rediscover the joy of creating with LEGO bricks... He is also on a mission to find Bobs' missing wing so that Bobs can fly just as high as him!



Bobs

Bobs is a curious creature who loves to shoot rainbows out of his horn, spread happiness and joy. He also loves to fly, but with only one wing that can be a bit tricky!



Explorers

Meet the brave explorers who are on a quest to save the incredible land of MYTHICA. They will need to use all their creativity to breathe new life into LEGO MYTHICA, and you can help them!

Build a portal, join the explorers, help Maximus find Bobs' missing wing and keep building to save LEGO MYTHICA. But, oh no, watch out for the snapping flytraps and creepy crawly creatures in the Magical Forest!







LEGO.com/sustainable-packaging



 ^{FR} **DONNEZ**
OU
RECYCLEZ

 OU  OU 

ASSOCIATION MAGASIN DÉCHÈTERIE

Adresses sur quefairedemesdechets.fr

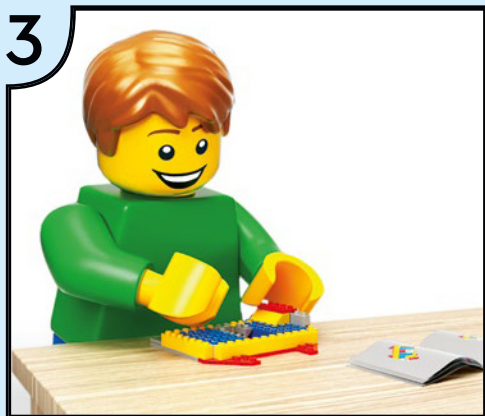

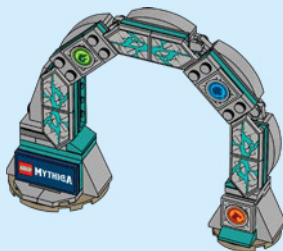
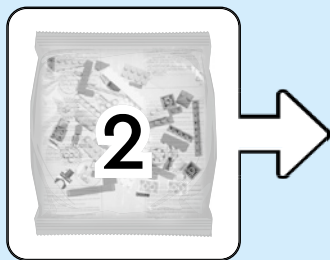
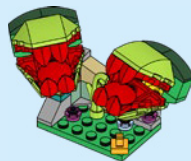

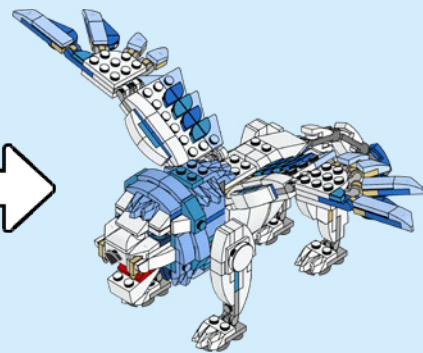
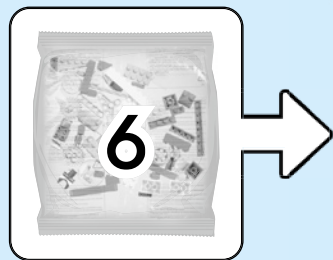
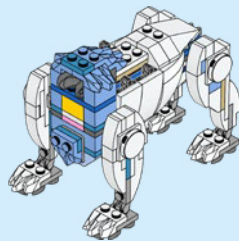
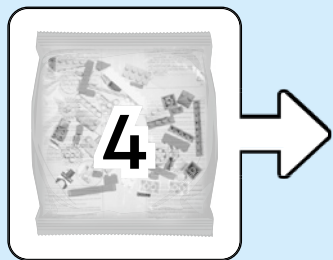
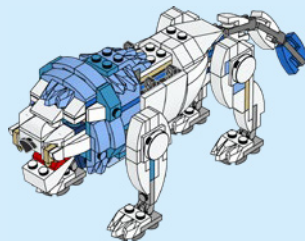
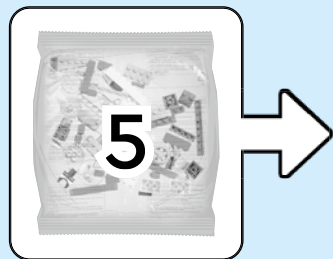
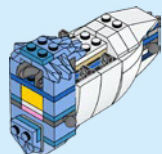

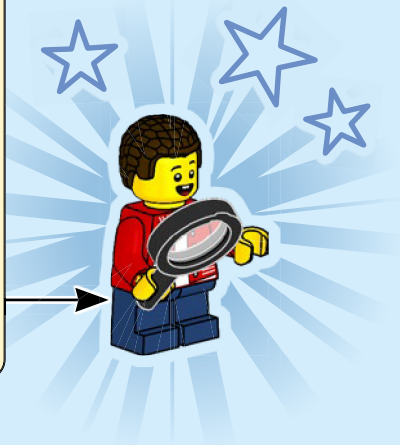
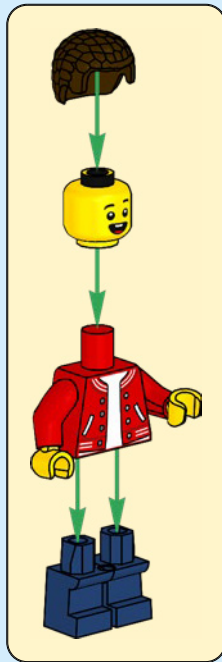

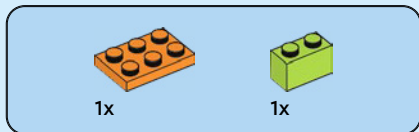

1

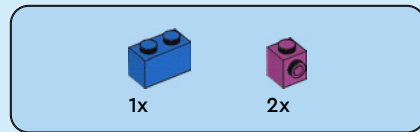
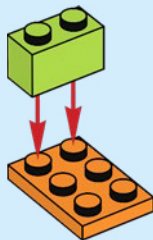

2

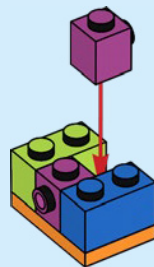



3x



1x

3

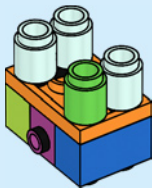

1x



1x

4

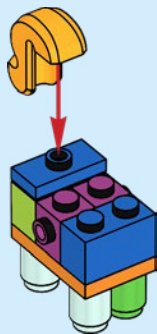

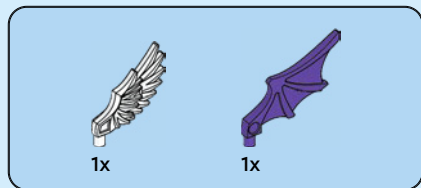

5

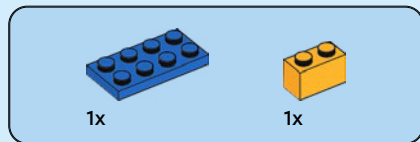

6

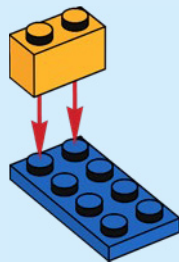



2x



1x

7

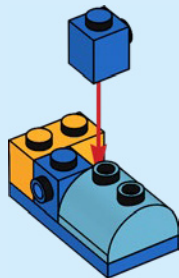

2x

8

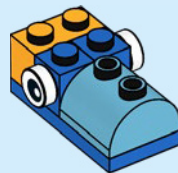



1x



1x

9

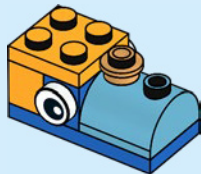

1x



1x

10





1x

11

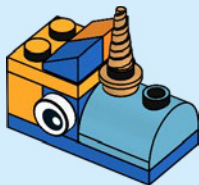

12



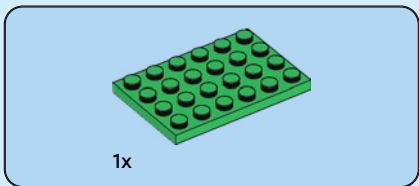
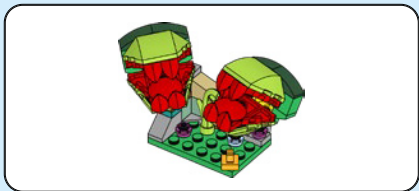

1x

1

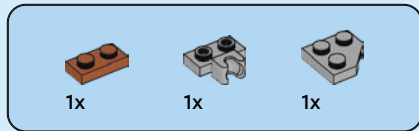
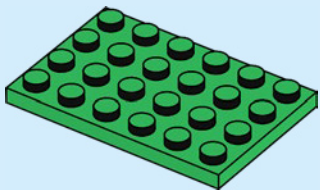

2

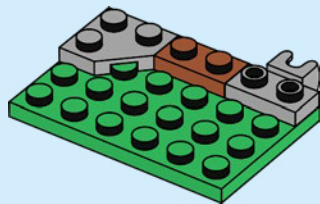



2x



2x

3

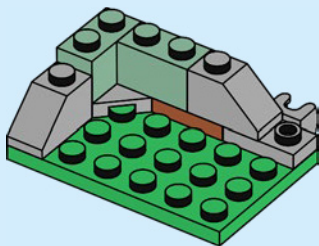

2x



1x



1x



1x

4

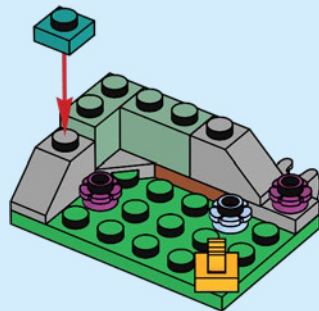

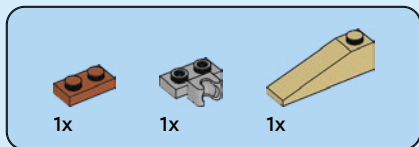

5

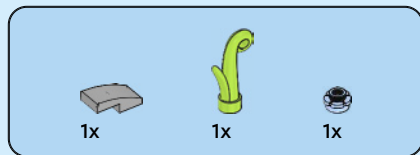
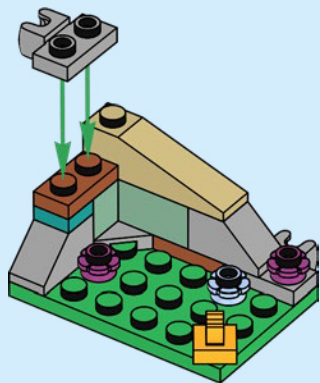

6

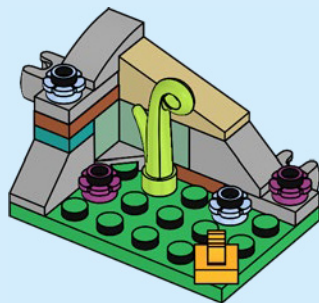

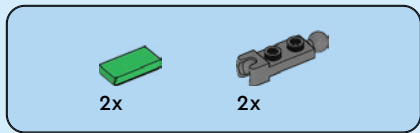

7

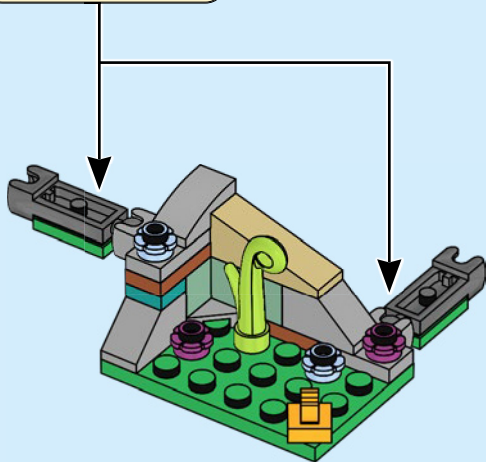
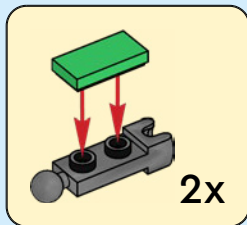



2x



1x



1x



1x

8

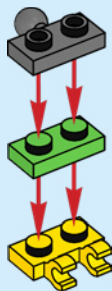

1x



1x

9

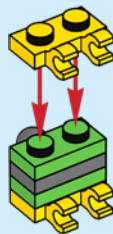



2x



2x

10

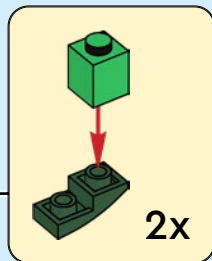
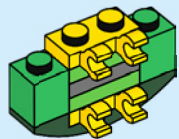

1x

11

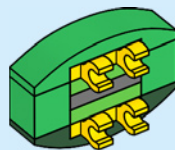

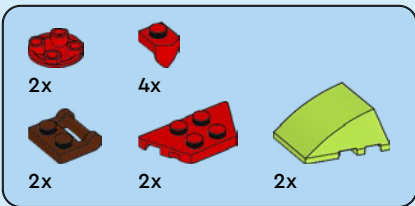

12

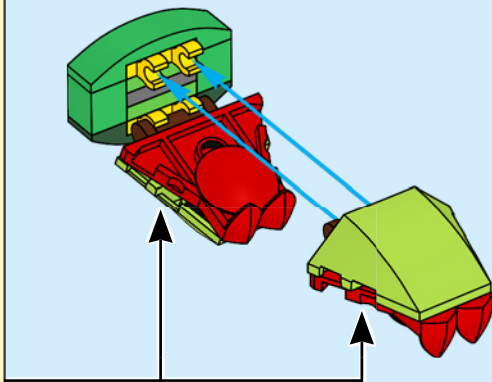
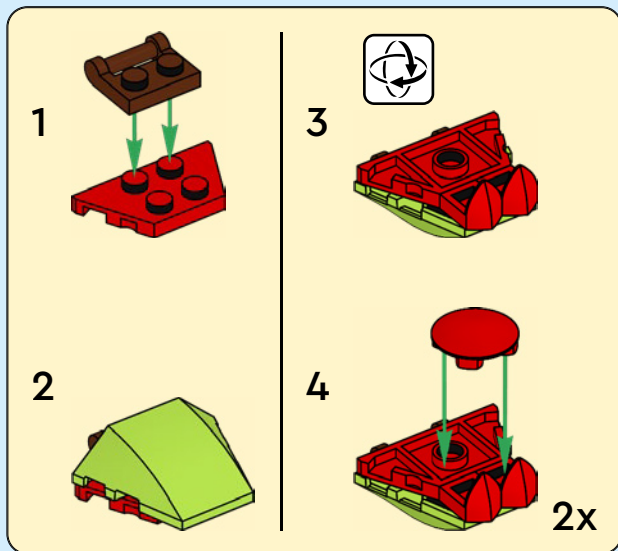

2x

13

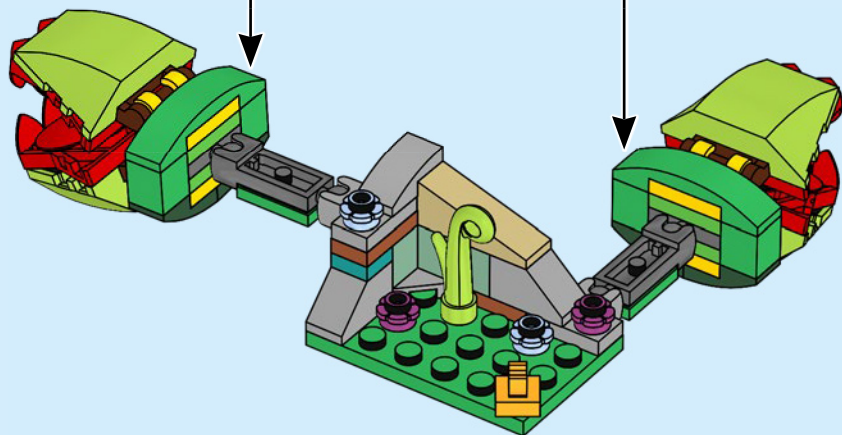

14

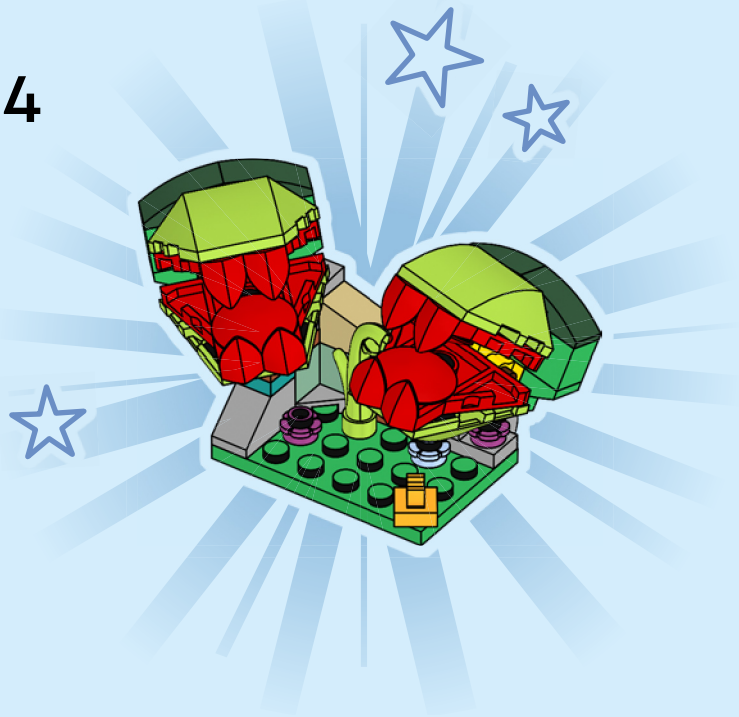

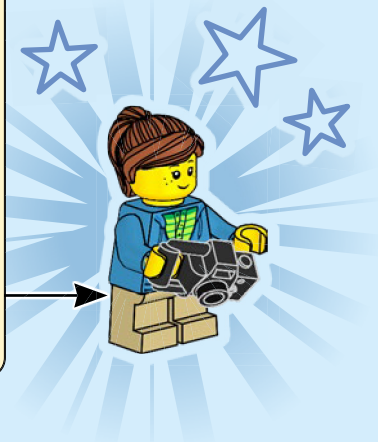
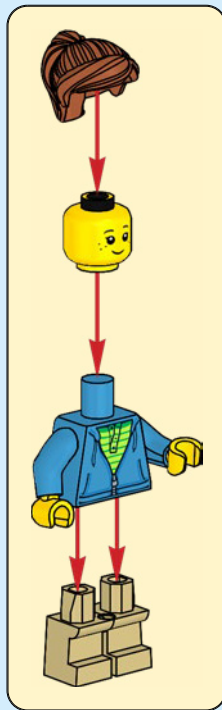

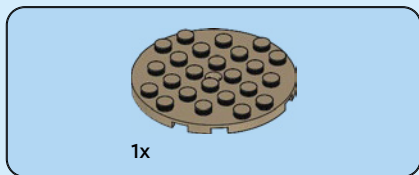
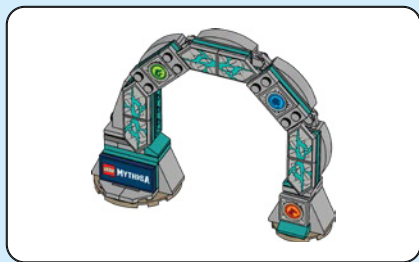

1

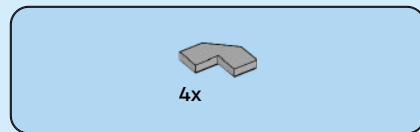
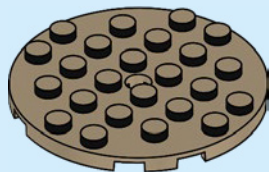

2

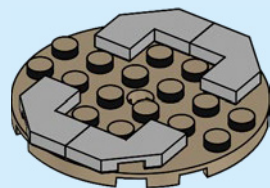

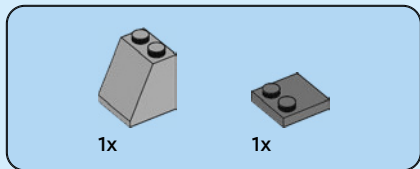

3

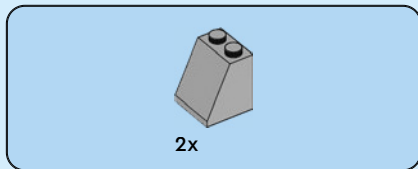
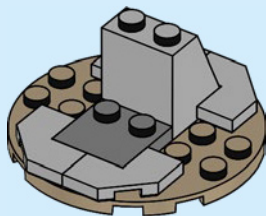

4

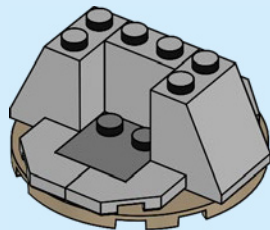



1x

5

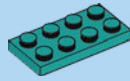
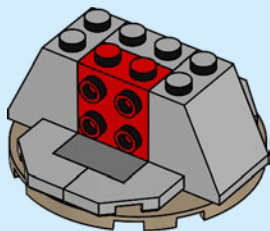

1x

6

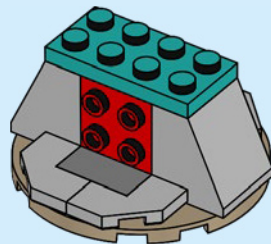

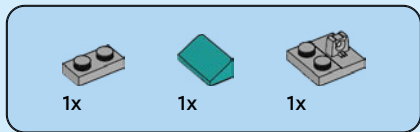

7

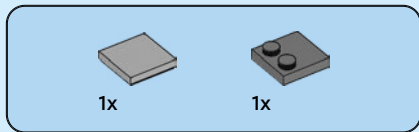
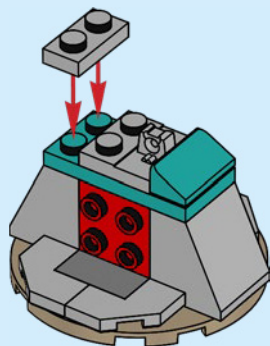

8

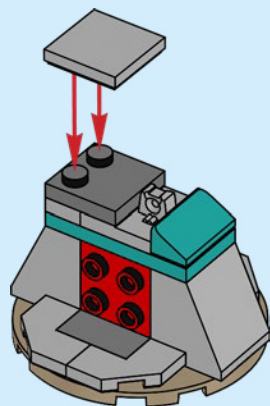

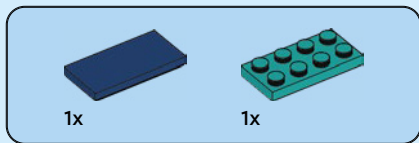

9

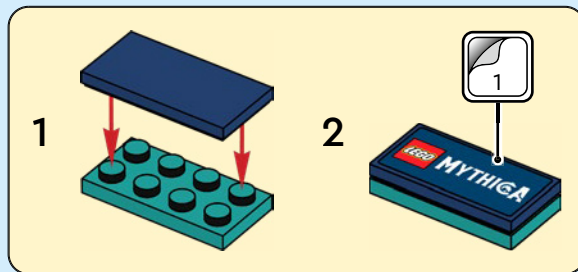

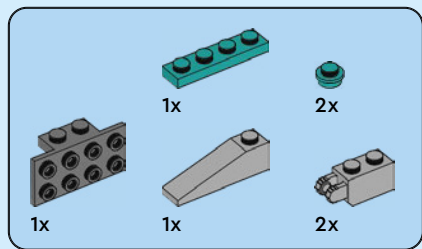

10

1

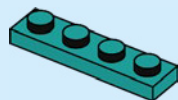

2

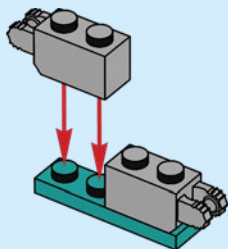

3

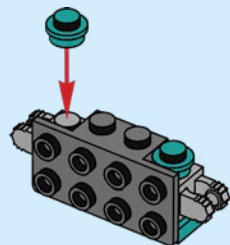

4

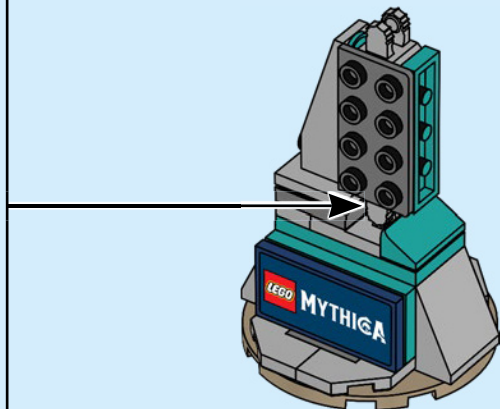
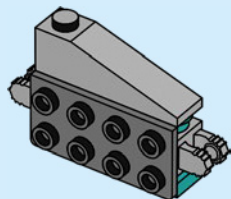

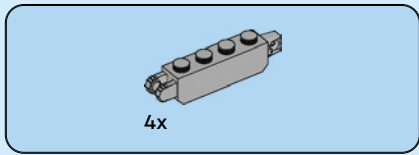
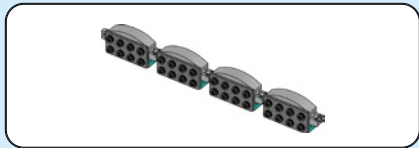

11

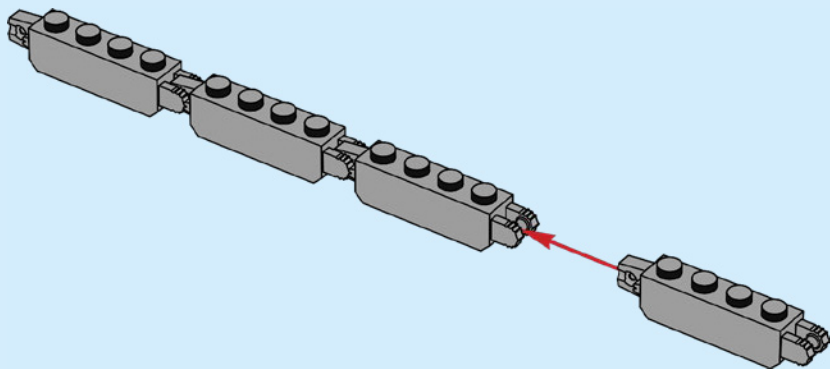

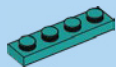

4x

12

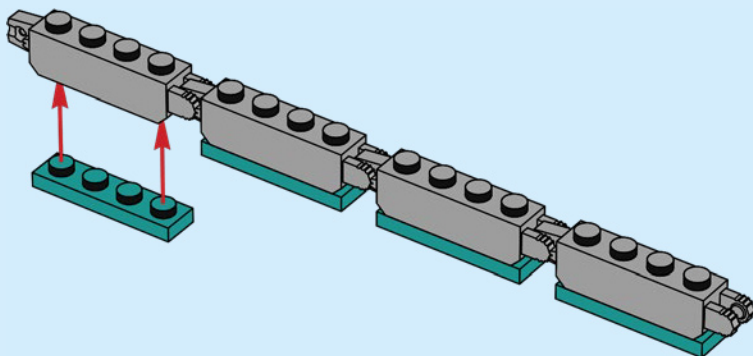

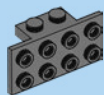

4x

13

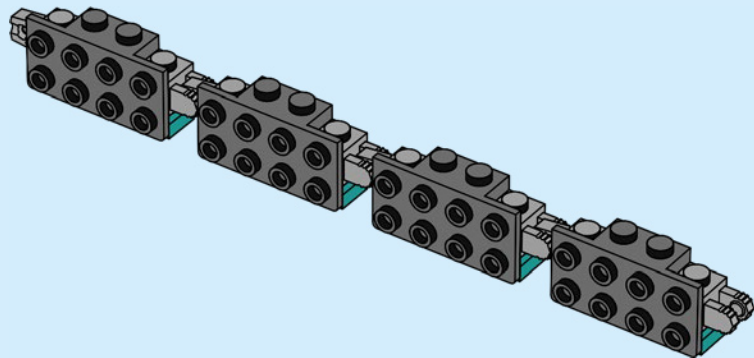



4x

14

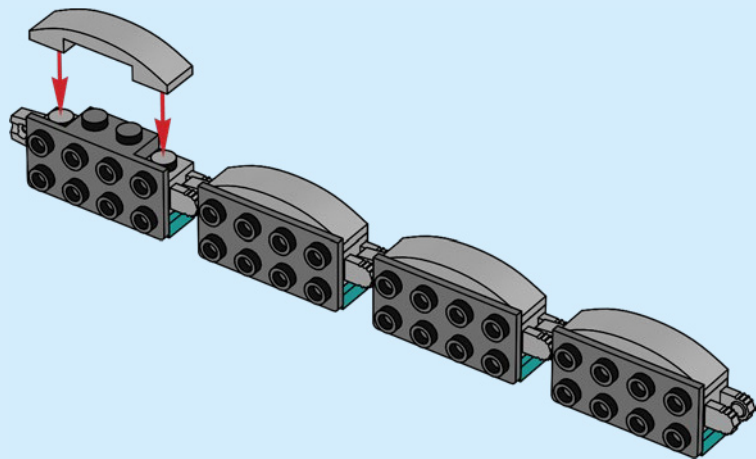

15

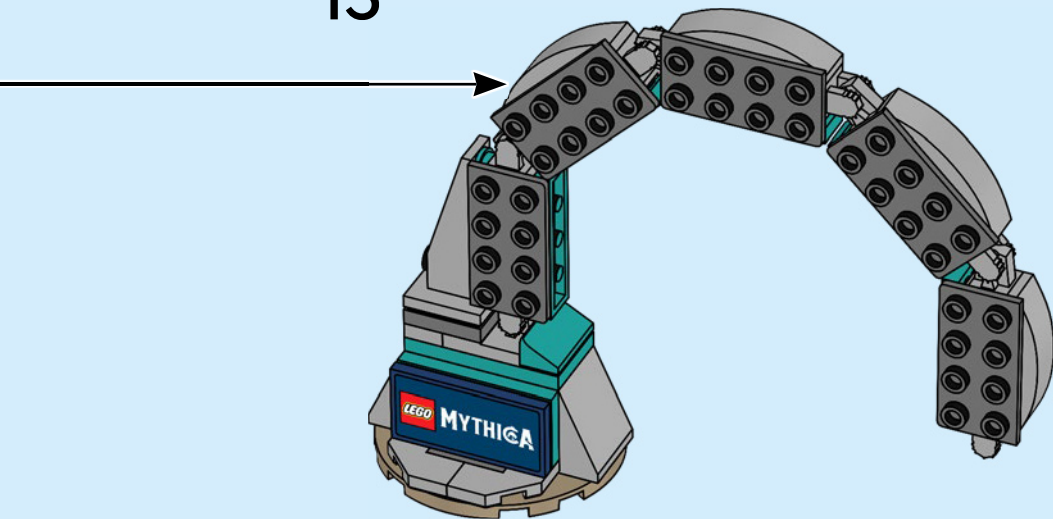



1x

16



2x

17

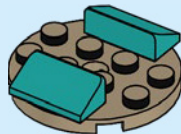



2x

18

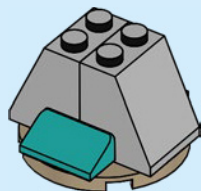

1x



1x

19

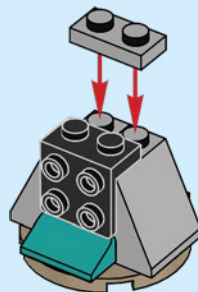



1x



1x

20

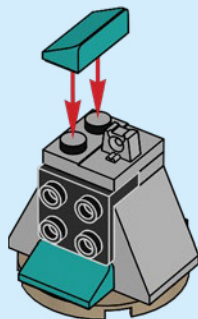

1x

21

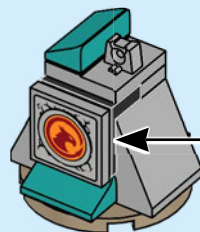
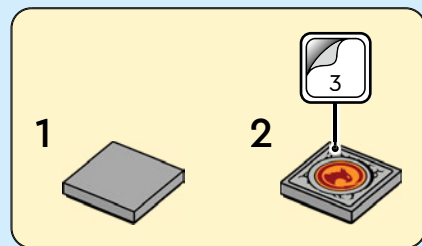

22

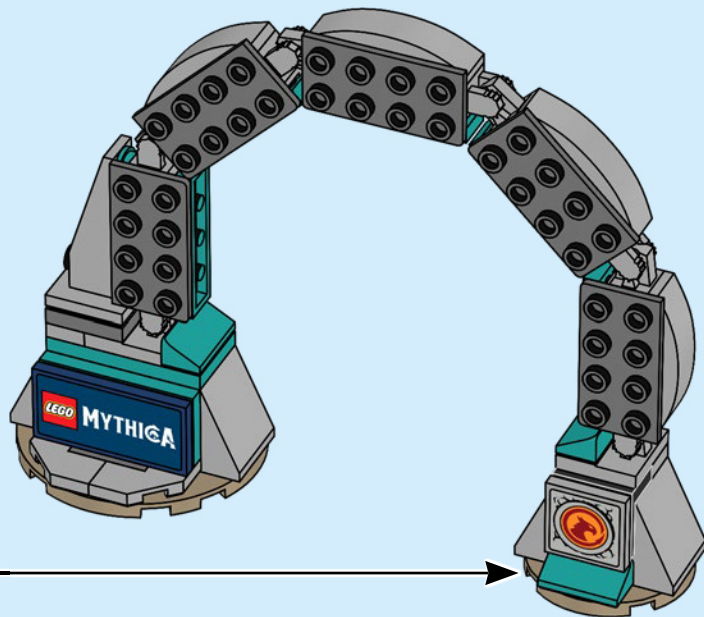

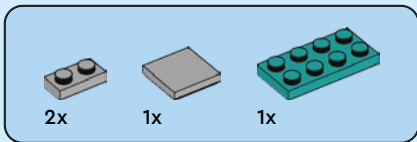

23

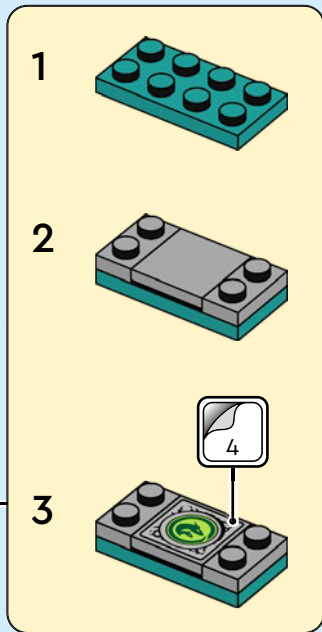
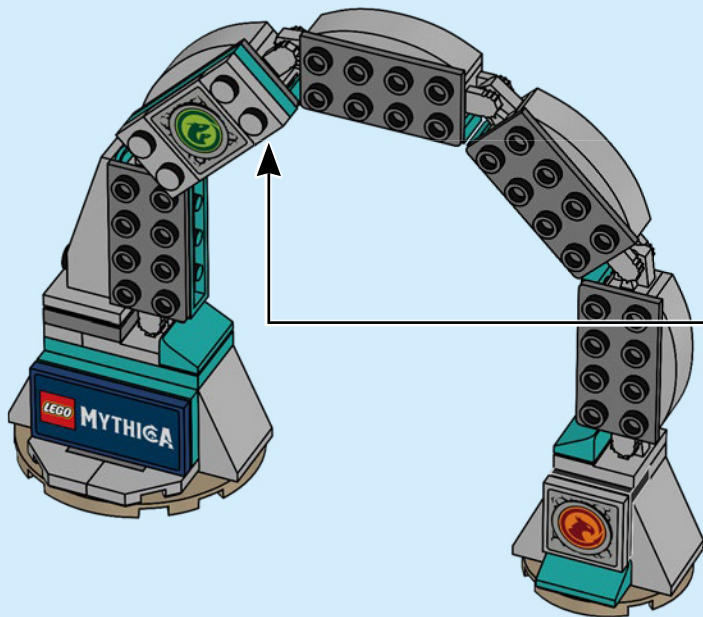

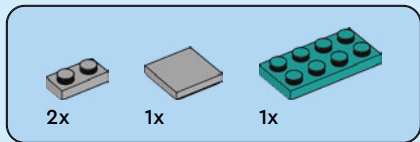

24

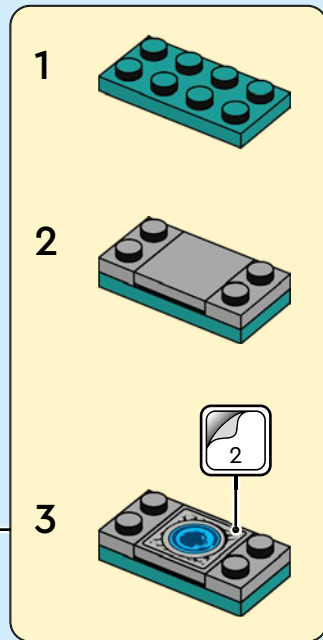
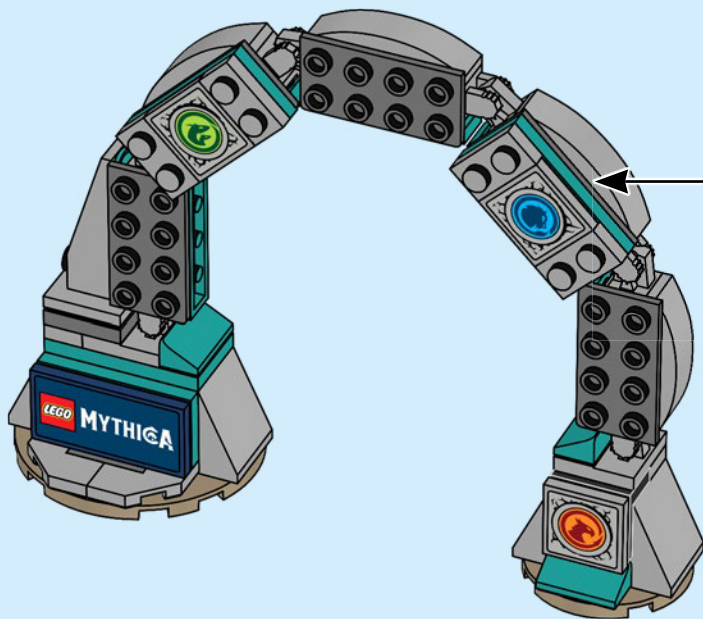

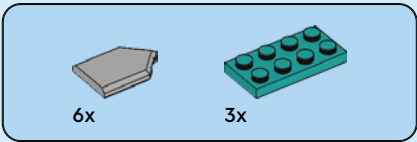

25

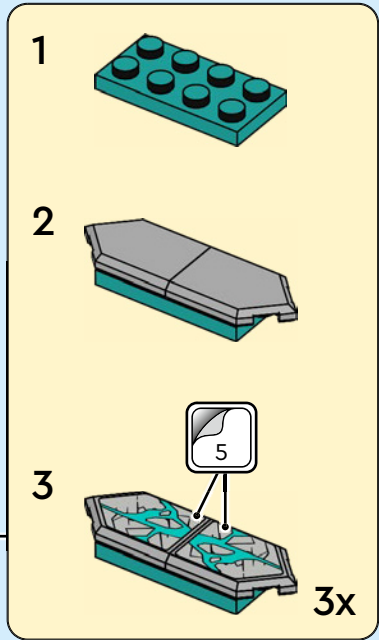
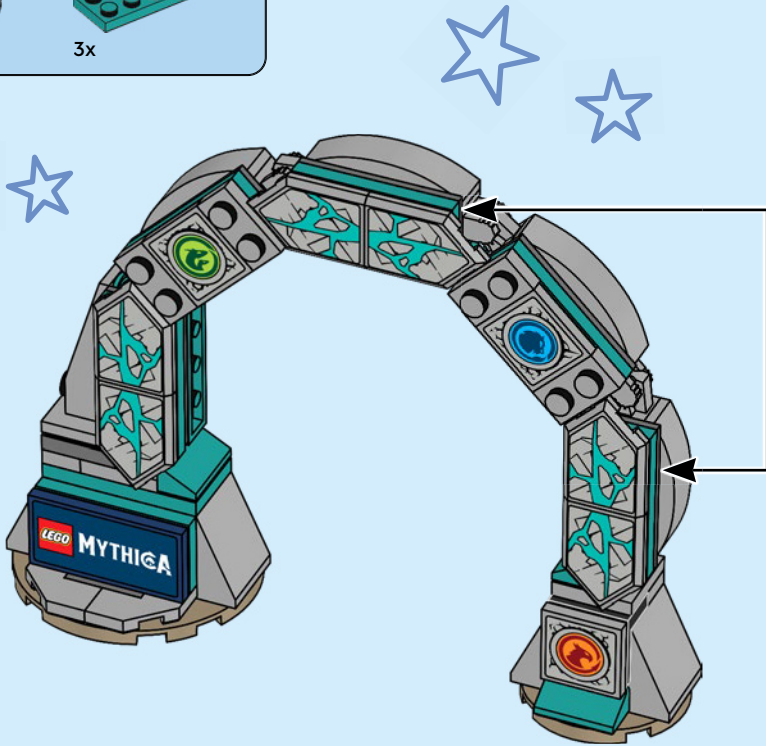



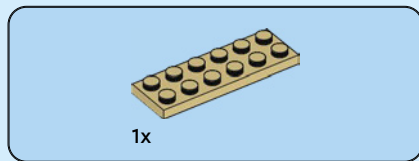
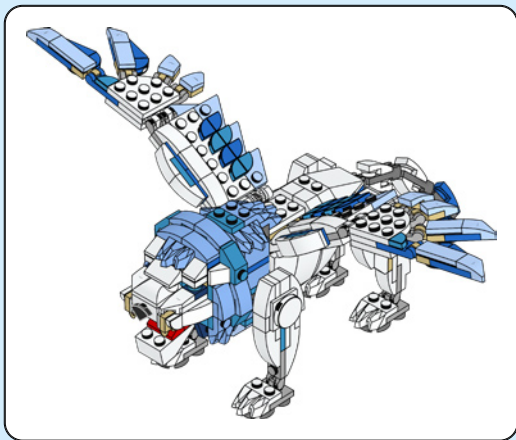

1

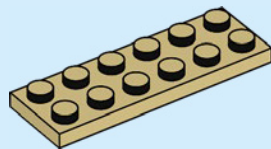

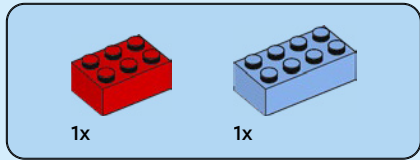

2

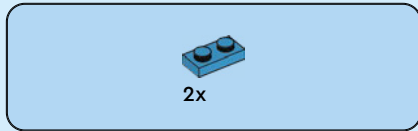
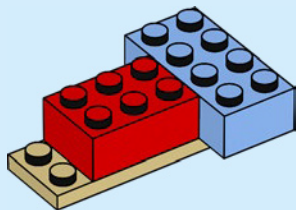

3

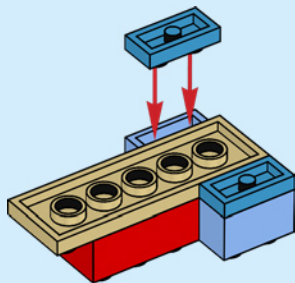

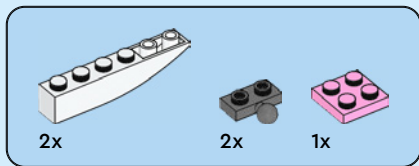

4

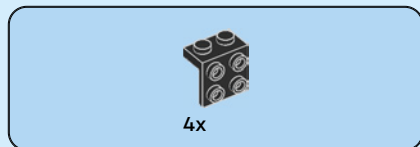
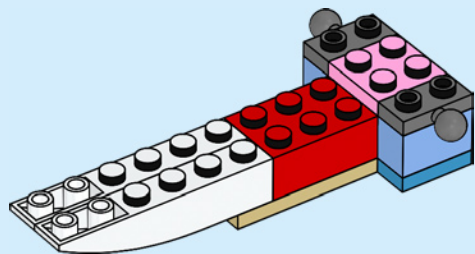

5

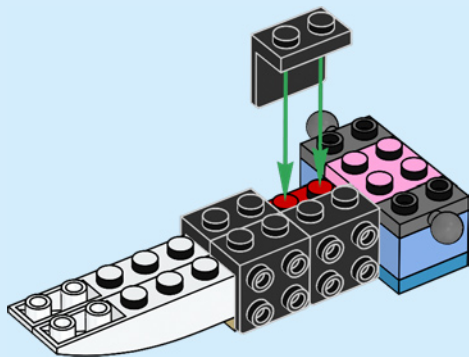

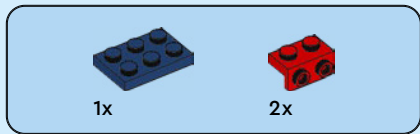

6

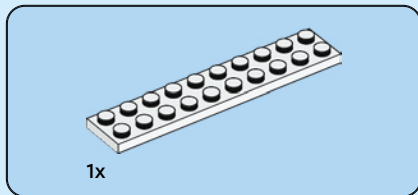
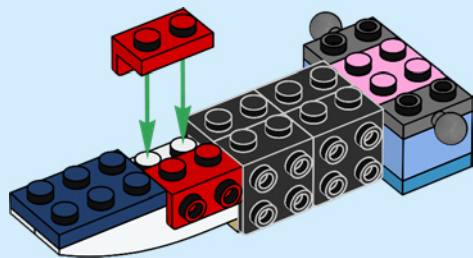

7

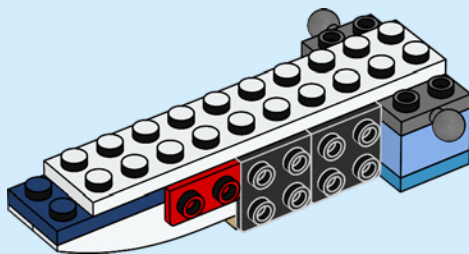

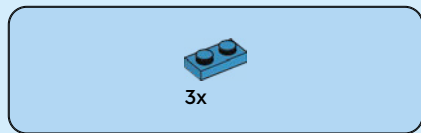

8

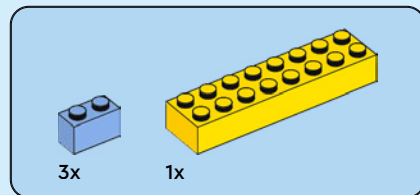
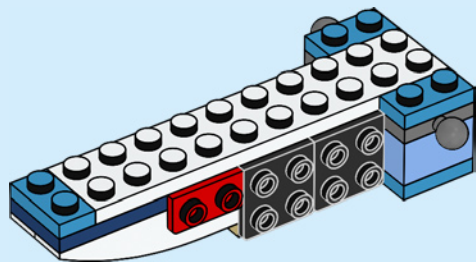

9

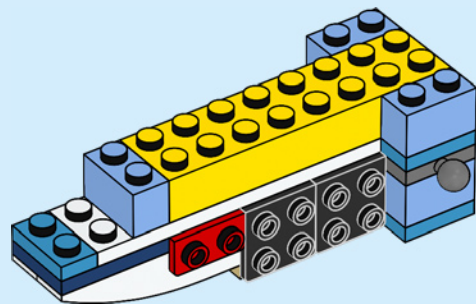

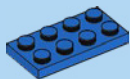

1x

10

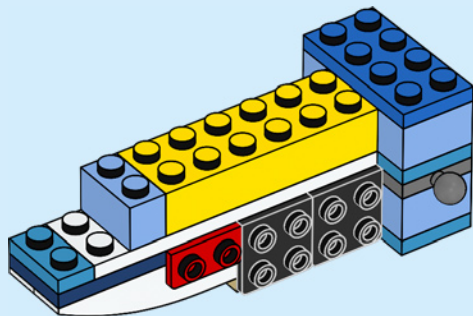

6x



2x

11

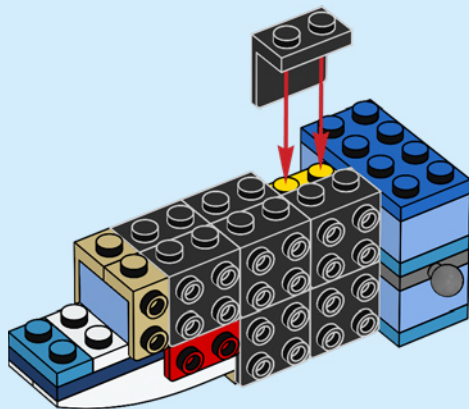

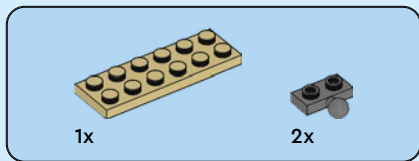

12

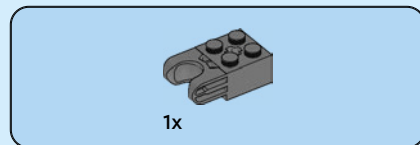
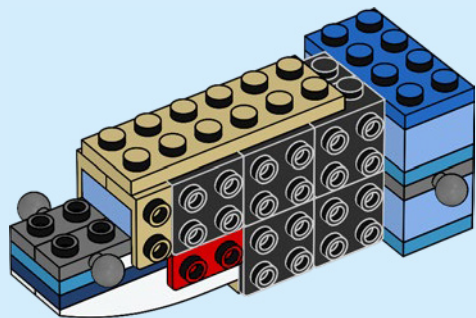

13

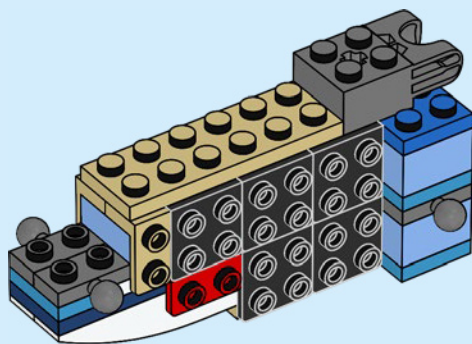

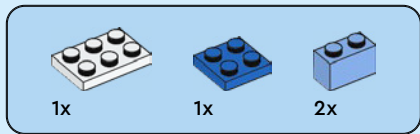

14

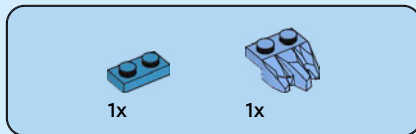
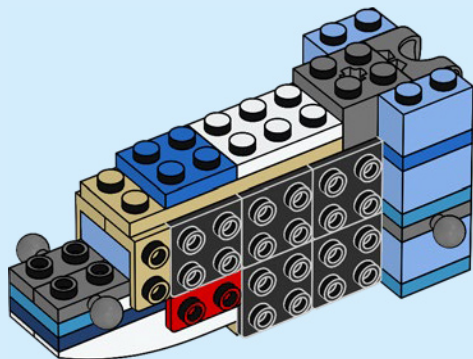

15

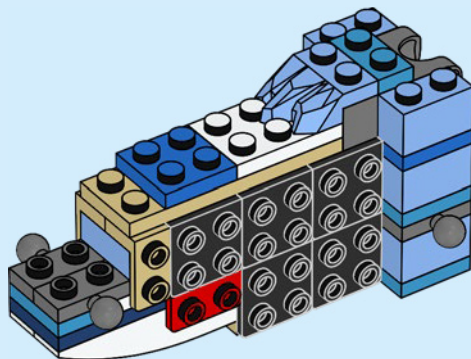



2x

16

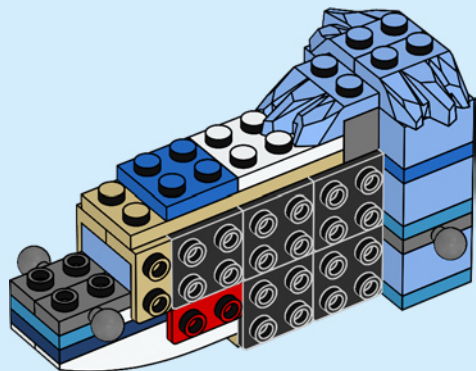

1x



1x

17

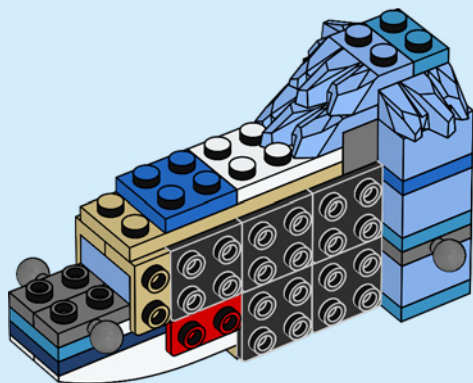

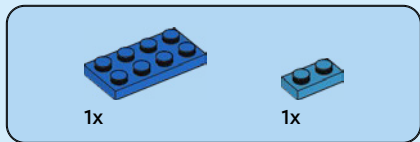

18

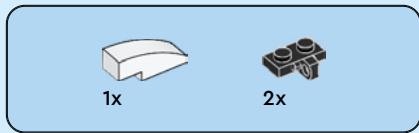
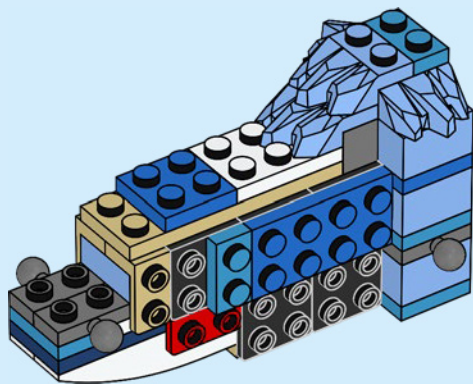

19

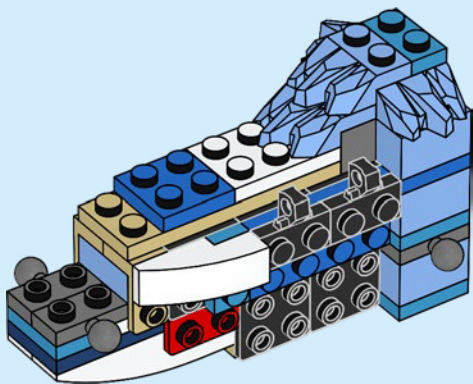



2x

20

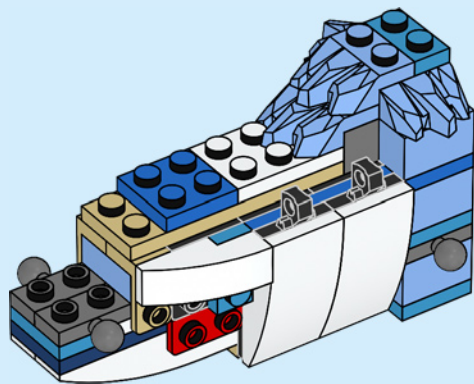

1x

21

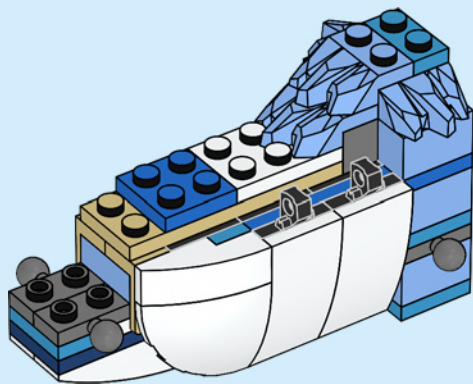

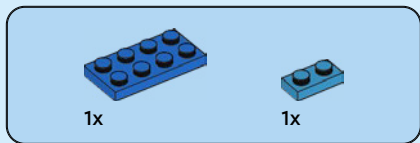

22

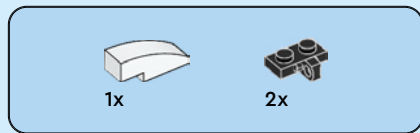
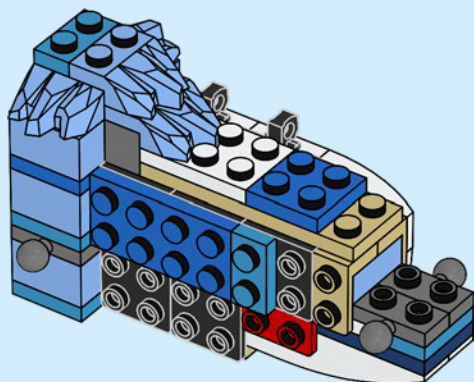

23

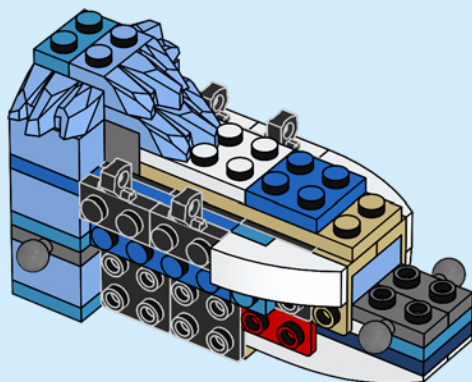



2x

24

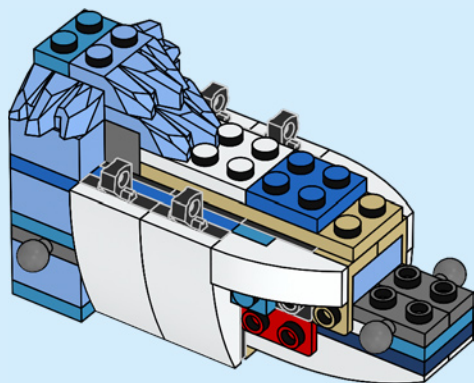

1x

25

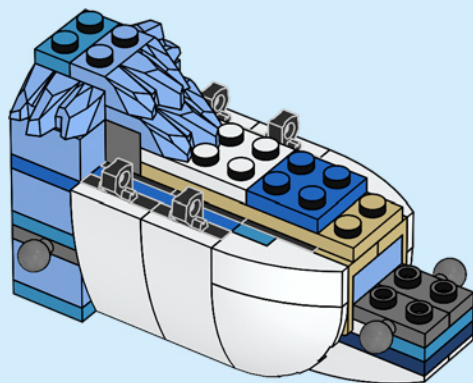

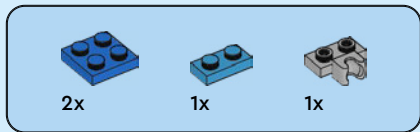

26

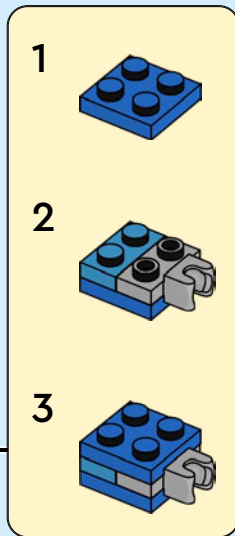
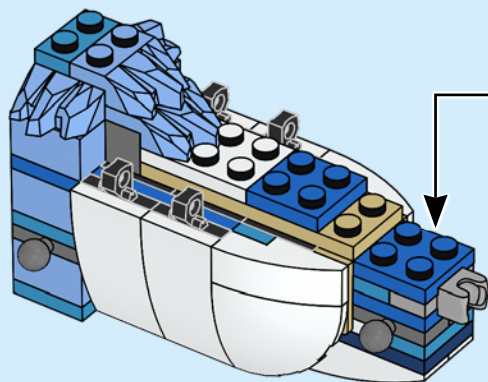

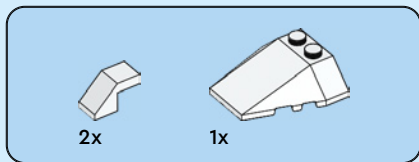

27

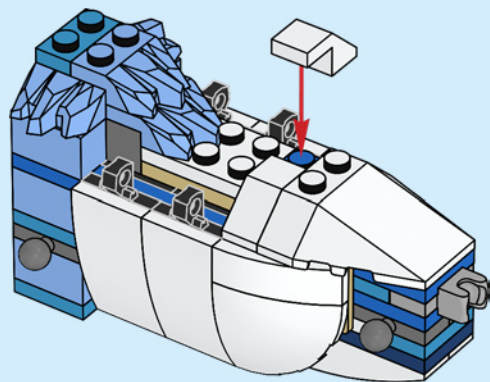

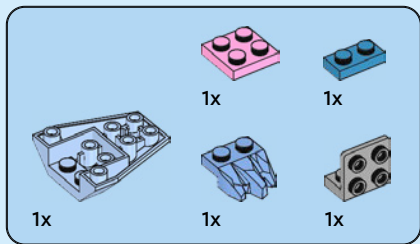

28

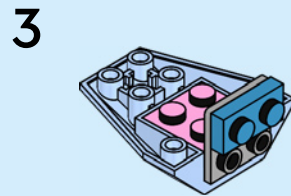
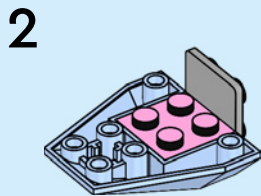
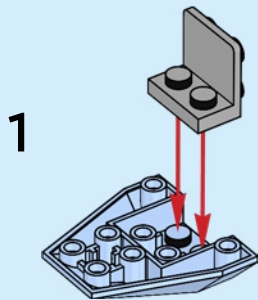

4

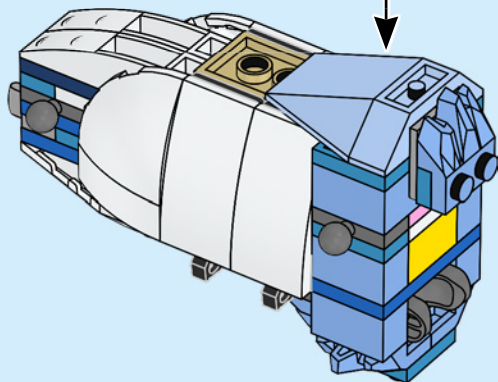
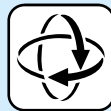
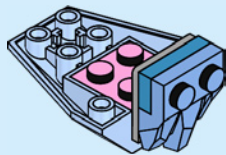



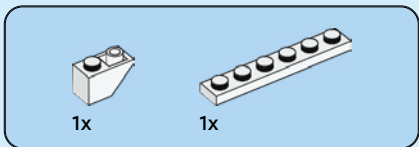
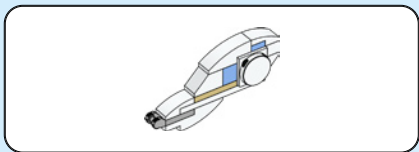

29

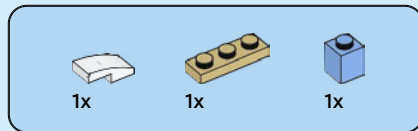
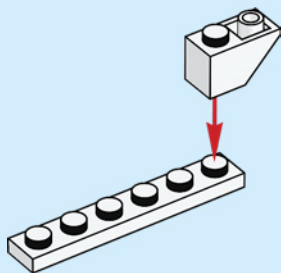

30

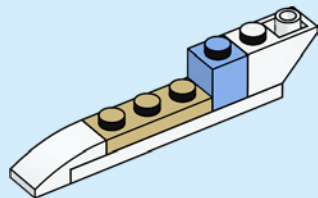

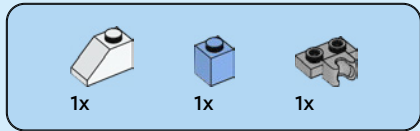

31

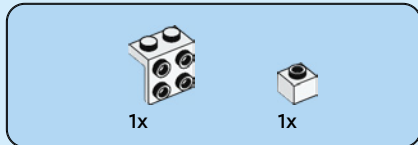
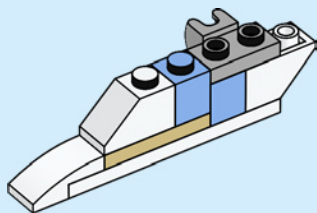

32

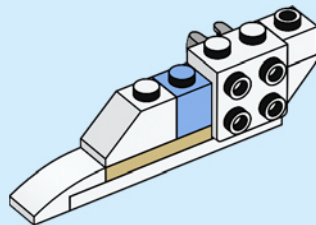



1x



1x

33

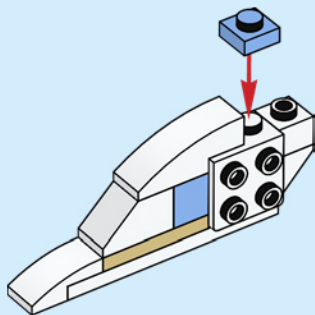

1x



1x

34

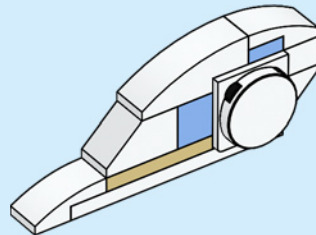

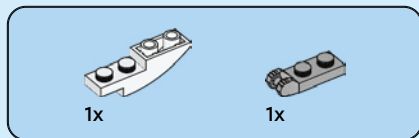

35

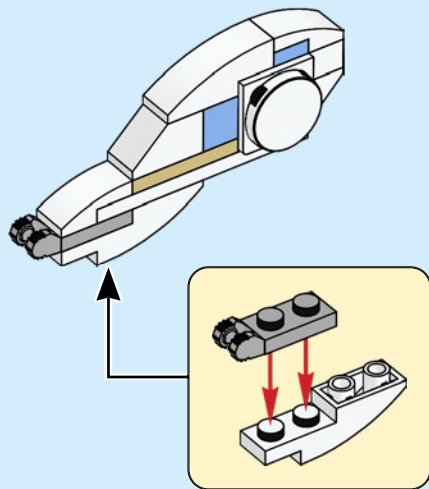

36

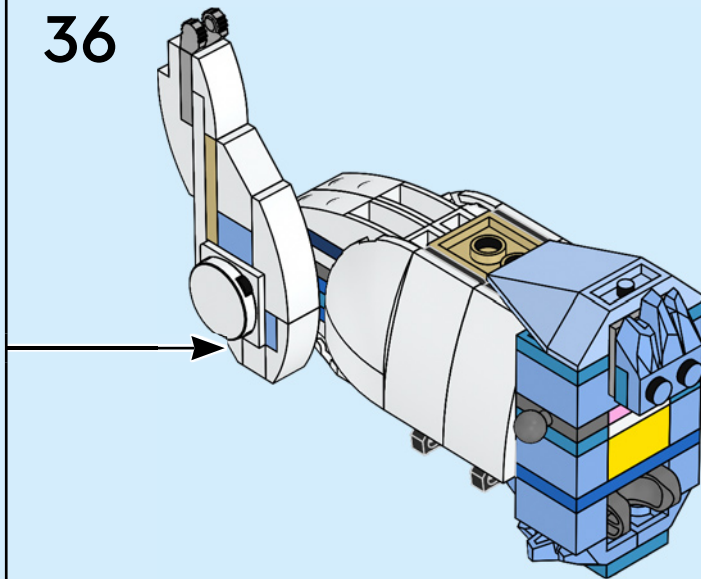

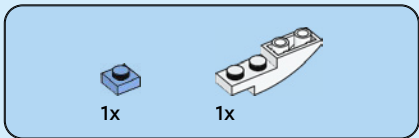
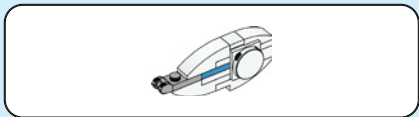

37

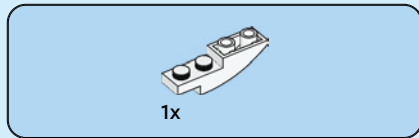
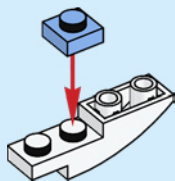

38

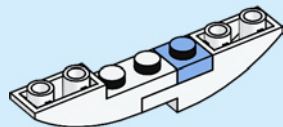



1x

39

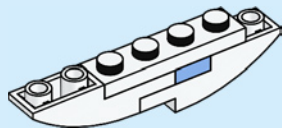

1x



1x



1x



1x

40

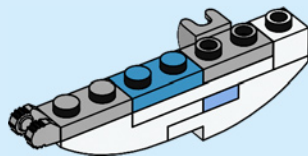

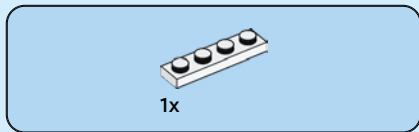

41

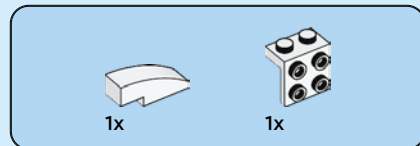
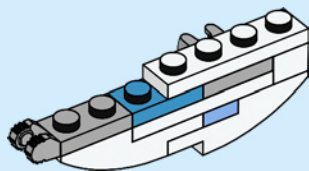

42

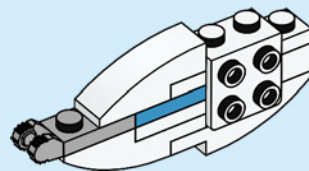

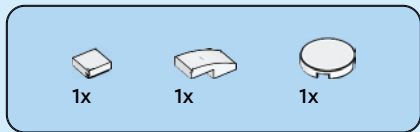

43

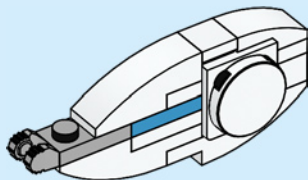

44

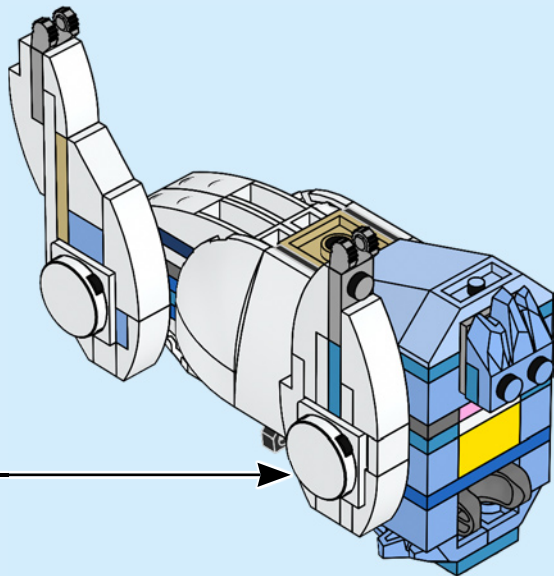

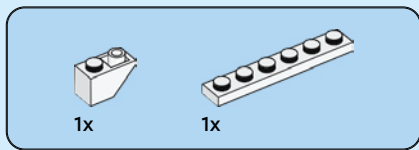
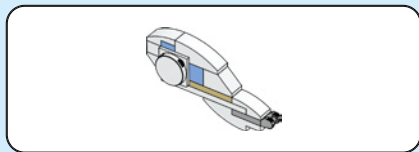

45

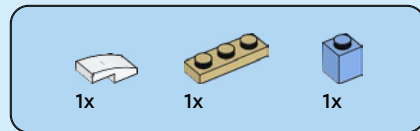
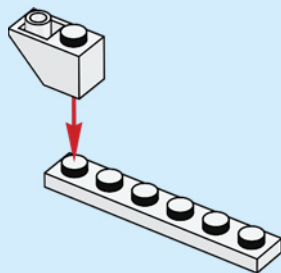

46

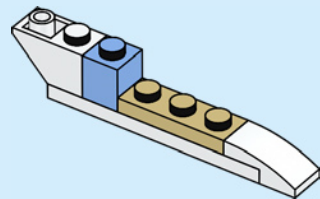

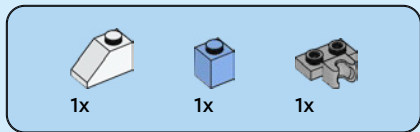

47

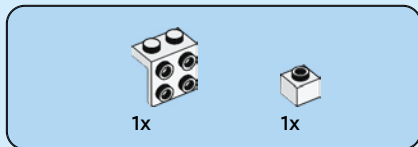
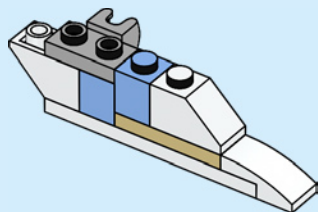

48

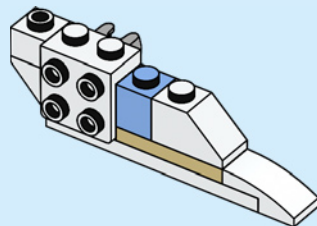



1x



1x

49

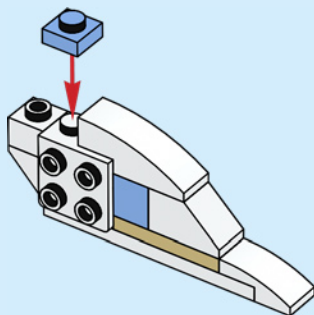

1x



1x

50

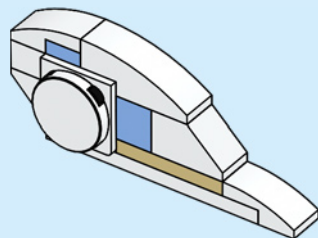

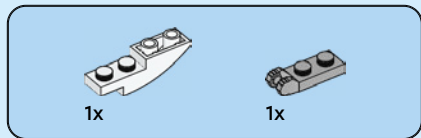

51

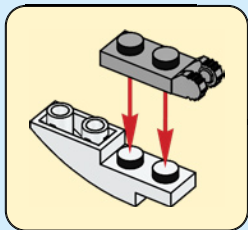
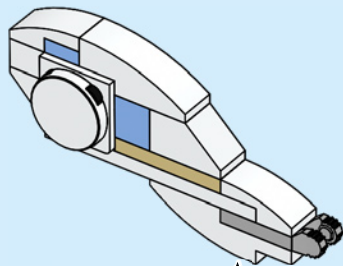

52

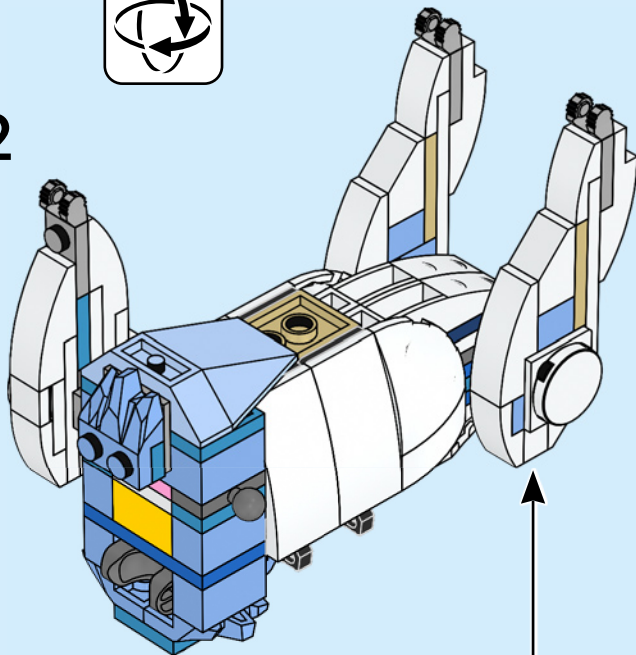
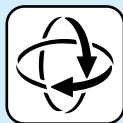

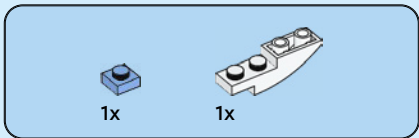
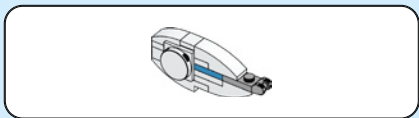

53

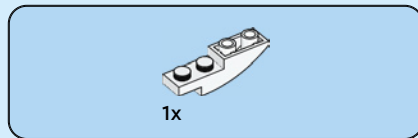
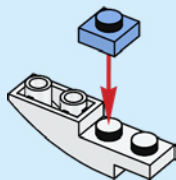

54

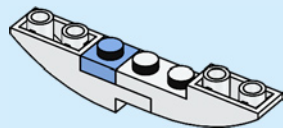



1x

55

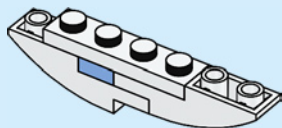

1x



1x



1x



1x

56

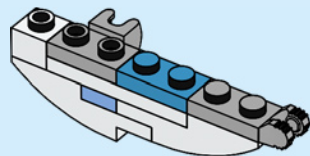



1x

57

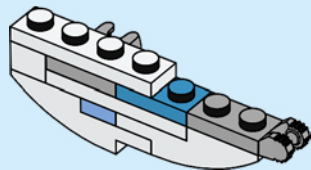

1x



1x

58

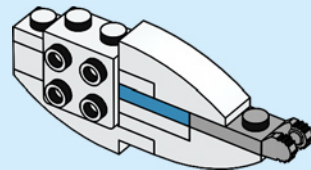

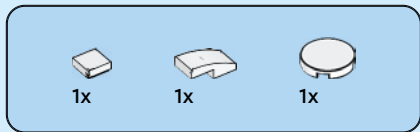

59

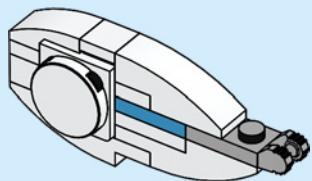

60

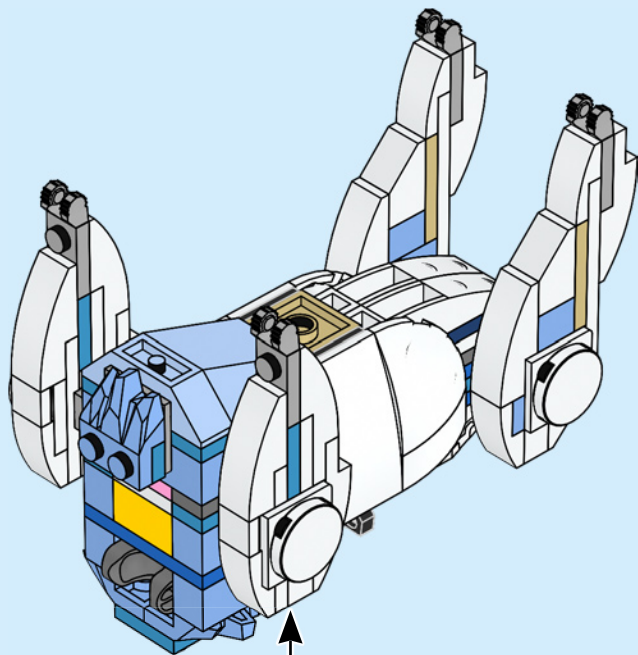

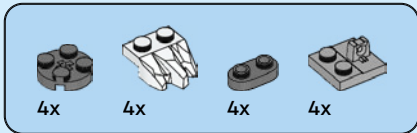

61

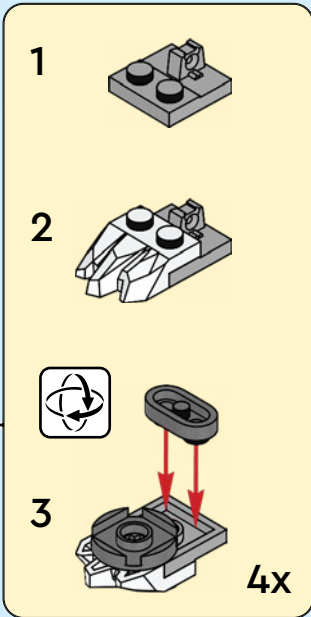
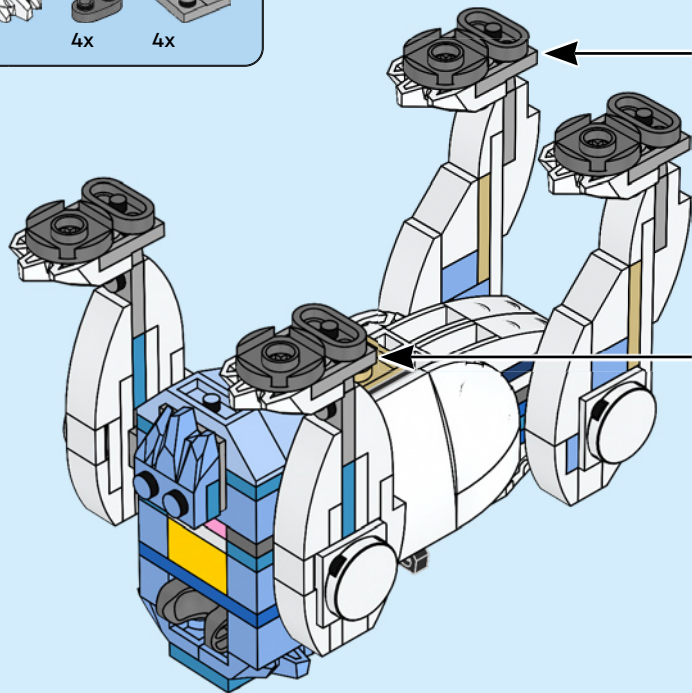



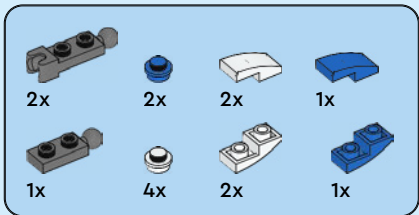
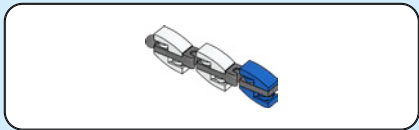

62

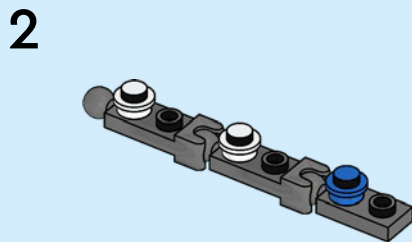
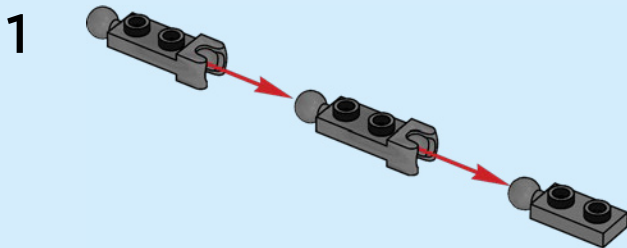

3

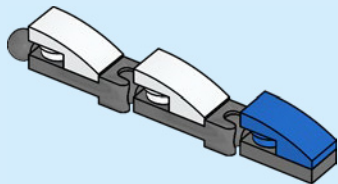

4

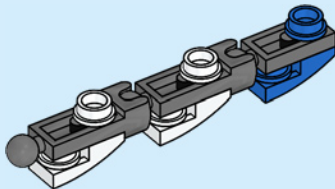

5

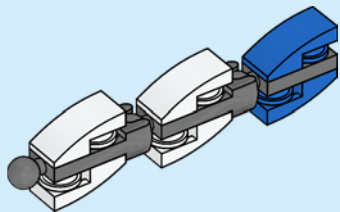

6

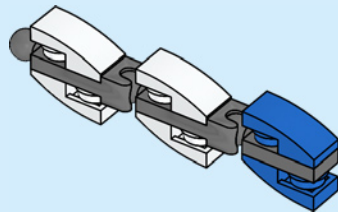

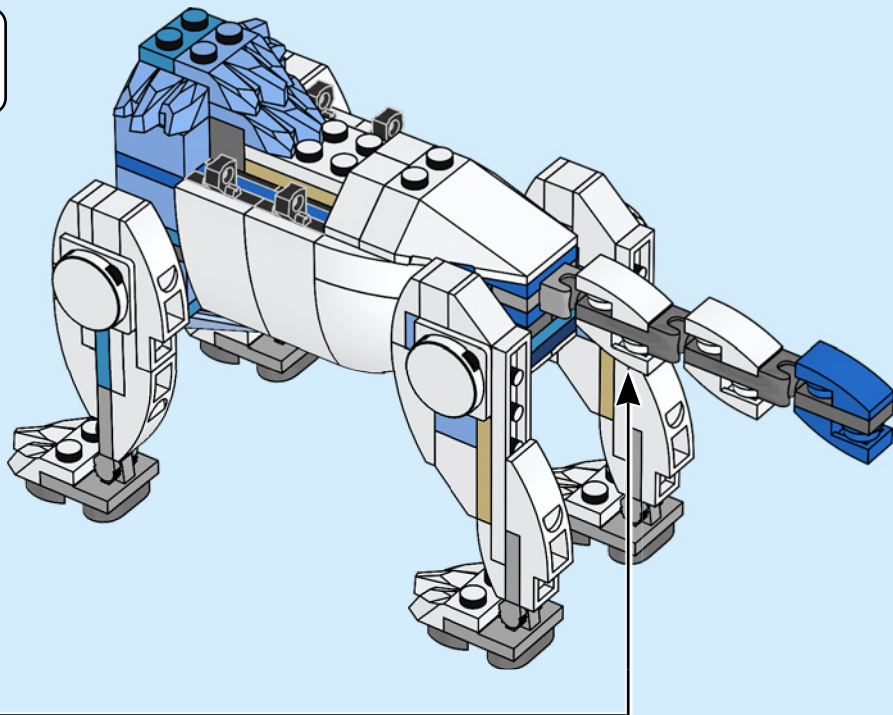

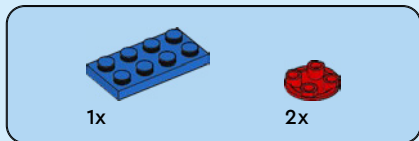
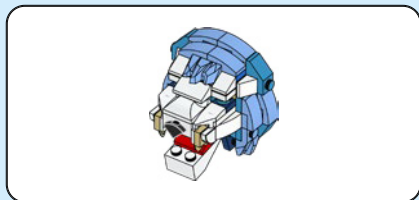

63

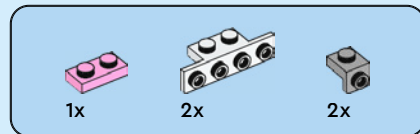
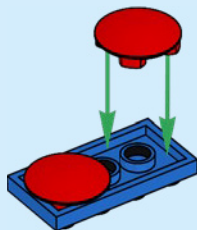

64

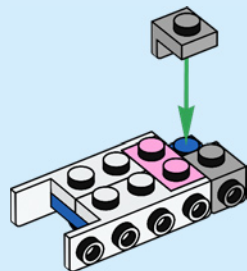

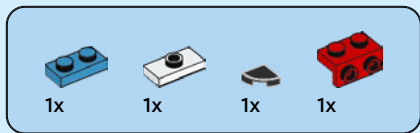

65

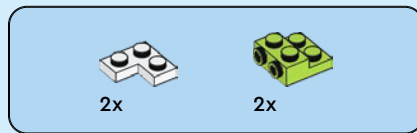
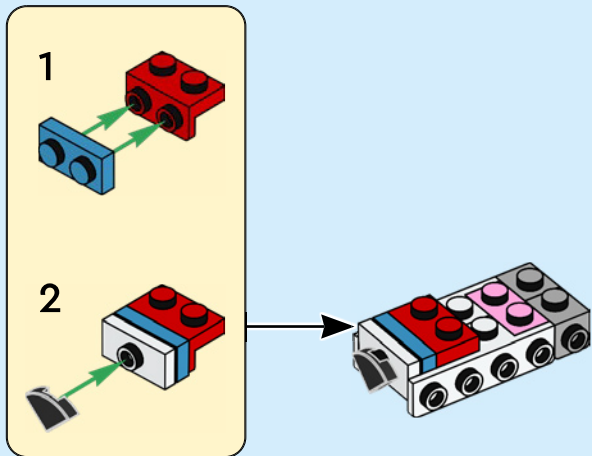

66

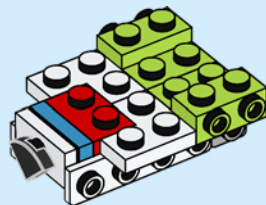

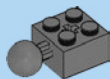

1x

67

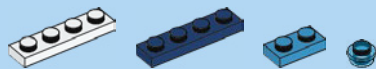
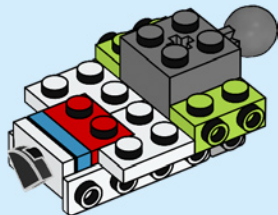

1x

1x

1x

2x

68

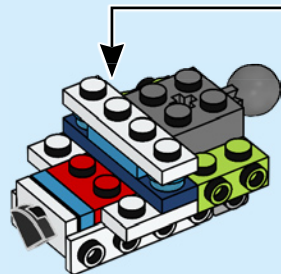

1

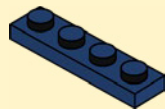

2

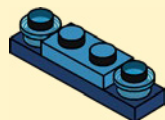

3

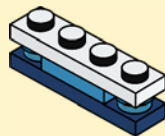



1x

69

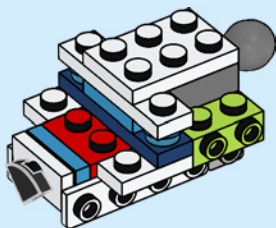

2x



1x



1x

70

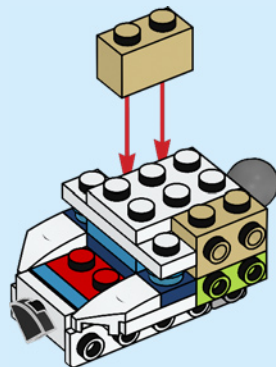



1x



2x

71

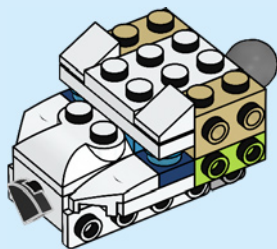

1x

72

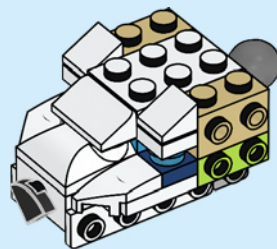

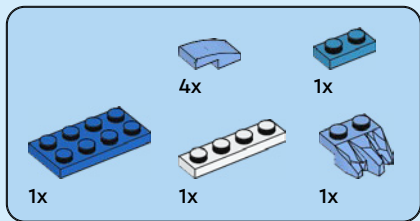

73

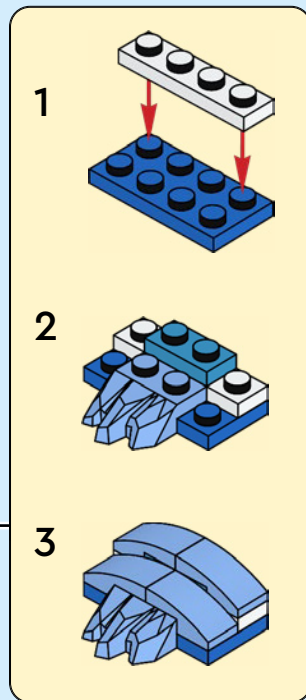
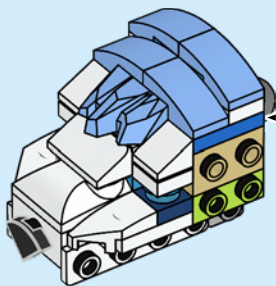

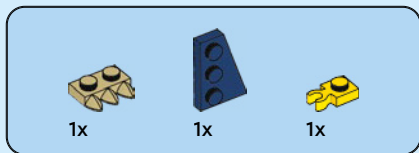

74

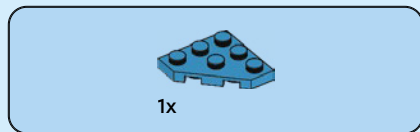

75

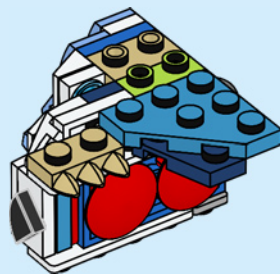



1x



1x

76



1x



1x



1x

77

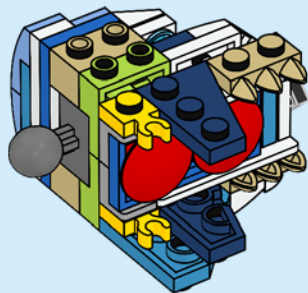



1x

78

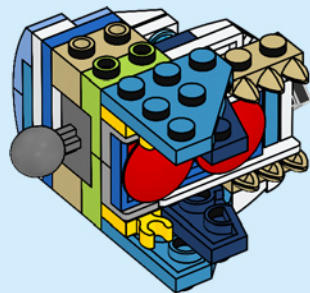

1x



1x

79

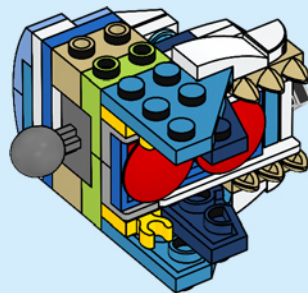

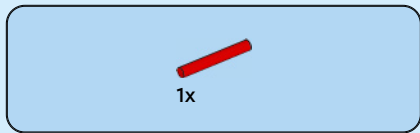

80

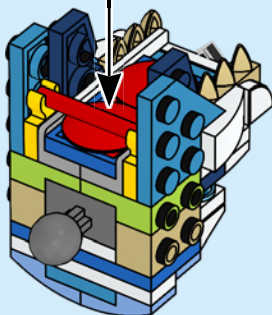
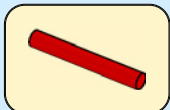

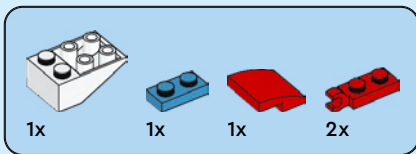

81

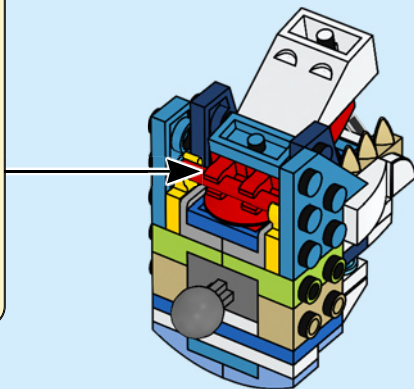
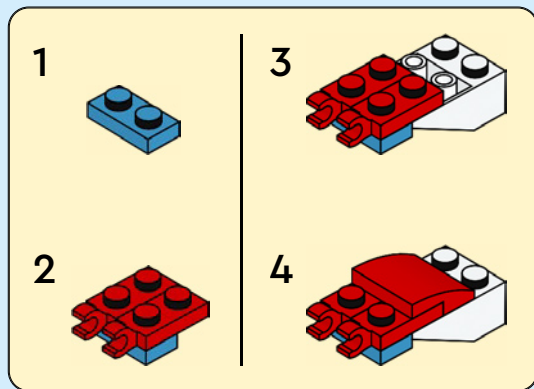



1x

82

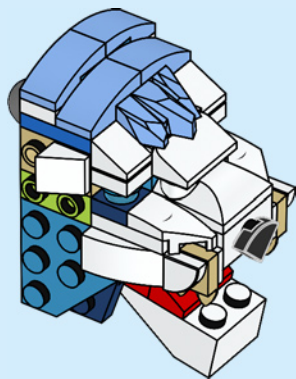

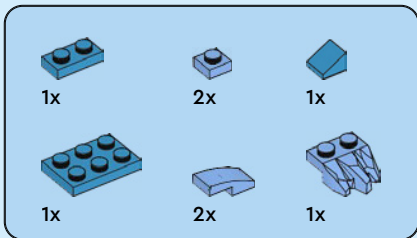

83

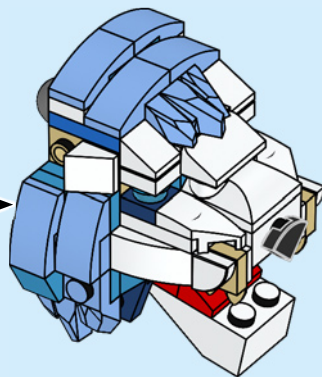
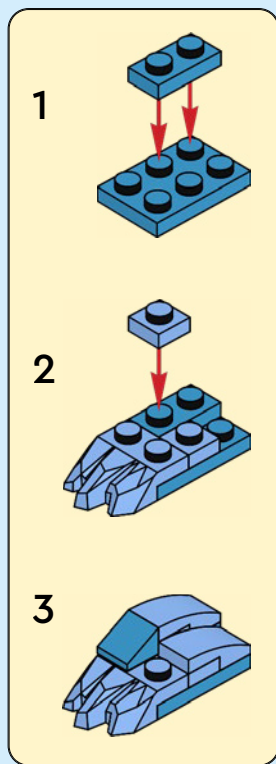



1x

84

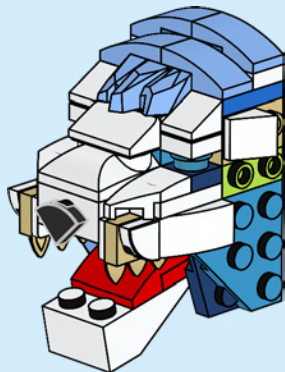

1x



2x



1x



1x



2x



1x

85

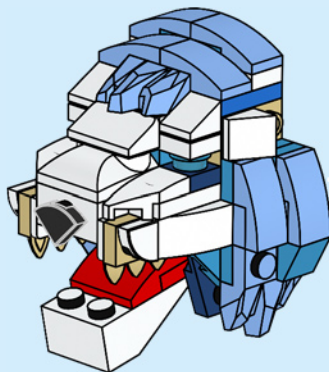

1

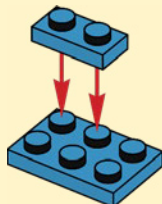

2

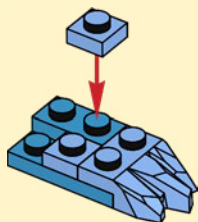

3

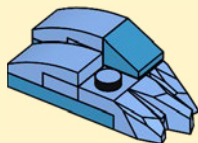



2x

86

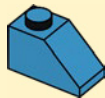

2x

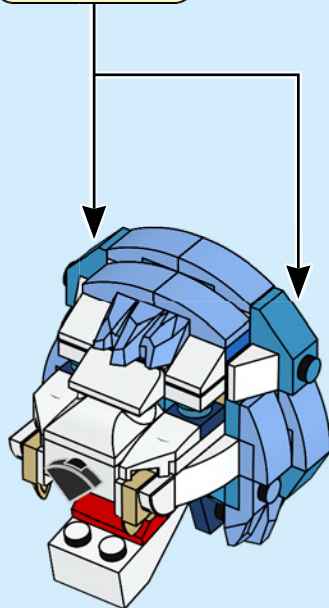

87

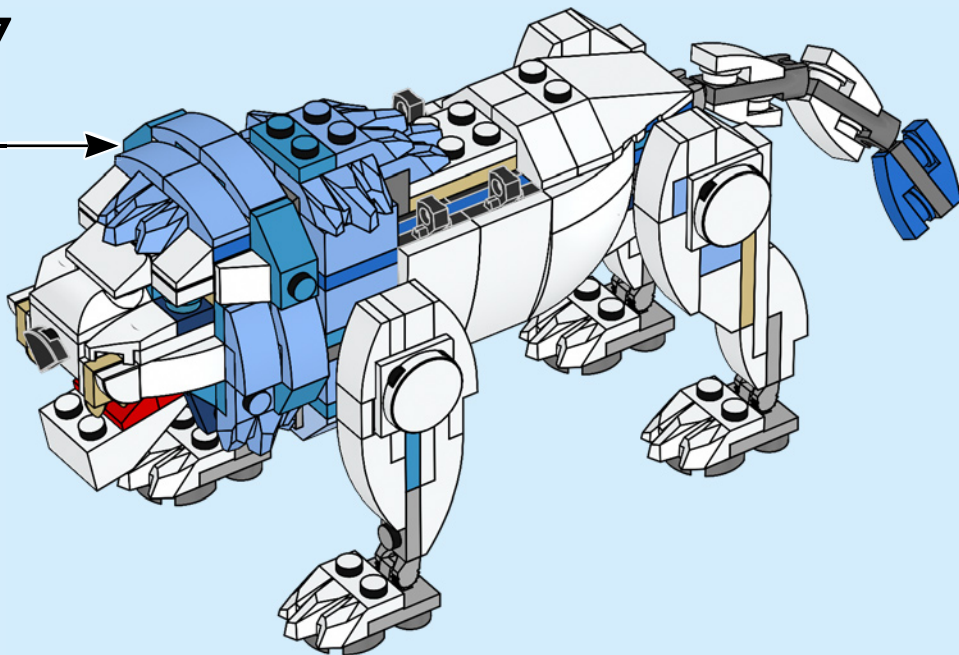



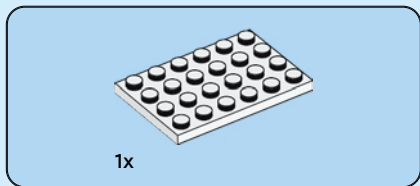
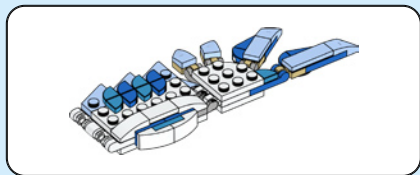

88

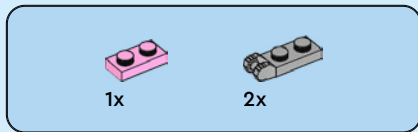
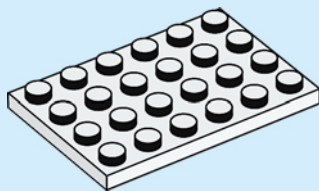

89

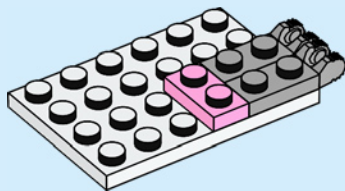

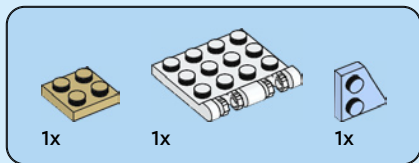

90

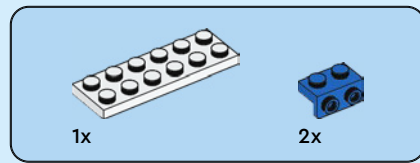
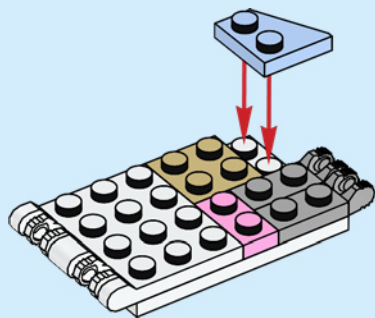

91

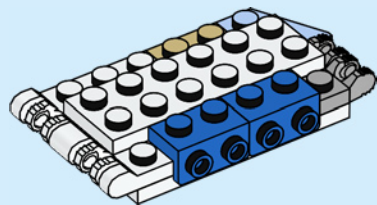



3x

92

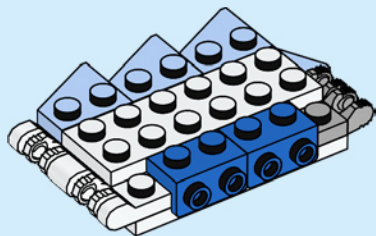

1x



4x



4x

93

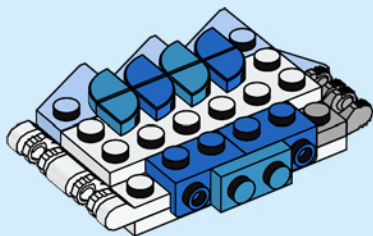



1x



4x

94

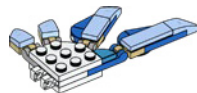
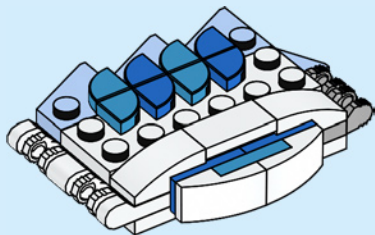

1x

95





2x

96

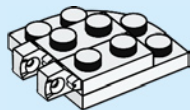

1x



3x

97

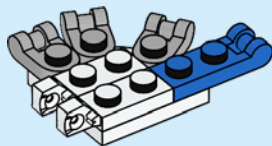



98

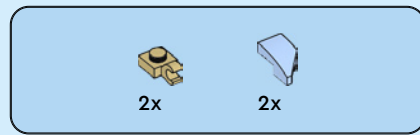
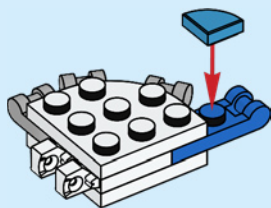

99

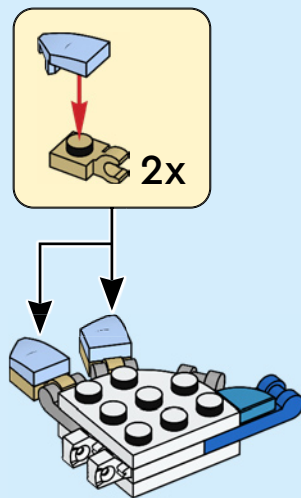

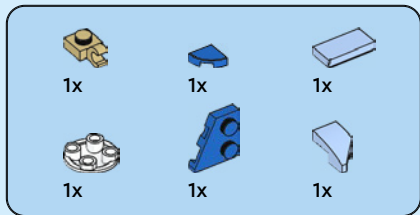

100

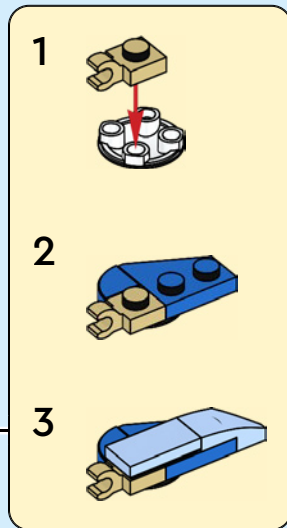
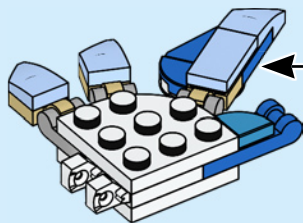

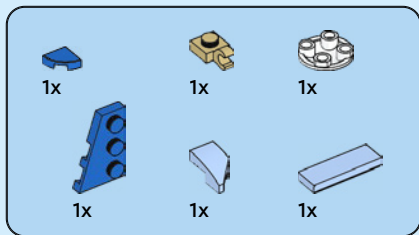

101

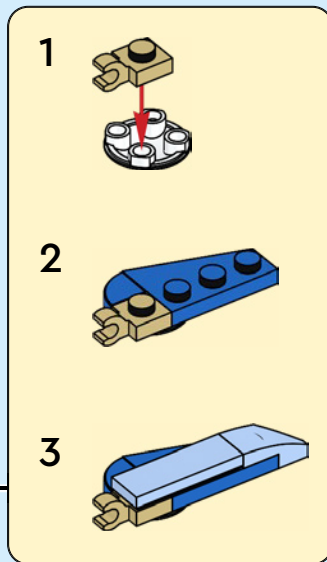
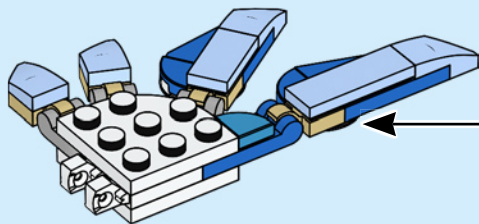

102

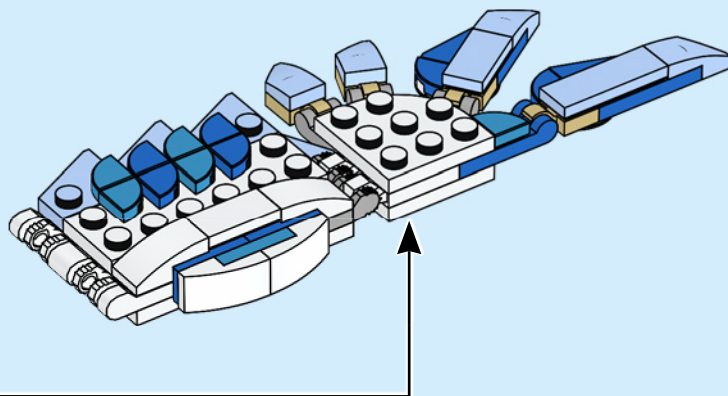

103

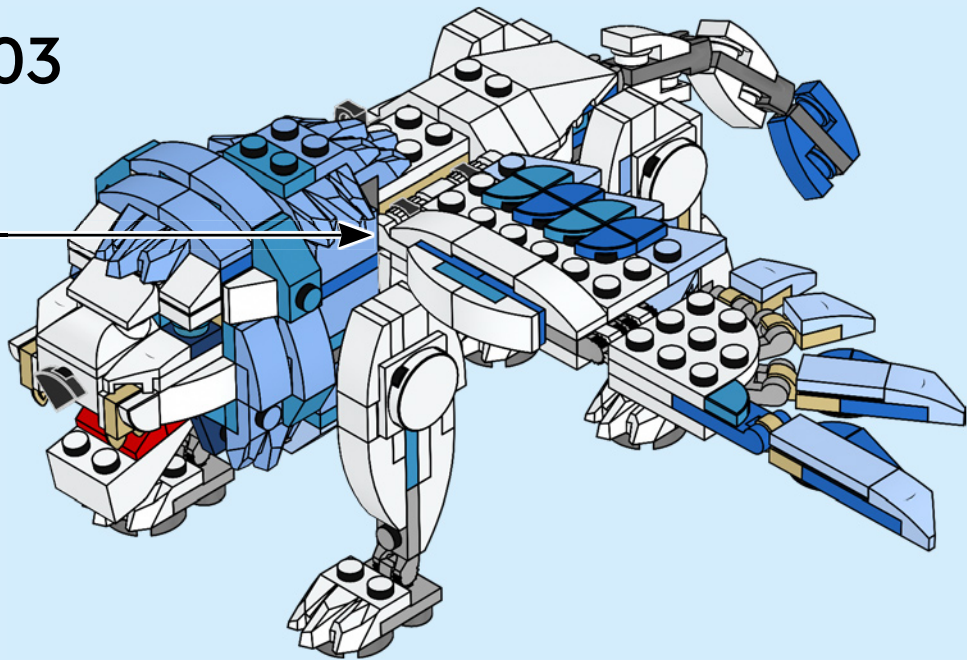

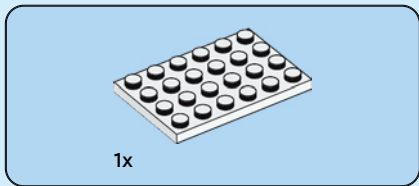
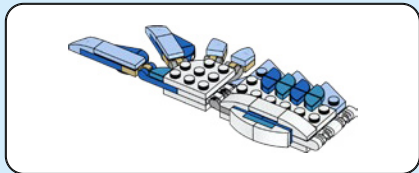

104

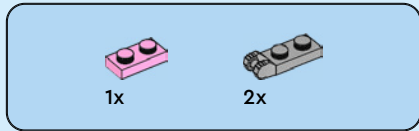
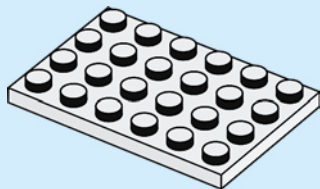

105

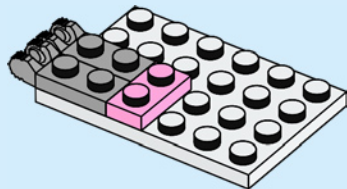

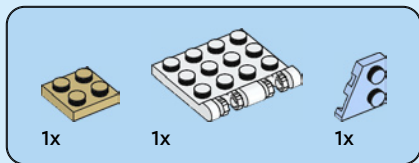

106

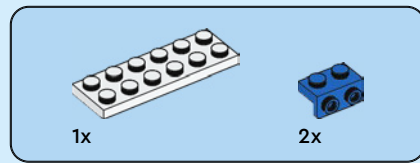
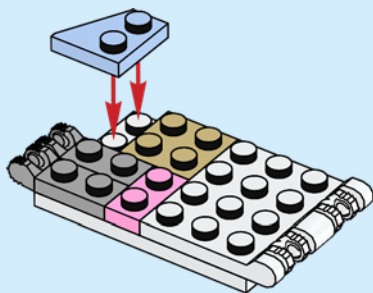

107

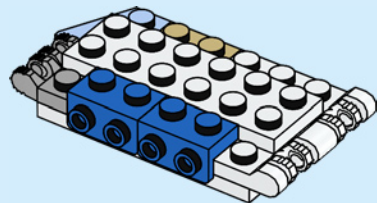



3x

108

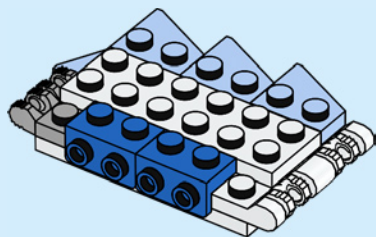

1x



4x



4x

109

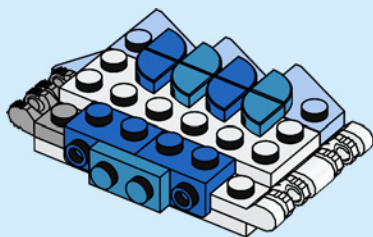



1x



4x

110

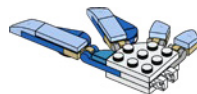
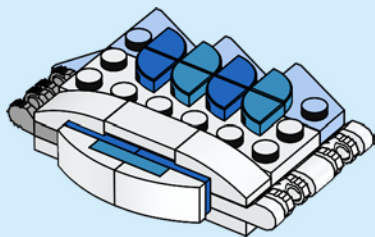

1x

111

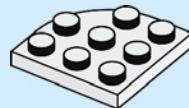



2x

112

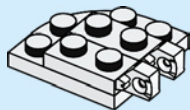

1x



3x

113

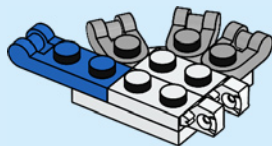



114

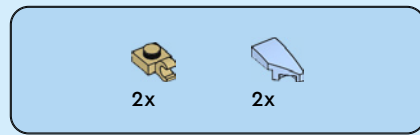
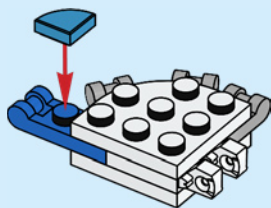

115

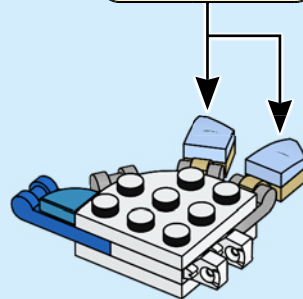
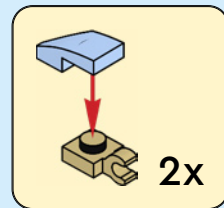

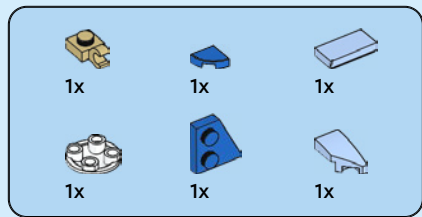

116

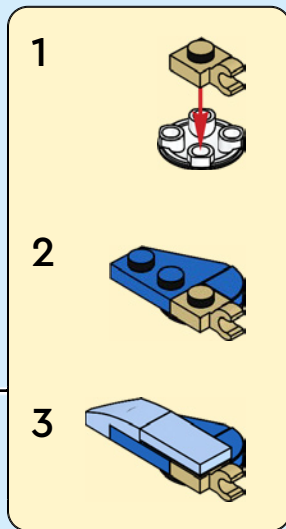
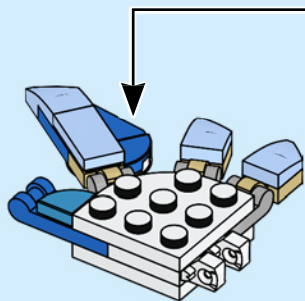

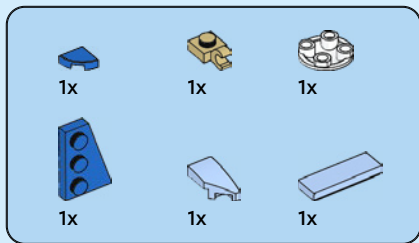

117

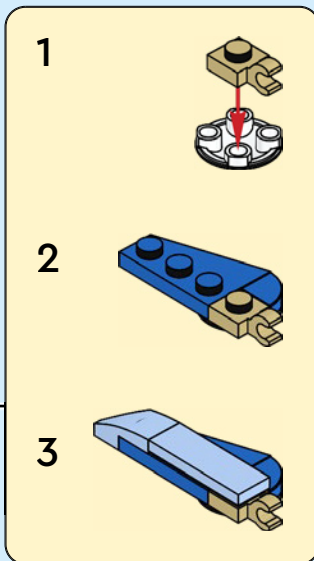
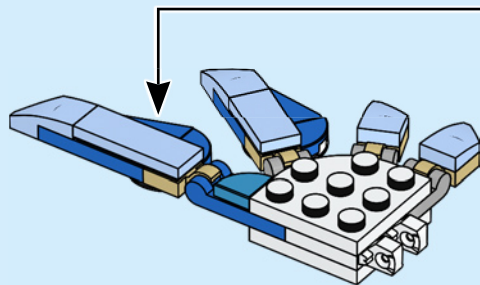



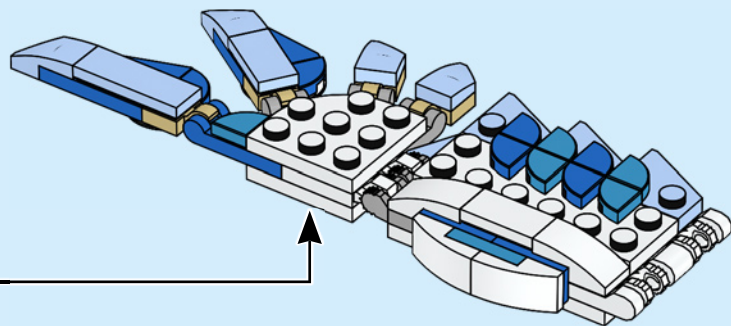



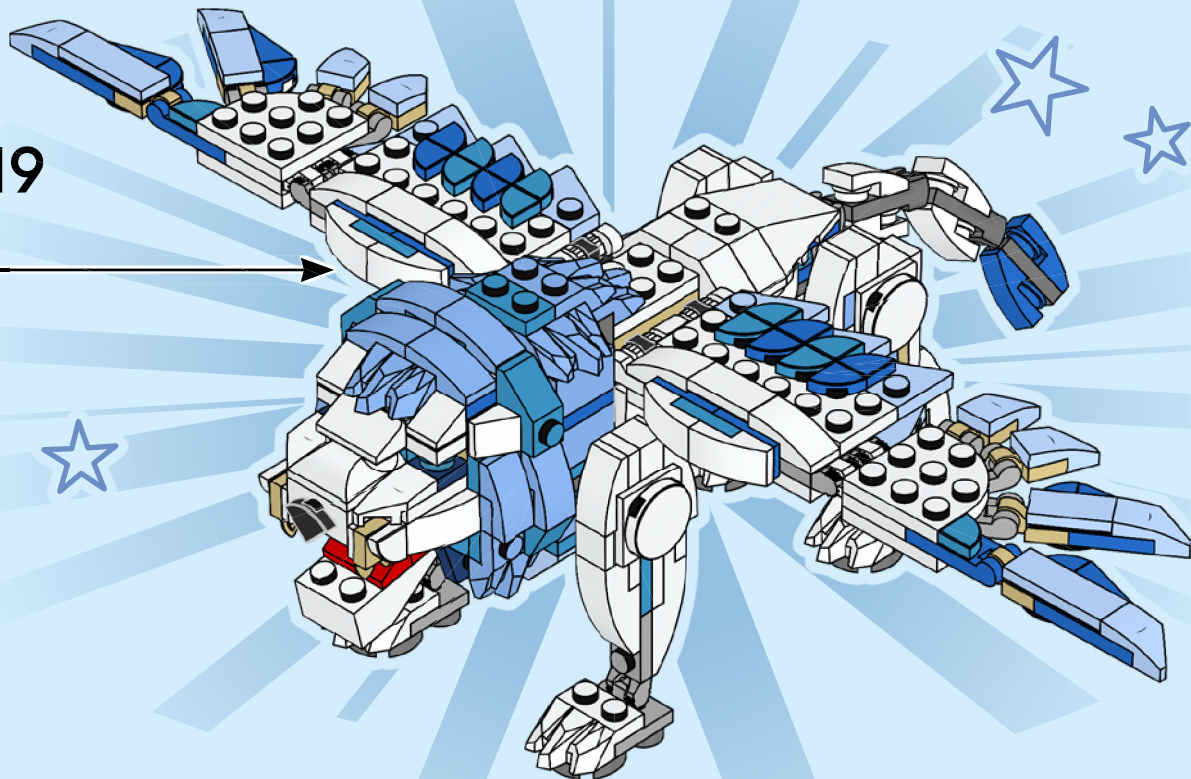















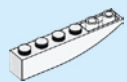

118















































119





 2x 6284599	 18x 6034044	 4x 6181319	 6x 371001	 2x 379501	 2x 4114084	 1x 6275080
 4x 614101	 2x 6166894	 4x 6266219	 2x 6168618	 2x 303201	 2x 4121921	 1x 6105976
 2x 307001	 2x 366501	 2x 242001	 2x 302101	 1x 383201	 1x 6058091	 1x 6271140
 4x 6383985	 1x 6051511	 1x 4494474	 1x 4500469	 2x 6266280	 2x 6046907	 4x 6023770
 4x 4504369	 2x 6172927	 2x 6334524	 6x 6034675	 2x 4160403	 2x 6374151	 1x 300221
 1x 6213880	 2x 306901	 6x 4249112	 4x 4550745	 2x 366601	 8x 6347292	 6x 4278275
 2x 6172366	 2x 4121932	 4x 6117940	 4x 6031947	 2x 366601	 1x 4507055	 1x 6135130
 1x 6213881	 4x 4278271	 1x 6018302	 1x 6299775	 2x 4113993	 2x 6024495	 3x 6319330
 1x 4547489	 4x 6044691				 8x 6224467	 2x 6346804

 1x 4504380	 2x 6073890	 4x 300528	 1x 6383964	 1x 4125278	 4x 6023954	 1x 4530028
 2x 4583862	 6x 302023	 2x 306928	 2x 6240214	 1x 4504371	 1x 6188696	 1x 4502089
 12x 6302961	 2x 614123	 2x 6021539	 4x 6236915	 2x 6325978	 1x 6188696	 1x 4569836
 1x 6189198	 1x 6055065	 4x 6343326	 8x 4179826	 1x 6213778	 1x 4164022	 4x 6170761
 1x 6189202	 1x 6308097	 1x 6401707	 4x 4179830	 4x 6228967	 2x 6264064	 2x 4616581
 1x 4498156	 4x 6163471	 1x 4116671	 5x 4179833	 5x 6350418	 1x 6251381	 1x 6262140
 1x 4498155	 3x 302223	 1x 6232138	 8x 6301857	 7x 6338181	 1x 6251382	 1x 6259037
 1x 300423	 1x 6092582	 1x 6166127	 8x 6394528	 2x 6209682	 1x 4530129	 1x 6003003
	 3x 6335549		 1x 4205058	 2x 6267189		 1x 6003033

 2x 6248078	 4x 6177078	 4x 6221607	 2x 6209683	 1x 6214208	 1x 6223823	 4x 6337231	 1x 4106552
 6x 6225246	 5x 4234535	 4x 4211042	 4x 6372228	 1x 6190252	 2x 4570877	 1x 6172383	 1x 6394539
 7x 6043656	 6x 6265742	 6x 6039479	 4x 6383107	 2x 6133838	 1x 6312485	 1x 6325525	 3x 4654128
 1x 6186657	 2x 6267142	 1x 6123814	 4x 6383109	 10x 6199887	 1x 6105708	 4x 6266244	 2x 6096589
 1x 6028813	 8x 6267048	 2x 6309059	 4x 6372226	 21x 4653988	 2x 6348065	 11x 6117973	
 6x 4211398	 6x 6245254	 4x 6039482	 2x 6097861	 2x 6036851	 1x 4639693		
 2x 4211614	 4x 4622803	 5x 6118832	 2x 6372225	 1x 6153138			
 1x 4654580	 1x 6013497	 1x 4497253	 1x 6383135	 2x 6369498			
 4x 4211413	 4x 6314473	 1x 6338291	 1x 6373083	 2x 6144149			

Customer Service
Kundenservice
Service Client
Assistenza clienti
Atención al cliente
Serviço de Apoio ao Consumidor
Ügyfélszolgálat
Klientu apkalpošanas dienests
Serviciul pentru client
客户服务
コンシューマーサービス
고객 서비스
LEGO.com/service

WIN

Terms & Conditions apply

Scan this QR code or go to **LEGO.COM/PRODUCTFEEDBACK** and give us your short feedback about this LEGO® set for a chance to win a cool LEGO prize.



GEWINNE

Scanne diesen QR-Code oder geh auf LEGO.COM/PRODUCTFEEDBACK

und gib uns dein kurzes Feedback zu diesem LEGO® Set. Dann hast du die Chance, einen coolen LEGO Preis zu gewinnen.

Es gelten die Teilnahmebedingungen

GAGNE

Scannez ce code QR ou rendez-vous sur LEGO.COM/PRODUCTFEEDBACK

pour donner votre avis sur ce produit LEGO® et avoir une chance de gagner un prix LEGO.

Voir Conditions Générales

GANAN

Escanea este código QR o visita LEGO.COM/PRODUCTFEEDBACK

y comparte con nosotros tu opinión sobre este set LEGO® para tener la oportunidad de ganar un fantástico premio LEGO.

Términos y Condiciones aplicables

获取奖品

只需扫描此二维码或访问 LEGO.COM/PRODUCTFEEDBACK,

就这款乐高®套装提供简短反馈,就有机会赢得很酷的乐高奖品。

《条款及条件》适用

LEGO, the LEGO logo, the Brick and Knob configurations and LEGOLAND are trademarks of the LEGO Group.

©2022 The LEGO Group.

6504241