



Friends



41058



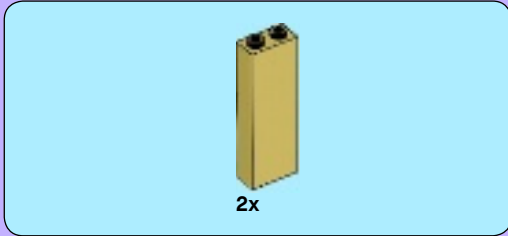
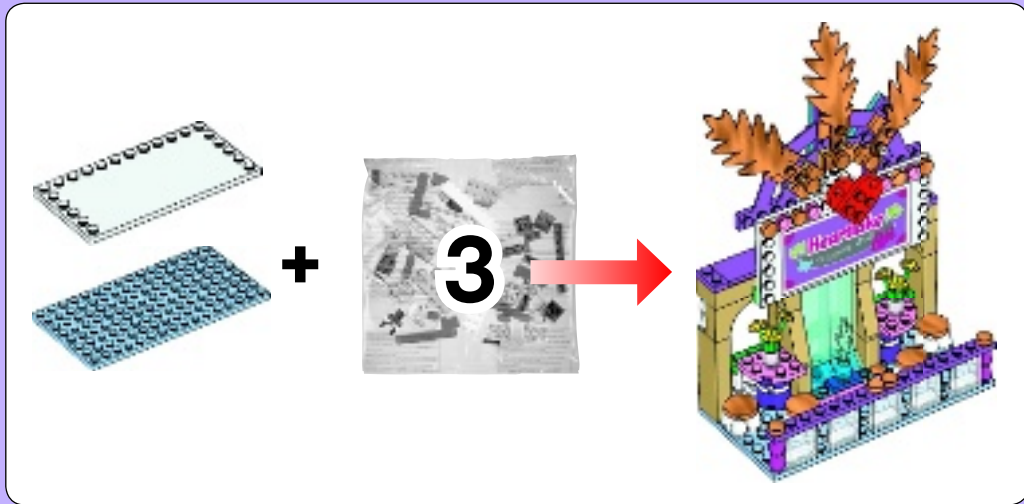

1

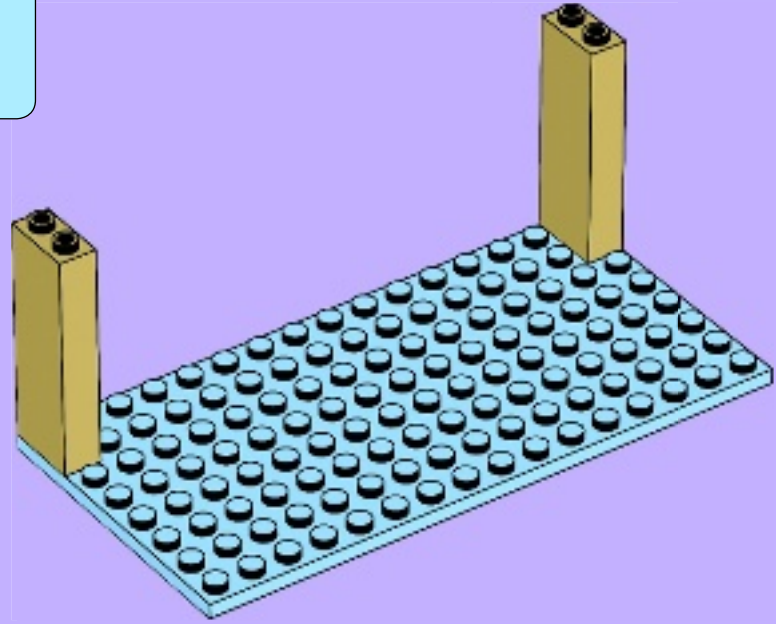

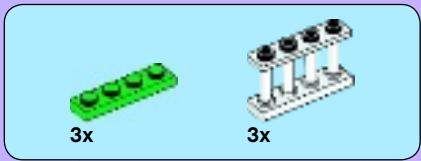

2

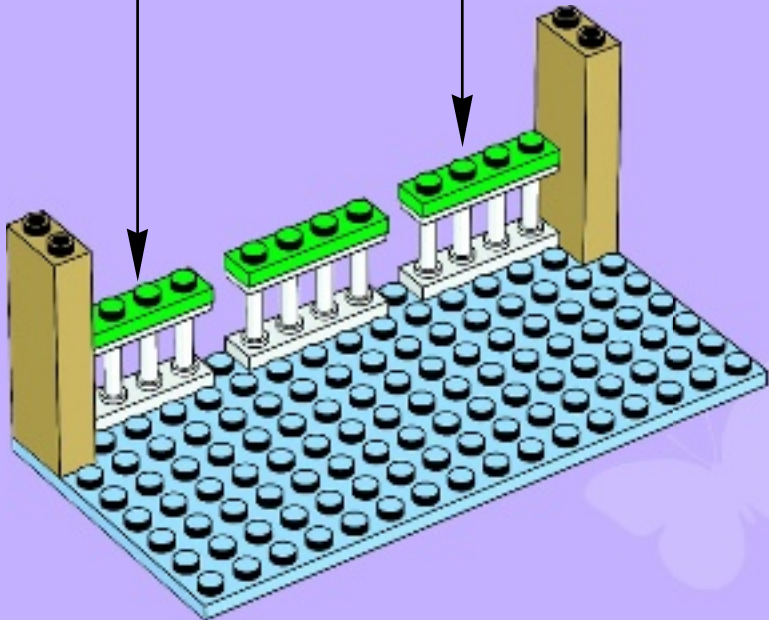
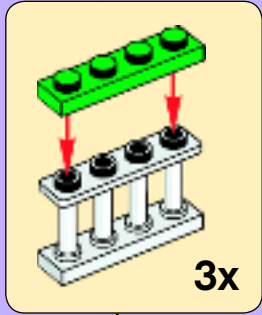

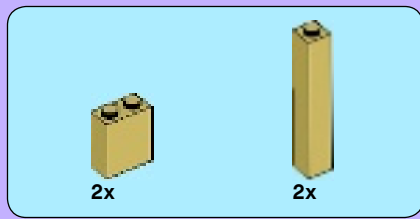

3

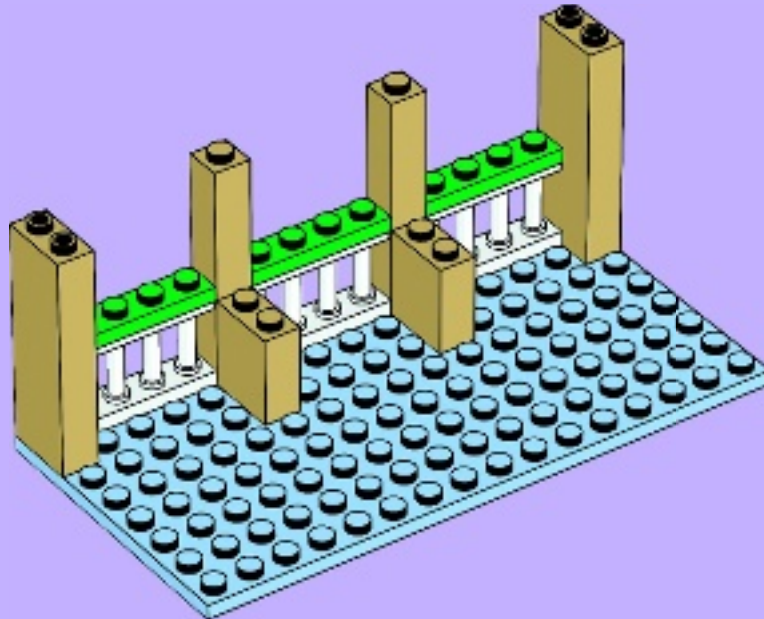



4

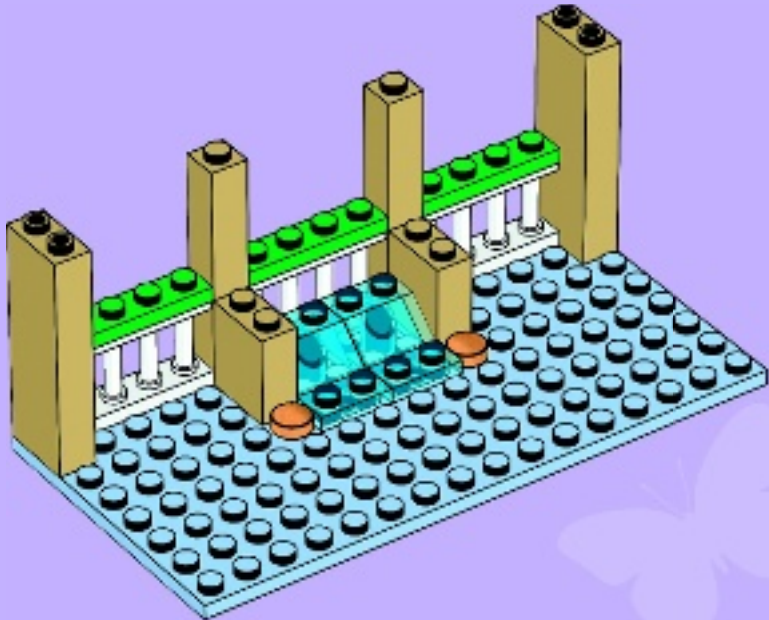

1x  3x 

5

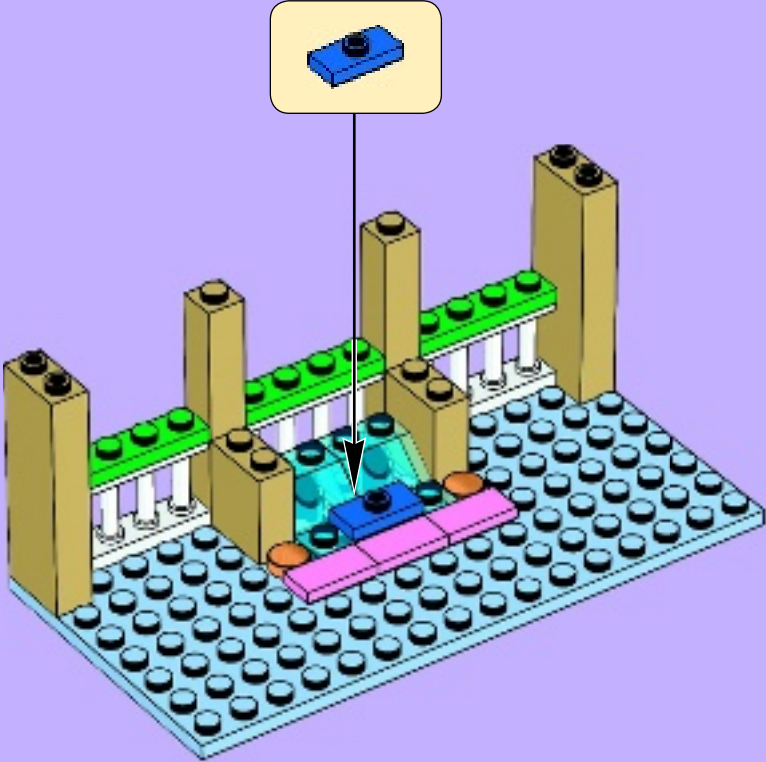

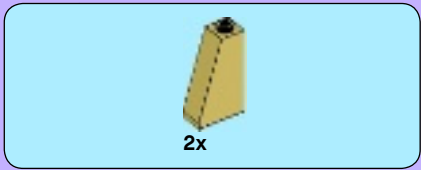

6

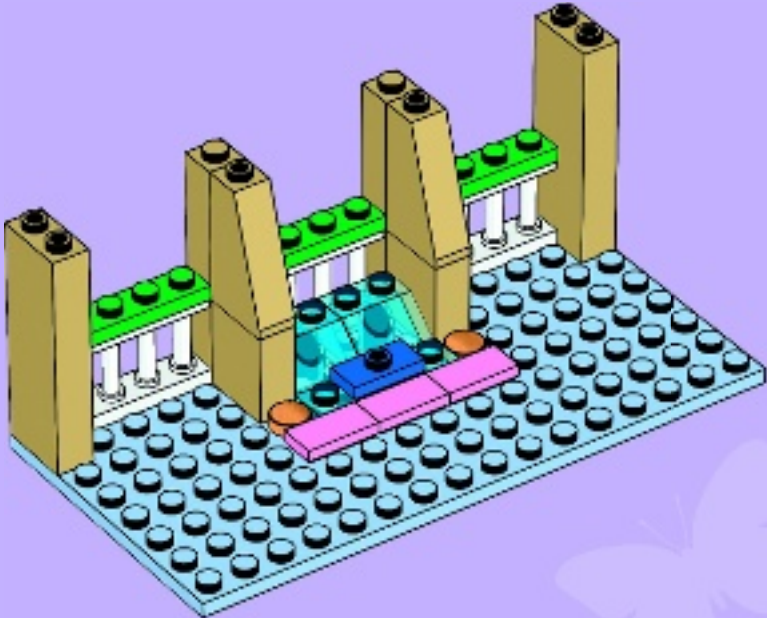

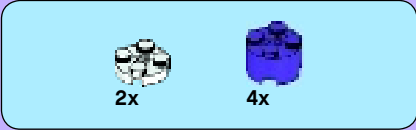

7

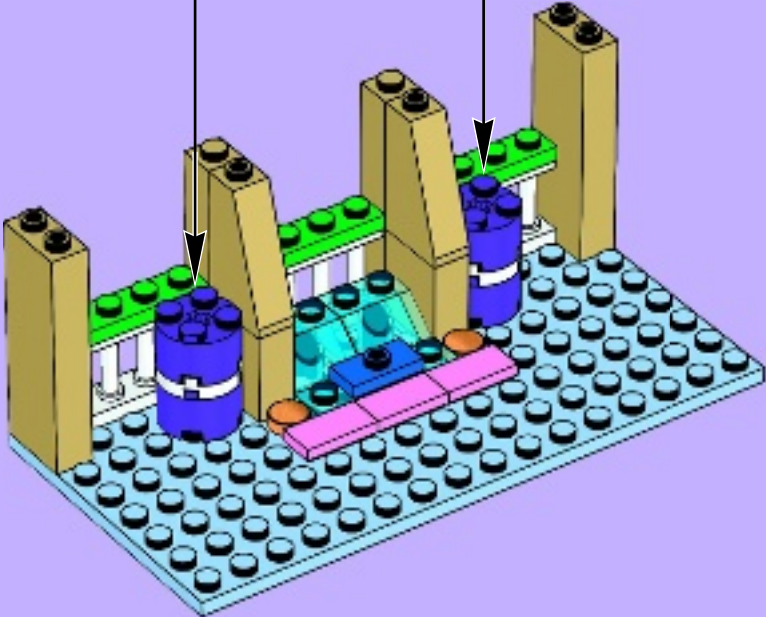
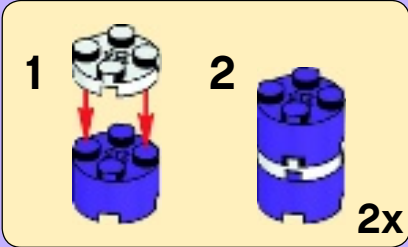



16x

8

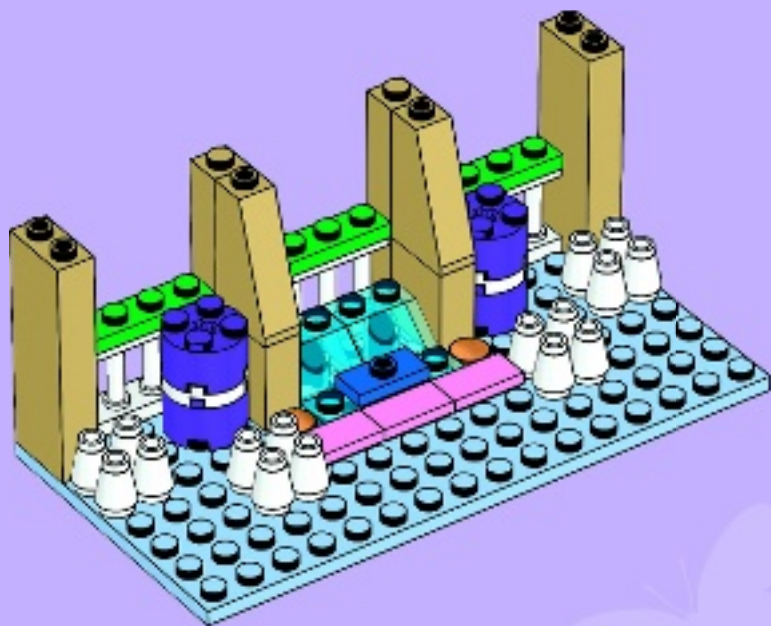



9

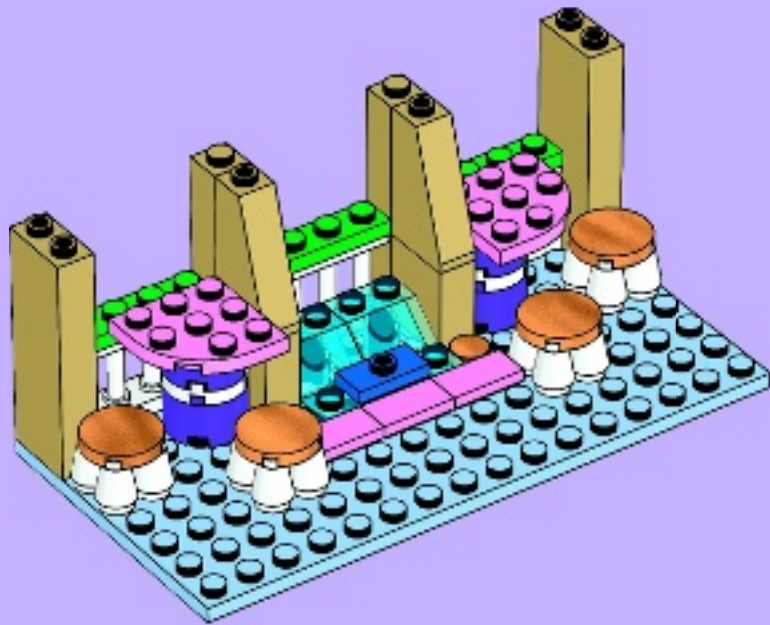

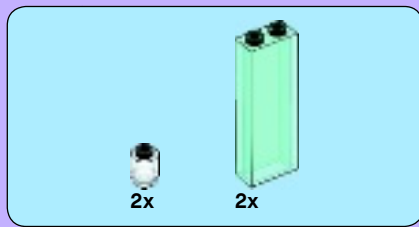

10

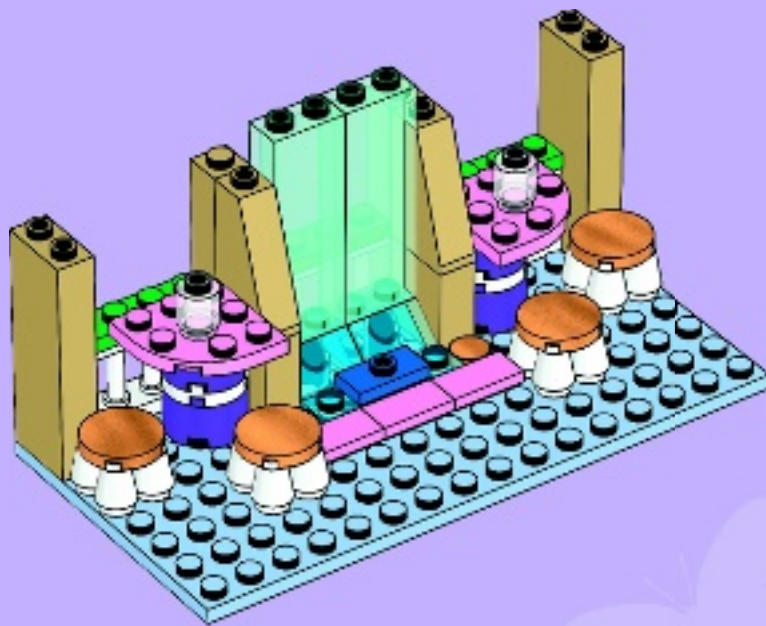



11

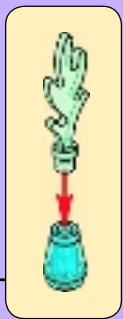
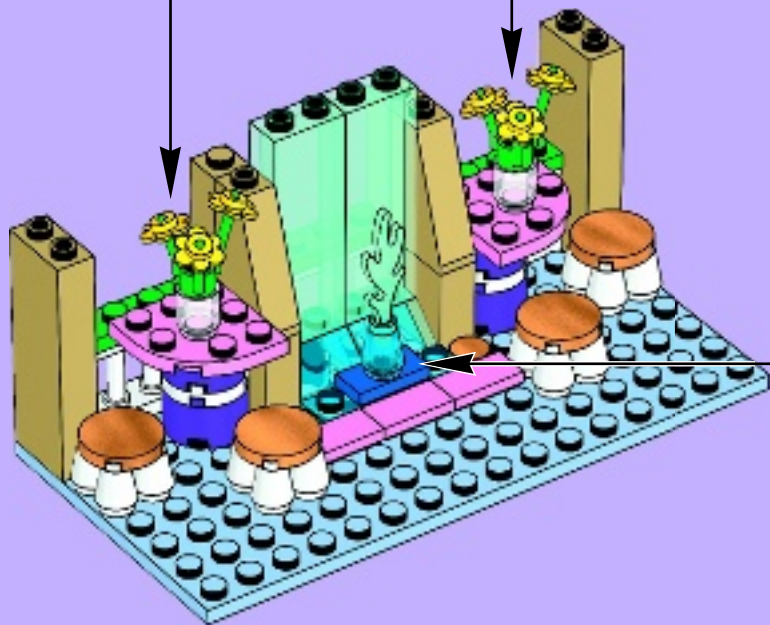

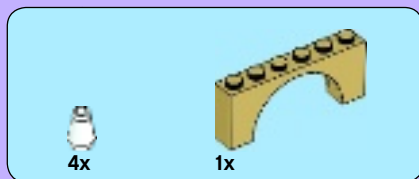

12



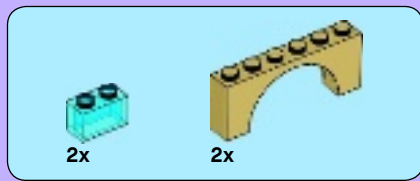

13





14

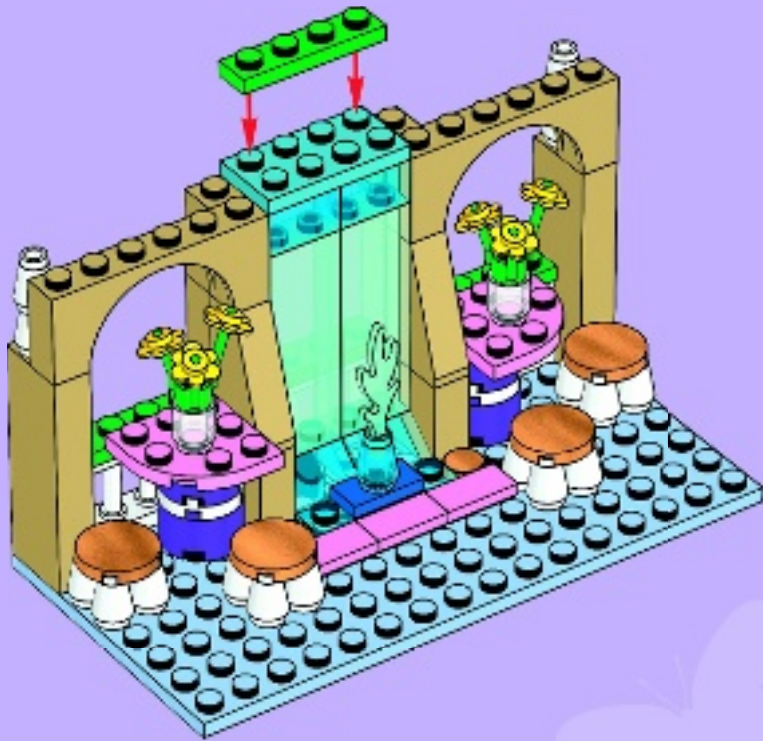



2x

15





16

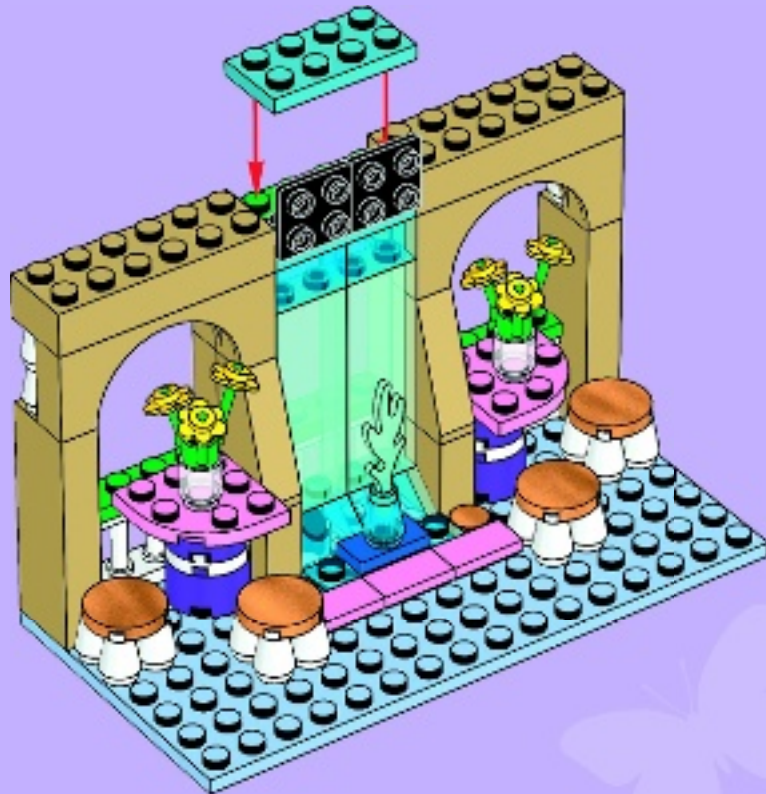

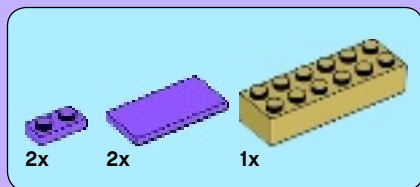

17

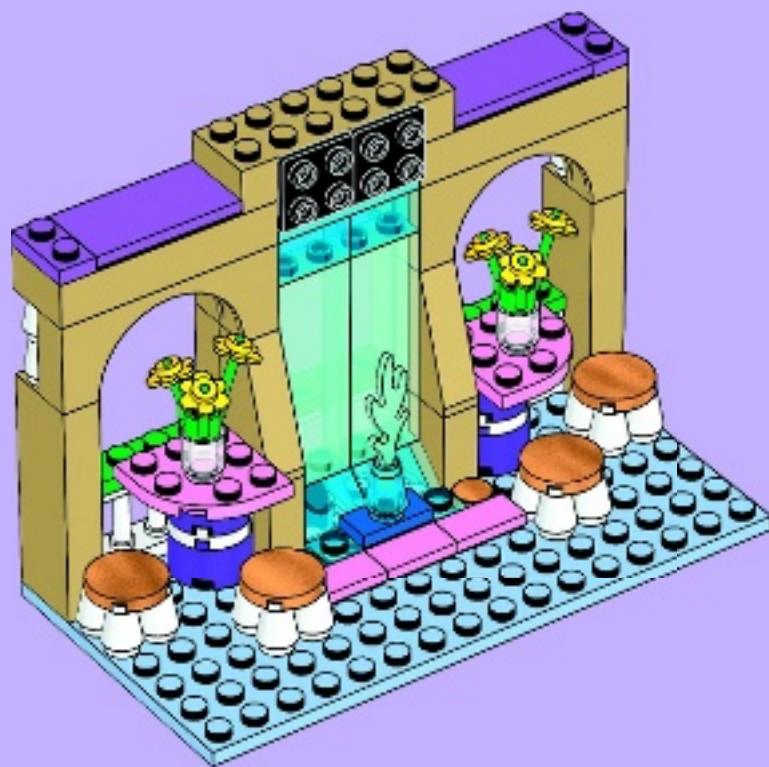



2x



2x

18

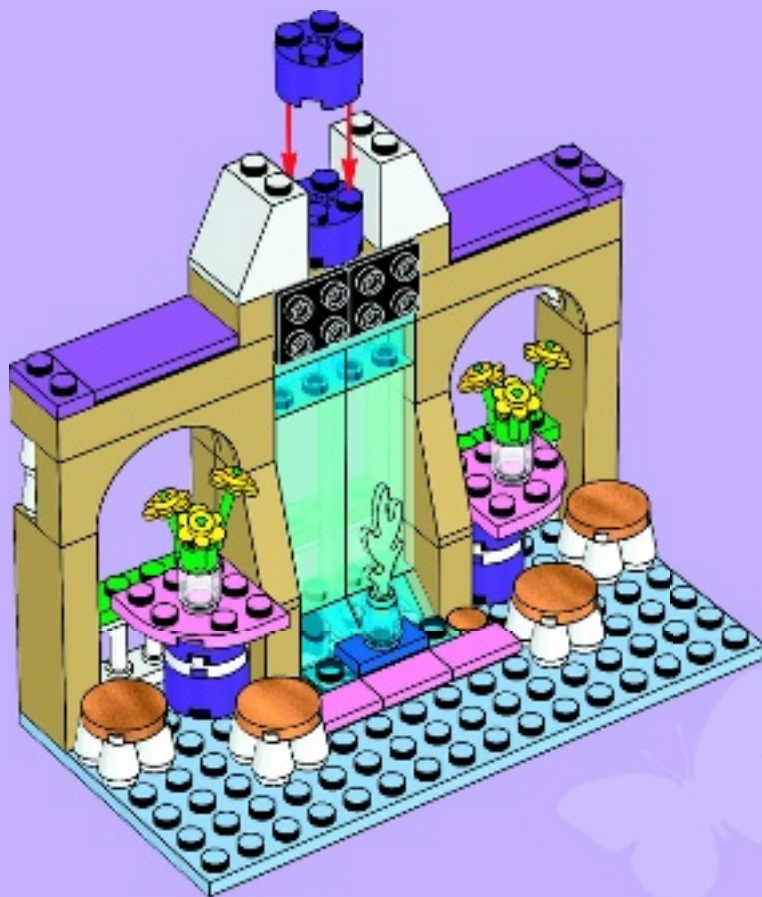

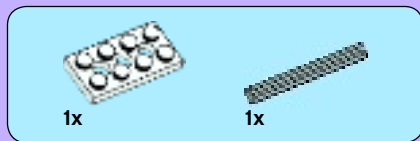

19

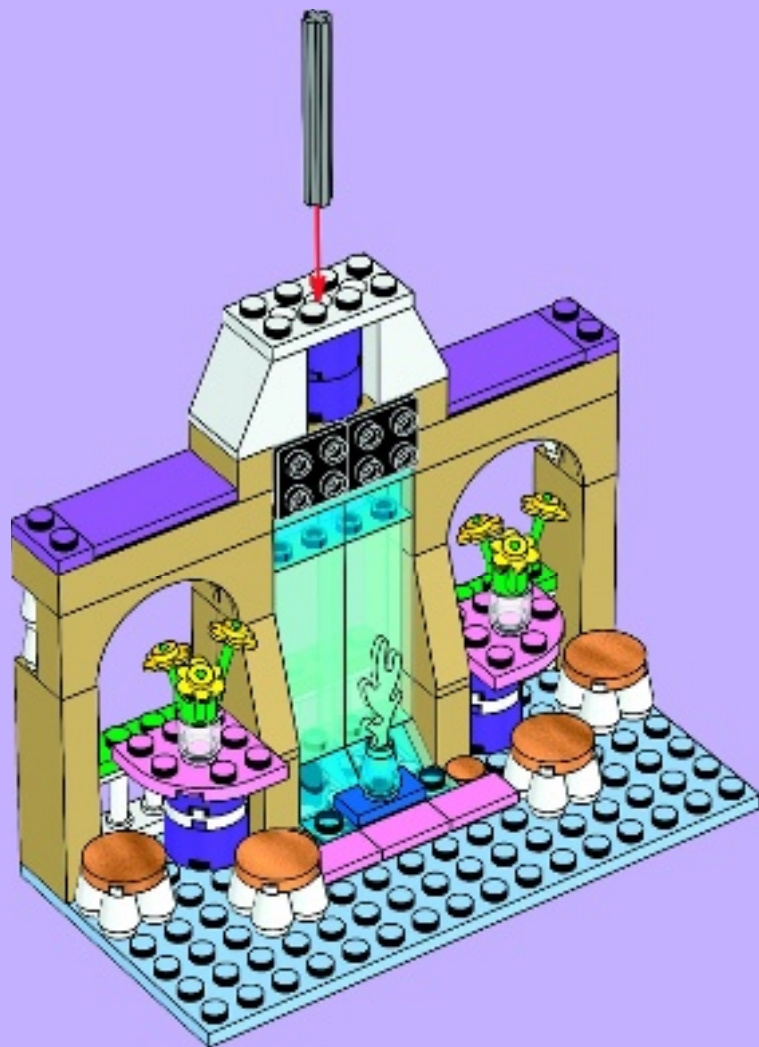



1x

20

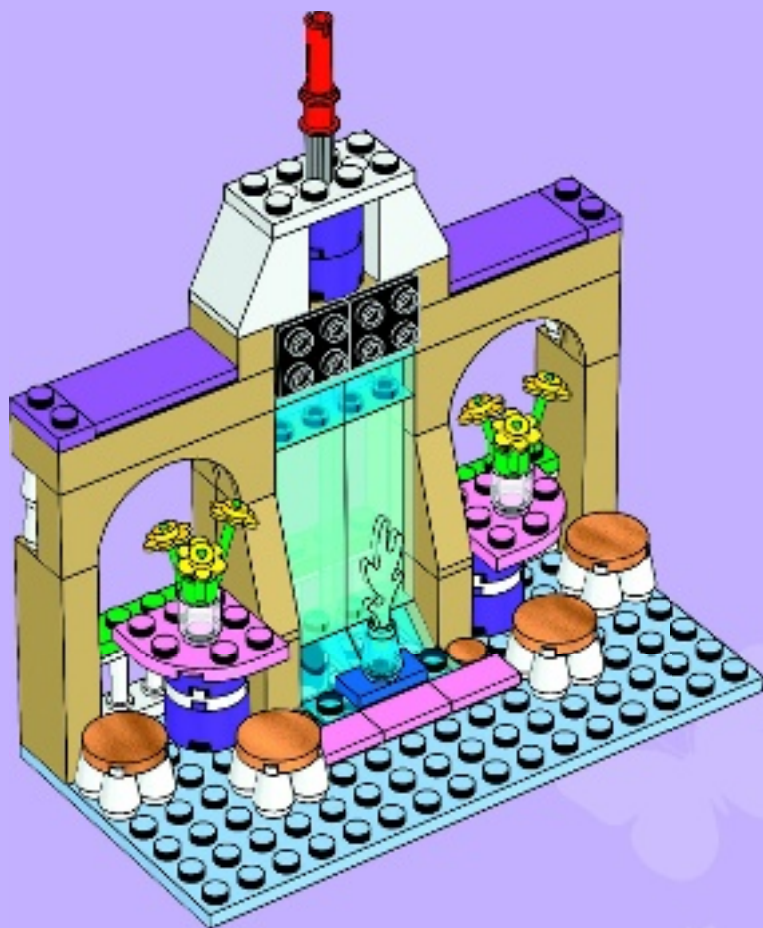

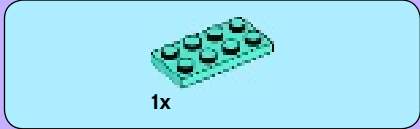
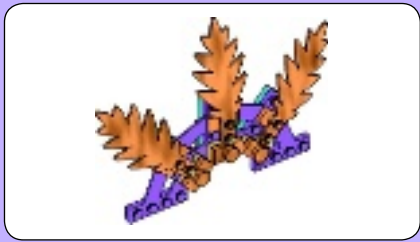

1x

1

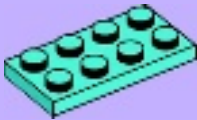

2x

2

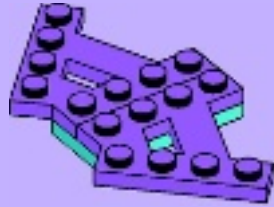



2x

3

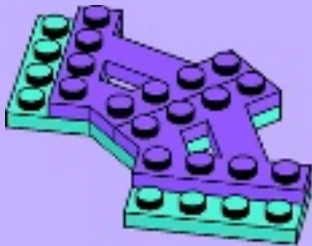

2x

4

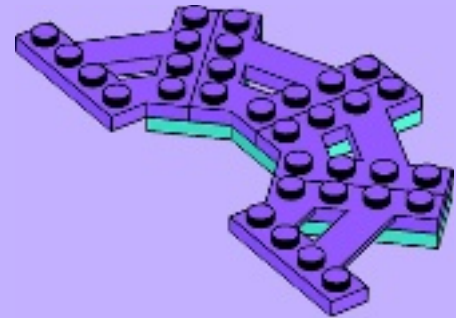



3x

5

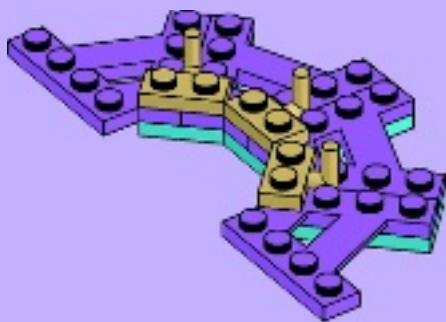

6x

6

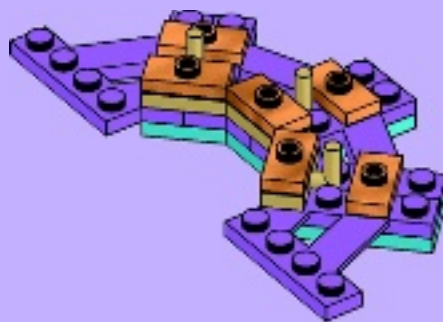



3x

7

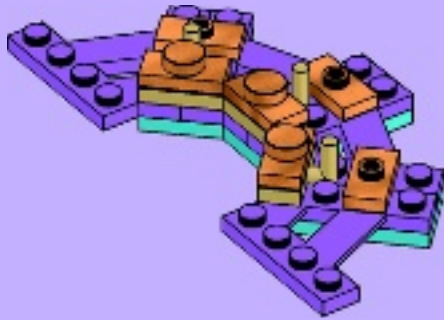

3x

8





1x

9

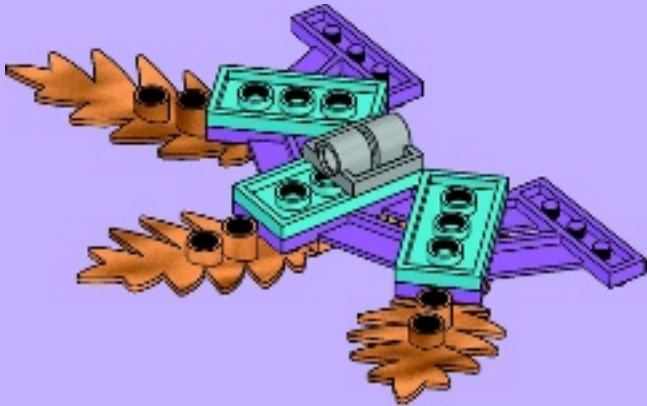

10

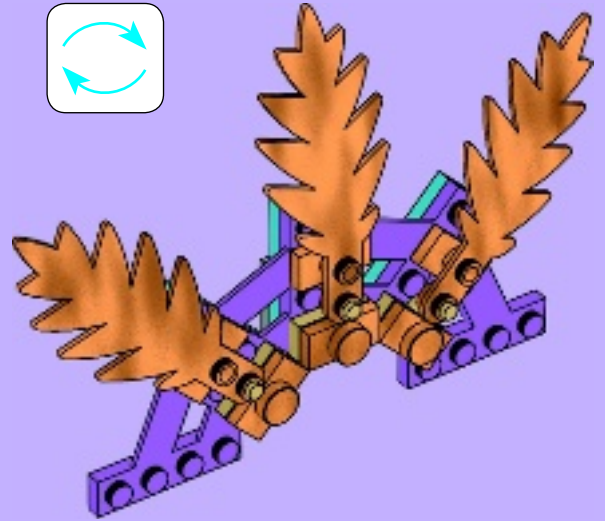
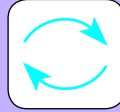

21



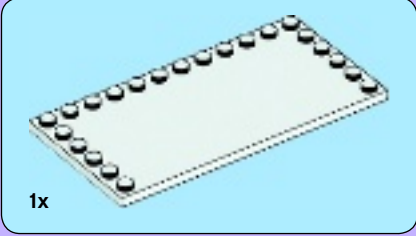

1

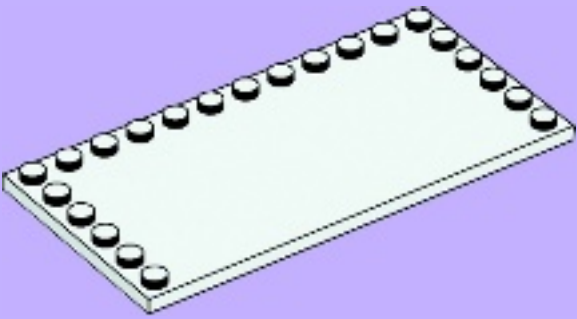

2



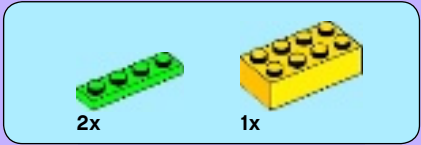

3

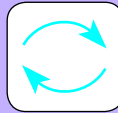
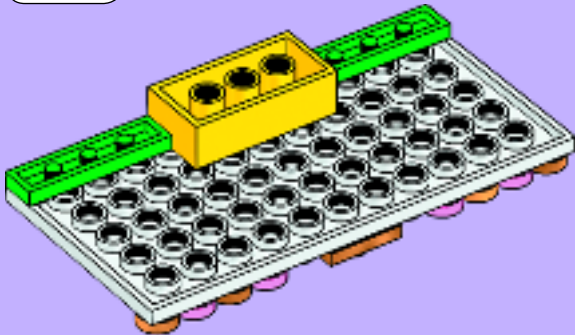
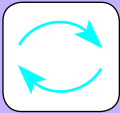

22





2x

23

1



2





24





5x

25



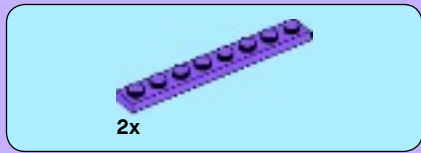

26





4x

27



28



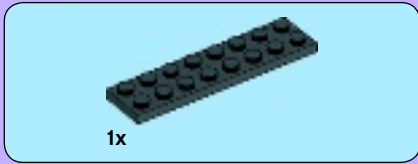
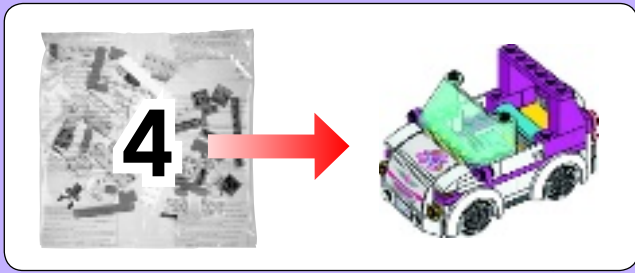

1

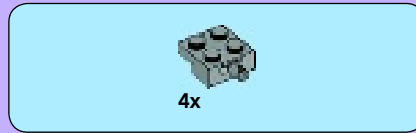
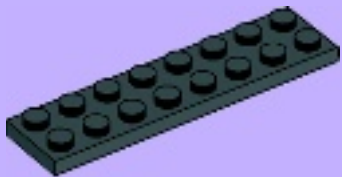

2

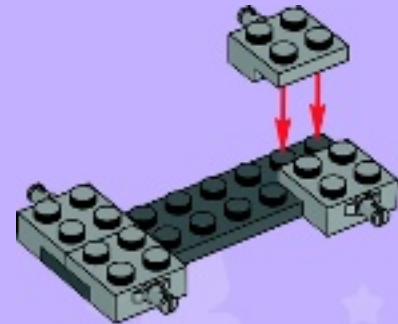



2x

3

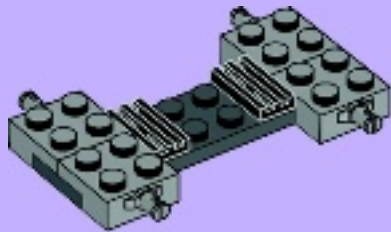

2x



1x

4

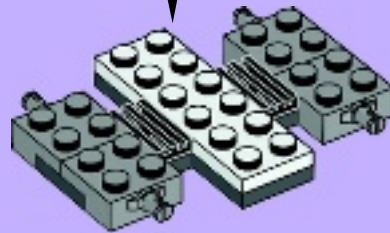
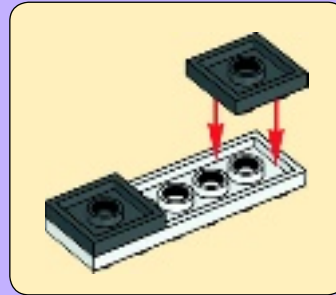

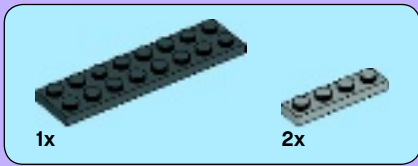

5

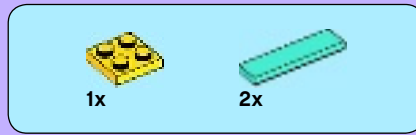
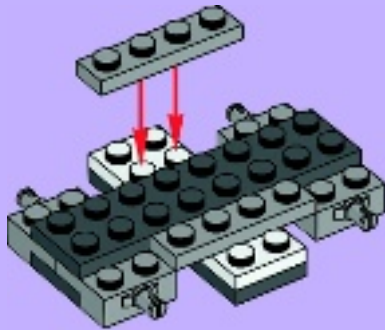

6





2x

7



1x



1x

8





4x

9



4x

10

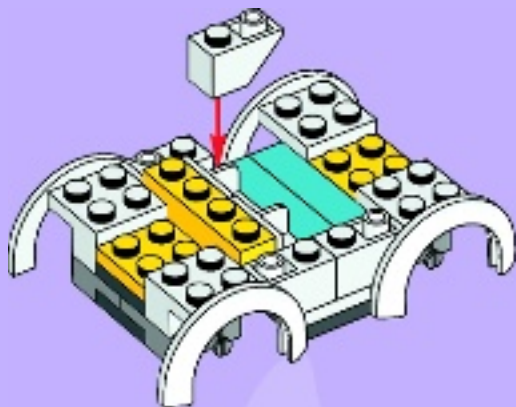



11

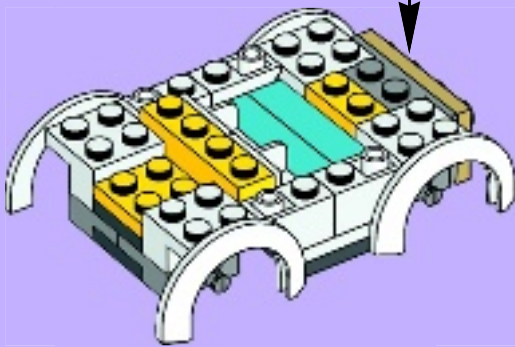



1x

1

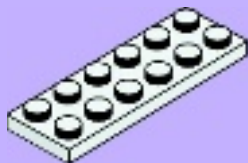

2x



1x

2



2x

3



1x



2x

4



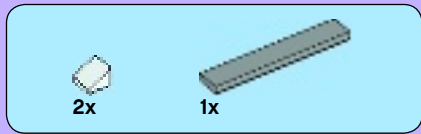

5

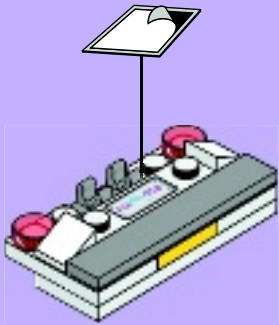

12

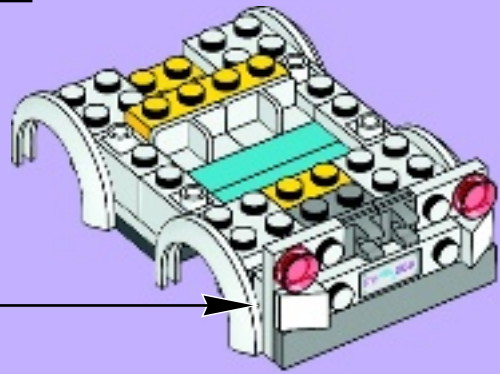
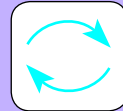

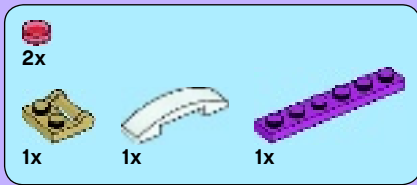

13

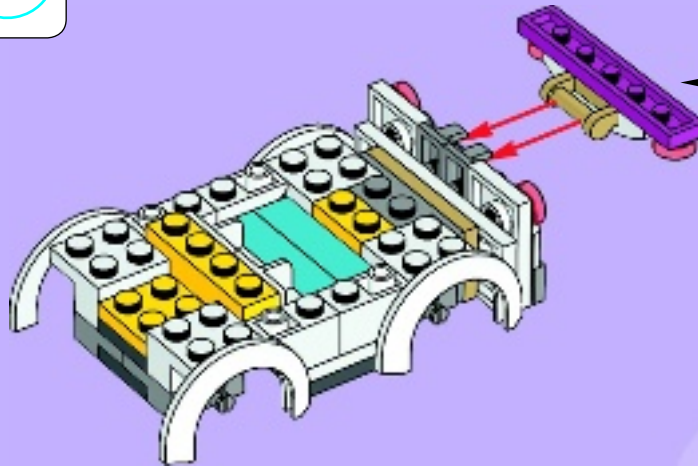
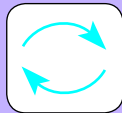
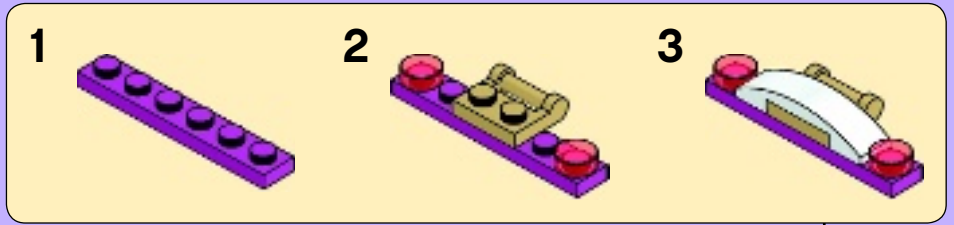

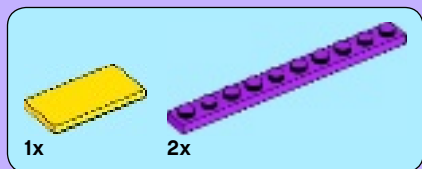

14

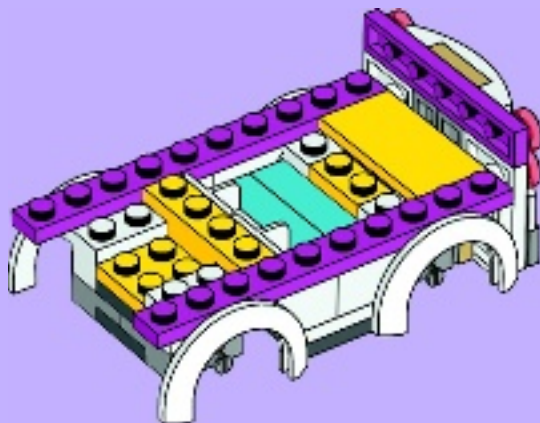



15

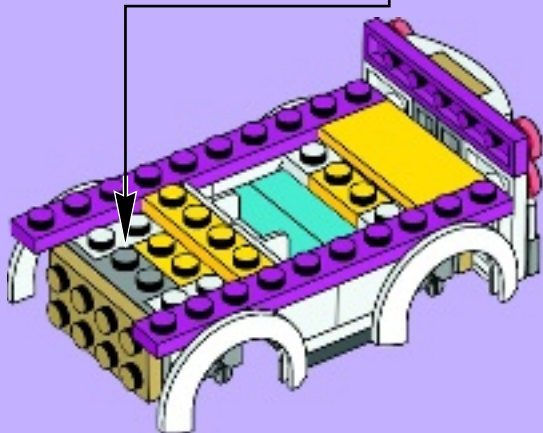

16

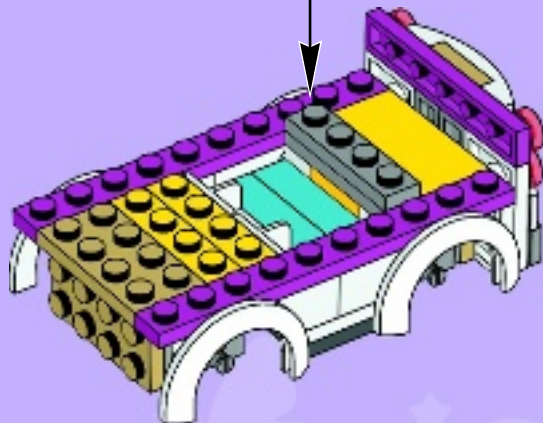
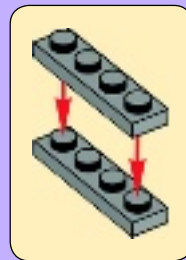



2x

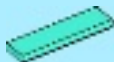

1x



2x

17

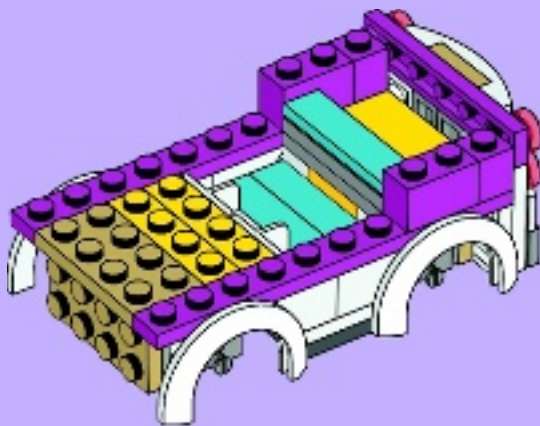



1x



1x

18

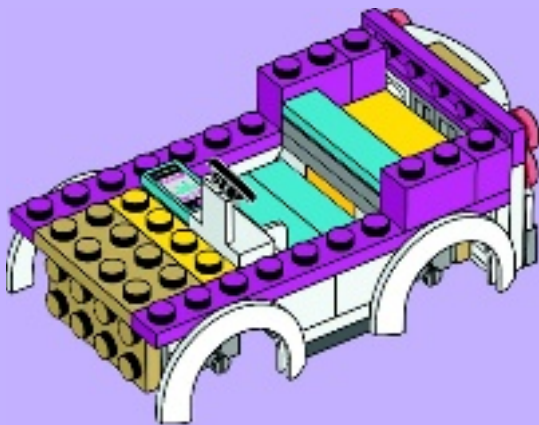

2x



2x



1x



1x

19





20

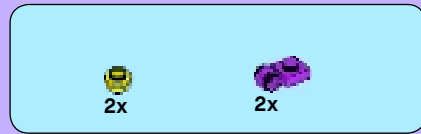
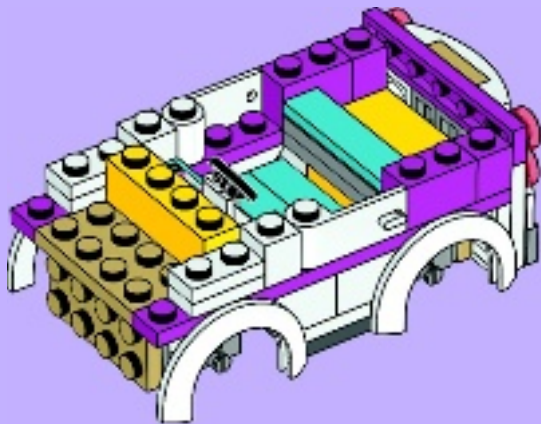

21

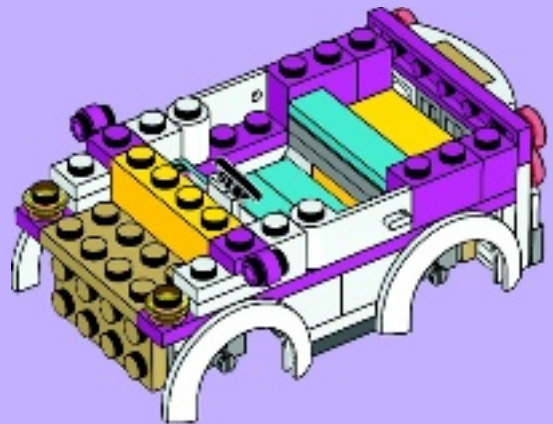



22

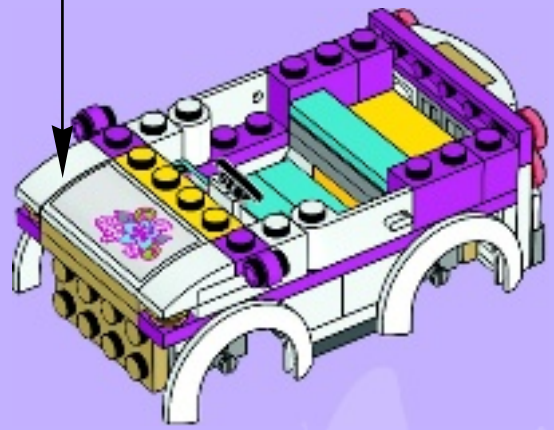
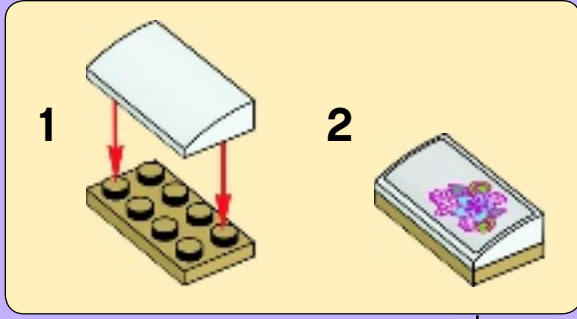

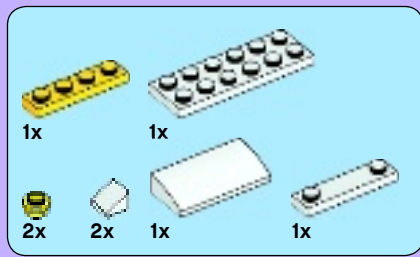

23

1

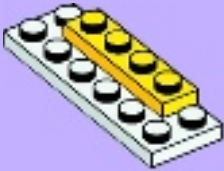

2



3



4



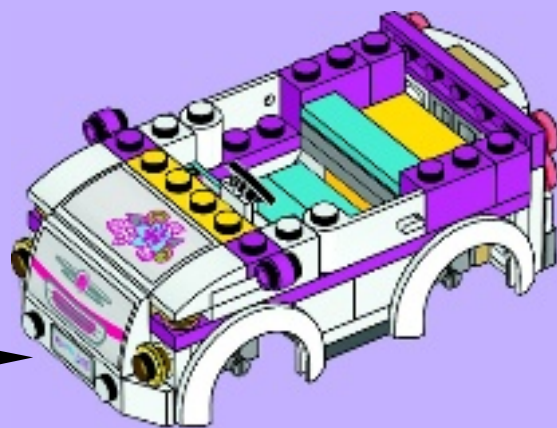



2x

24

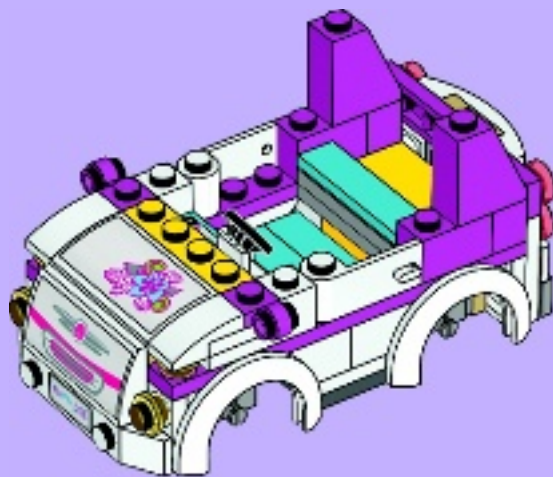

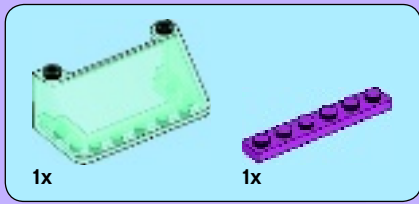

25

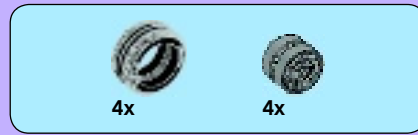
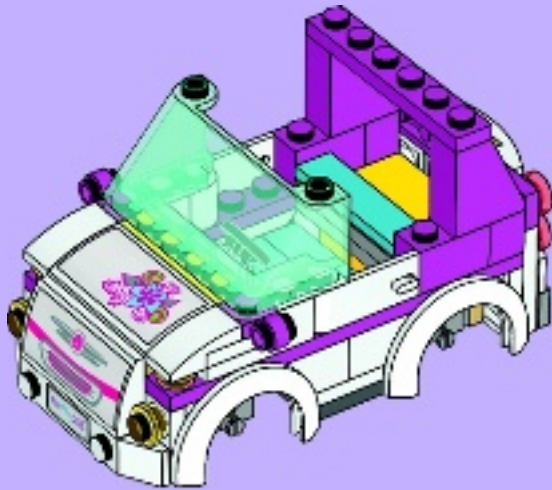

26

