



Friends



41058



1



2



3



4



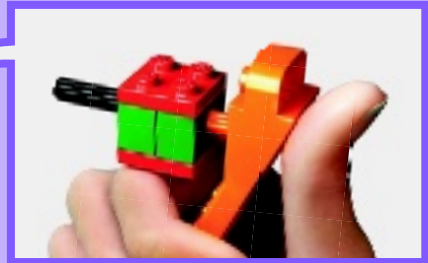

LEGO.com/brickseparator







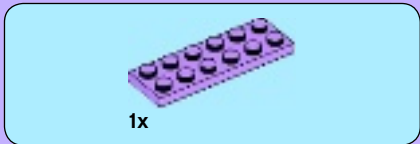

1

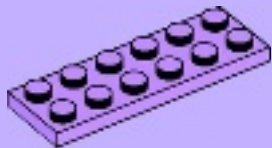

2

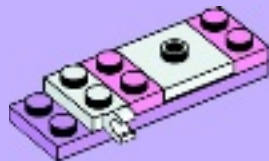



2x

3

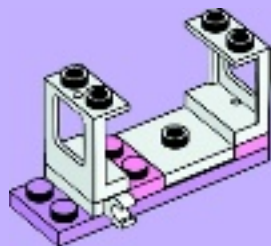

1x



1x

4

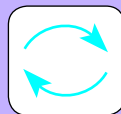



2x



2x

5

1

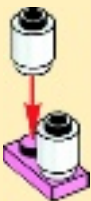

2

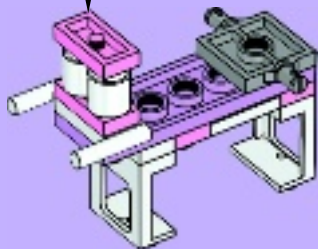

8



2x

6

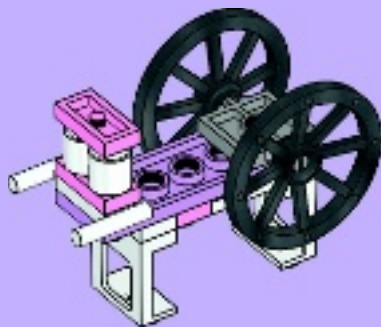



1x



1x



1x

7

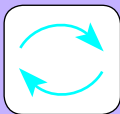

1x

1

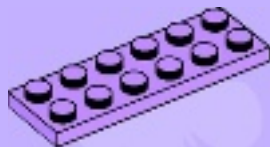



2

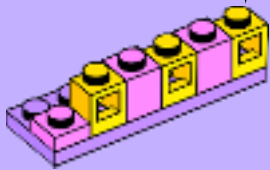

3

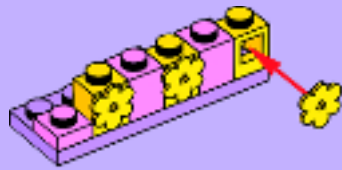



1x



1x



1x



1x

4

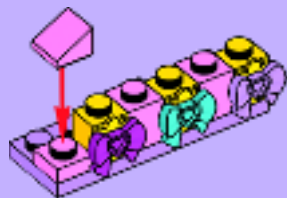

8

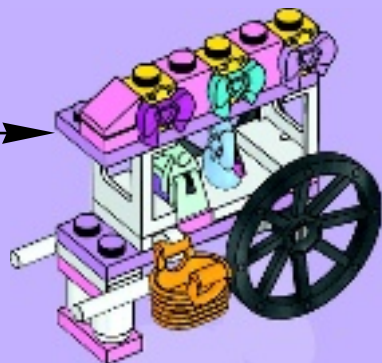

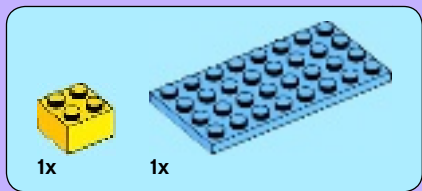

1



2

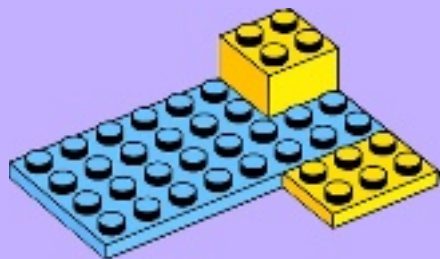



2x

3

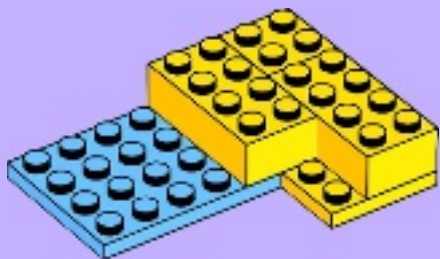

1x

4

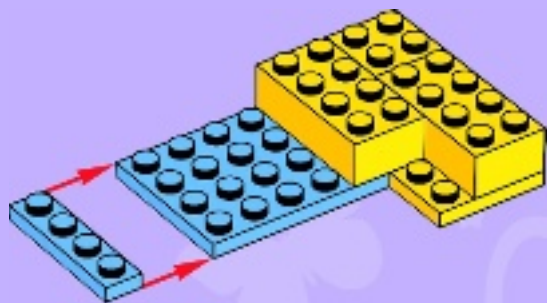

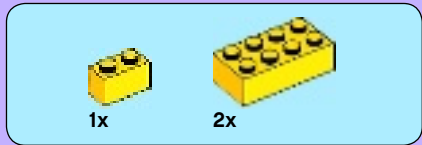

5

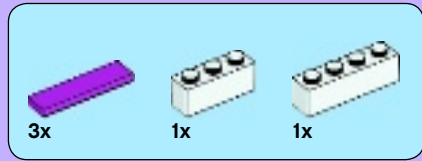
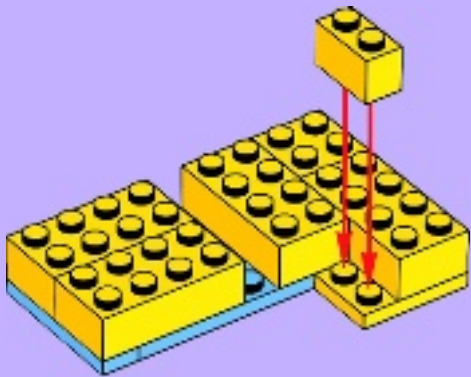

6

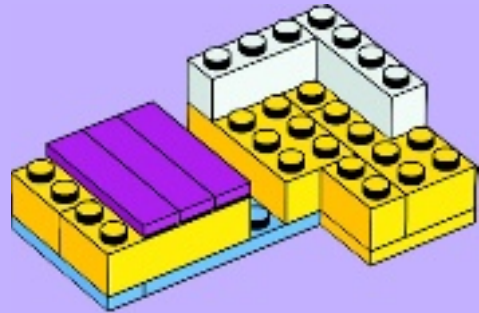

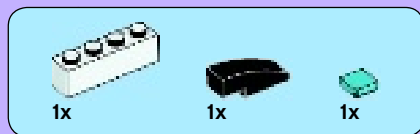

7

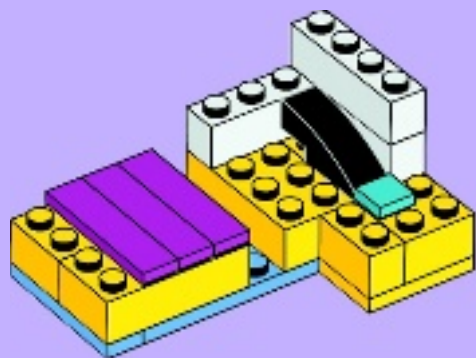

8

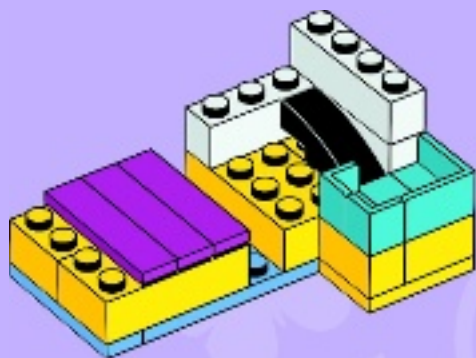



1x



1x

9

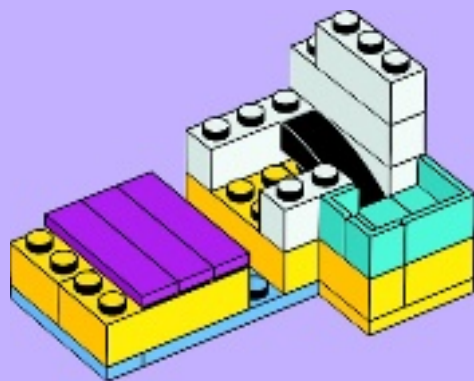



10

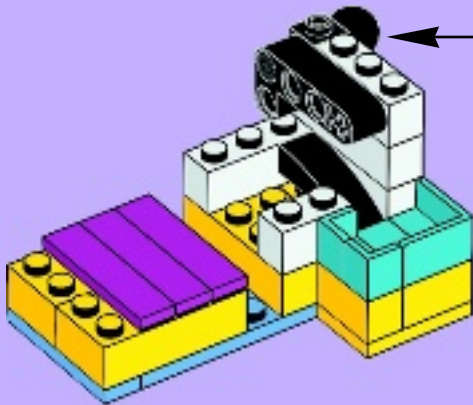
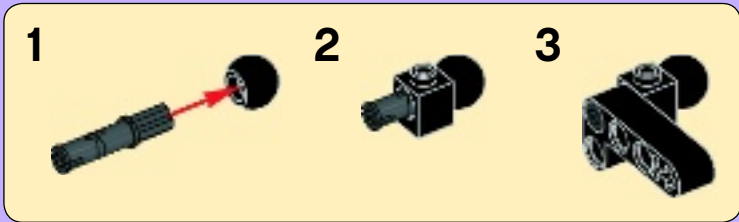



11

1



2

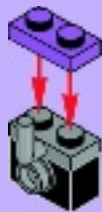

3



4



5





1x



1x

12

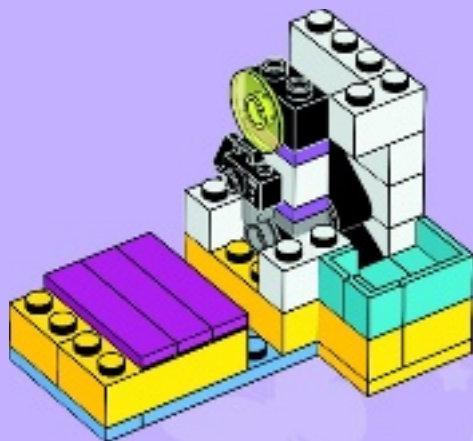
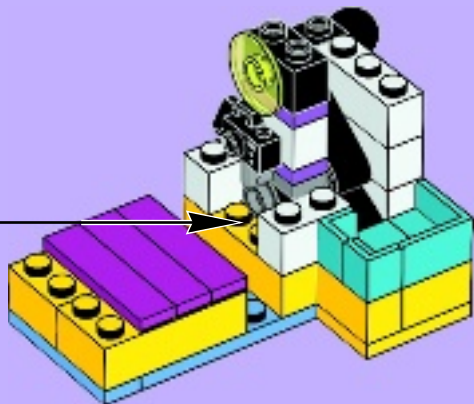



13



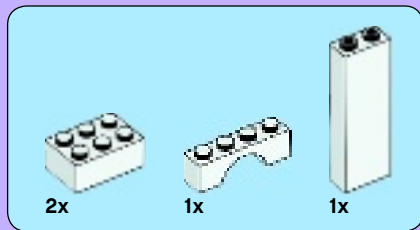

14

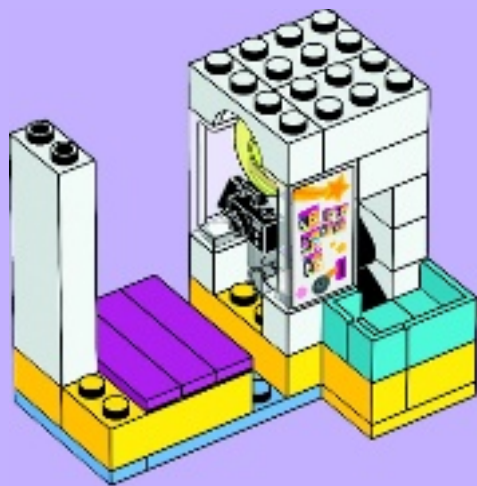

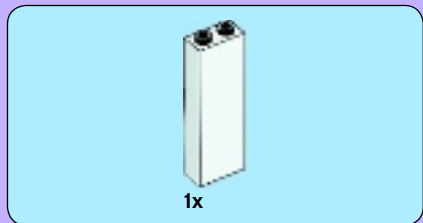

15

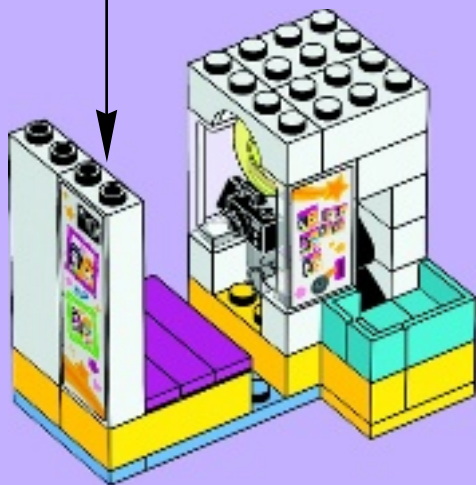
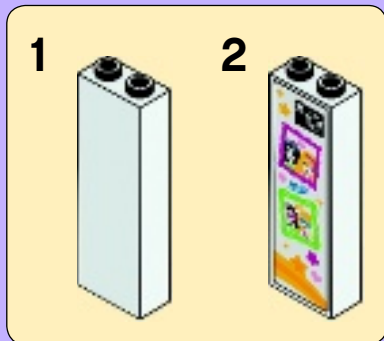



16

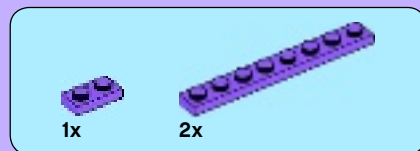

17





1x

18

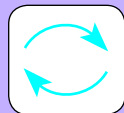
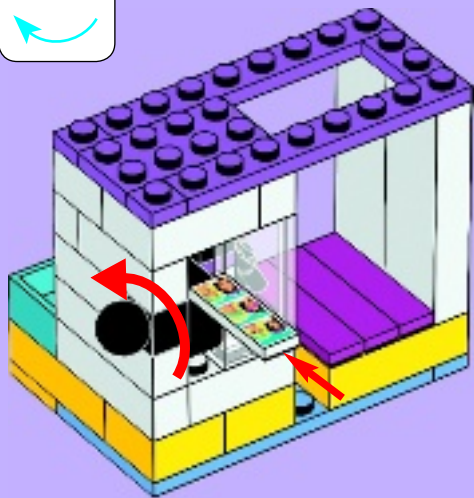
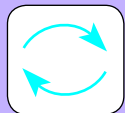

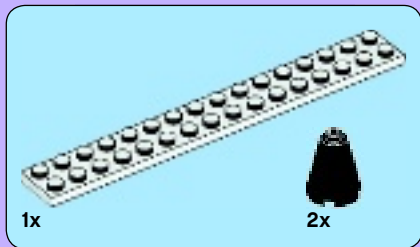

1

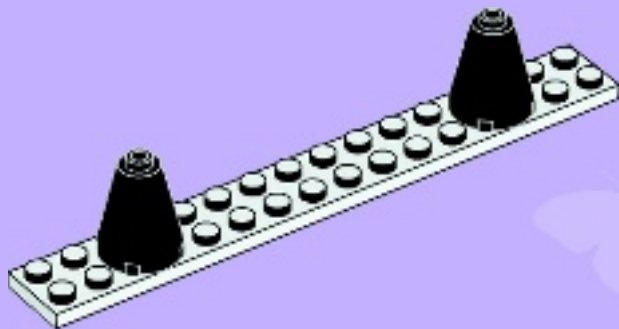

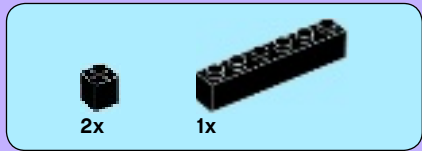

2

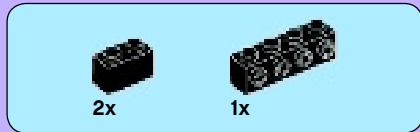
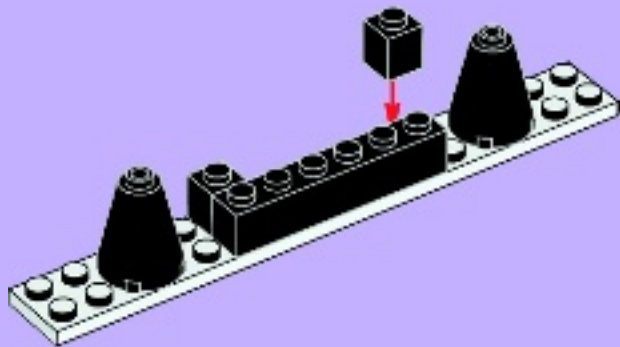

3

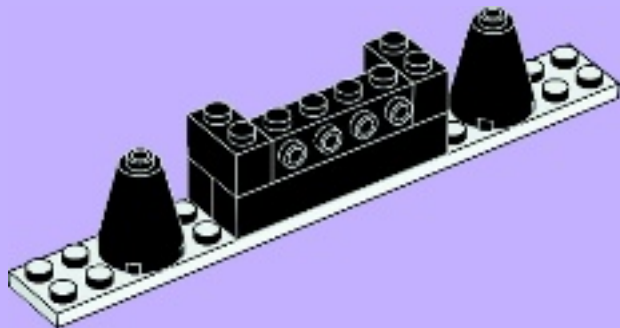

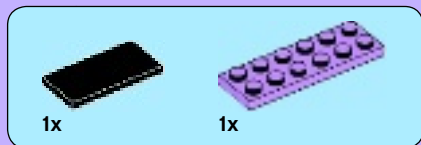

4

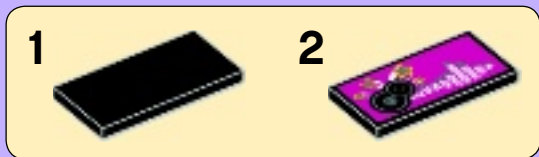

5





6

1



2



3



4



2x

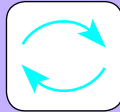



1x

7

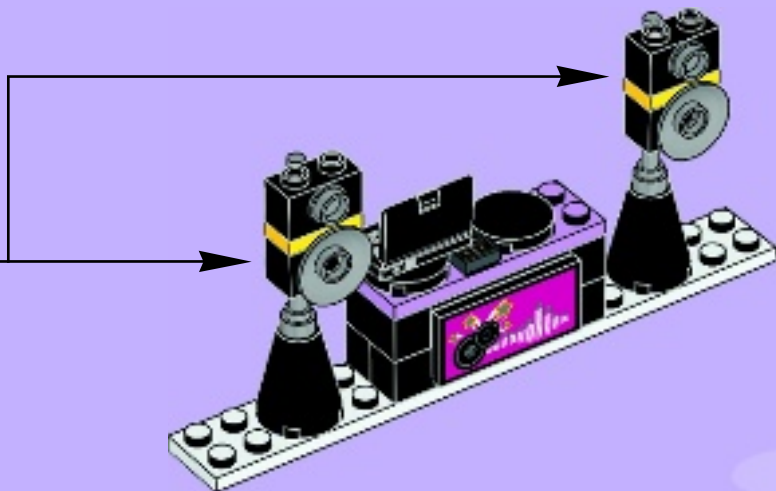

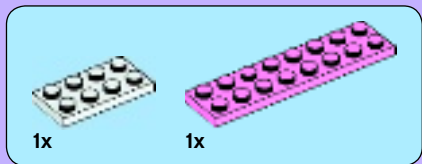

1

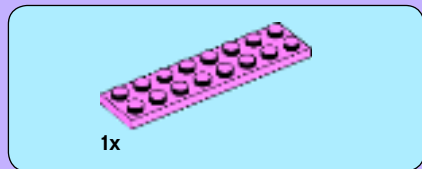
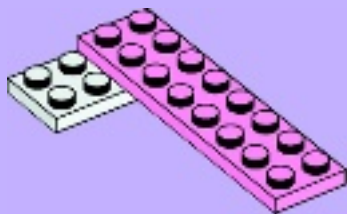

2





3

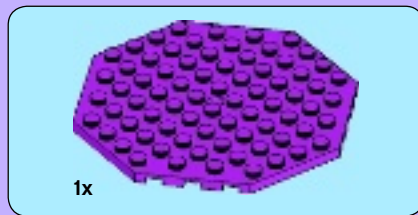
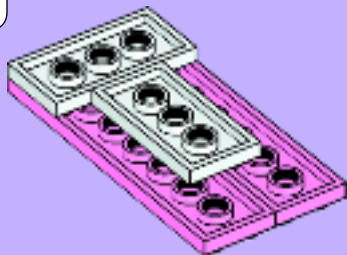
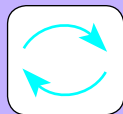

4

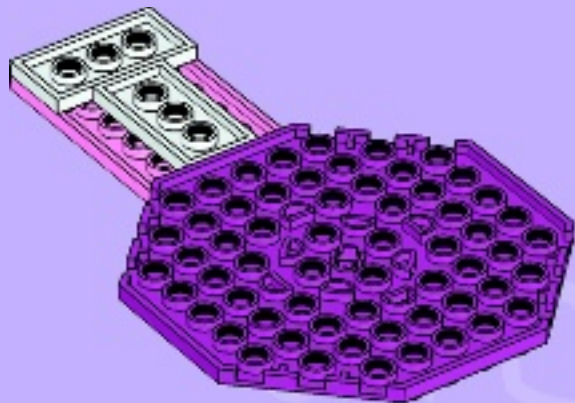

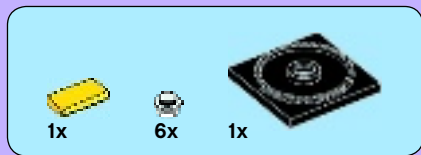

5

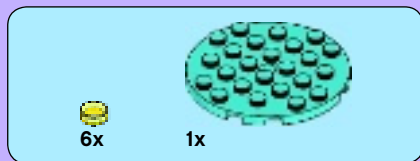
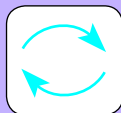

6

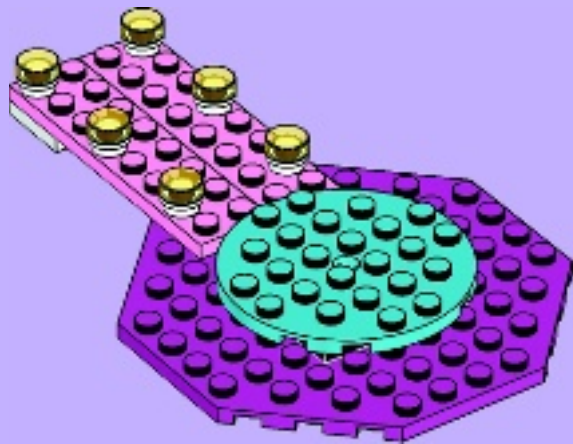

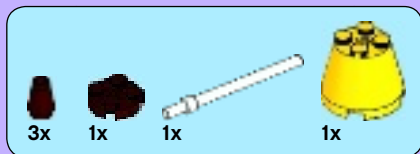

1

1



2



3





2

1



2



3



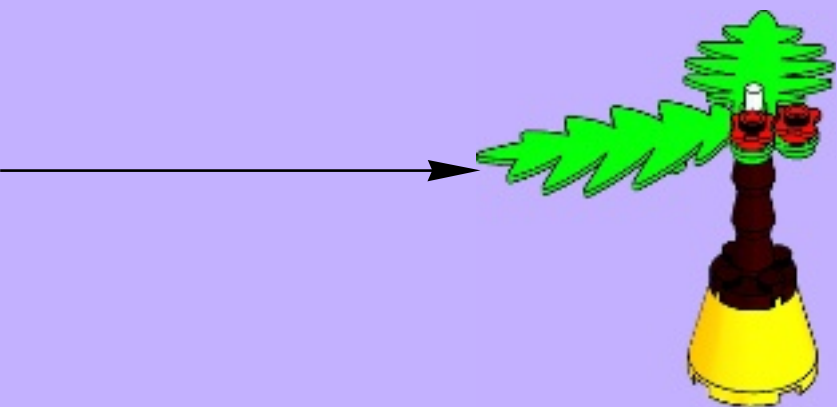

2x





1x



1x

1

1

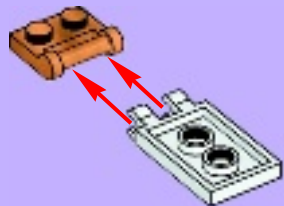

2



1x



1x

2

1

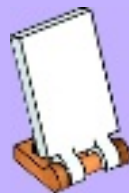

2



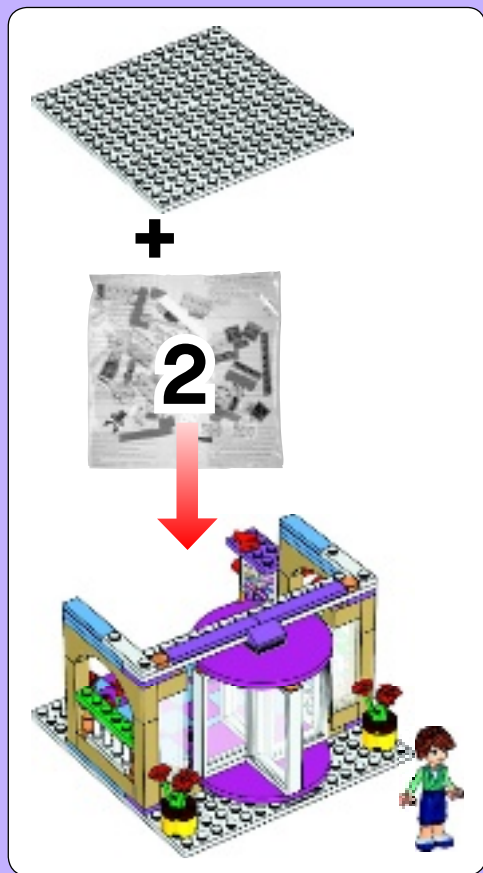



1x

1

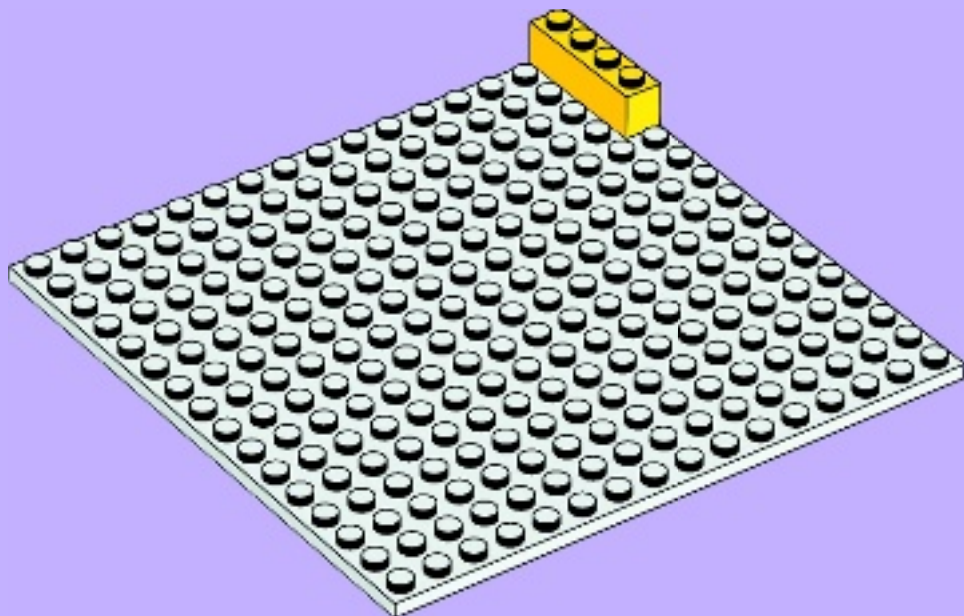



2

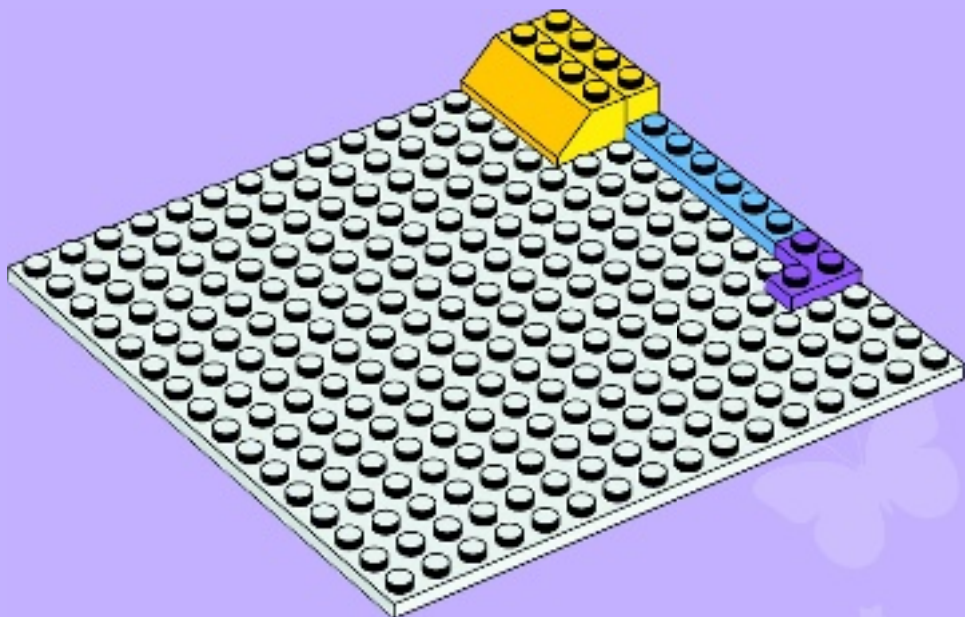



3x



2x



1x

3

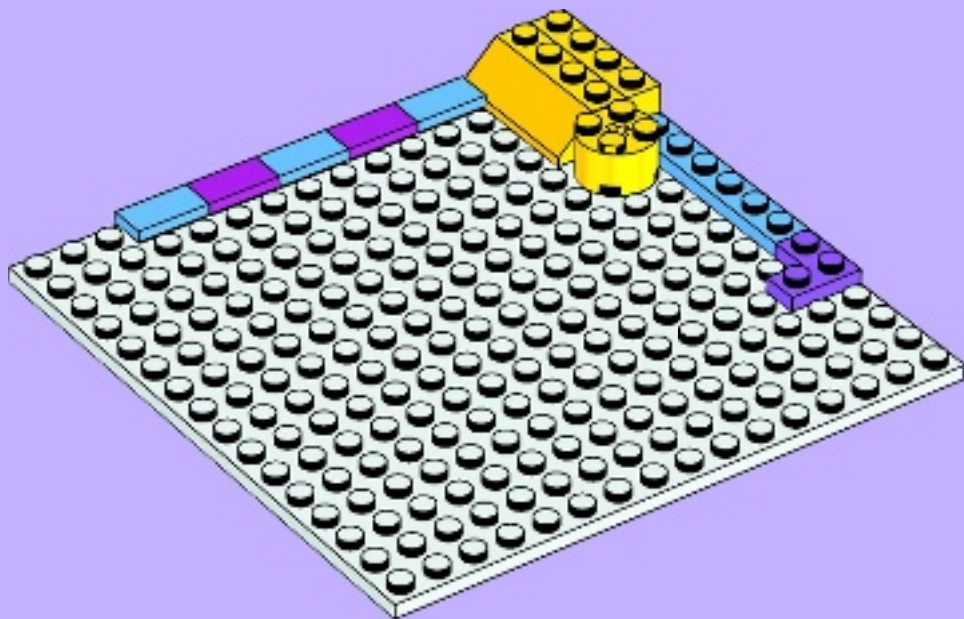



10x



10x

4

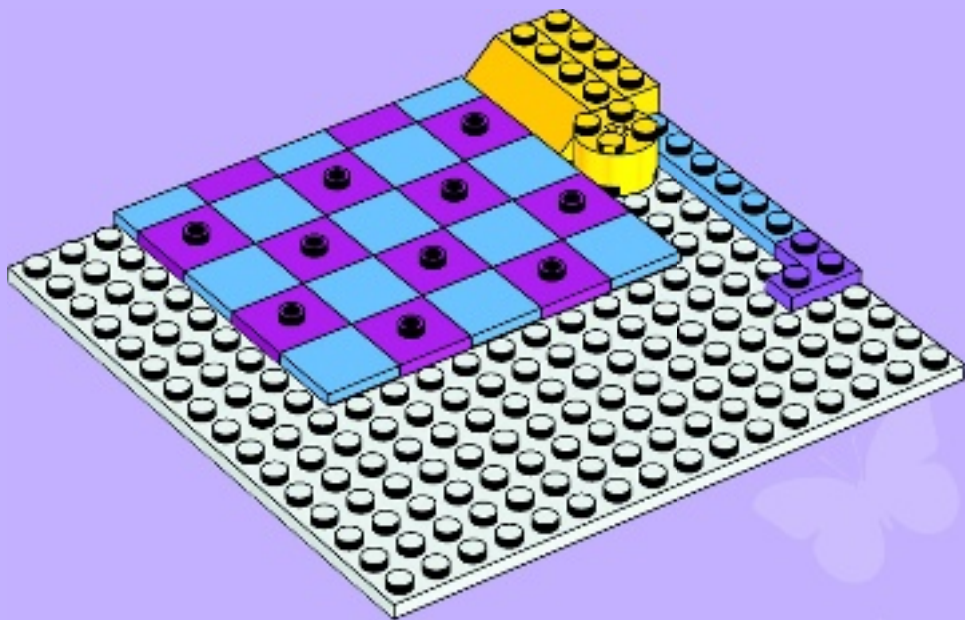

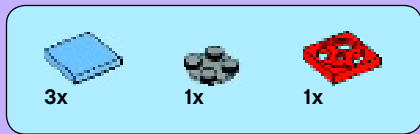

5

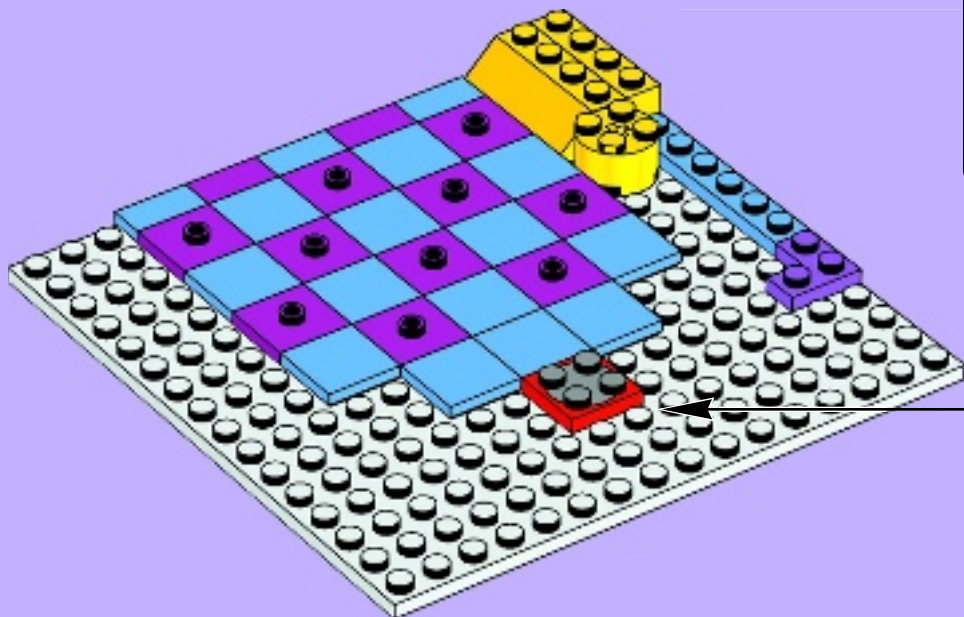



6x



2x

6

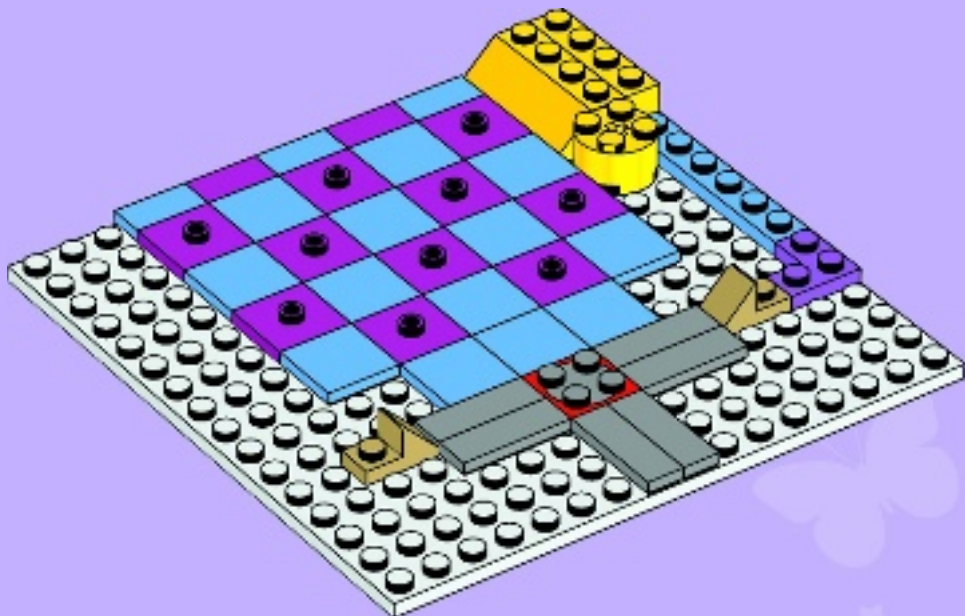

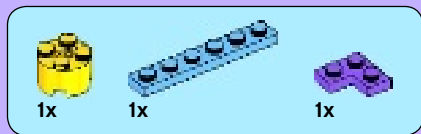

7

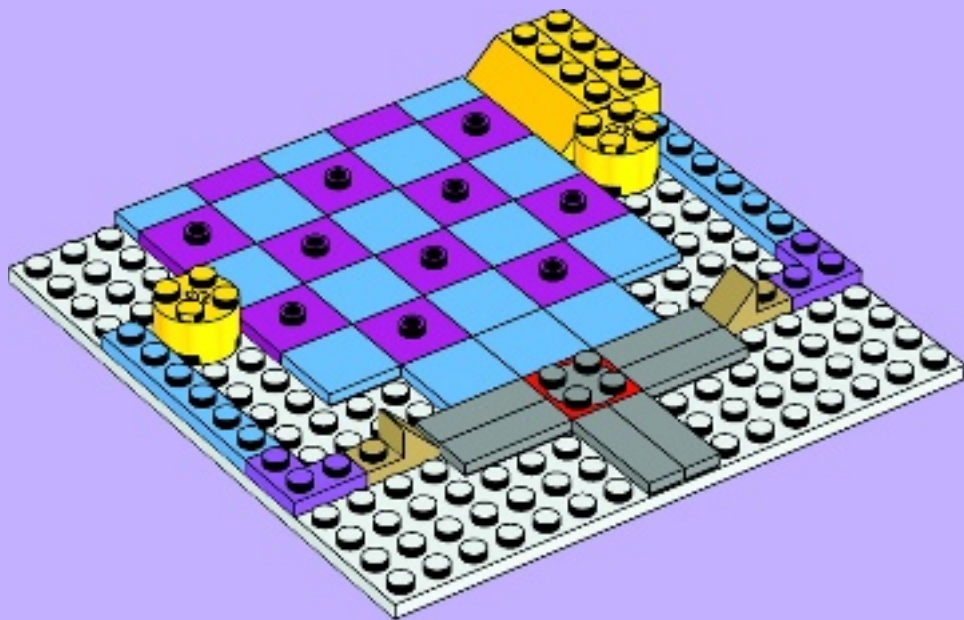



9

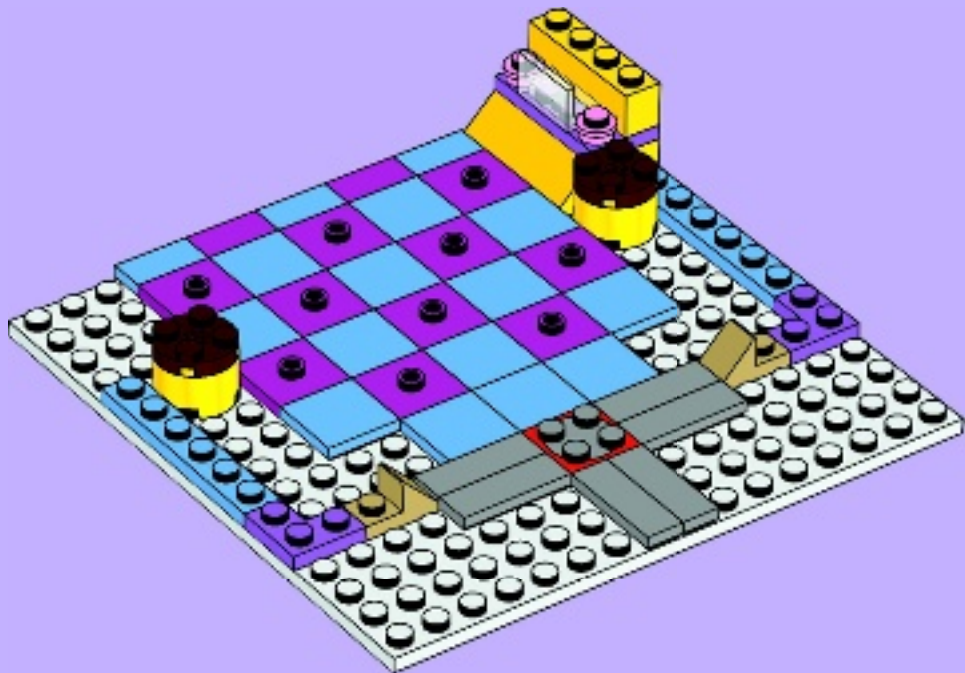

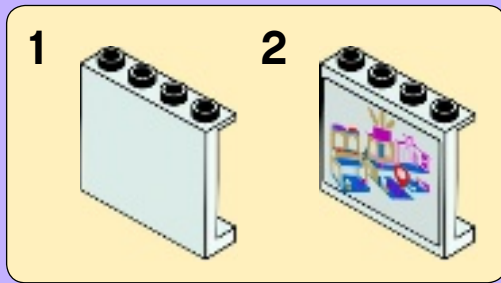
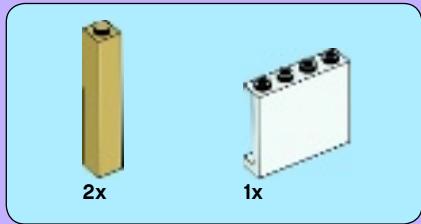

10



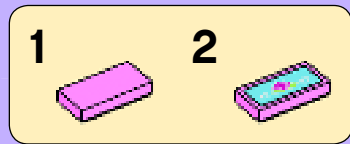
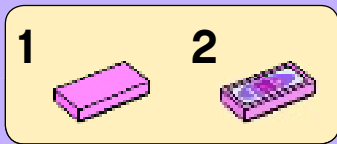
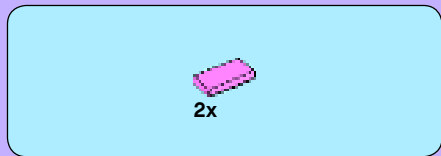

11

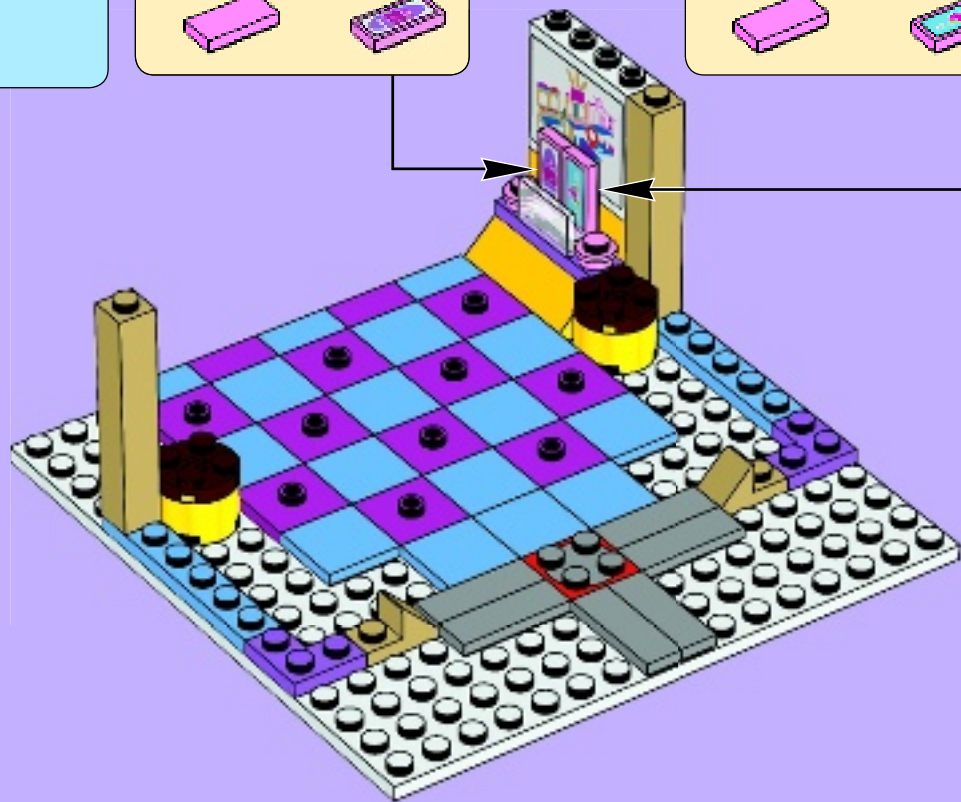

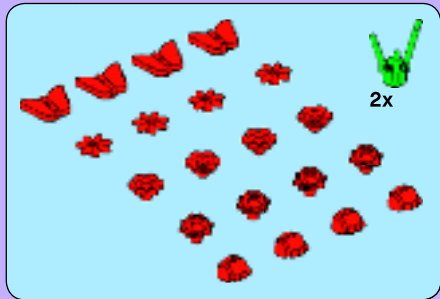

12

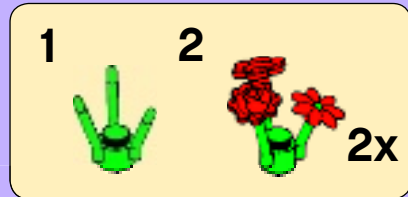

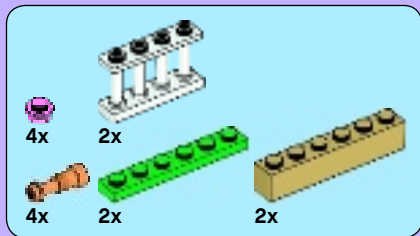

13

1

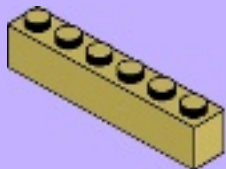

2



3



4



2x

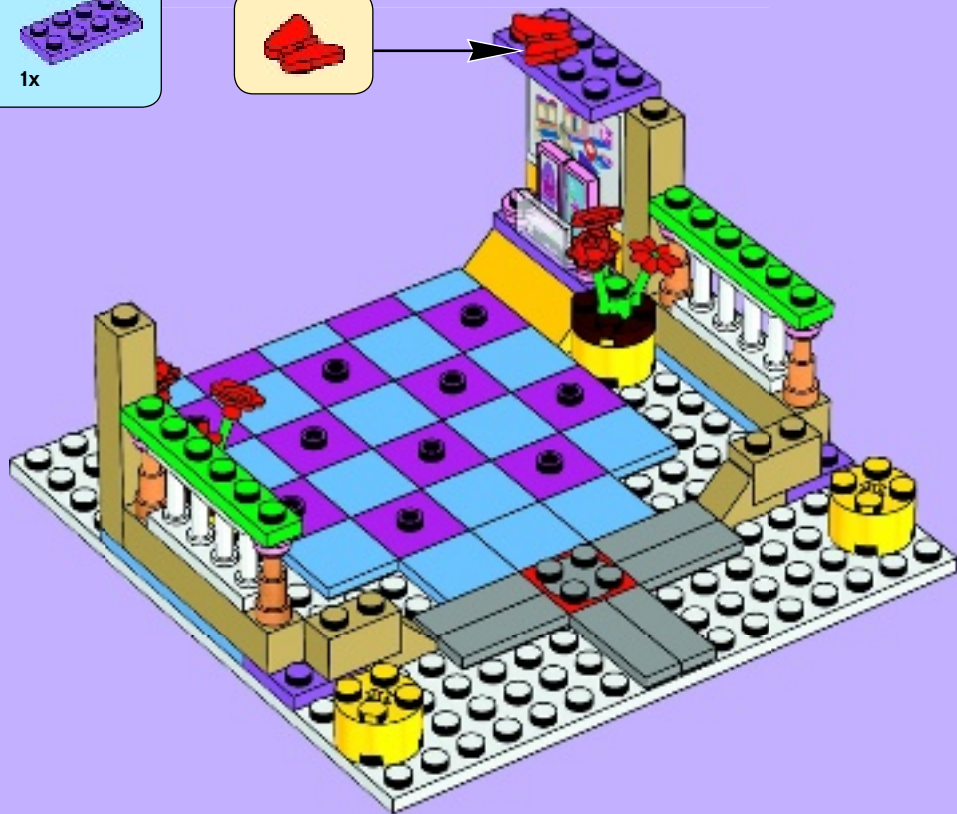
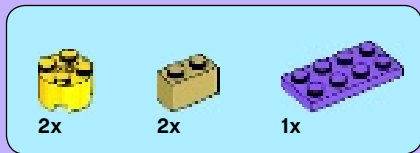

14



15



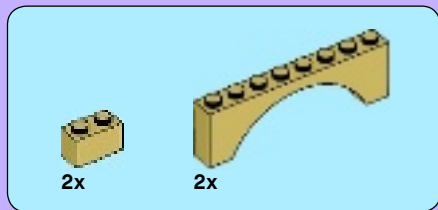

16





17

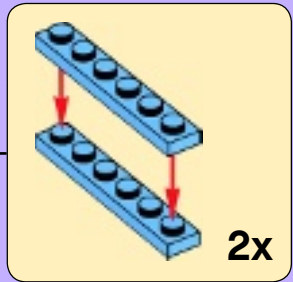
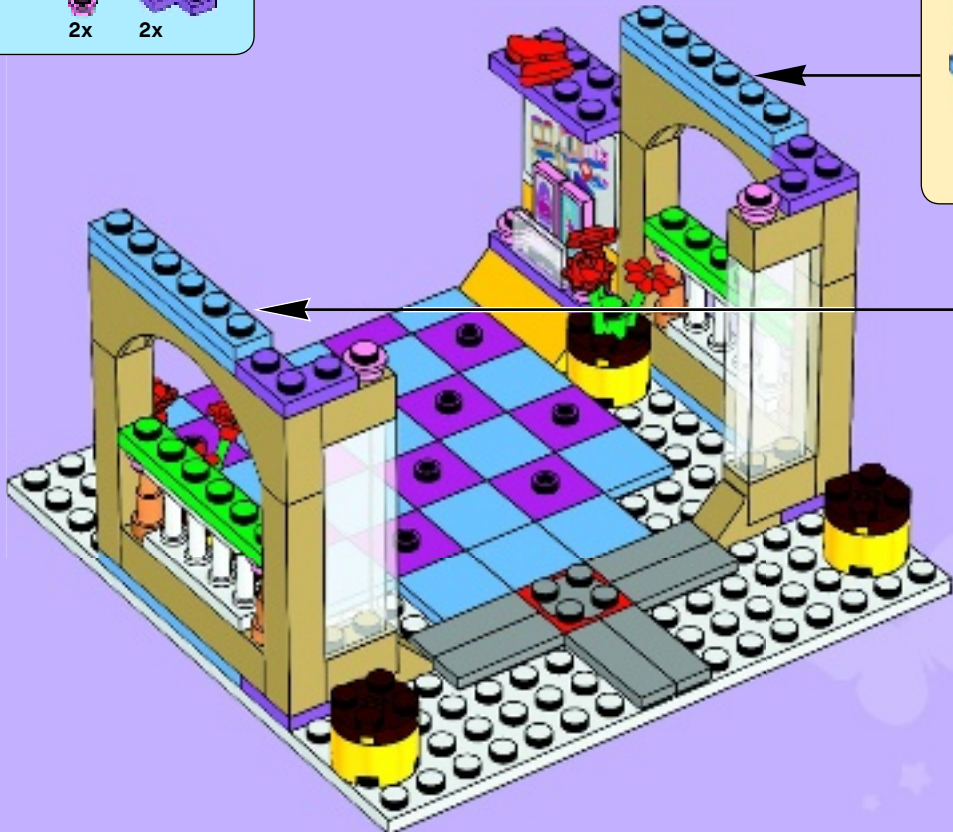

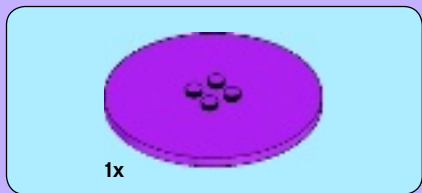

1

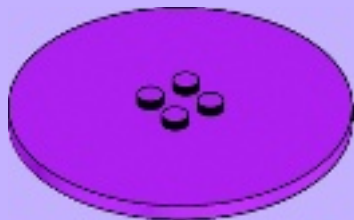

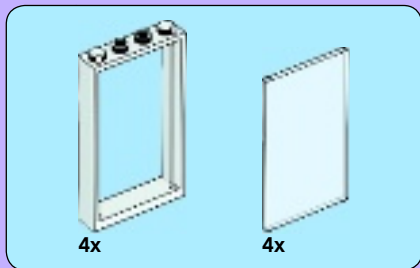

2

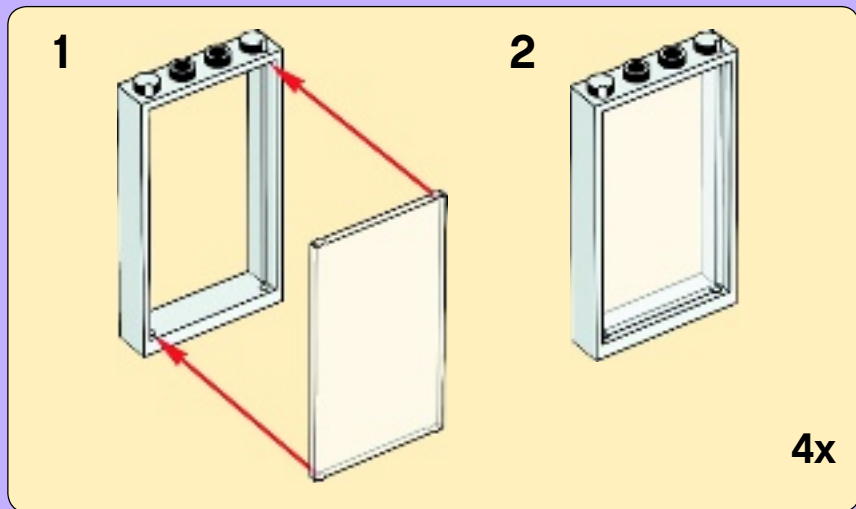

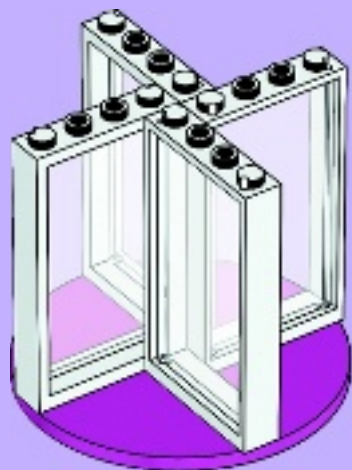

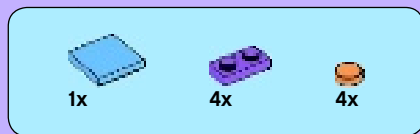

3



4





1x



1x

5



1x

6



18

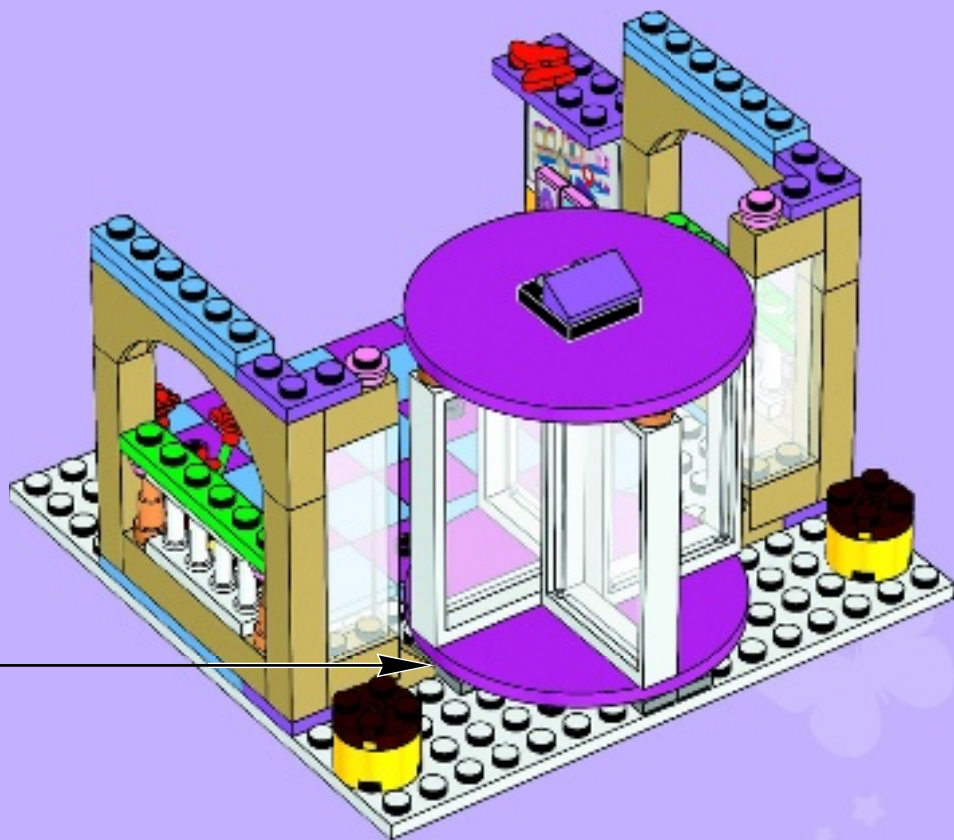

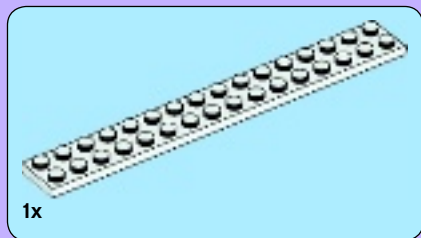

19



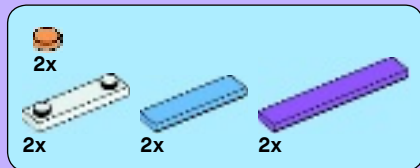

20





2x

21

1



2



2x

