

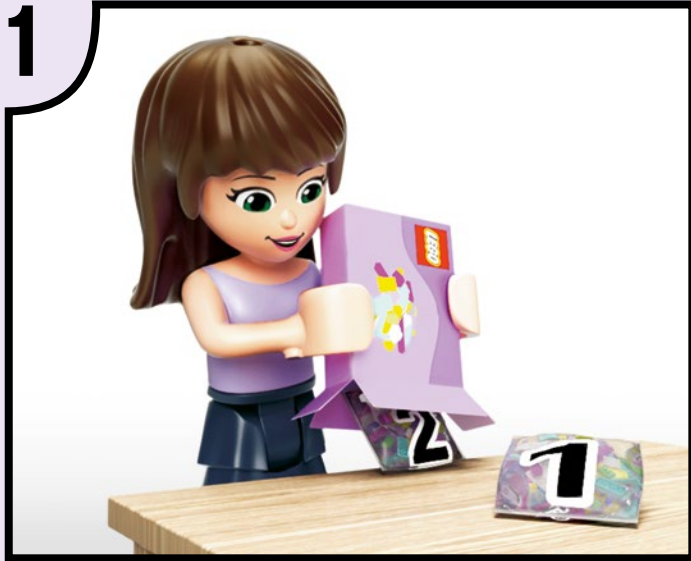

# Friends™

41344





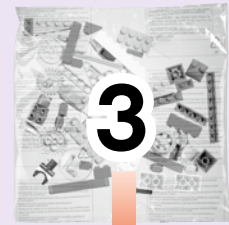
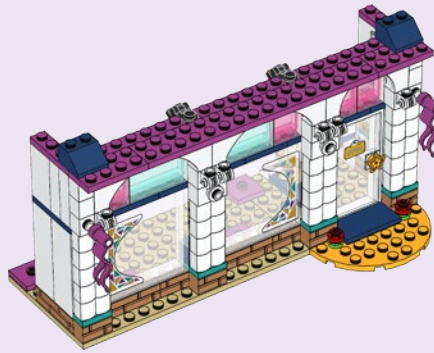
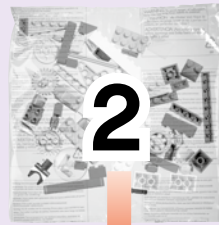

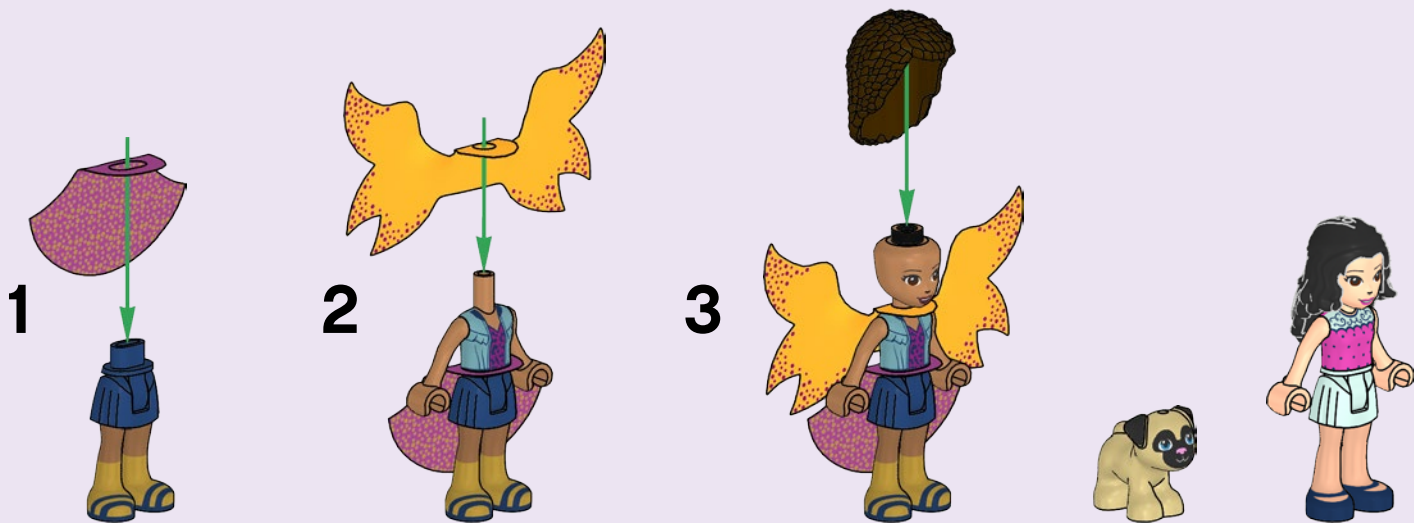
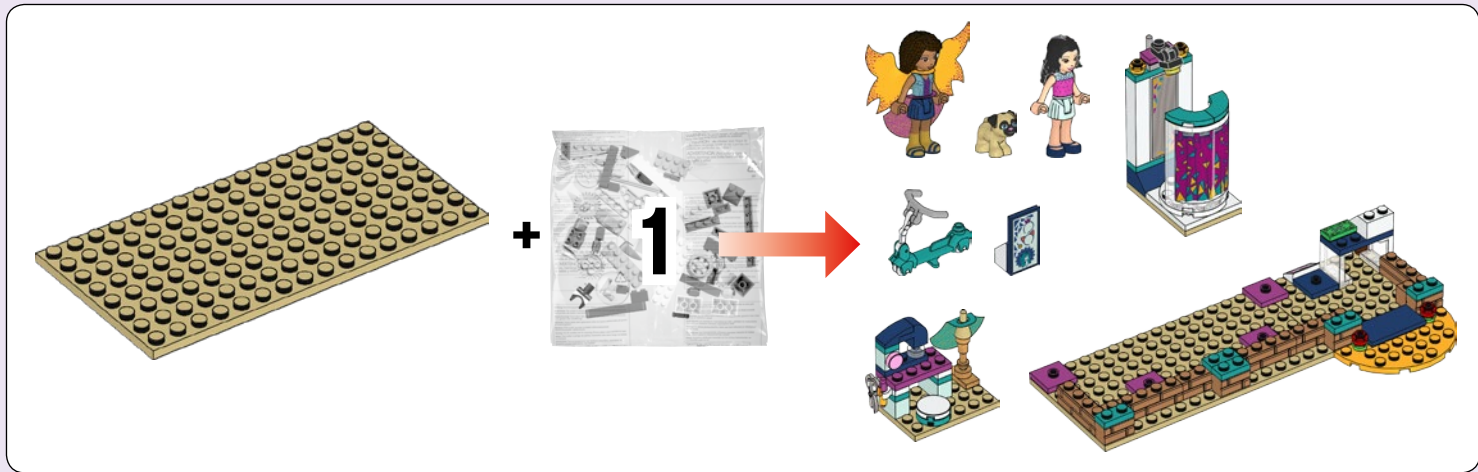

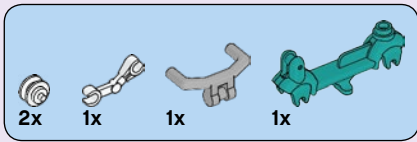

1

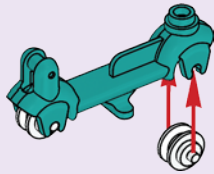

2

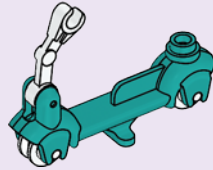

3

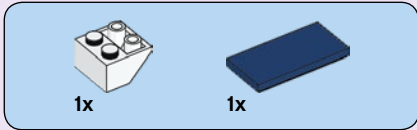
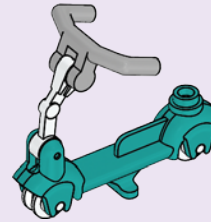

1

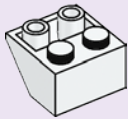

2

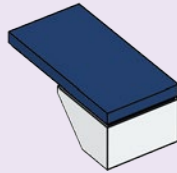

3

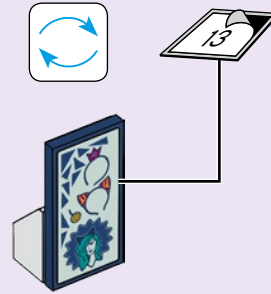

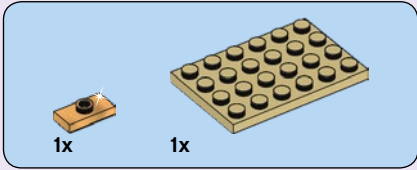

**1**

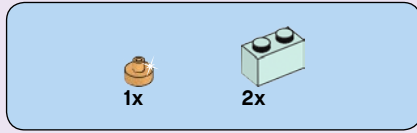
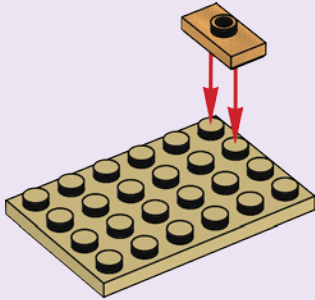

**2**

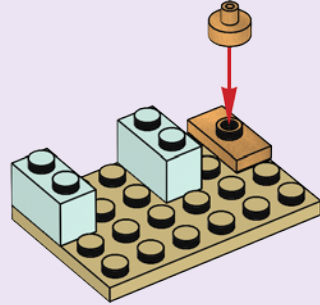

**3**

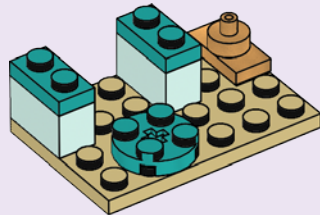



4

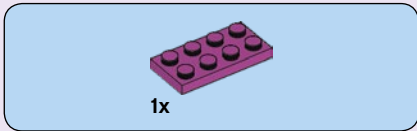
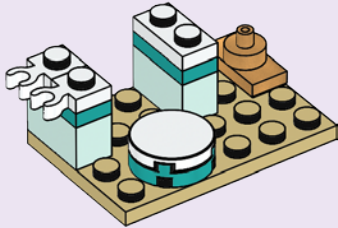

5

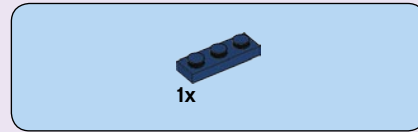
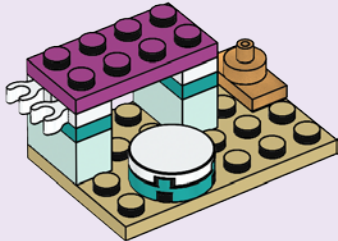

6

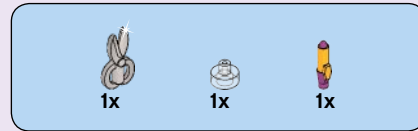
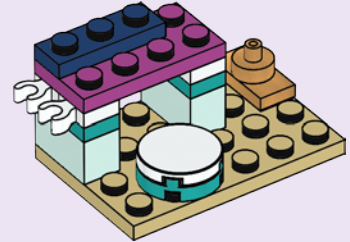

7





8

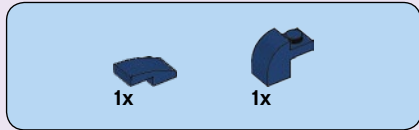
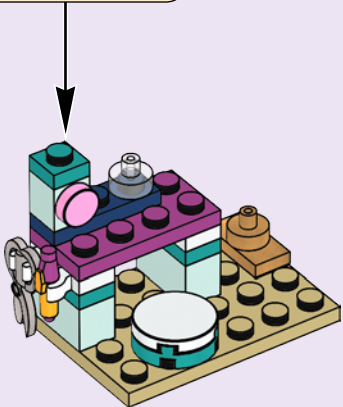
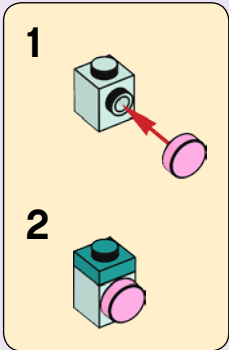

9

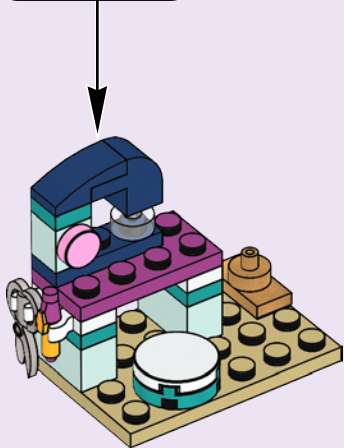
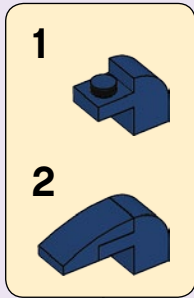





10

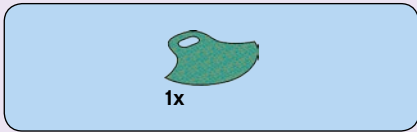
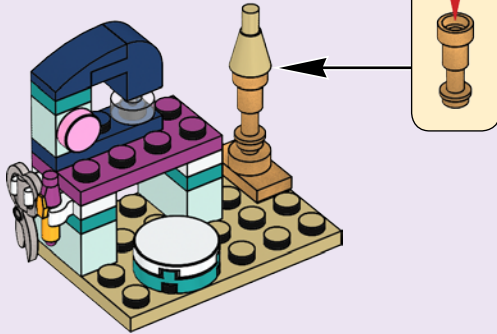

11

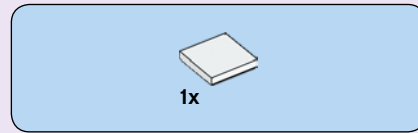

12

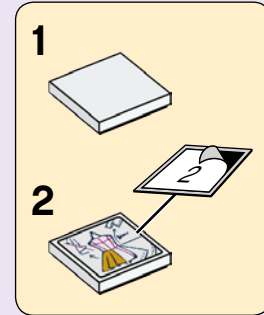

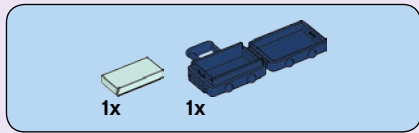

13

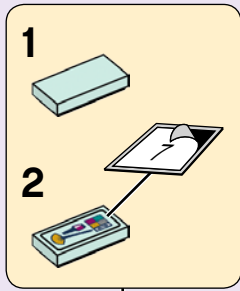

1

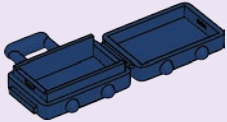

2



3

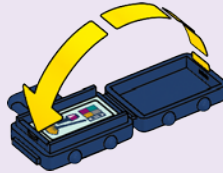

4



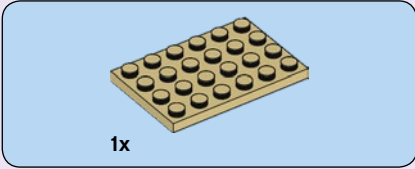
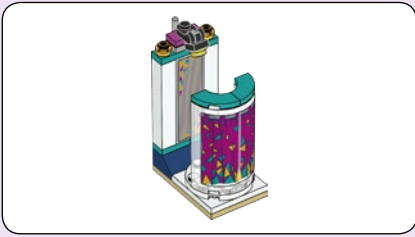

**1**

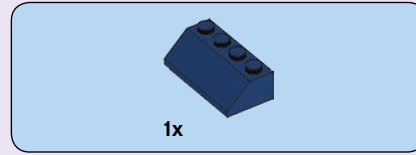
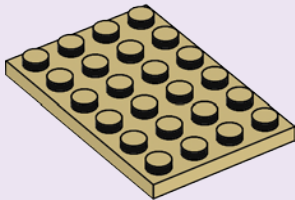

**2**

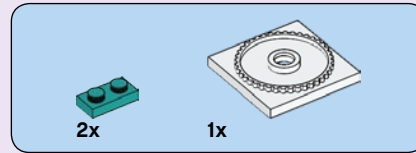
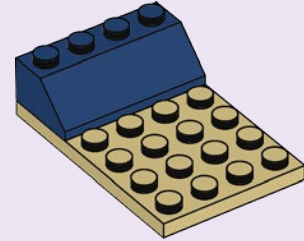

**3**

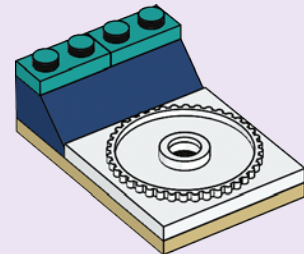

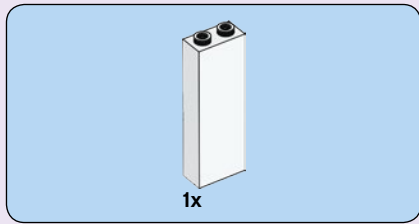

4

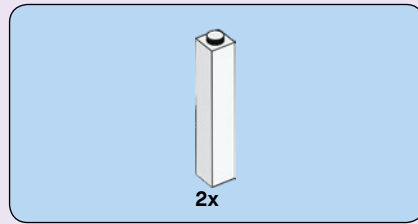
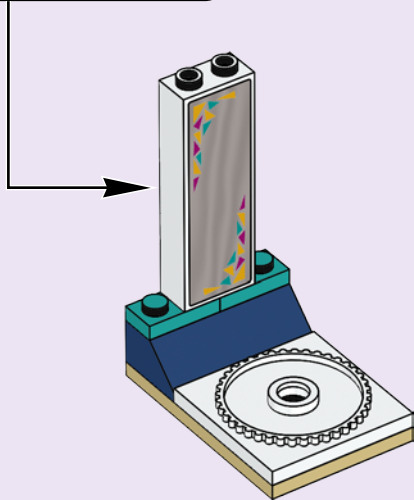
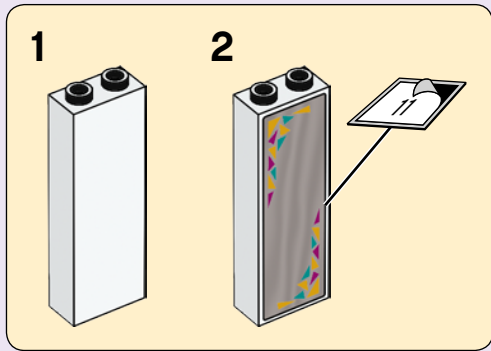

5

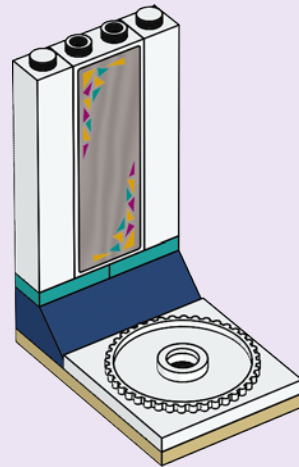



2x

6

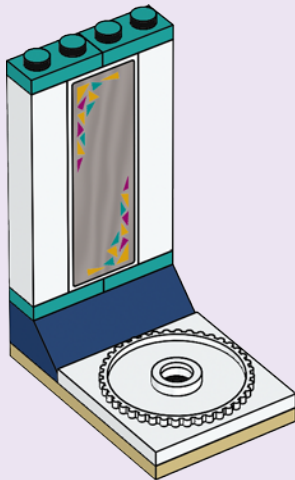

1x

2x

7

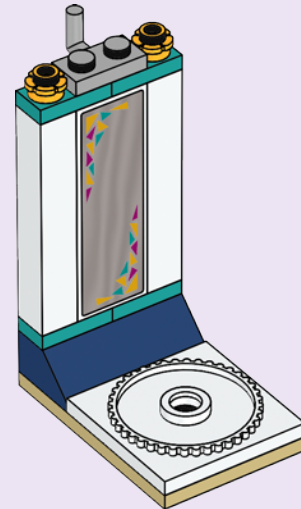

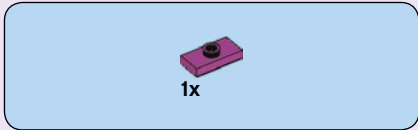

8

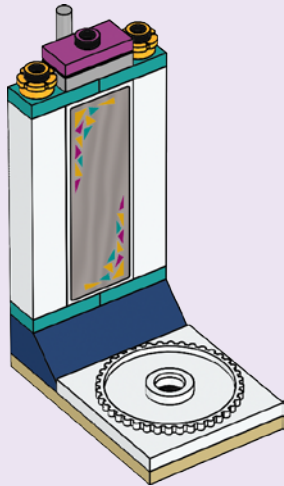

9

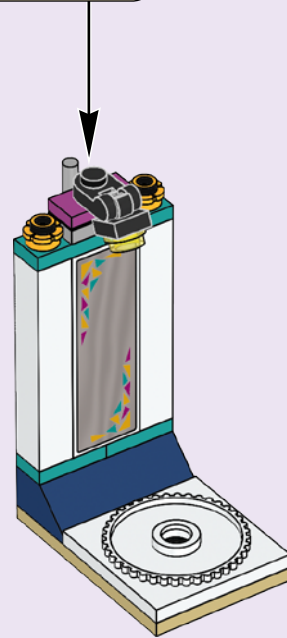
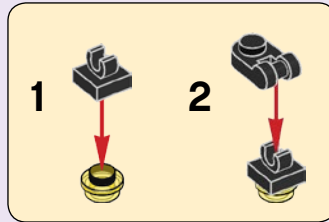

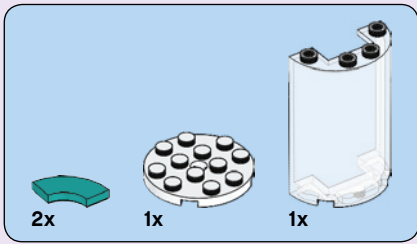

10

1



2



3



4

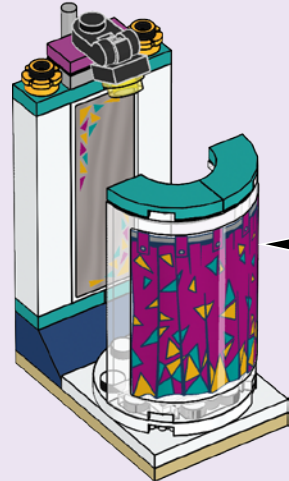
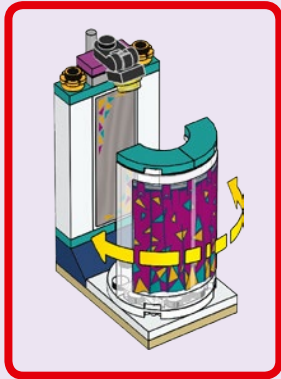

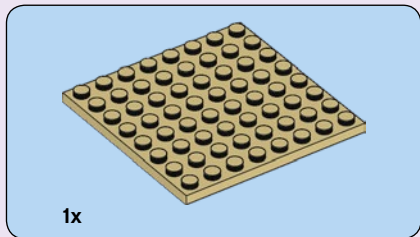

1

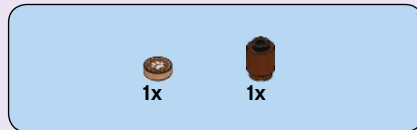
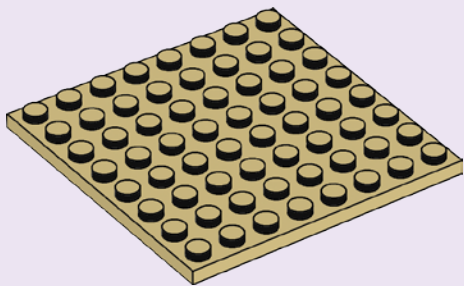

2

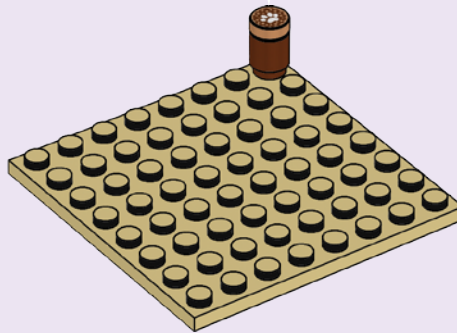
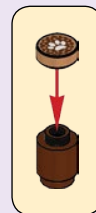



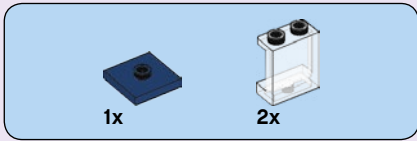

3

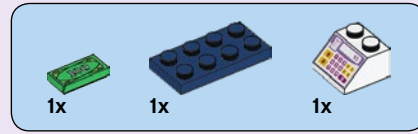

4

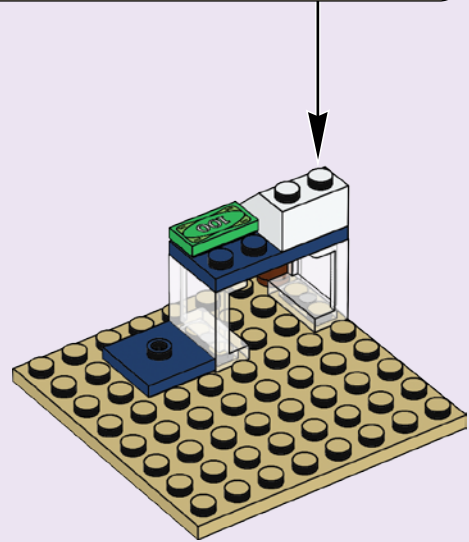
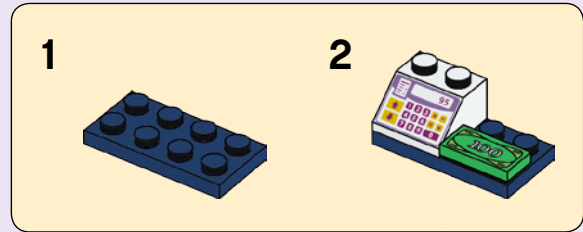

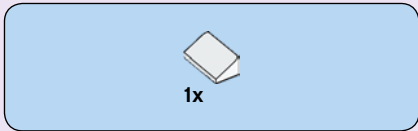

5

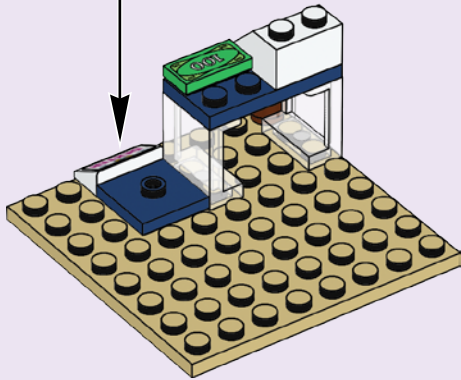
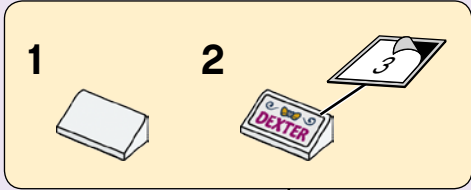

6

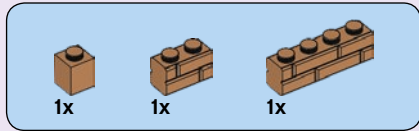
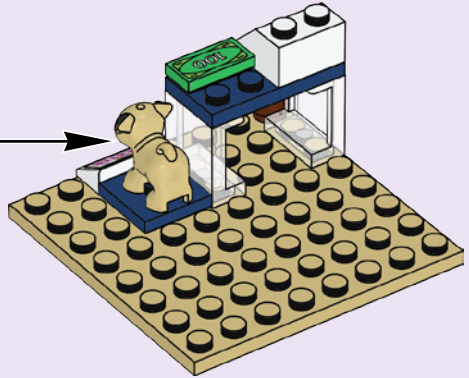

7

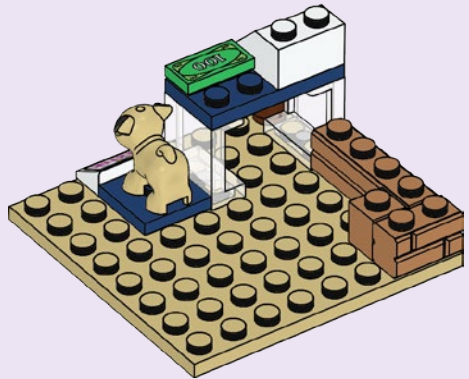

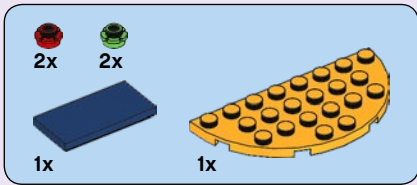

8

1

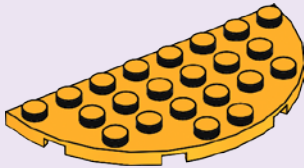

2

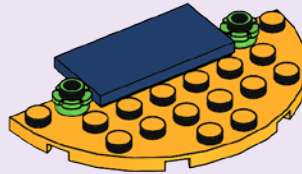

3

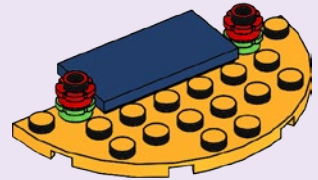

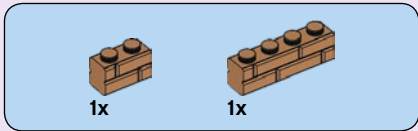

9



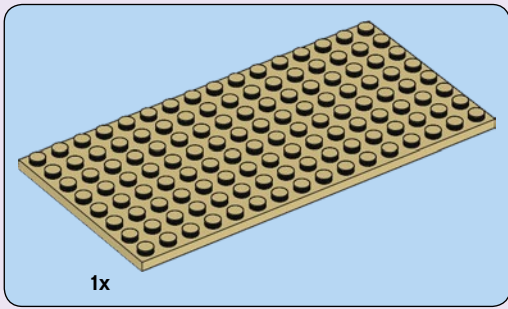

10

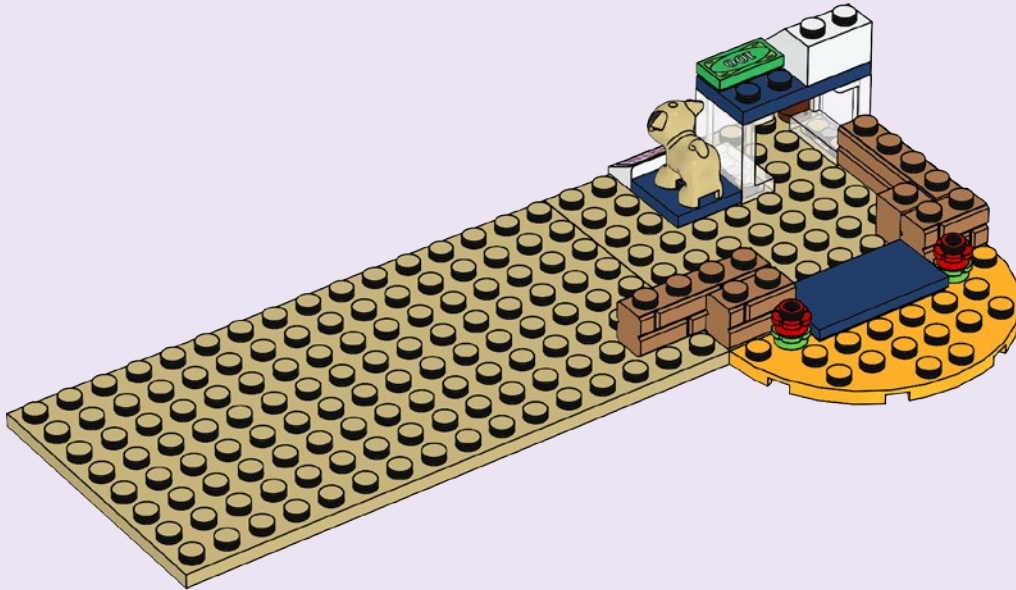



2x

11

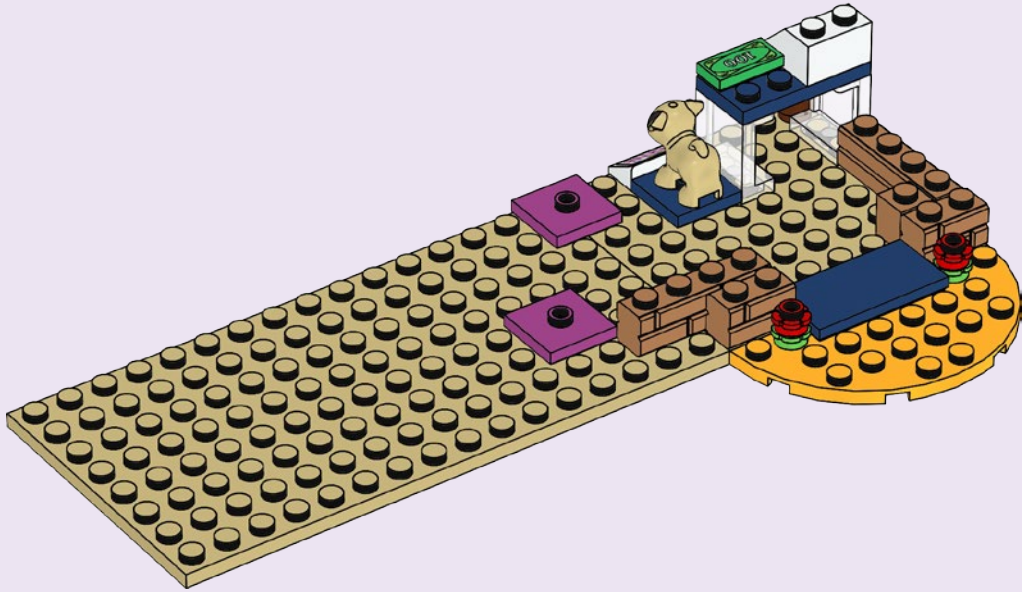

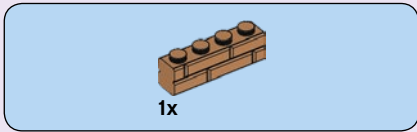

12

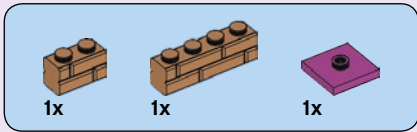
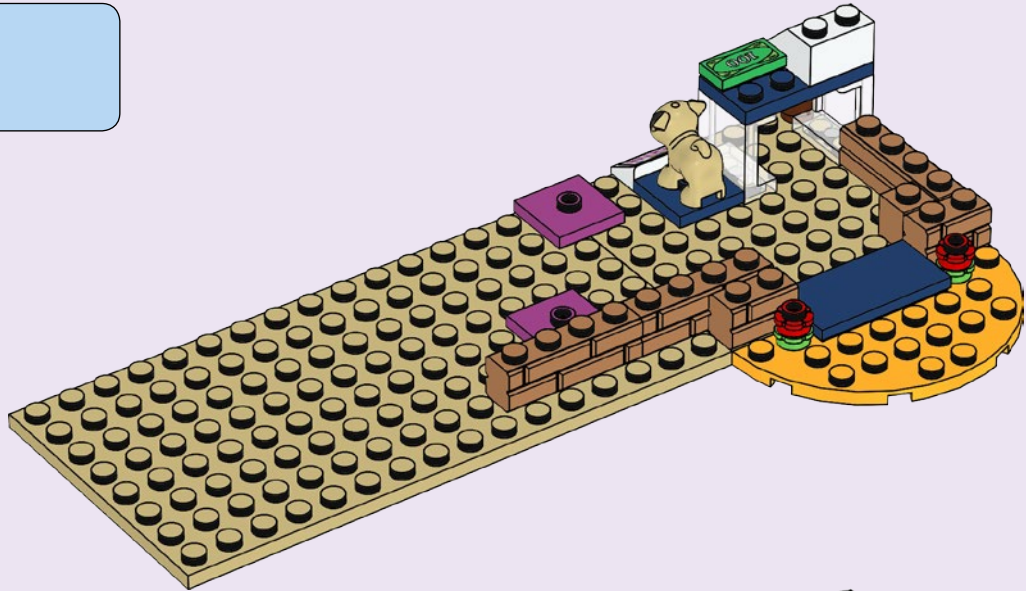

13

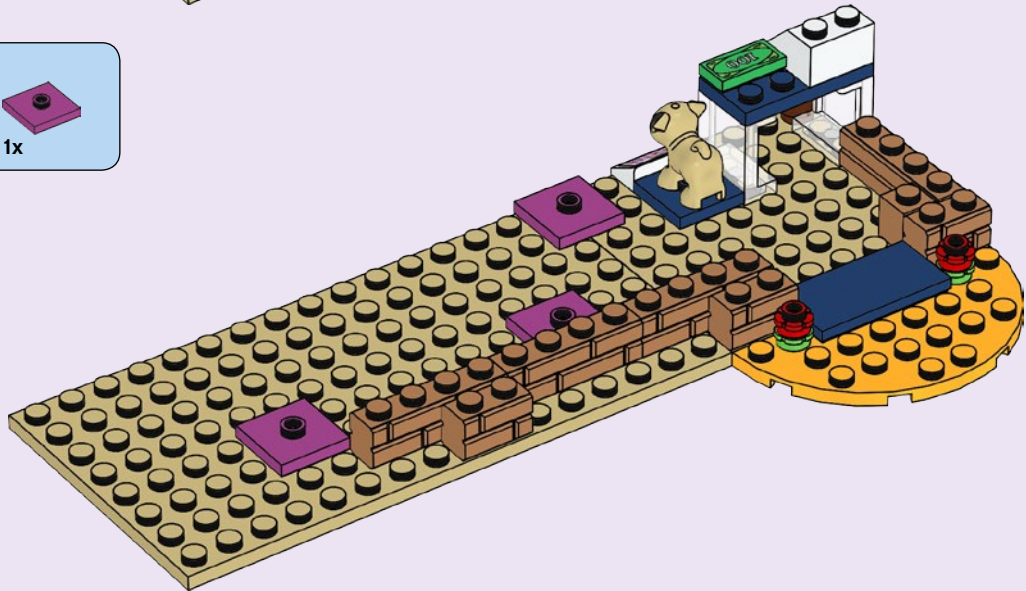

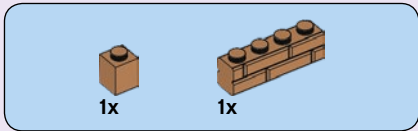

14

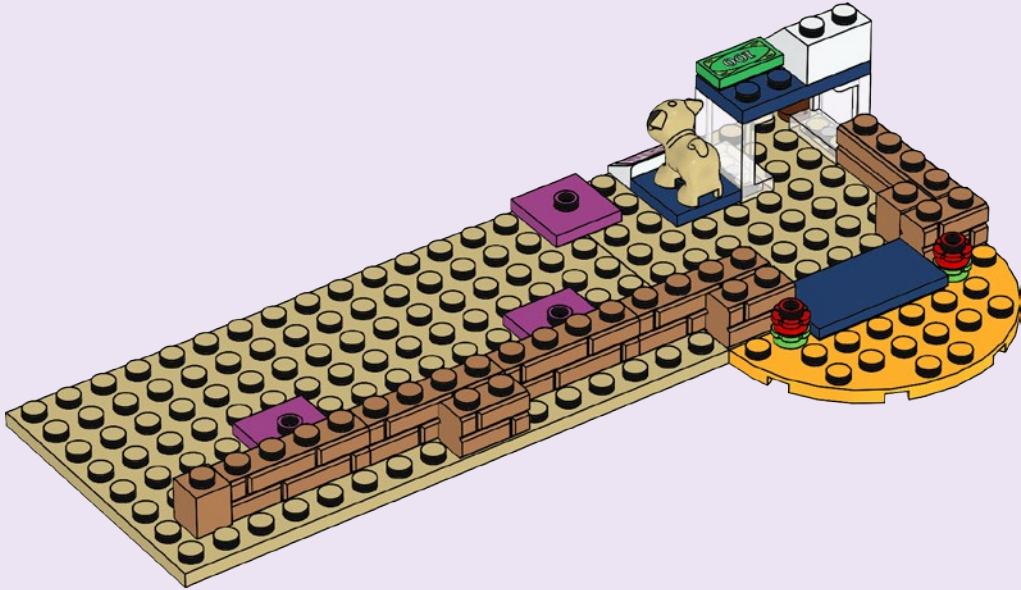



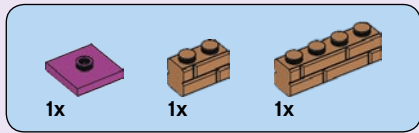

15

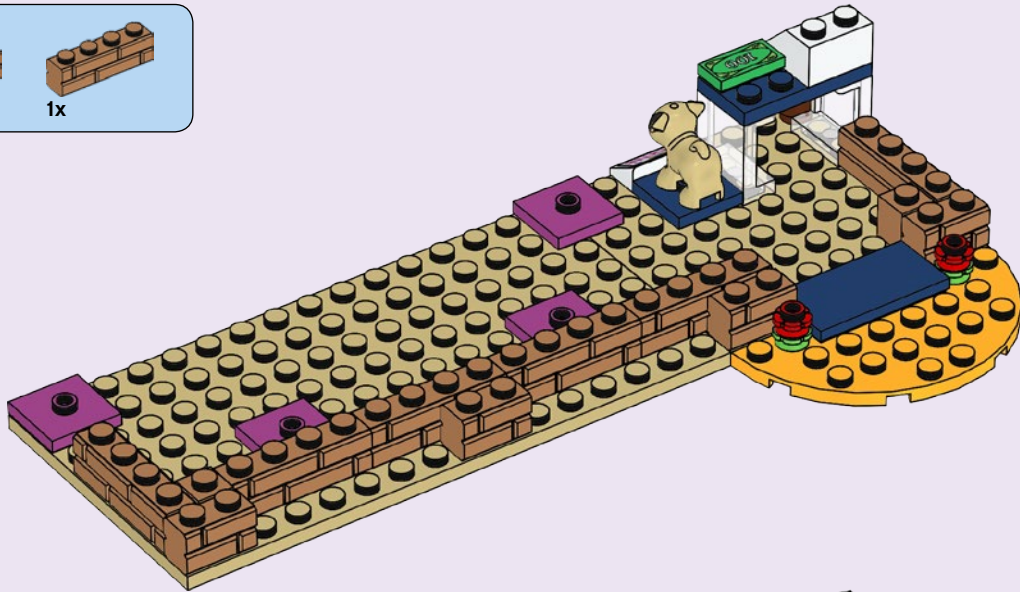

16

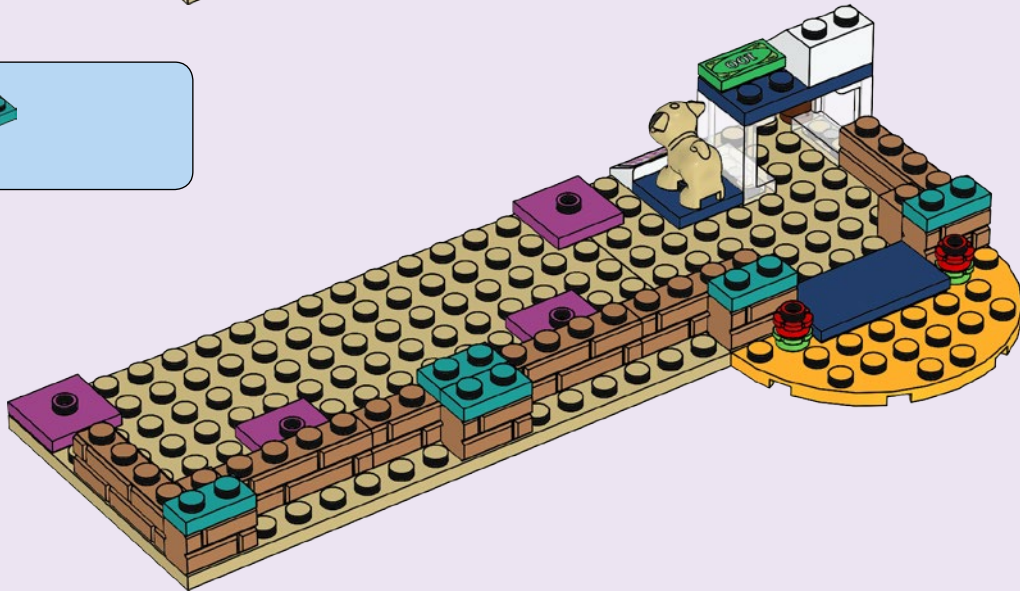

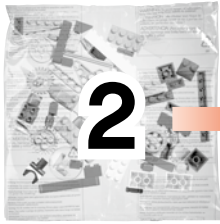

2

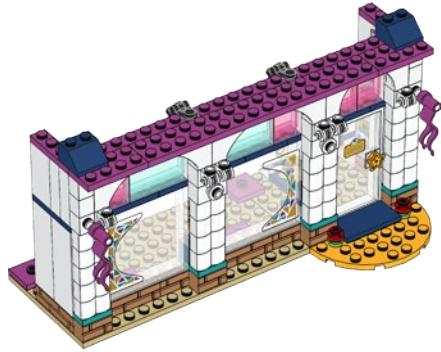

1x

17

1

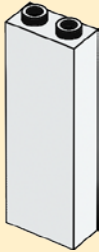

2

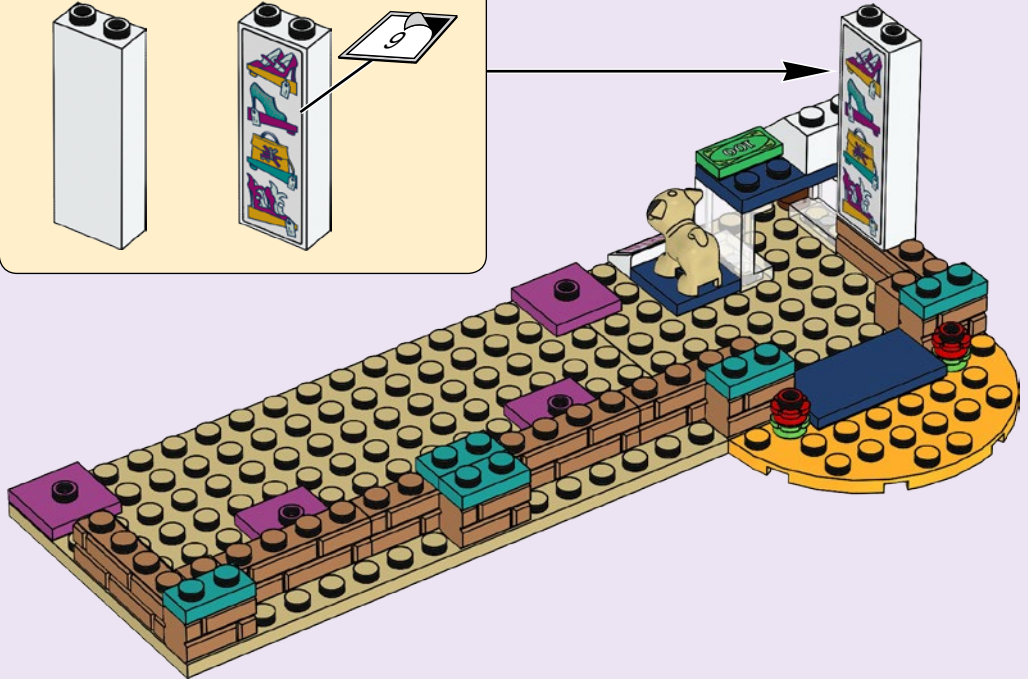
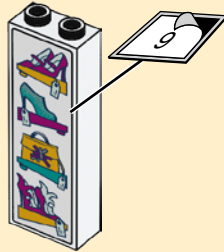

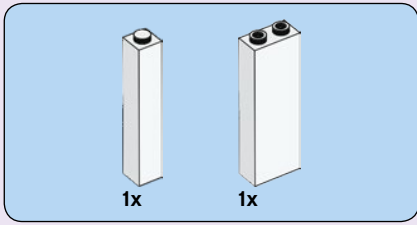

18

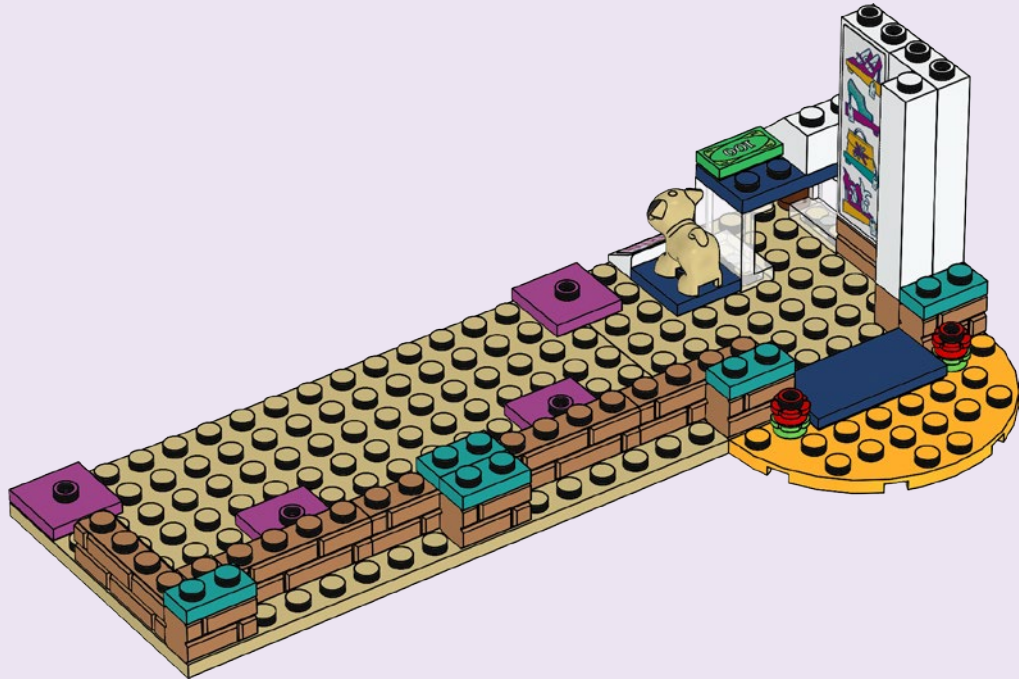

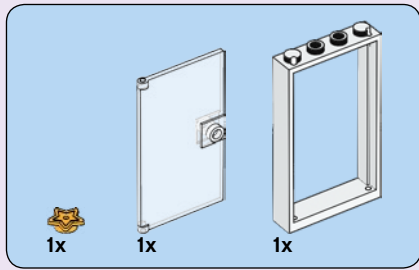

19

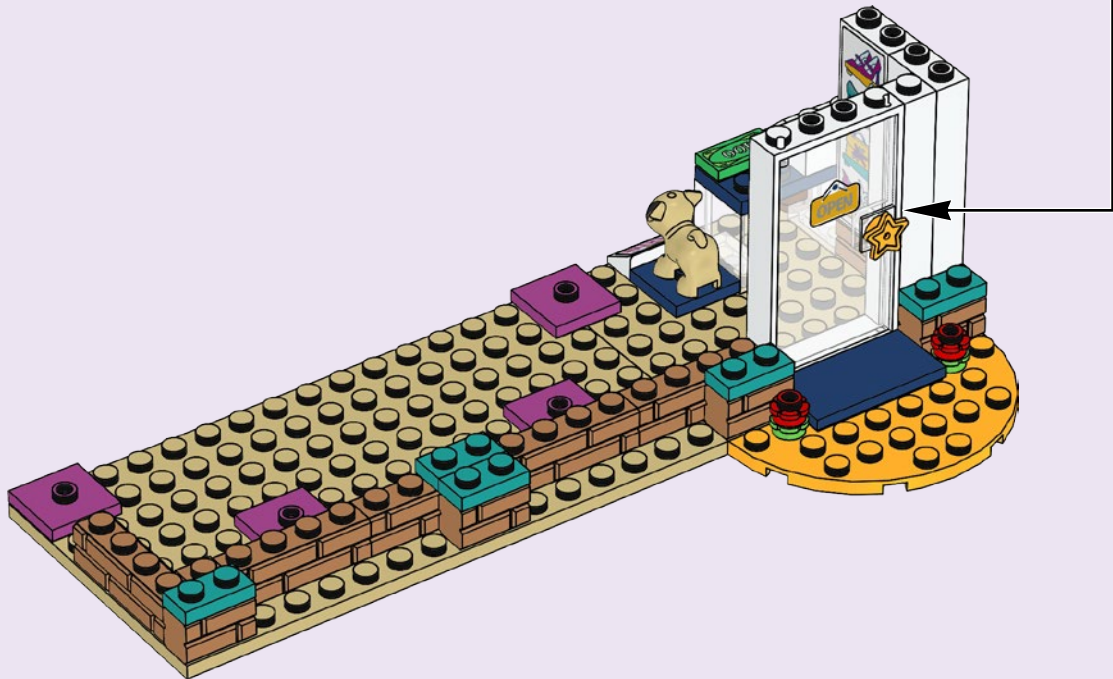
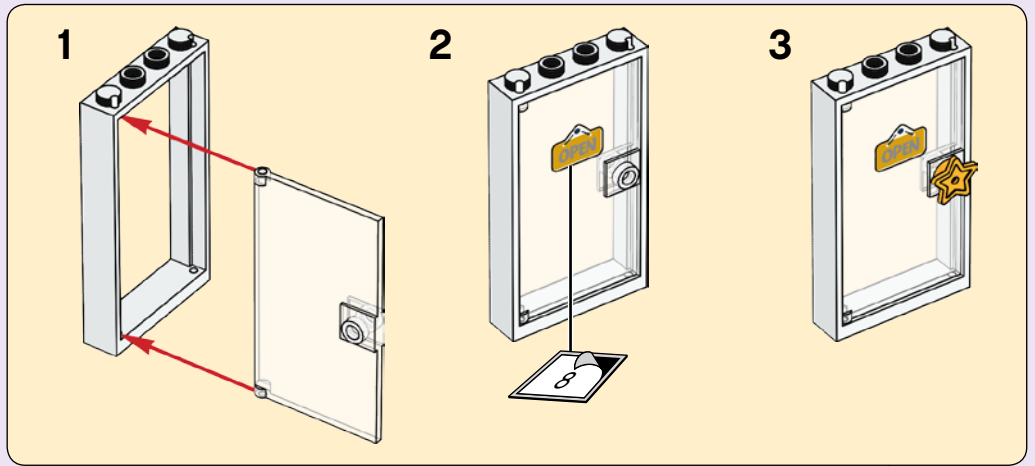



1x



1x

20

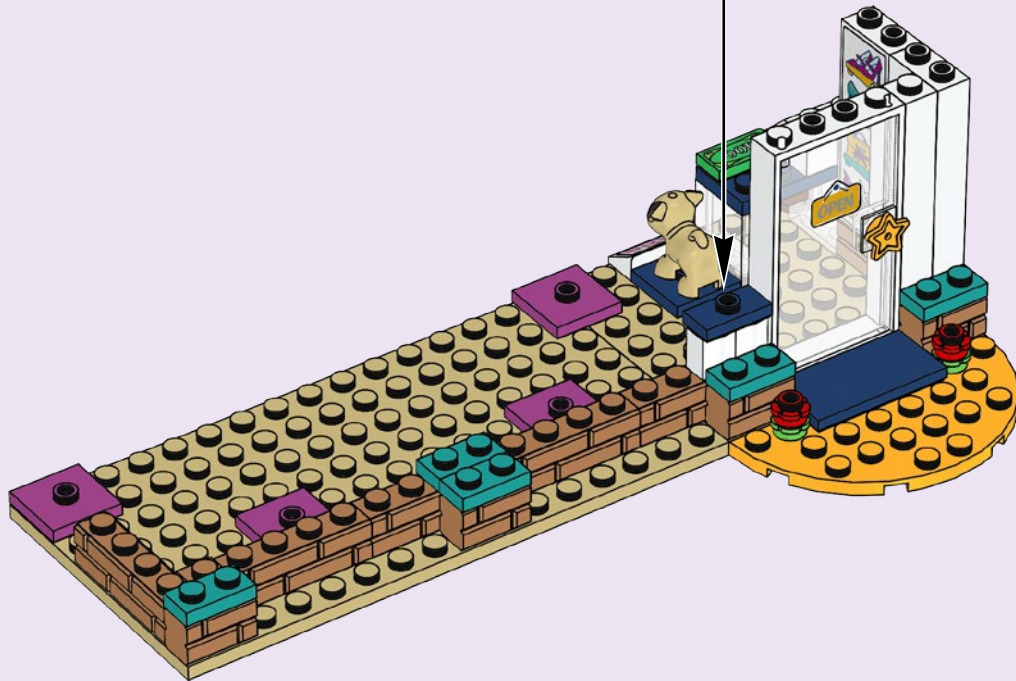
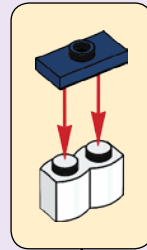

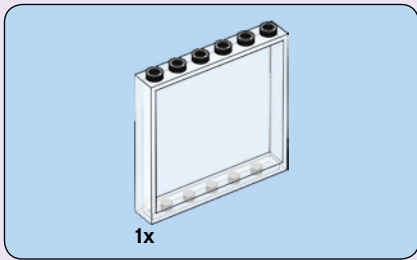

21

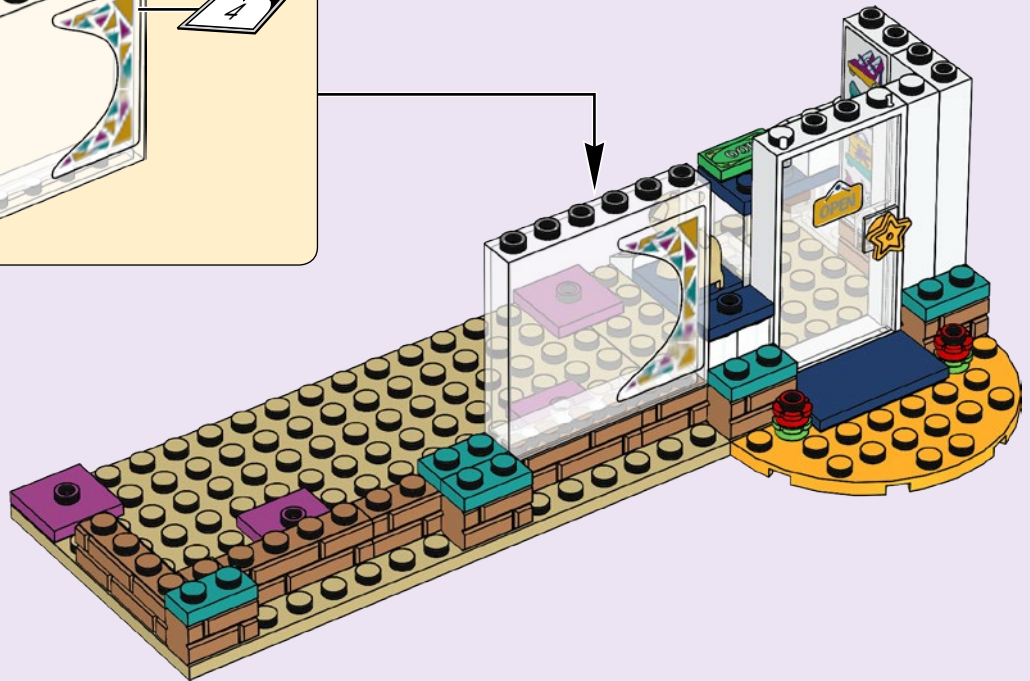
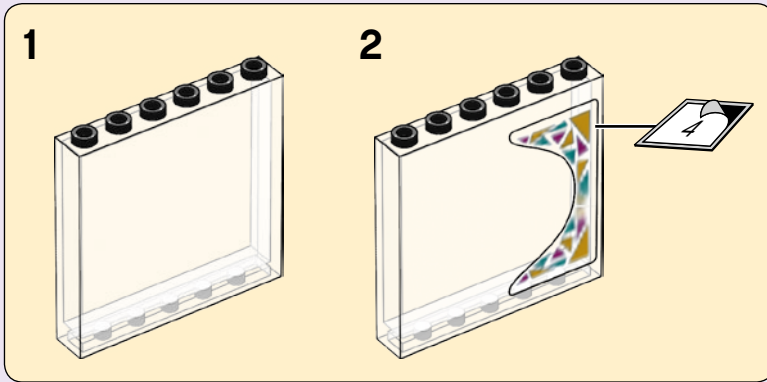



1x

22



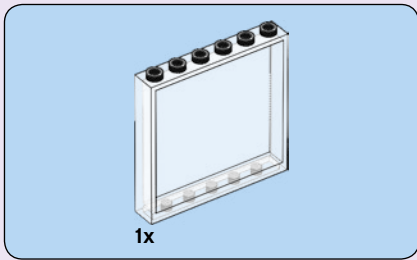

# 23

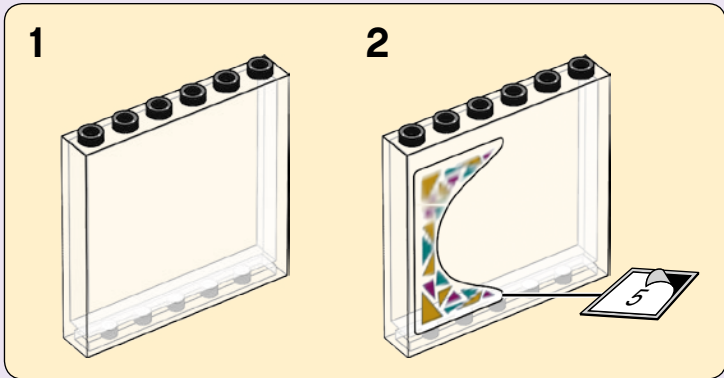



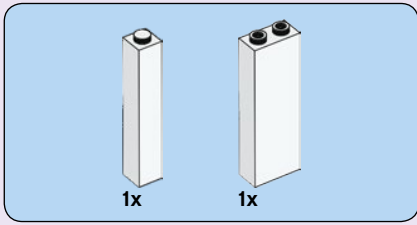

24



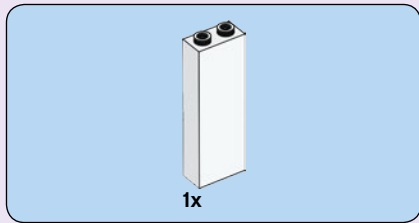

25

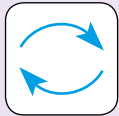
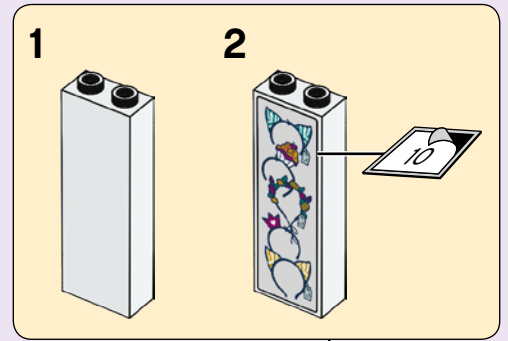

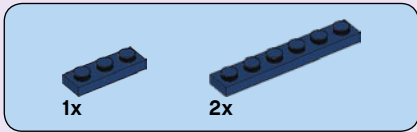

26



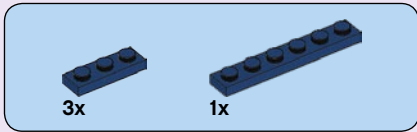

27

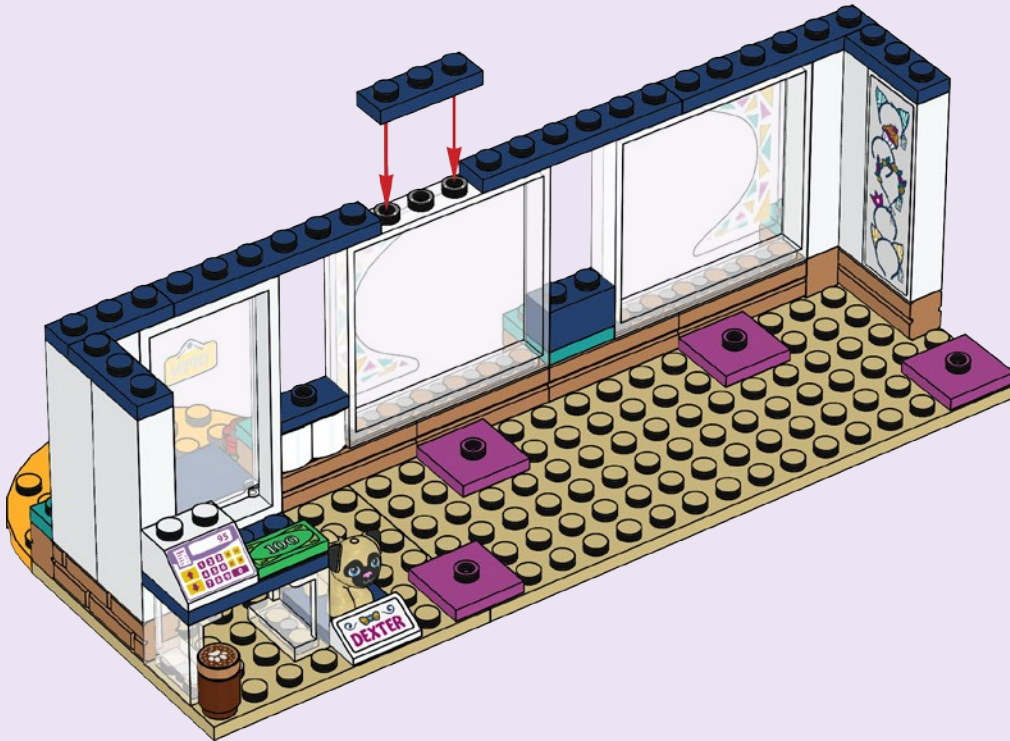

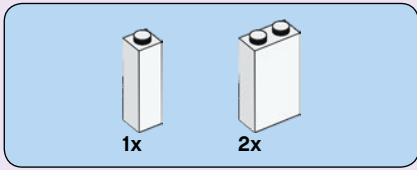

28

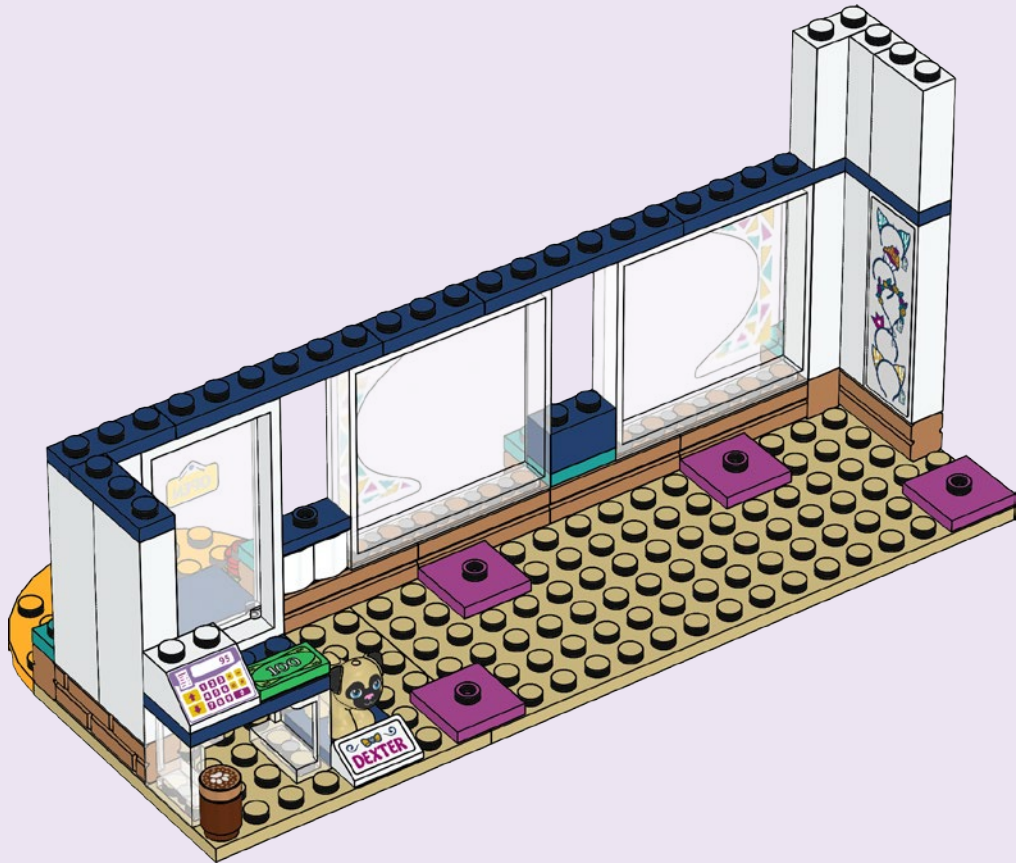

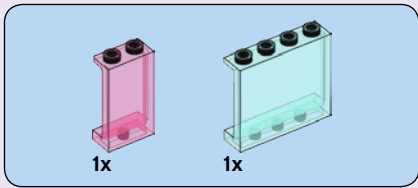

29

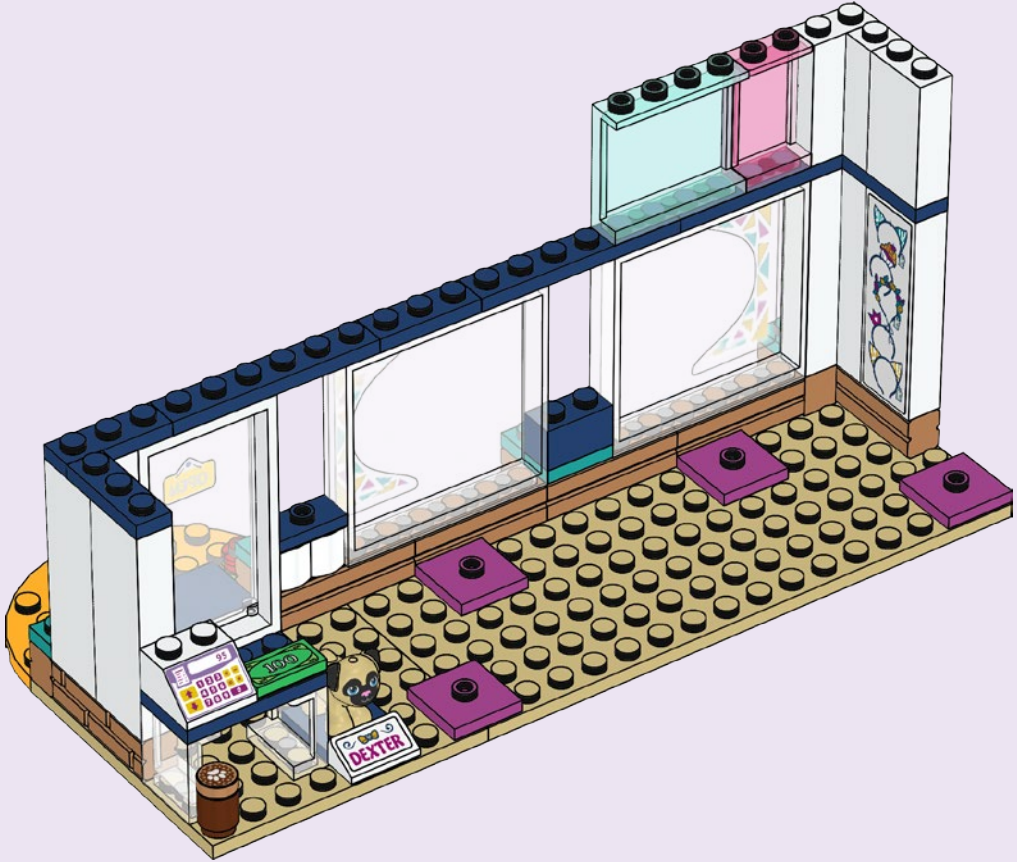

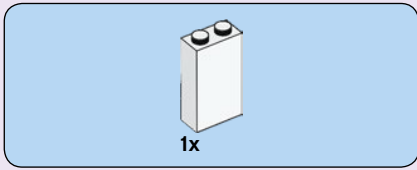

30

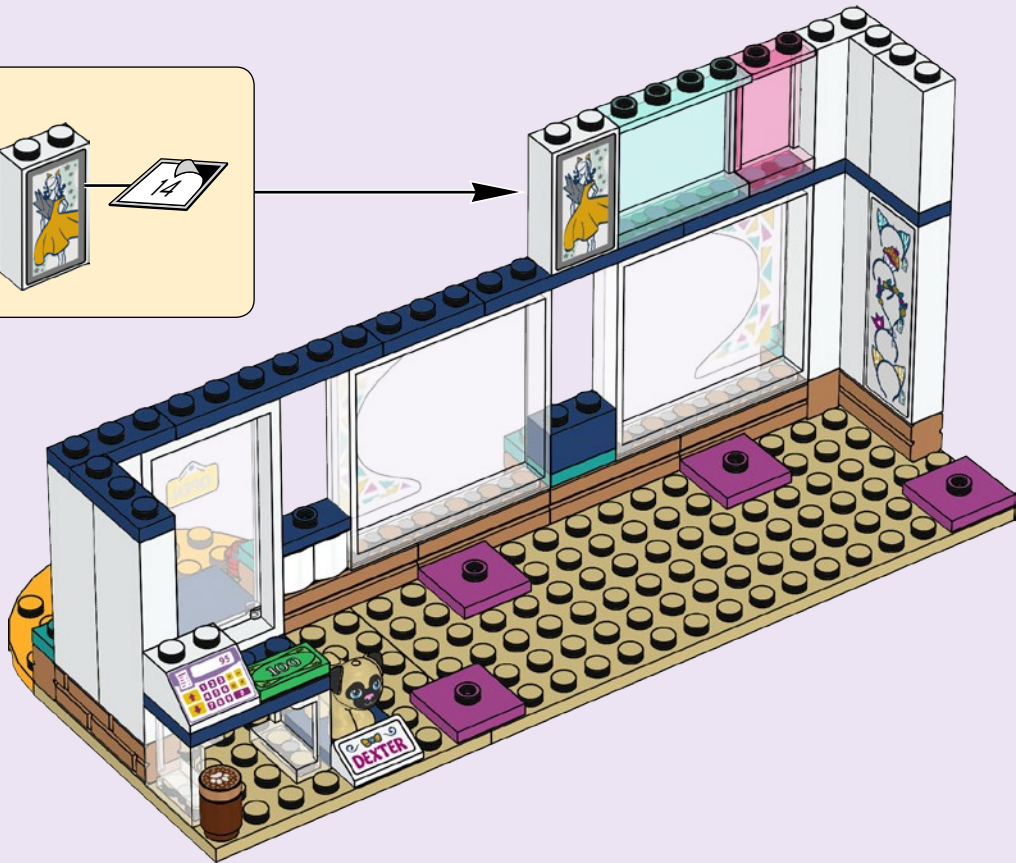
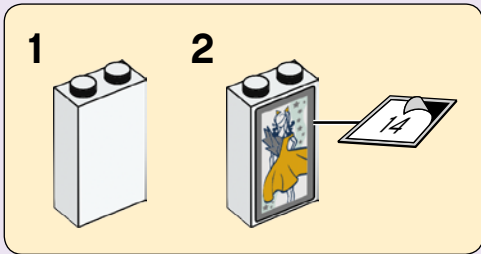

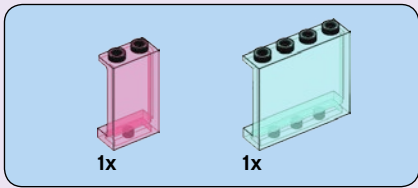

31





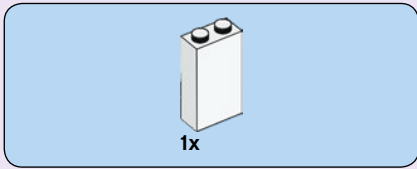

32

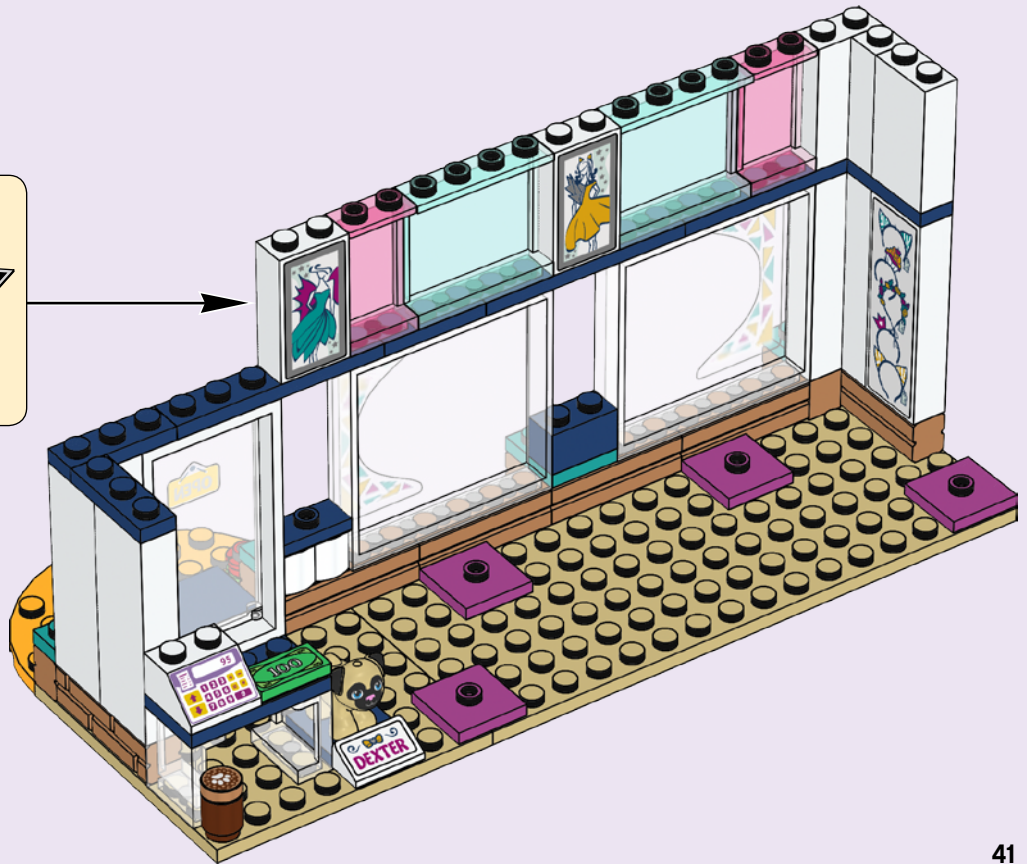
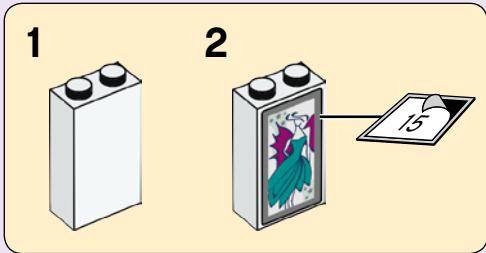

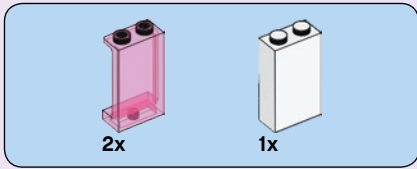

33



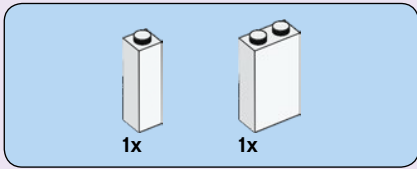

34



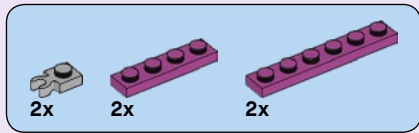

35



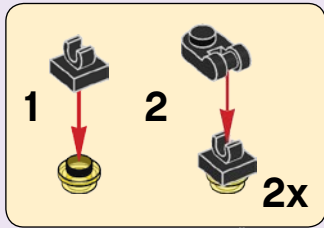
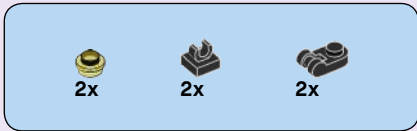

36



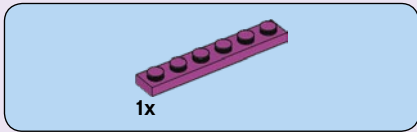

37



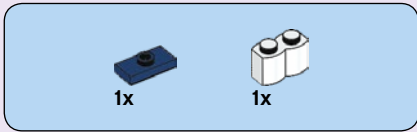

38

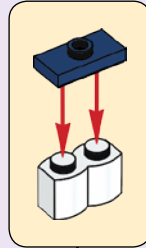



10x

39

1

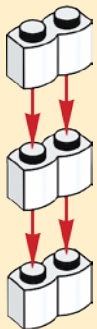

2

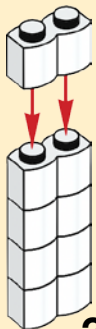

2x

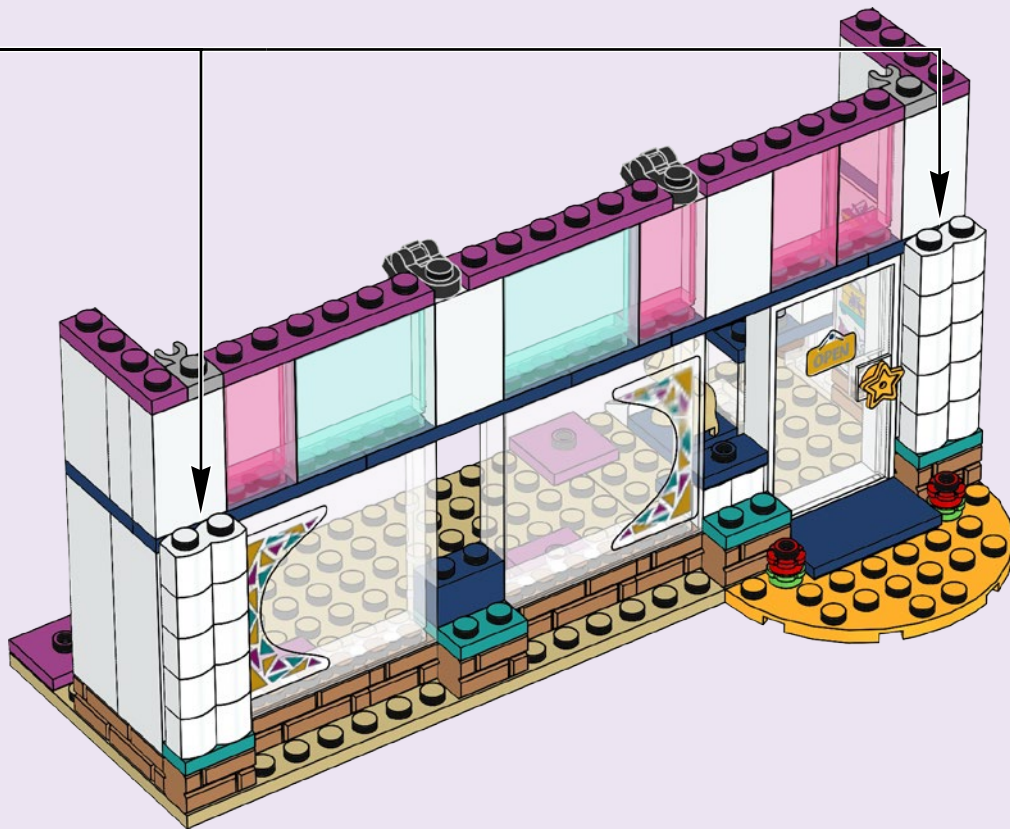
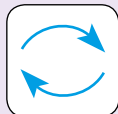





8x

40

1

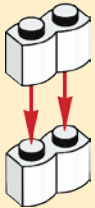

2

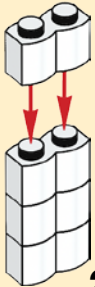

2x

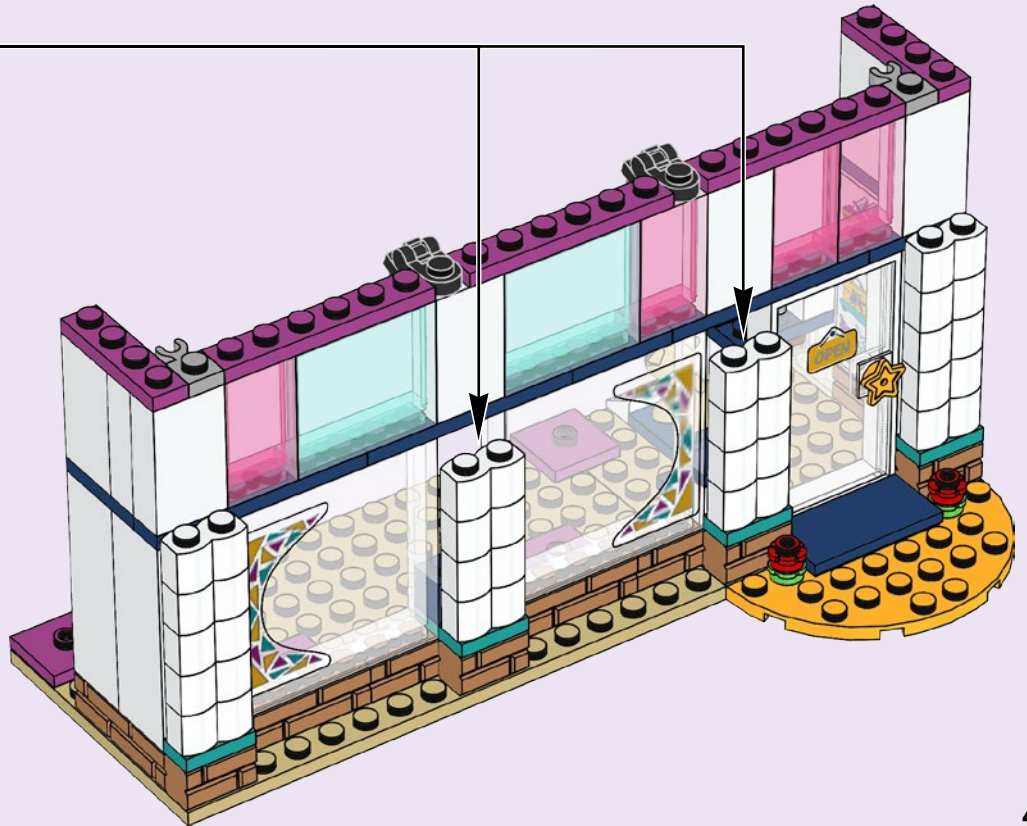



41

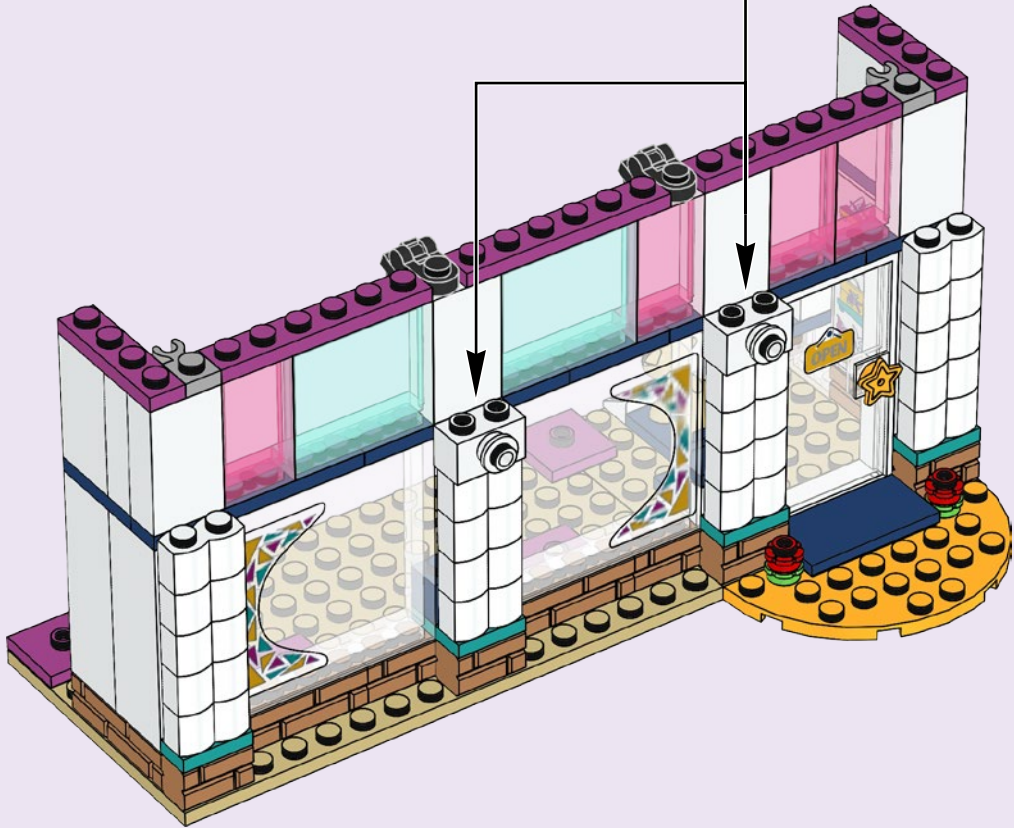
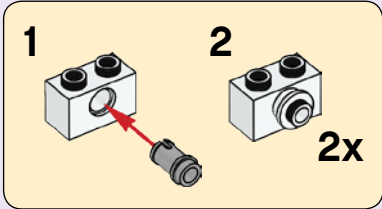

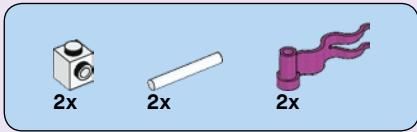

42

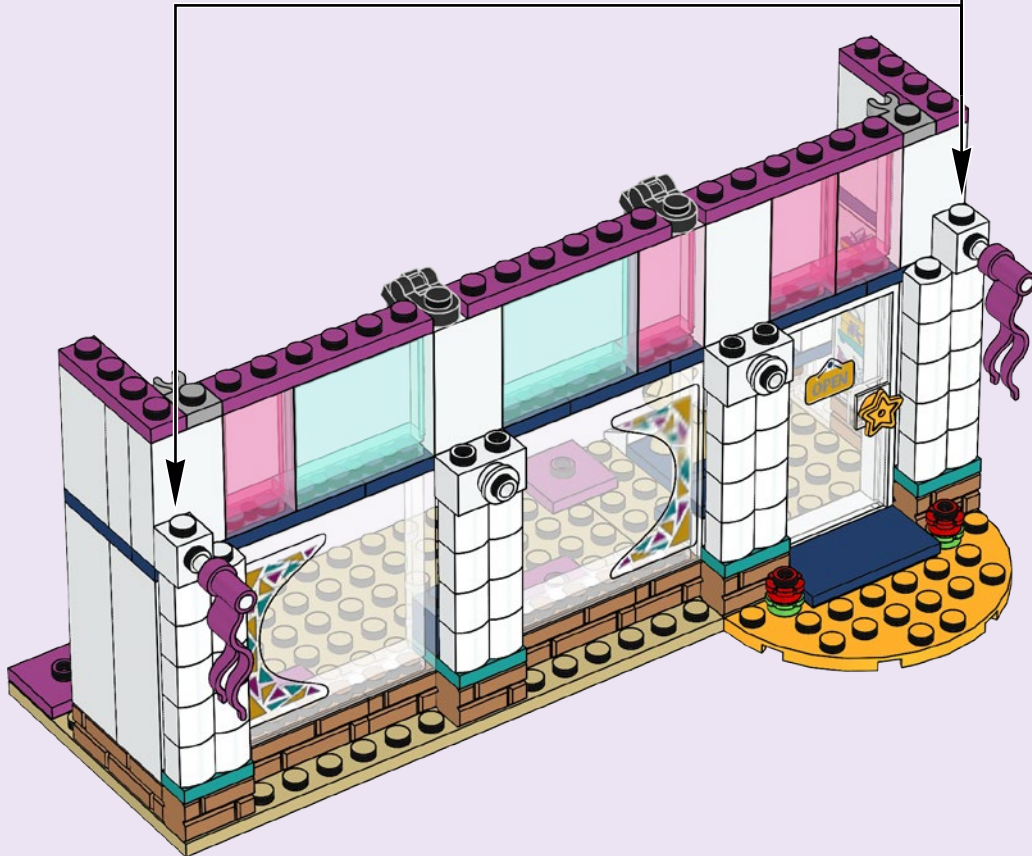
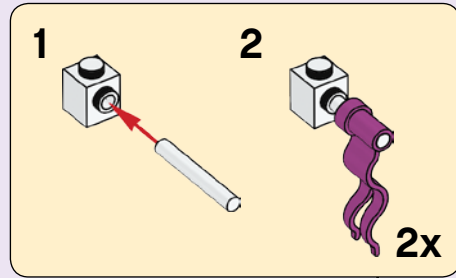



6x

43





4x

44

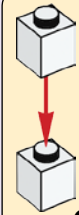

2x

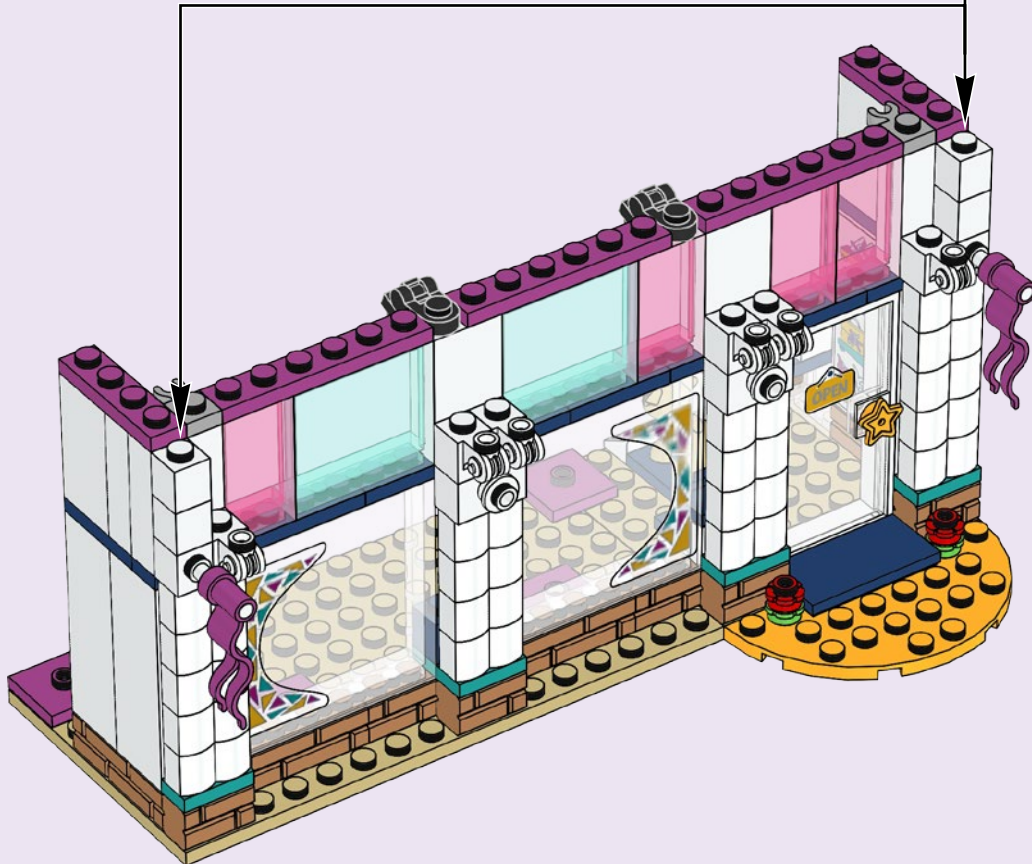

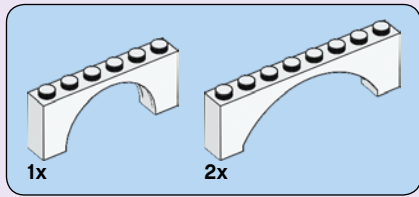

45



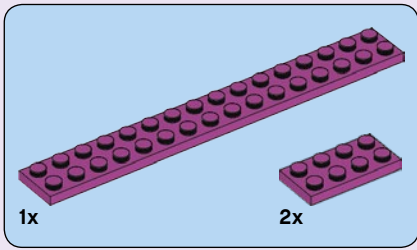

46





2x

47



56



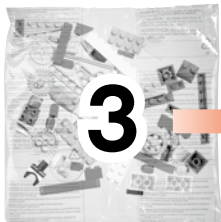

3

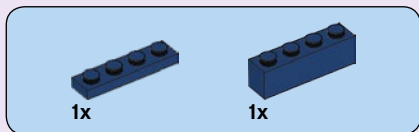

48

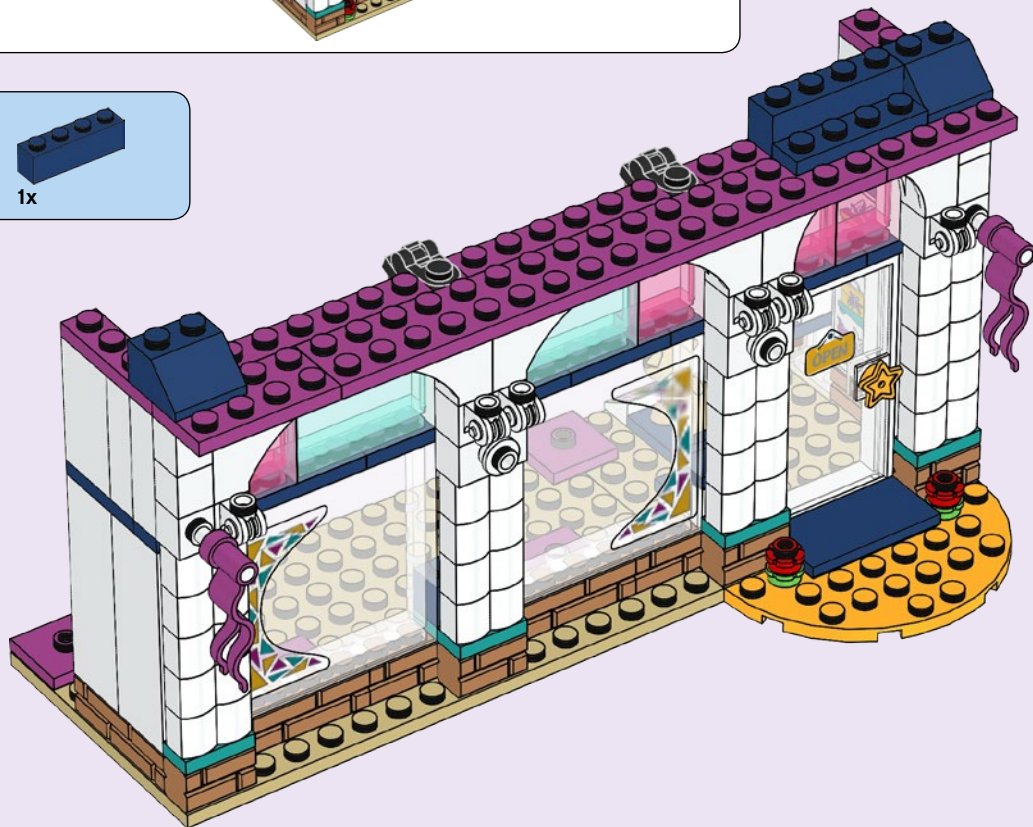



4x

49



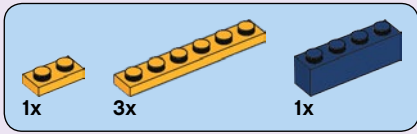

50

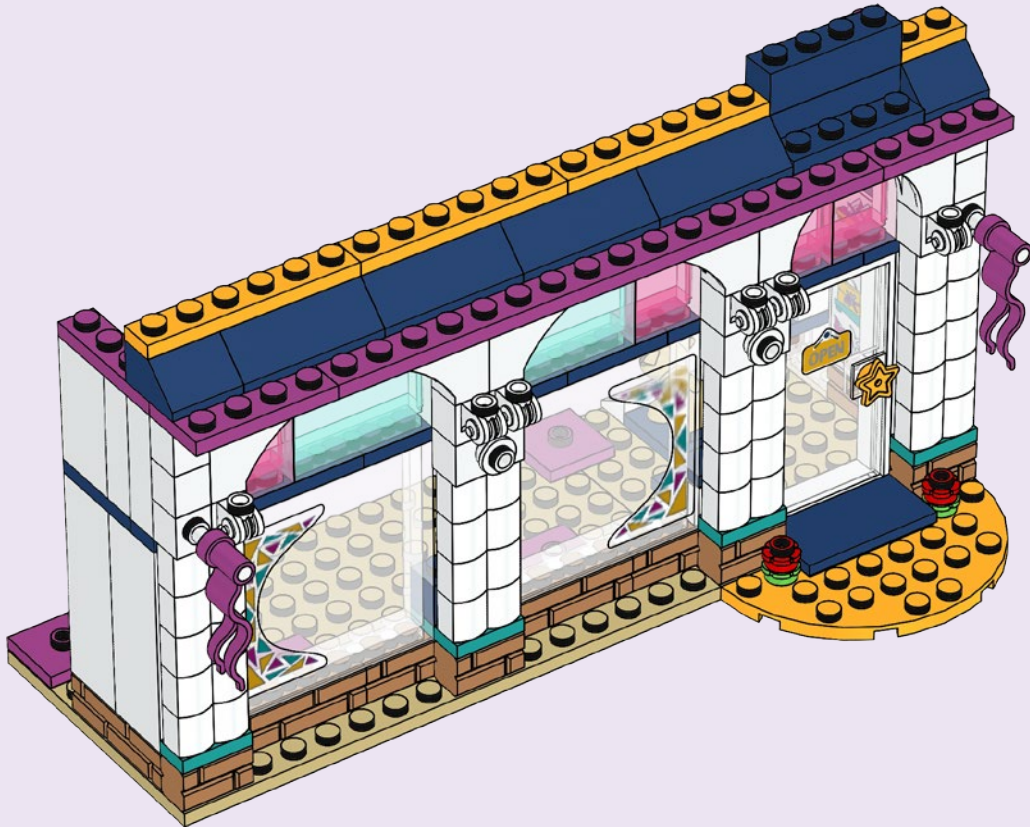



2x

51

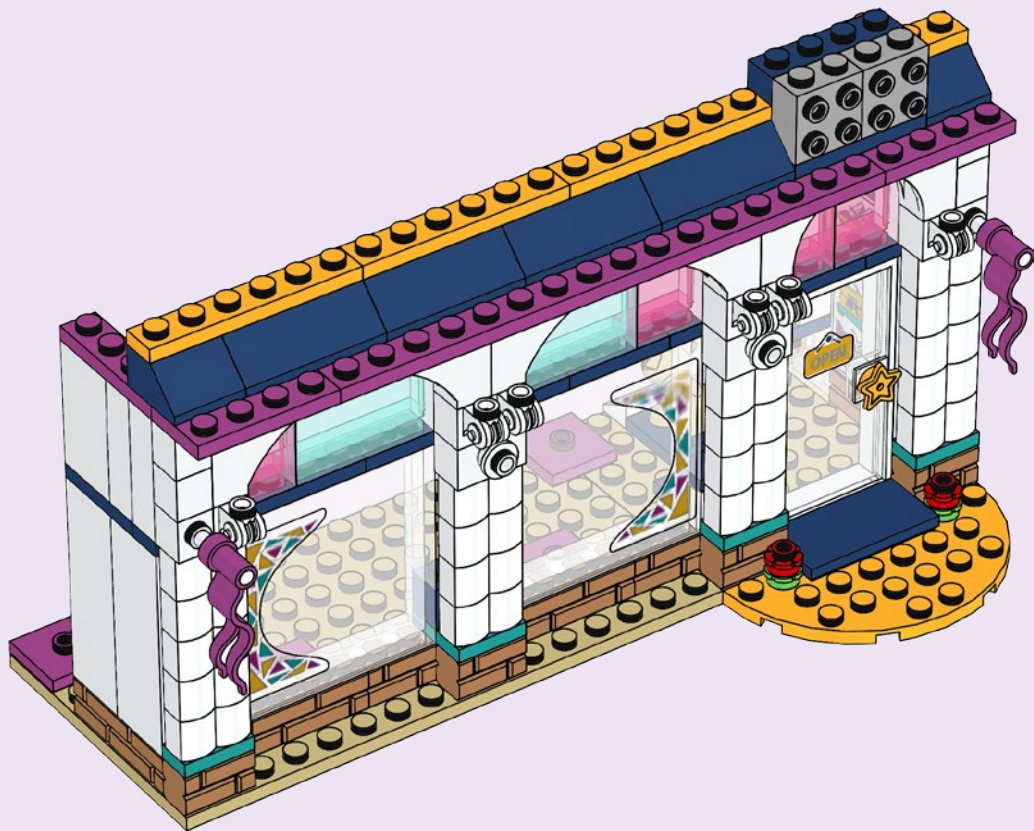



1x

52

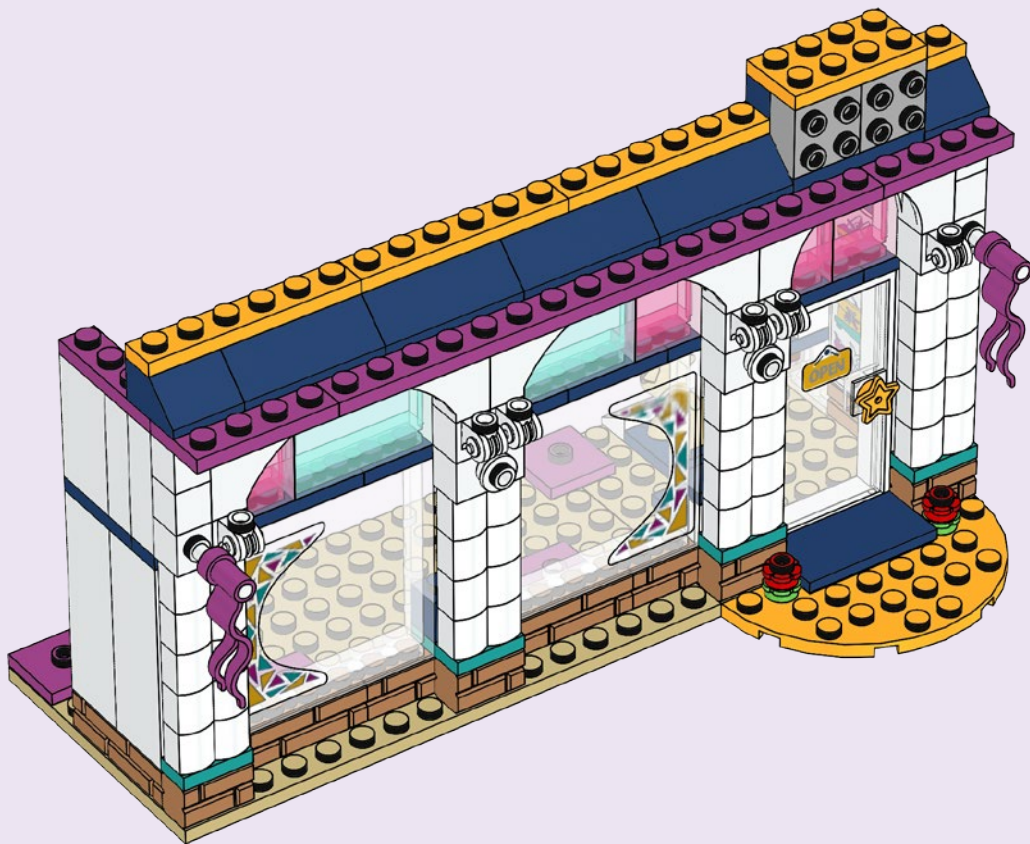

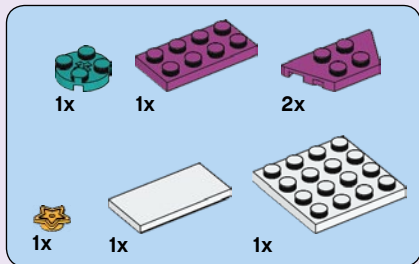

53

1

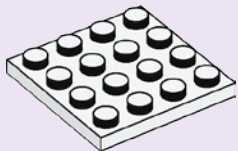

2



3

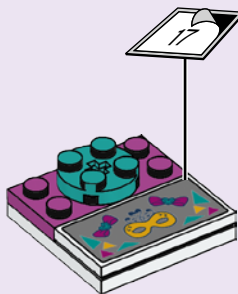

4



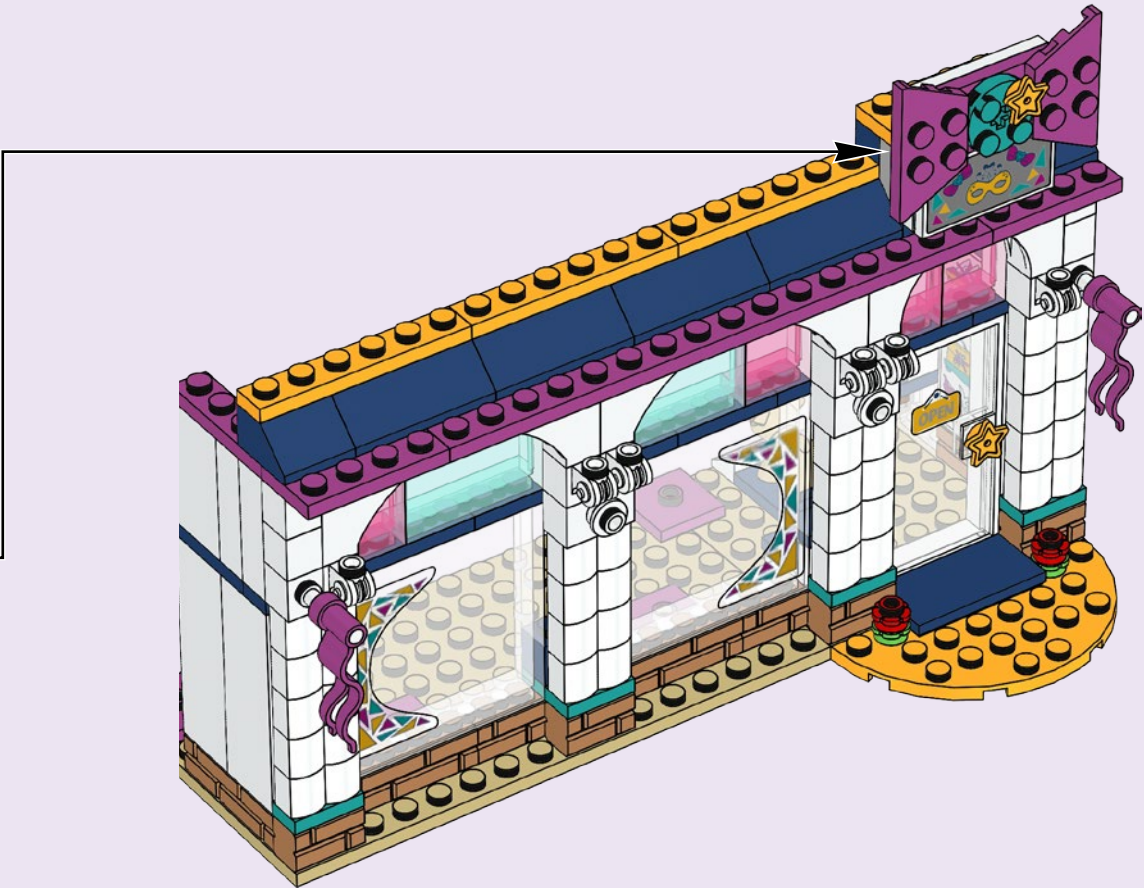



4x



4x

54

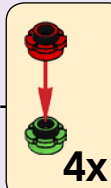
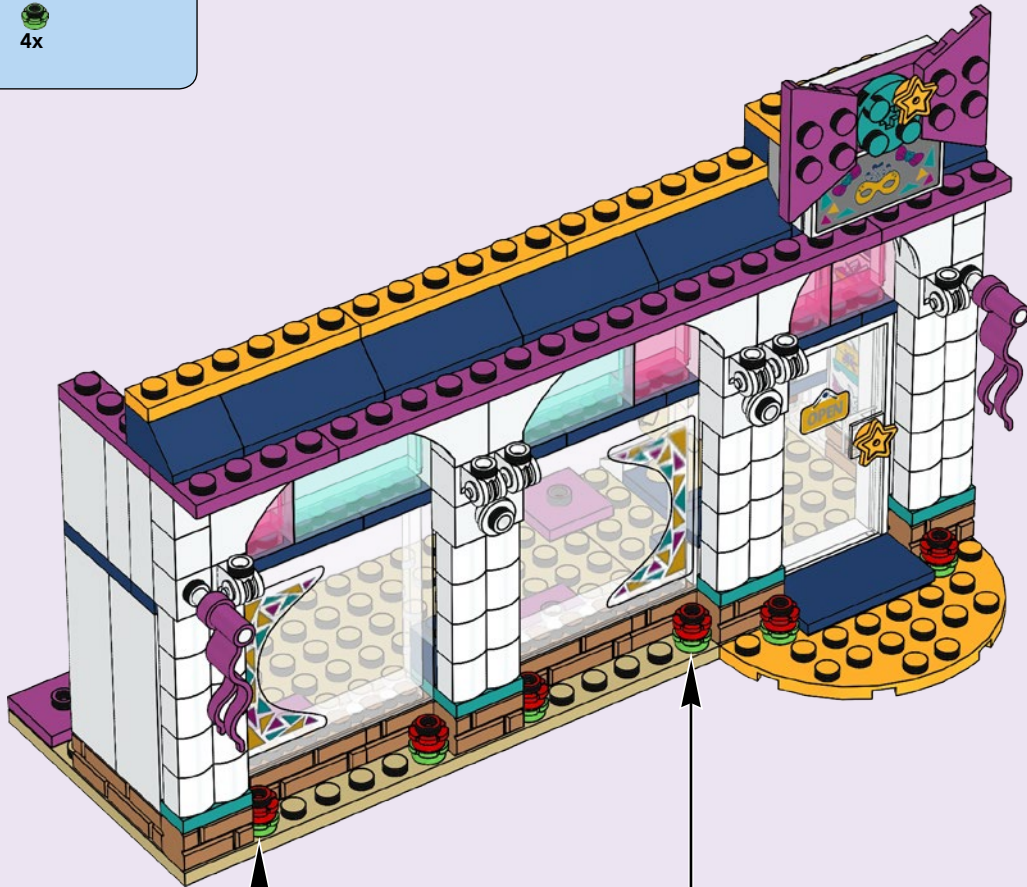

4x





12x



2x

55

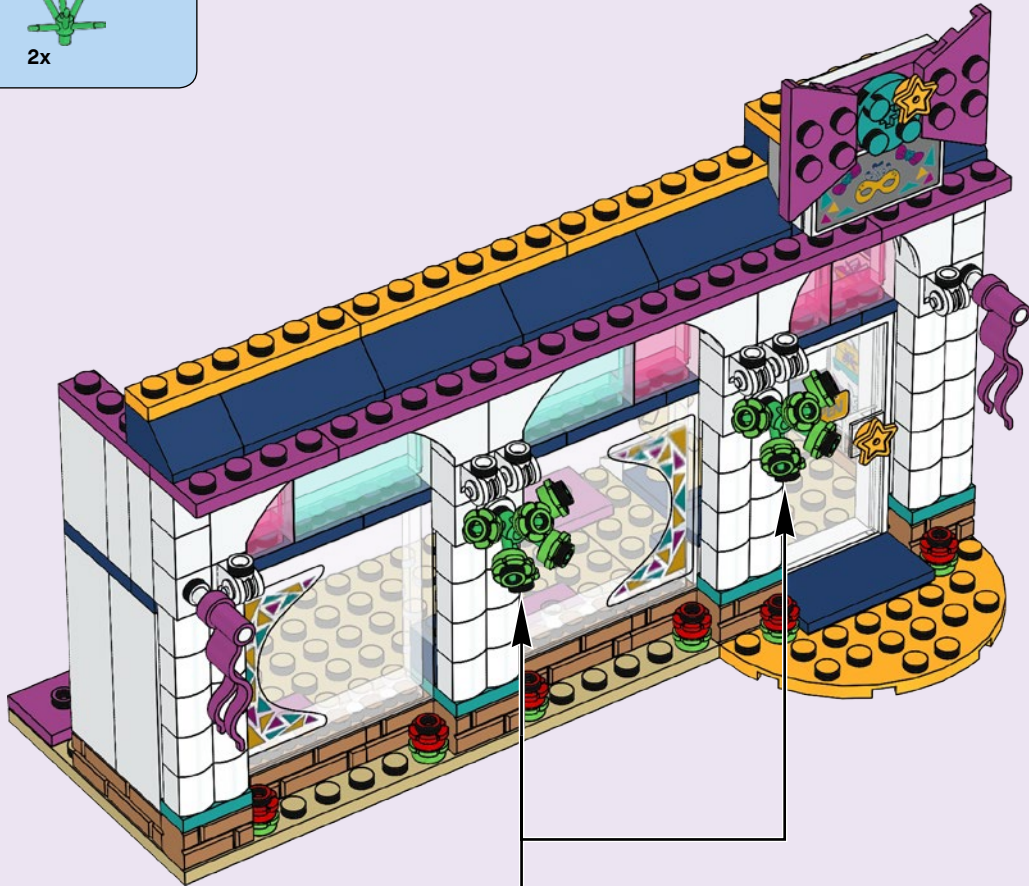

1



2

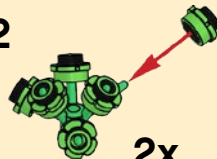

2x

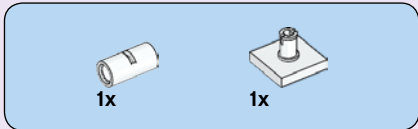
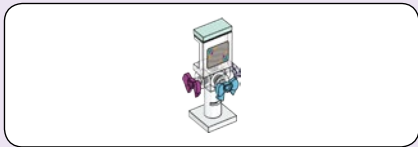

56

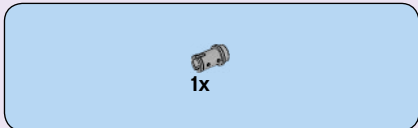
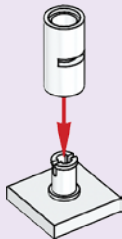

57

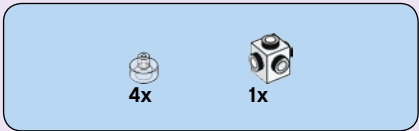
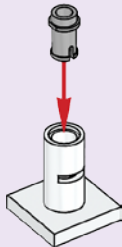

58

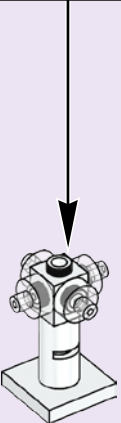
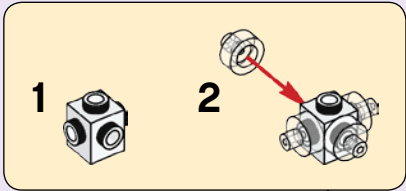



59

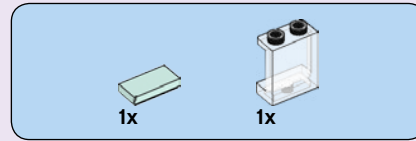
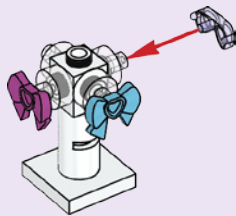

60

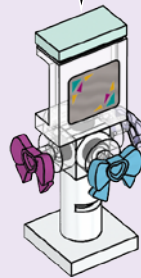
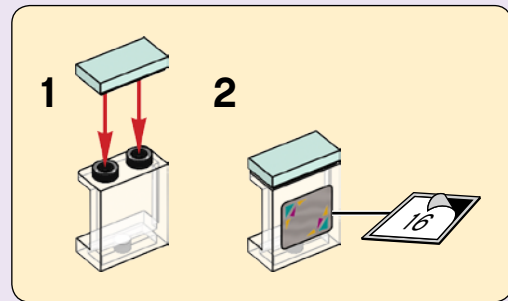

61



1x 1x 1x

62

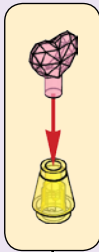



2x

63



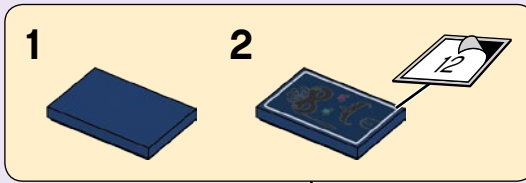
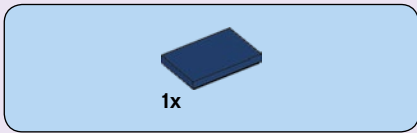

64



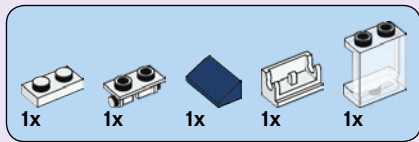

65

1

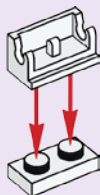

2

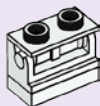

3

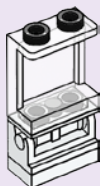

4



5

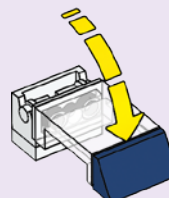

6

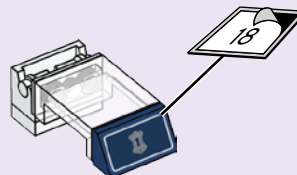





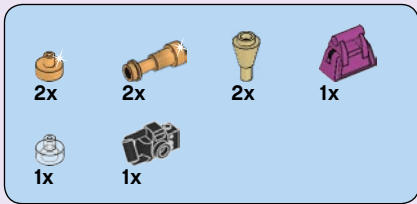

66

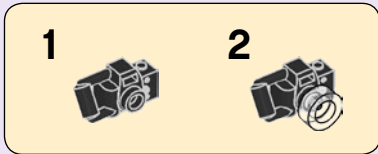
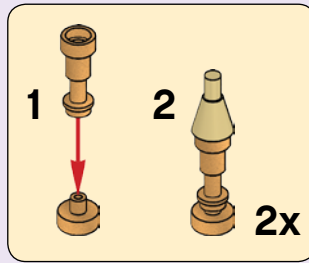

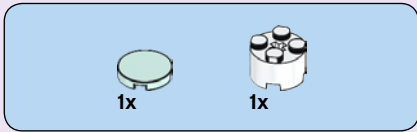

67

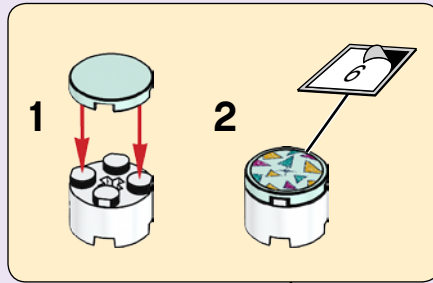



68

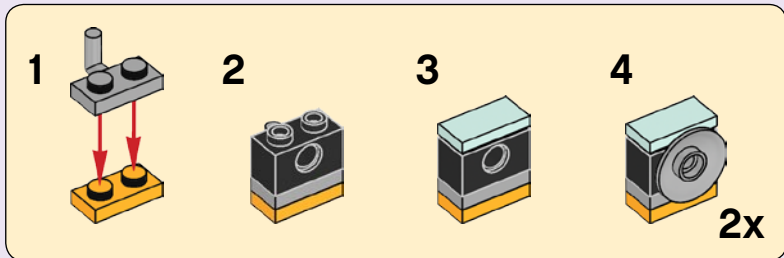



1x



69



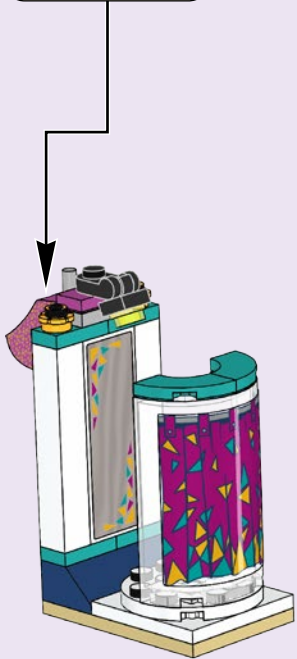
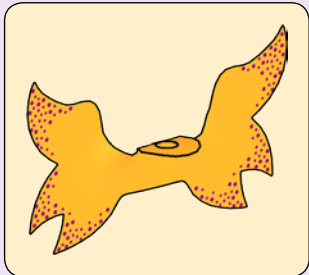
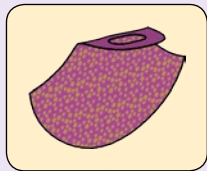

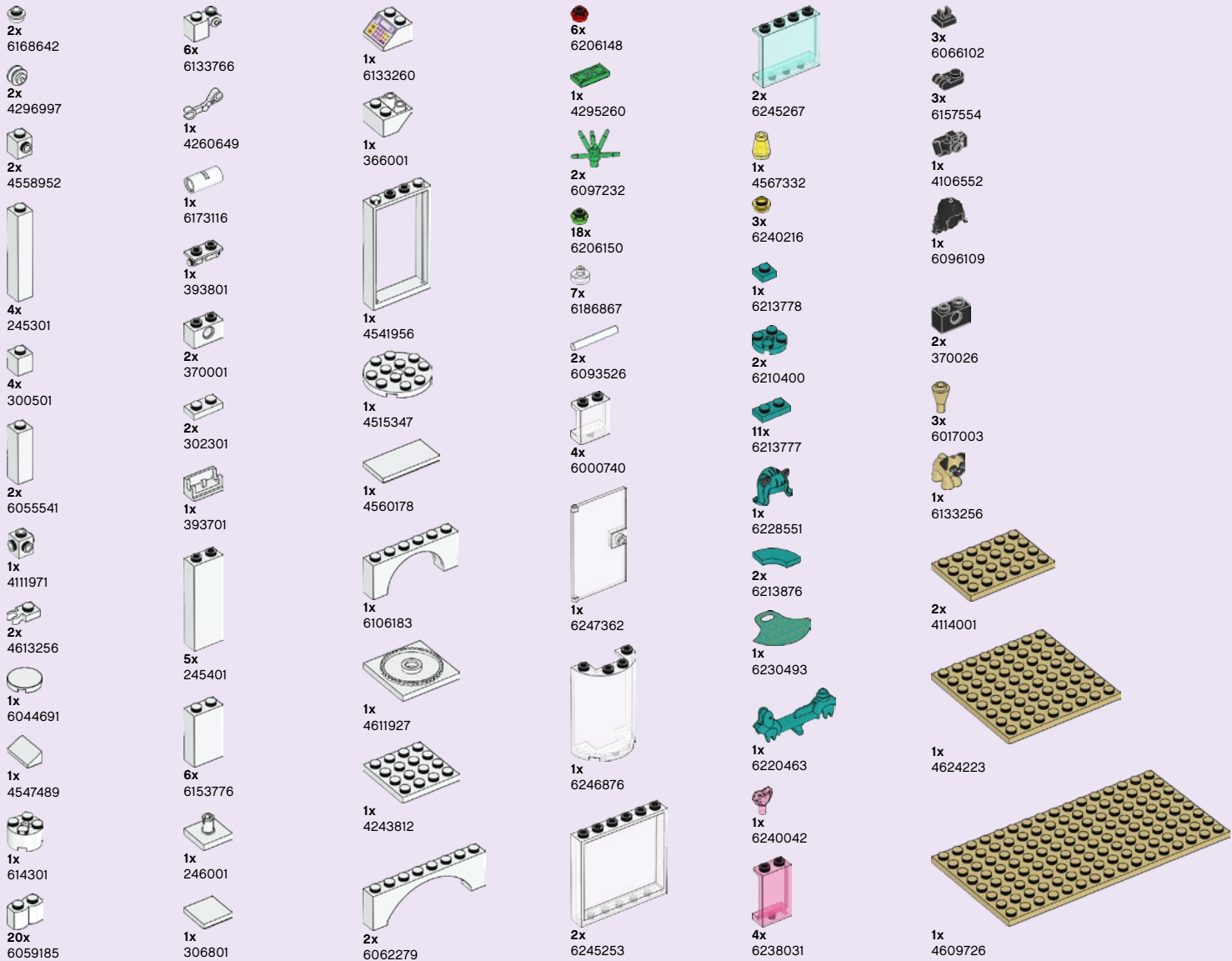

- 1x  
6023827
- 1x  
6177228
- 1x  
6101073
- 4x  
6056292
- 1x  
6230034
- 2x  
6133790
- 2x  
6056293
- 2x  
6037652
- 4x  
6037658
- 3x  
4654105
- 1x  
6173062
- 1x  
6226590
- 1x  
6216905
- 2x  
6092588
- 1x  
4249891
- 1x  
6115447
- 1x  
6094143

- 1x  
4565320
- 2x  
4153653
- 5x  
4177735
- 1x  
6186974
- 1x  
4502089
- 4x  
4264569
- 5x  
4578094
- 1x  
4667595
- 2x  
4569836
- 1x  
6223169
- 3x  
4508313

- 2x  
6209681
- 2x  
6167776
- 3x  
6028736
- 1x  
6097511
- 3x  
6020074
- 1x  
6176303
- 3x  
4211483
- 2x  
4594238
- 2x  
4211512
- 2x  
6123809
- 3x  
4611702
- 1x  
4644102

- 1x  
6055380
- 1x  
6226430
- 1x  
6242567
- 3x  
6186672
- 1x  
6092594
- 3x  
4538126
- 1x  
6209868
- 1x  
6152676
- 2x  
6057986
- 4x  
4656783
- 1x  
6226569
- 1x  
6218929

- 6x  
6055309
- 1x  
4211183
- 1x  
6237881
- 1x  
6096993
- 1x  
6023825
- 1x  
4619815
- 1x  
6211662
- 1x  
6096948
- 2x  
6022032
- 4x  
6133247
- 1x  
6096991
- 1x  
6223175

**Customer Service**

Kundenservice

Service Consommateurs

Servicio Al Consumidor

[LEGO.com/service](http://LEGO.com/service) or dial

- - 
  - 
  - 
  - 
  - 
  - 
  - 
  - 
  - 
  - 
  - 
  -
- 00800 5346 5555 :  
1-800-422-5346 :





41341



41342



41327



41328



41329



41347  
Heartlake City Resort  
Le complexe touristique de  
Heartlake City  
Resort de  
Heartlake City



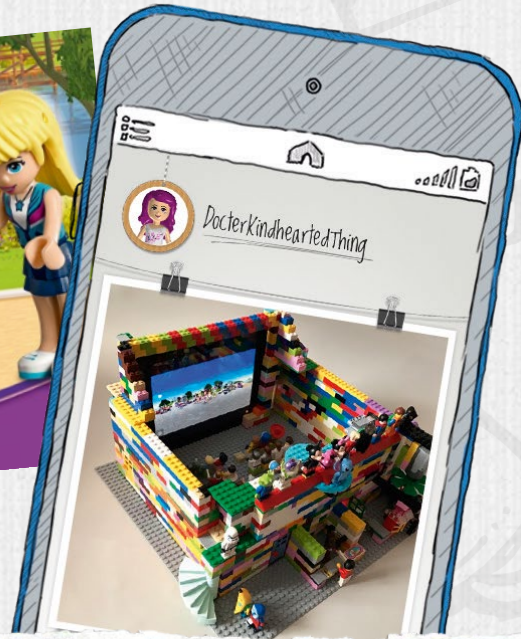

# WIN

GO TO [WWW.LEGO.COM/PRODUCTFEEDBACK](http://WWW.LEGO.COM/PRODUCTFEEDBACK) AND  
GIVE US YOUR SHORT **FEEDBACK** ABOUT THIS  
LEGO® SET FOR A CHANCE TO WIN  
A COOL LEGO PRIZE.

Terms & Conditions apply



## LEGO.com/productfeedback

### GEWINNE

Erzähle uns auf  
[www.LEGO.com/productfeedback](http://www.LEGO.com/productfeedback)

etwas über die Erfahrungen, die du mit  
diesem LEGO® Set gemacht hast, und  
sichere dir die Chance auf einen coolen  
LEGO Preis!

Es gelten die Teilnahmebedingungen

### GAGNE

Rends-toi sur  
[www.LEGO.com/productfeedback](http://www.LEGO.com/productfeedback)

et donne-nous quelques commentaires  
sur ce produit LEGO® pour avoir une  
chance de gagner un prix LEGO !

Voir Conditions Générales

### GANANA

Visita  
[www.LEGO.com/productfeedback](http://www.LEGO.com/productfeedback)

y envíanos tu opinión acerca de este set  
LEGO®. ¡Participarás en el sorteo de un  
premio LEGO!

Términos y Condiciones aplicables

### 获取奖品

登录  
[www.LEGO.com/productfeedback](http://www.LEGO.com/productfeedback)

给出关于此乐高®套装的简短反馈，  
就有机会获得炫酷乐高奖品

《条款及条件》适用

LEGO, the LEGO logo and the FRIENDS logo are trademarks of the/son des marques de commerce du/son marcas registradas de LEGO Group. ©2018 The LEGO Group.