



Friends™

41378



WARNING: CHOKING HAZARD.
Toy contains small parts and a small ball.
Not for children under 3 years.



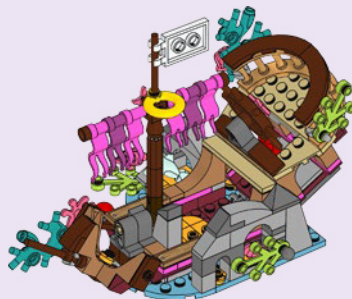
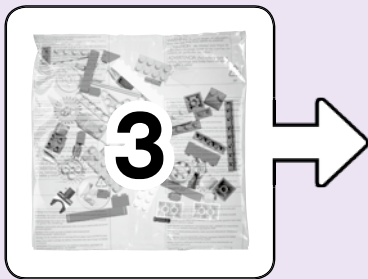

AVERTISSEMENT : RISQUE D'ÉTOUFFEMENT.
Le jouet contient des petites pièces ainsi qu'une petite boule.
Il ne convient pas aux enfants de moins de 3 ans.



ADVERTENCIA: PELIGRO DE ASFIXIA.
Juguete que contiene partes pequeñas y una pelota pequeña.
No recomendado para niños menores de 3 años.

3

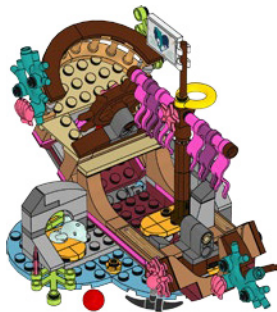
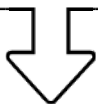

1x

1

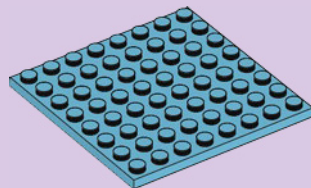

2x

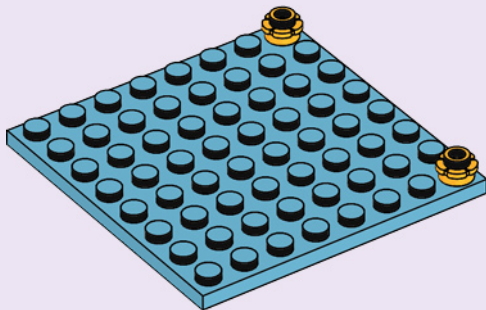

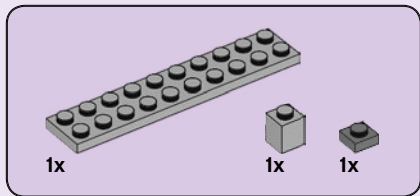

2

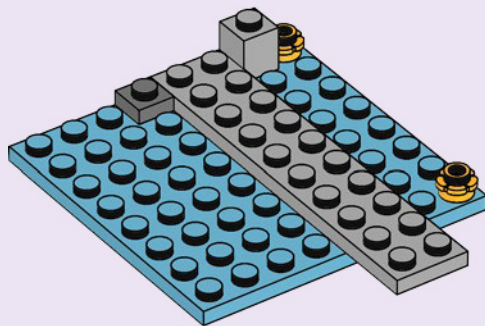

4

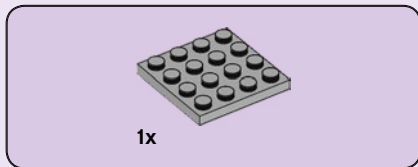

3

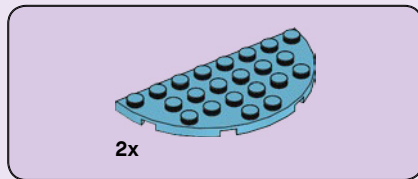
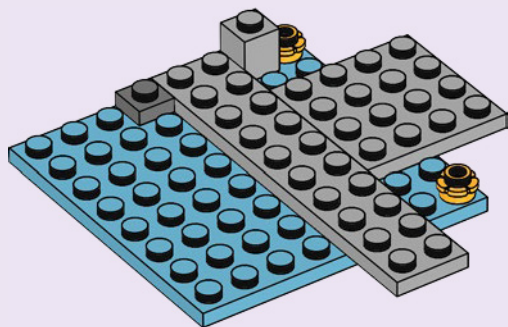

4

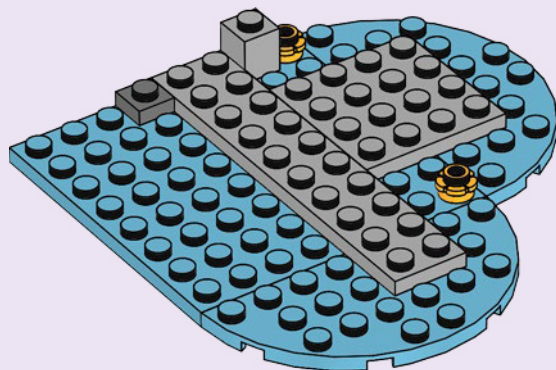



1x



1x

5

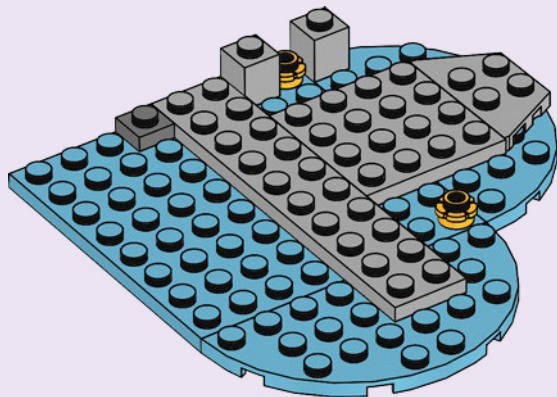

6

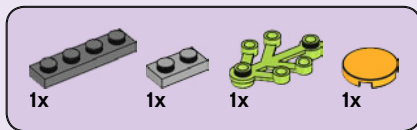

6

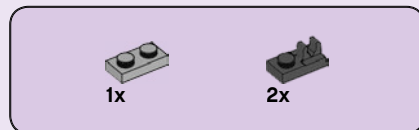
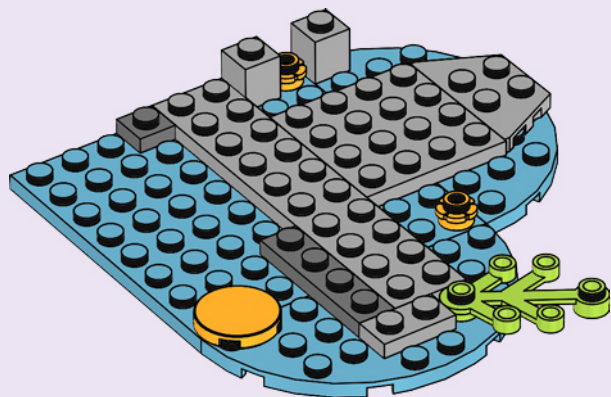

7

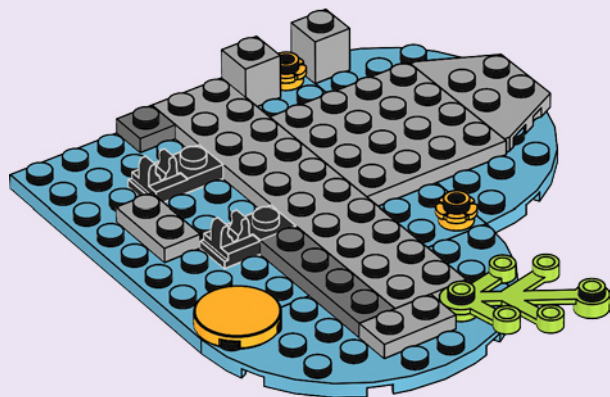

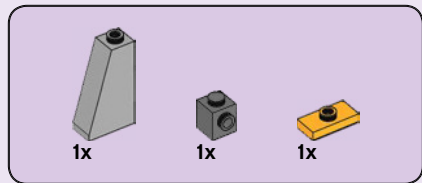

8

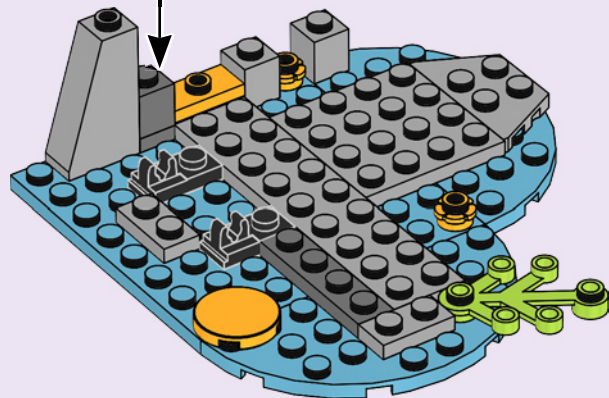
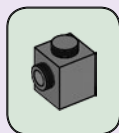

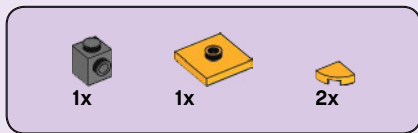

9

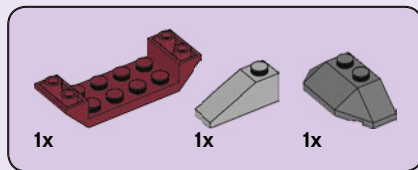
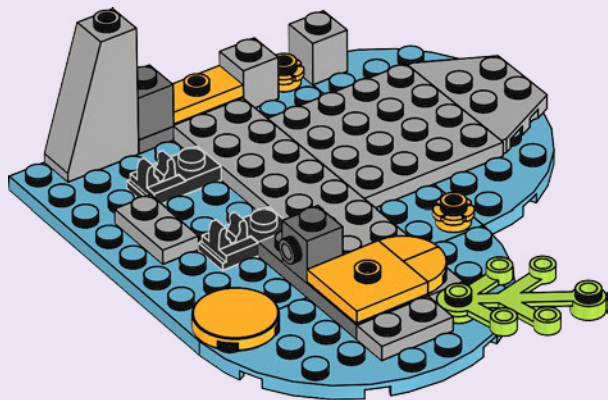

10

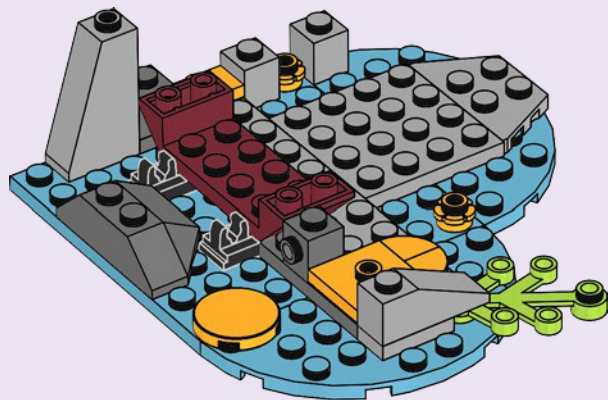



2x



1x

11

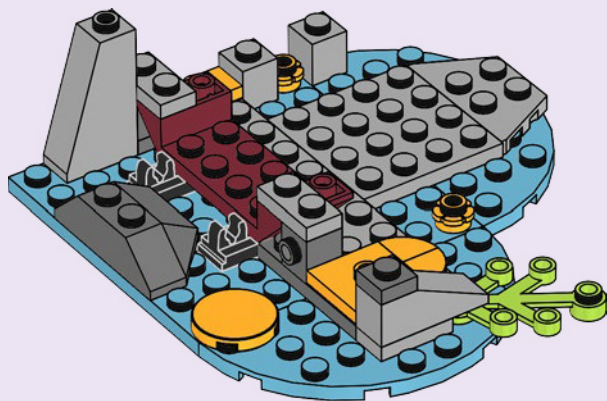

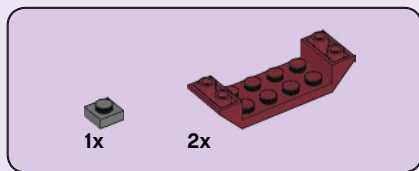

12

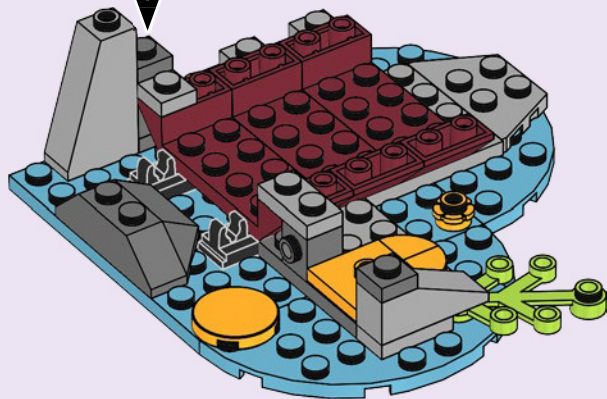
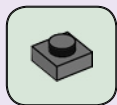

13

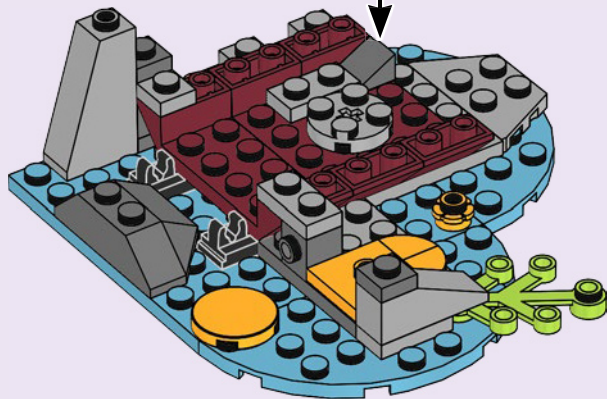

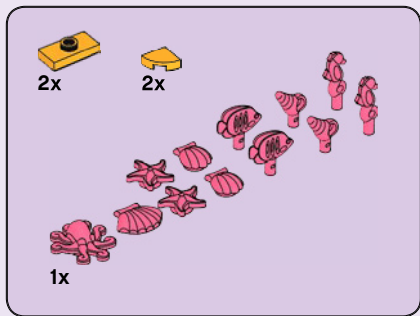

14

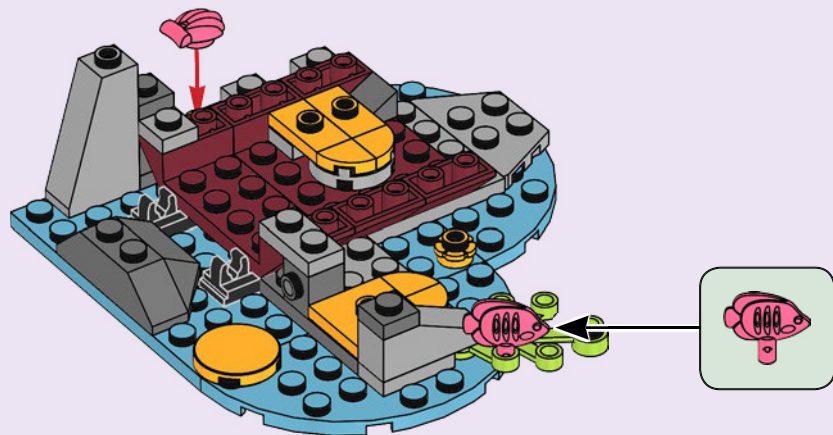

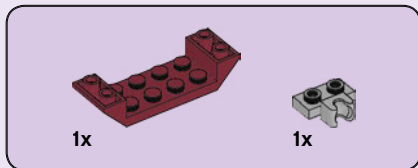

15

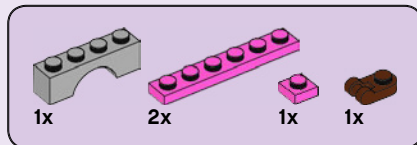
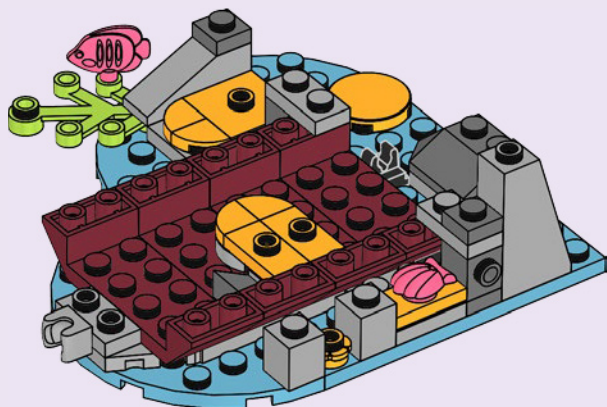

16

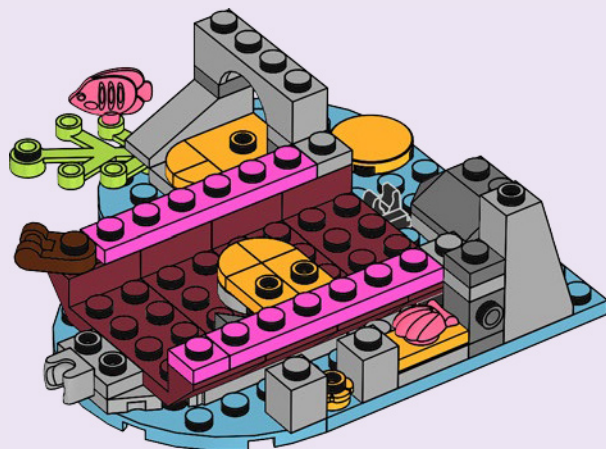

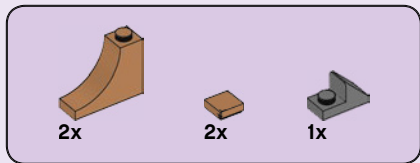

17

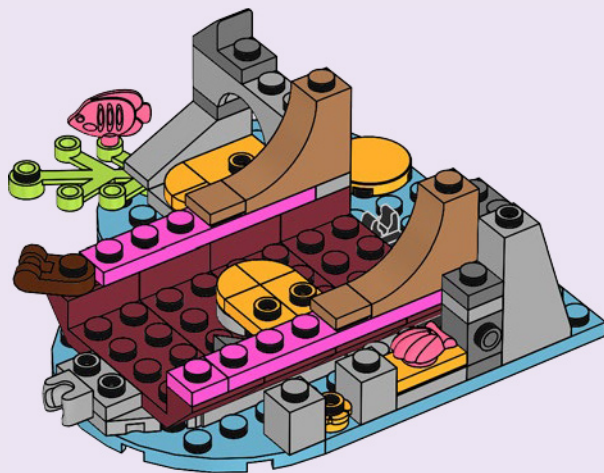



1x



1x

18

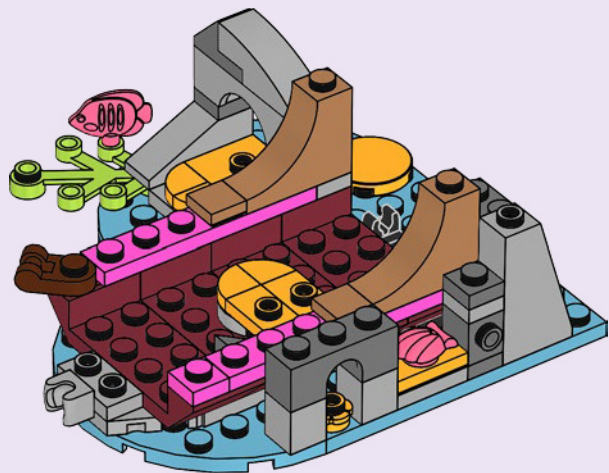

1x



1x

19

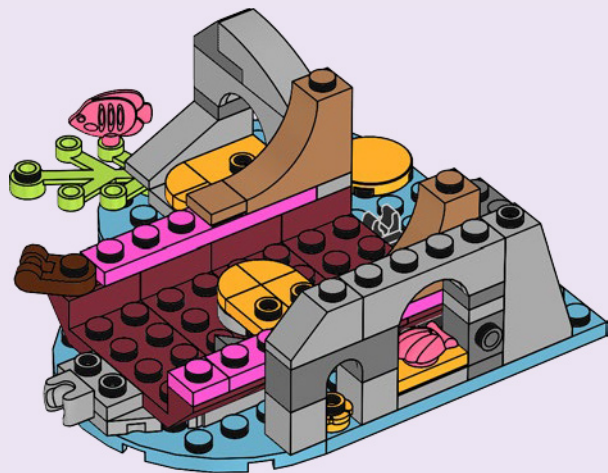

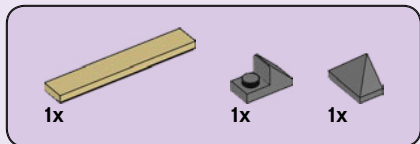

20

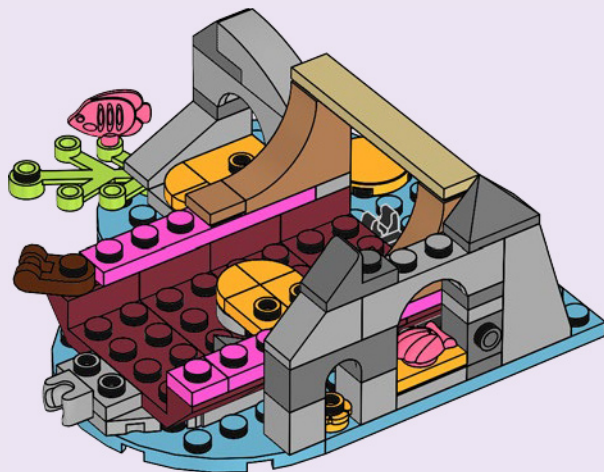

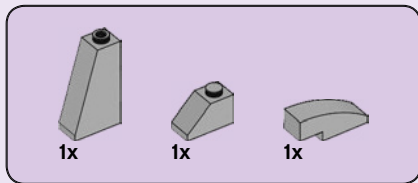

21

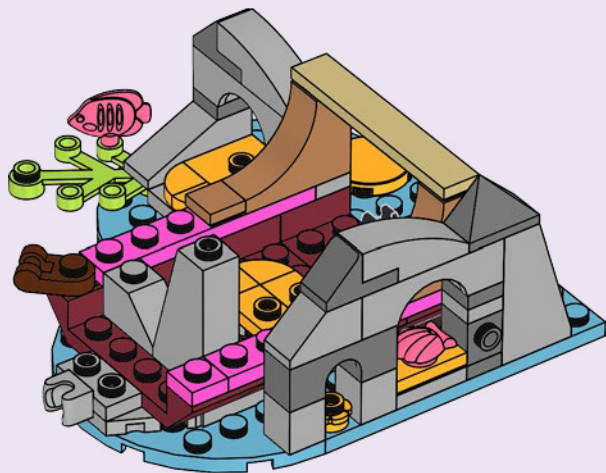



2x

22

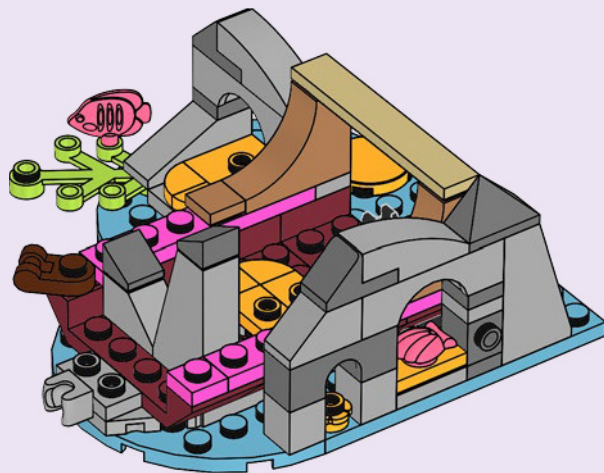



2x

23

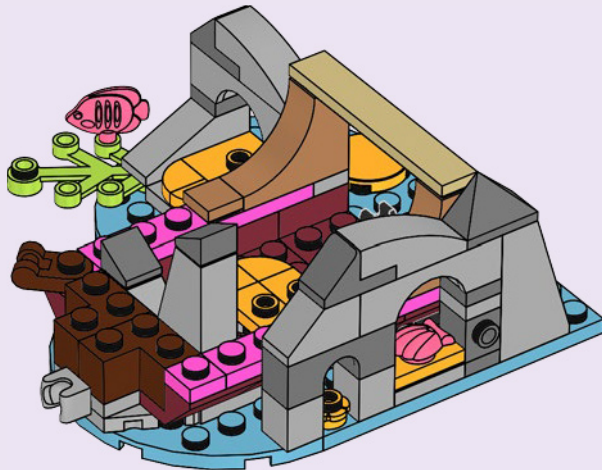



2x

24

1

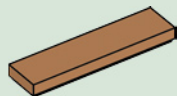

2

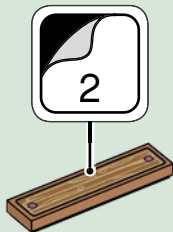

2x

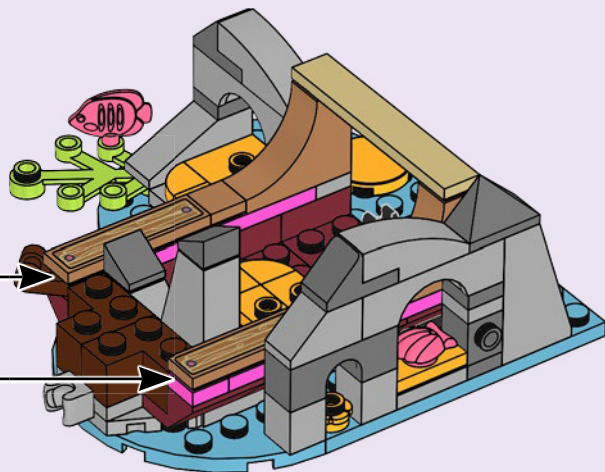



1x



2x

25

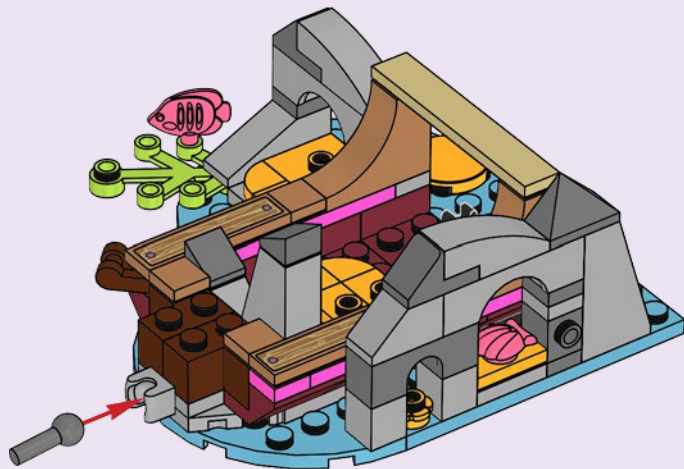



2x

26

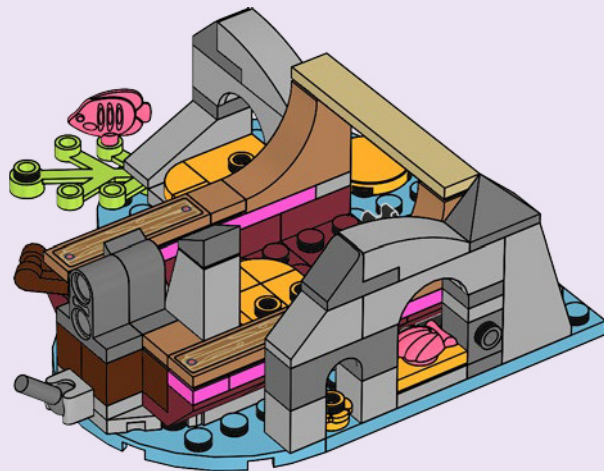

22



27

1



2

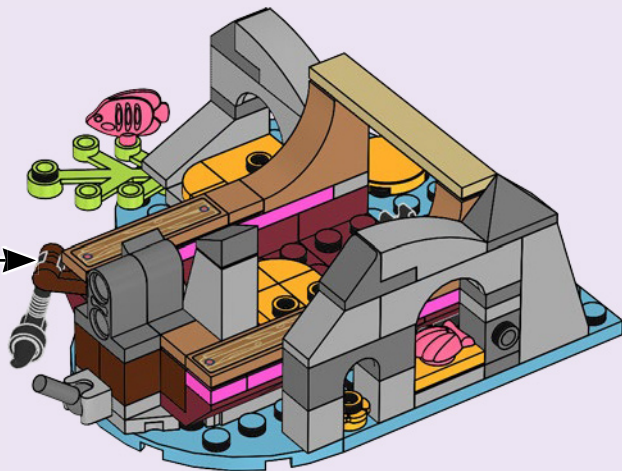



2x



2x

28

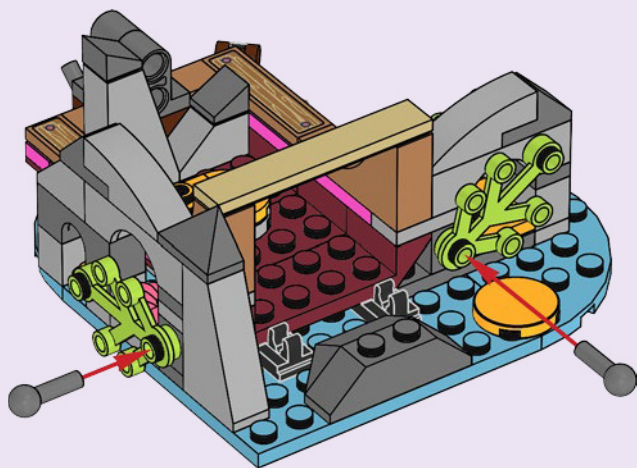



29

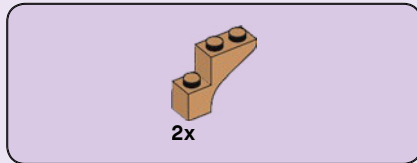

30

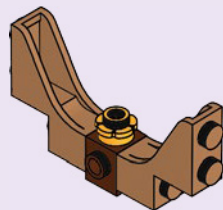



31

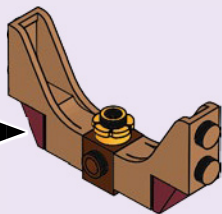

32

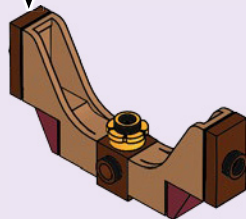

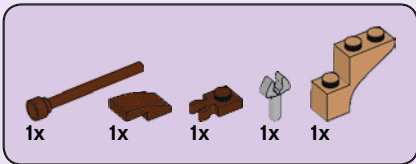
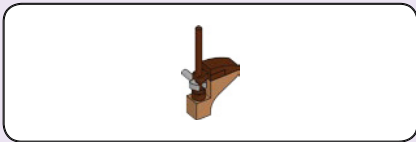

33

1

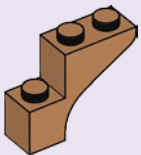

2

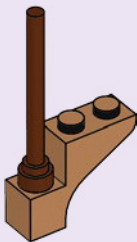

3

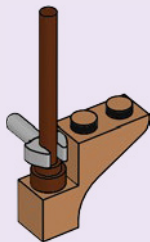

4

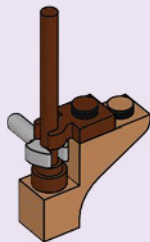

5

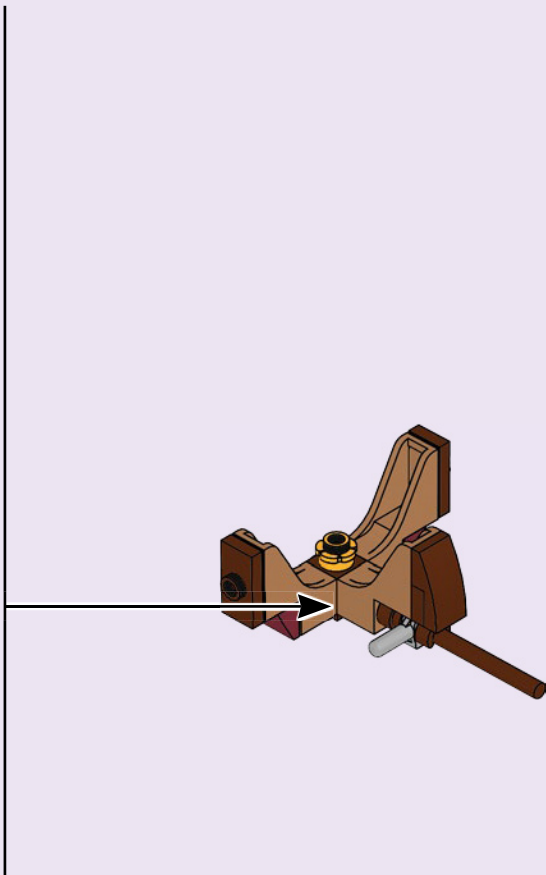
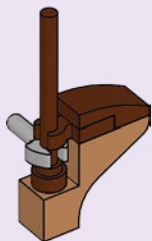

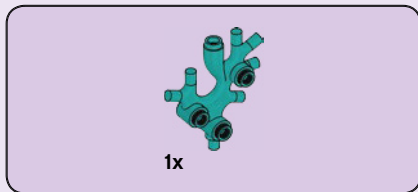

34

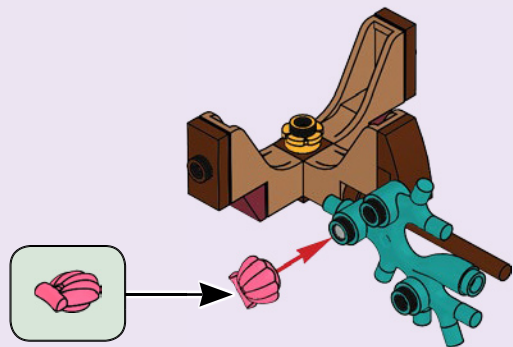

35

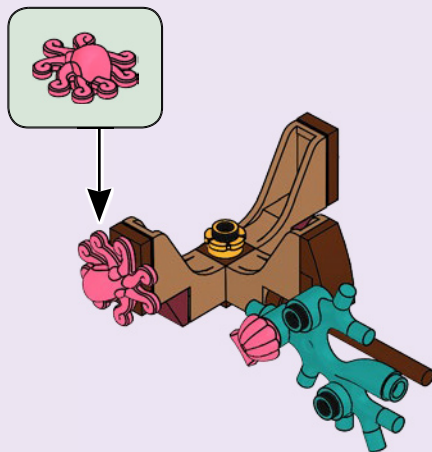

36

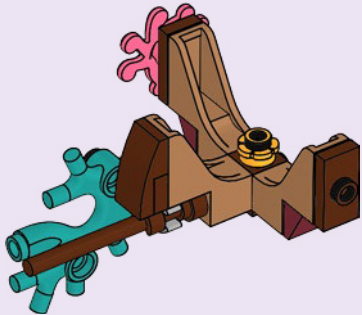

37

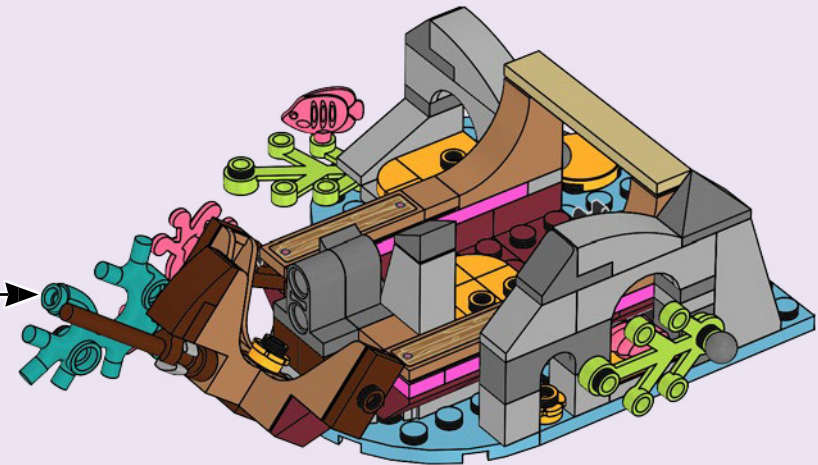



38

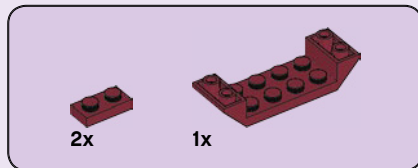
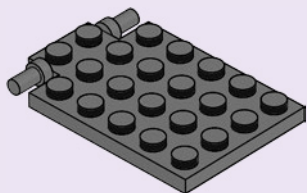

39

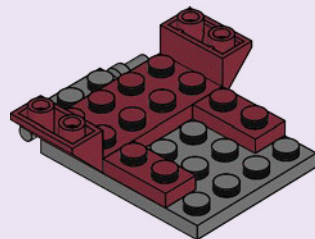

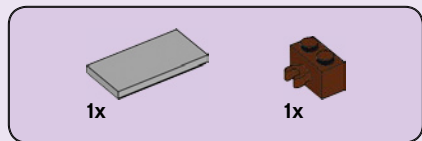

40

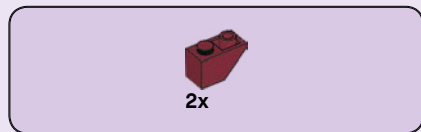
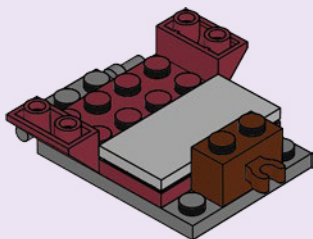

41

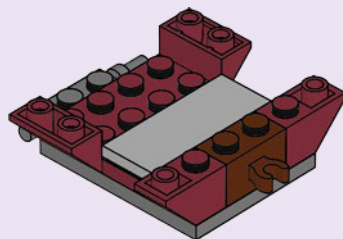

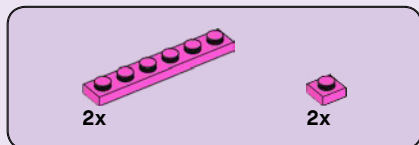

42

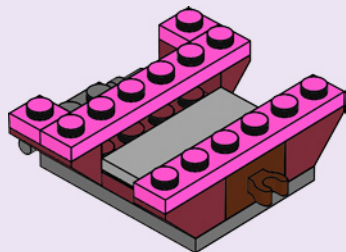

43

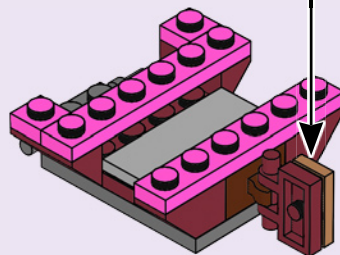
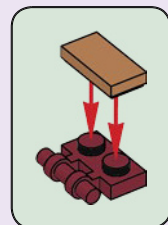

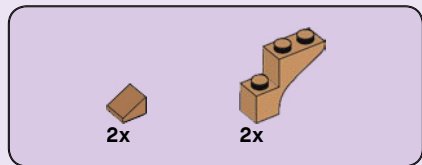

44

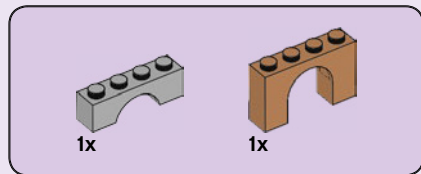
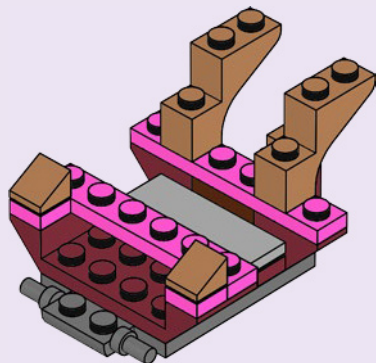

45

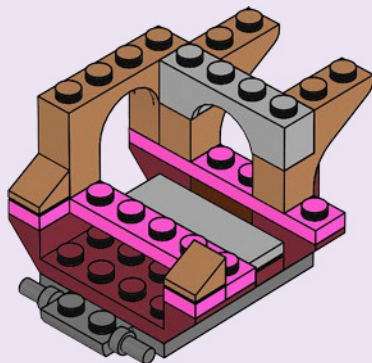

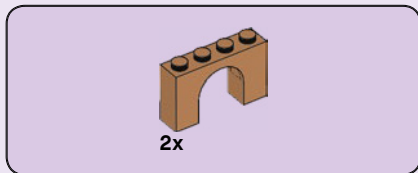

46

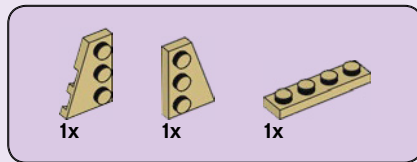
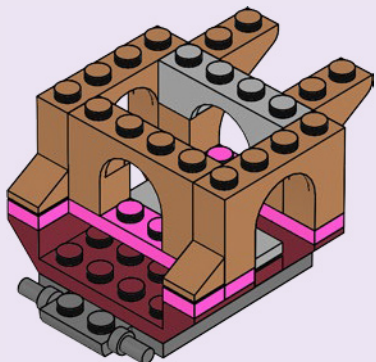

47

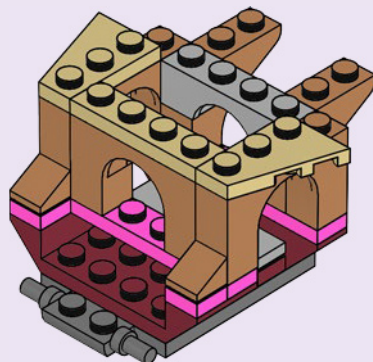

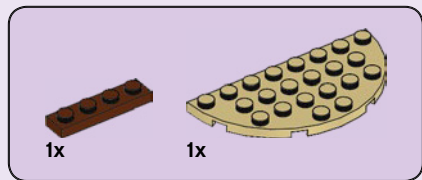

48

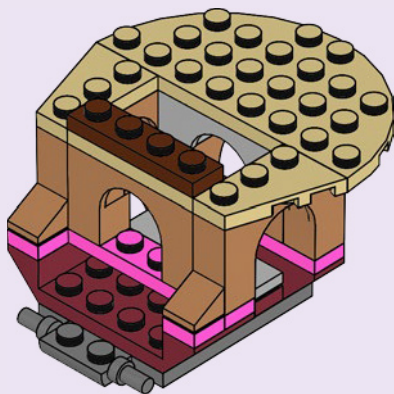

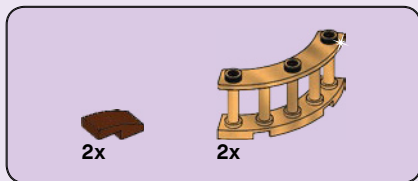

49

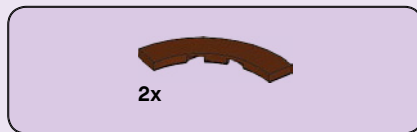
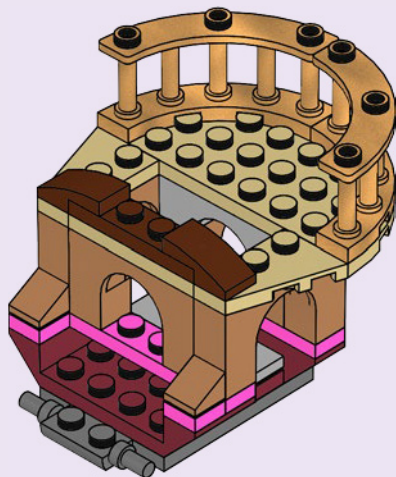

50

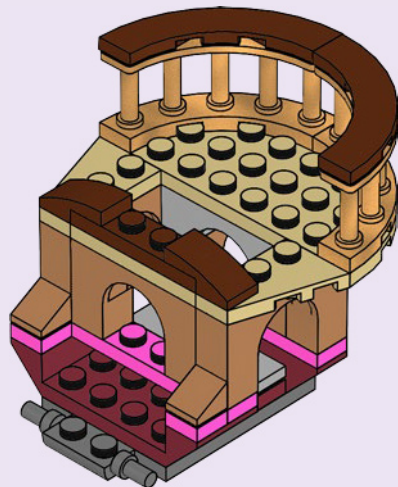

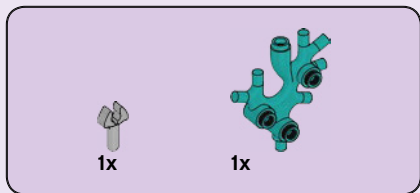

51

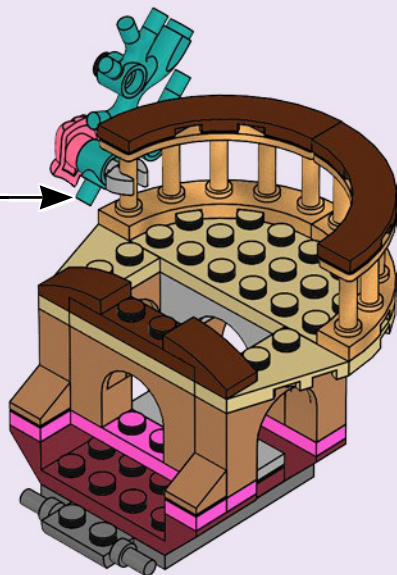
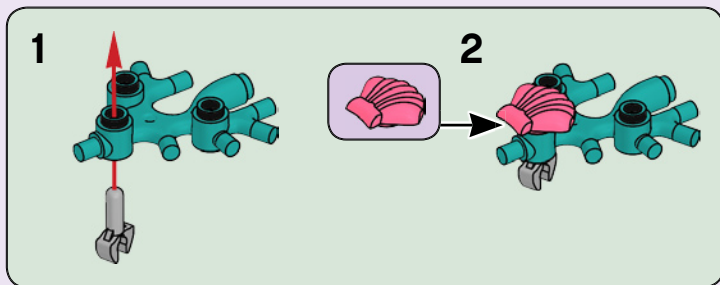



1x



1x

52

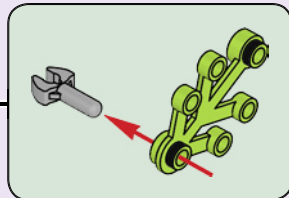
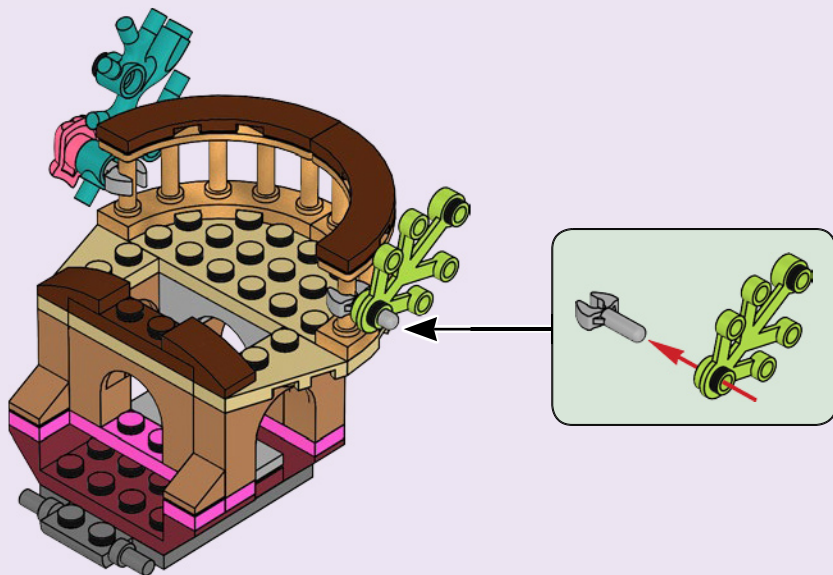

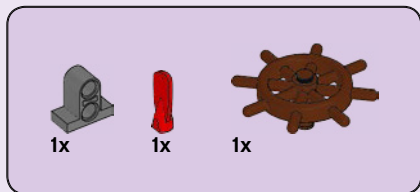

53

1

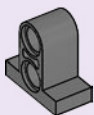

2

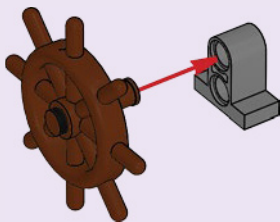

3

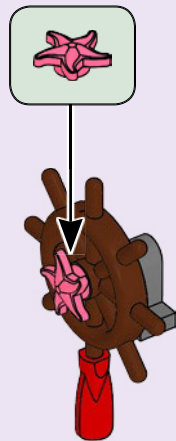

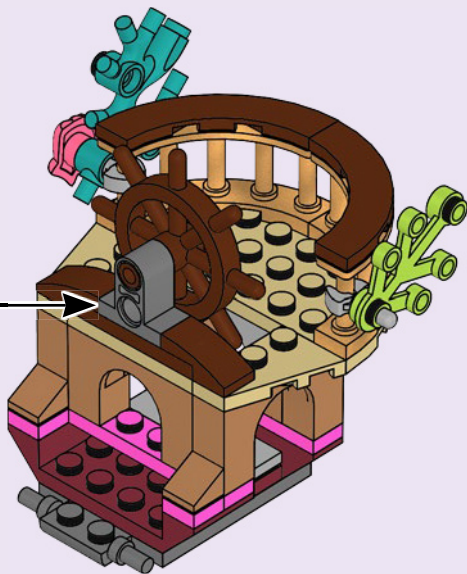

54

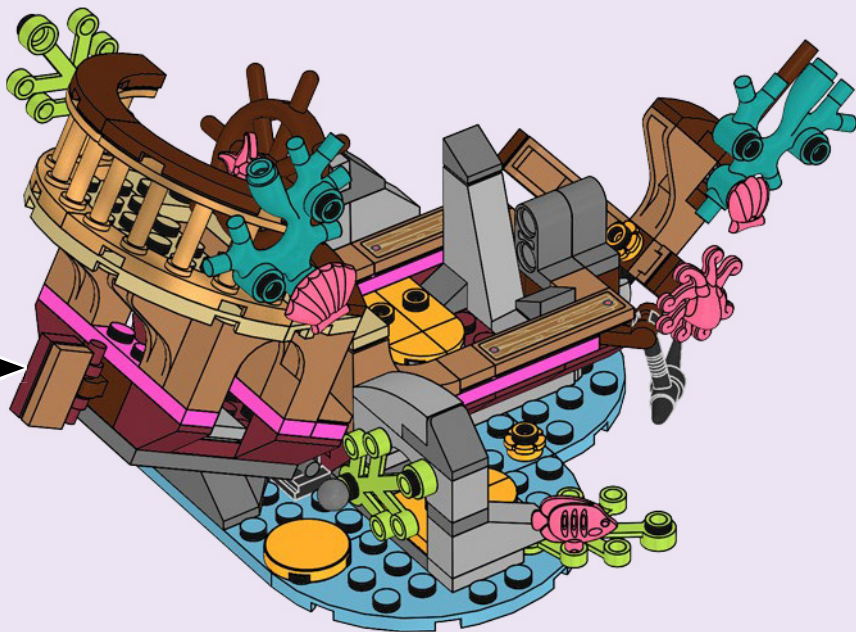

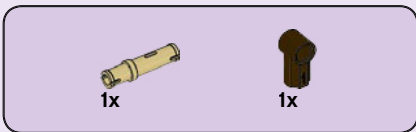
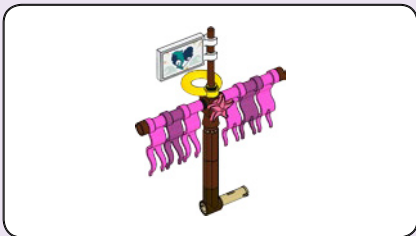

55

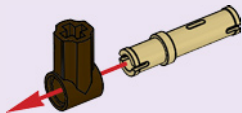

56

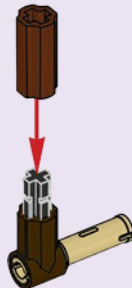



1x



1x

57

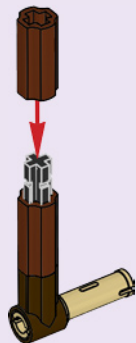

1x



1x

58

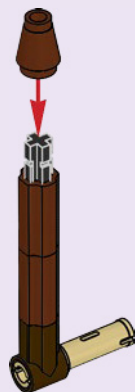

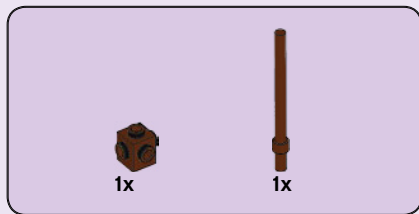

59





60

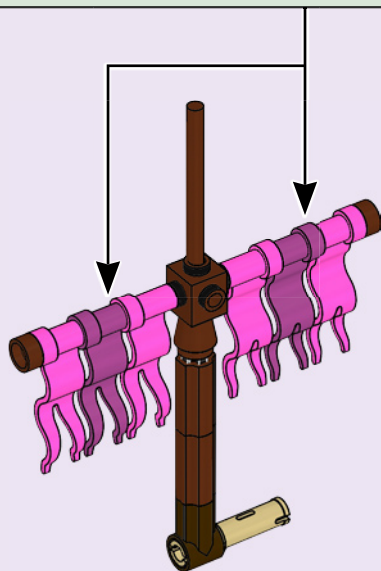
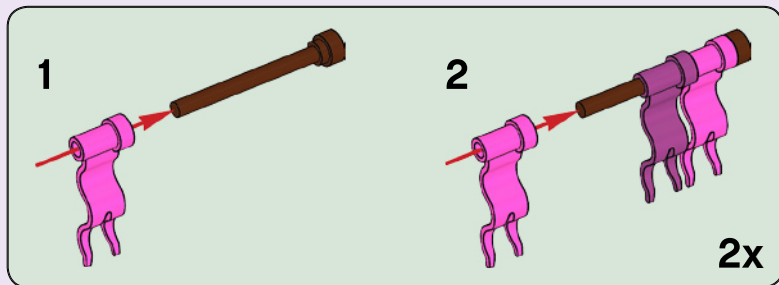



1x

61

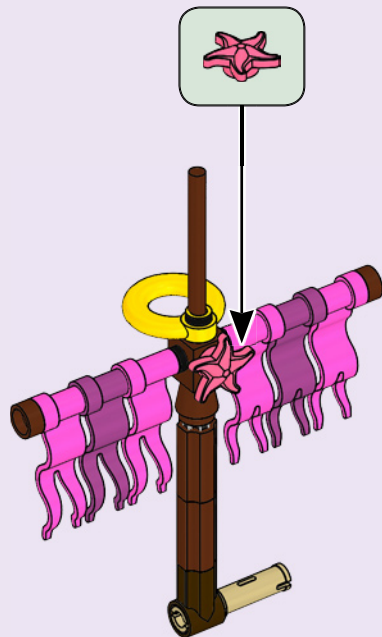

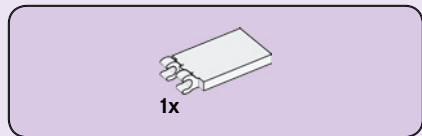

62

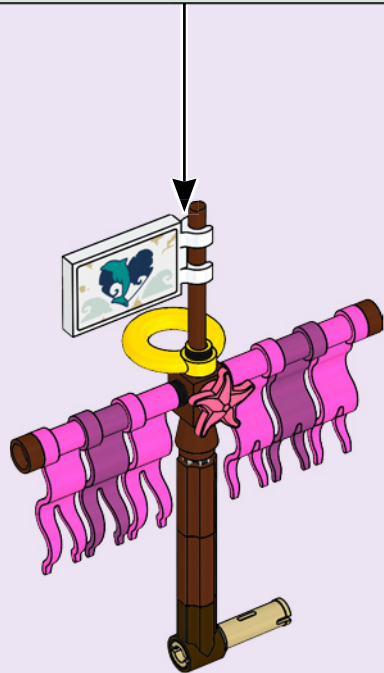

63

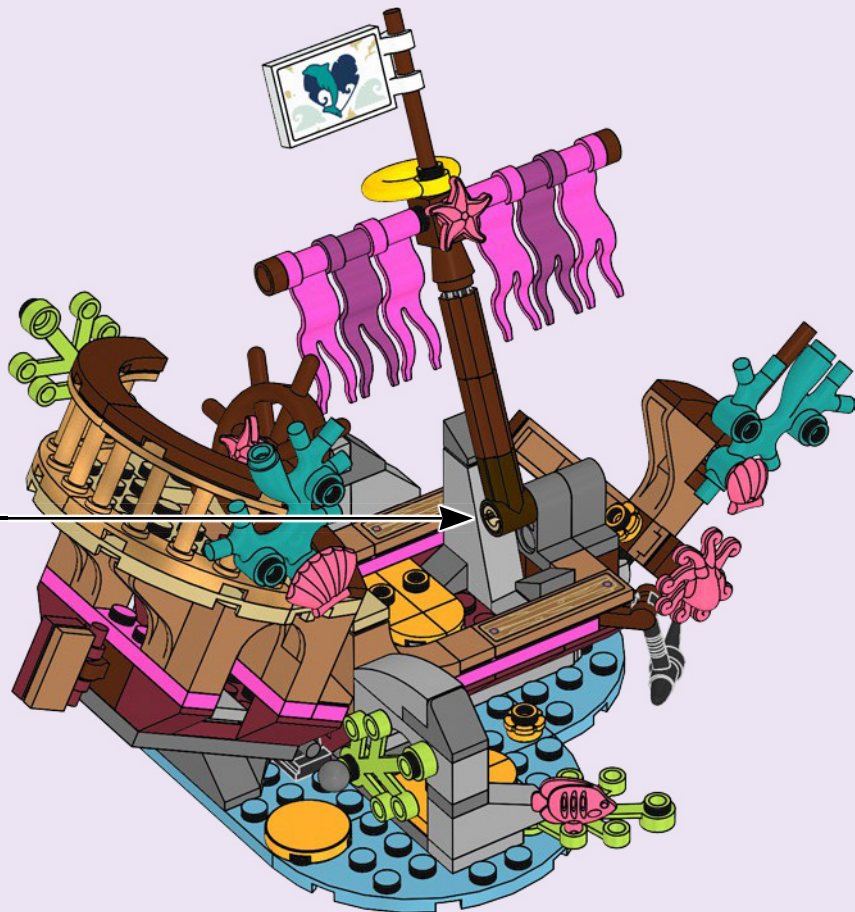



1x







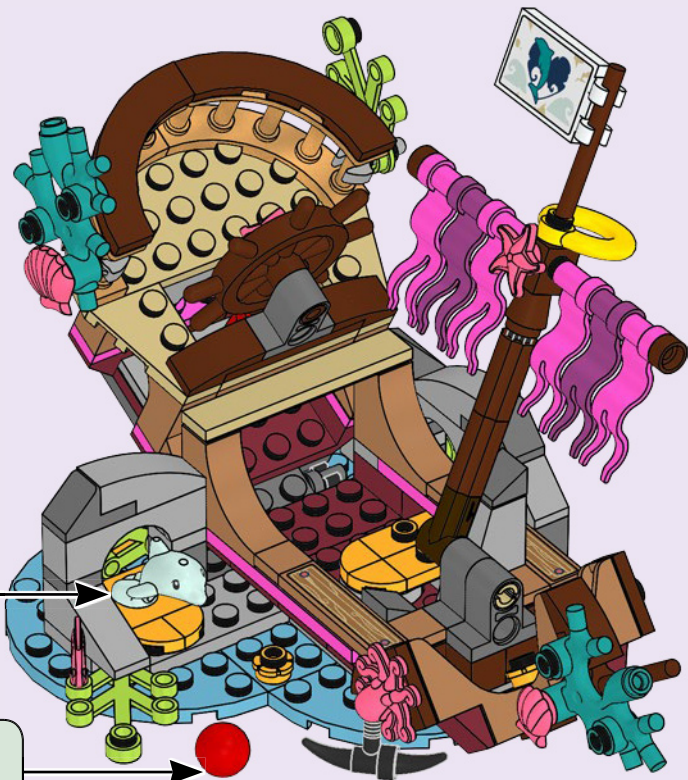
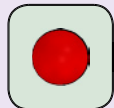

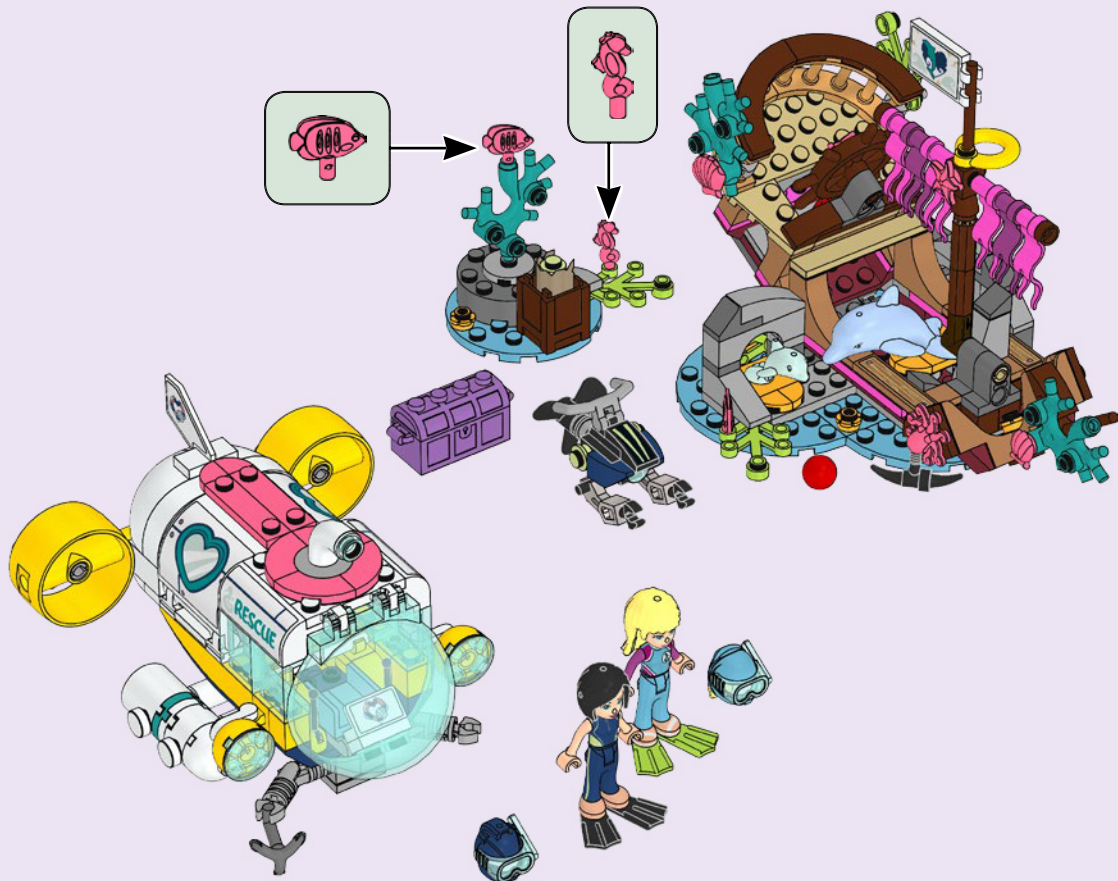

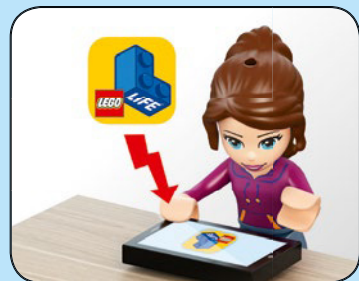





1x

64





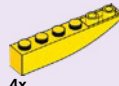

 4x 4646844	 1x 6146215	 1x 6116602	 2x 6102937	 1x 4113233	 2x 4515354	 2x 74156	 1x 6047276
 1x 300501	 4x 6173116	 2x 371001	 2x 389401	 1x 4157277	 2x 4216656	 1x 6168646	 1x 4141580
 2x 6174937	 4x 302301	 1x 4193479	 2x 389401	 1x 6123812	 2x 6173122	 1x 4273590	 3x 604126
 1x 4533763	 4x 4598527	 1x 4599983	 1x 6132772	 1x 6233807	 2x 4188357	 2x 6270103	 2x 6278152
 2x 403201	 1x 4556152	 2x 4586275	 1x 4181142	 1x 4290714	 4x 302324	 1x 4596244	 1x 6247369
 2x 6218899	 1x 4140626	 2x 608101	 1x 6138230	 1x 300421	 1x 4527354	 3x 4109810	 1x 6247798
 2x 4216652	 1x 6093526	 1x 370901	 1x 6228984	 5x 4143005	 2x 302224	 12x 4121715	 3x 6240225
 1x 6194851	 2x 306801	 1x 6192352	 1x 4514554	 3x 4206482	 2x 6100888	 2x 6172936	 1x 6022171
 2x 4194010	 1x 6253365			 2x 6071270	 4x 6175158	 3x 4598528	 1x 6167812
				 2x 300524		 2x 4569733	 2x 6171733



2x
6244761



4x
6253230



1x
6245267



1x
6181886



1x
6247790



2x
6210400



3x
6262134

54



1x
6240042



1x
6086765



2x
6172932



5x
6268818



2x
6133790



1x
6264072



1x
6214811



1x
6127054



1x
6263001



1x
6214812



1x
6251246



1x
6259779



2x
4531415



2x
4539097



2x
4590811



1x
6214312



5x
6175590



4x
6209681



4x
6214457



1x
6131589



3x
6122504



1x
6193972



1x
6170468



1x
4529242



2x
6133765



1x
6153863



1x
6066142



2x
4531751



1x
6127734



3x
6069984



2x
6092590



1x
4520638



2x
4211200



1x
4211190



3x
4538252



1x
6278548



2x
6176608



5x
4542590



2x
4211389



4x
4211535



2x
4211679



2x
4222047



1x
4211475



1x
6179186



2x
4211807



1x
6183782



1x
6043656



1x
6028813



5x
4211398



2x
4211614



2x
4211494



2x
6132886



2x
4515369



1x
4211502



1x
4644102



2x
4251163



1x
4211488



1x
4507056



3x
4211435



2x
4211445



1x
4560183



2x
4243797



Customer Service

Kundenservice

Service Consommateurs

Servicio Al Consumidor

LEGO.com/service or dial



: 00800 5346 5555

: 1-800-422-5346



41376

A LEGO Friends set (41376) featuring a tropical island with a wooden building, a yellow boat, and various accessories like a lifebuoy and a small boat.



41378

A LEGO Friends set (41378) featuring a large white and red boat with a yellow lifebuoy, a small boat, and various accessories like a lifebuoy and a small boat.



41381

A LEGO Friends set (41381) featuring a large white and red boat with a yellow lifebuoy, a small boat, and various accessories like a lifebuoy and a small boat.



41380

A LEGO Friends set (41380) featuring a large white and red boat with a yellow lifebuoy, a small boat, and various accessories like a lifebuoy and a small boat.

LEGO

Friends™

LEGO, the LEGO logo and the FRIENDS logo are trademarks of the/son des marques de commerce du/son marcas registradas de LEGO Group. ©2019 The LEGO Group. 6282687