



# Mixels™

41548



# DRIBBAL



 [LEGO.com](http://LEGO.com)

6126535

1

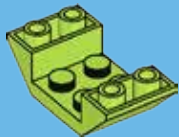

2

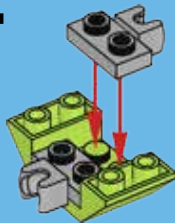

3

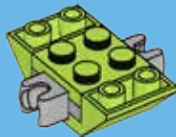

4

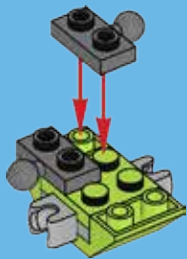

5

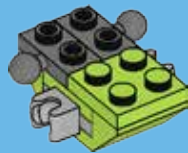

6



7

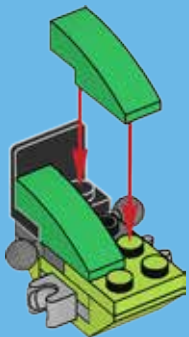

8



1

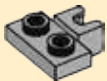

2

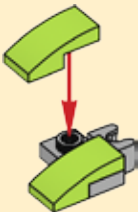

3



9

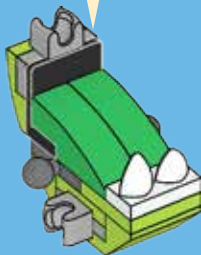

1

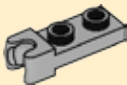

2

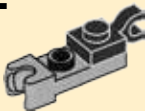

3

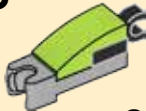

2x

10

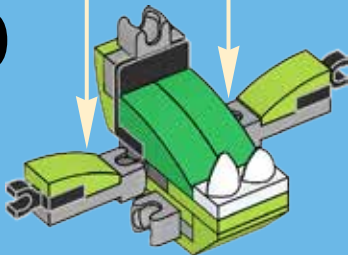

1



2

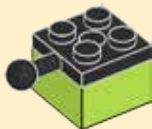

3



2x

11

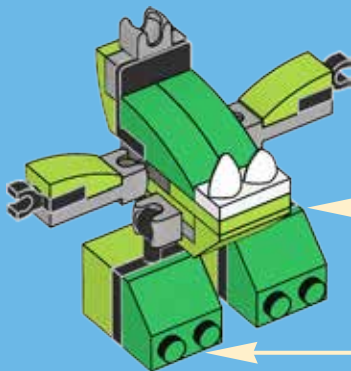



12

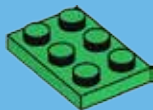

13



14

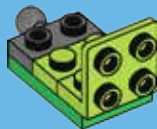



15

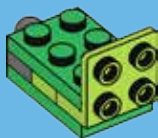

16

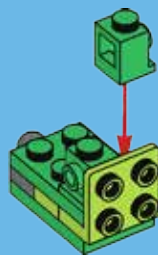

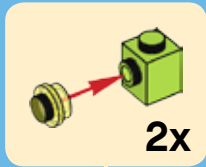

17

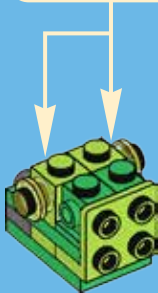

18

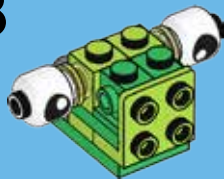



19



20

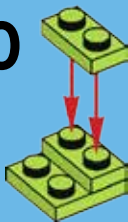

21



22

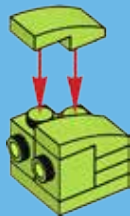

23

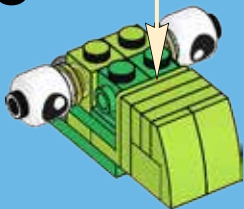

24

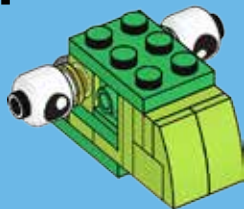

25

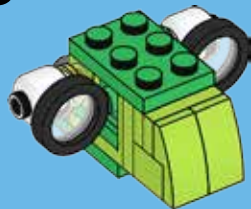

26

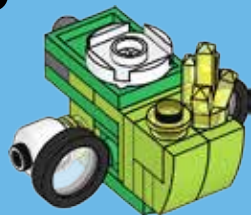

27



28

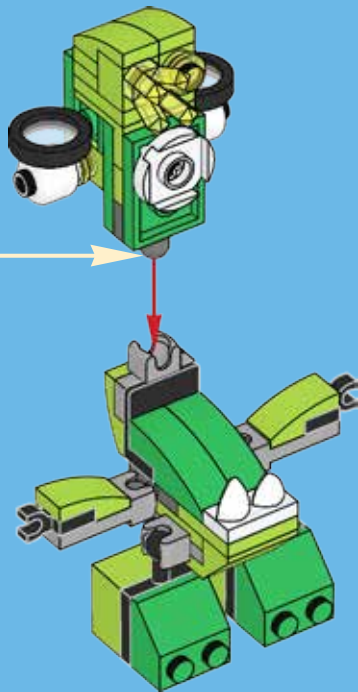

29

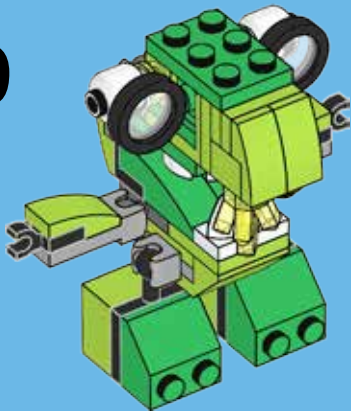



3x  
6043656



4x  
6073026



6x  
6069006



1x  
403201



2x  
4187334



2x  
6043639



2x  
4220632



3x  
4164037



2x  
6060802



2x  
303928



3x  
6039479



1x  
6110067



3x  
4537937



1x  
6046384



2x  
6039946



3x  
302128



**Customer Service**

**Kundenservice**

**Service Consommateurs**

**Servicio Al Consumidor**

**LEGO.com/service or dial**



**00800 5346 5555 :**



**1-800-422-5346 :**



1x  
6094031



2x  
4517925



1x  
6000650



2x  
6051038



2x  
6012466



3x  
3005749



1x  
4540417





**DRIBBAL  
41548**



**GLORP CORP  
MAX!**



**GURGGLE  
41549**



**SLUSHO  
41550**



[LEGO.com/mixels](http://LEGO.com/mixels)





# Mixels™



**41545  
KRAMM**



**41546  
FORX**



**41547  
WUZZO**



**41548  
DRIBBAL**



**41549  
GURGGLE**



**41550  
SLUSHO**



**41551  
SNAX**



**41552  
BERP**



**41553  
VAKA-WAKA**



[LEGO.com/mixels](http://LEGO.com/mixels)





**YOU CAN BUY THE GAME!  
TU PEUX ACHETER LE JEU!  
¡PUEDES COMPRAR EL JUEGO!**

**D R O O 1 D R A W 1**

**IN GAME CODE!  
CODE DANS LE JEU!  
¡CÓDIGO PARA EL JUEGO!**



# Mixels RUSH



Apple, the Apple logo, iPad, iPhone and iPod touch are trademarks of Apple Inc., registered in the U.S. and other countries. App Store is a service mark of Apple Inc.

Apple, le logo Apple, iPad, iPhone et iPod touch sont des marques de commerce d'Apple Inc., déposées aux États-Unis et dans d'autres pays. App Store est une marque de service d'Apple Inc.

Apple, el logotipo de Apple, iPad, iPhone e iPod touch son marcas comerciales de Apple Inc. registradas en EE. UU. y otros países. App Store es una marca de servicio de Apple Inc.

Google Play is a trademark of Google Inc.

Google Play est une marque de commerce de Google Inc.

Google Play es una marca comercial de Google Inc.