



# TECHNIC

42023



EXCAVATOR

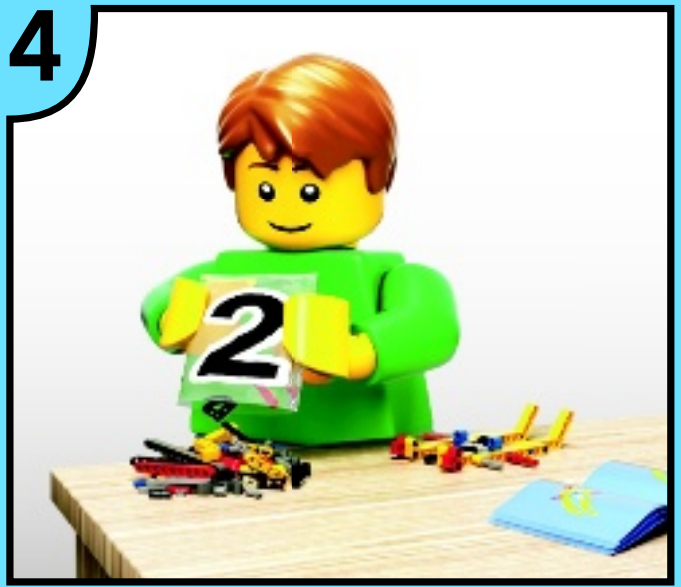





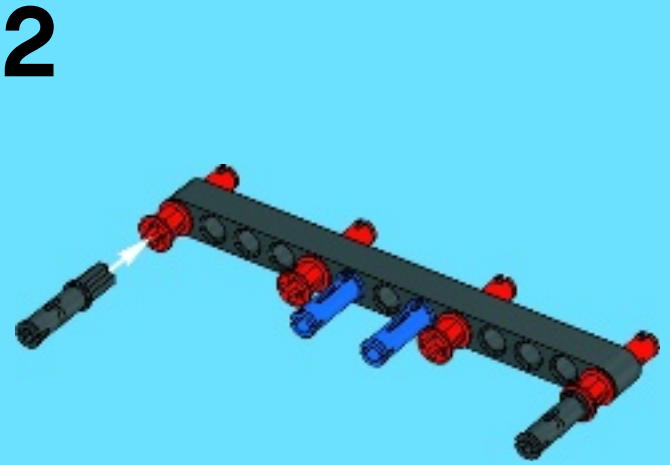
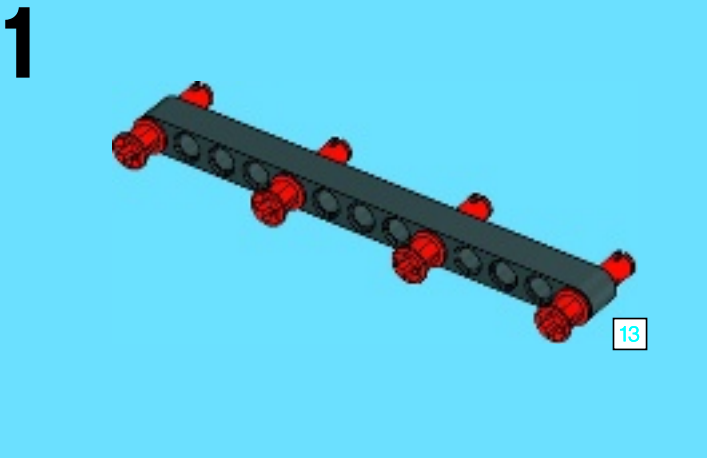
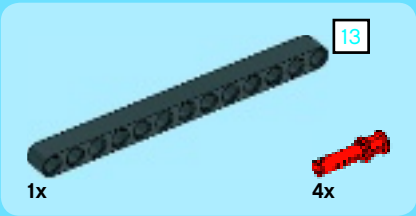
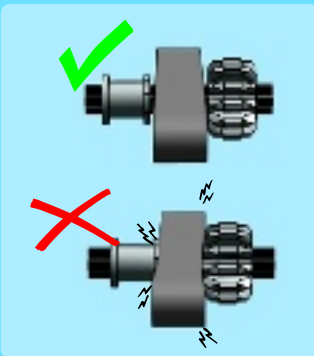
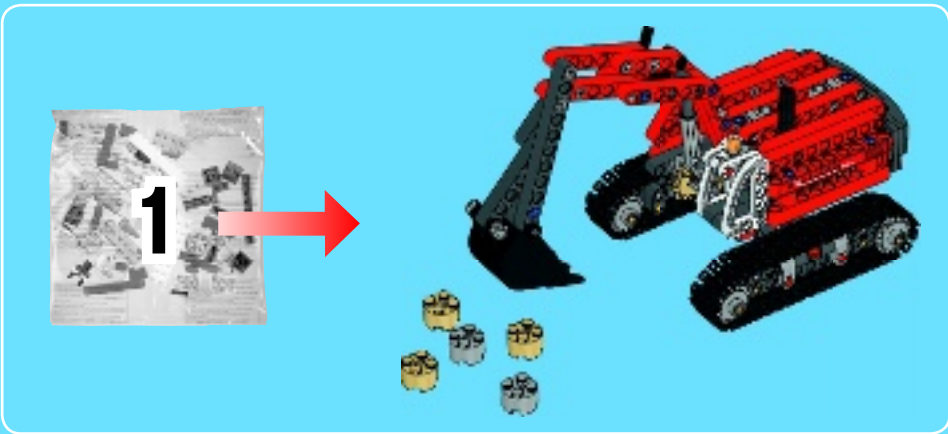



1x



1x



2x

# 3

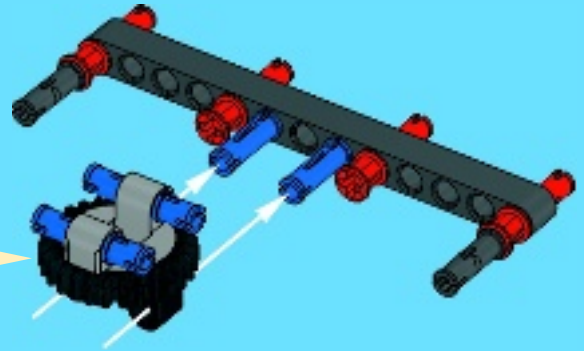
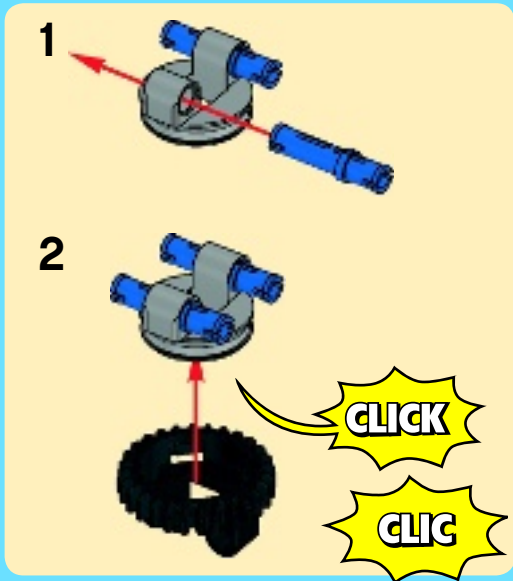



4

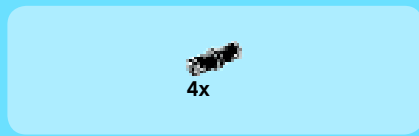
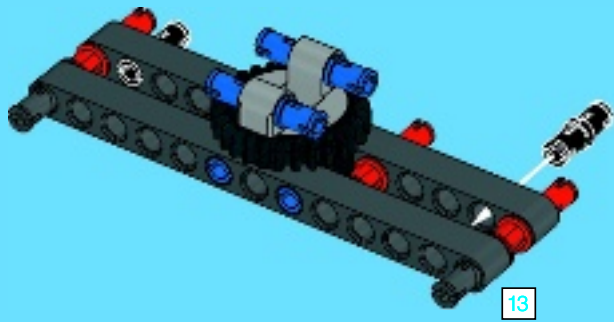

5

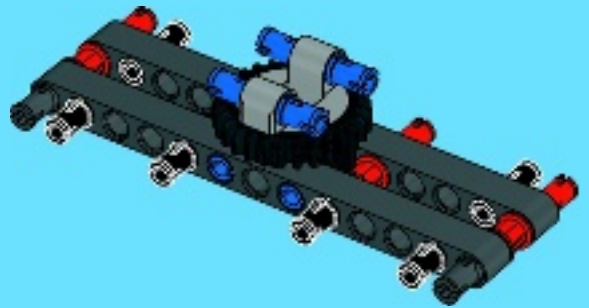

6



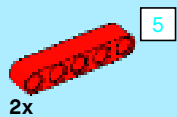

6

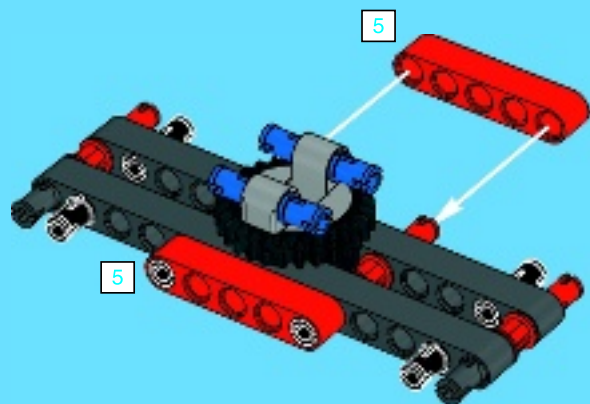

4x



4x



4x

7

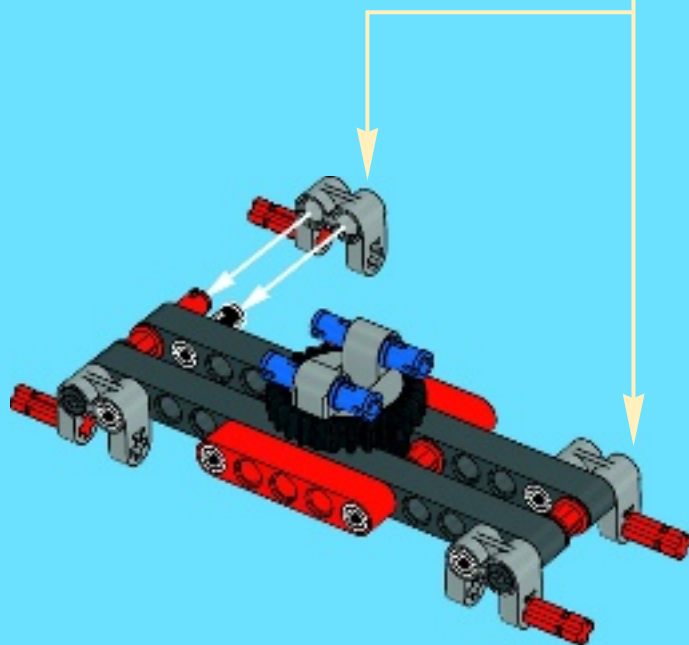

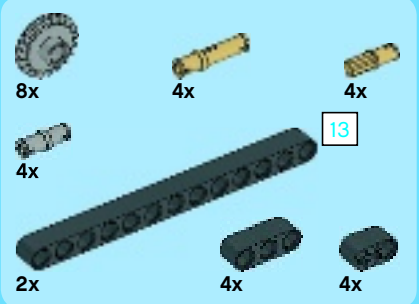

8

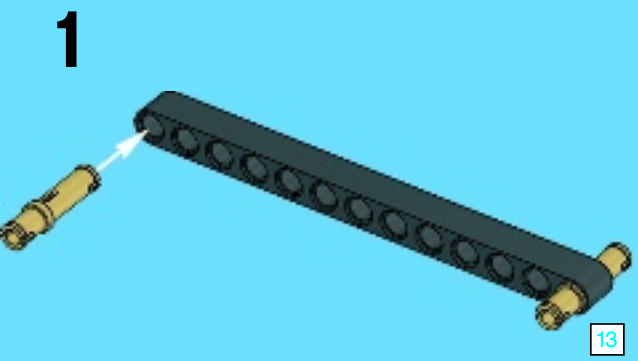

13

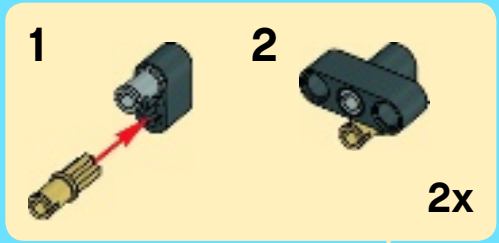

2

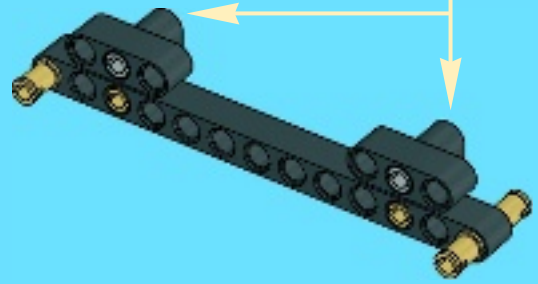

3

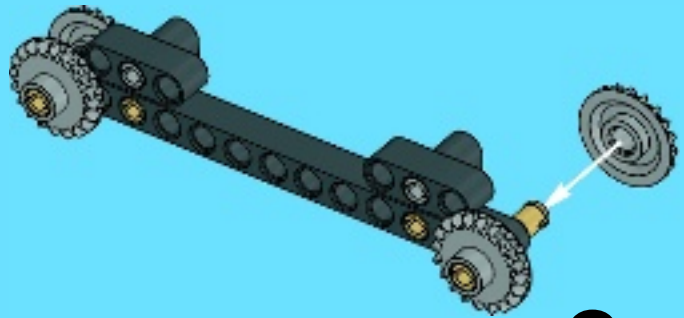

2x



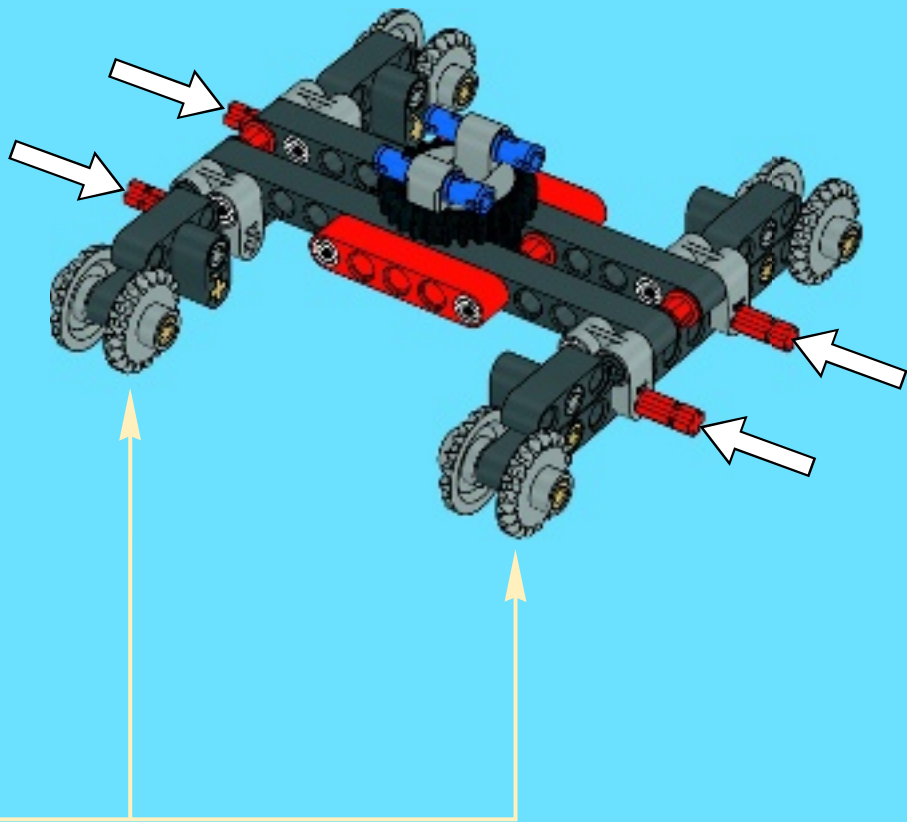



80x

9

40x

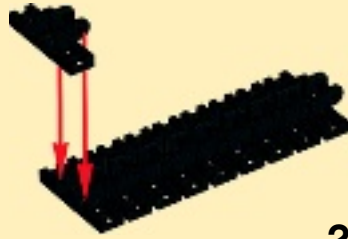

2x

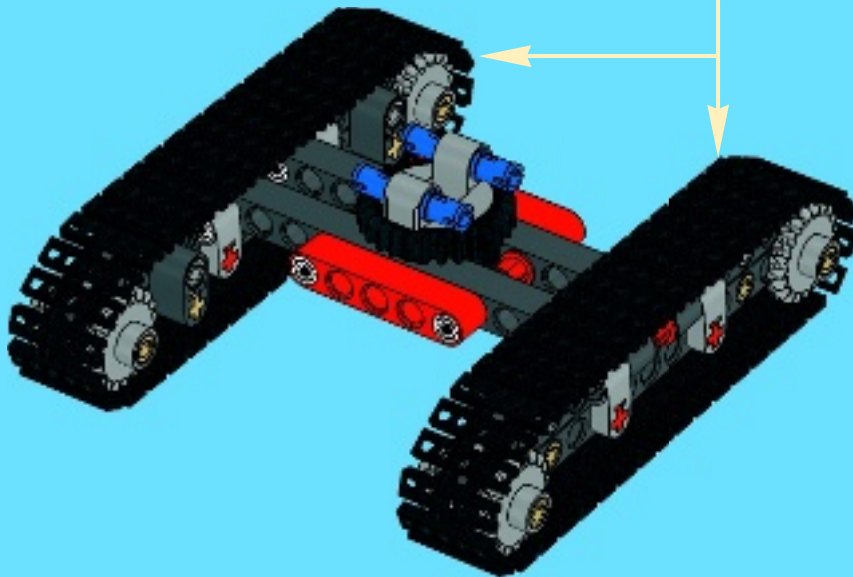

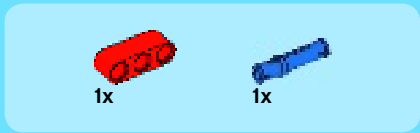

1

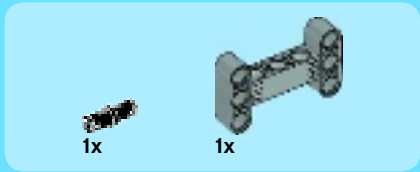
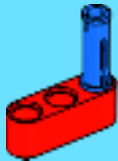

2

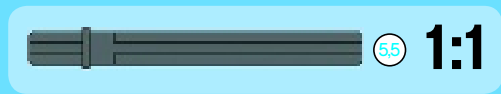

3

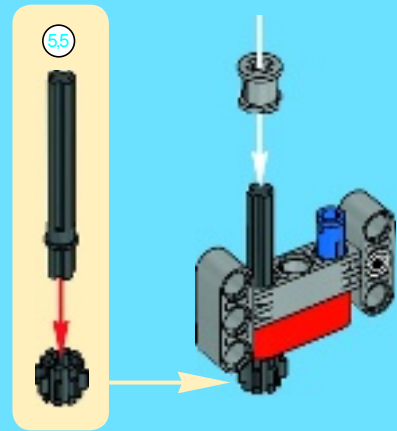



2x

4

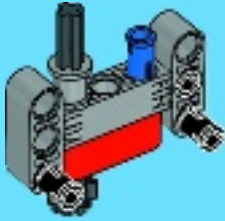

1x

5

5

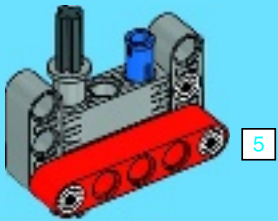

1x



1x

6

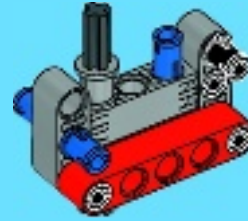

1x



1x

7

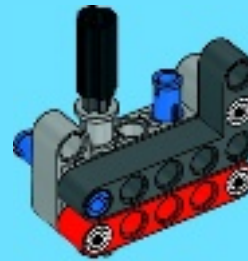

5

1:1

10

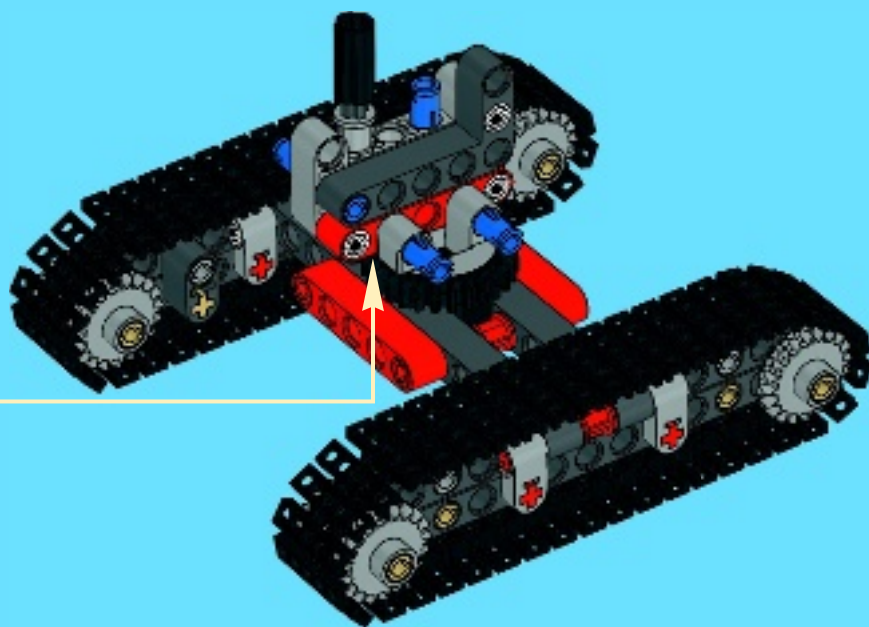



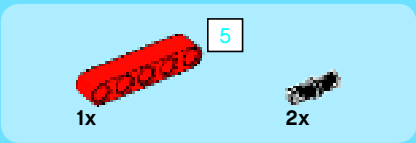

# 11

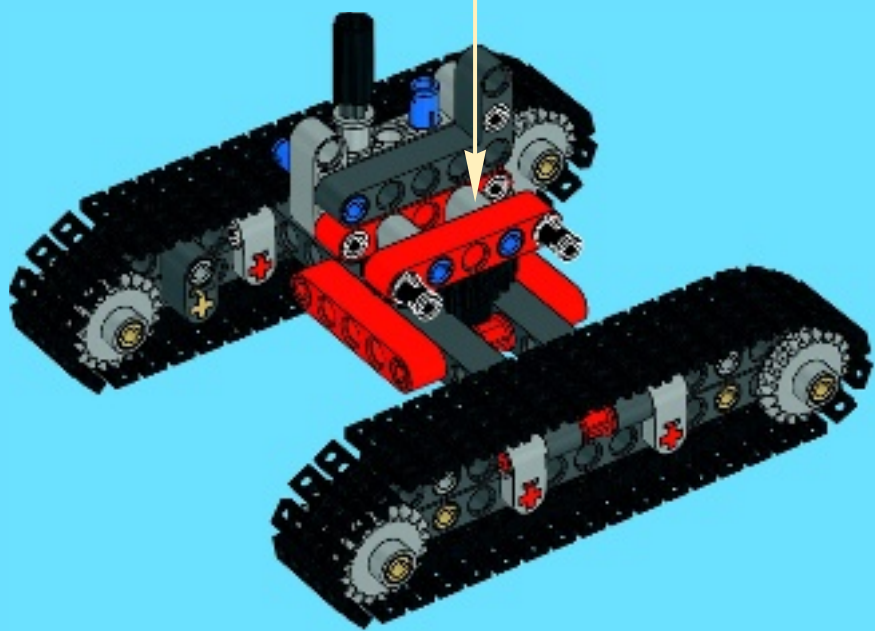
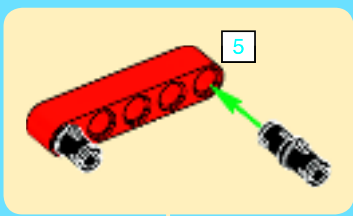

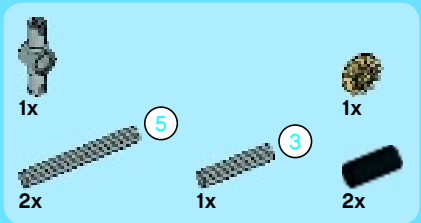
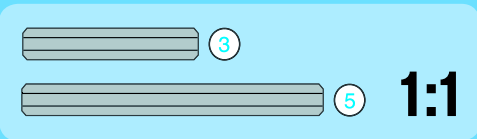

12 1



2



3

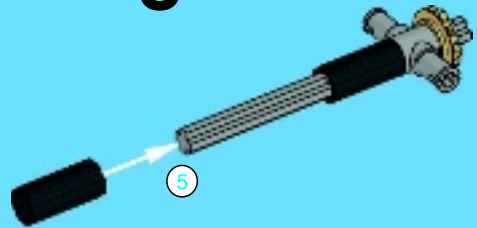

4

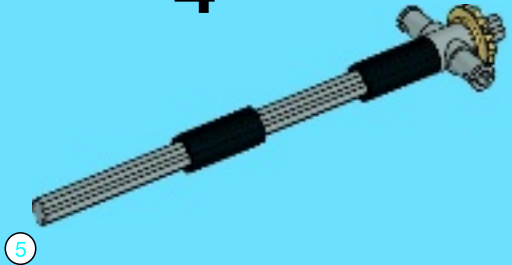

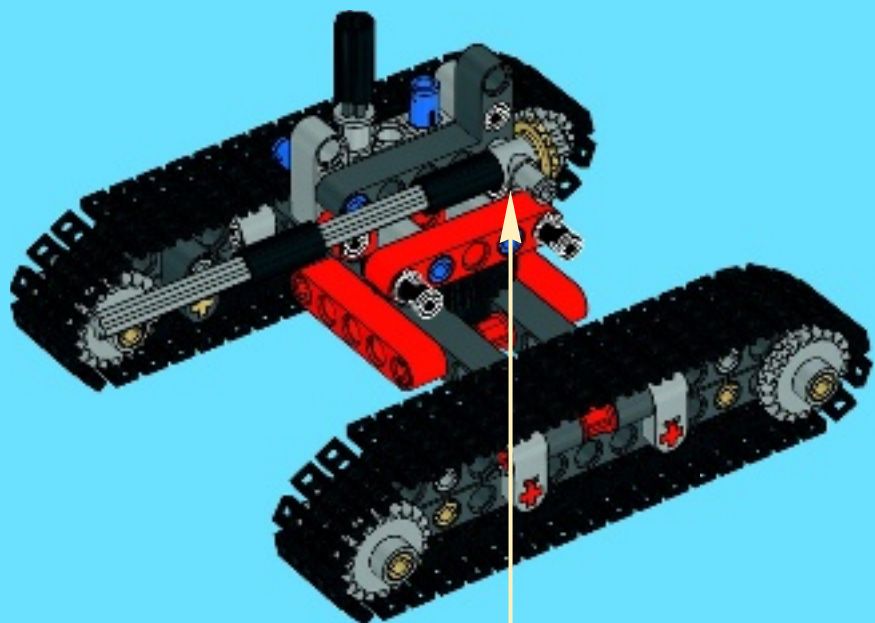

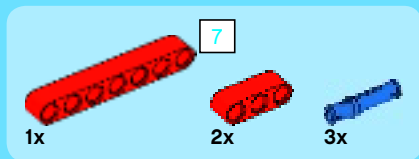

# 13

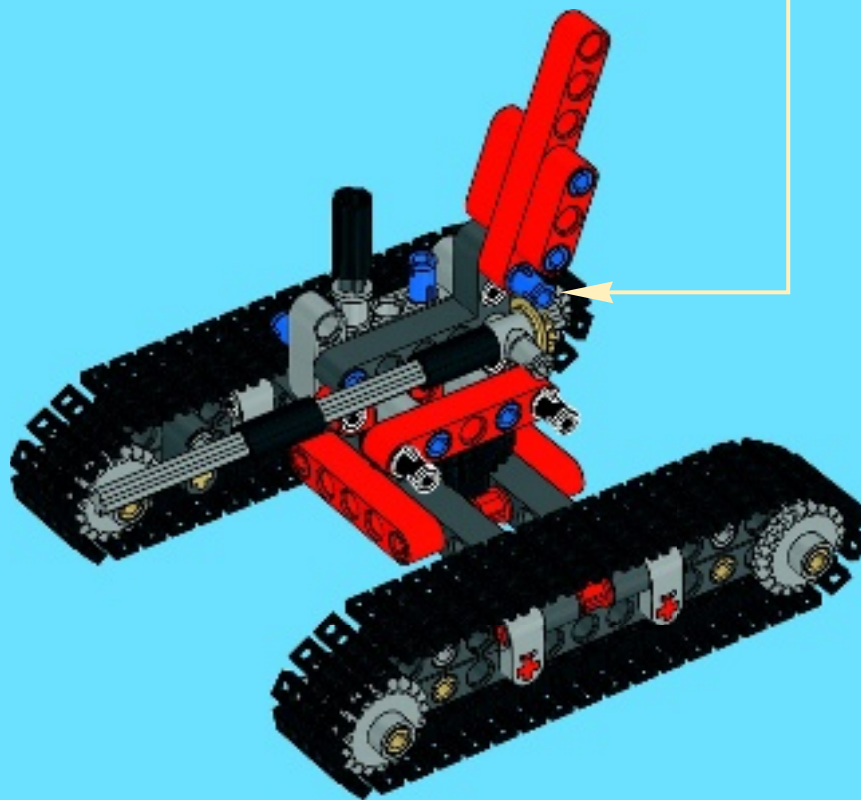
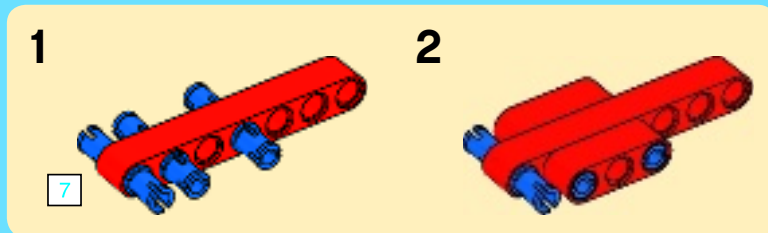

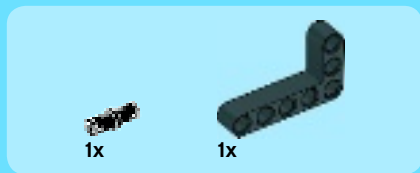

14

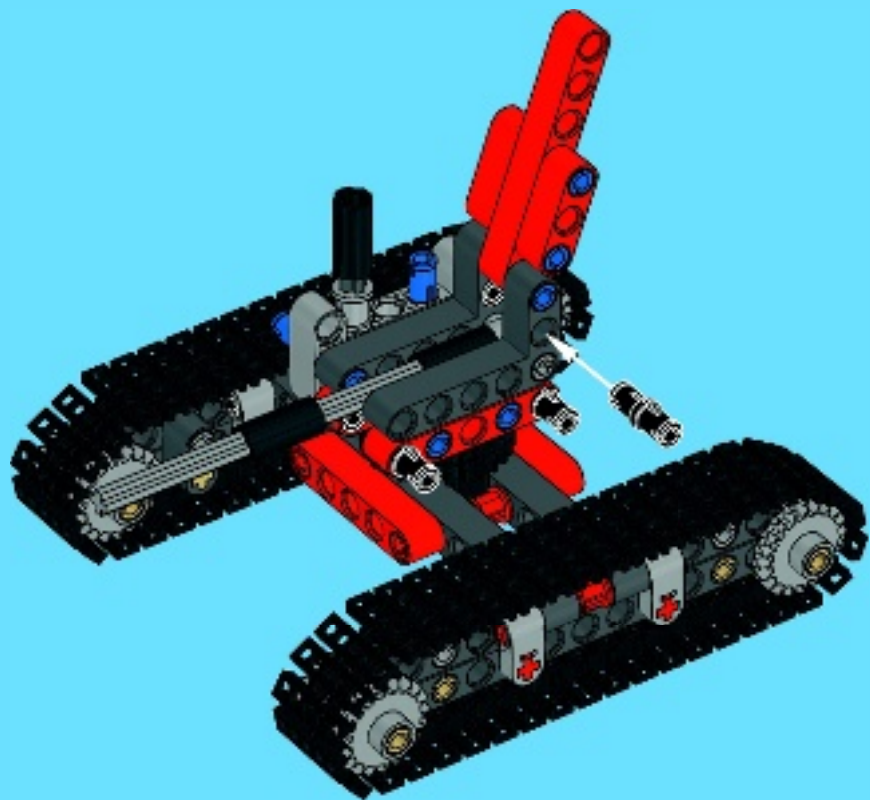



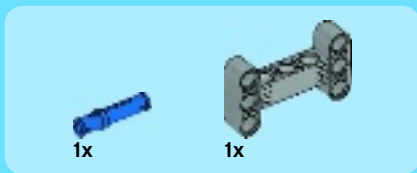

15

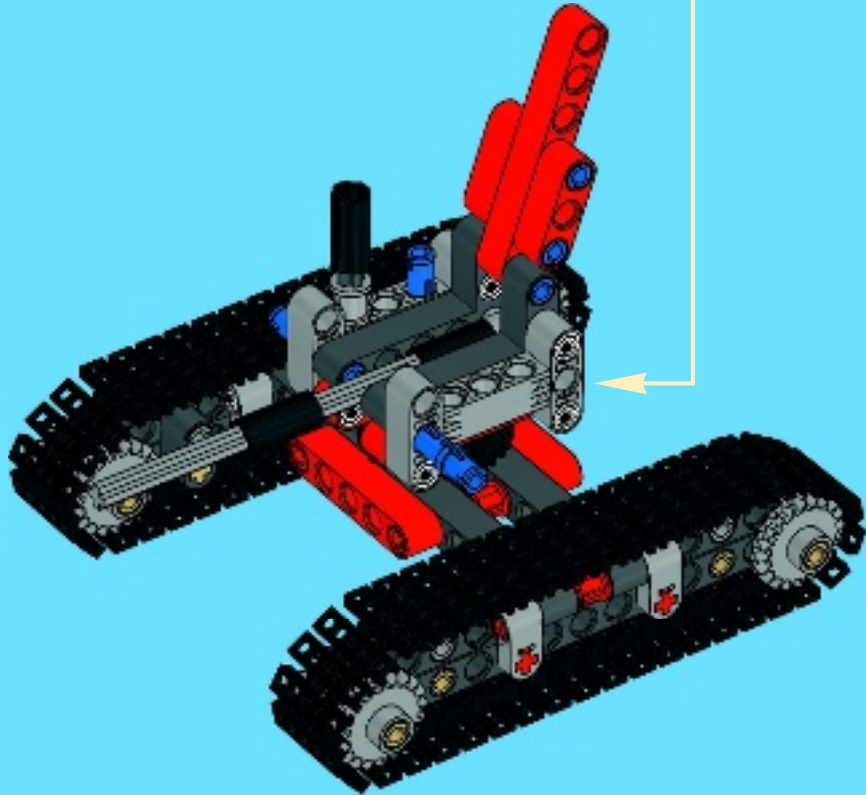
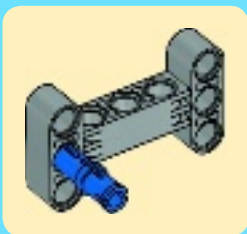



2x

# 16

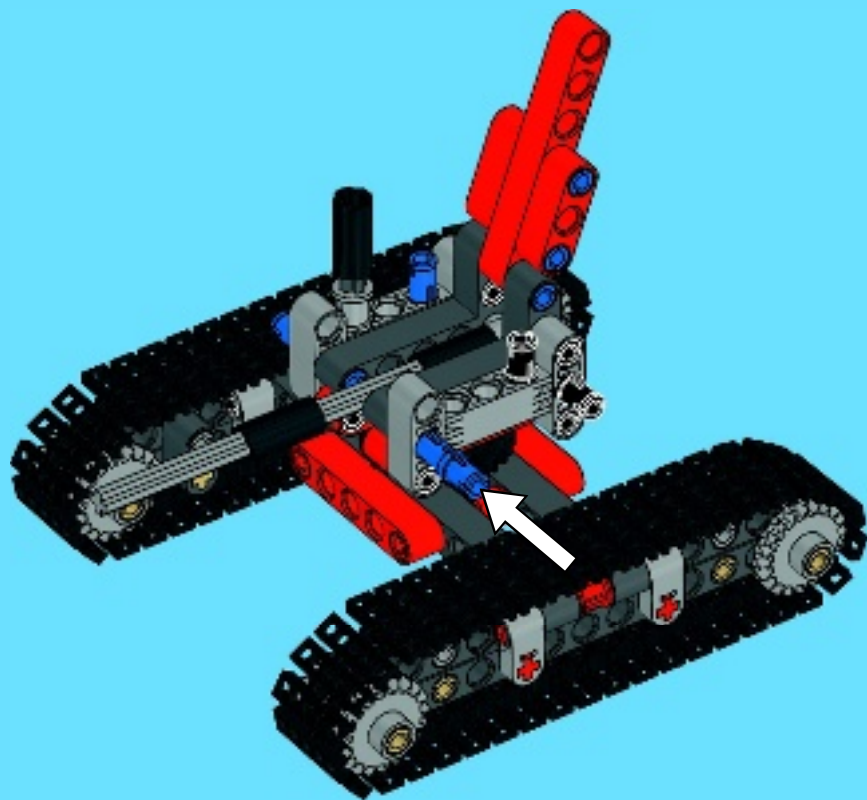

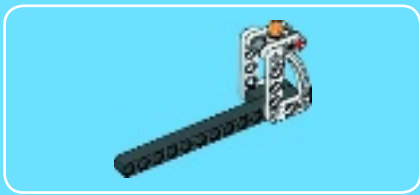

1

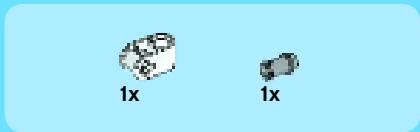

2

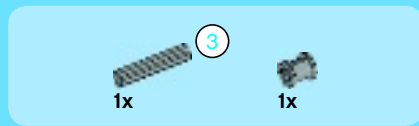

3

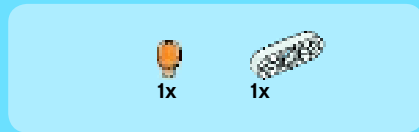
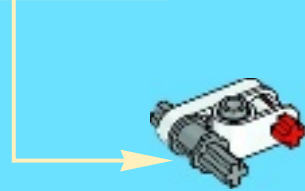
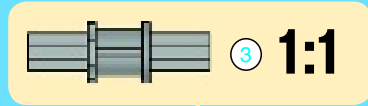

4

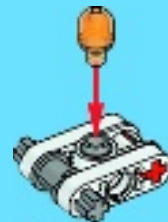



1x

5

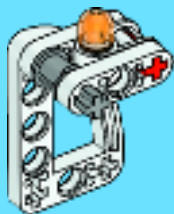

2x

3

6

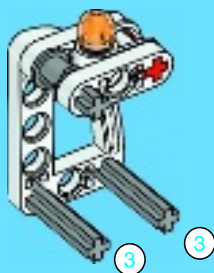

3

3



1x

7



1x

13



1x

8

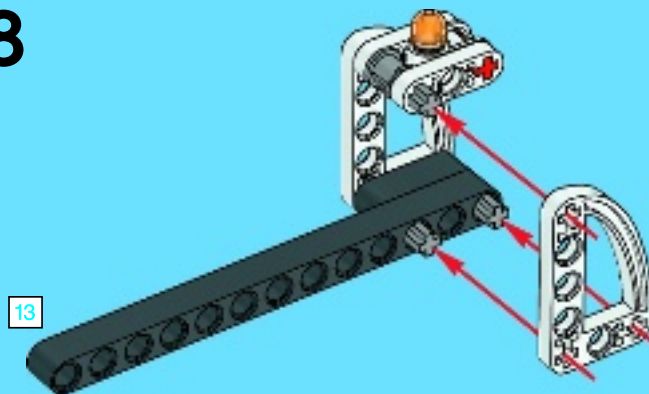

13

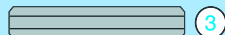

3



13

1:1

17

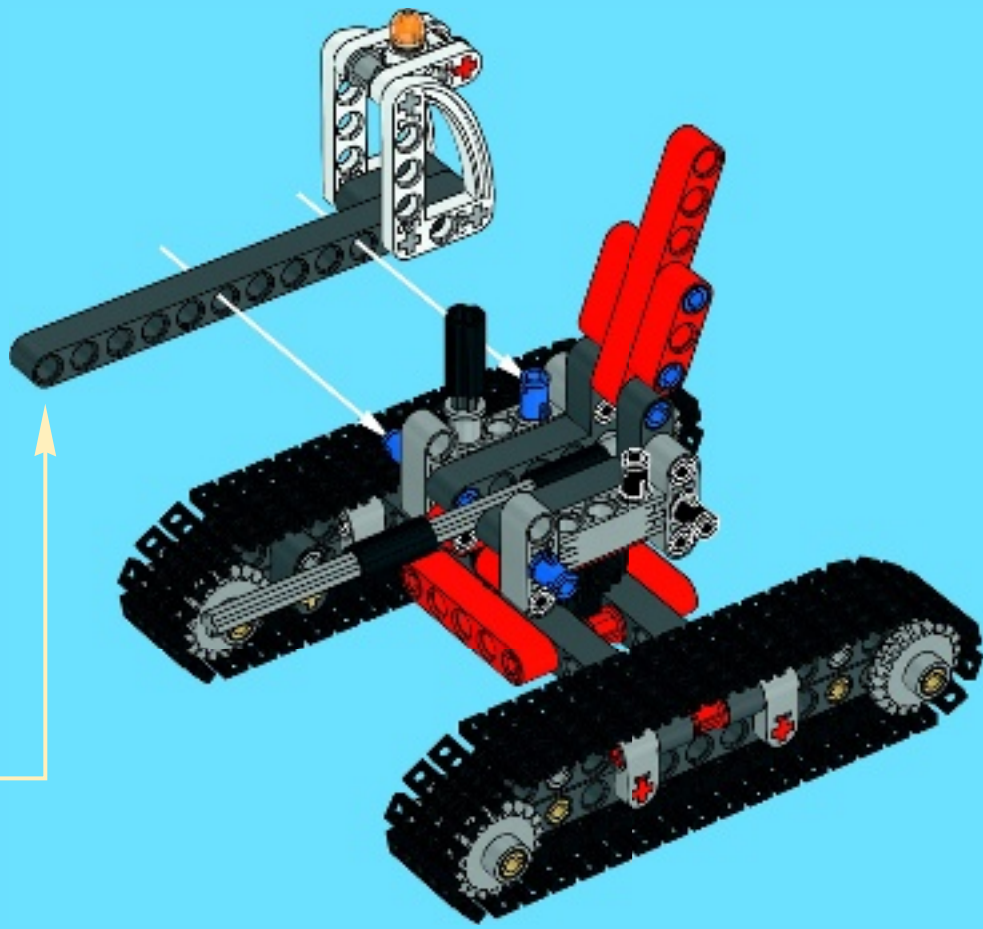



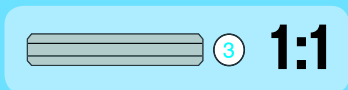
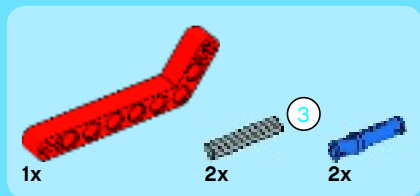

# 18

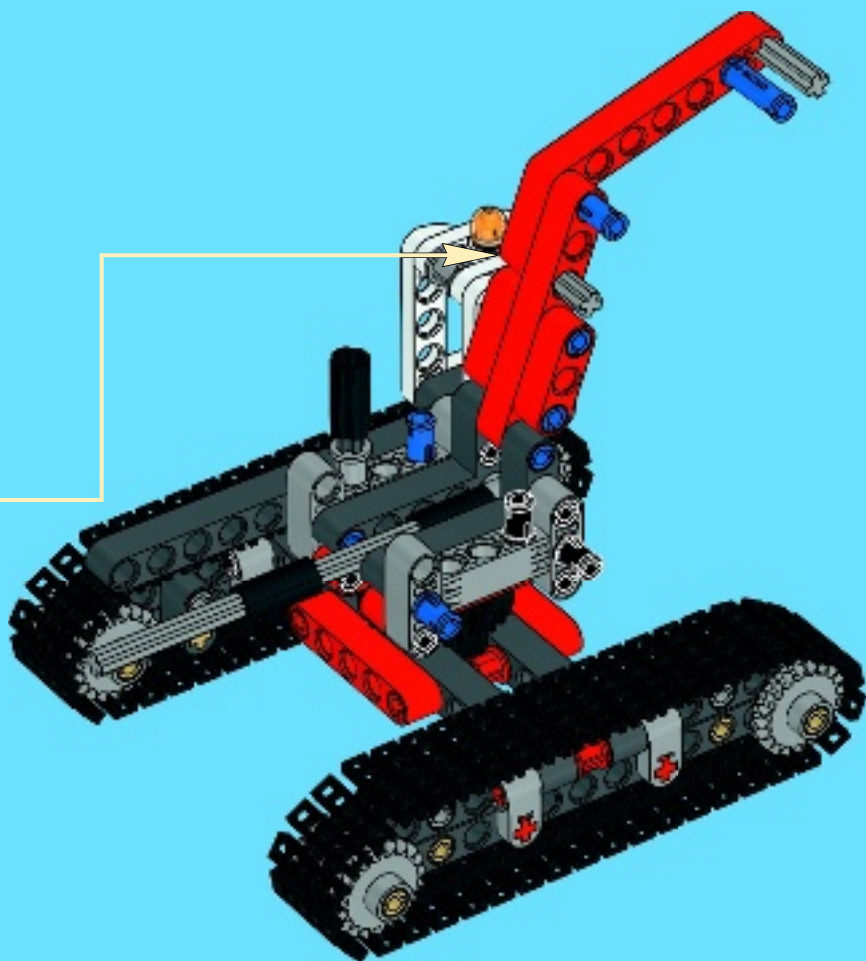
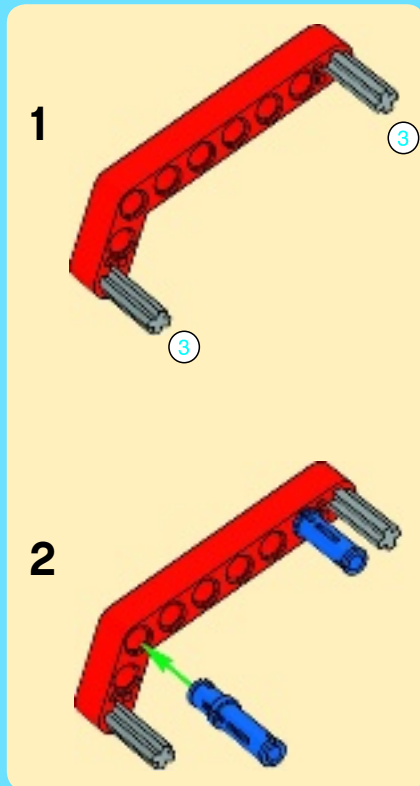

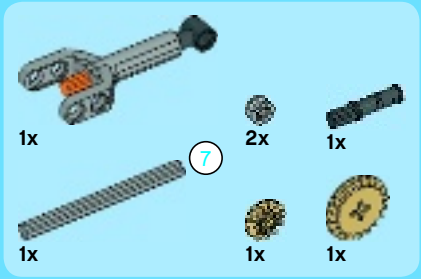
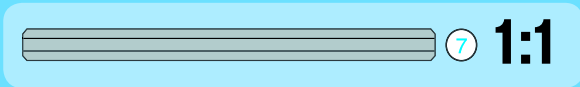

# 19

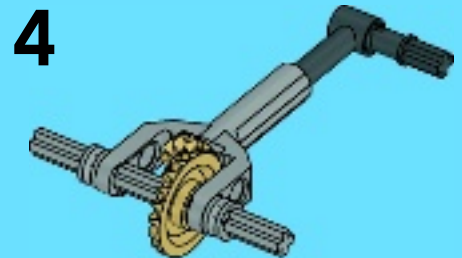
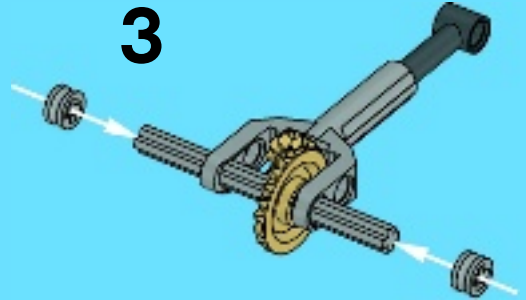
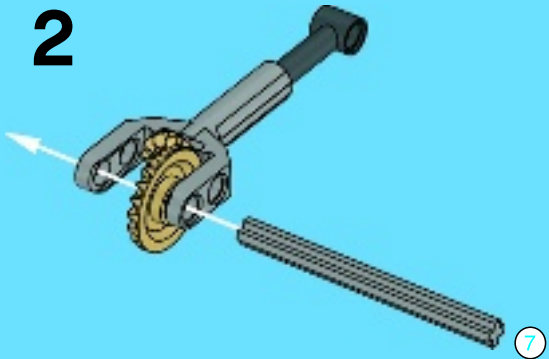

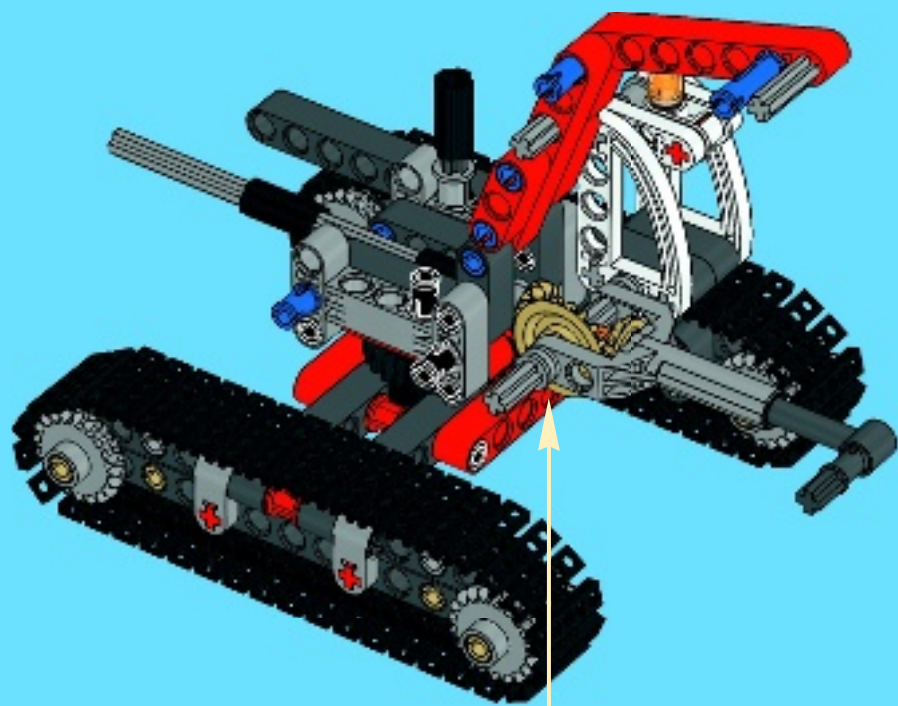

20

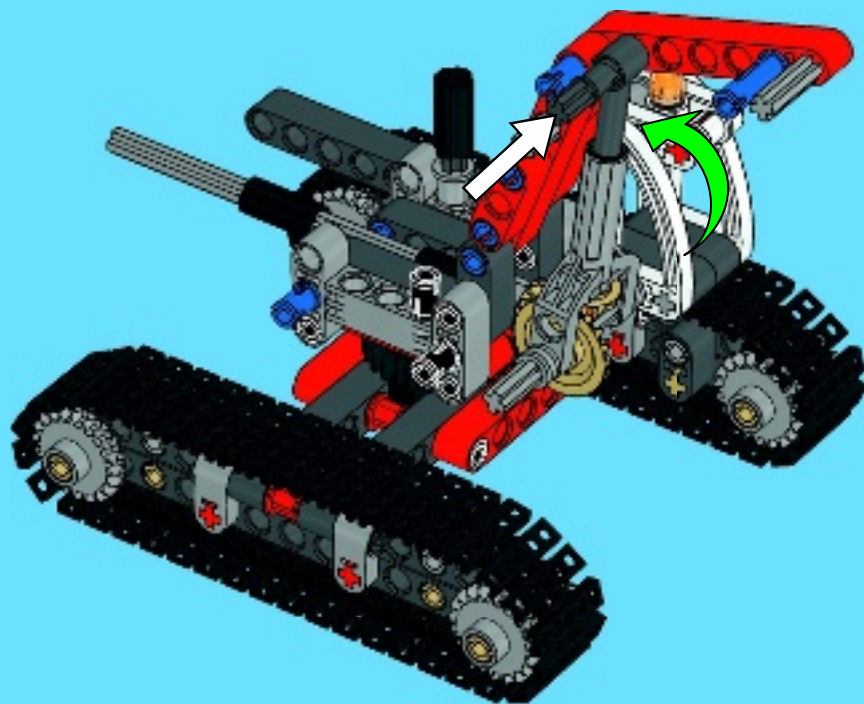

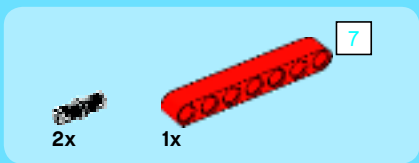

# 21

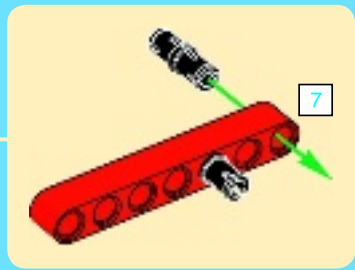
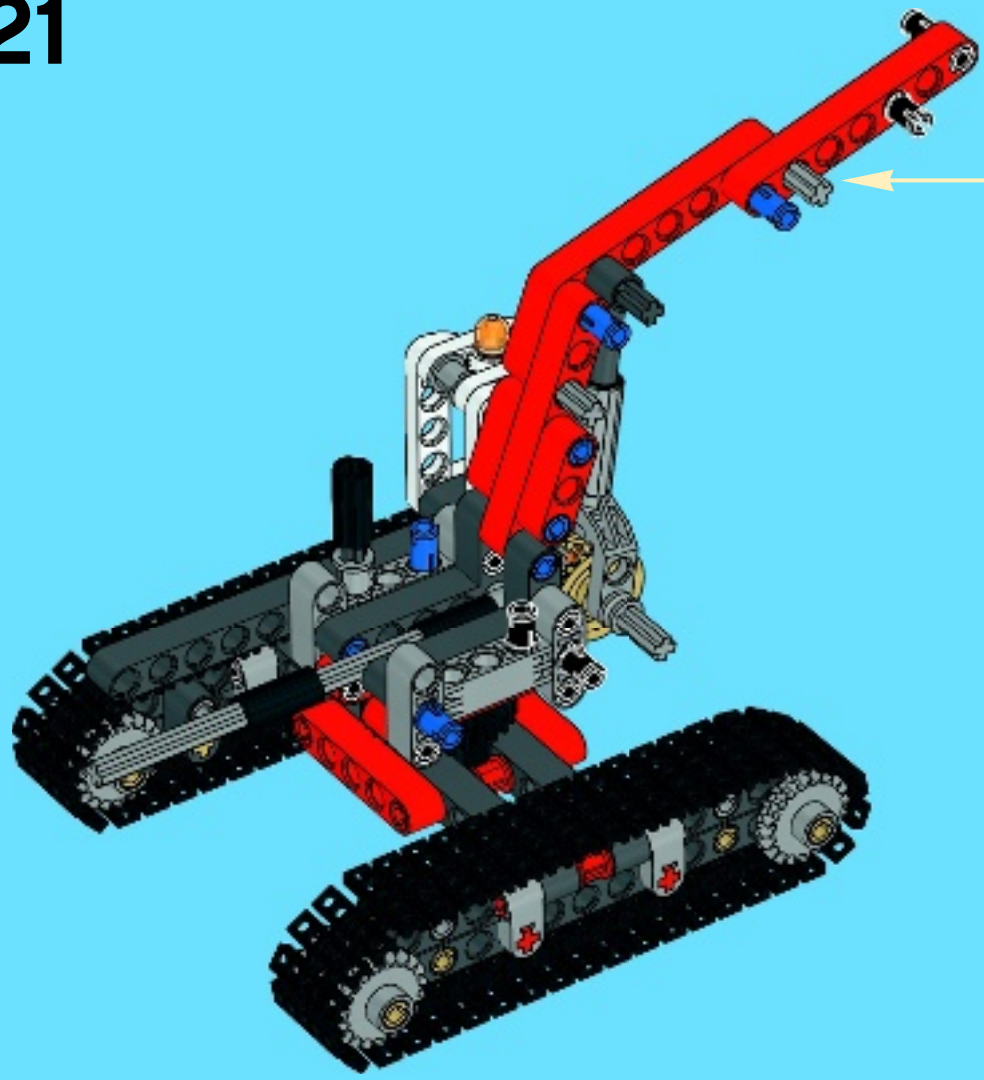

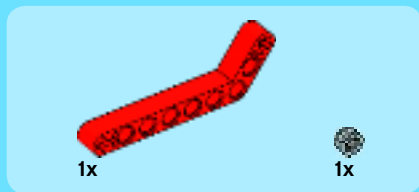

22

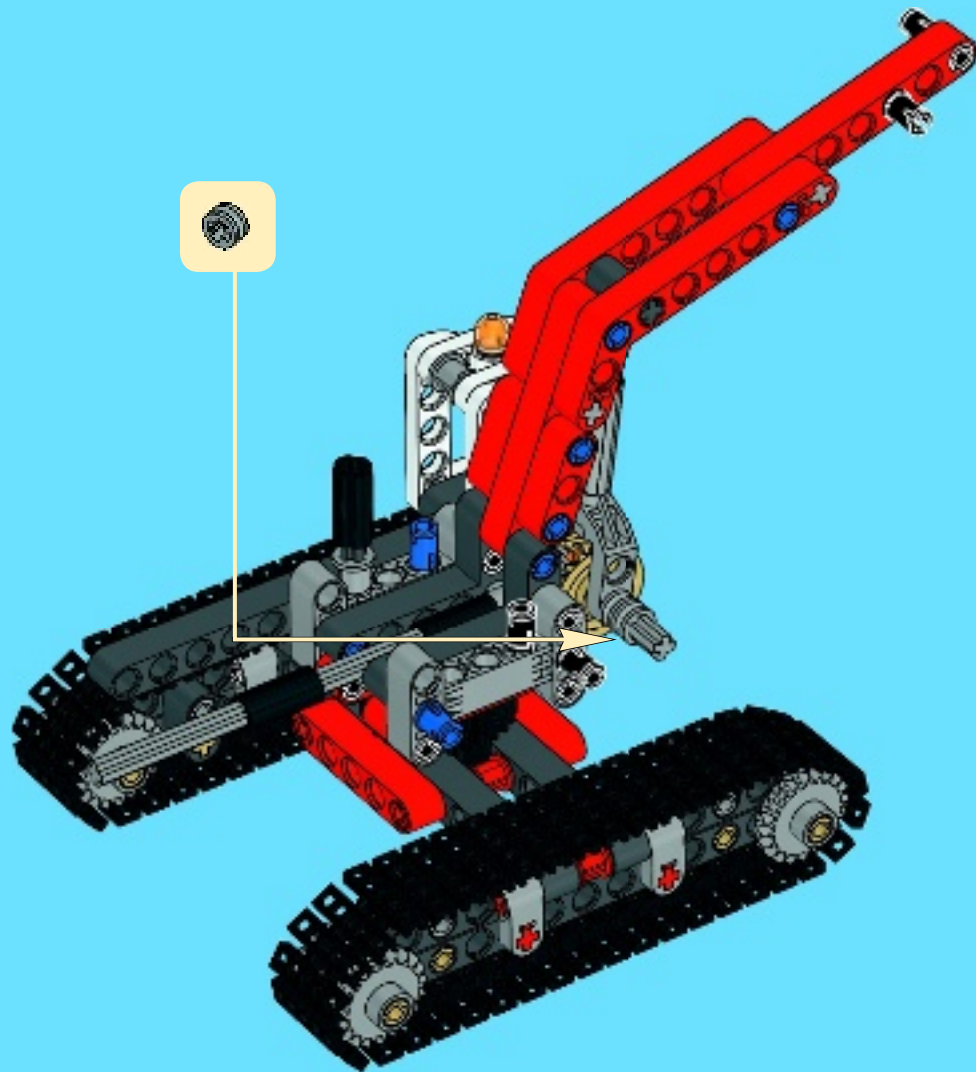



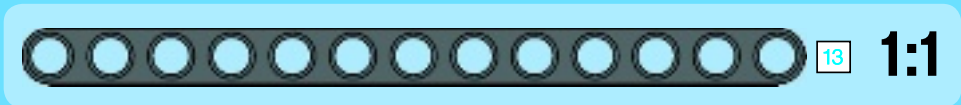

23

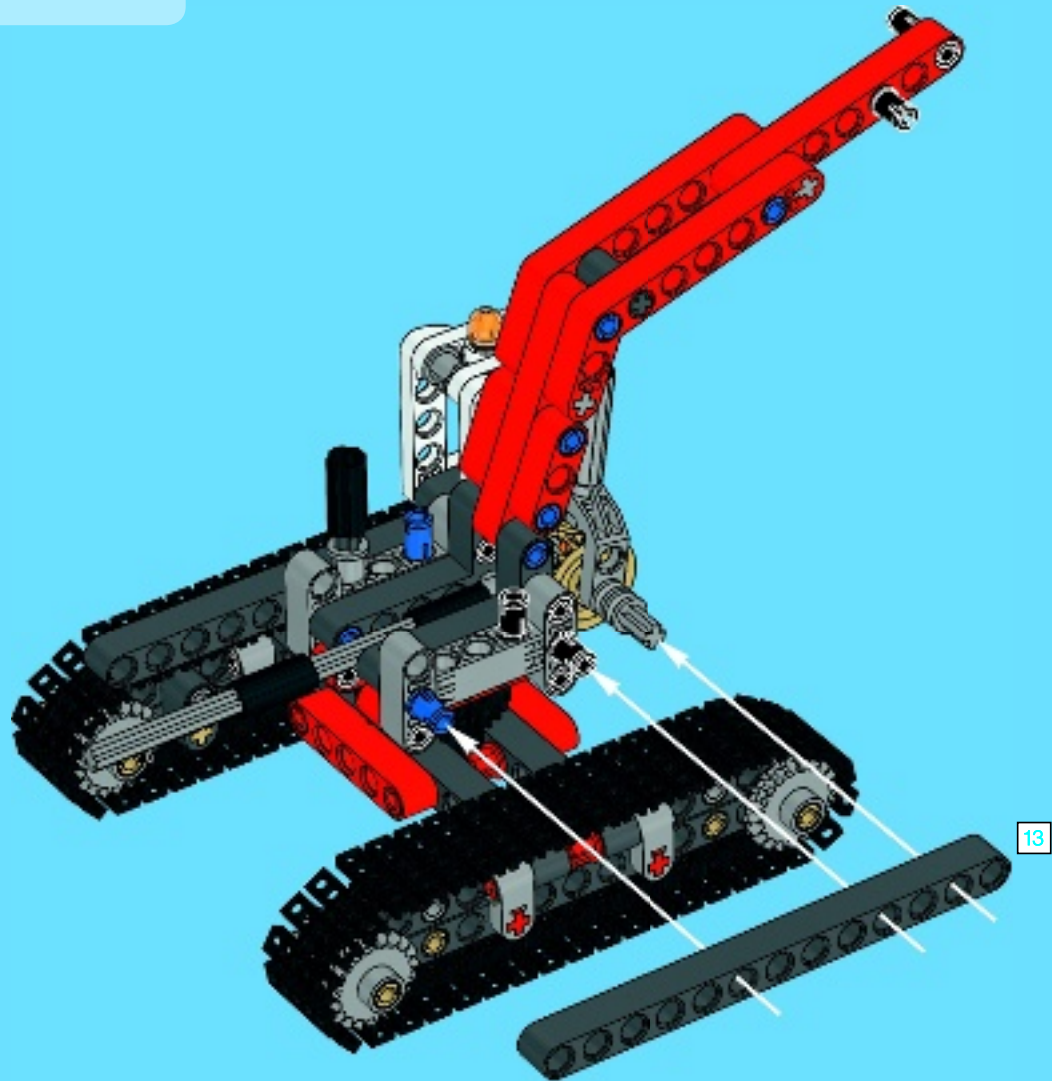



2x

1x

5



5

1:1

# 24

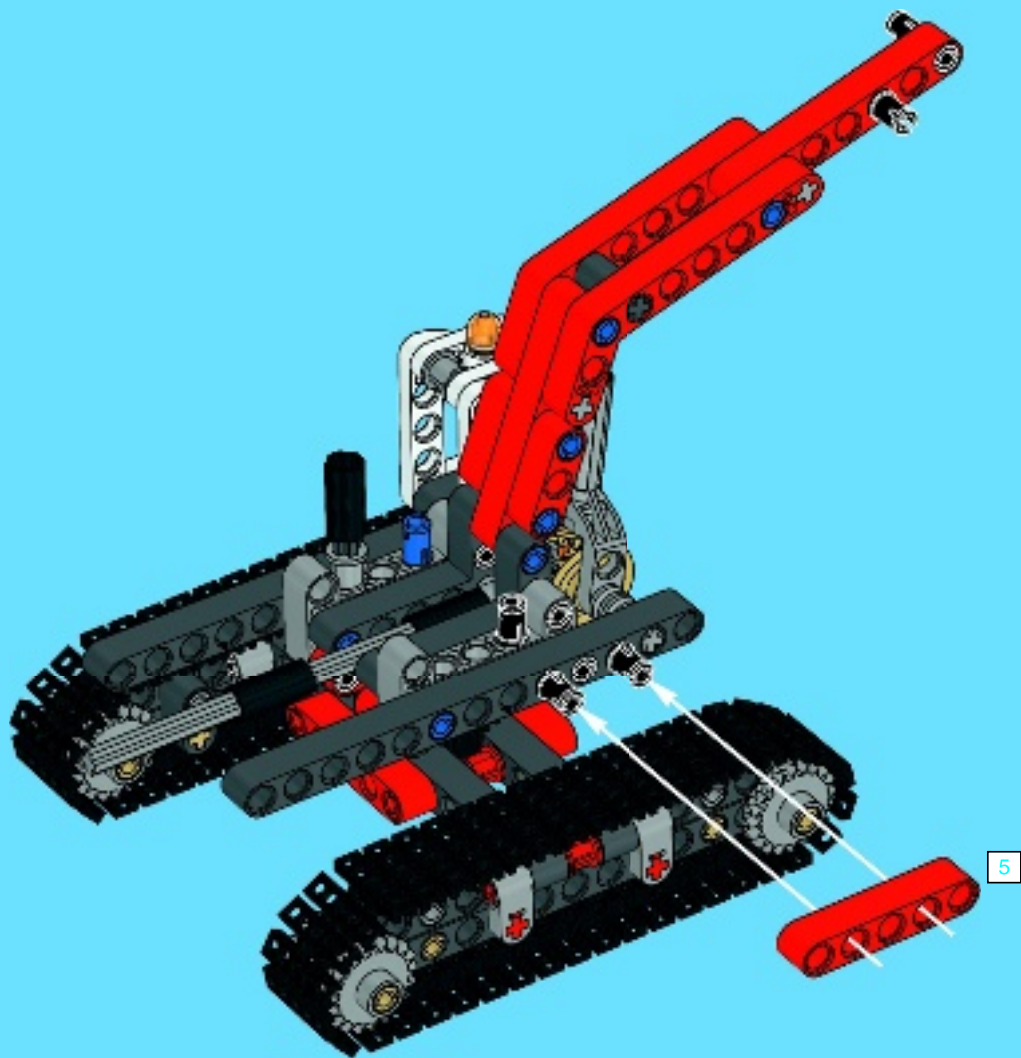

5

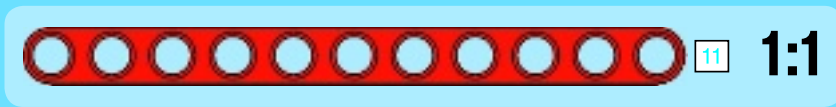
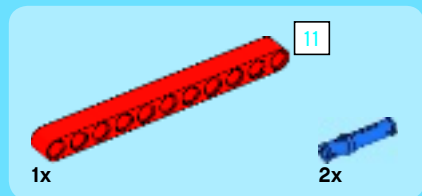

25

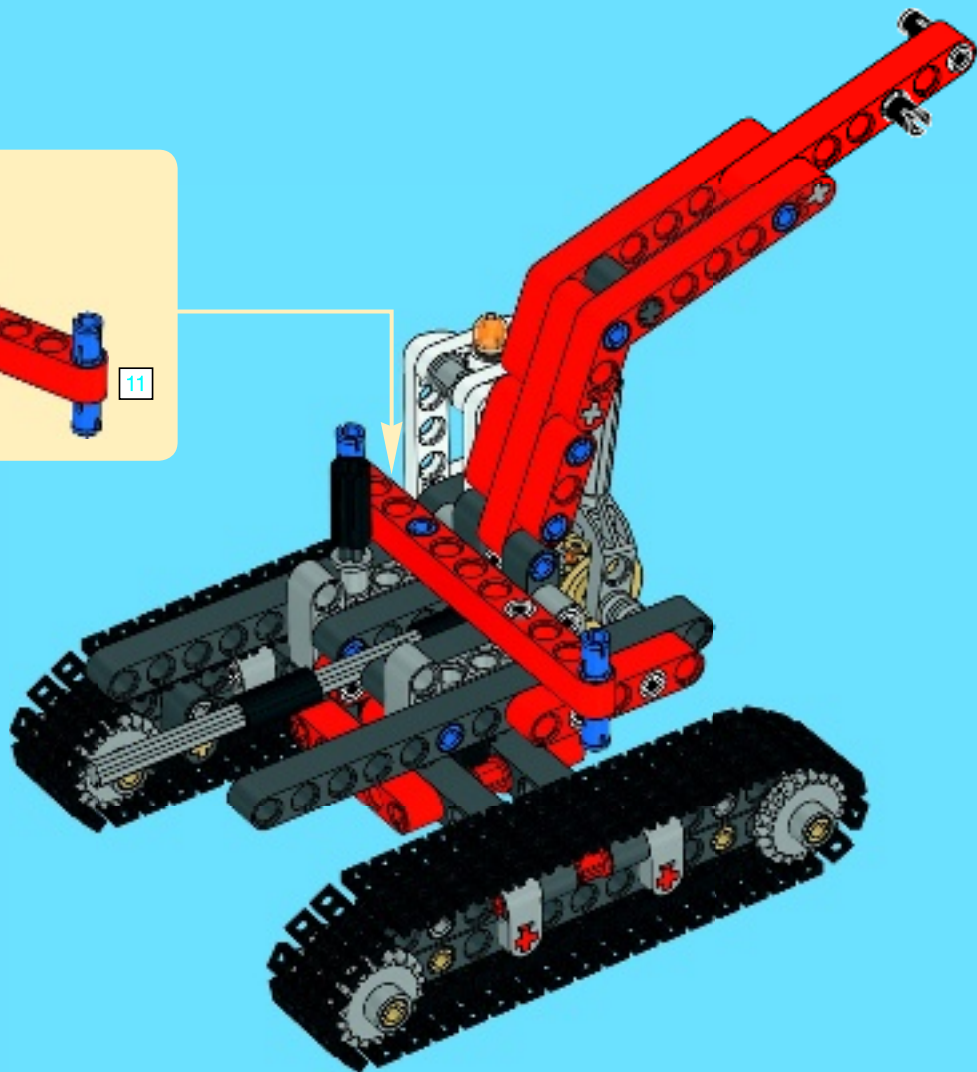
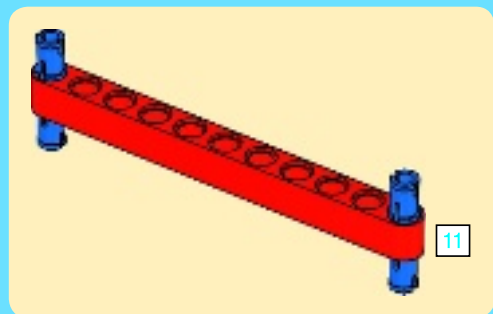

4x

2x

# 26

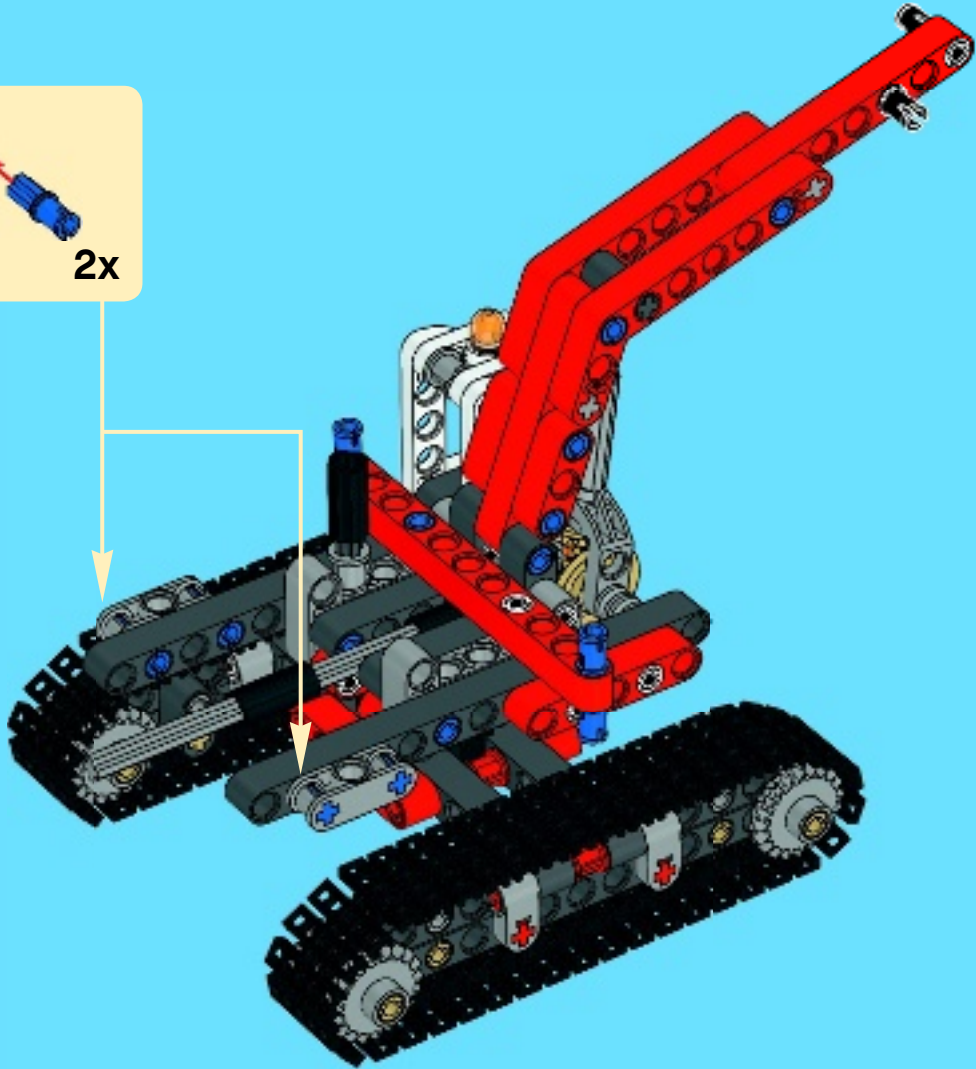
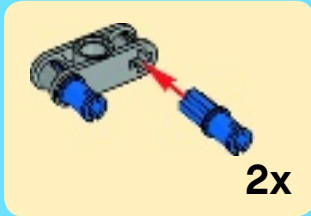

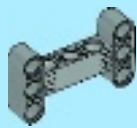

1x

1

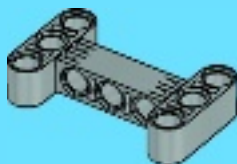

4x

2

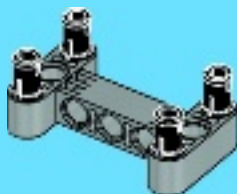

1x



2x



2x

3

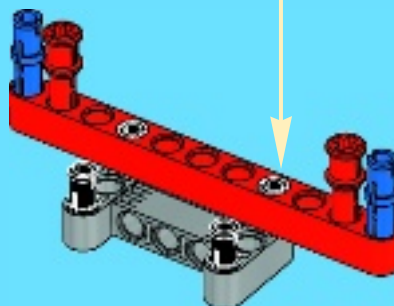
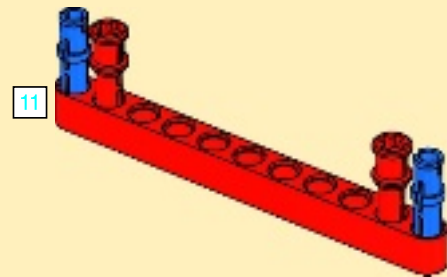

11

1:1

27

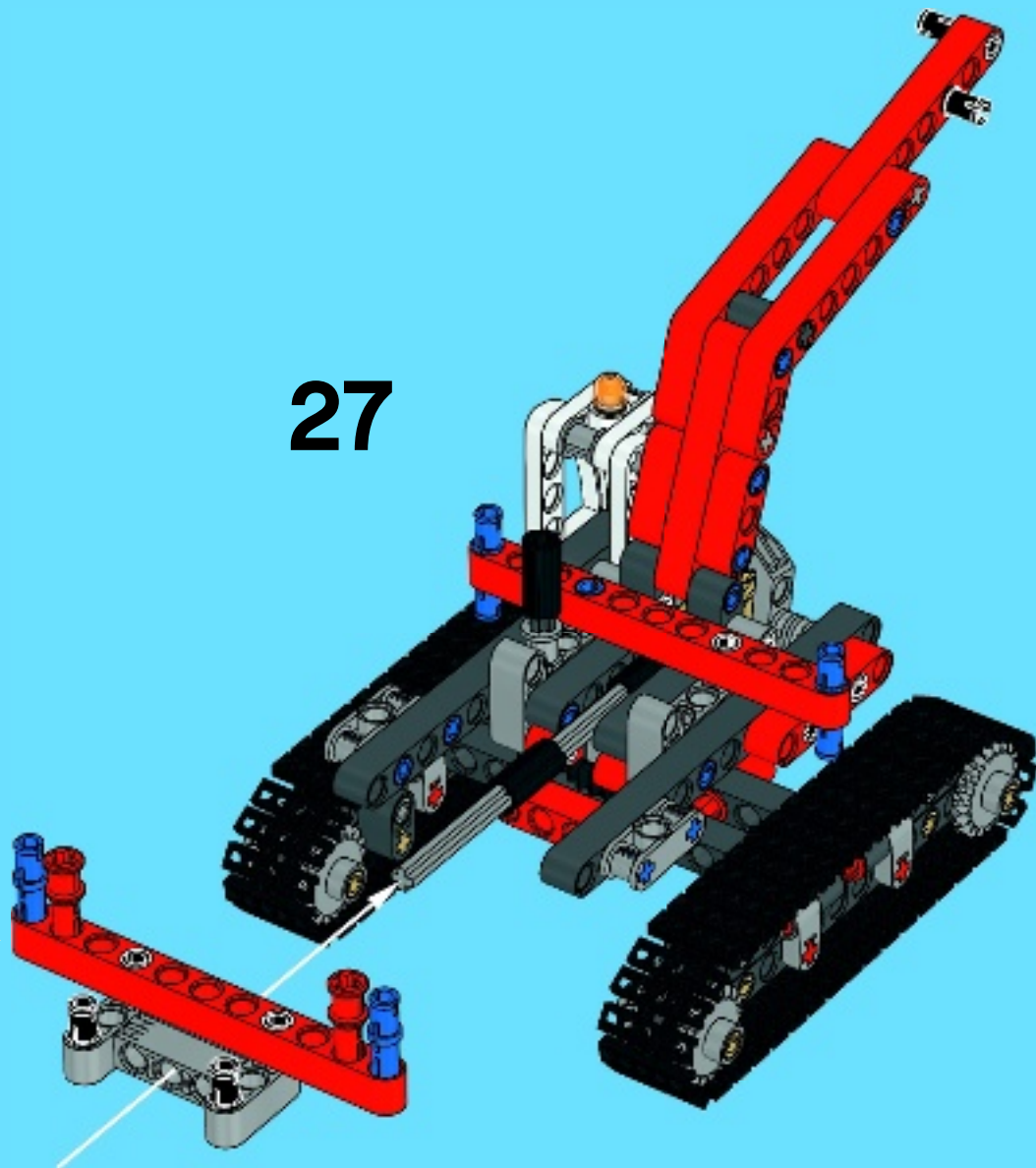



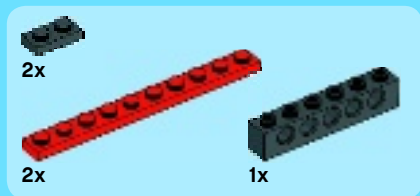

# 28

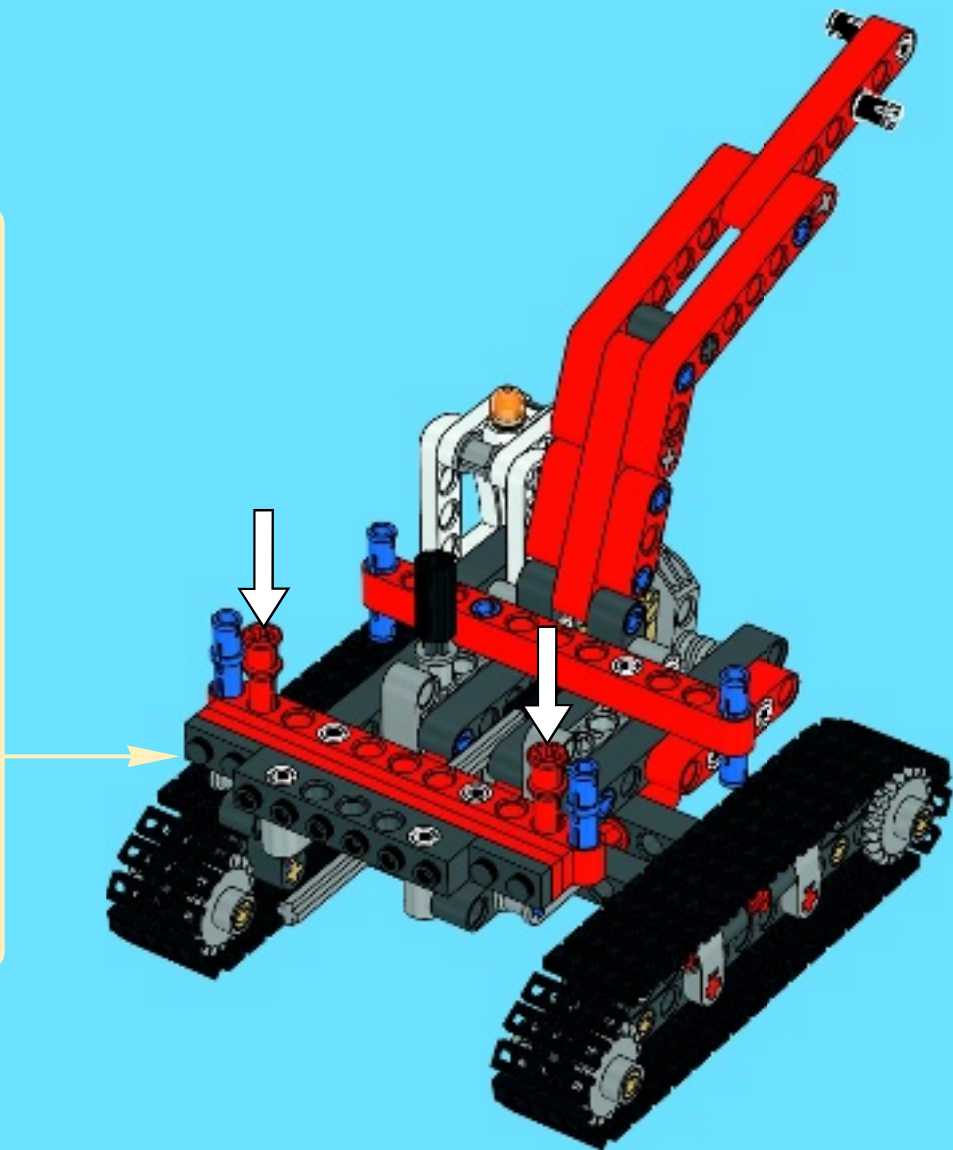
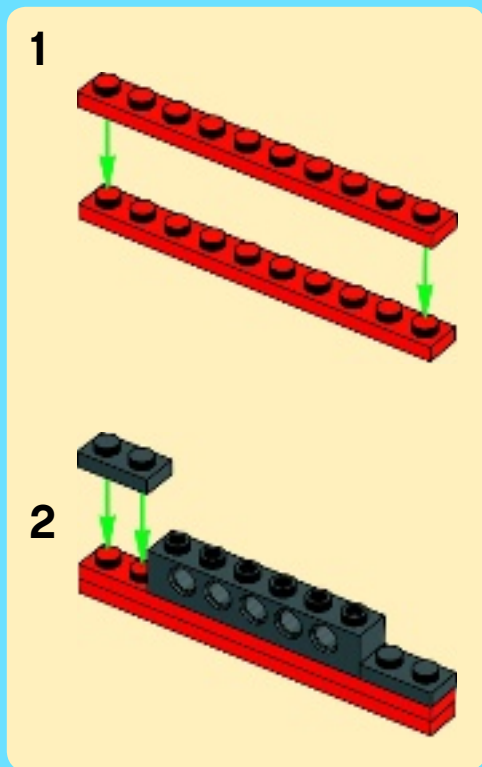

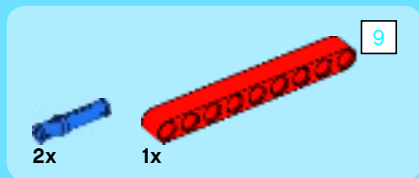

# 29

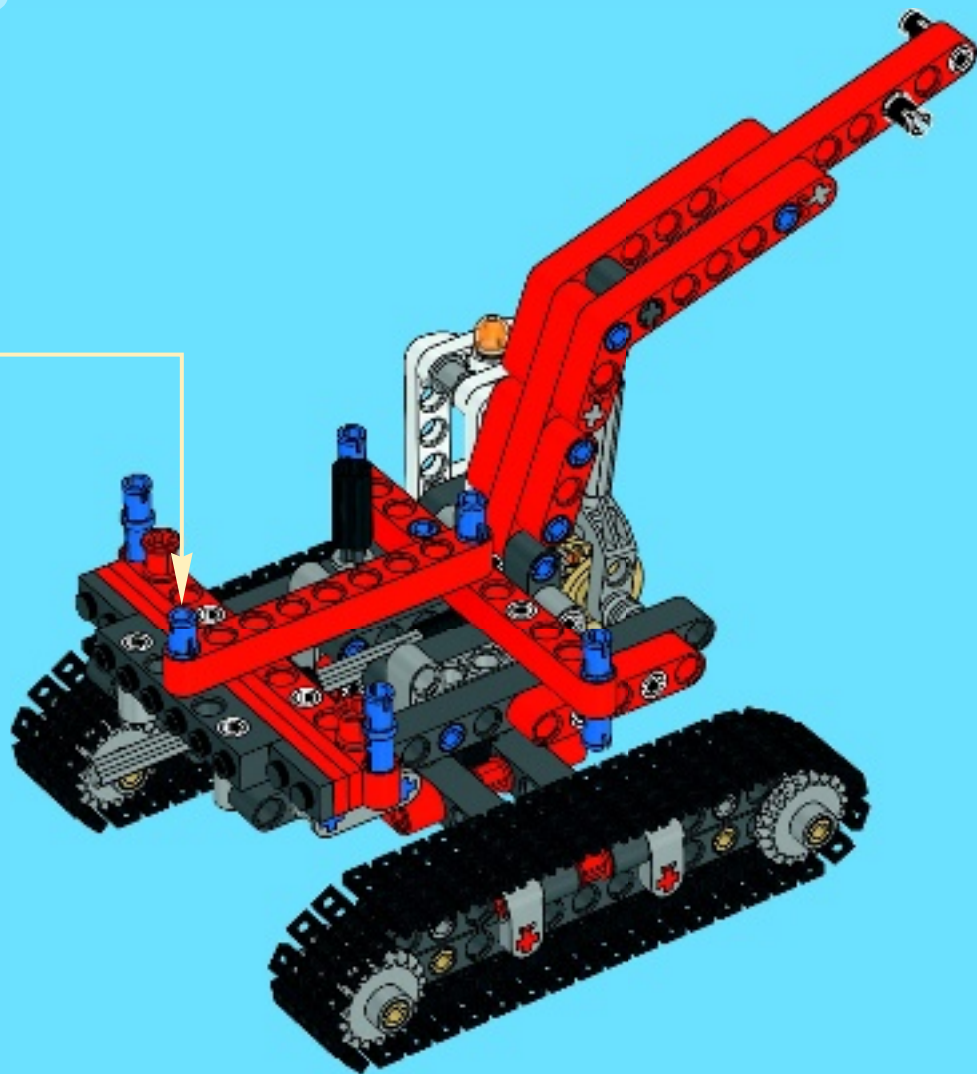
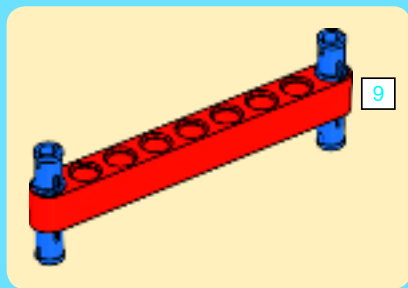



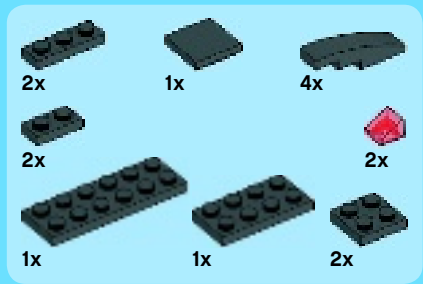

# 30

1

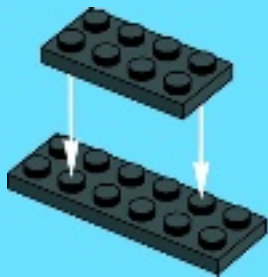

2

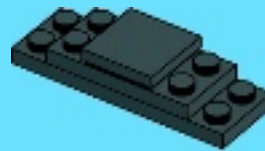

3

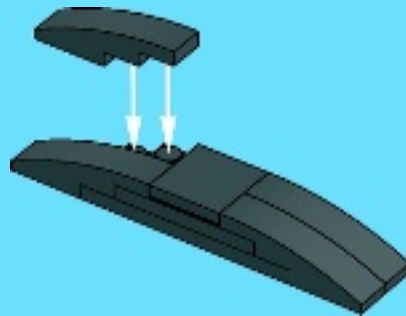



4

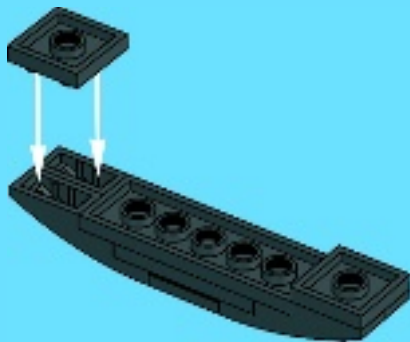

5

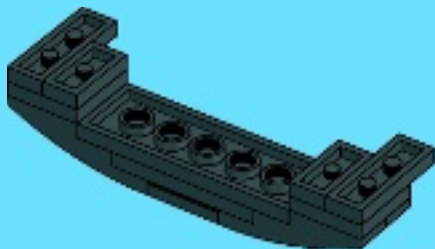

6

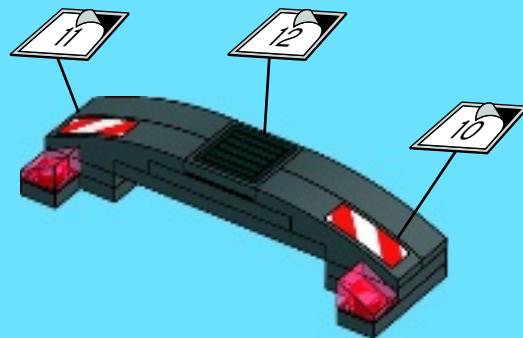

7

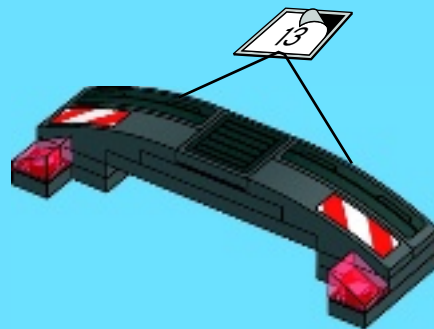

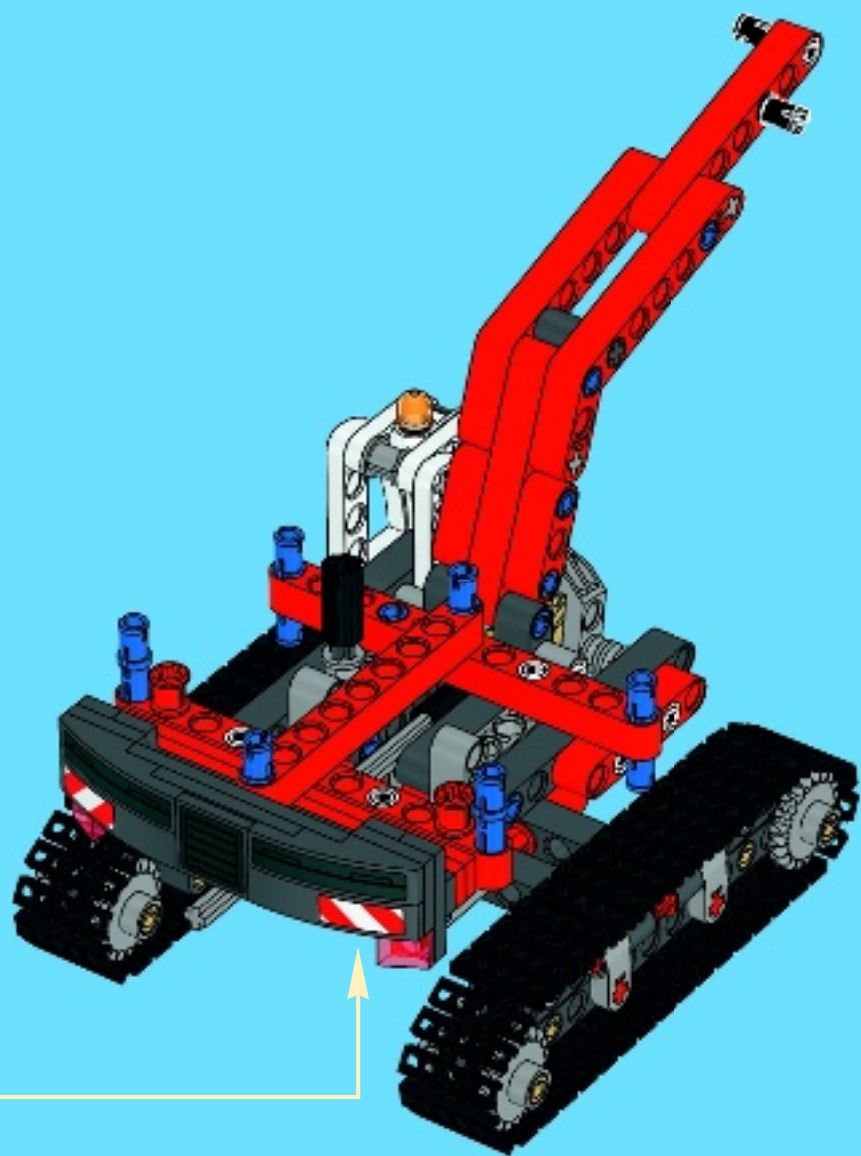

31

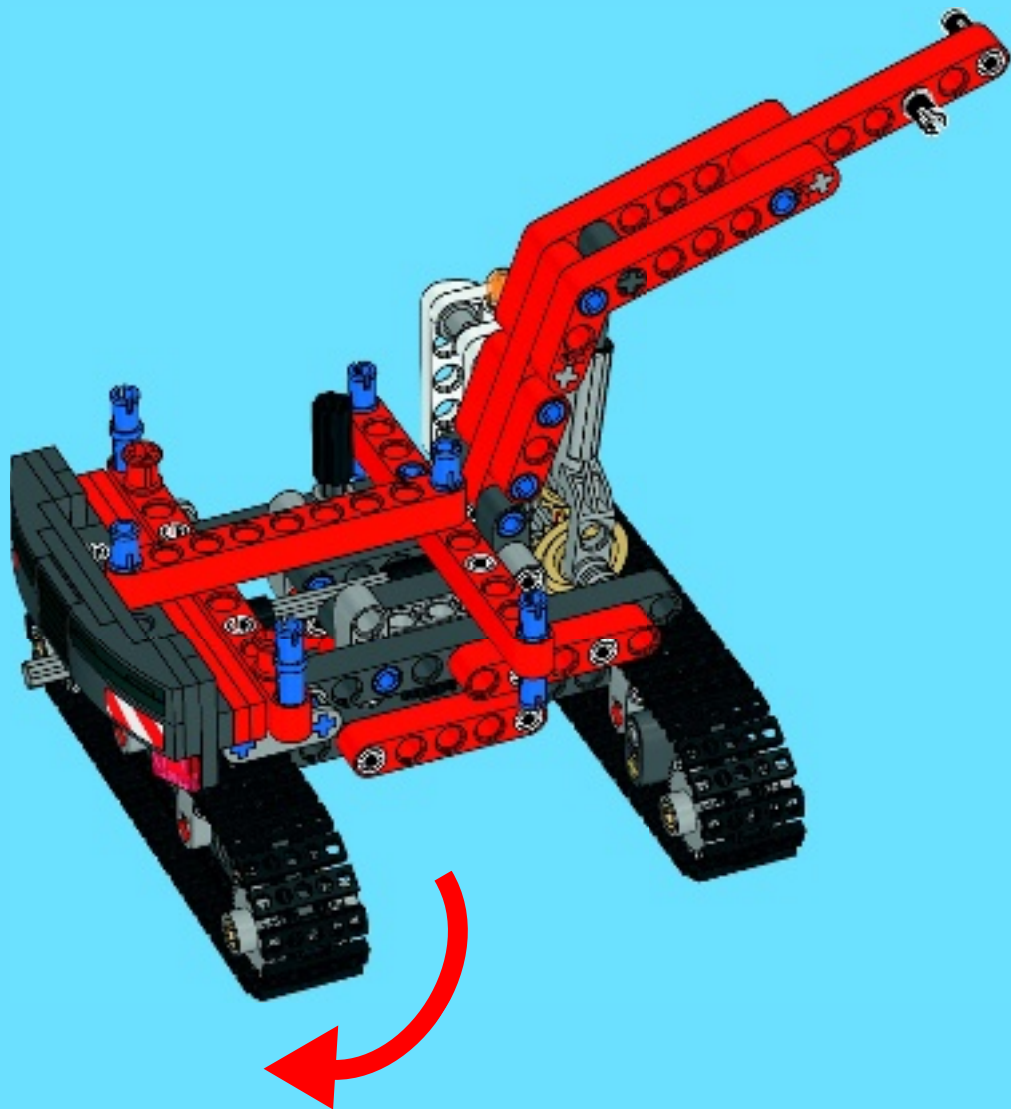

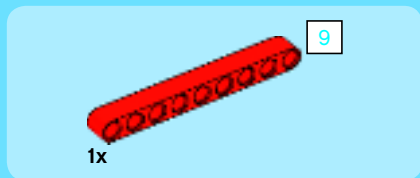

32

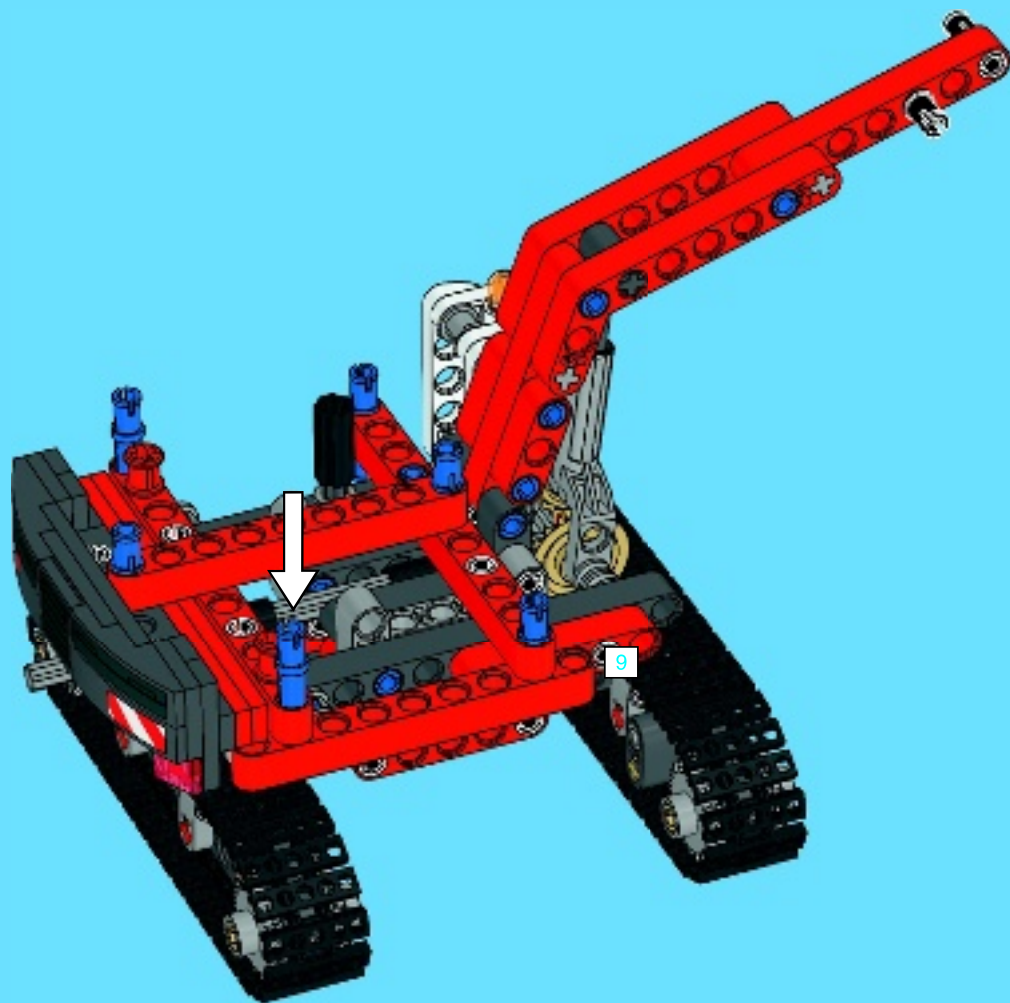

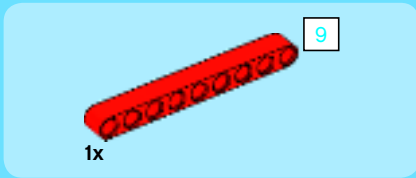

33

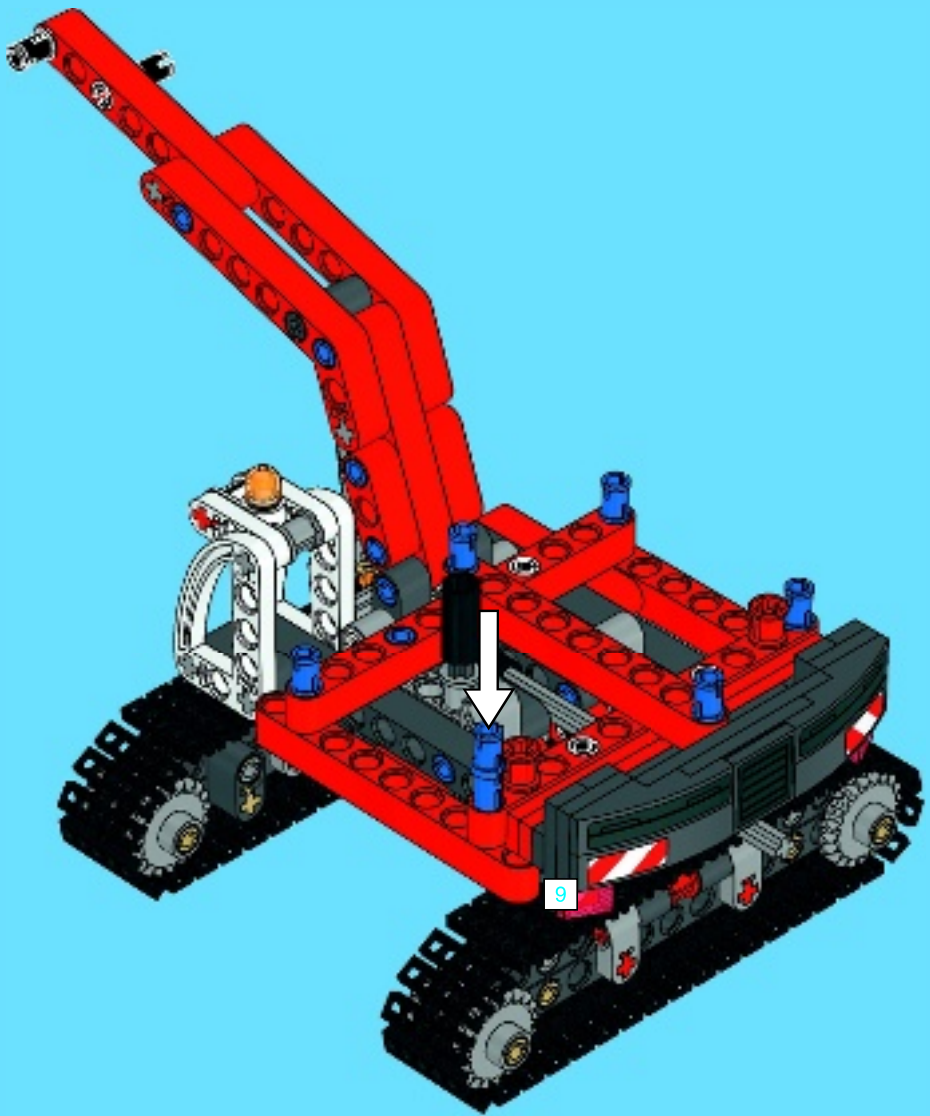





# 34

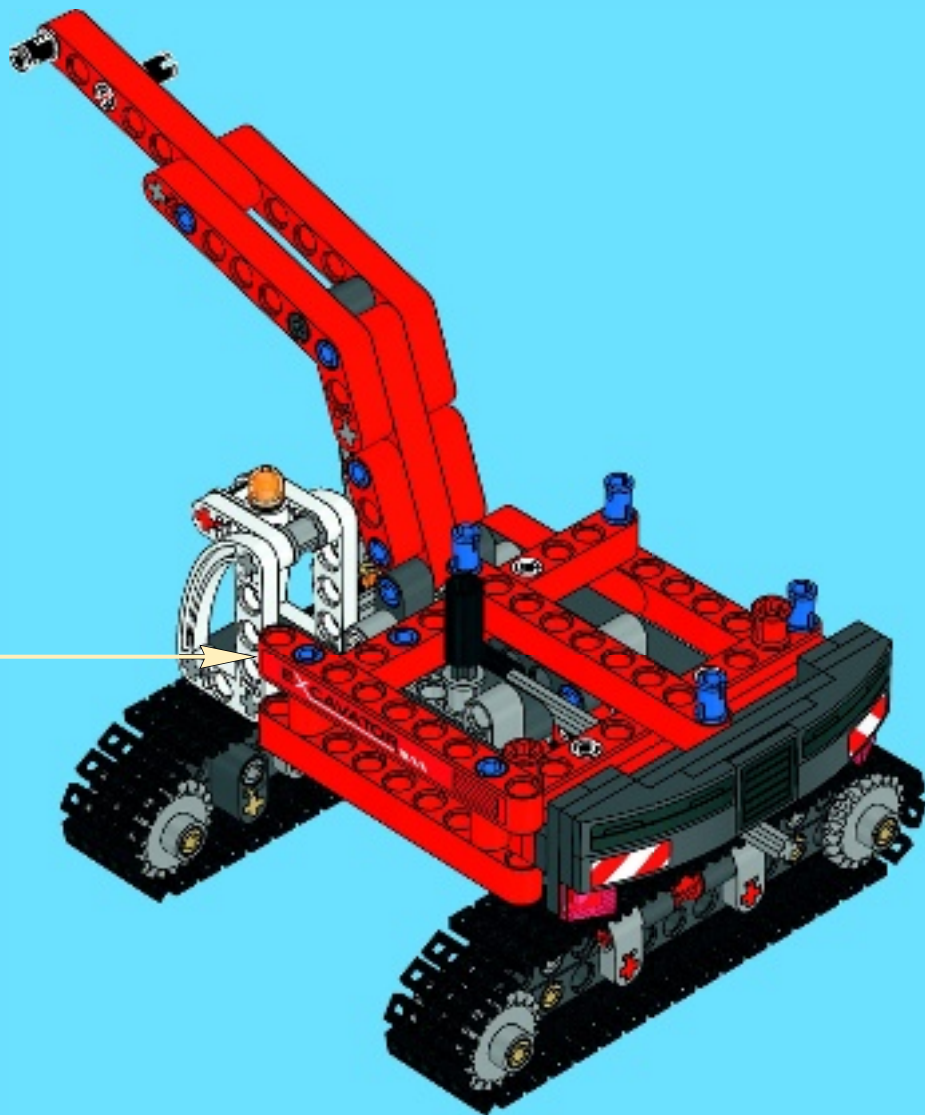
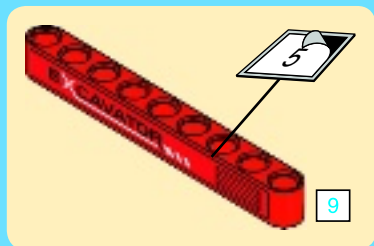





# 35

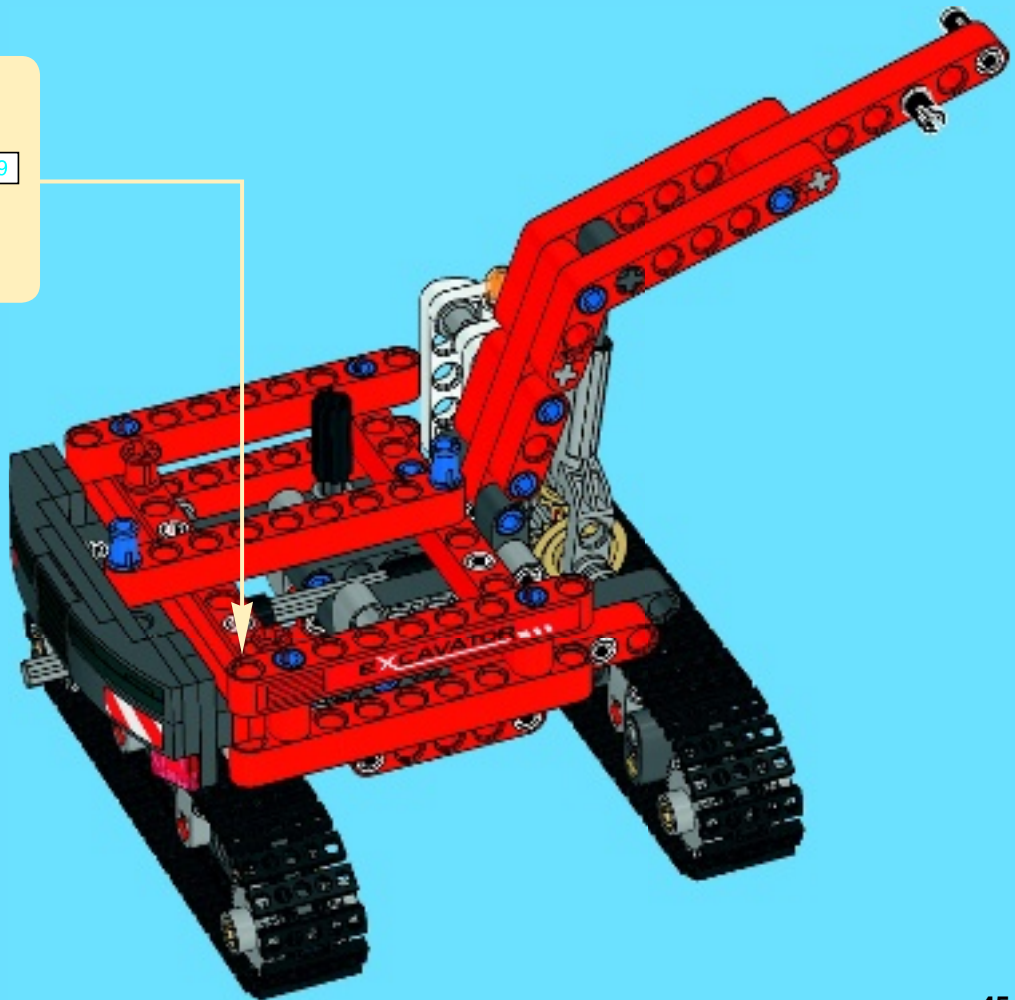
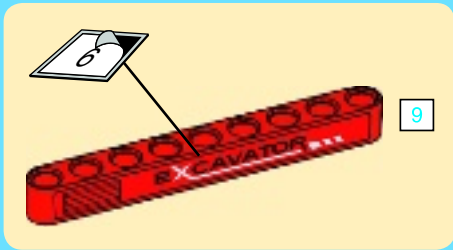



1x



2x

# 36

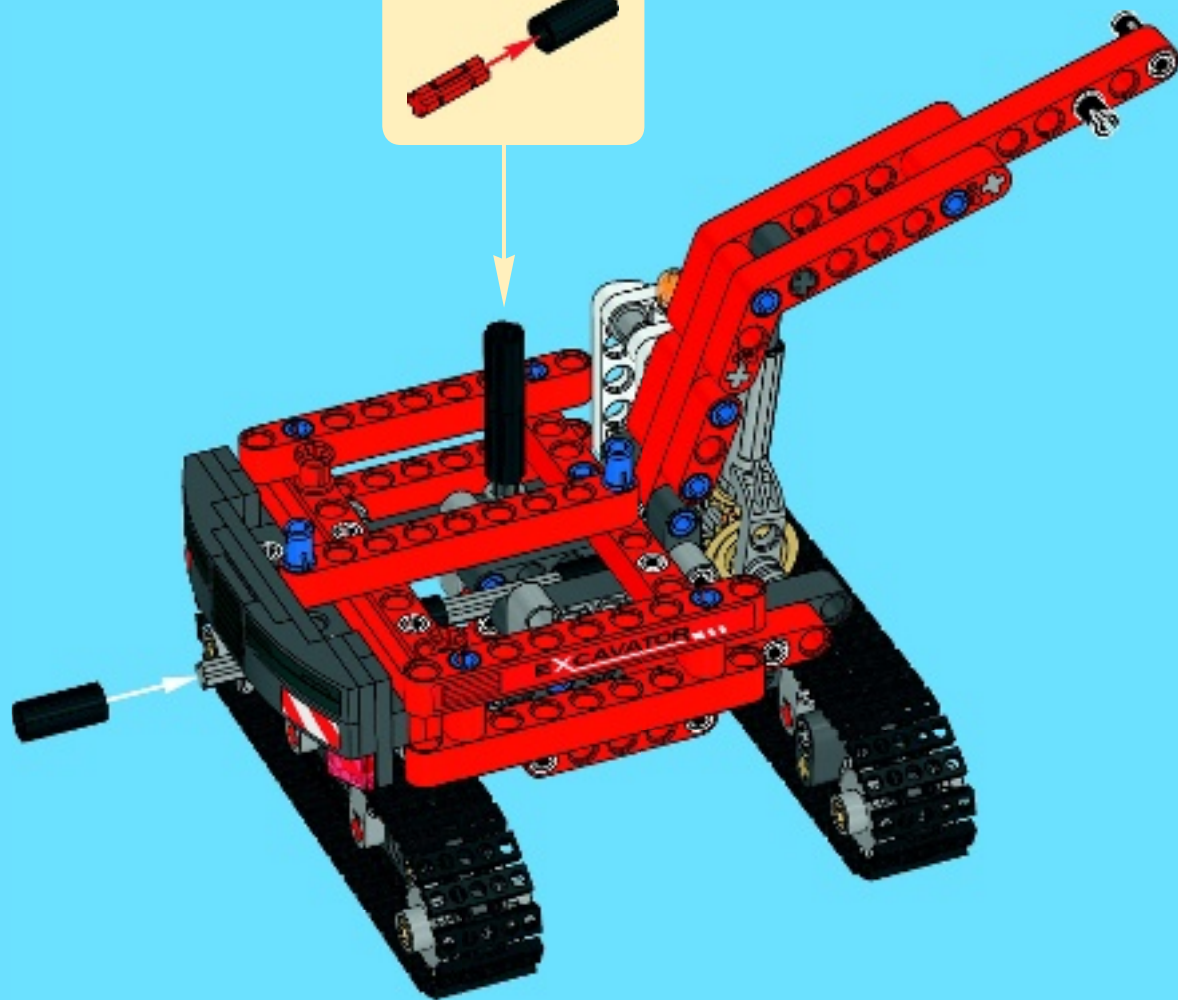
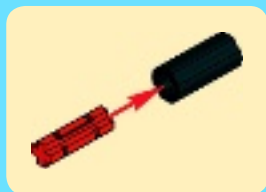



1

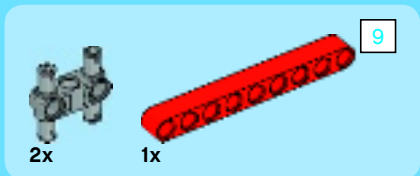
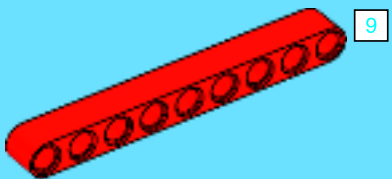

2

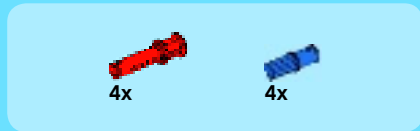
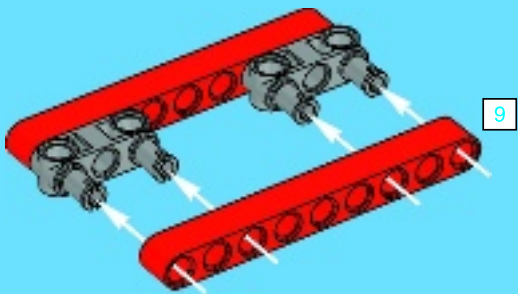

3

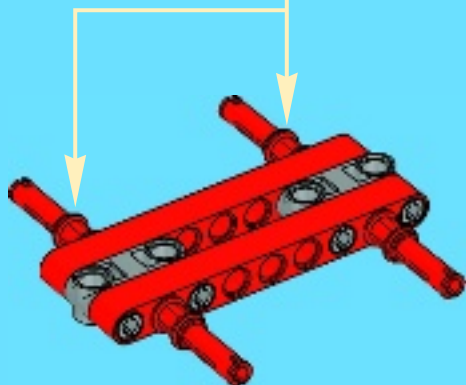
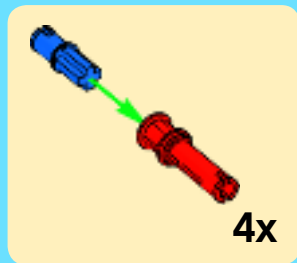

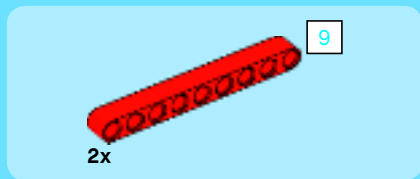

4

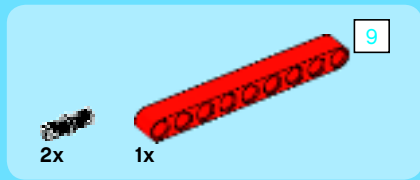
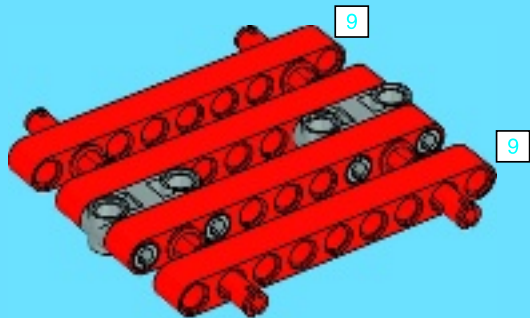

5

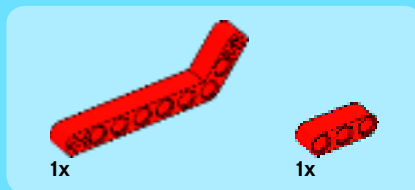
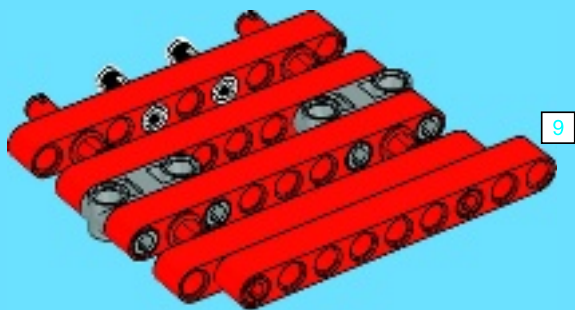

6

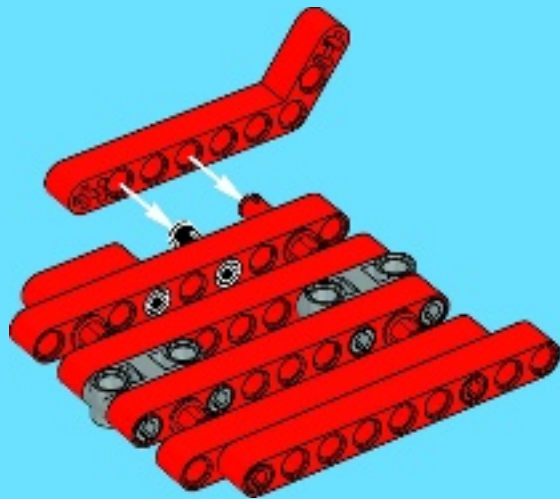

7

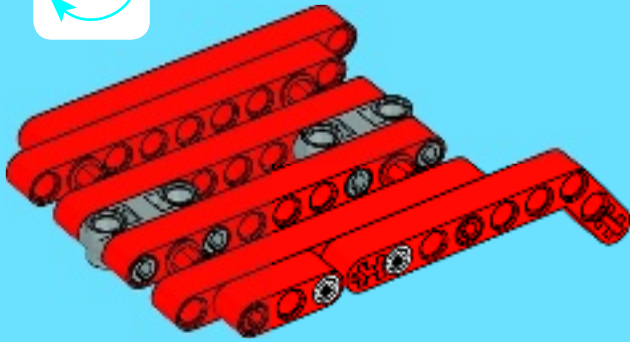

37

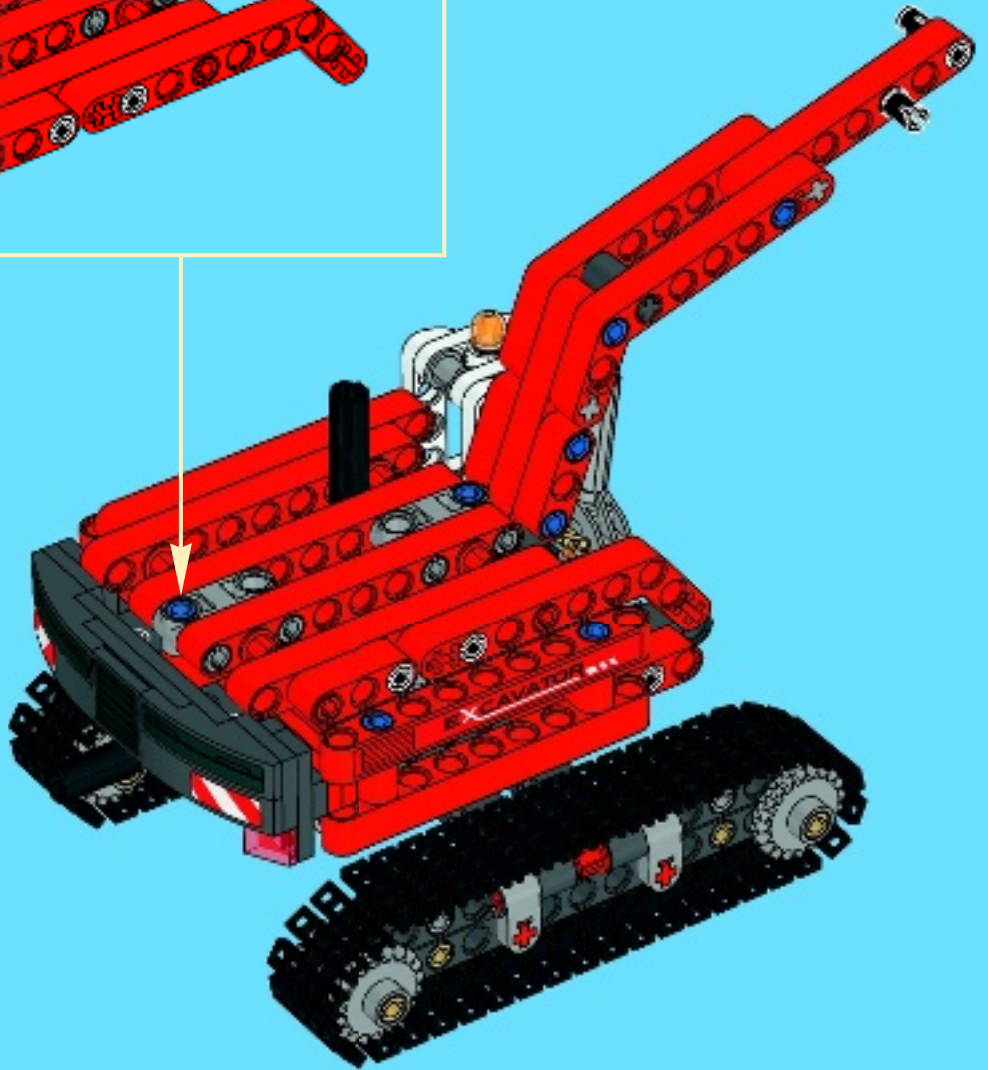



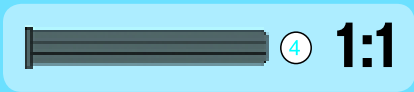
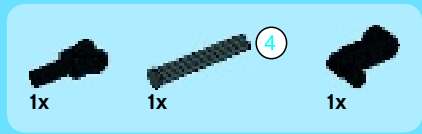

38

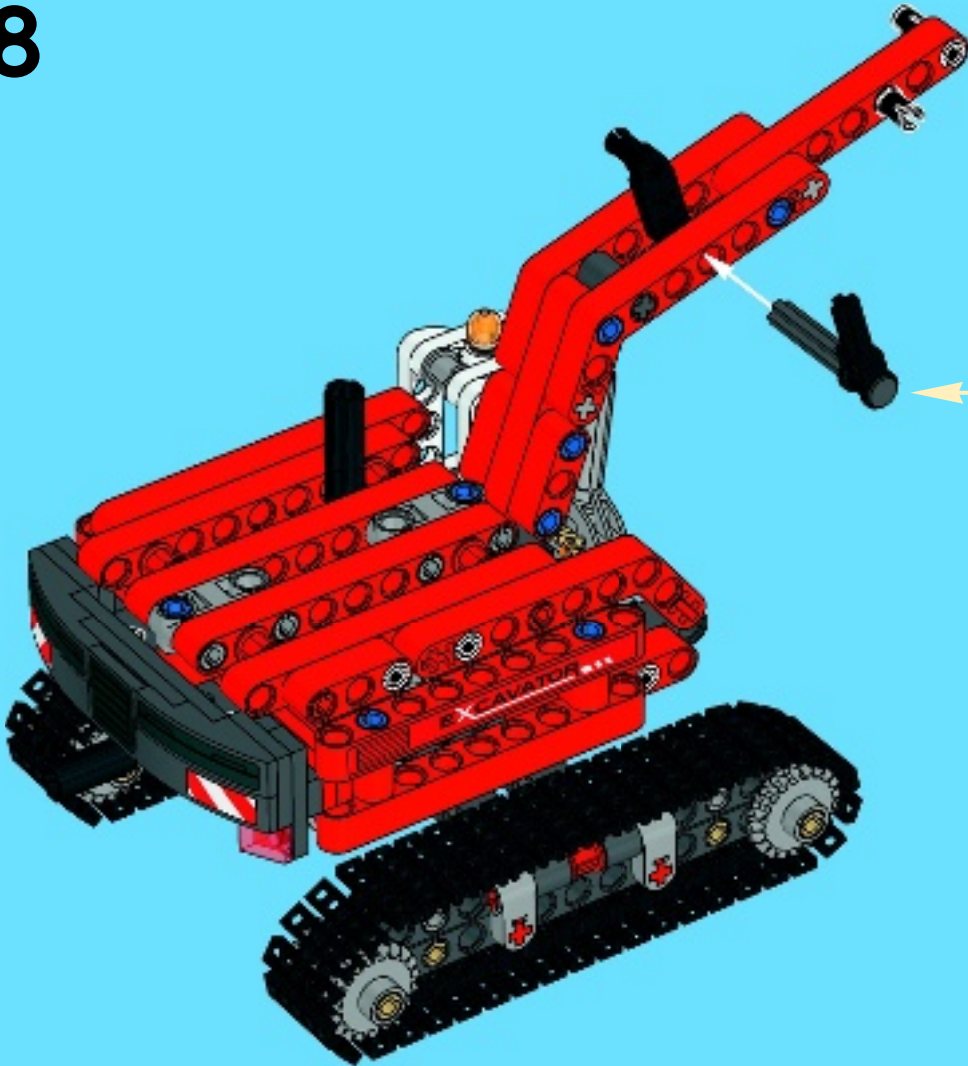
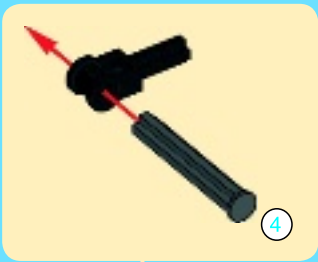

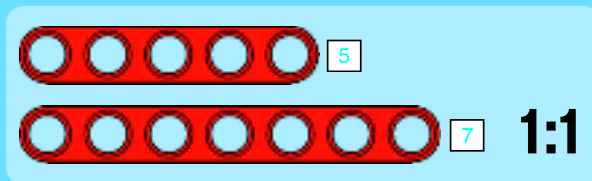
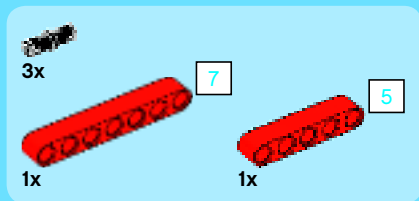

# 39

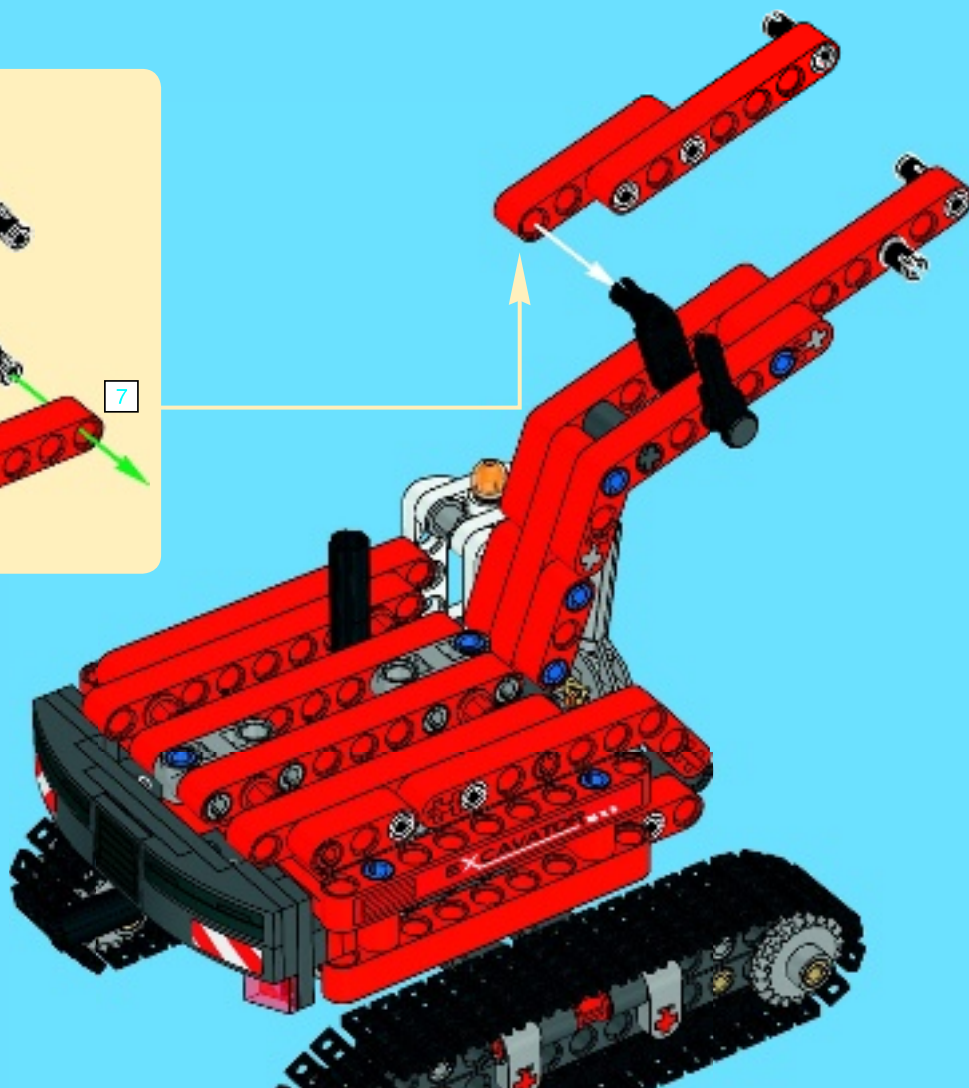
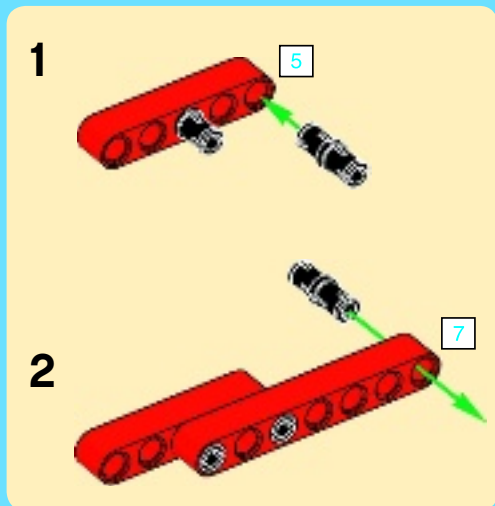





3

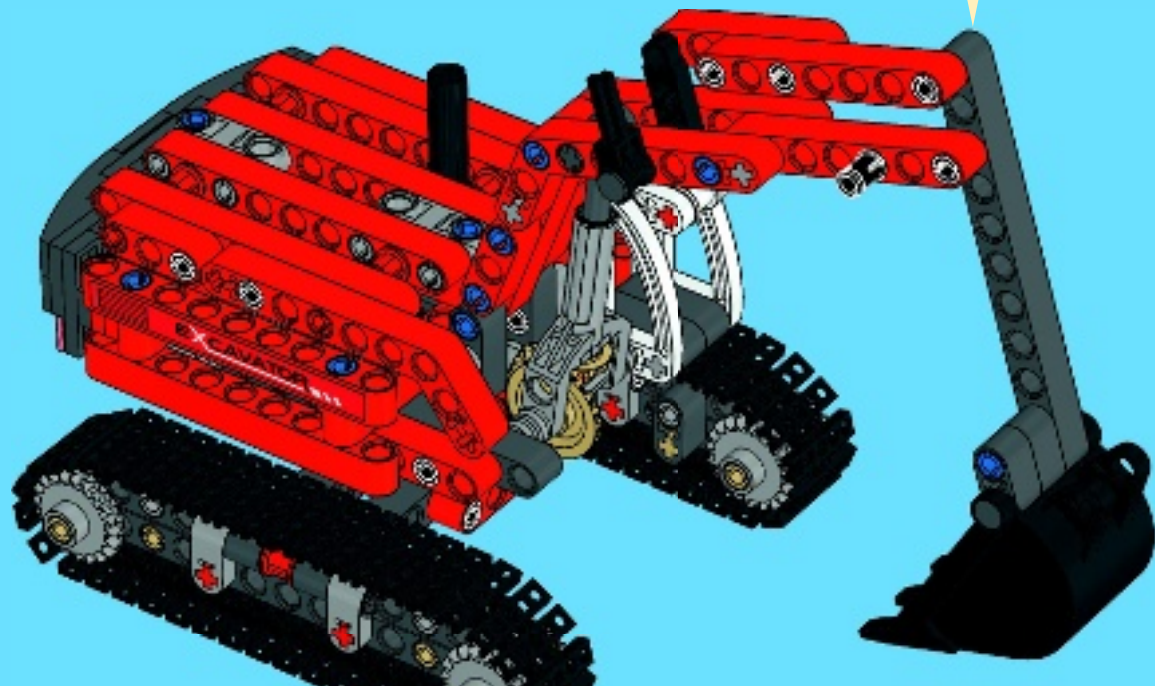

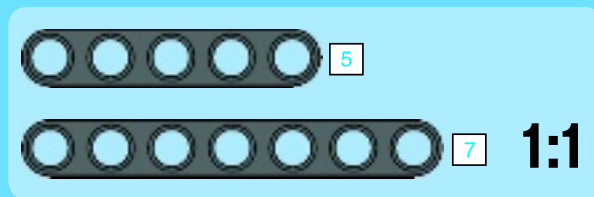
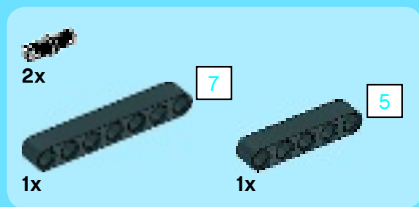

# 41

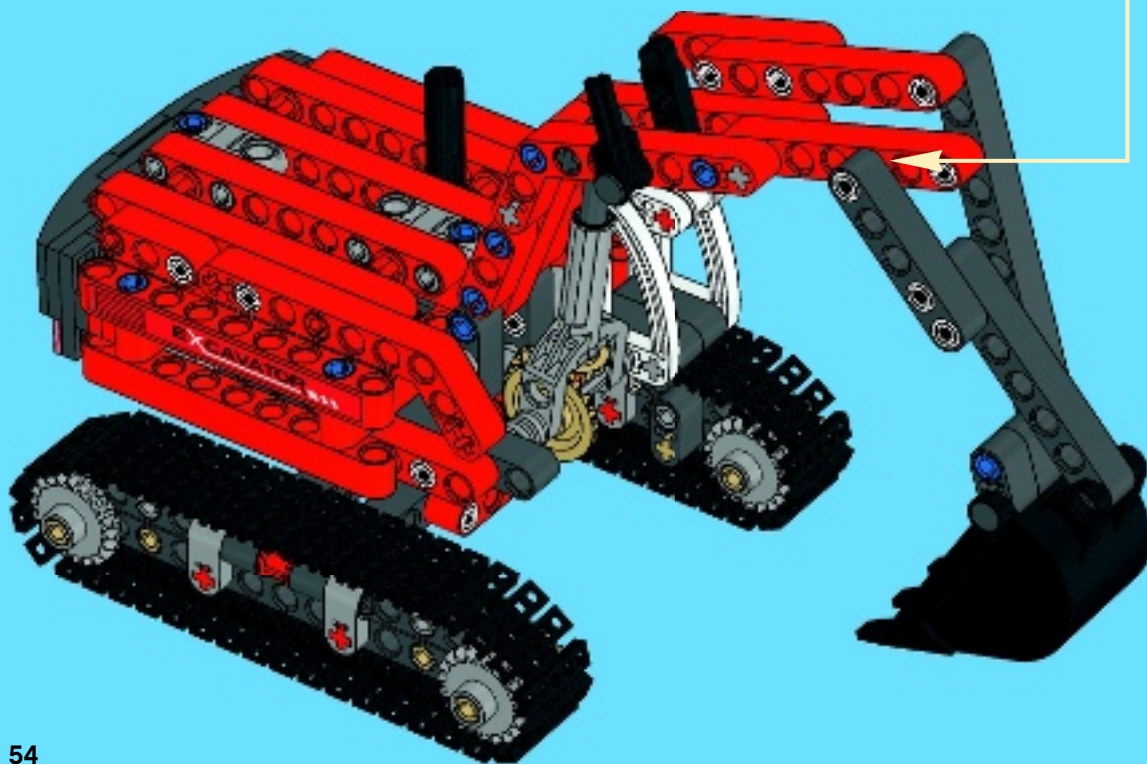
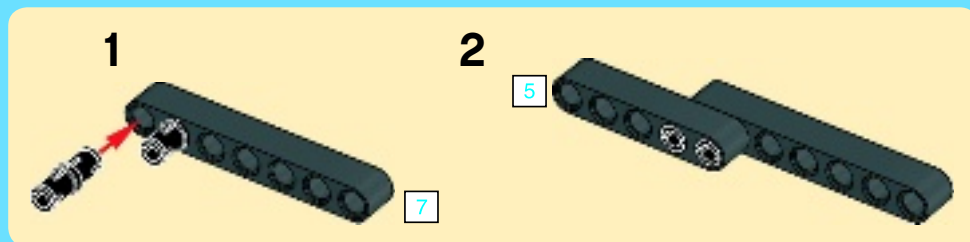



2x



1x

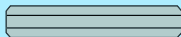

3

1:1

1



2

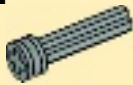

# 42

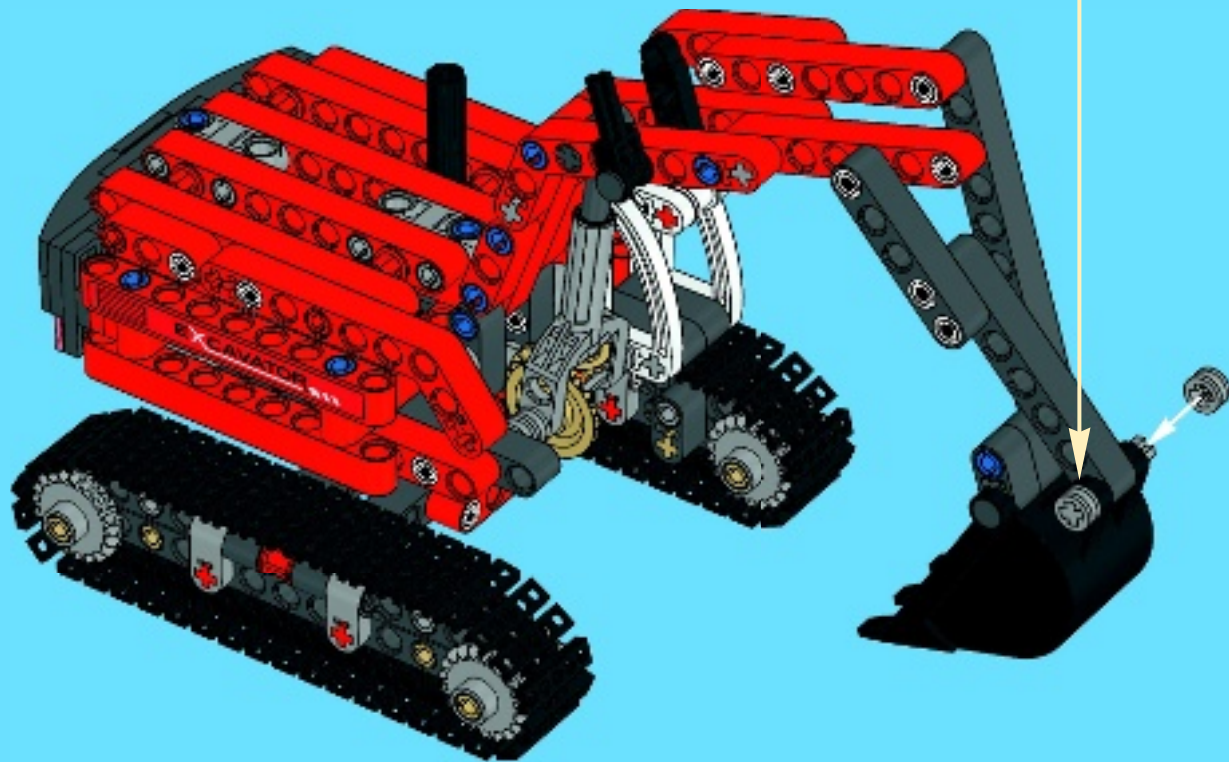



3x



2x

# 43

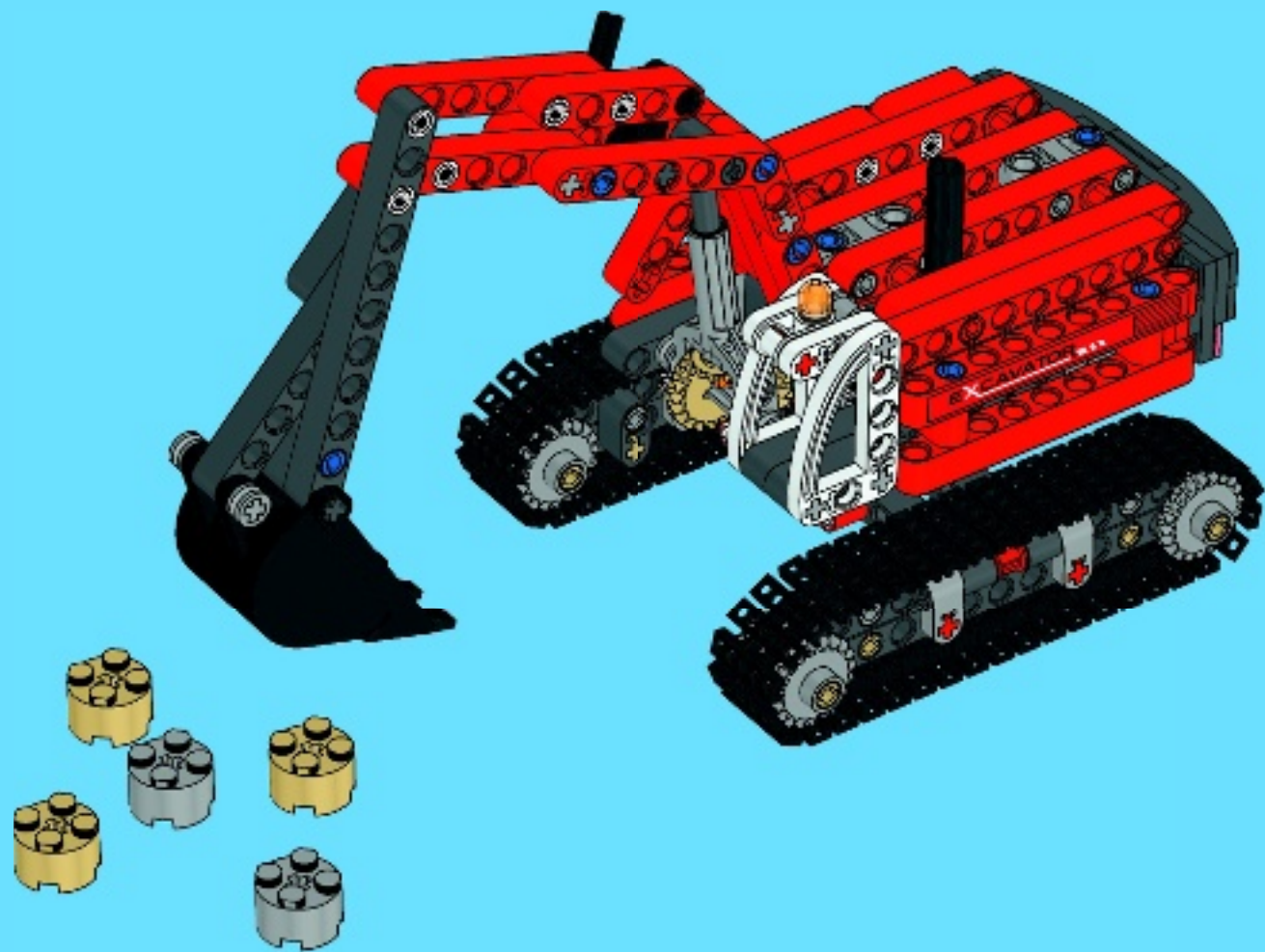



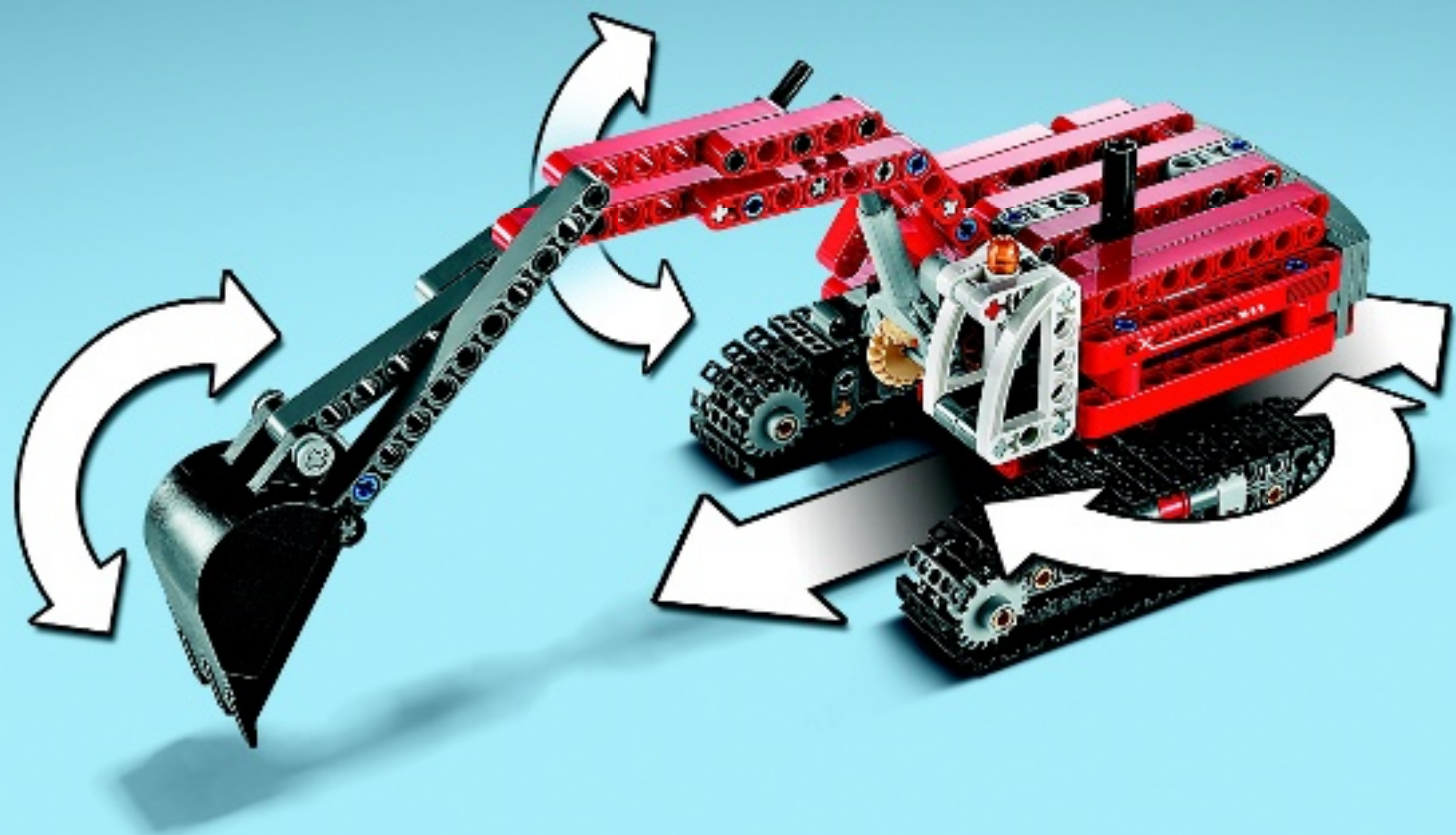





2x  
6063443



1x  
4173670



2x  
4107826



1x  
6013938



10x  
4666579



5x  
4514554



2x  
4666999



4x  
4565452



2x  
6031962



5x  
4125220



2x  
4167842



2x  
4244363



2x  
3005741



4x  
6031821



6x  
4222960



2x  
4524365



2x  
4227155



9x  
4142865



10x  
4140806



4x  
4153718



6x  
4142132



3x  
4495933



10x  
4645733



2x  
4562805



2x  
447721



3x  
4141743



2x  
4143005



4x  
6061202



45x  
4206482



52x  
4514553



2x  
4107797



3x  
4168114



5x  
4158923



2x  
4182884



6x  
6057802



4x  
4509376



7x  
4142134



3x  
4506043



6x  
4173666



3x  
4175441



4x  
4503425



2x  
4128554



4x  
4490139



2x  
4141628



6x  
6010863



2x  
4188311



2x  
4111996



2x  
4187136



2x  
4522935



3x  
4519010



6x  
4239601



5x  
370526



1x  
370626



1x  
4645732



1x  
6023352



1x  
4562379



4x  
6055626



6x  
4550937



1x  
4652236



1x  
4558692



4x  
4177431



7x  
4512363



1x  
4526982



2x  
4140430



15x  
4121667



4x  
4563044



1x  
6037533



1x  
4107765



80x  
6047885



1x  
4107783



4x  
4142823

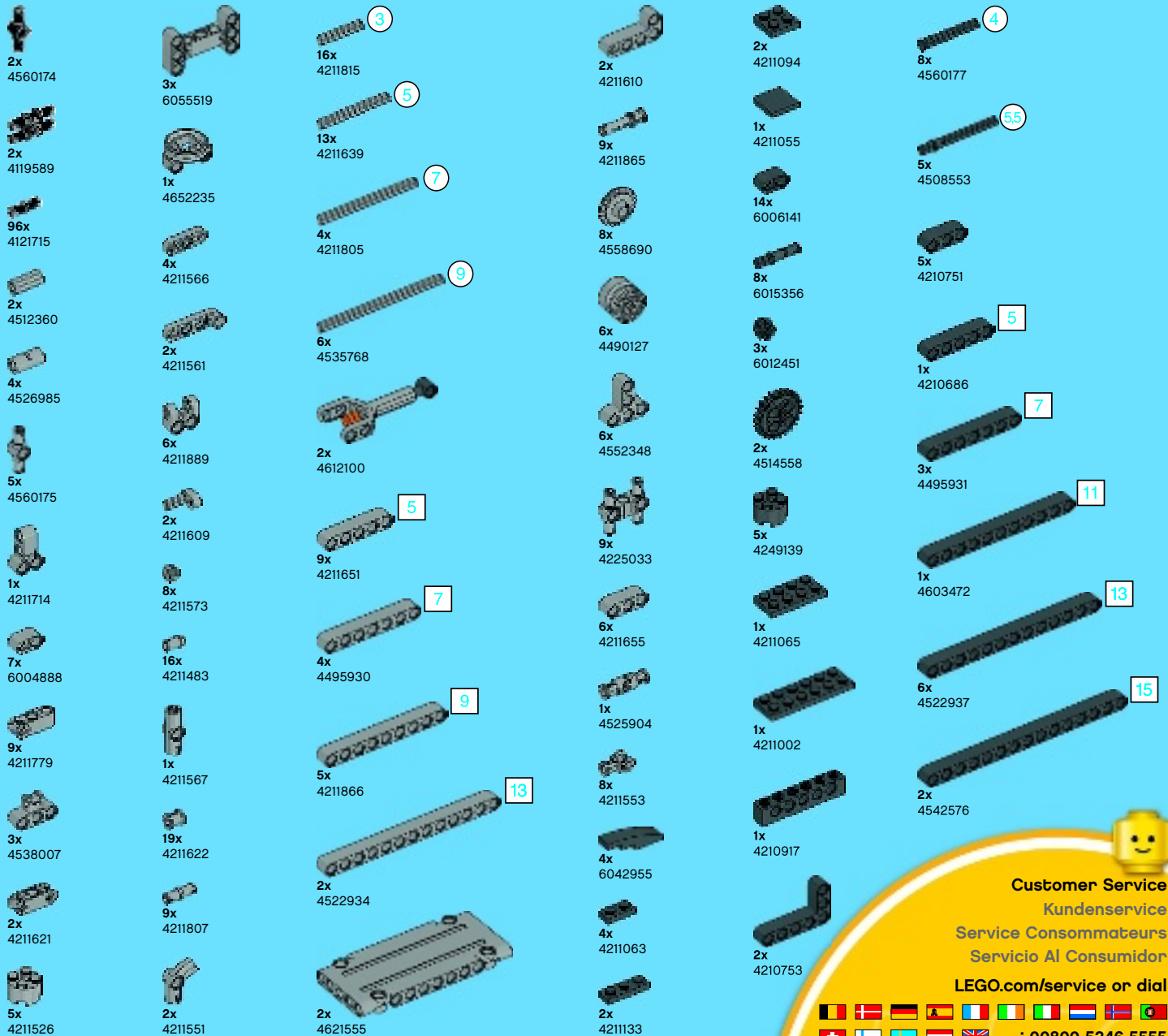



# TECHNIC

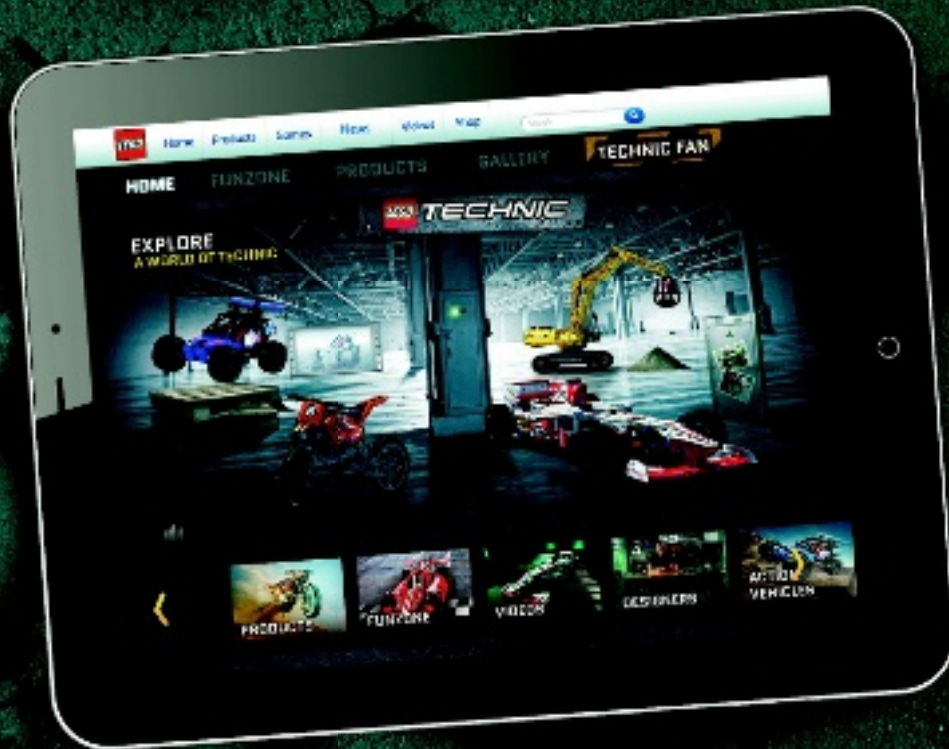

[LEGO.com/technic](http://LEGO.com/technic)