



Disney

43243



LEGO® Builder



Get excited about our new packaging!

We're switching from plastic to paper-based packaging. That's why you might find a mix of paper and plastic in our boxes!

Nos nouveaux emballages vous emballeront !

Nous passons des emballages en plastique aux emballages à base de papier. C'est pourquoi vous pourriez trouver un mélange de papier et de plastique dans nos boîtes !

¡Te presentamos nuestros nuevos empaques!

Estamos sustituyendo las bolsas de plástico por bolsas con base de papel. ¡Por eso, puedes encontrar una mezcla de papel y de plástico en nuestras cajas!

[LEGO.com/sustainable-packaging](https://www.lego.com/sustainable-packaging)

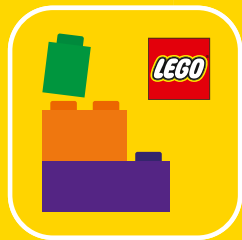

Q LEGO® Builder

BUILDER



Apple and the Apple logo are trademarks of Apple Inc., registered in the U.S. and other countries and regions. App Store is a service mark of Apple Inc. Google Play and the Google Play logo are trademarks of Google LLC. Tencent and the Tencent logo are trademarks of Tencent Inc.

Q LEGO.com/devicecheck

EN Ask parents' permission before going online | DE Eltern um Erlaubnis bitten, bevor du online gehst | FR Demande l'autorisation d'un parent avant d'aller en ligne | IT Chiedi il permesso ai tuoi genitori prima di andare online | ES Pídeles permiso a tus papás antes de conectarte a Internet | PT Pede autorização aos pais antes de acederes online | ZH 上网前应先征得父母的同意 | PL Poproś rodziców o zgodę, zanim wejdiesz do Internetu | CS Než půjdeš na internet, požádej rodiče o svolení | SK Skôr než pôjdeš na internet, vypýtaj si povolenie od rodičov | HU Kérj szülői engedélyt, mielőtt online csatlakoznál! | RO Cere permisiunea părinților înainte de a te conecta online | BG Поискайте разрешение от родител, преди да влезете онлайн | LV Pirms došanās tiešsaistē palūdz atļauju vecākiem | ET Enne Interneti kasutamist küsi vanematelt luba | LT Prieš prisijungdami prie interneto, atsiklauskite tėvų

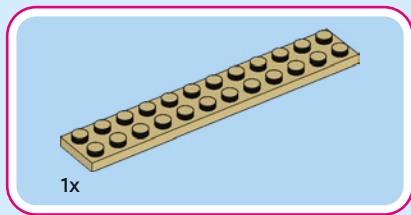

1

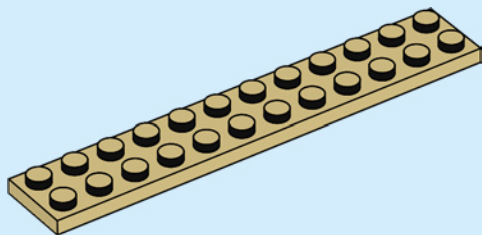



2x

2

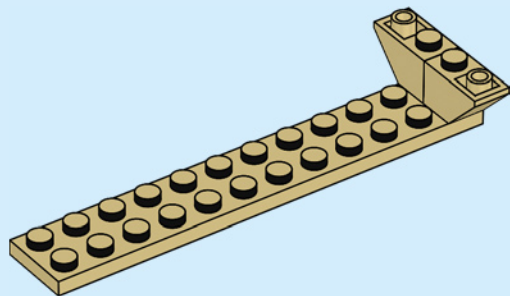

1x

3

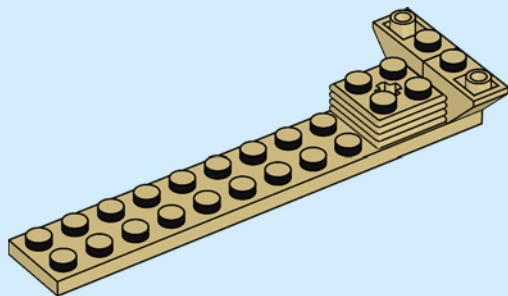

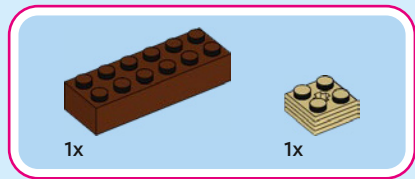

4

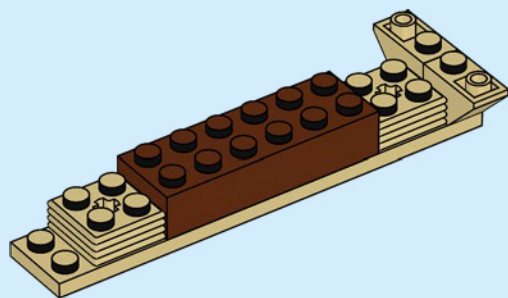



2x

5

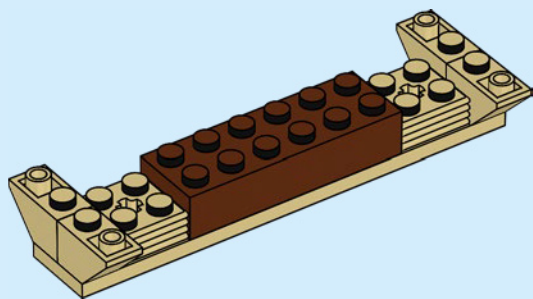

4x

6

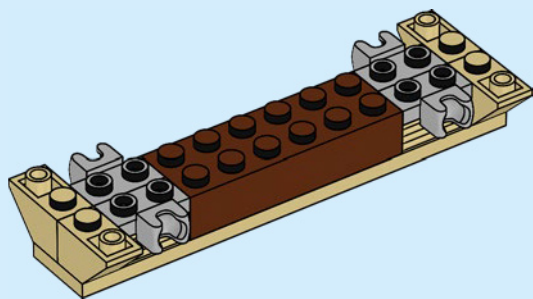



2x

7

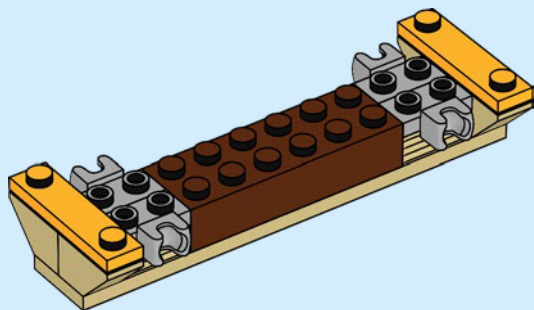

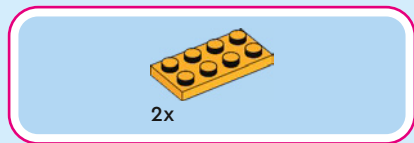

8

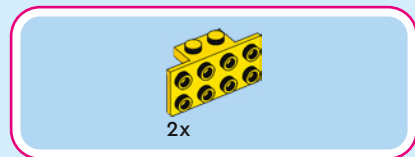
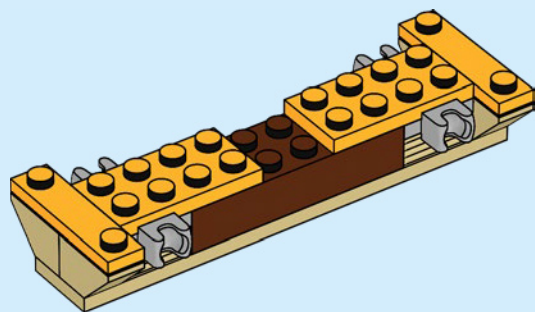

9

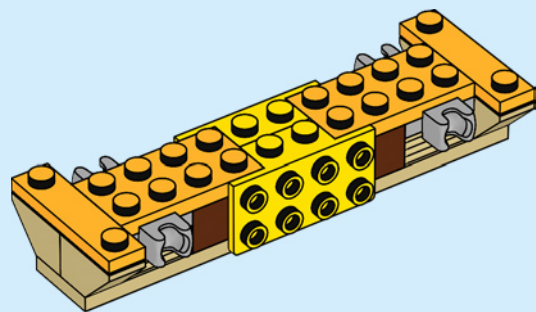



3x

10

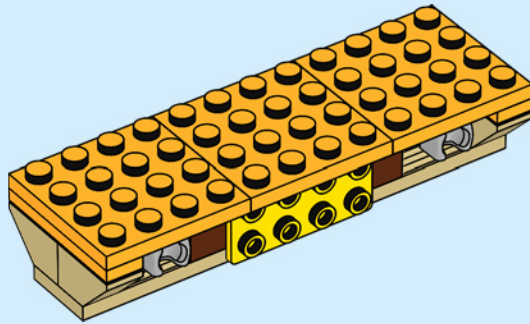

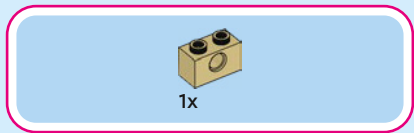

11

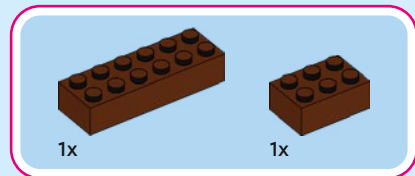
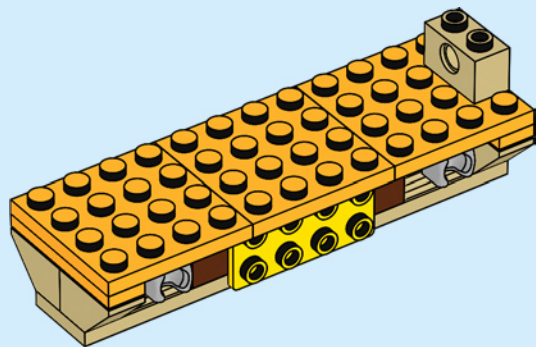

12

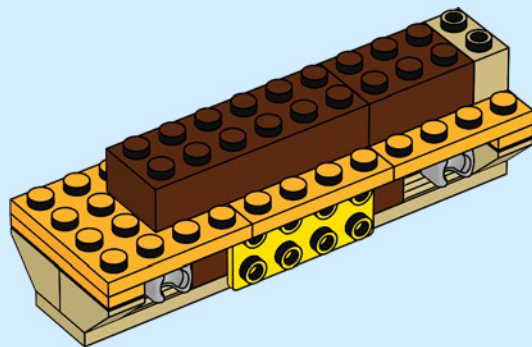



1x

13

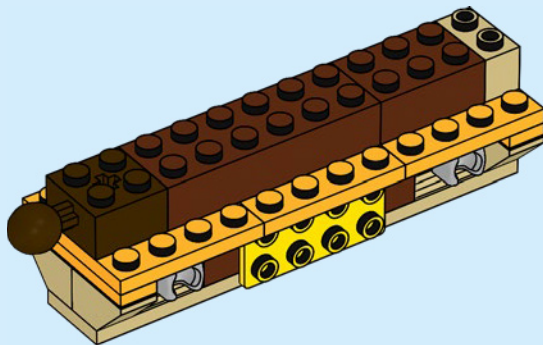

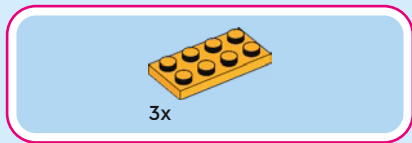

14

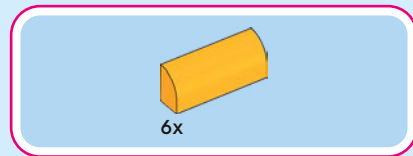
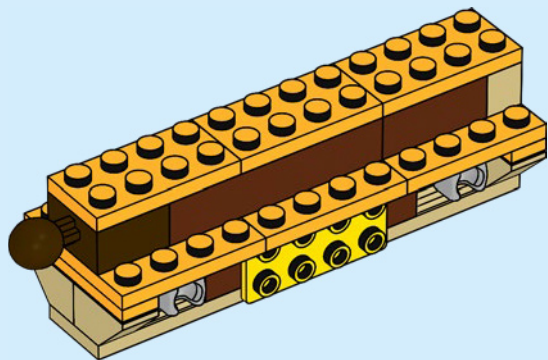

15

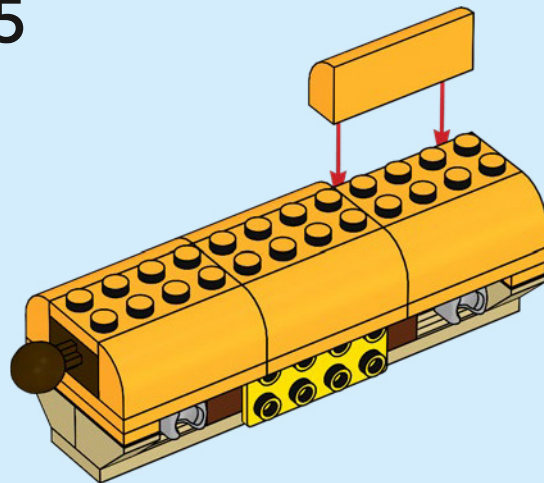

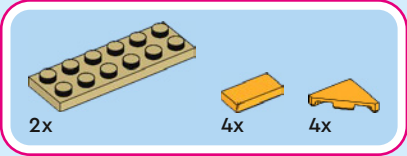
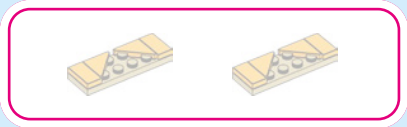

16

1

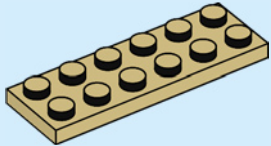

2

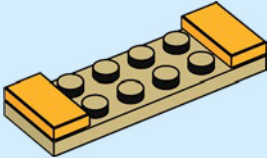

3

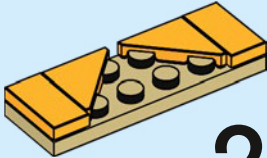

2x

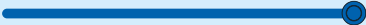

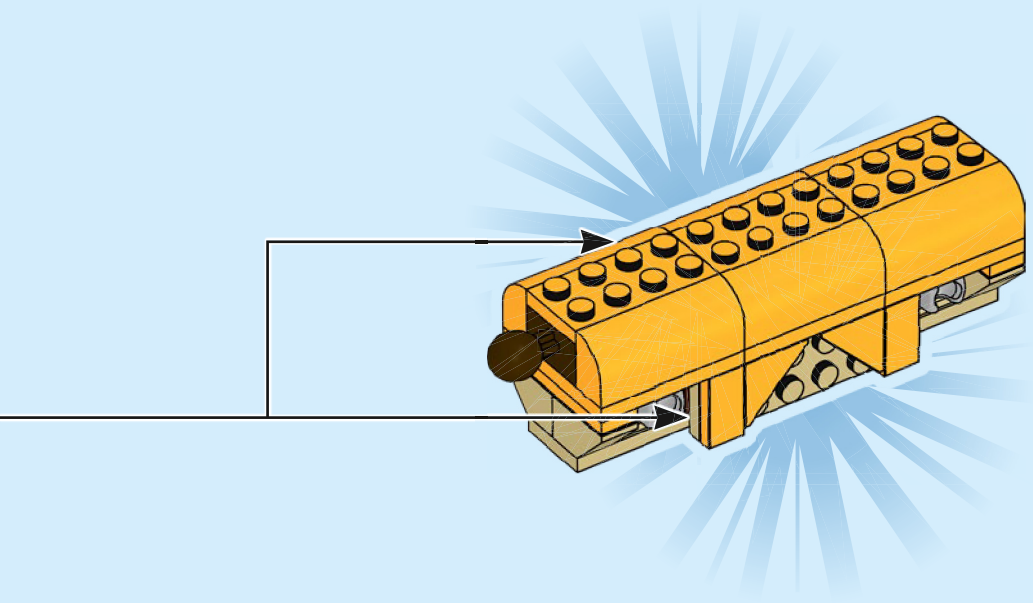

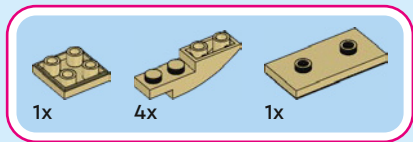

17

1

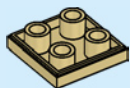

2

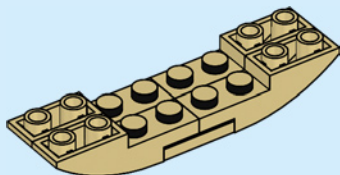

3

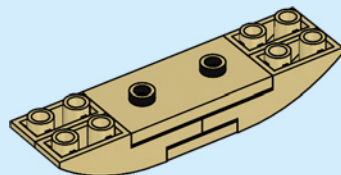

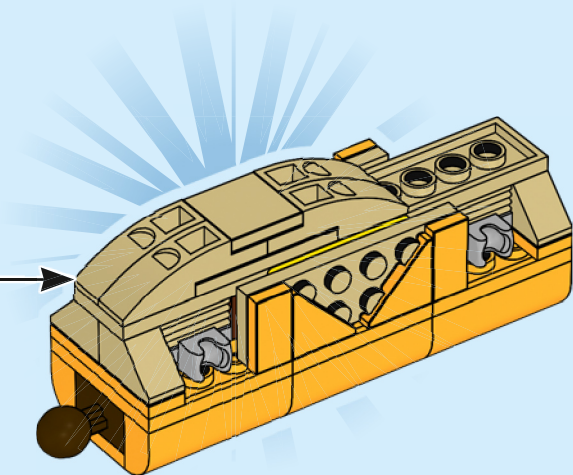

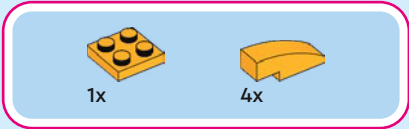

18

1

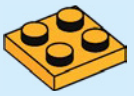

2

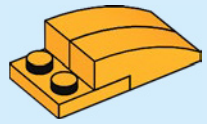

3

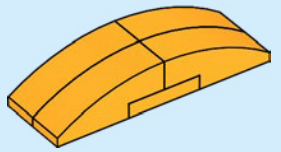

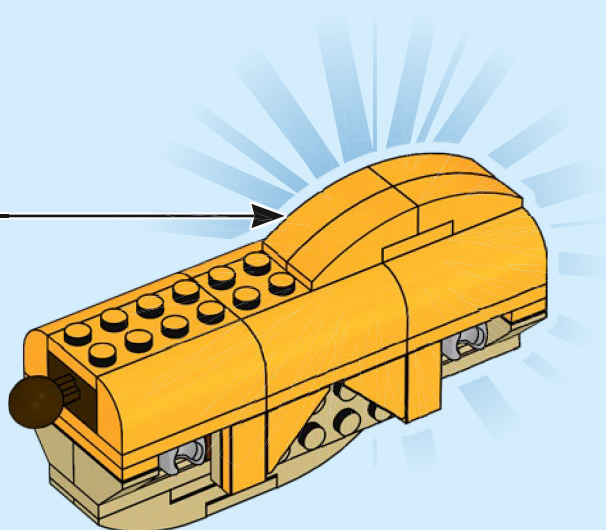

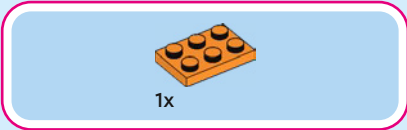
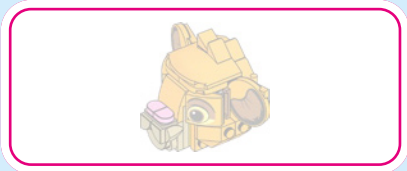

19

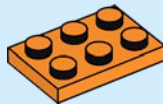



1x



1x

20

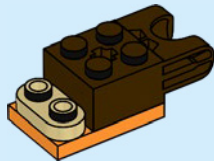

1x

21

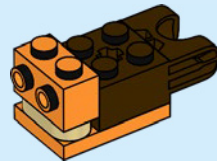

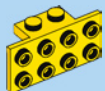

2x

22

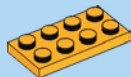
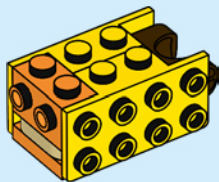

1x

23

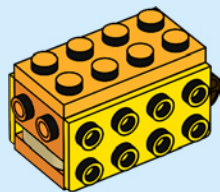

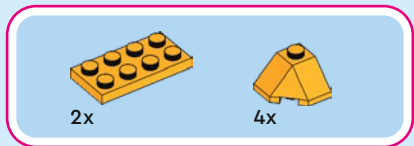

24

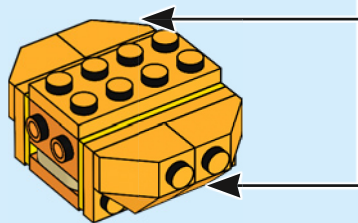
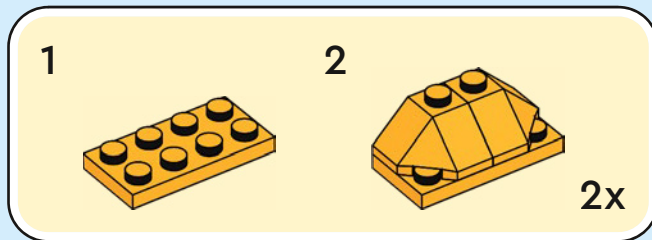

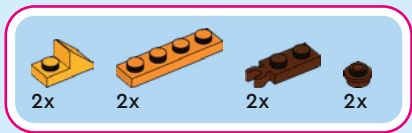

25

1

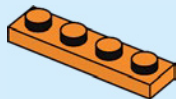

2

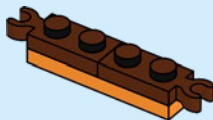

3

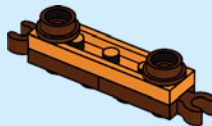

4

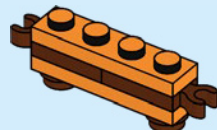

5

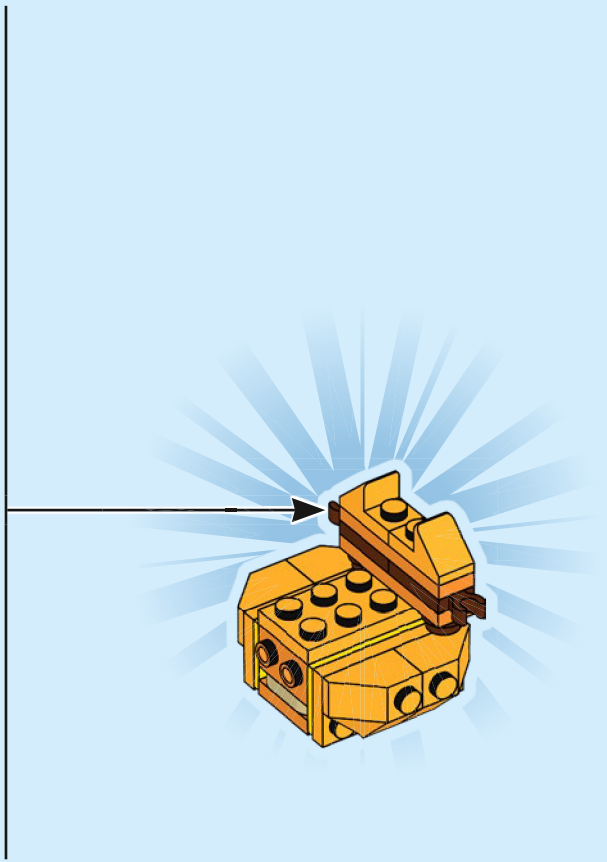
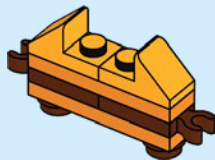



1x

26

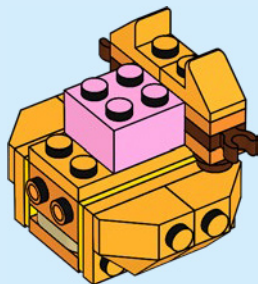



2x

27

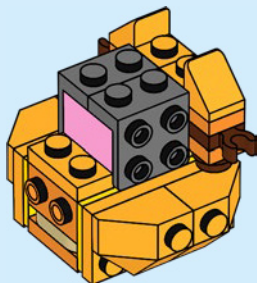

1x



1x

28

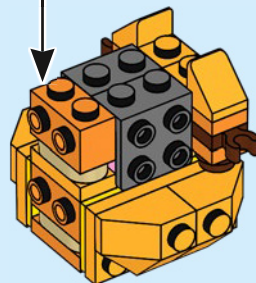
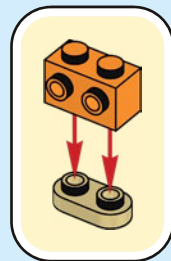



1x

29



1x



1x

30

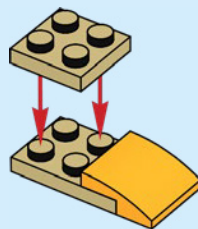



1x



1x

31

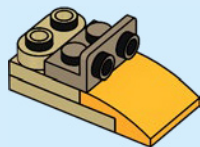

2x

32

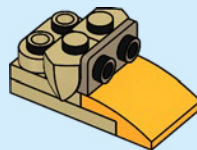



1x

33

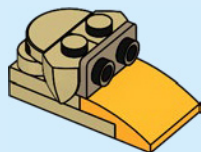

2x

34

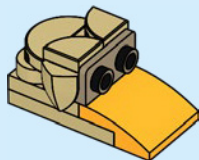

2x

35

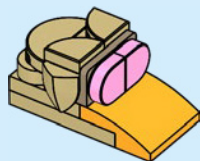

36

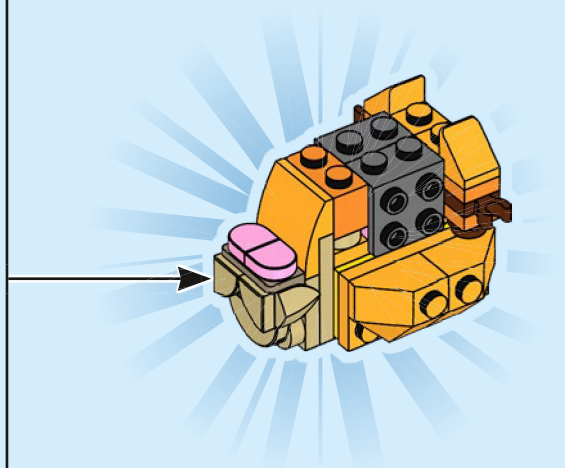



2x

37

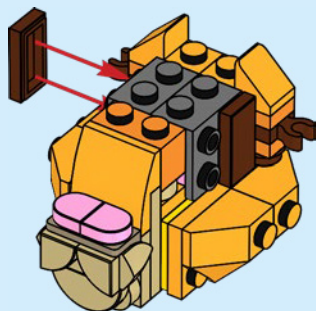

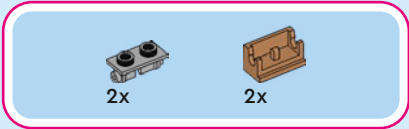

40

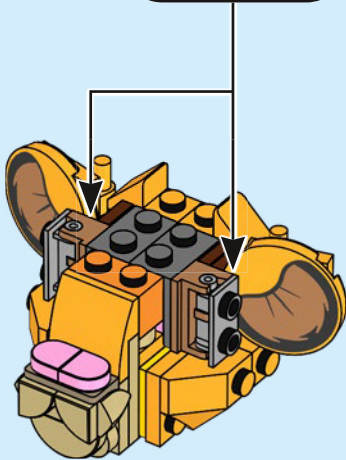
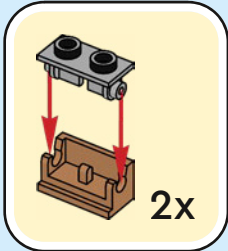

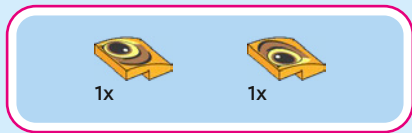

41

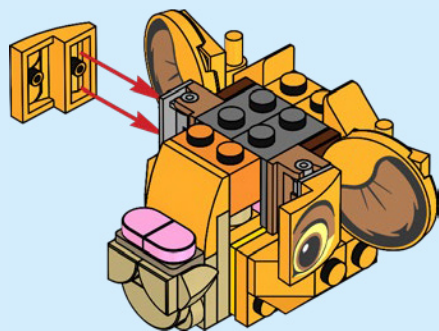

42

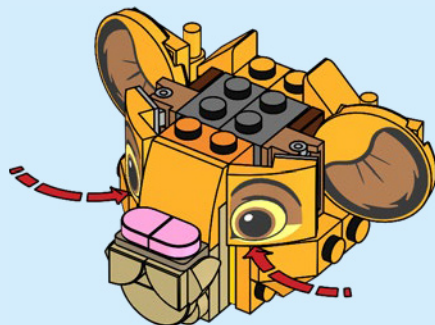



1x

43

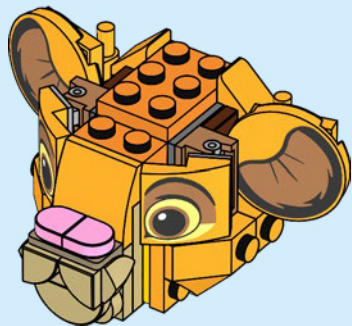



2x

44

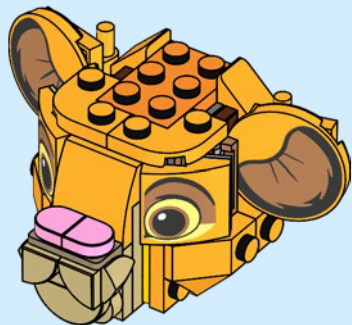

1x

45

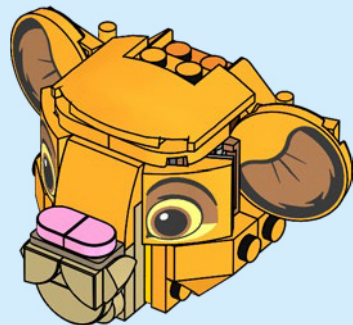



2x

46

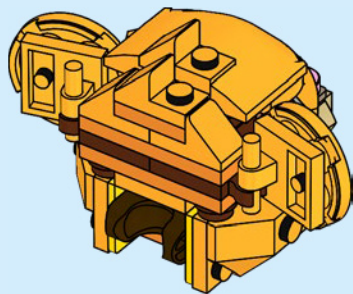



2x

47

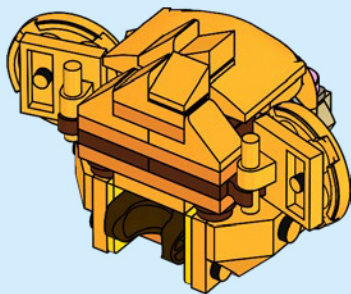

48

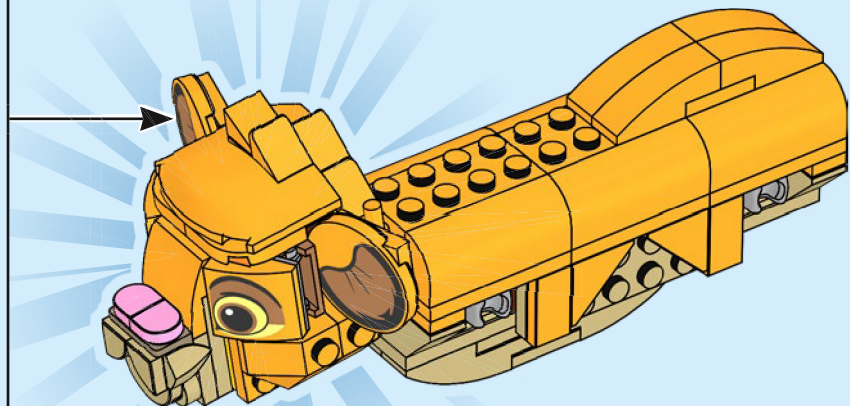

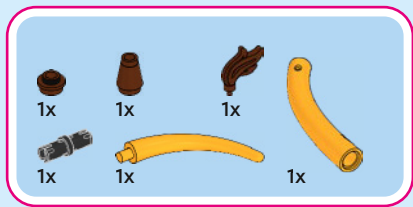

49

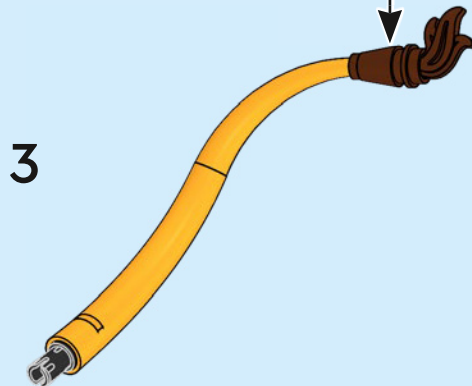
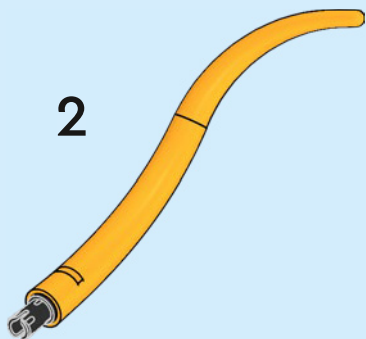
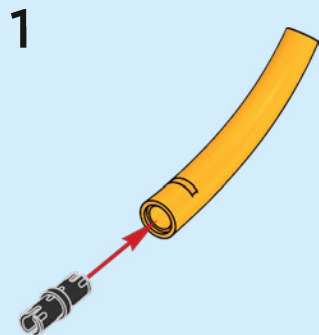
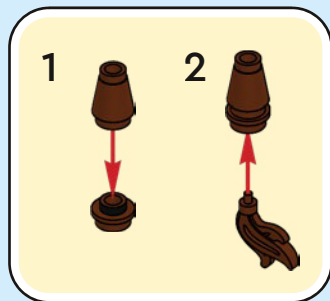

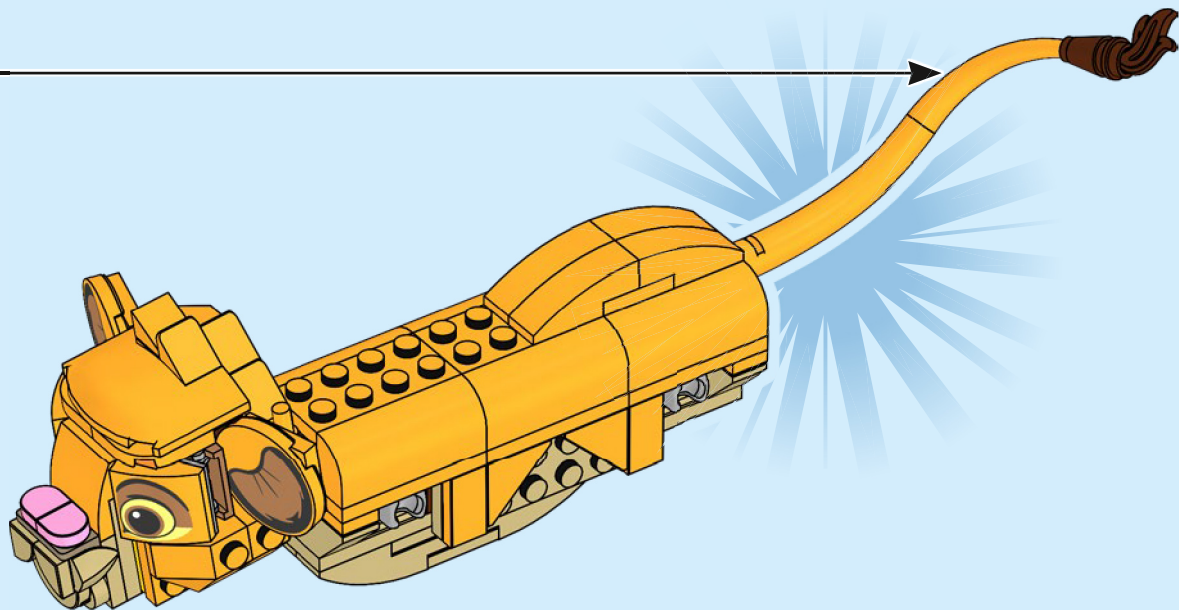



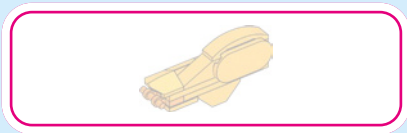

50

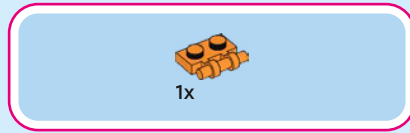
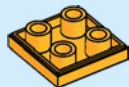

51



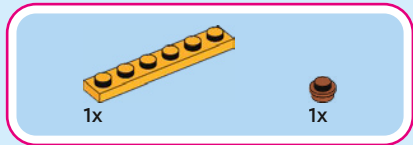

52

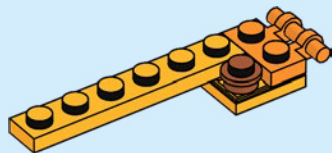



1x

53

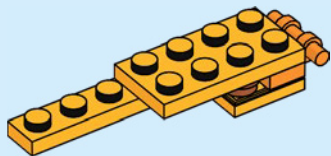

1x

54

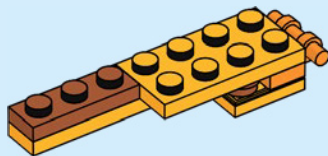

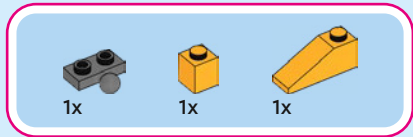

55

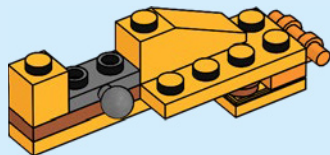



1x



1x

56

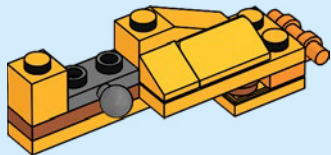

1x

57

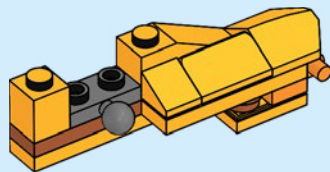



1x

58

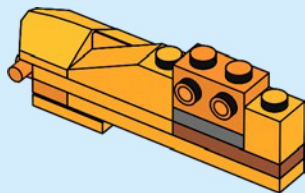

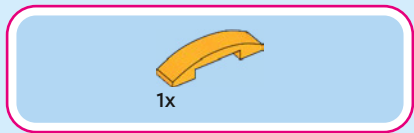

59

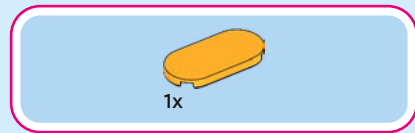
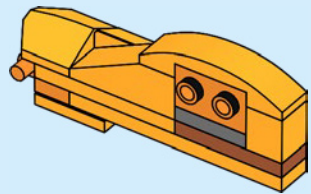

60

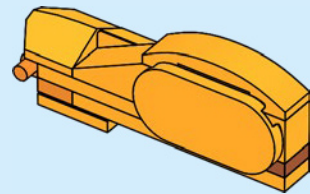



1x

61

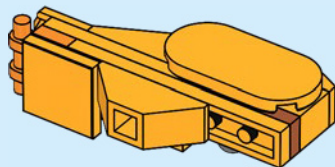

62

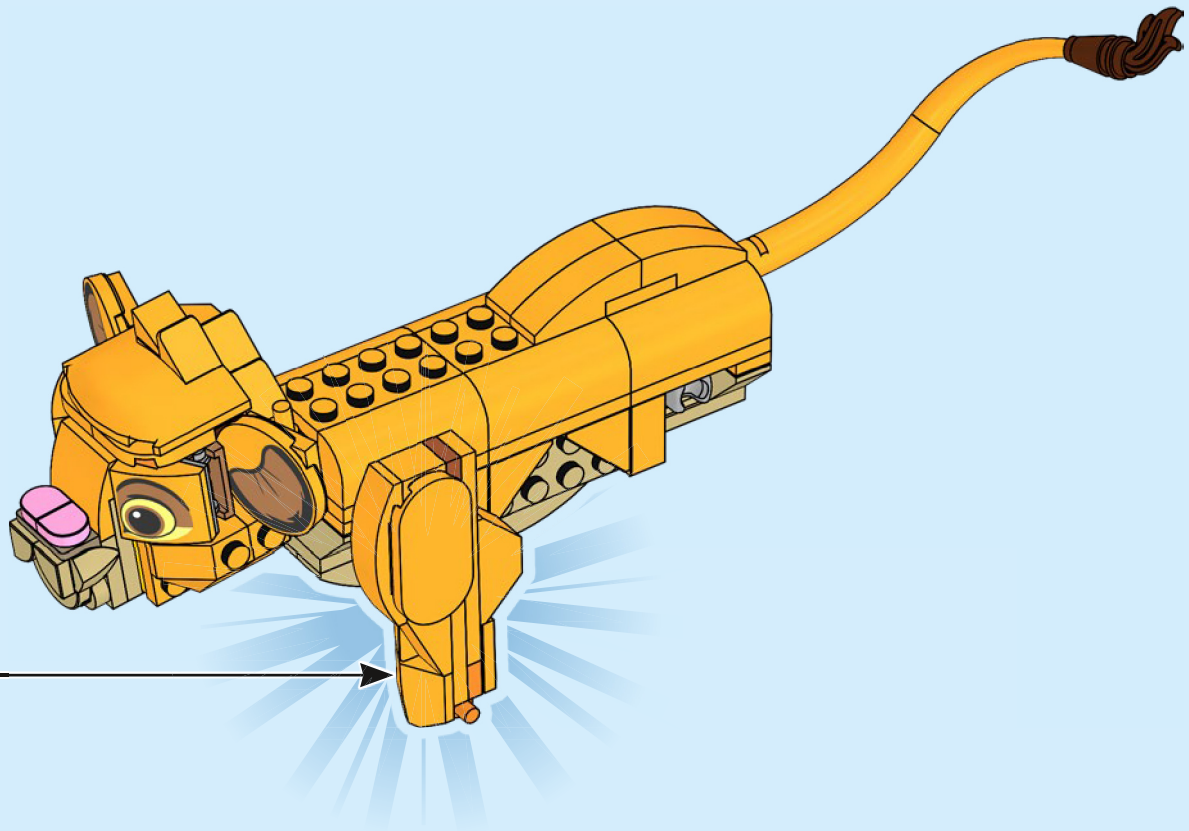

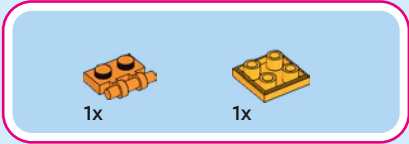
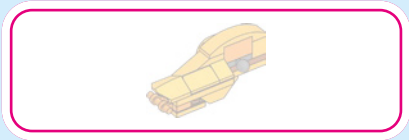

63

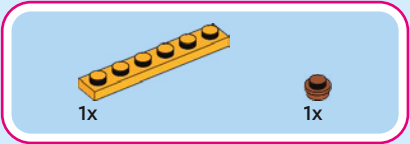

64

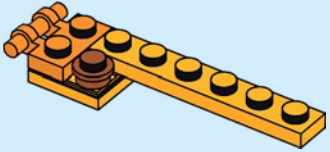



1x

65

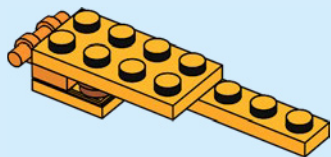

1x

66

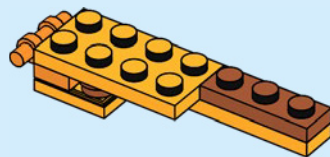

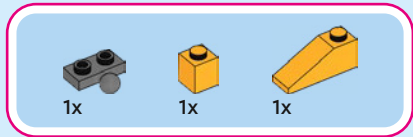

67

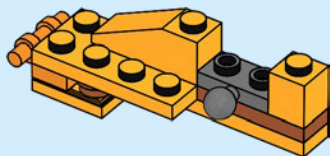



1x



1x

68

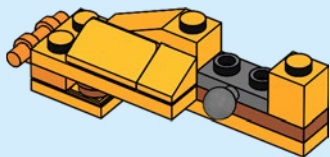

1x

69

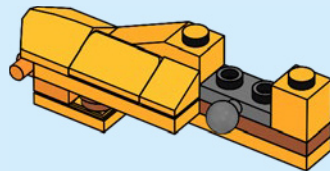



1x

70

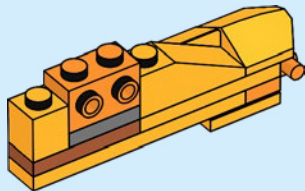

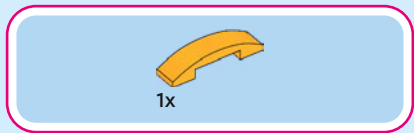

71

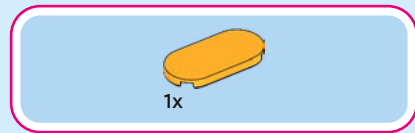
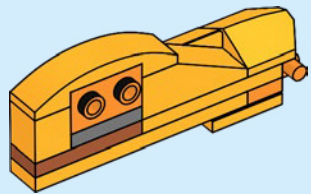

72

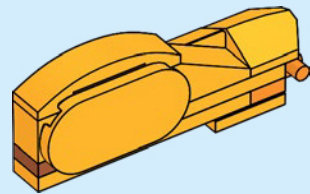



1x

73

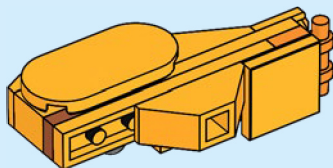

74

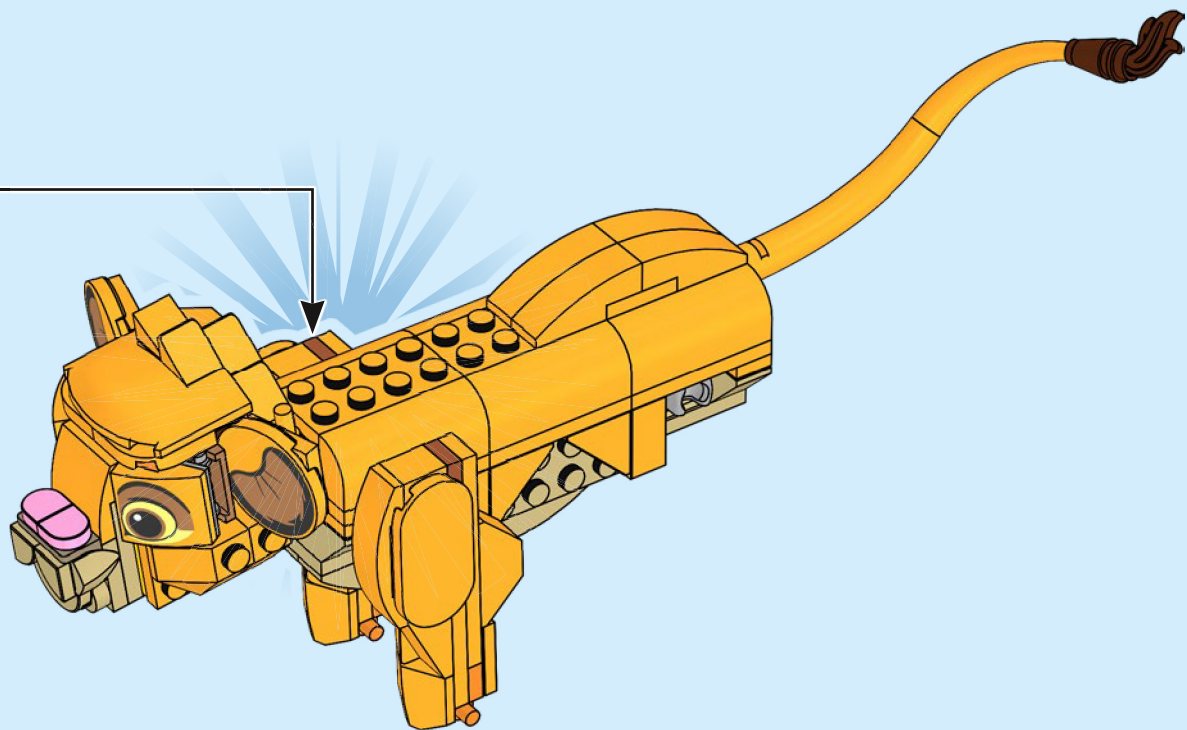

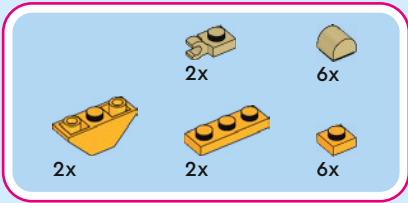

75

1

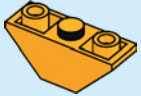

2

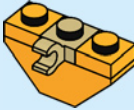

3

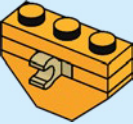

4

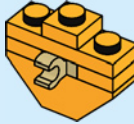

5

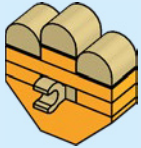

2x

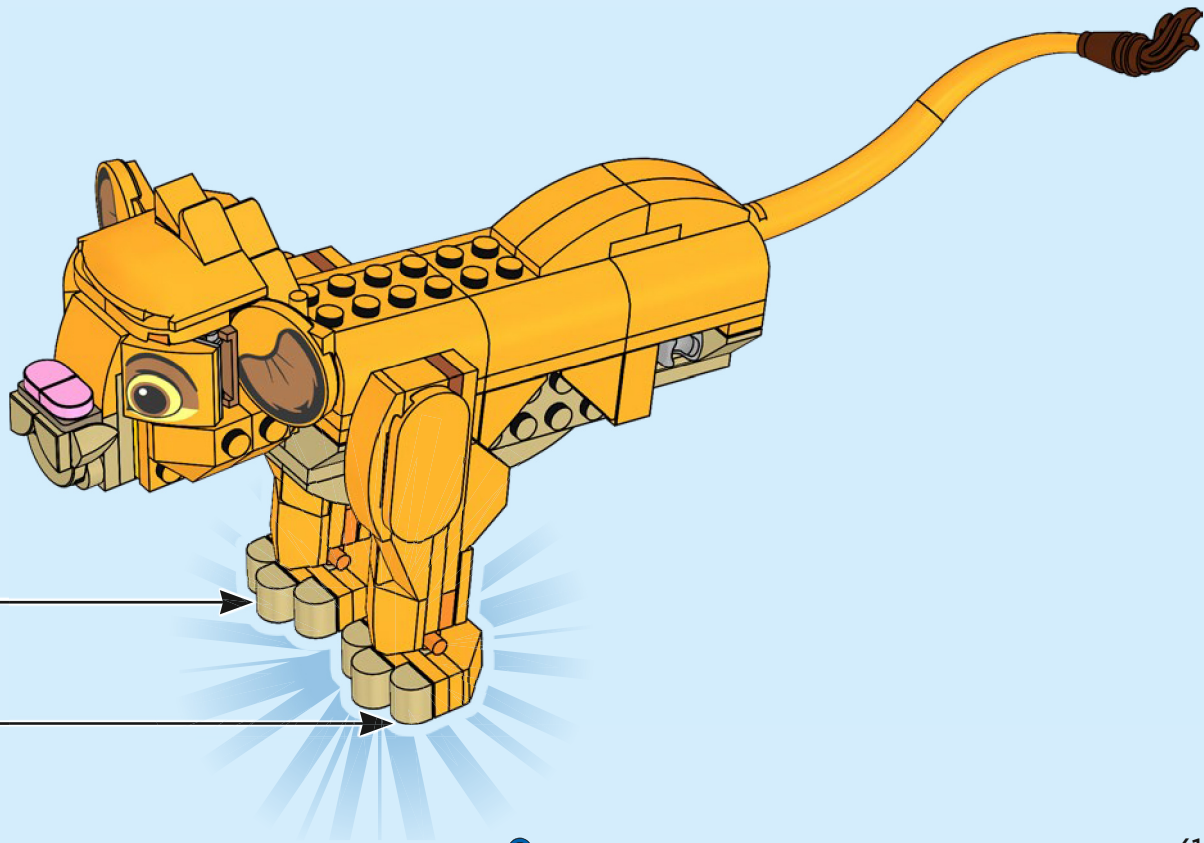



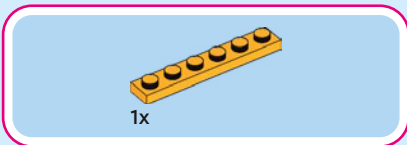
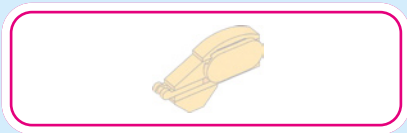

76

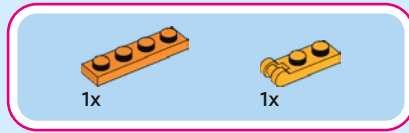
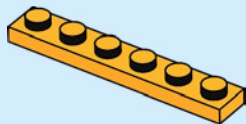

77

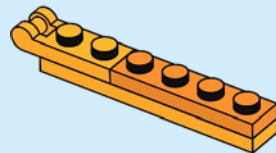

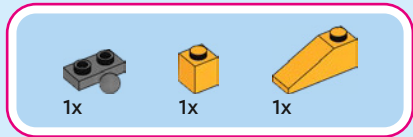

78

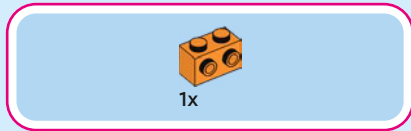
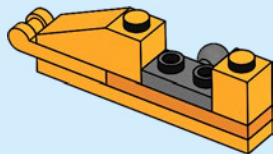

79

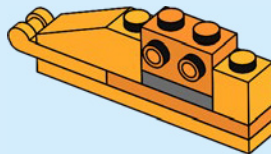



1x

80

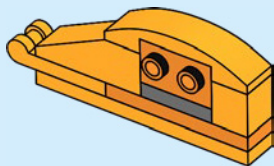

1x

81

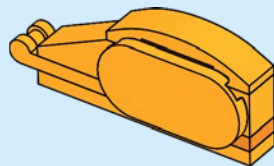



1x

82

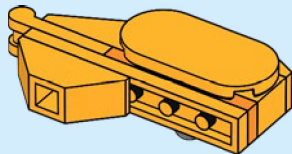

83

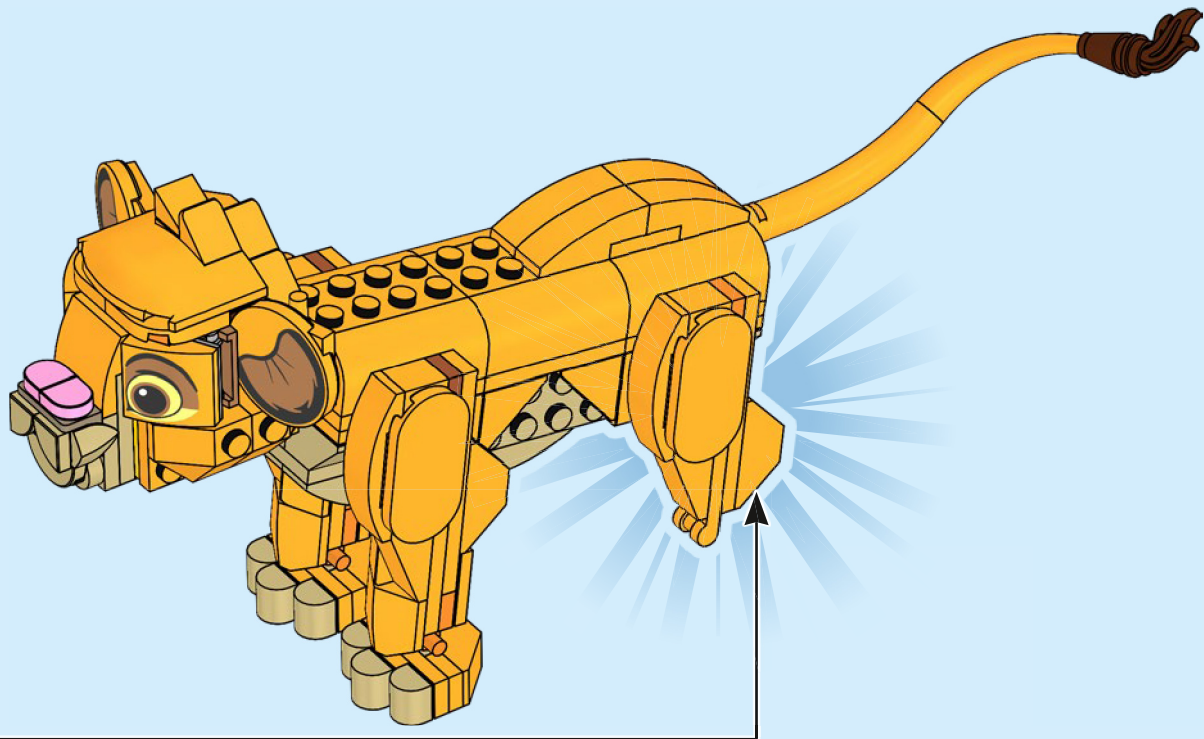



1x

84

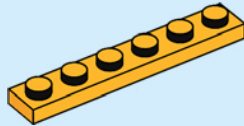

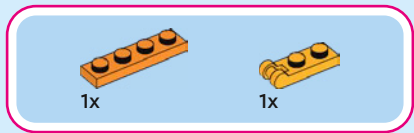

85

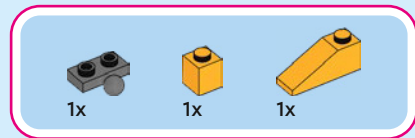
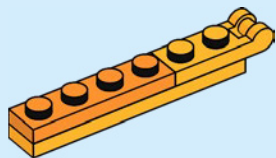

86

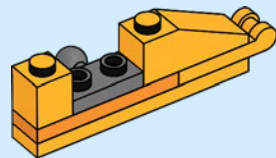



1x

87

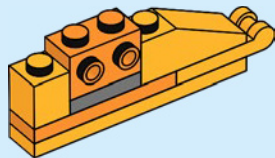

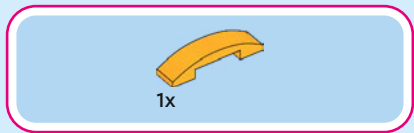

88

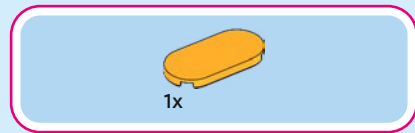
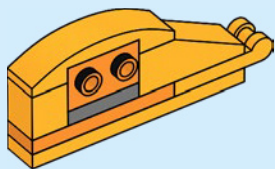

89

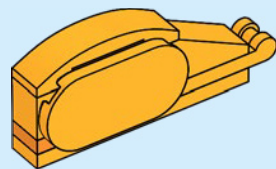



1x

90

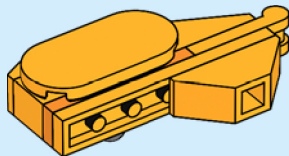

91

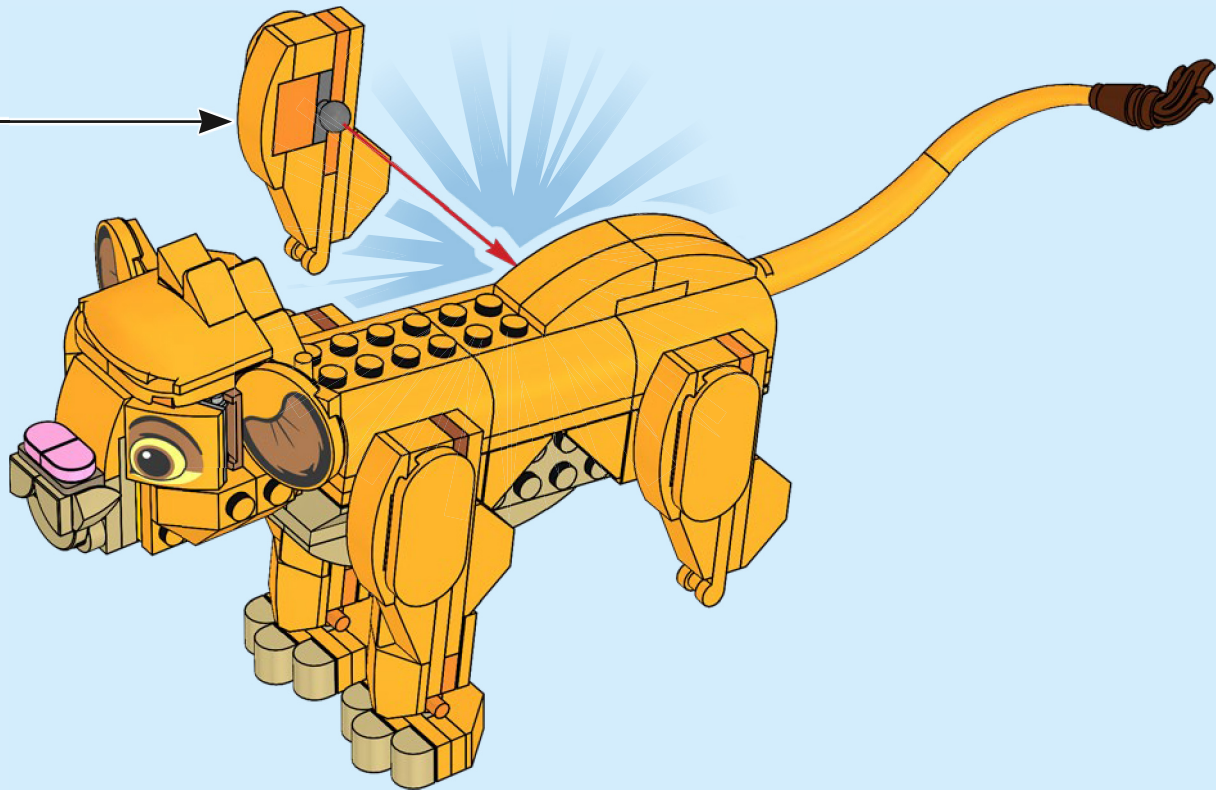

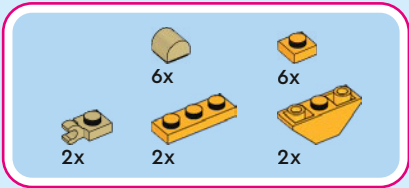

92

1

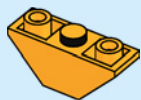

2

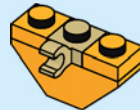

3

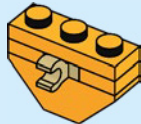

4

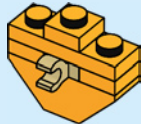

5

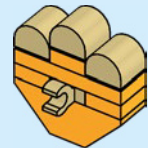

2x

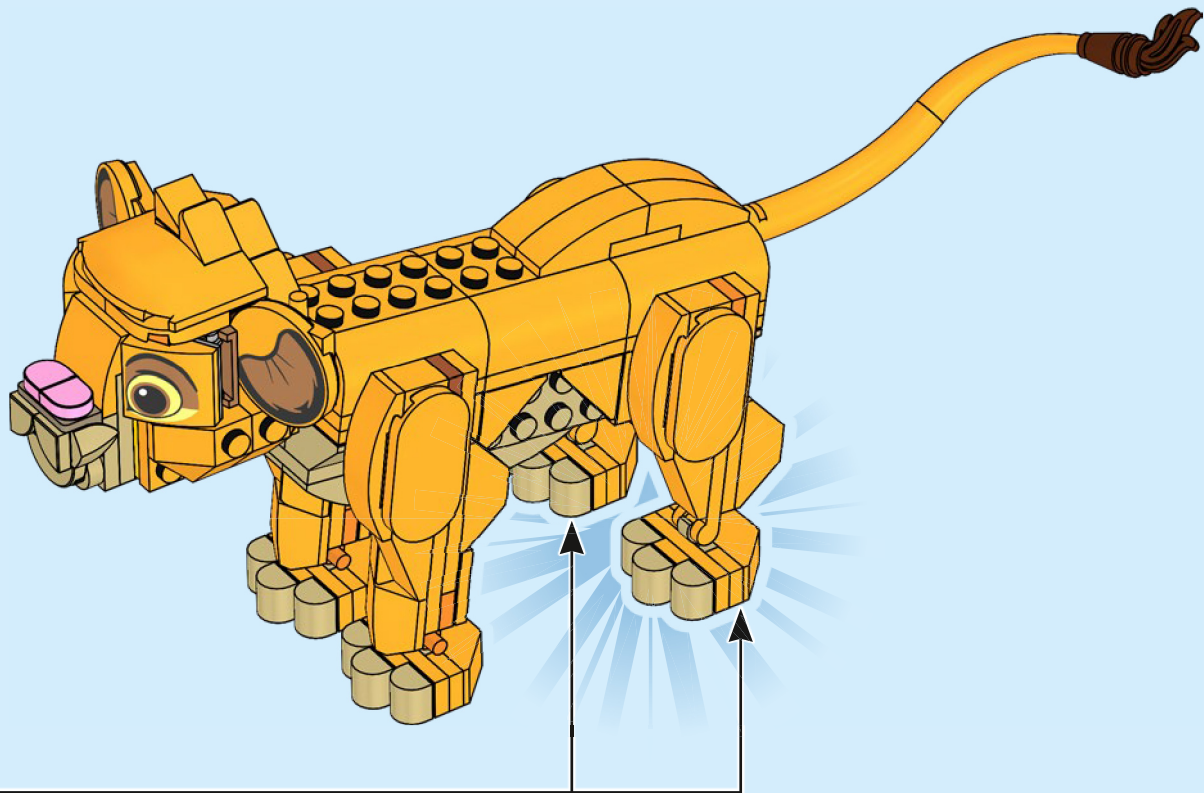



1x

93



2x

94

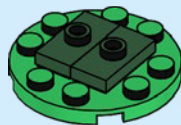



2x



2x

95

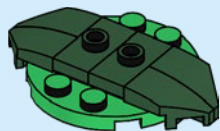

2x



1x

96

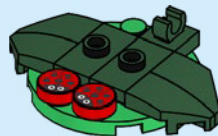

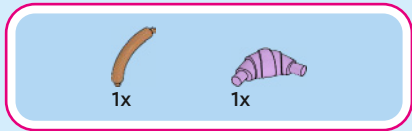

97



98

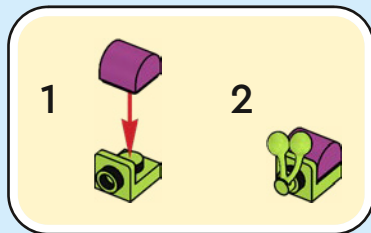

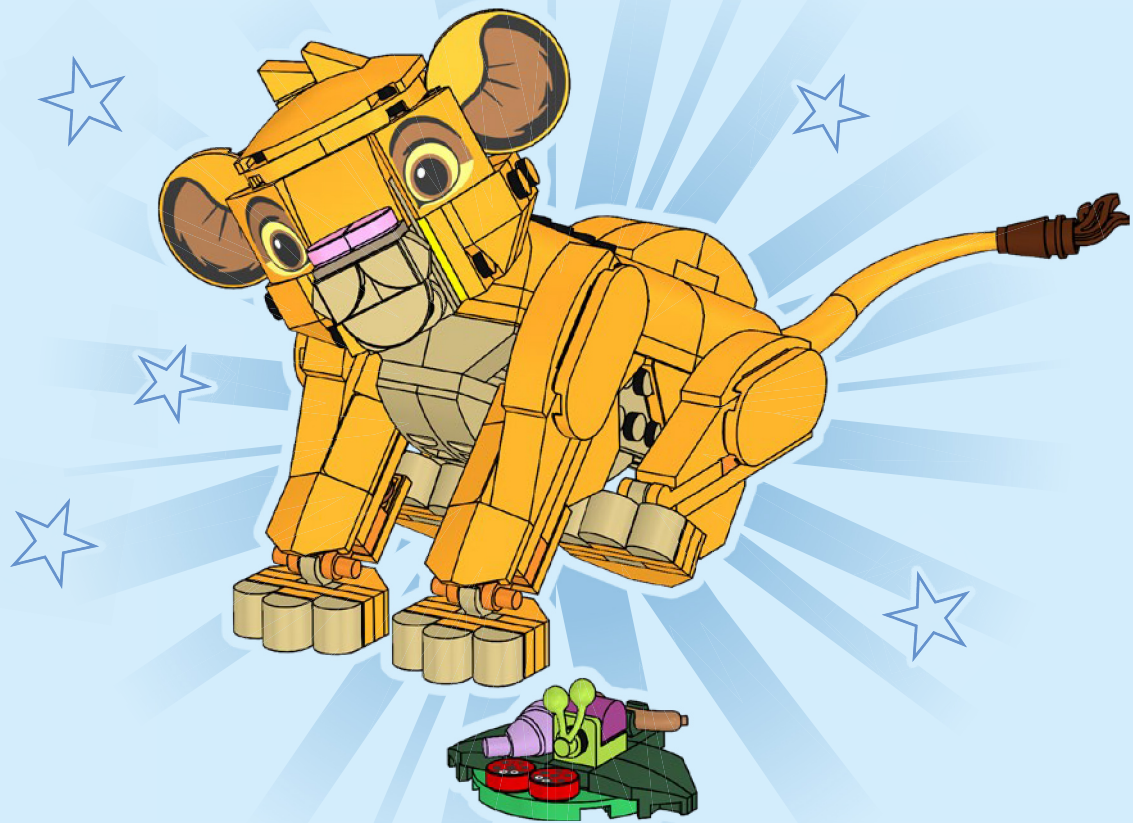



Disney



[LEGO.com/disney](https://www.lego.com/disney)





1x
4205107



4x
4159196



12x
6286329



4x
6273851



1x
4114084



1x
4118790



1x
6294227



2x
4113993

82

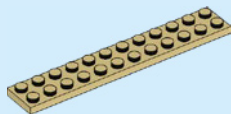

1x
6093864



4x
6347292



1x
6013081



2x
6145570



1x
6408047



3x
6212758



2x
6143058



2x
6330903



1x
6279875



1x
6353423



2x
6186007



2x
6315782



6x
6223454



2x
4125278



4x
4118782



2x
4190164



1x
6365620



1x
6087084



1x
6278442



1x
6250168



2x
6214814



2x
6214813



2x
6192250



1x
6348061



4x
6061685



4x
6023173



2x
6024286



4x
6330901



4x
6484946



8x
6484948



4x
6131583



1x
6099730



1x
6490743



1x
6481712



4x
6022064



4x
6133826



6x
6422296



12x
6073040

4x
4622062



4x
6479470

1x
6003033

4x
6073042

2x
6257595

10x
6097511

4x
6020074

2x
6491824

2x
6484950

2x
6248671

2x
6444576

2x
6481711

4x
6422093

1x
6485967



1x
6210392



3x
6093272

1x
6218142

2x
6400434

1x
4216668

2x
4216615

1x
4529242

2x
4211151

2x
6459597

3x
6215659

1x
6484949

2x
6117972

4x
6039479

1x
6484947

4x
6043656

2x
4211470

1x
4550359

2x
6258972

1x
6045909

1x
6360827

1x
6417964

2x
6167642

2x
6324417

4x
6118828



 [LEGO.com/service](https://www.LEGO.com/service)

YOU COULD **WIN**



Scan this QR code or go to **LEGO.COM/PRODUCTFEEDBACK** and give us your short feedback about this LEGO® set for a chance to win a cool LEGO prize.

Terms and Conditions apply*

EN: YOU COULD WIN. Terms and Conditions apply* **DE: Du könntest GEWINNEN.** Es gelten die Teilnahmebedingungen* **FR: Tu pourrais GAGNER.** Des conditions s'appliquent* **IT: Potresti VINCERE tu.** Termini e condizioni sono applicabili* **ES: Puedes GANAR.** Aplican términos y condiciones* **PT: Poderá GANHAR.** Aplicam-se termos e condições* **ZH: 轻松获奖. 条款和条件适用*** **PL: Szansa na WYGRANĄ.** Obowiązują warunki korzystania* **CS: Máte šanci VYHRÁT.** Platí všeobecné smluvní podmínky* **SK: Máte šancu VYHRAŤ.** Platia všeobecné zmluvné podmienky* **HU: TE IS NYERHETSZ.** Felhasználási feltételek érvényesek* **RO: Ai putea CÂȘTIGA.** Se aplică termenii și condiții* **BG: Можете да СПЕЧЕЛИТЕ.** Има определени правила и условия* **LV: Tu vari LAIMĒT.** Ir spēkā noteikumi un nosacījumi.* **ET: Sul on võimalus VÕITA.** Kehtivad tingimused* **LT: Jūs galite LAIMĖTI.** Taikomos sąlygos*

*[LEGO.com/productfeedback-terms](https://www.lego.com/productfeedback-terms)

LEGO and the LEGO logo are trademarks of the/sont des marques de commerce du/son marcas registradas de LEGO Group. ©2024 The LEGO Group.