



4439

# CITY





3

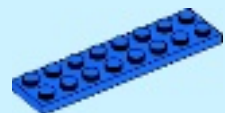
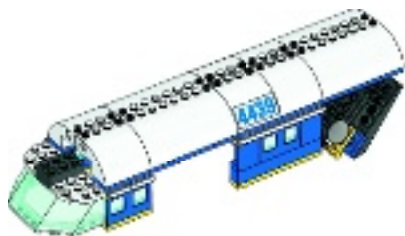

2x



2x

60

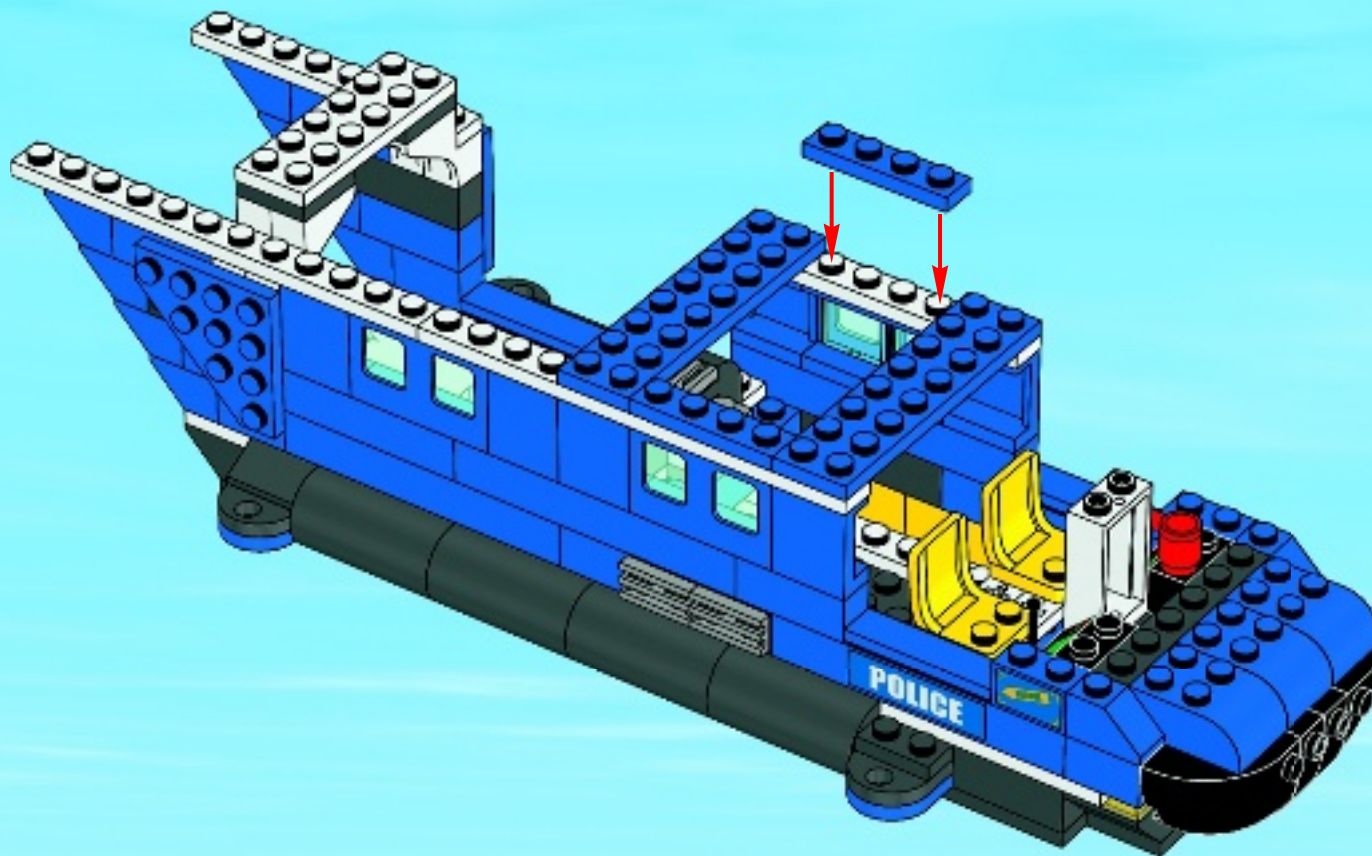





61

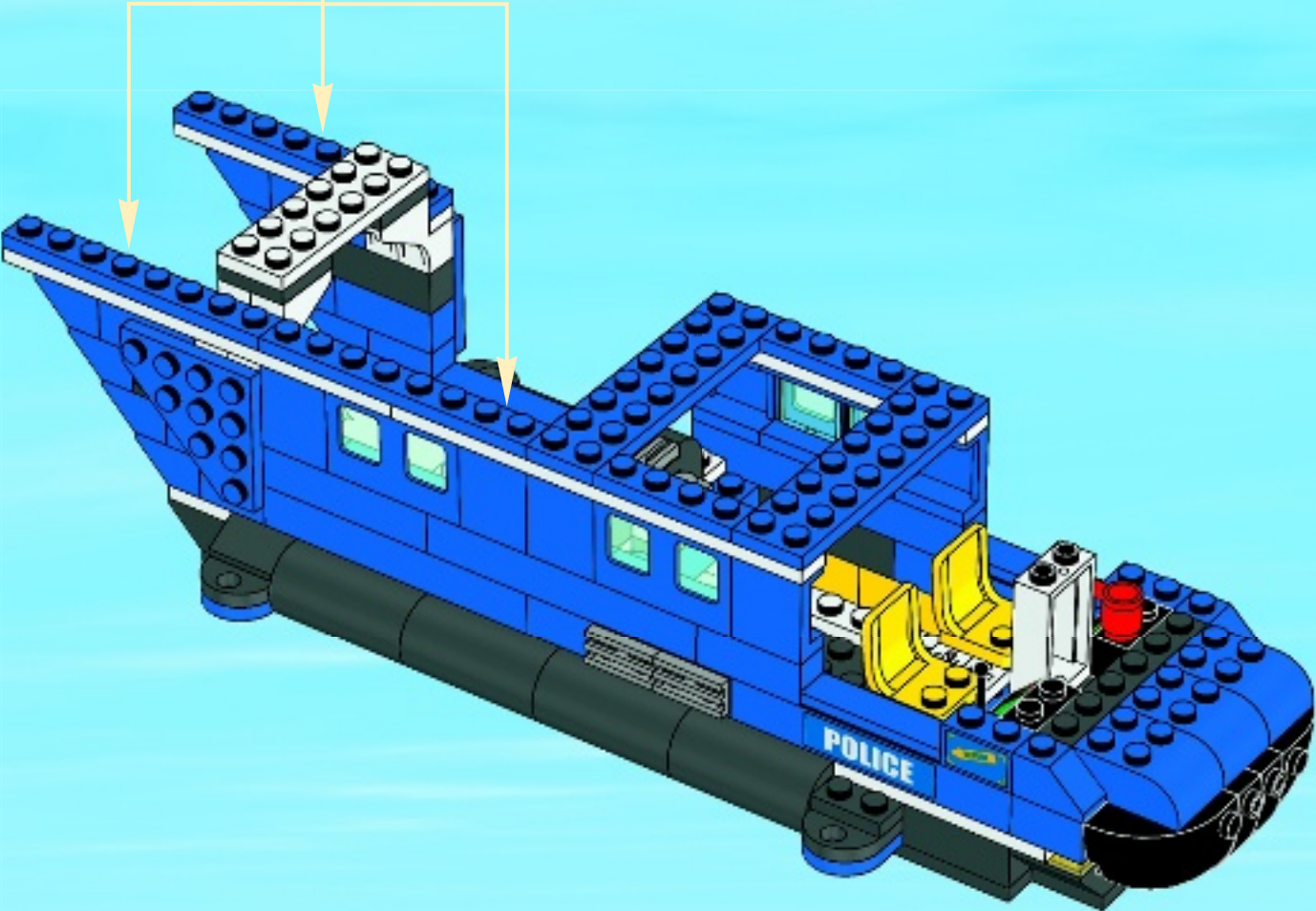
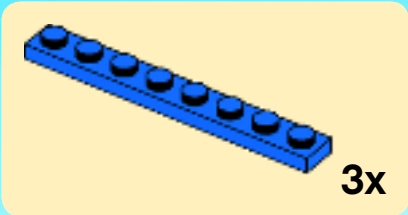

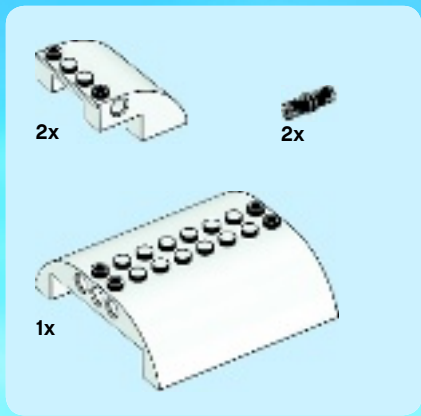

**62**

**1**



**2**

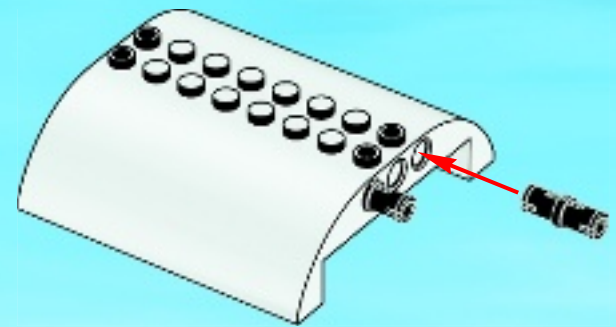

3

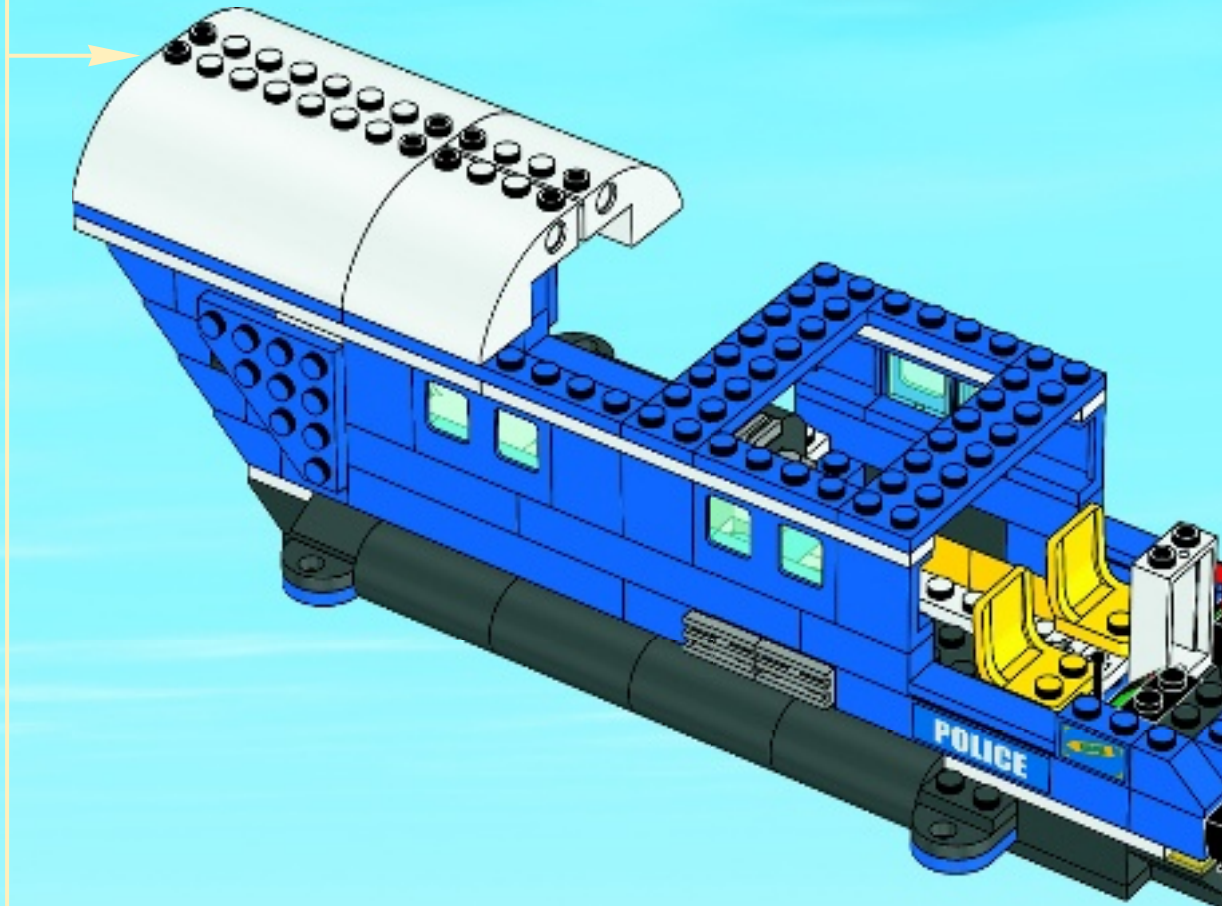
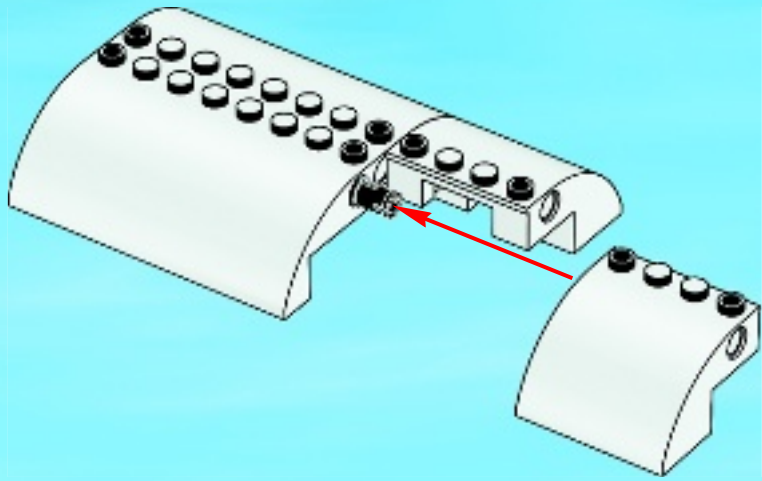

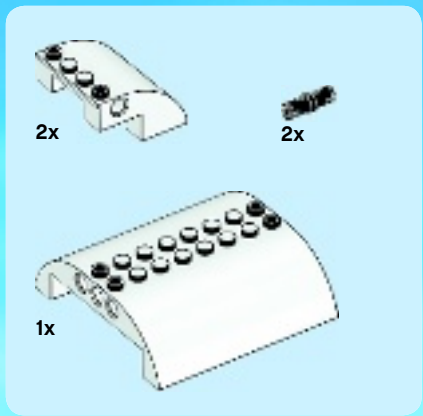

# 63

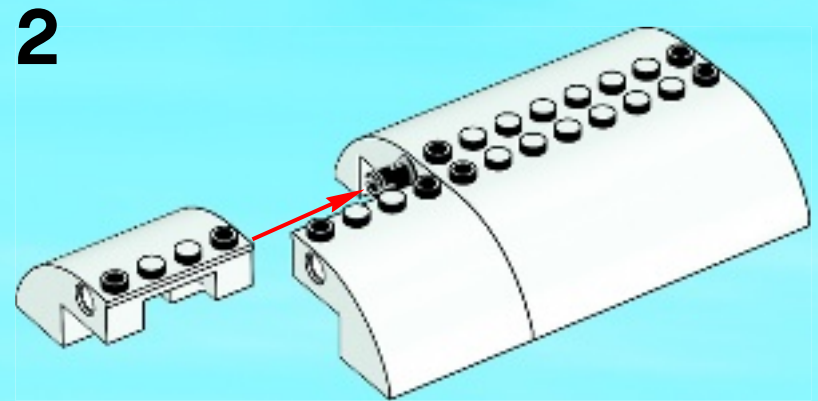
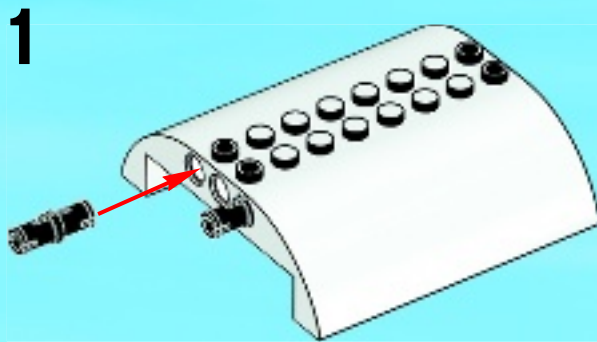



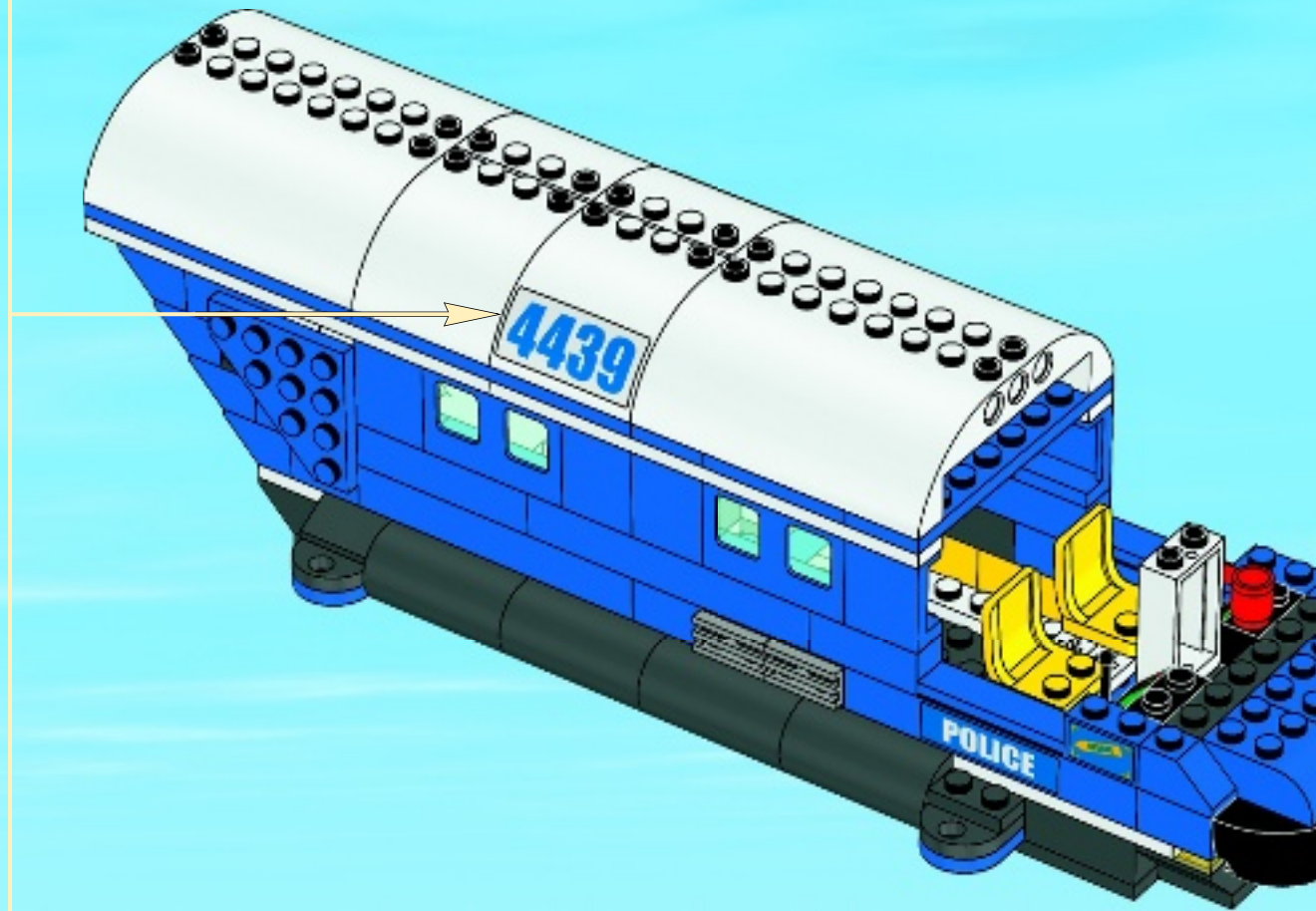
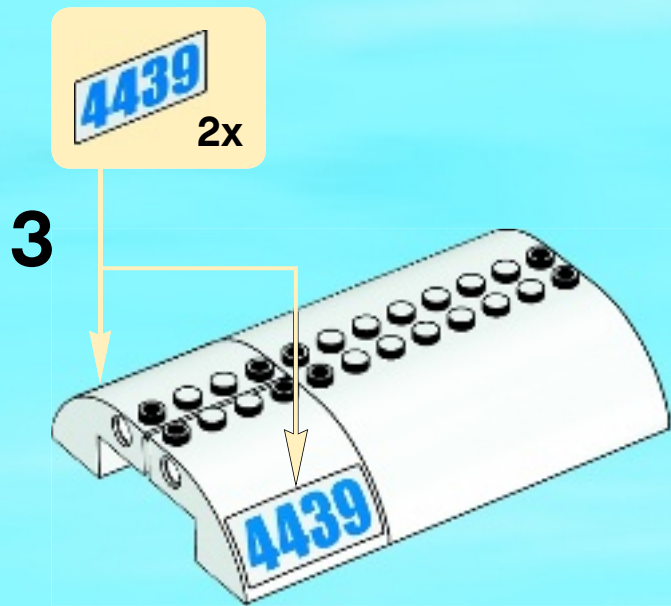



2x

# 64

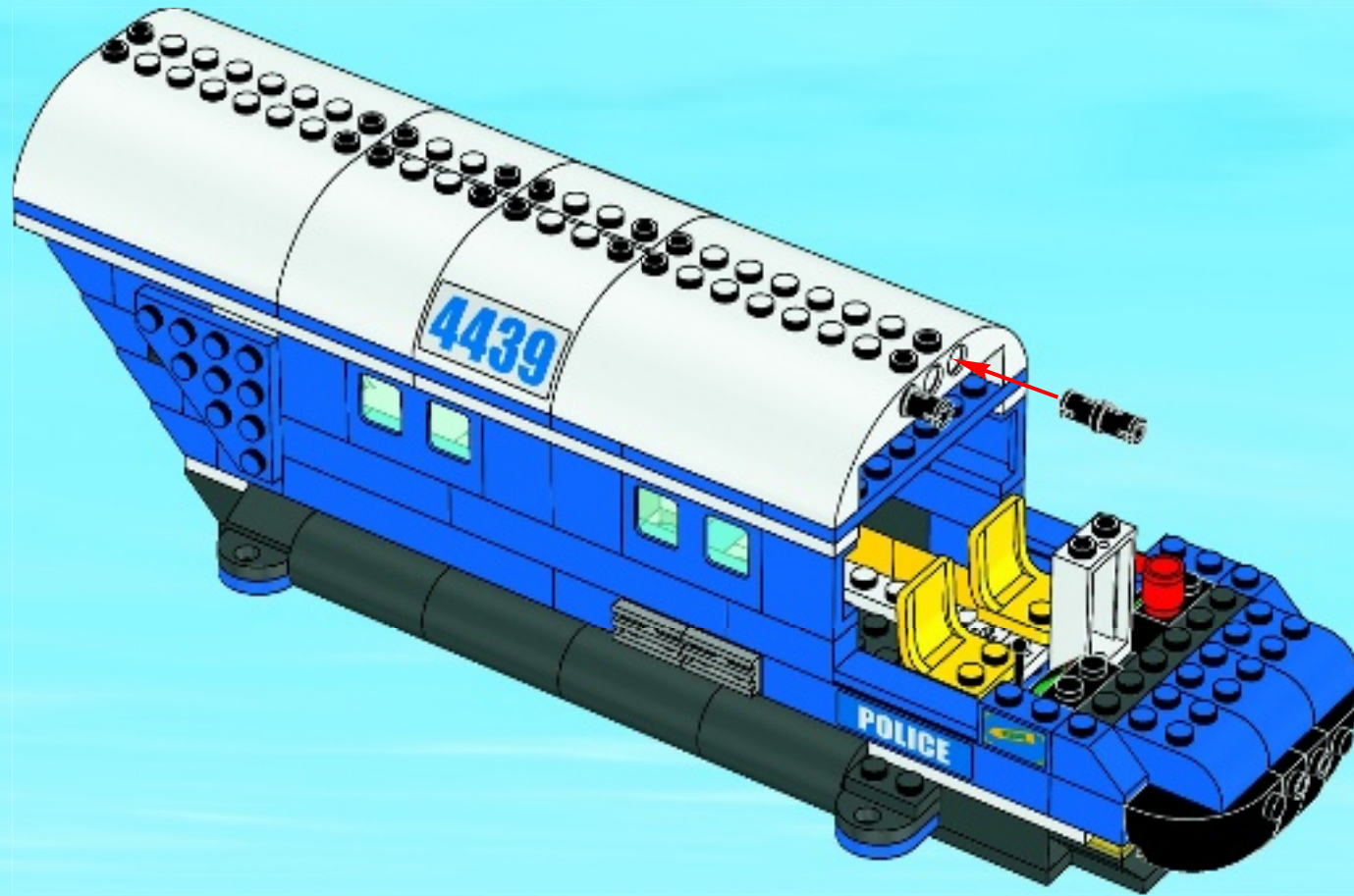





65

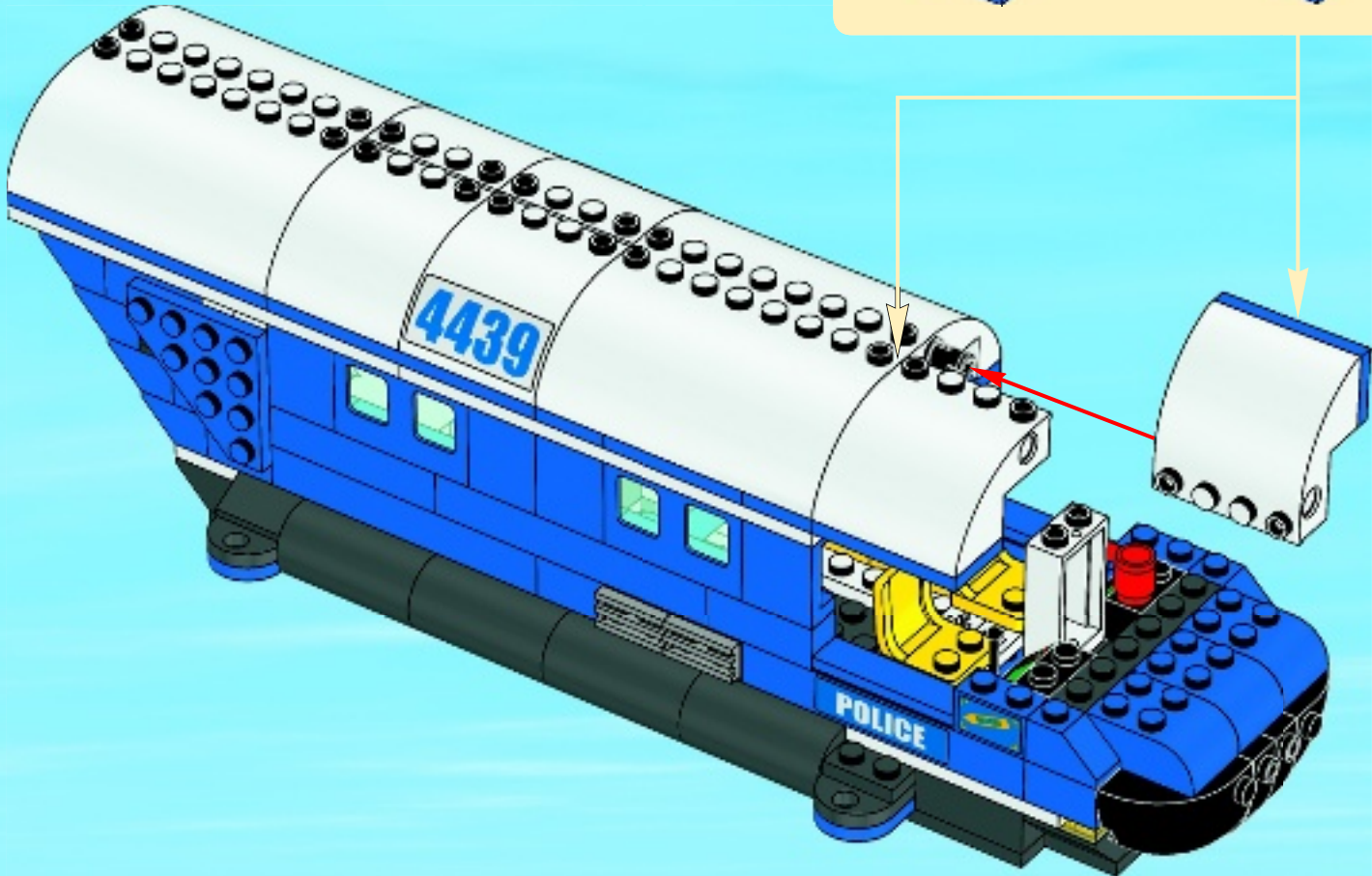
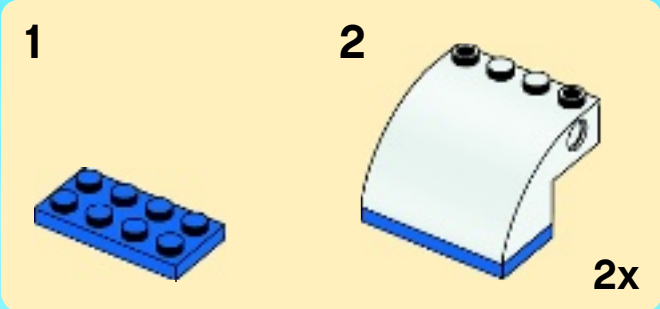

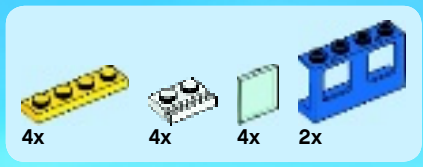

66

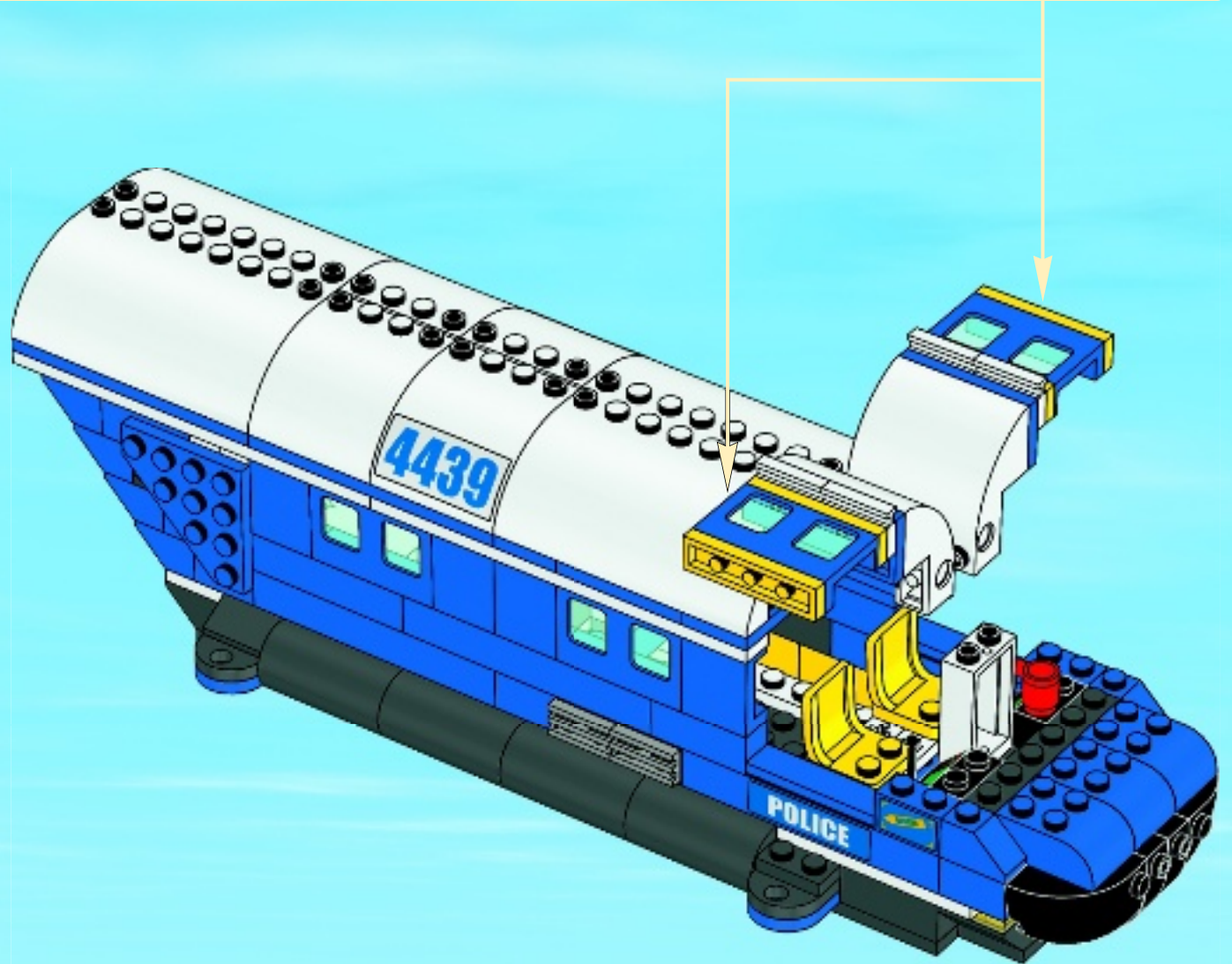
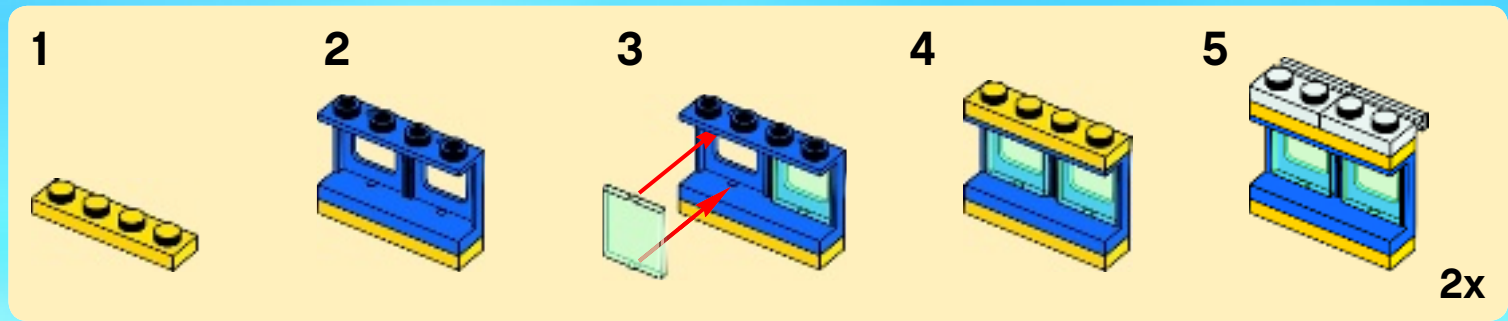



67

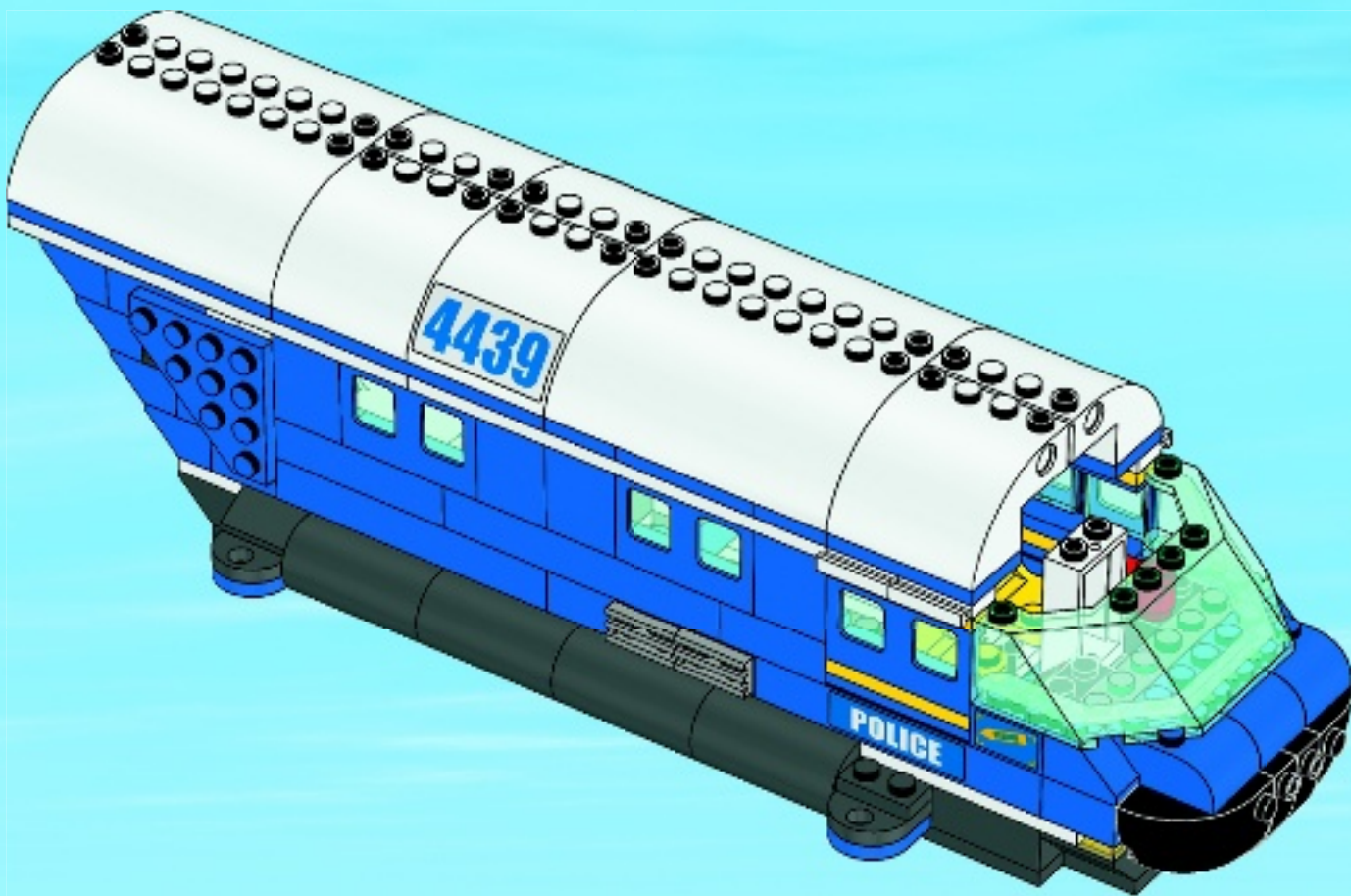





1x

68

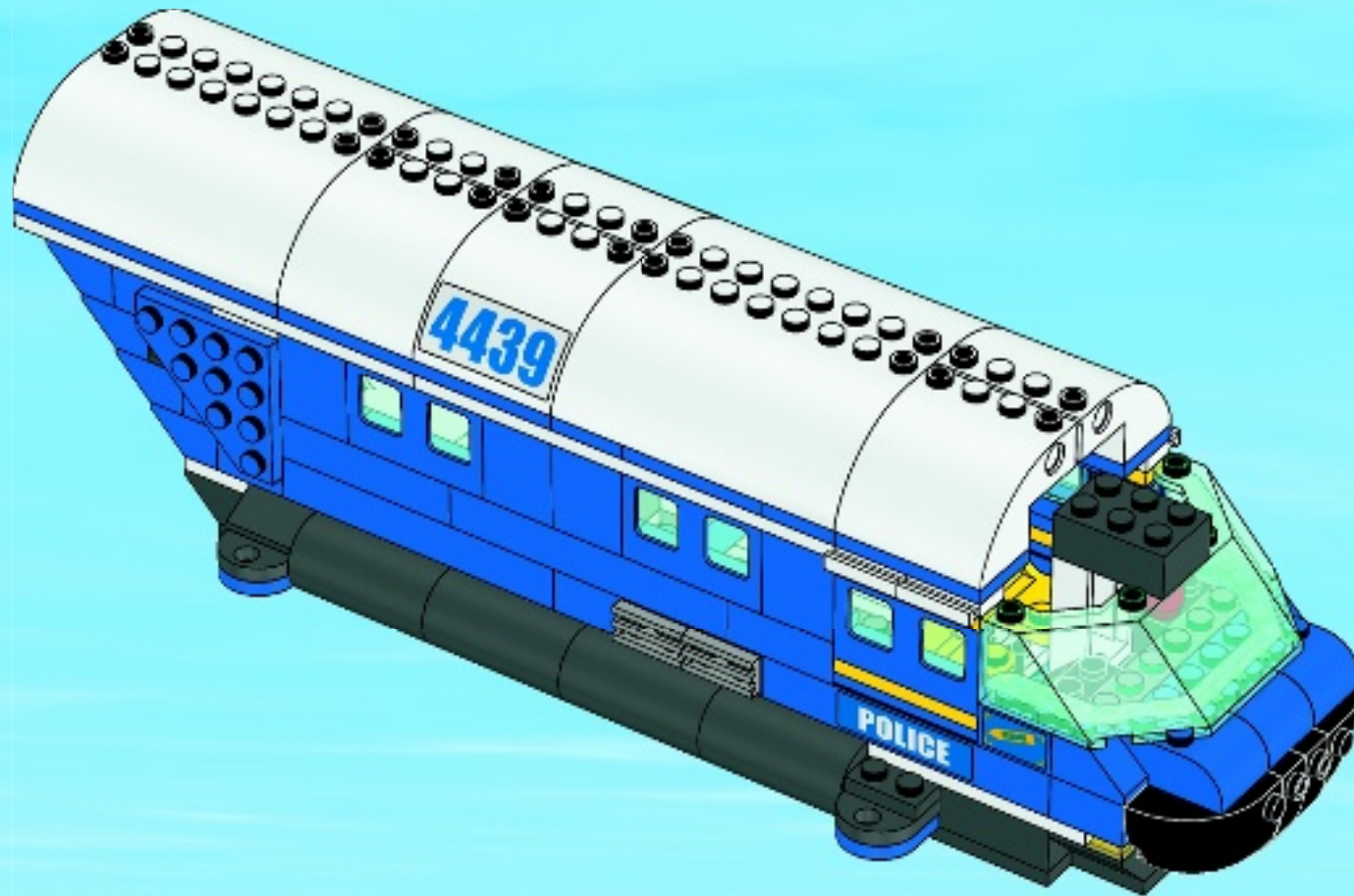



2x

69

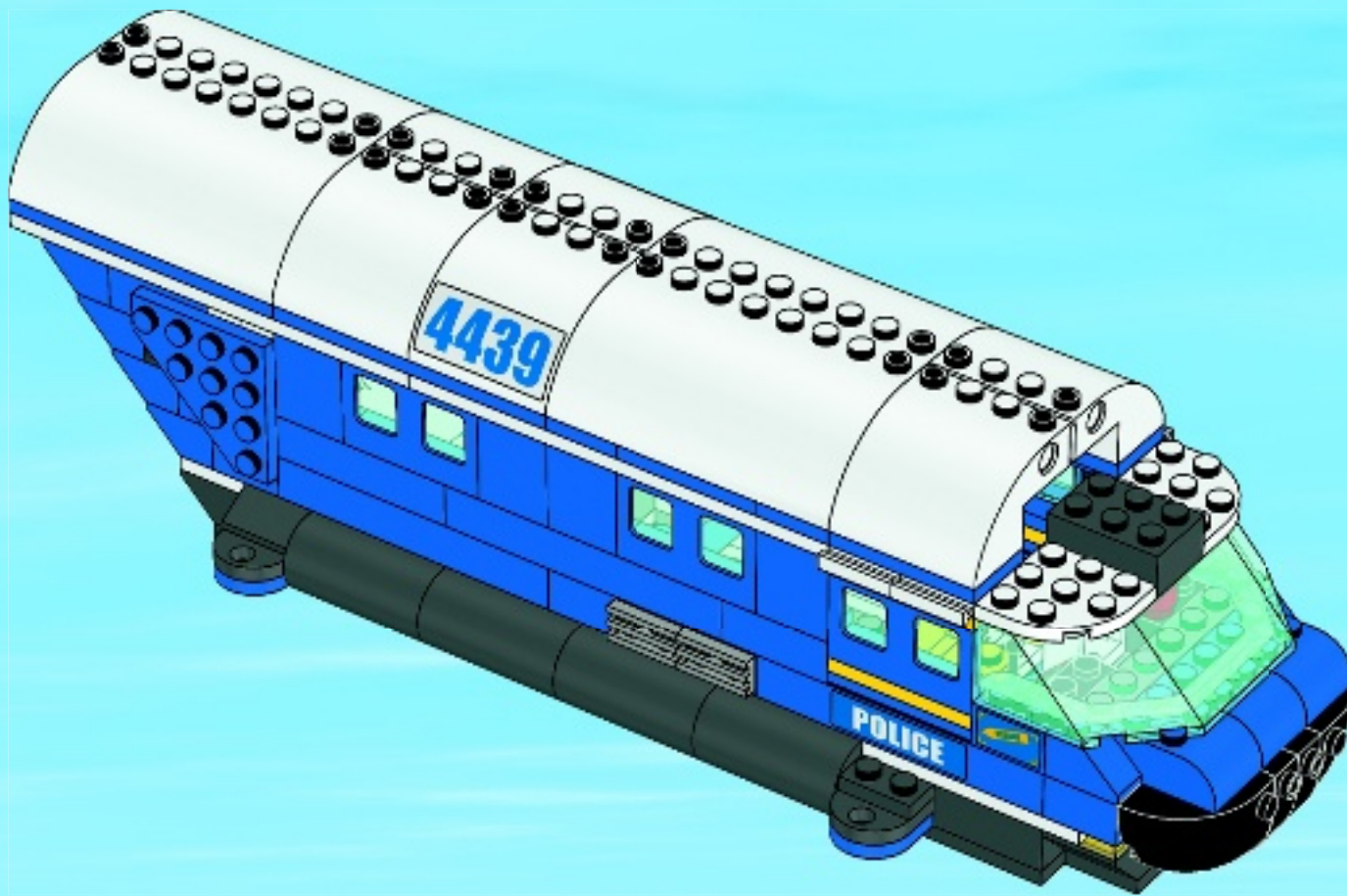

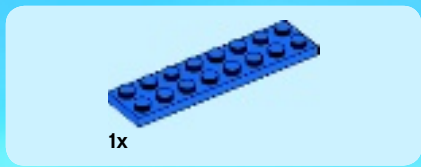

70

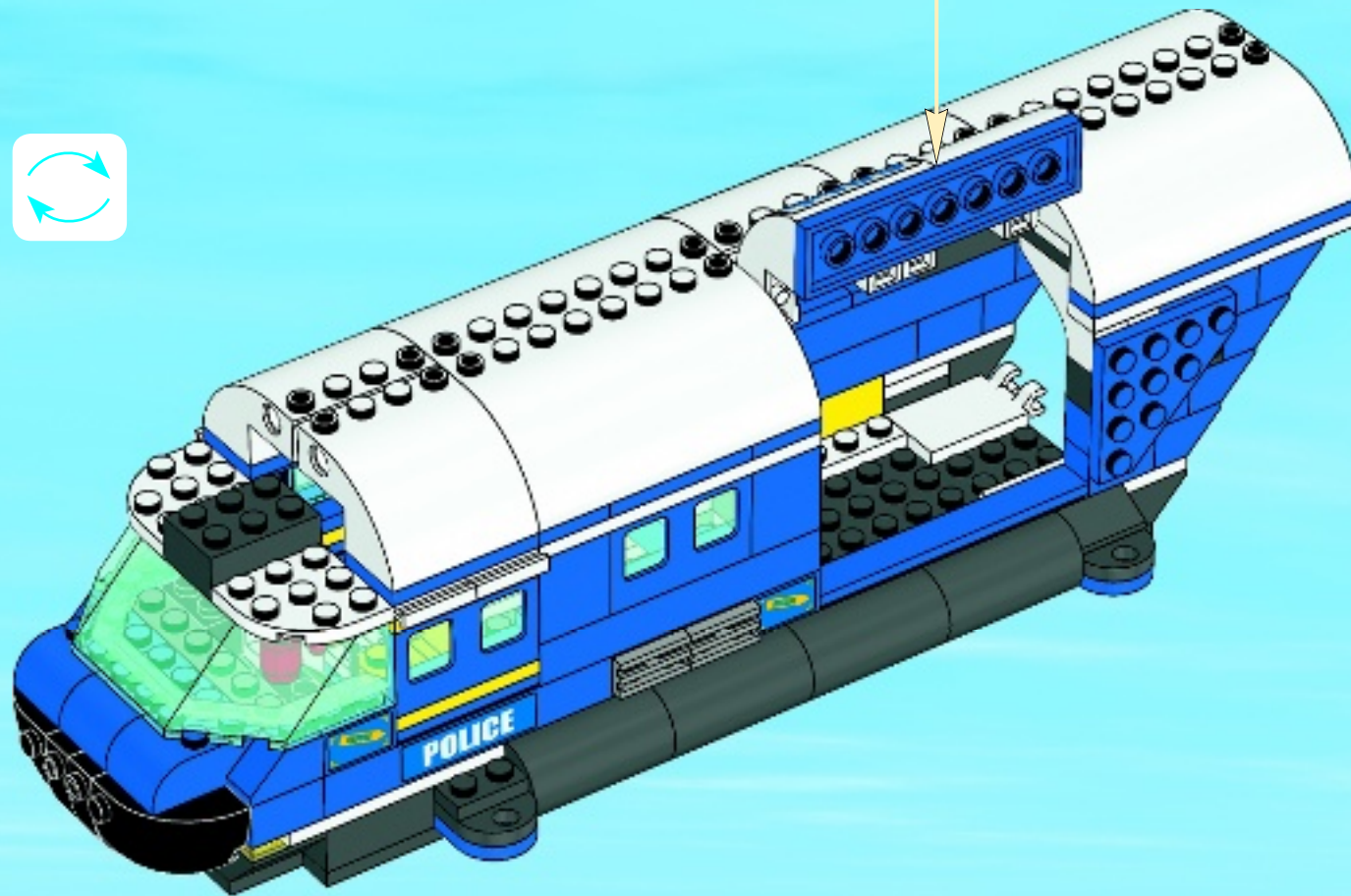
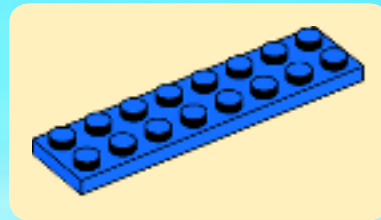



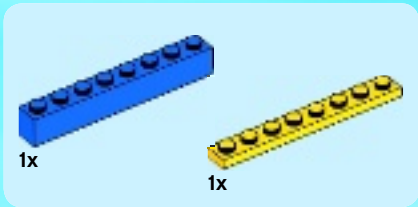

1

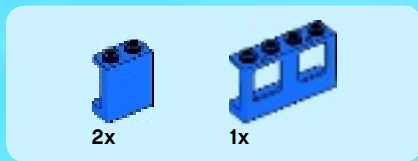
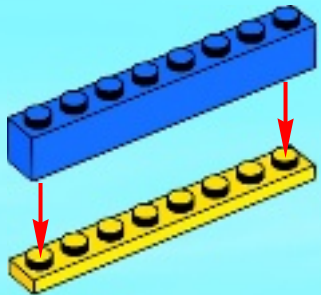

2

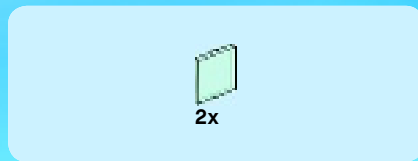
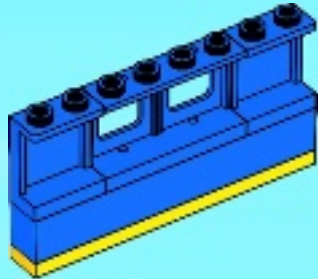

3

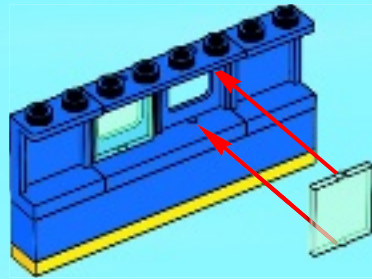

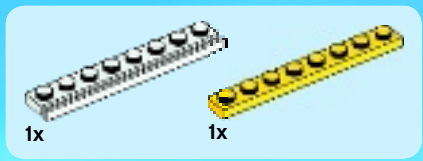

4

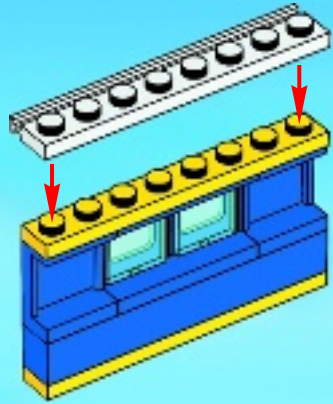

5

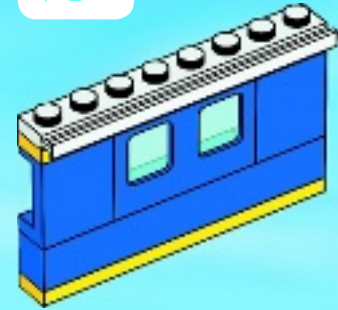

71

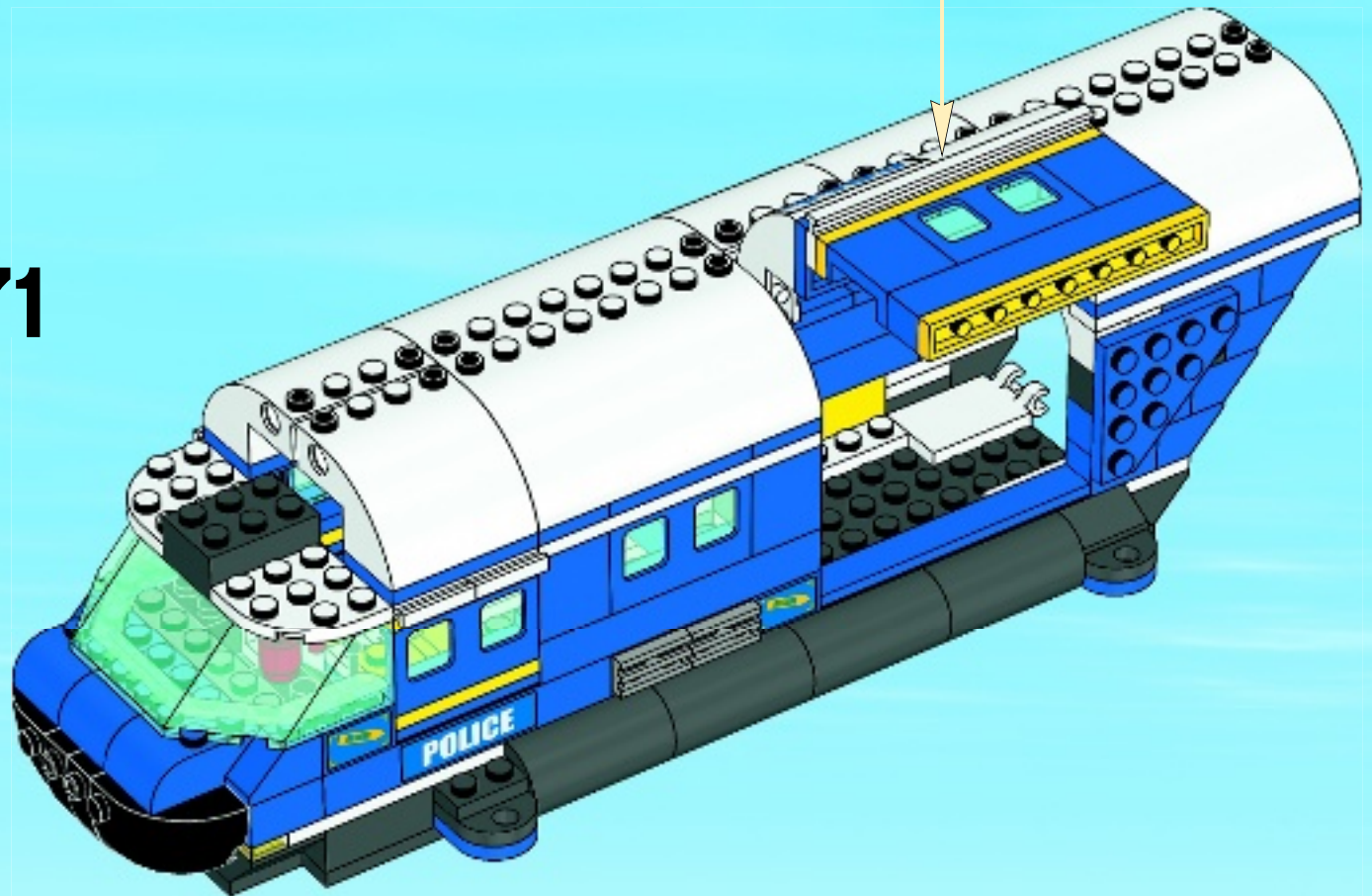



**1**

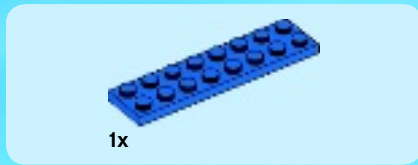

**2**



**3**





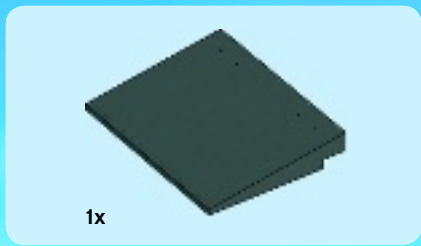

4



5

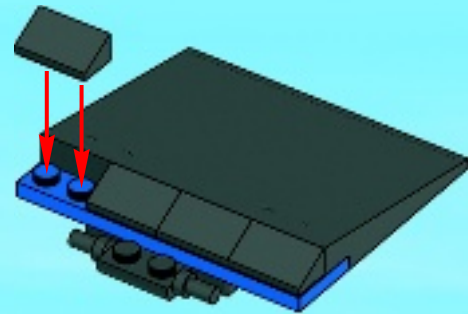



2x



1x

6



3x

7



72

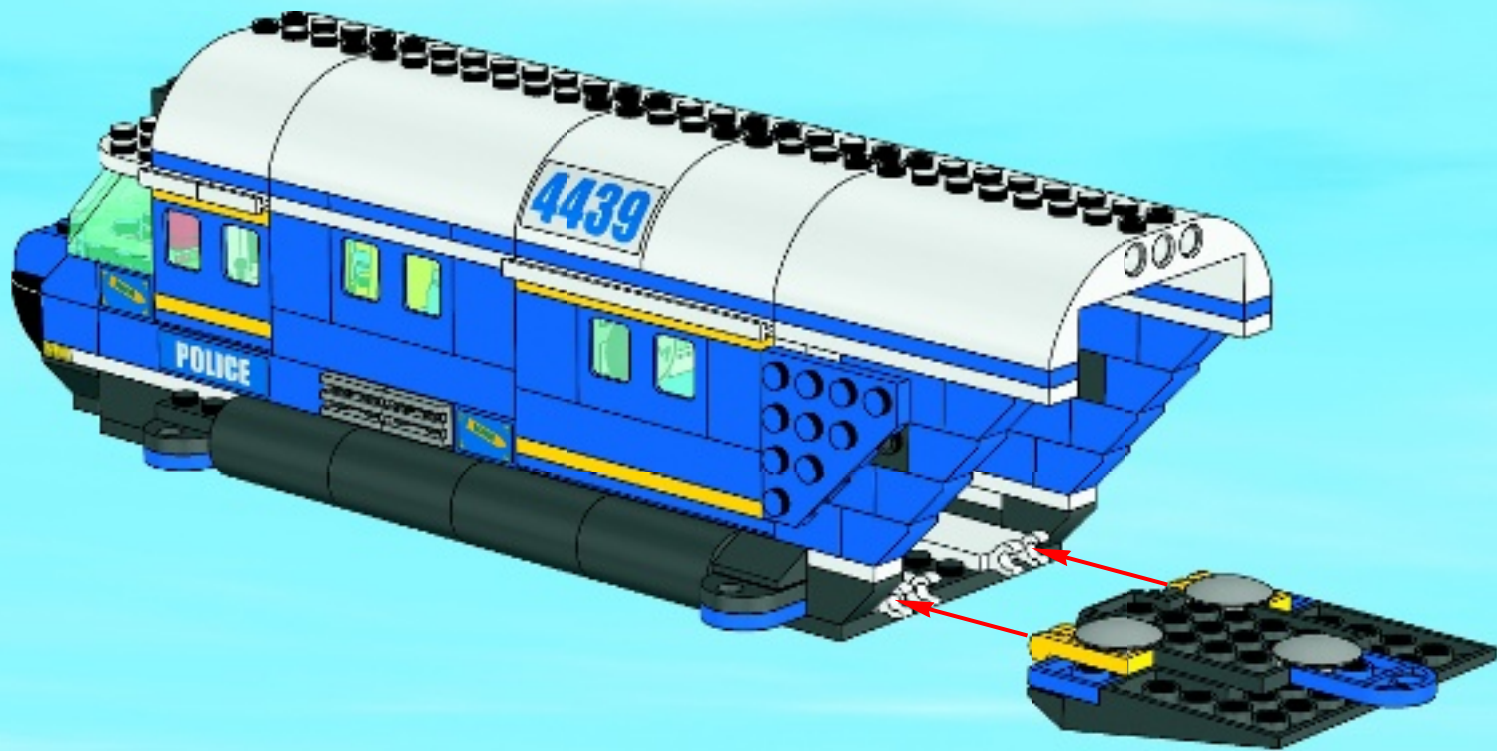



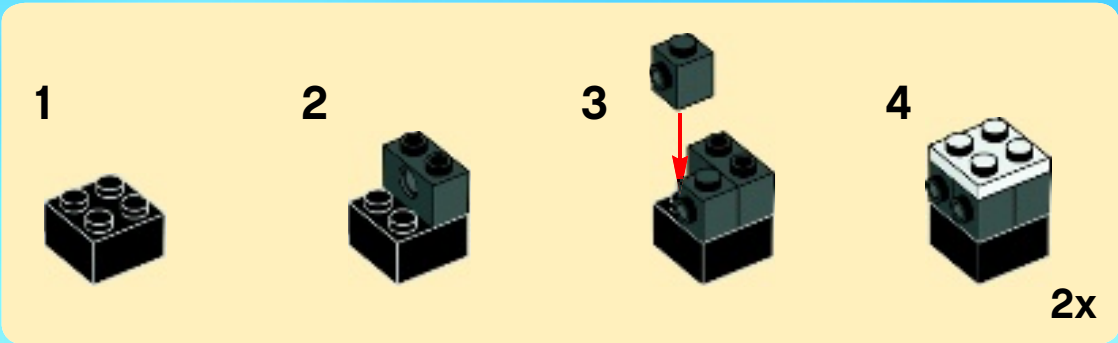

73

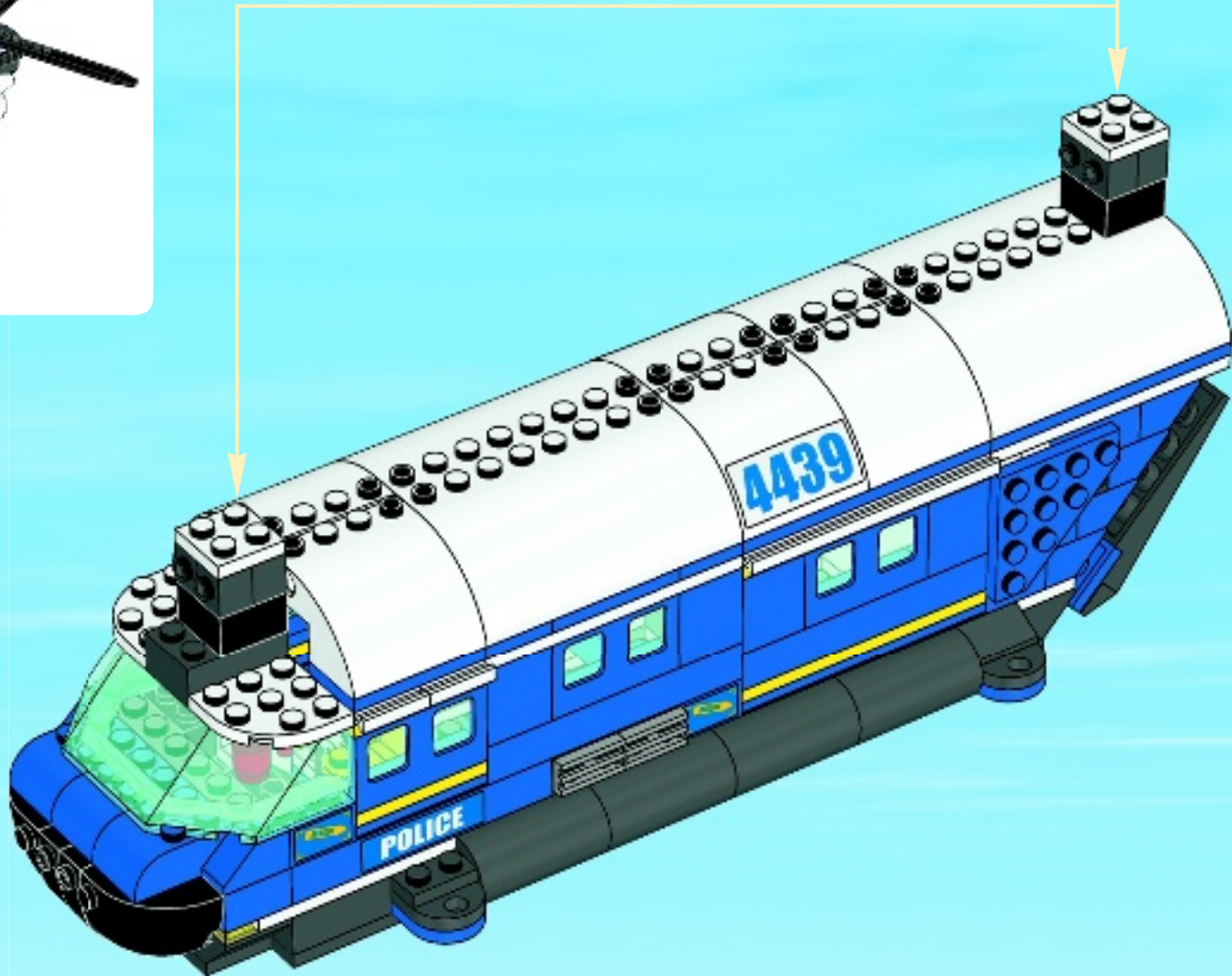



2x

74



2x

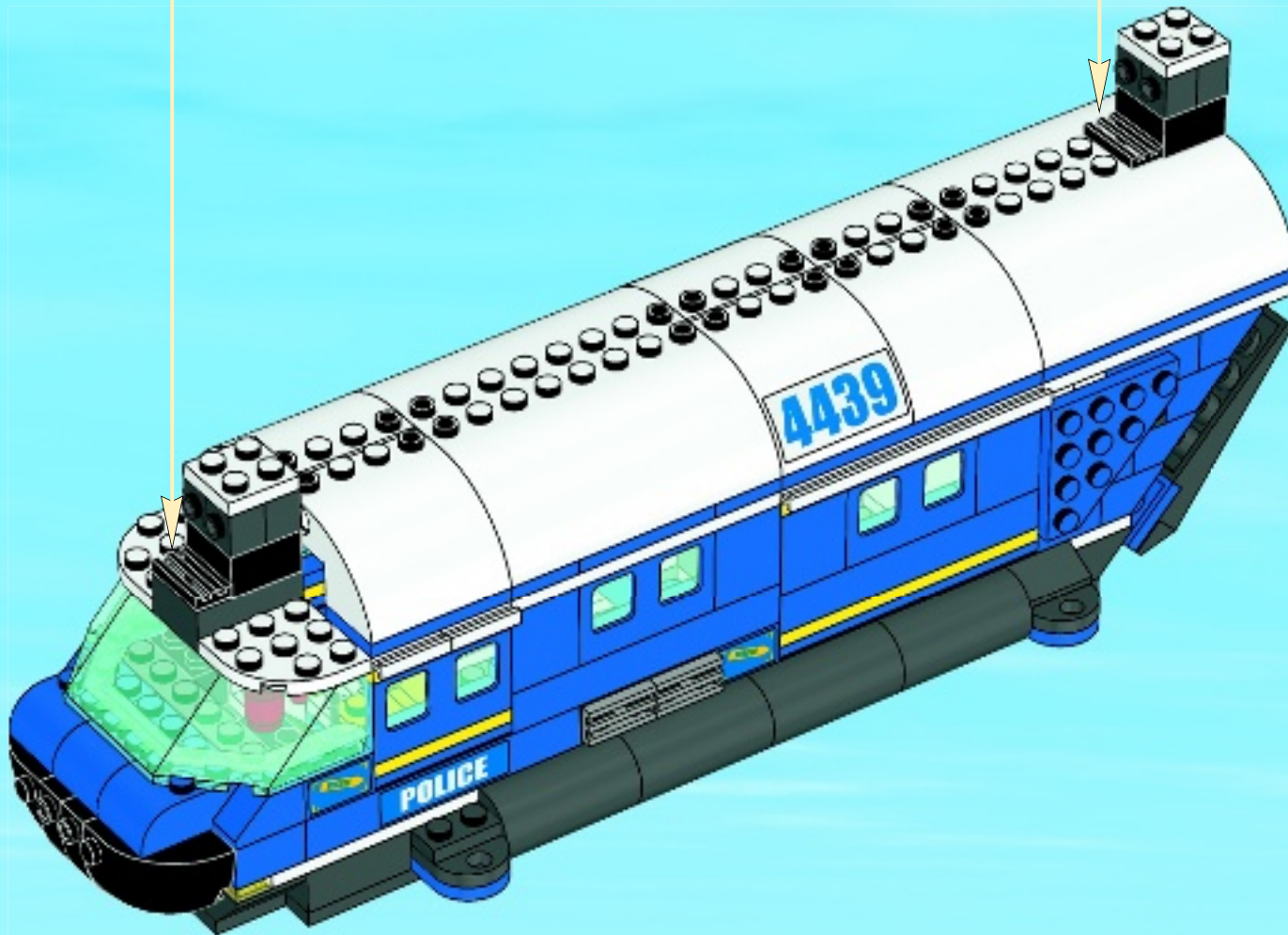

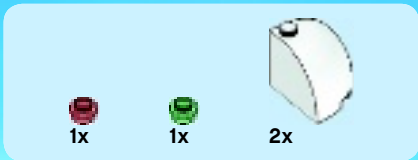

75

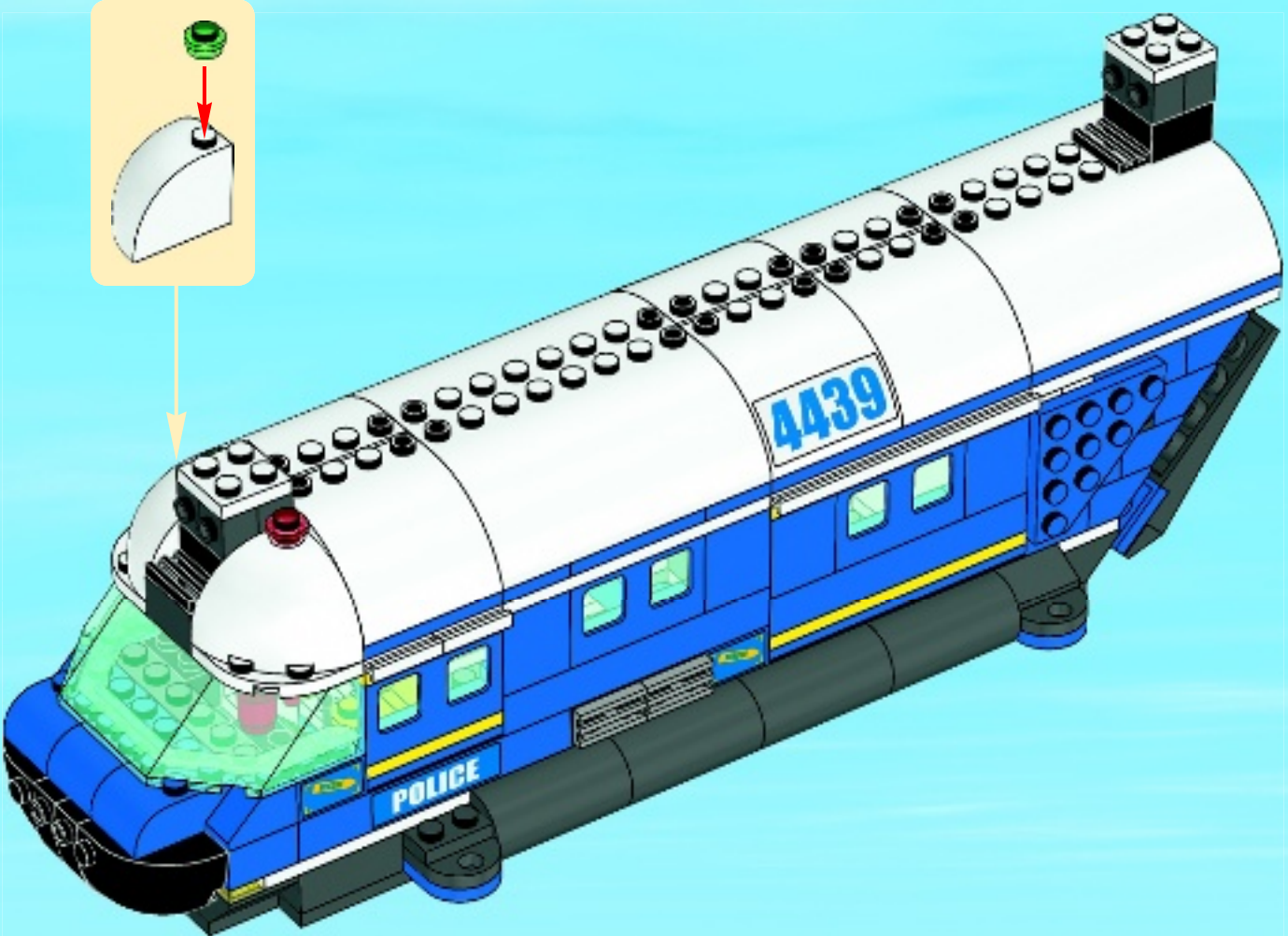





2x

1

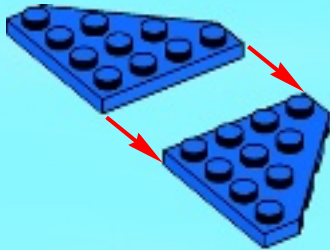

1x

2

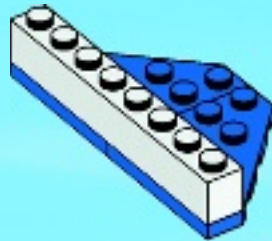

1x

3

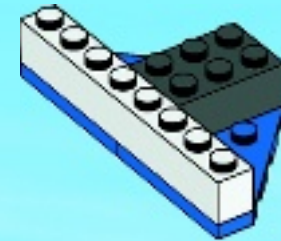



1x



1x

4

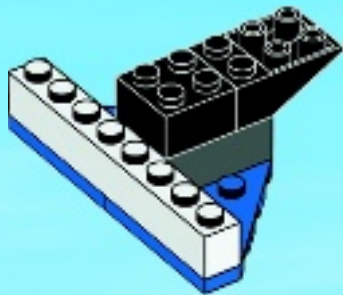

2x

5



2x



2x

6





1x

7

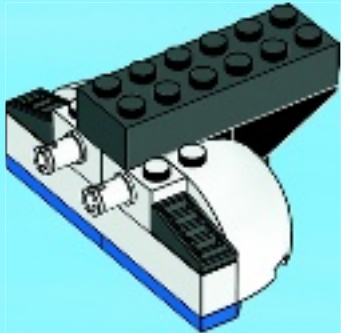

2x

8

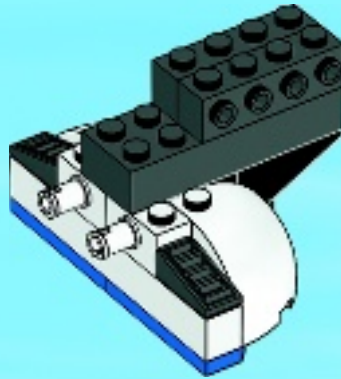

2x

9

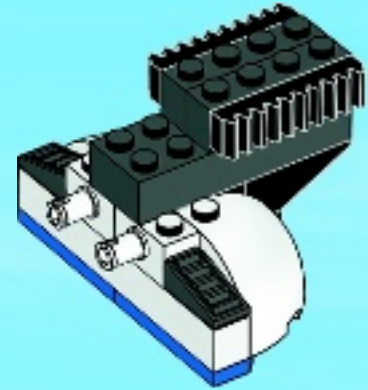





10

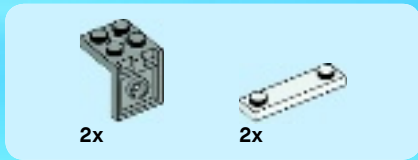

11





# 12

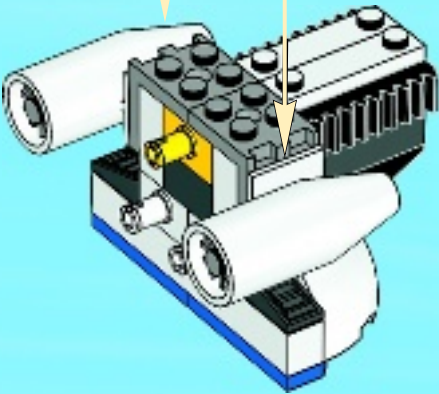
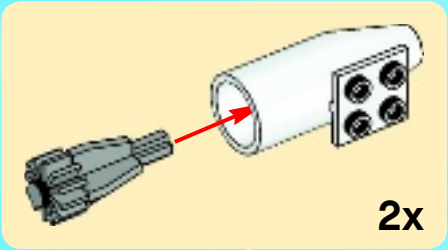

# 13

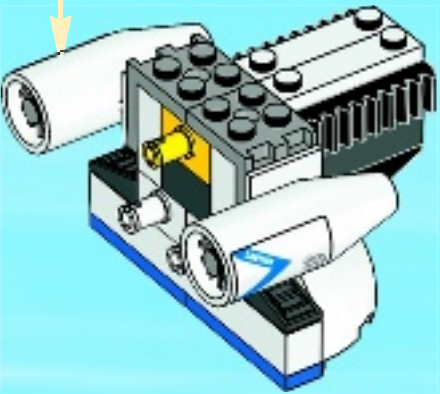
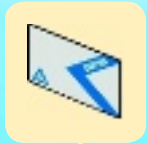

76

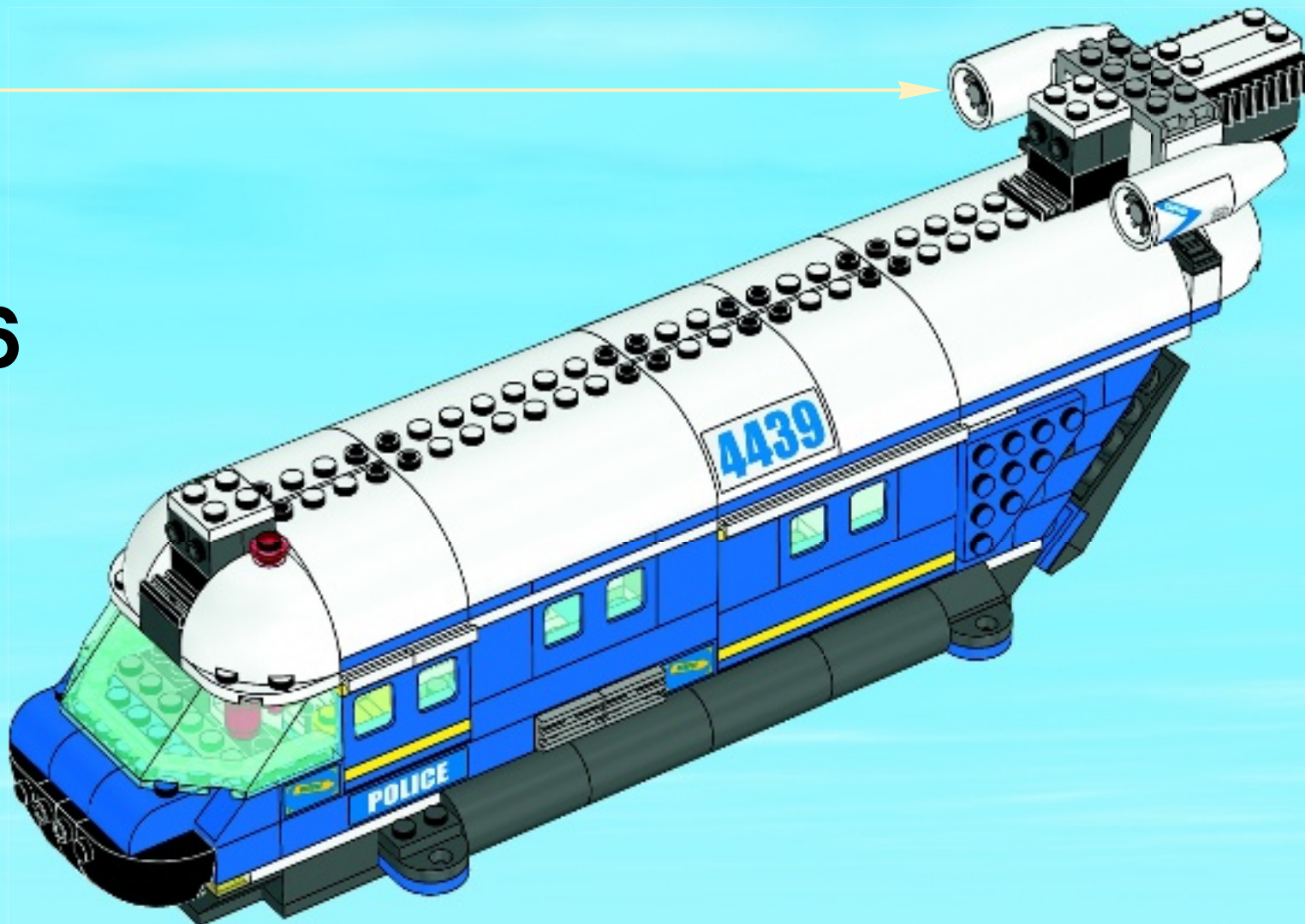





77



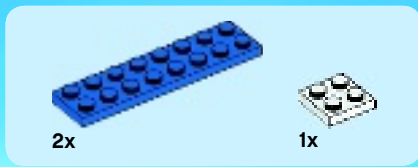

78

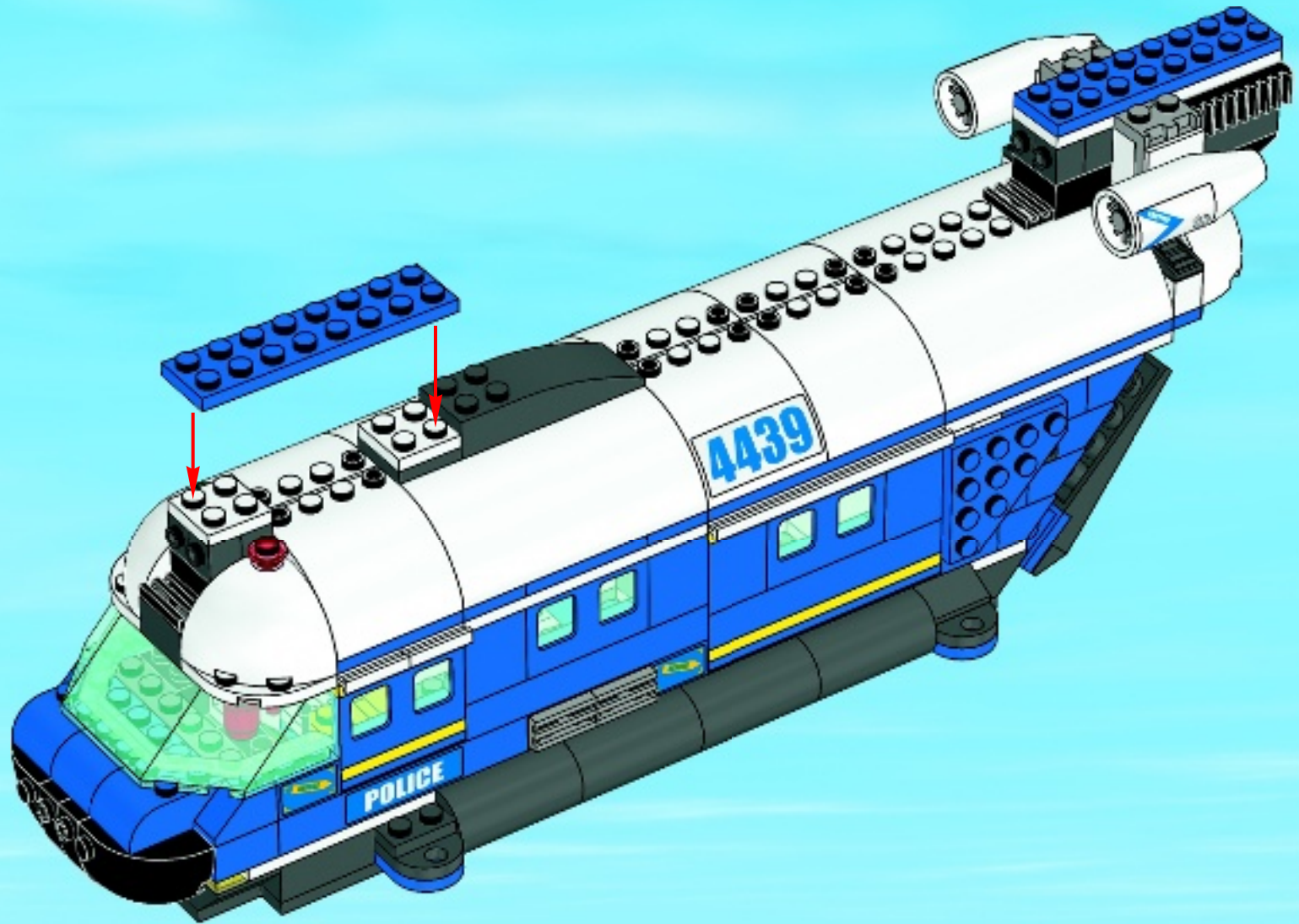



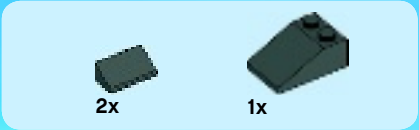

79

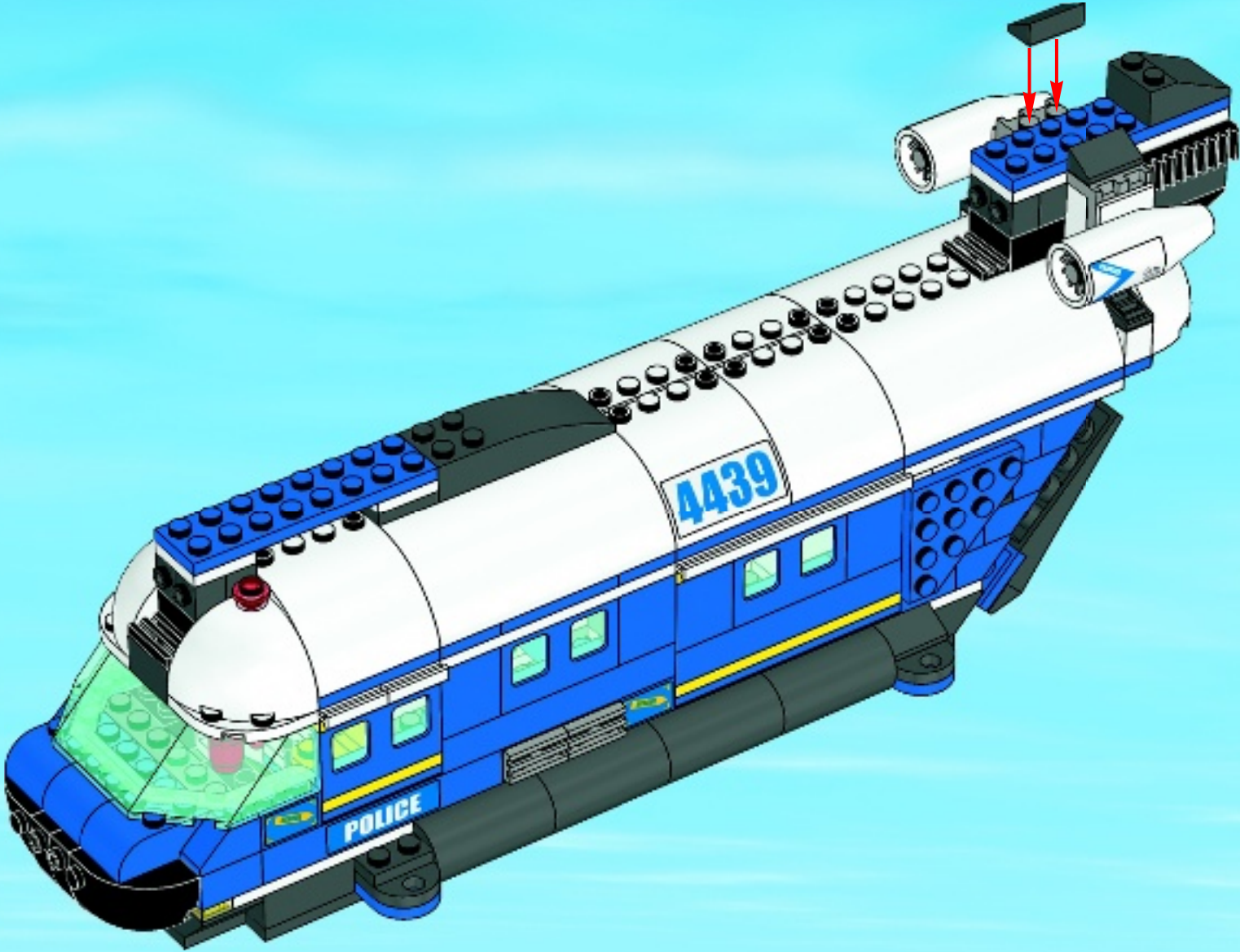





2x



1x

80

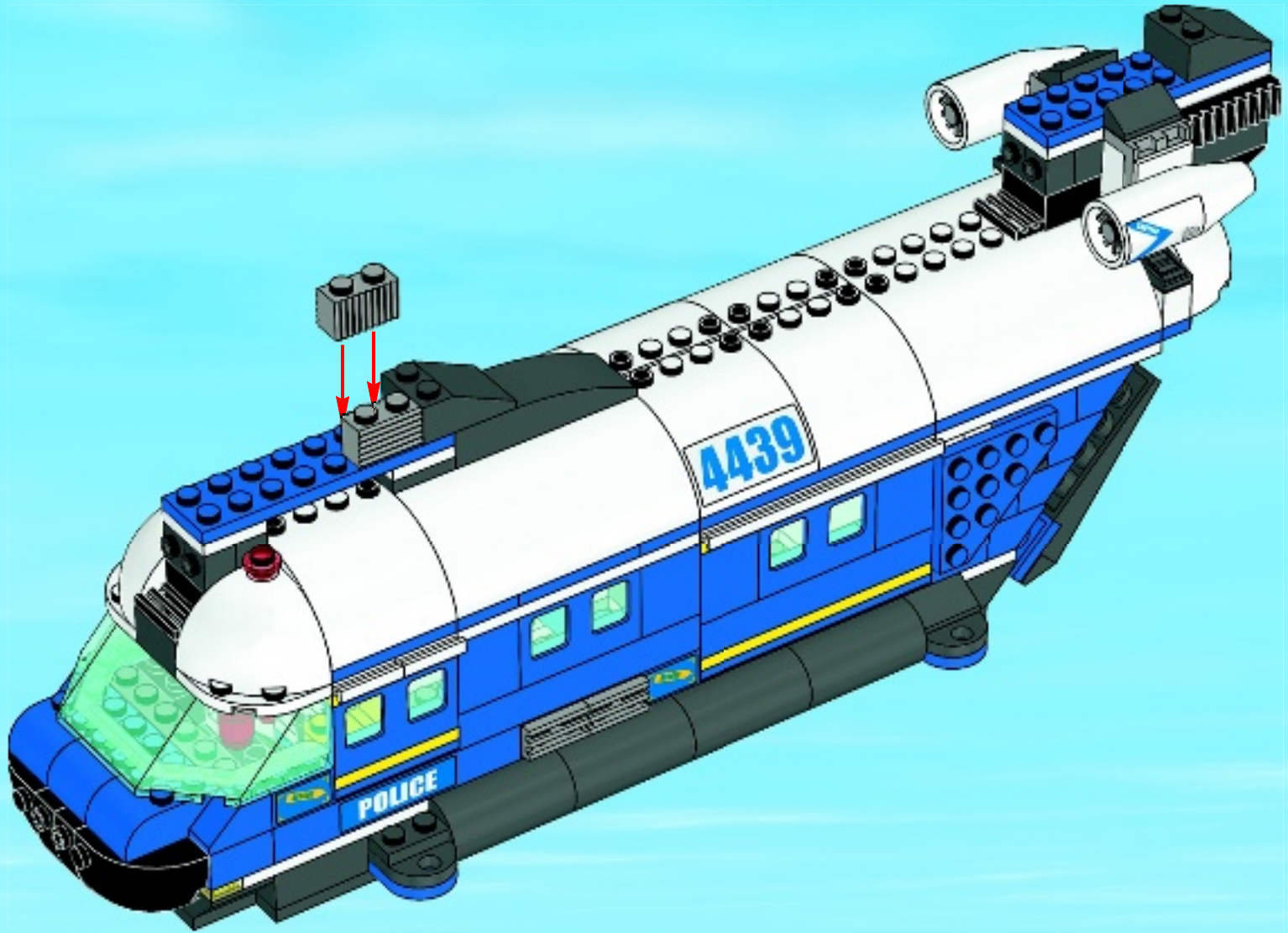

4x

4x

2x

# 81

1



2



3



2x

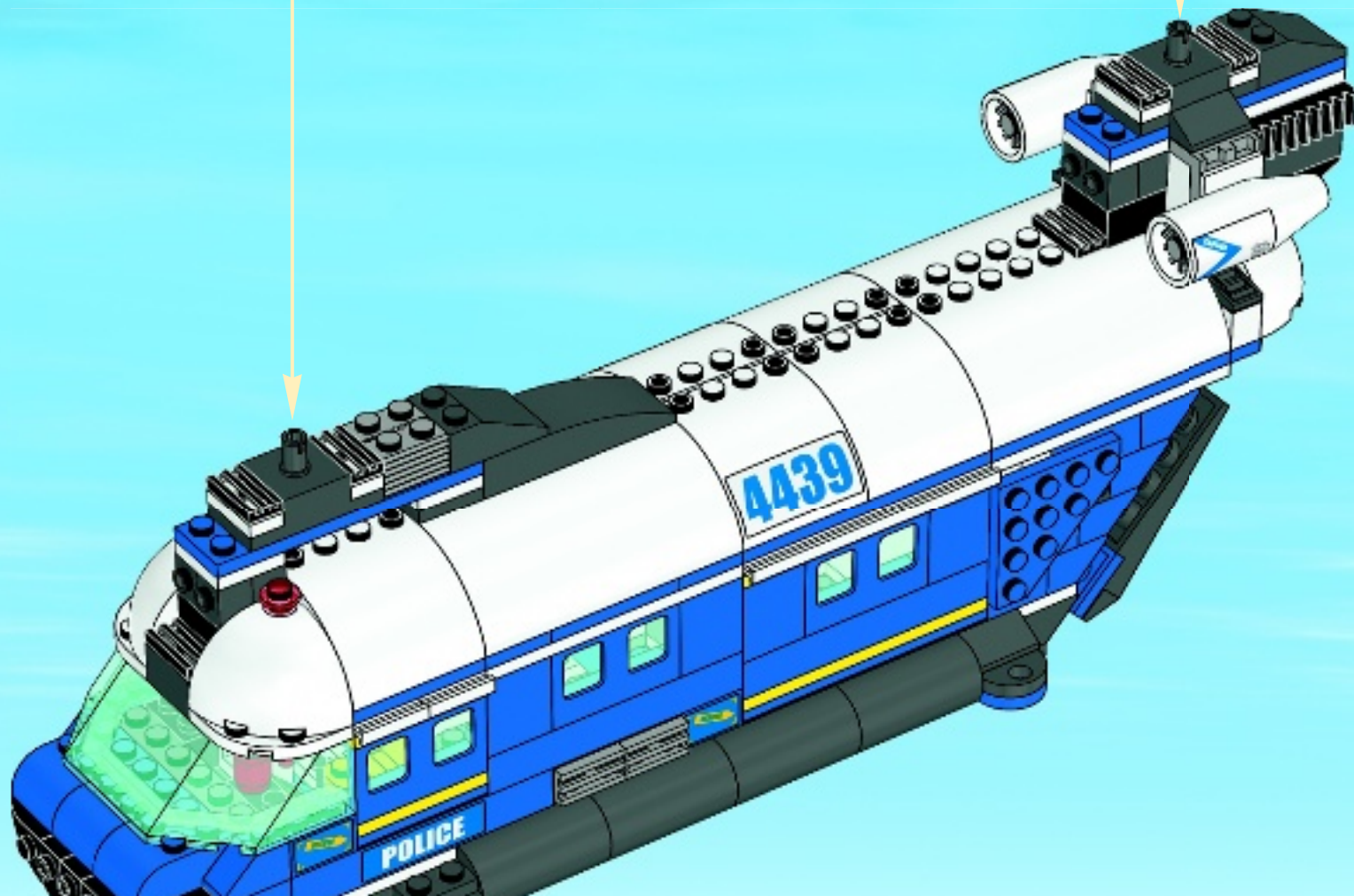





4x

# 82



4x







2x

# 83

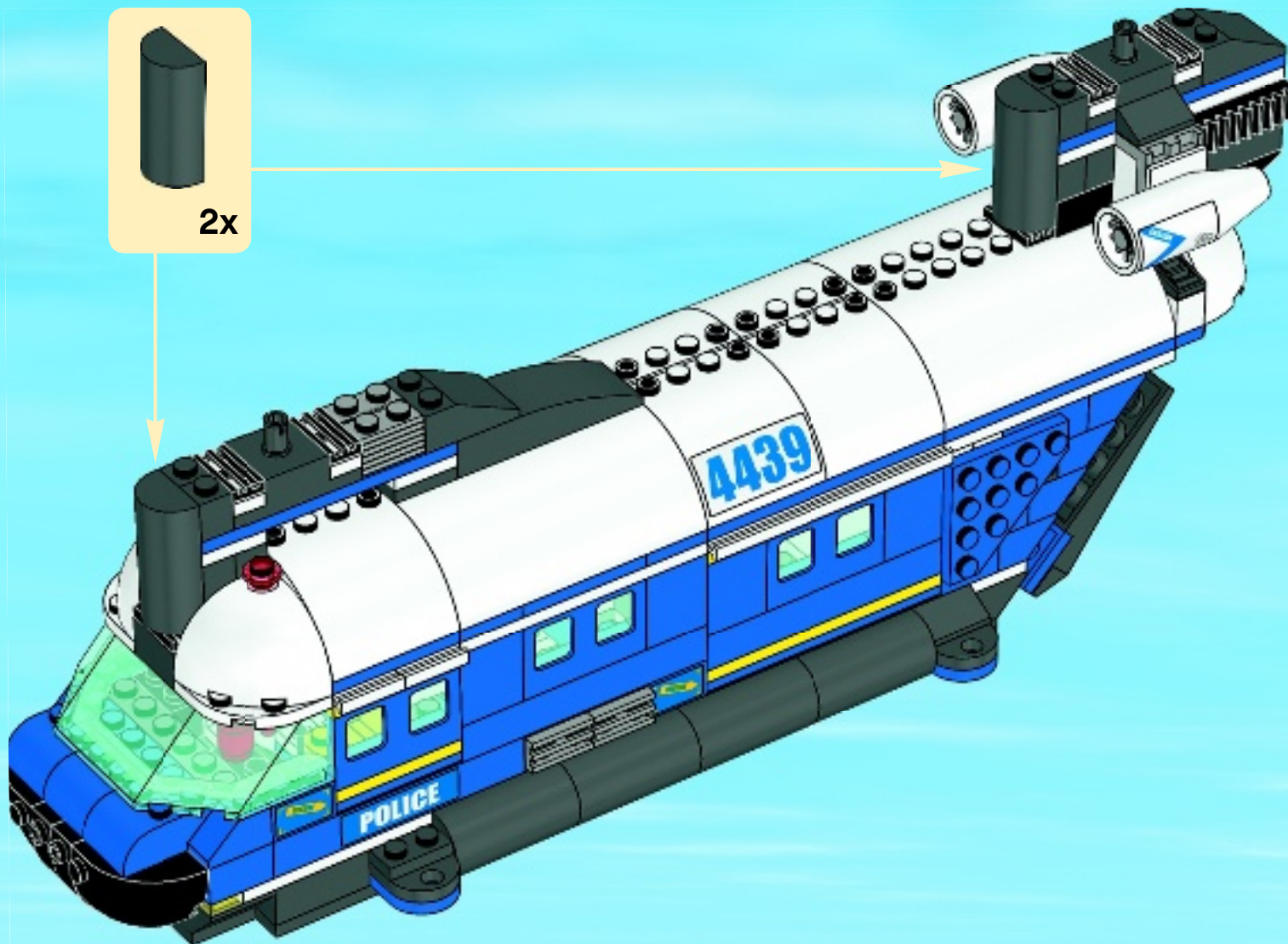



8x







8x



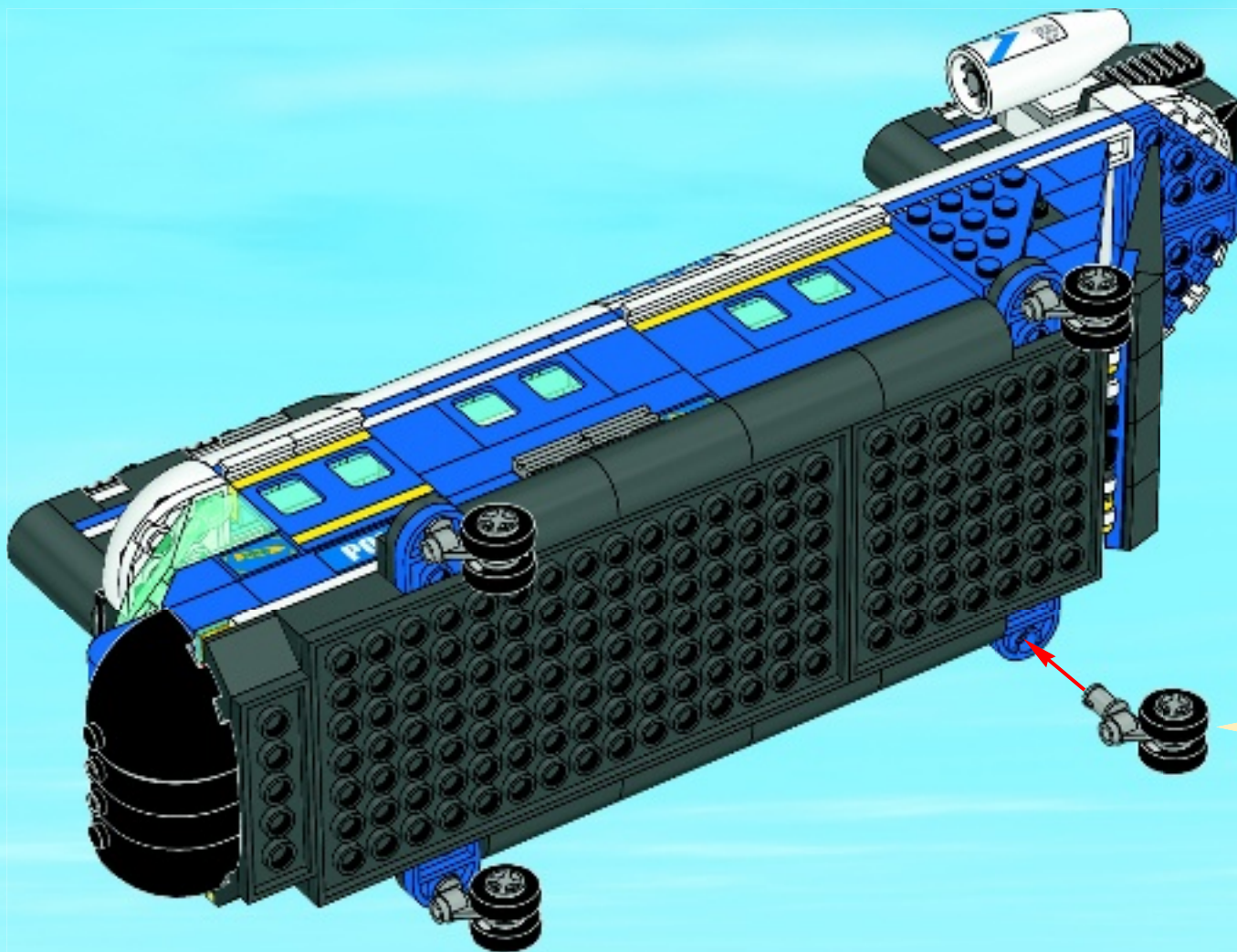



4x

# 84



1   

2 

3   

4x



1



2

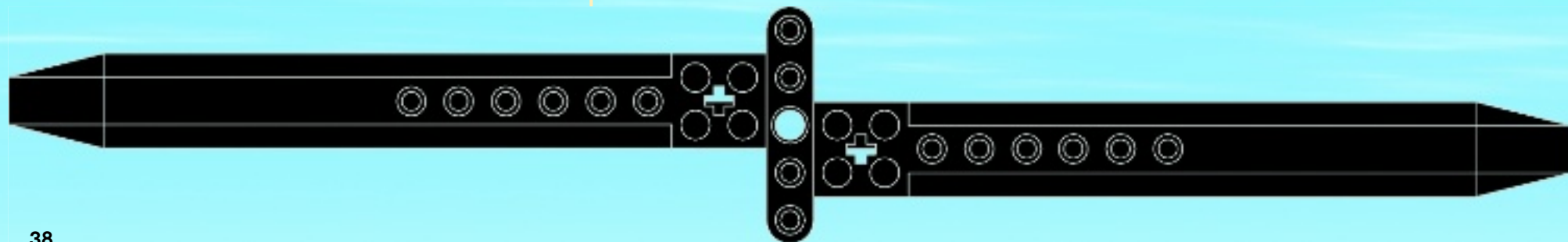
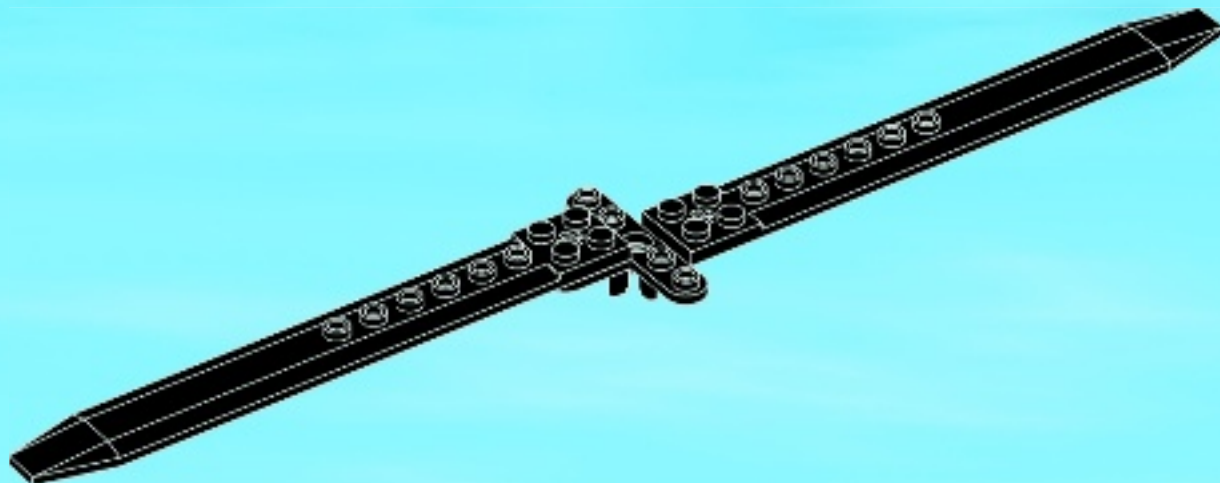





1x

3

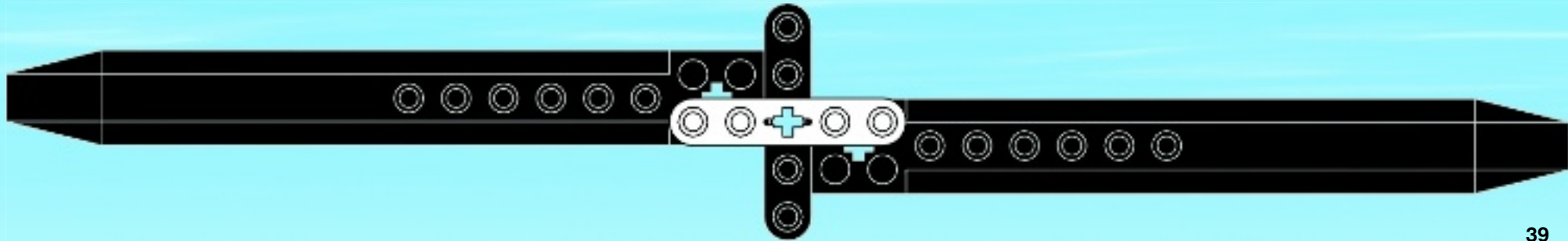
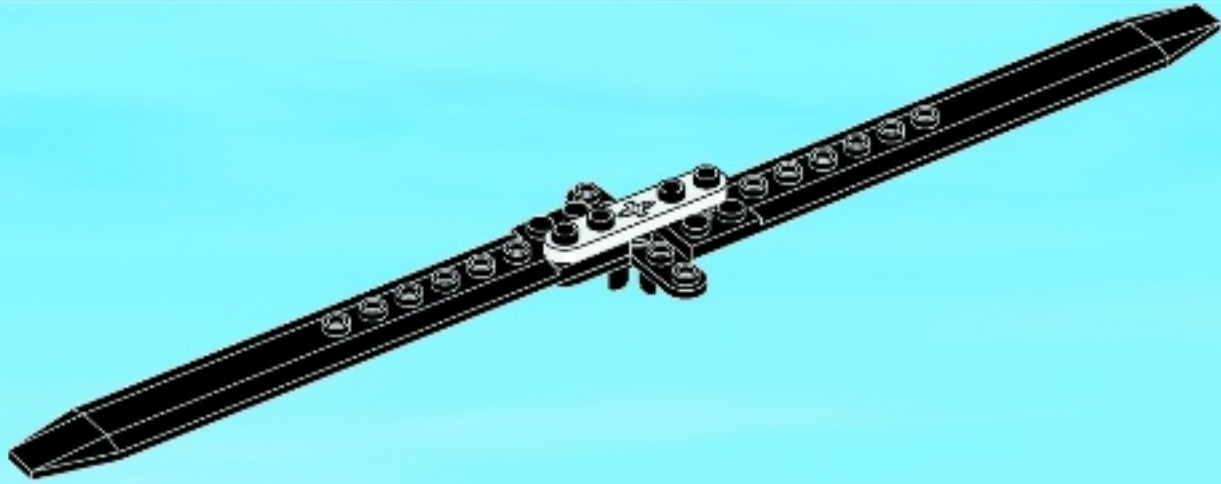



4

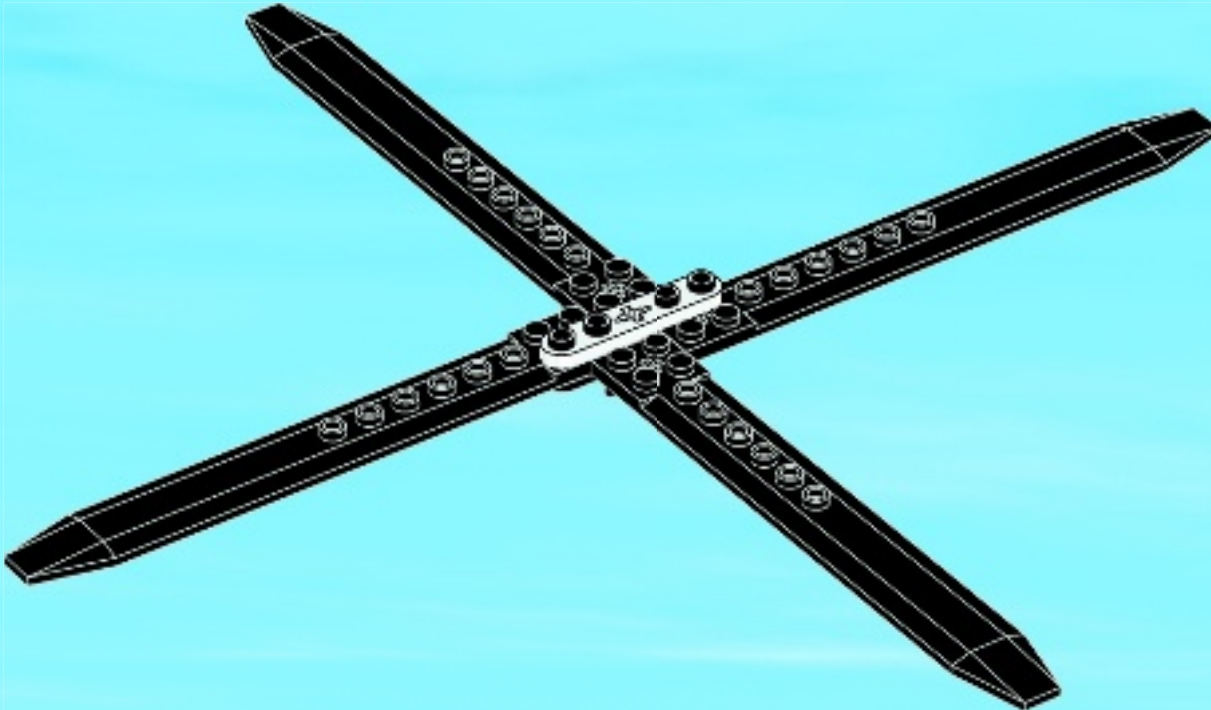



2x

5

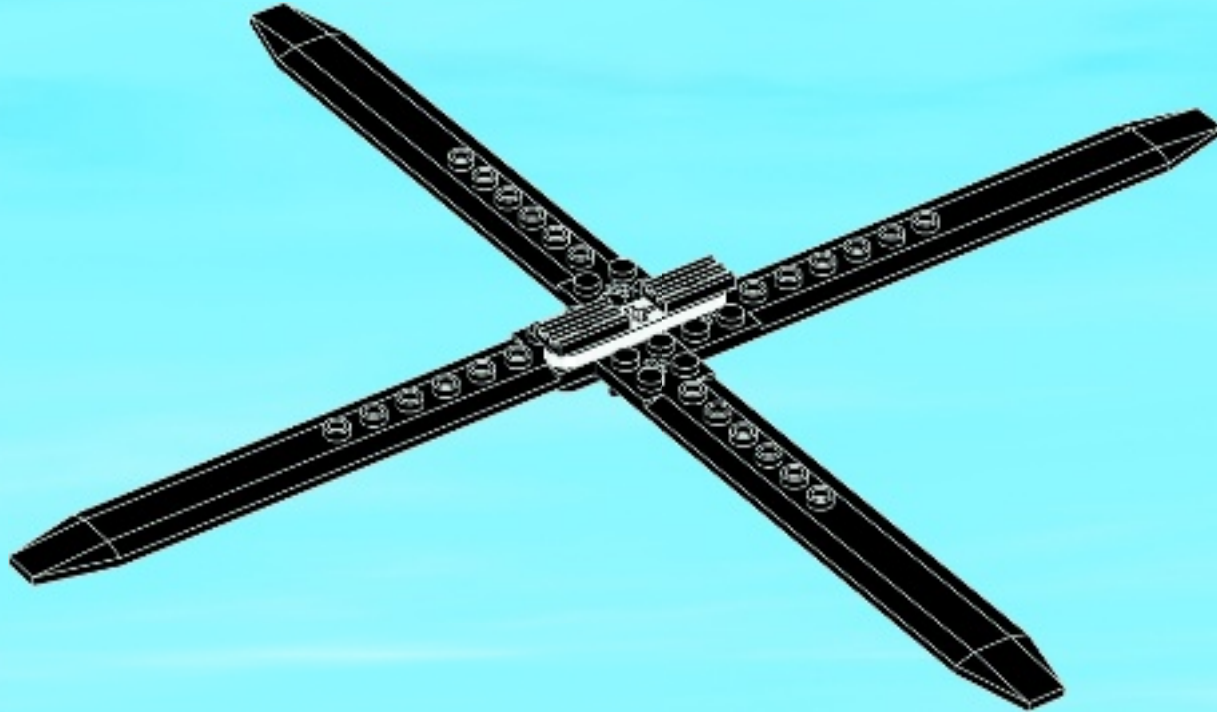





2x

6

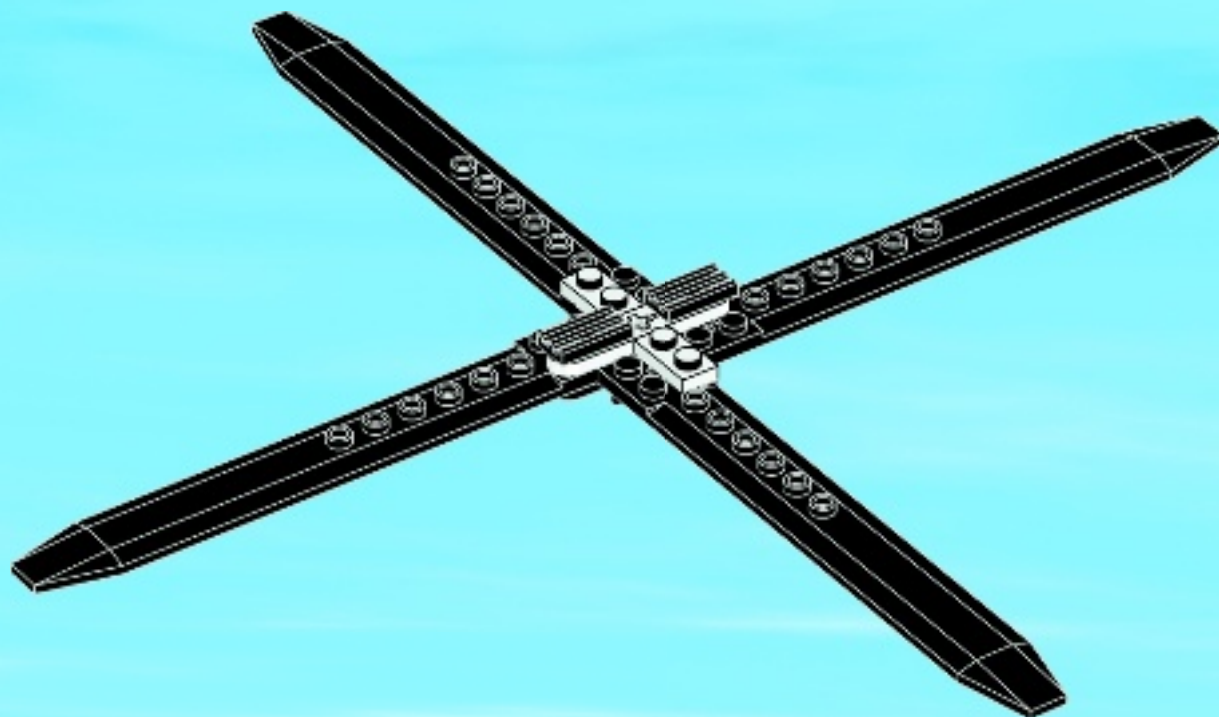



7

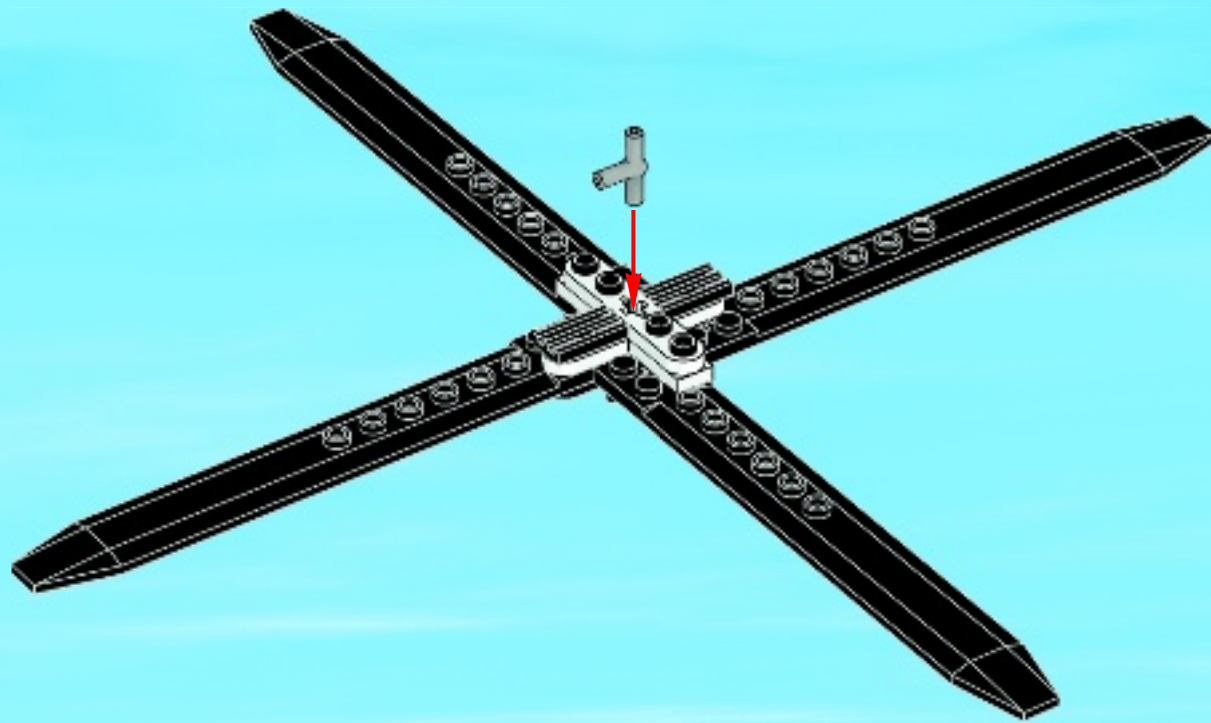



1x

8

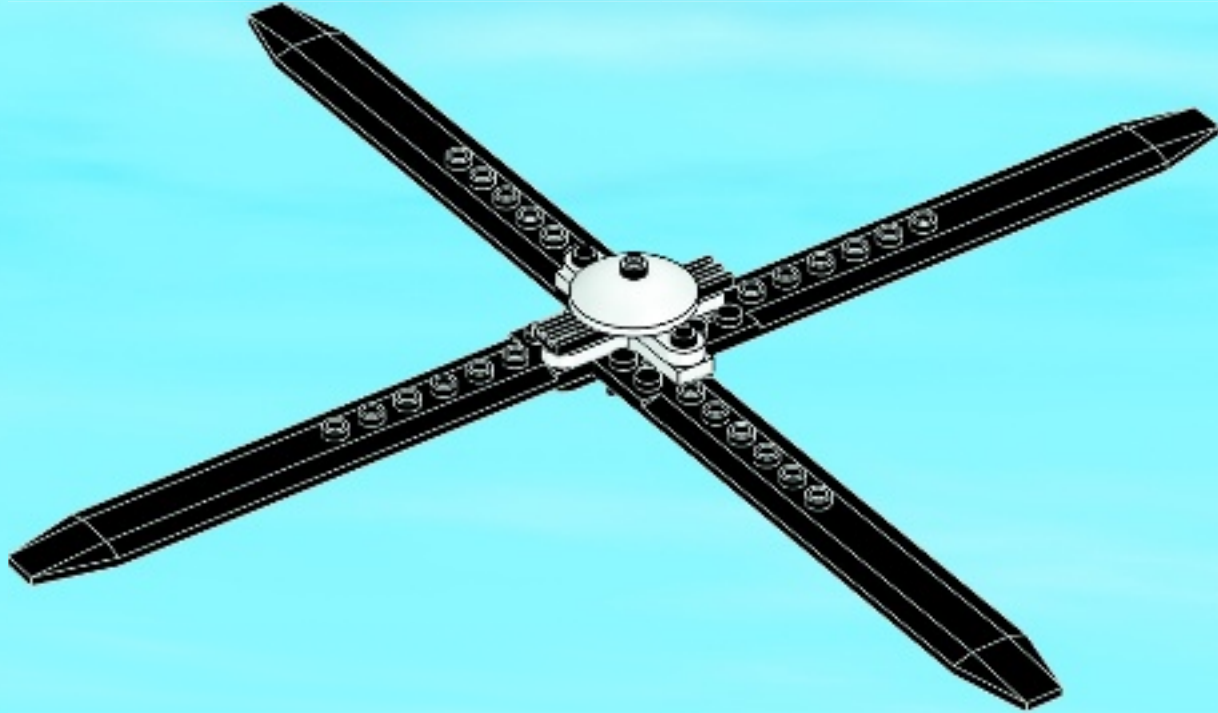

2x



85



86





87







# CITY



4440



4439



4441



4437



4436





# CITY



[videogames.LEGO.com](http://videogames.LEGO.com)



© 2012 The LEGO Group.™ & © TT Games (s12)







www.LEGOclub.com



LEGO® Club Email



LEGO® Club Magazine

**LEGO** club™

**FREE! GRATIS! GRATUIT!**

**SIGN UP ONLINE!**  
**www.LEGOclub.com**

VISIT THE WORLD'S  
BIGGEST LEGO® SHOP!  
[www.LEGOshop.com](http://www.LEGOshop.com)

GO TO  
[www.LEGOclub.com](http://www.LEGOclub.com)

00800 5346 5555\*

1-866-534-6258 • 1-877-518-5346

US & Canada only

Canada seulement



\* Freephone. Mobile charges may apply.  
\* Numéro sans frais. Des frais peuvent s'appliquer avec les téléphones cellulaires.  
\* Gebührenfrei. Kosten für Anrufe aus Mobilfunknetzen können abweichen.  
\* Gratis telefoonnummer vanaf vaste lijn.  
\* Det er et gratis nummer, når du ringer fra fasttelefon.  
\* Det är gratis, när du ringer från en fast telefon.  
\* Numéro sans frais. Des frais peuvent s'appliquer avec les téléphones portables.



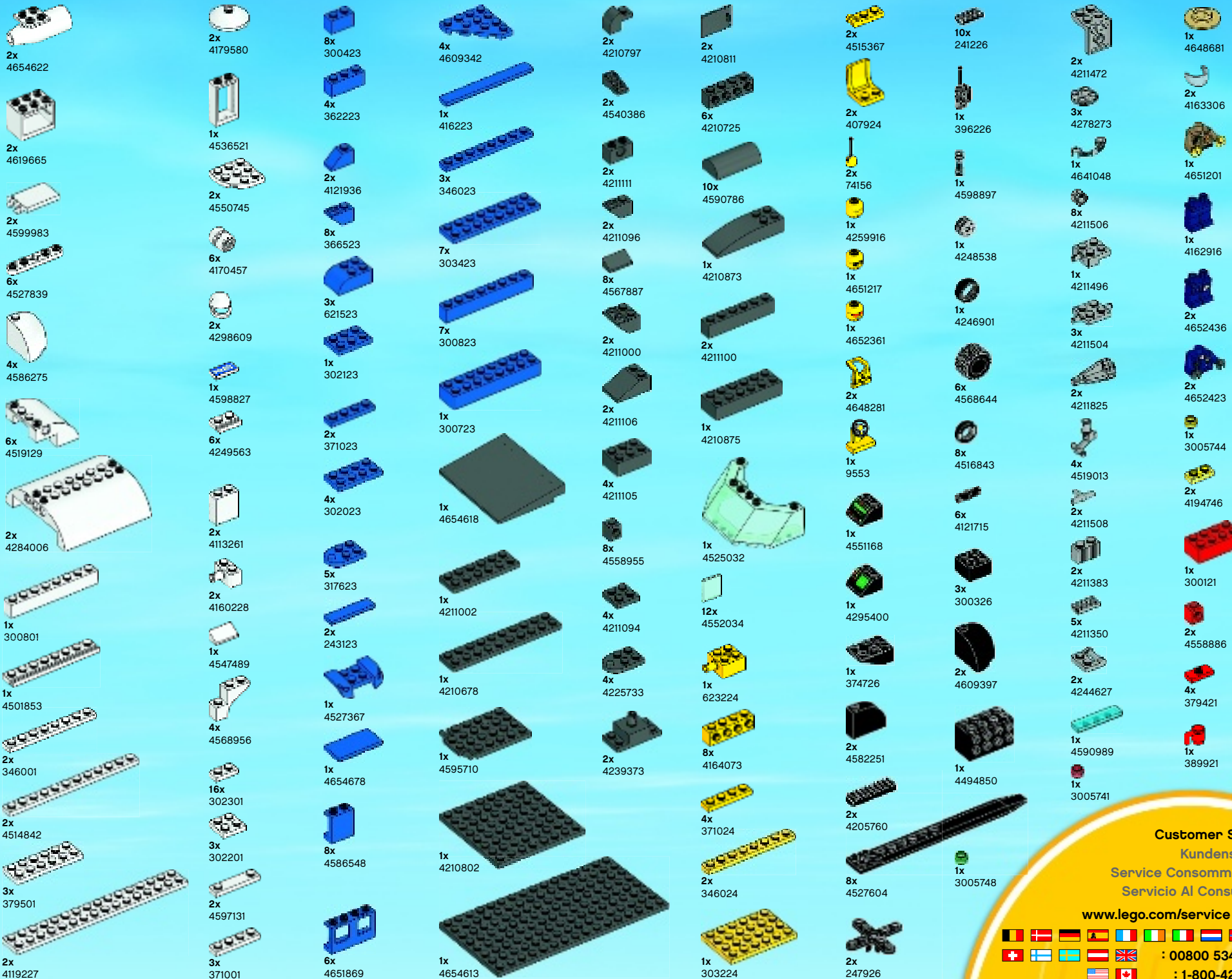

  
**Customer Service**  
 Kundenservice  
 Service Consommateurs  
 Servicio Al Consumidor  
[www.lego.com/service](http://www.lego.com/service) or dial  
 : 00800 5346 5555  
 : 1-800-422-5346



# WIN!

Go to [www.LEGOsurvey.com/product](http://www.LEGOsurvey.com/product) to fill out a survey for a chance to win a cool LEGO® Product.

No purchase necessary.

Open to all residents where not prohibited.



## [www.LEGOsurvey.com/product](http://www.LEGOsurvey.com/product)

### GEWINNE!

Nimm an der Umfrage auf [www.LEGOsurvey.com/product](http://www.LEGOsurvey.com/product) teil und hab die Chance ein cooles LEGO® Produkt zu gewinnen!

Die Teilnahme am Gewinnspiel führt zu keinerlei Kaufverpflichtungen. Teilnahme in allen nicht ausgeschlossenen Ländern möglich.

### WIN!

Ga naar [www.LEGOsurvey.com/product](http://www.LEGOsurvey.com/product), vul een enquêteformulier in en maak kans op een cool LEGO® product.

Geen aankoopverplichting. Iedereen mag deelnemen, uitgezonderd ingezetenden van landen waar een enquêteverbod geldt.

### GAGNE!

Visite [www.LEGOsurvey.com/product](http://www.LEGOsurvey.com/product) pour répondre à un questionnaire et avoir une chance de gagner un produit LEGO® très cool!

Aucune obligation d'achat. Ouvert à tous les résidents des pays autorisés.

### 当てよう!

[www.LEGOsurvey.com/product](http://www.LEGOsurvey.com/product) にアクセスして、アンケートにご記入ください。当選者にはレゴ®製品を差し上げます。

お買い上げの必要はありません。禁止されていない限り、すべての皆様にご利用いただけます。