

# CREATOR

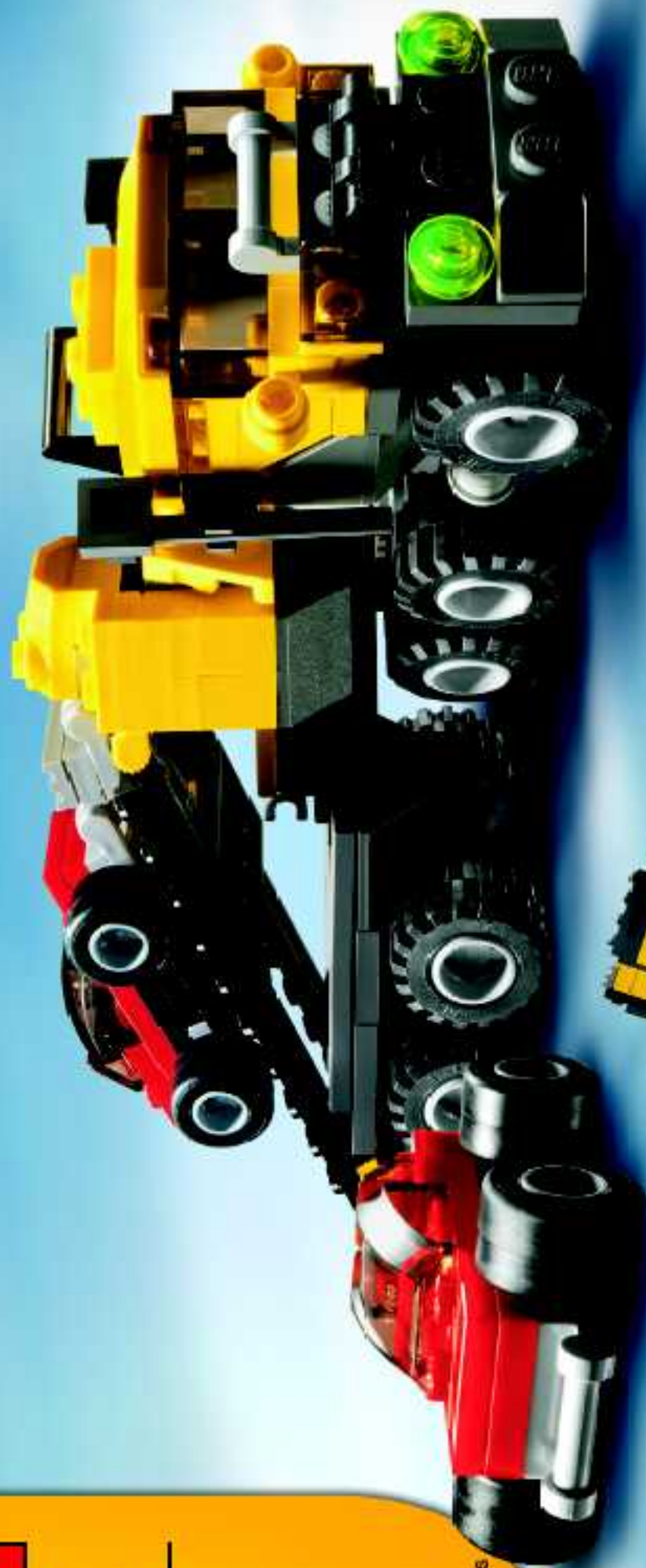

modèle  
verschobene  
Modèle in Etiam  
modèle et  
modell  
modellen  
modellen en

# 6-in-1



# LEGO

## 6-12

4891



Ideas



Instructions





Quick Build  
 Schnellbaumodelle  
 Construction rapide  
 Costruzione rapida  
 Snel bouwen  
 Construcción rápida  
 Byg hurtigt  
 Nopeaan rakentamiseen  
 Bygg snabbt  
 Construção Rápida  
**Γρήγορες Κατασκευές**  
 Kísérletezőknek



Experienced Build  
 Könnemodelle  
 Construction normale  
 Costruzione esperta  
 Bouwen voor gevorderden  
 Construcción experta  
 Byg videre  
 Kokeneelle rakentajalle  
 Bygg mer  
 Construção para Experimentados  
**Εμπειρικές Κατασκευές**  
 Haladóknak



Advanced Build  
 Profimodelle  
 Construction avancée  
 Costruzione avanzata  
 Geavanceerd bouwen  
 Construcción avanzada  
 Byg avanceret  
 Taitavalle rakentajalle  
 Bygg avancerat  
 Construção Avançada  
**Εξελιγμένες Κατασκευές**  
 Profioknak





1



2



3



4



5







9



1



2



3



4



10



11

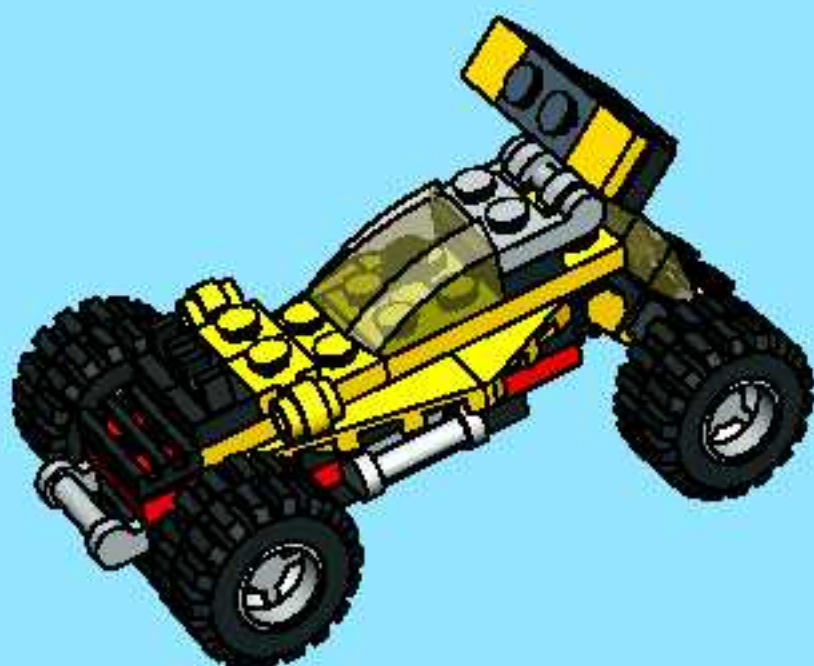



1



2



3

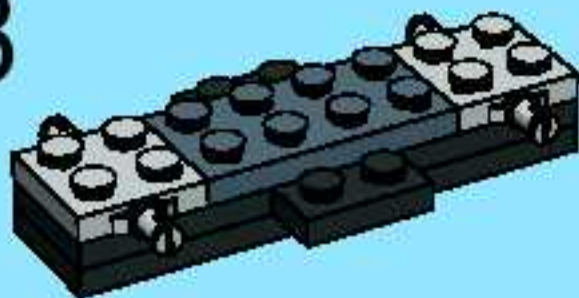

4

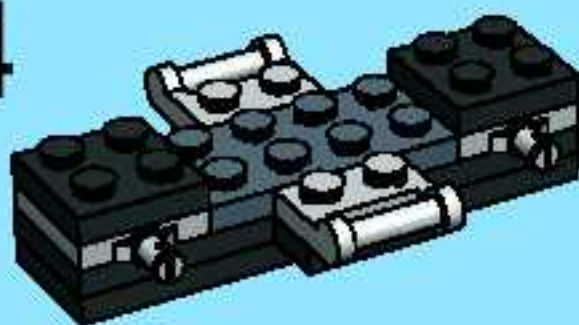

5

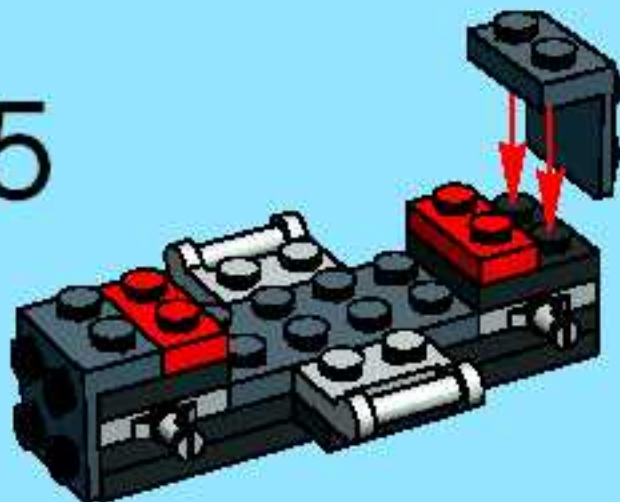



6

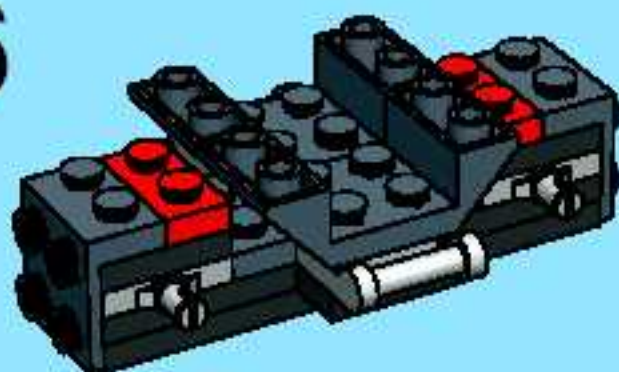

7

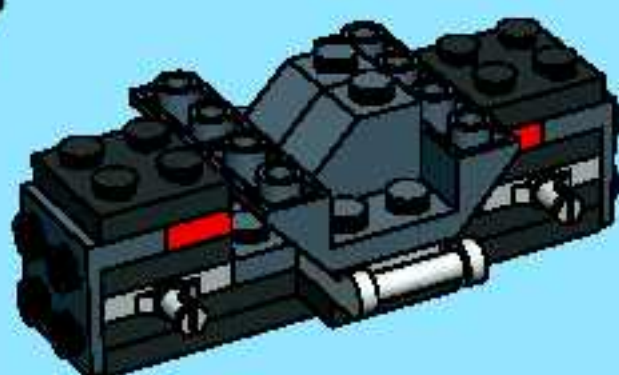

1



2



3



8

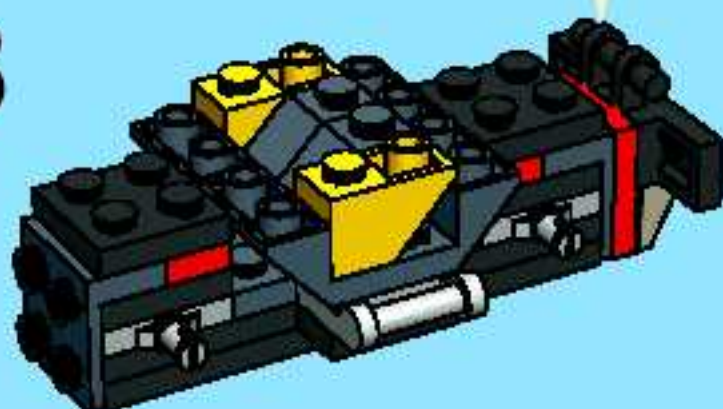

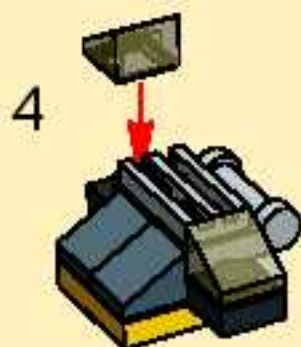
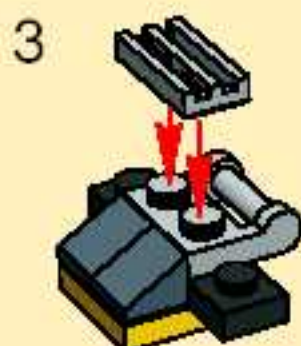
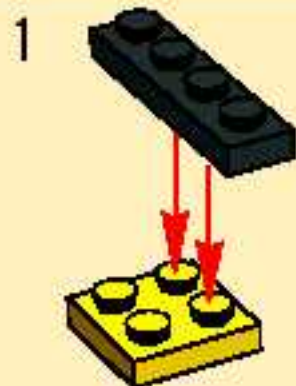

9



10





11

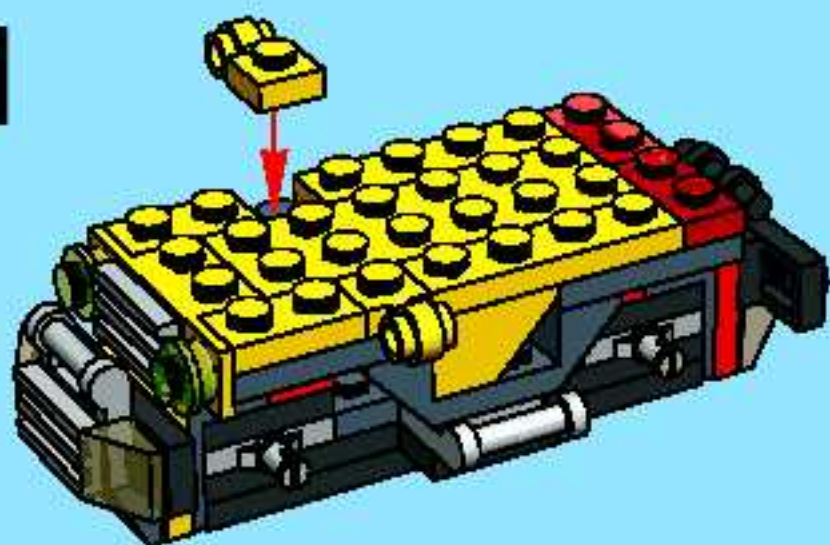

12



13

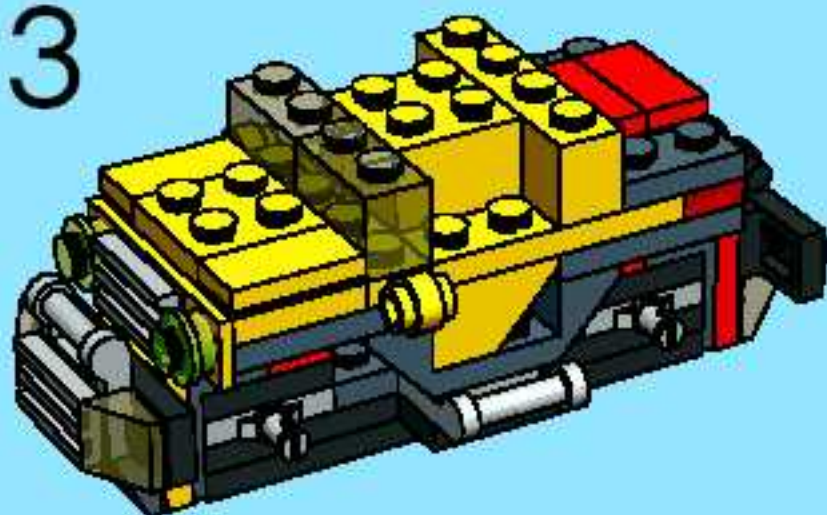

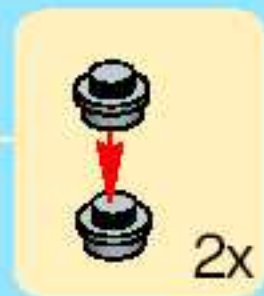
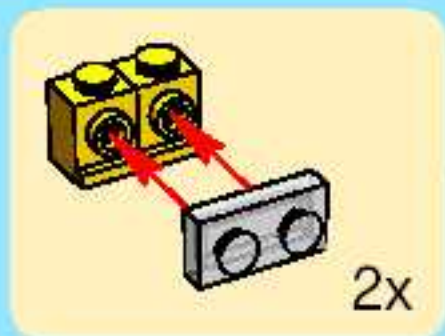

14

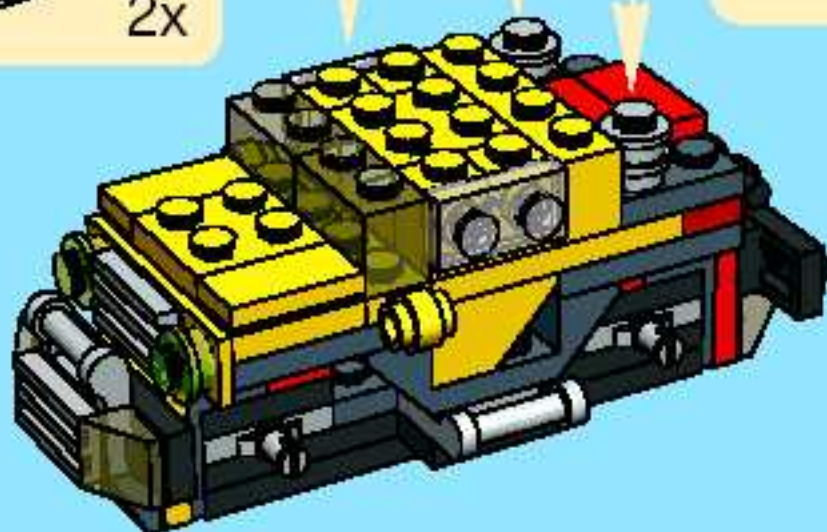

15

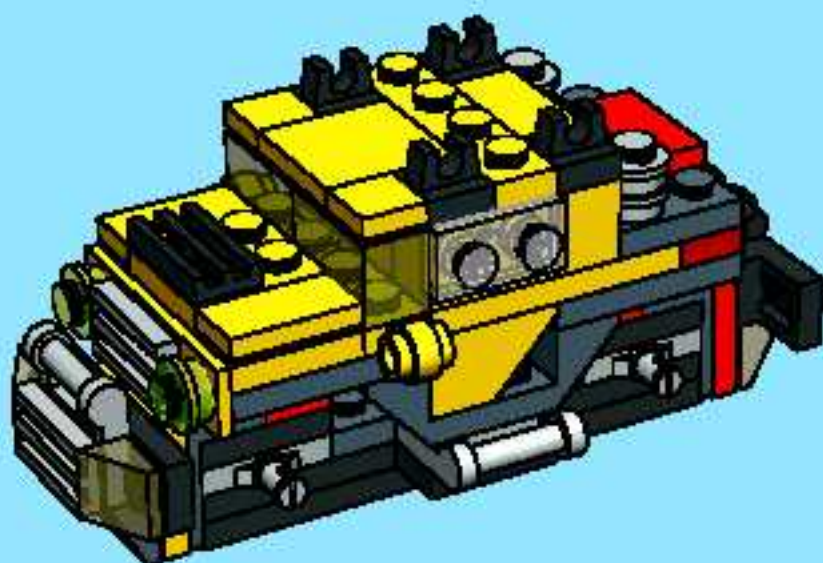

16







3





1



2



3



1

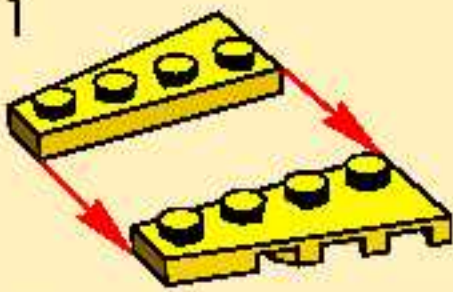

2



4





5

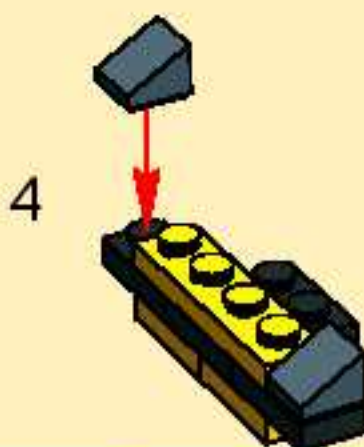
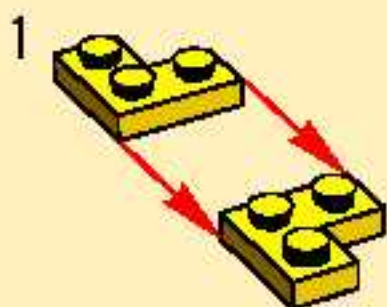
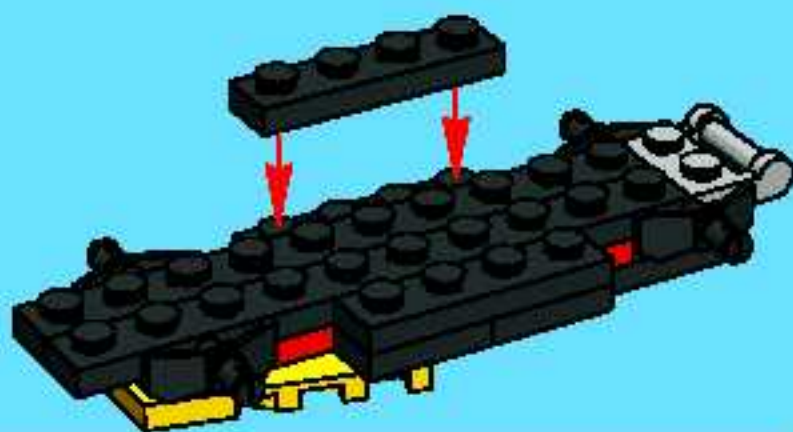

6



7



8

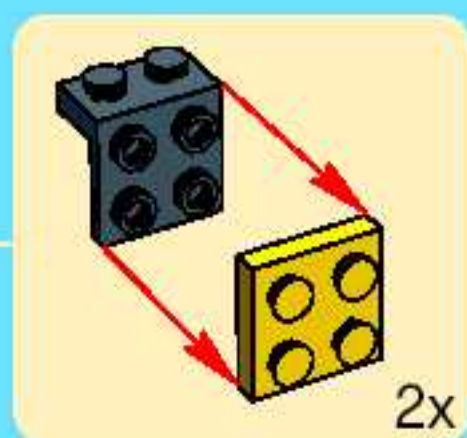

9



10

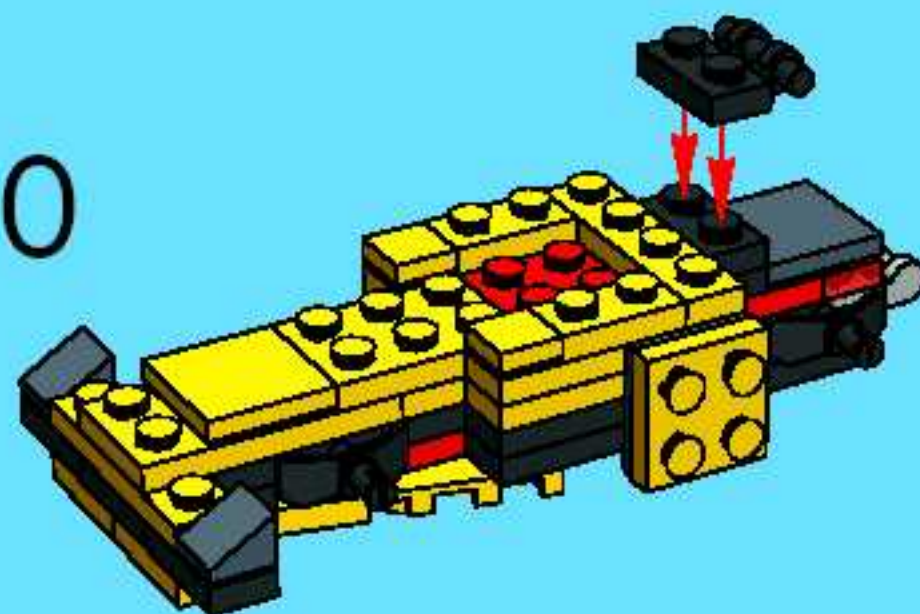



11

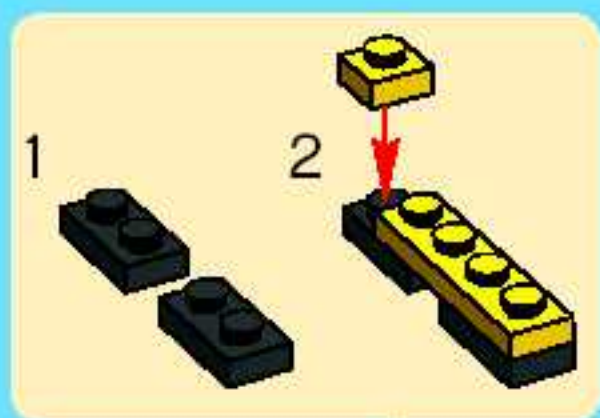

12

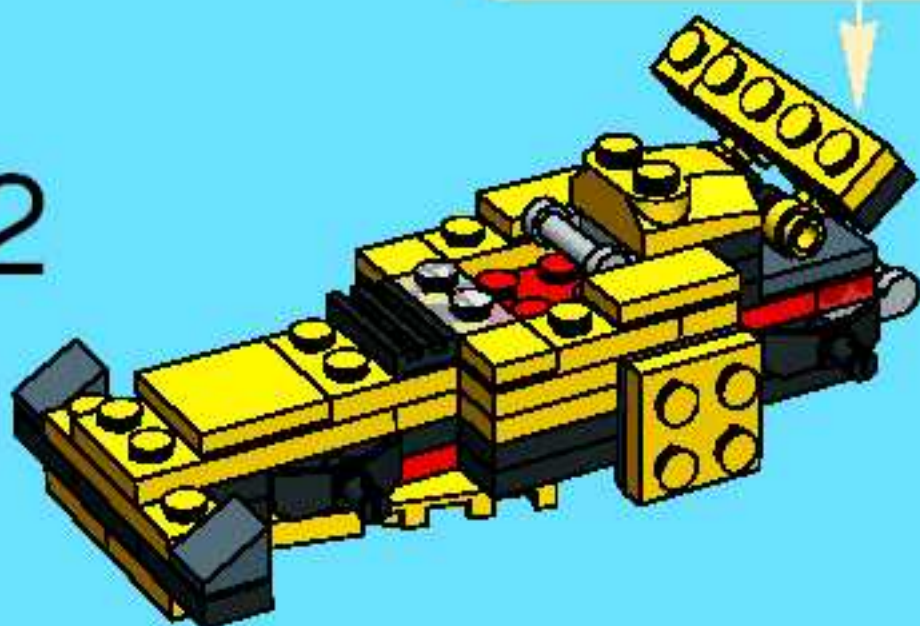

13

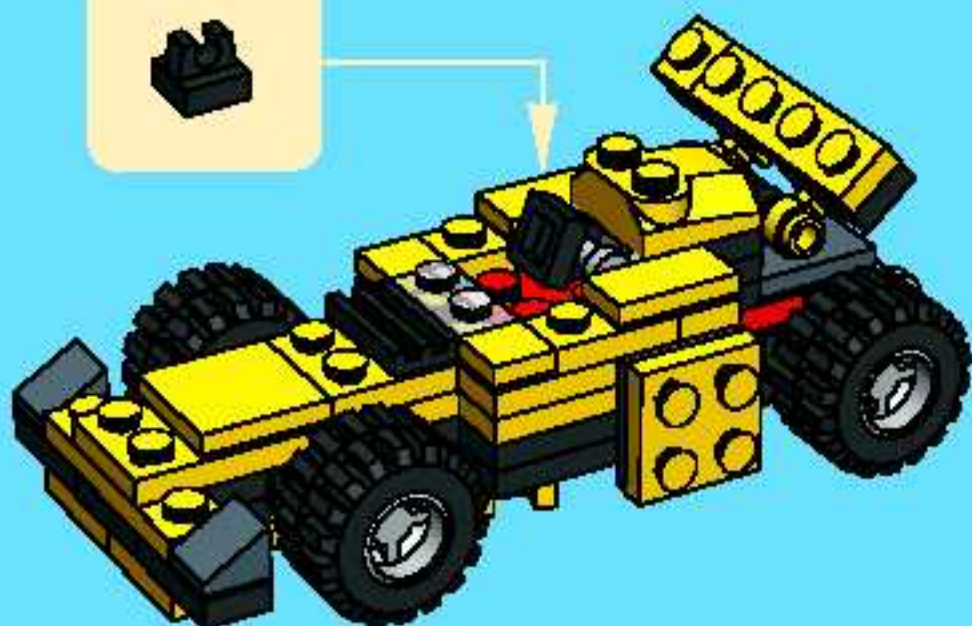

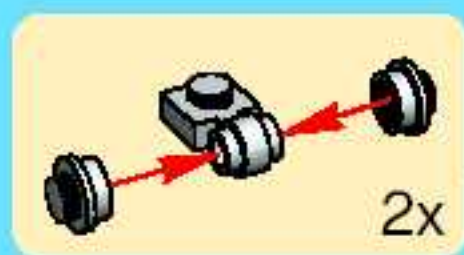
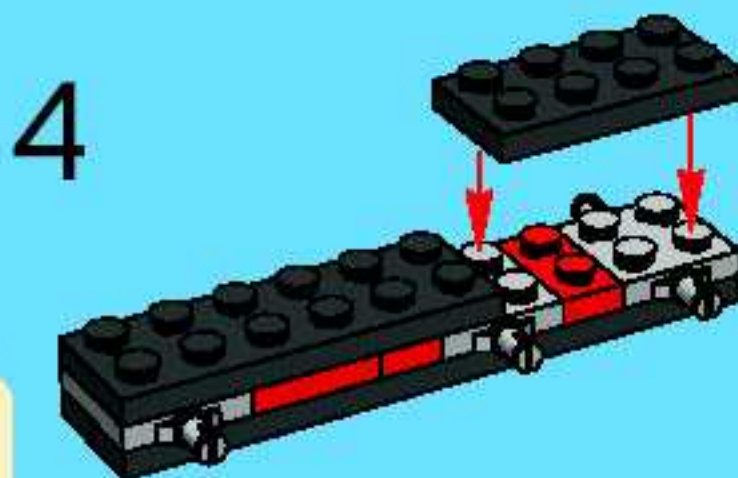
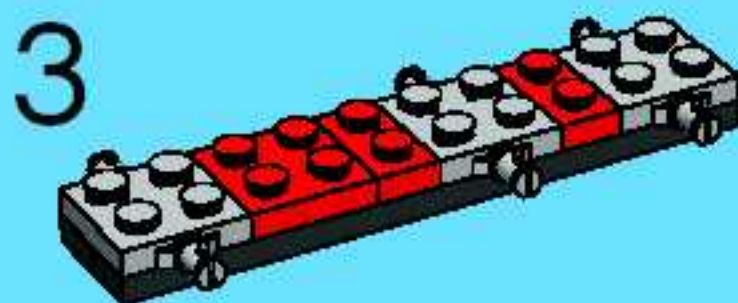
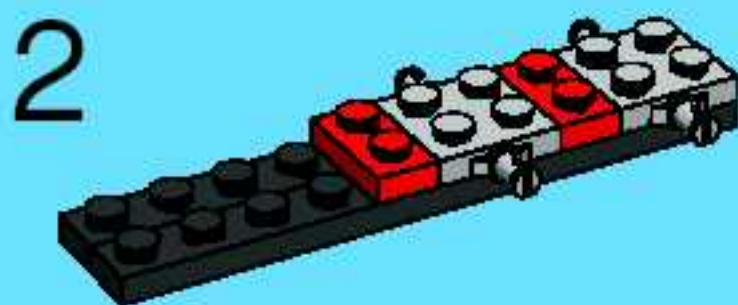
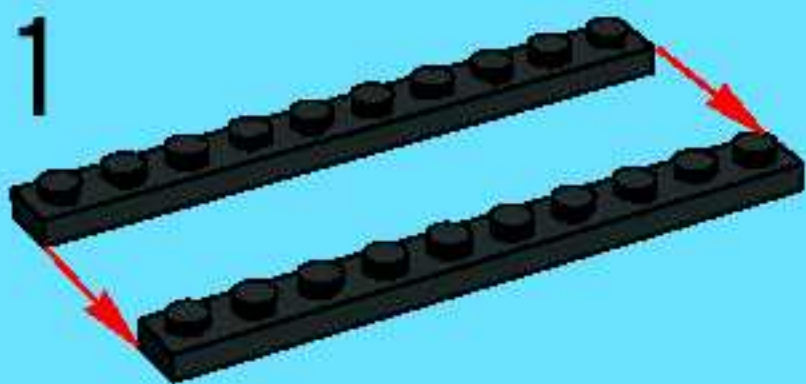



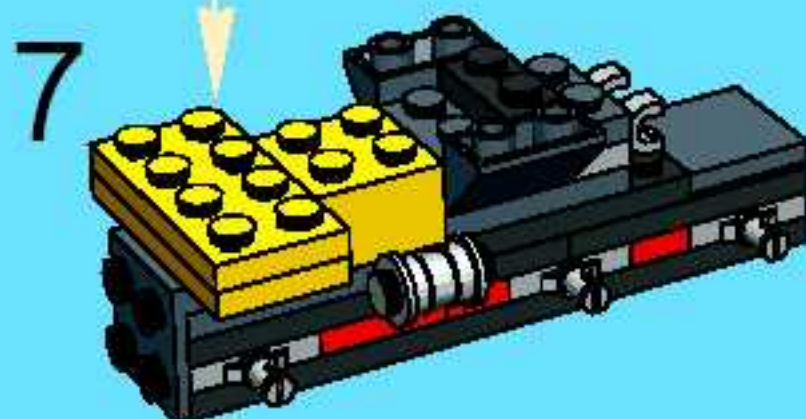
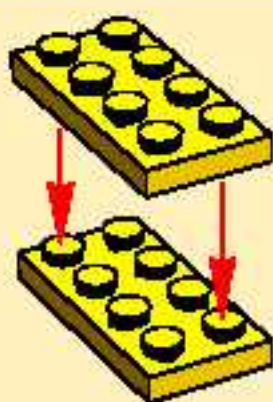
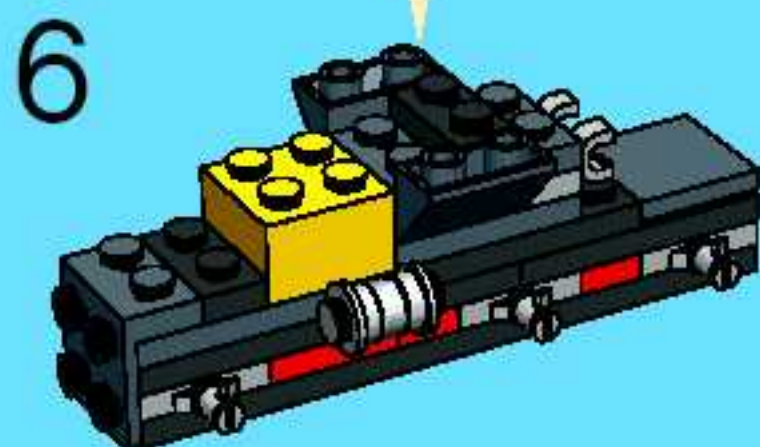

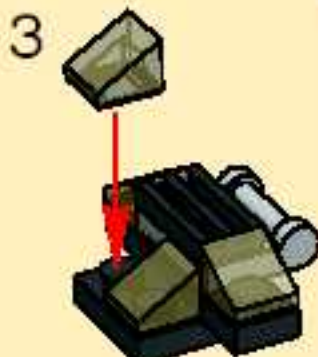

8



1



2



9

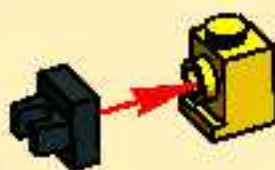

2x

10

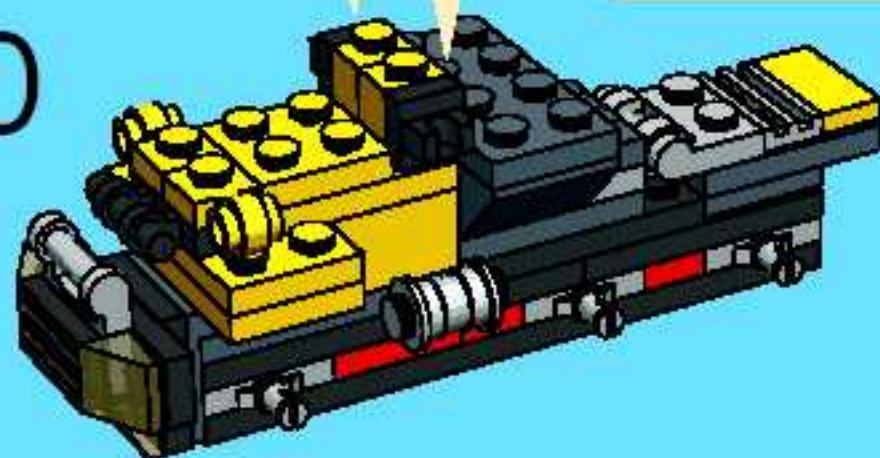



11

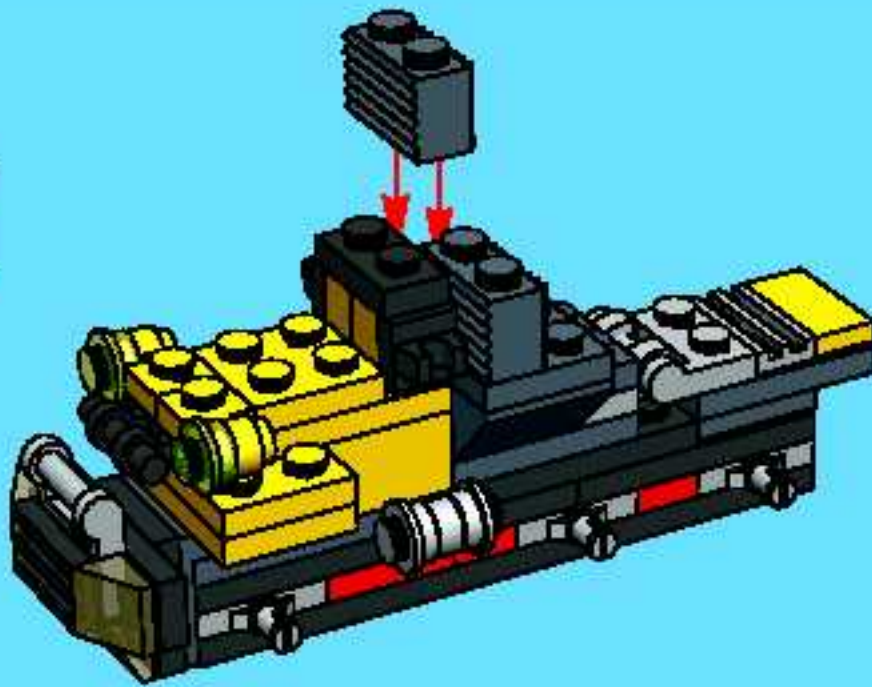

12

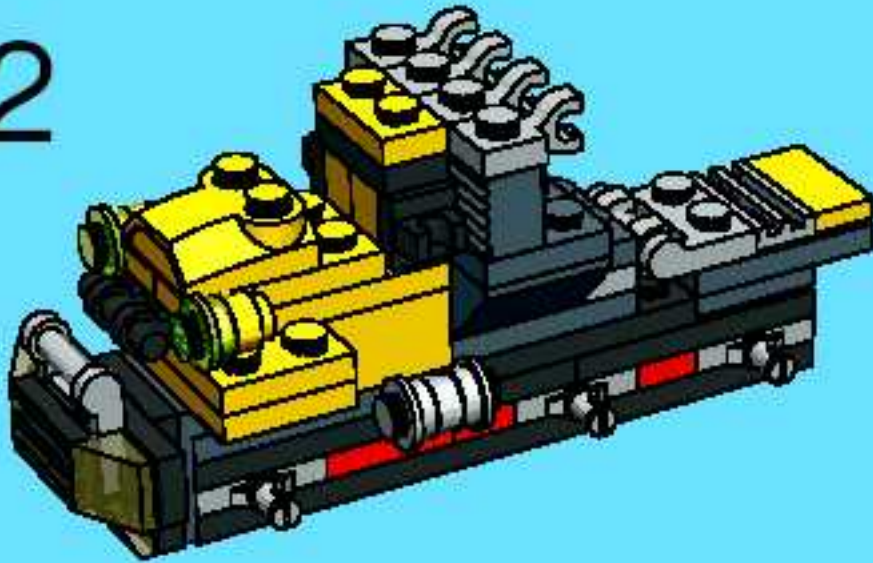

13

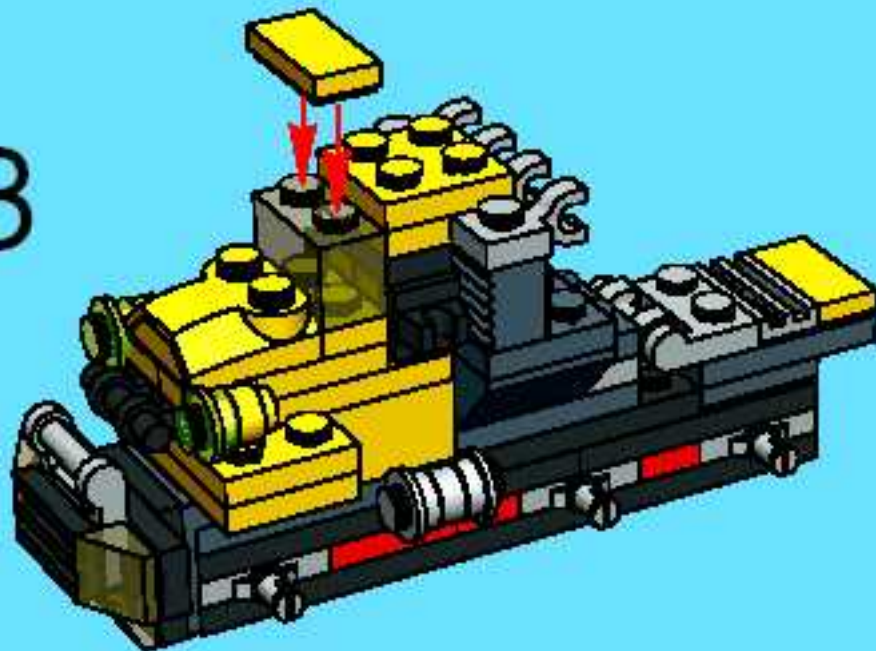

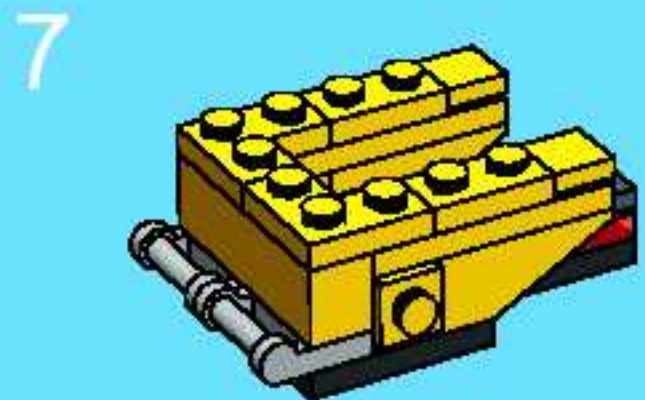
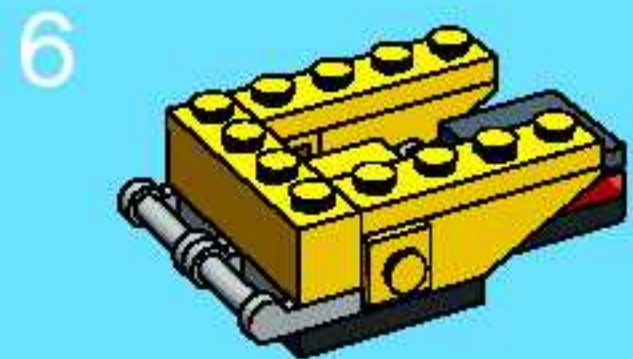
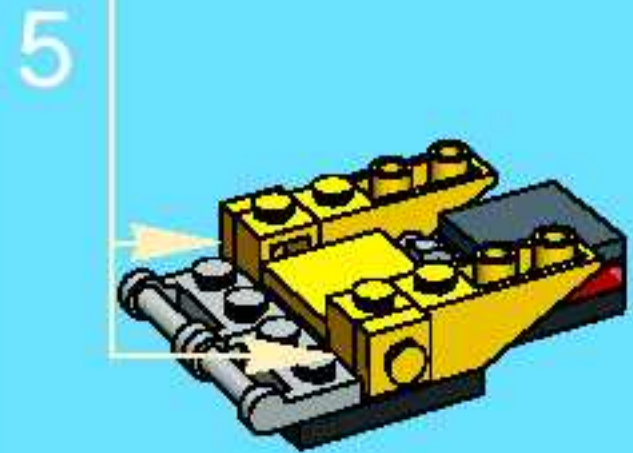
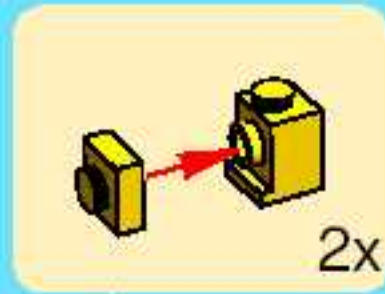
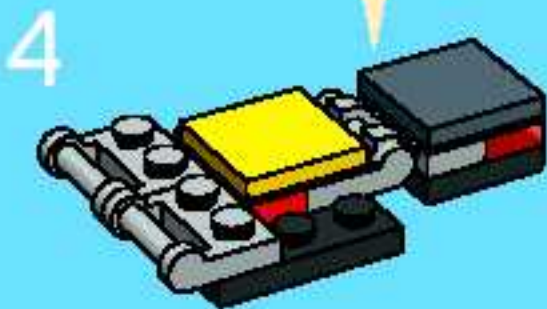
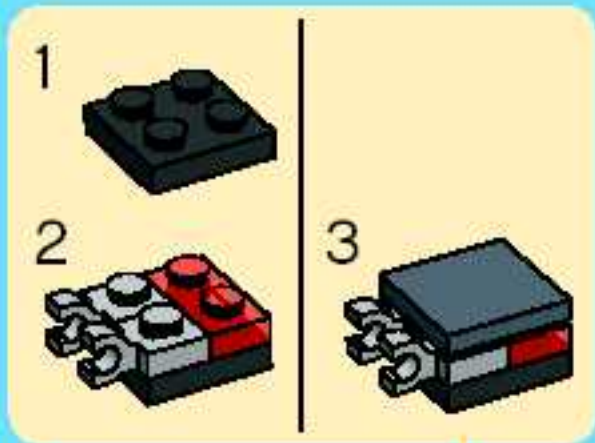
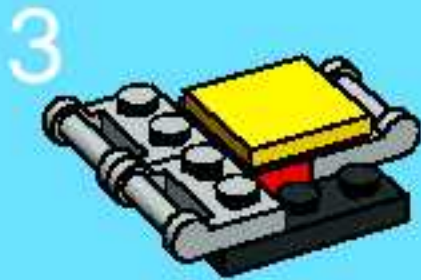
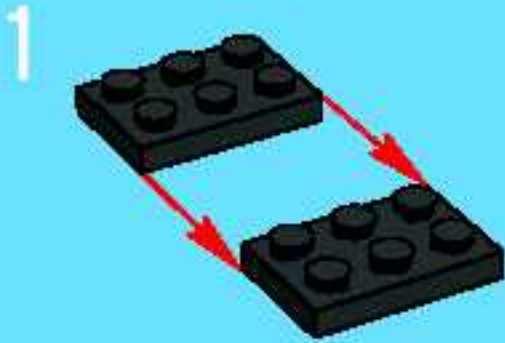



14

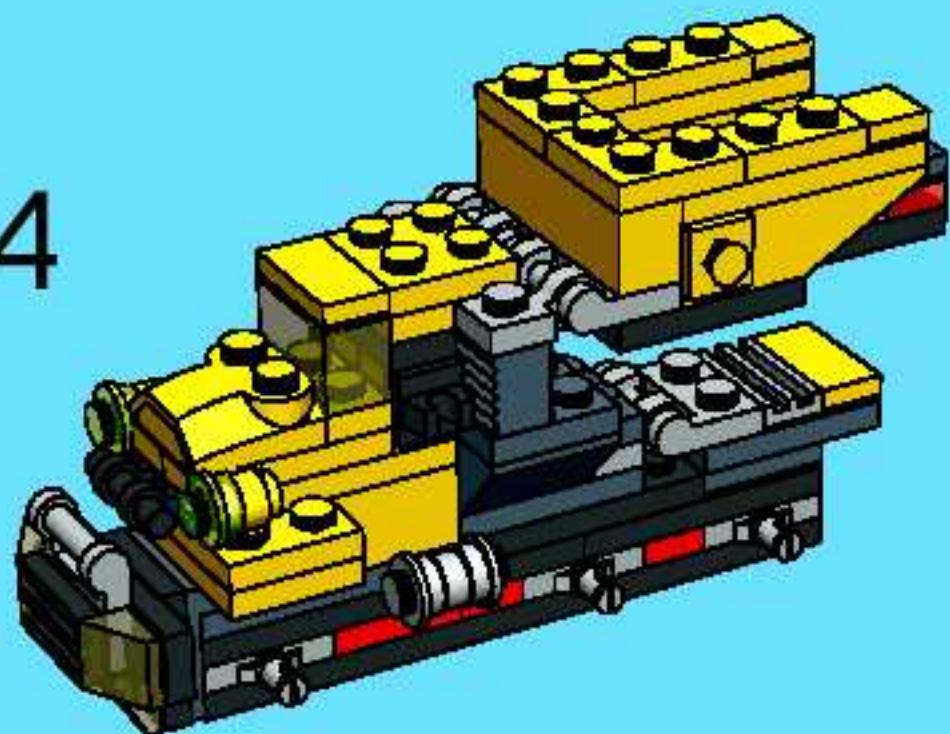

15

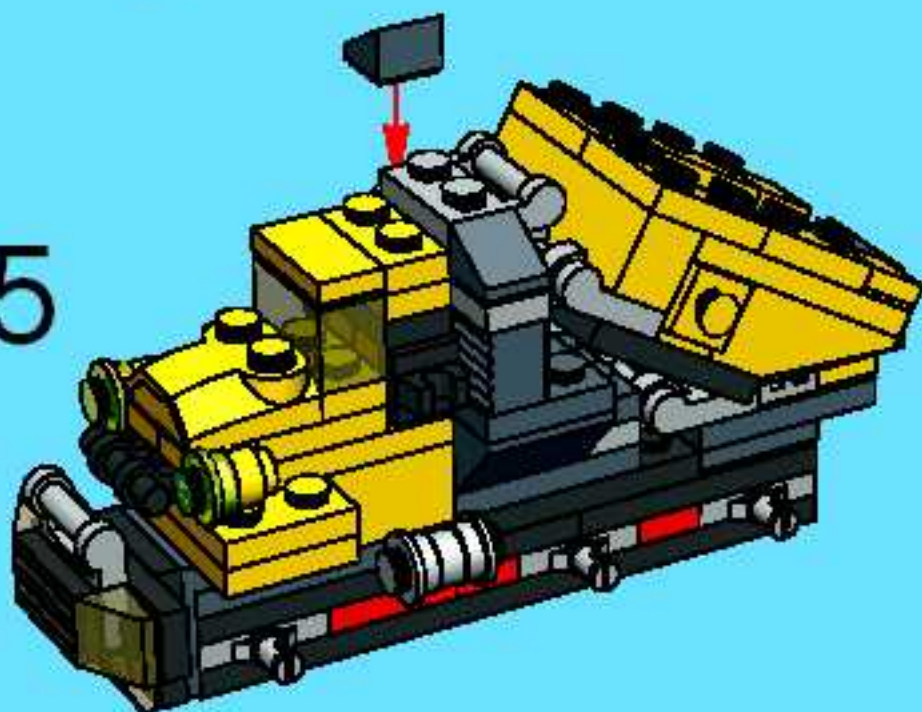

2x

16













- 1
- 2
- 3
- 4

- 5

- 6

- 7

- 8

2x





1



2

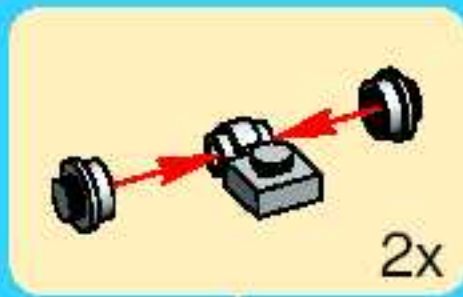

3



4

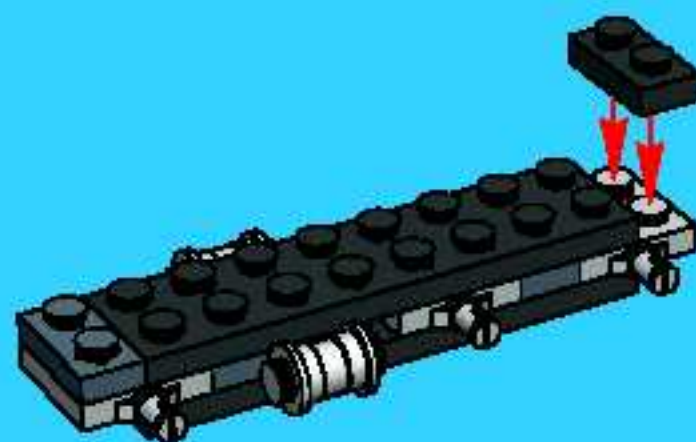

5

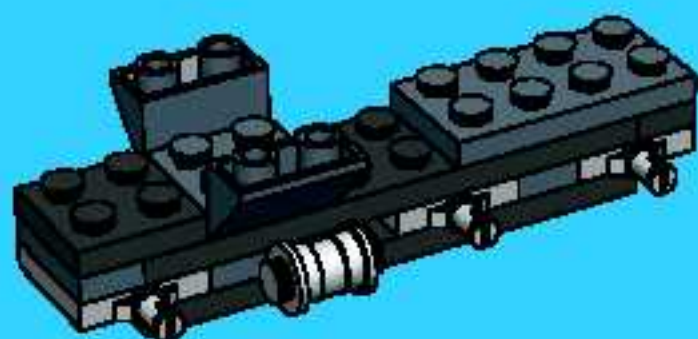

6

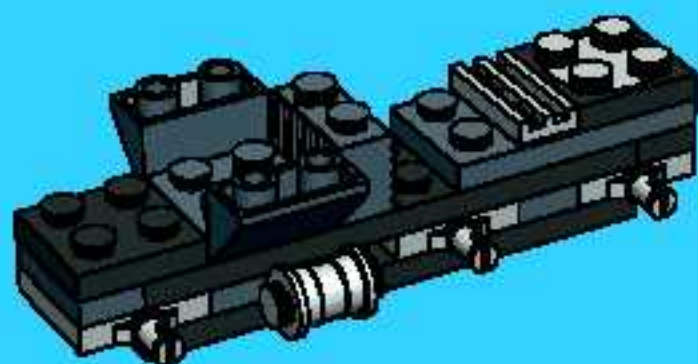



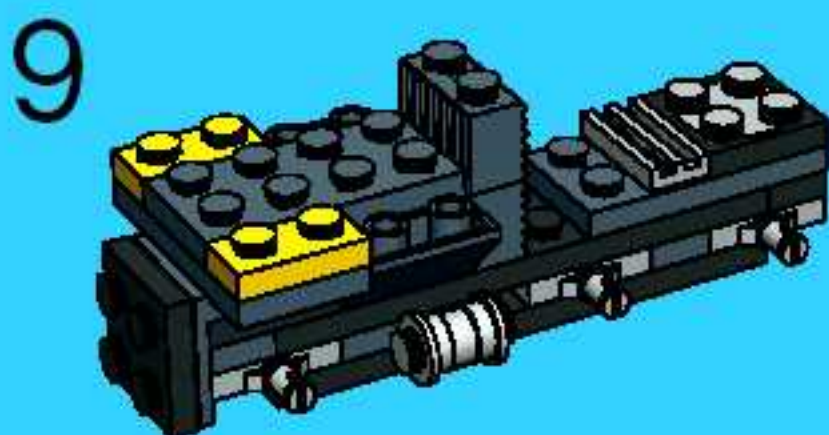
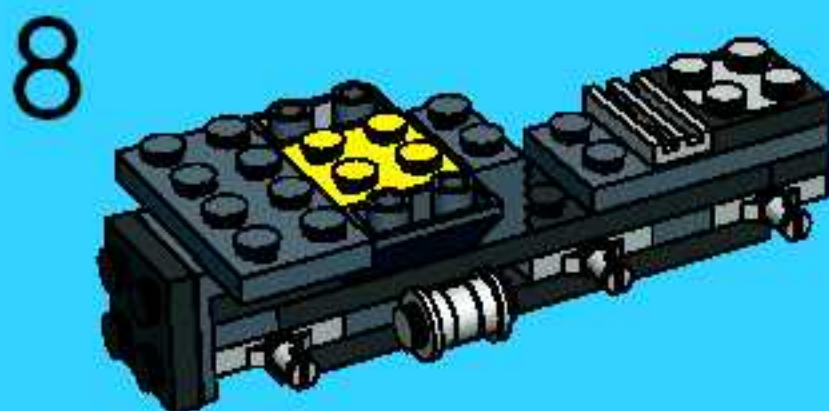
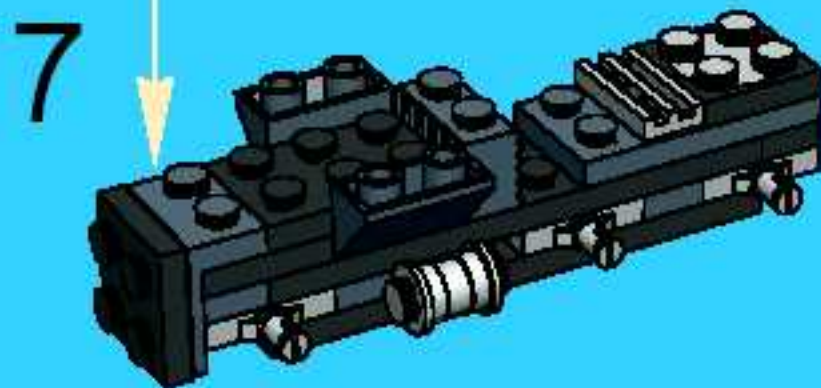
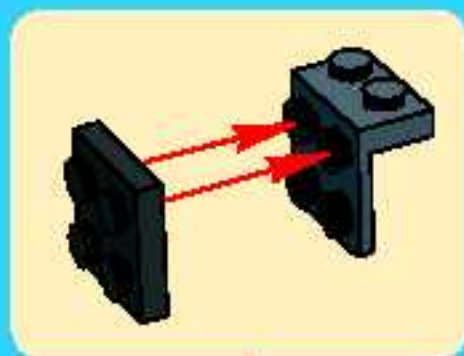

10

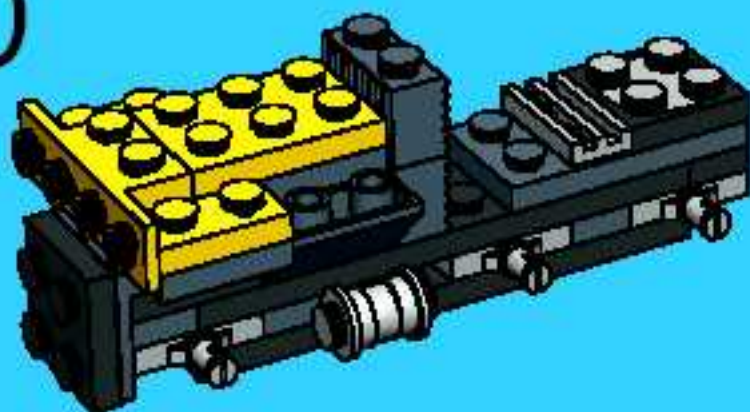

11

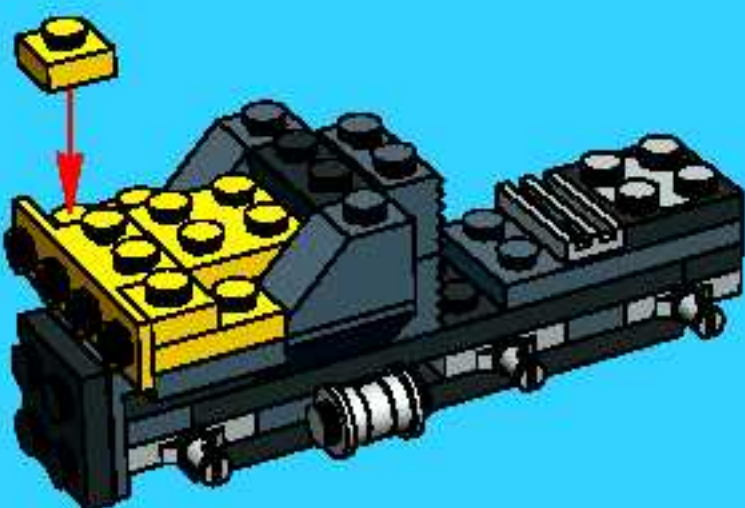

12

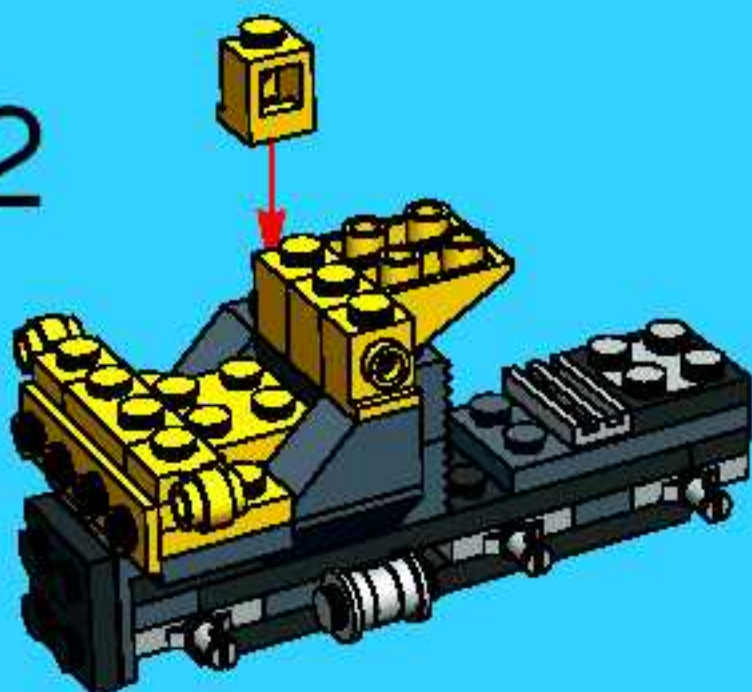



13

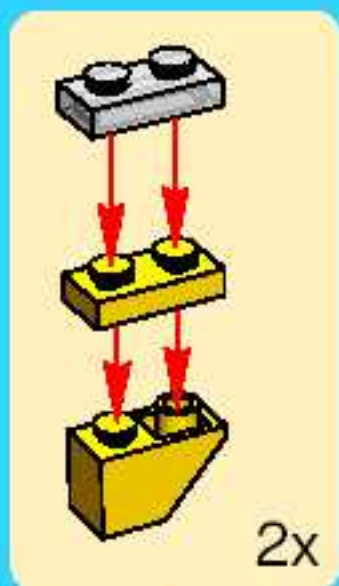
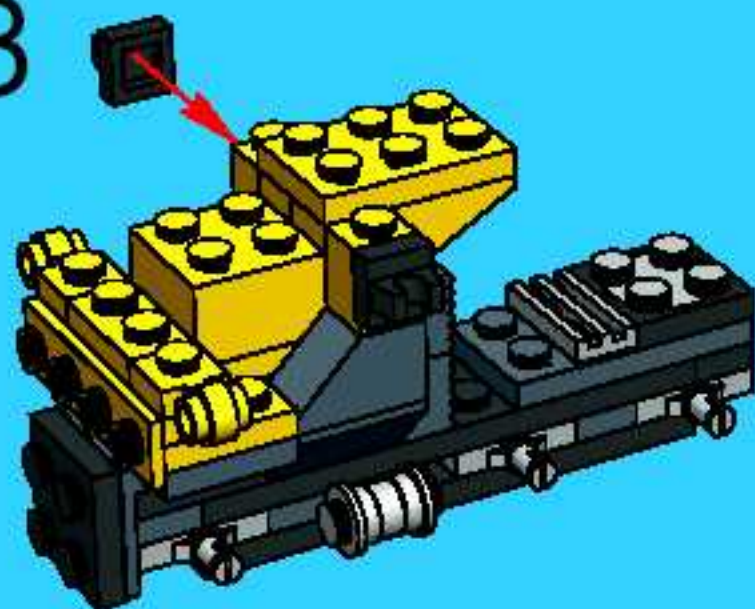

14

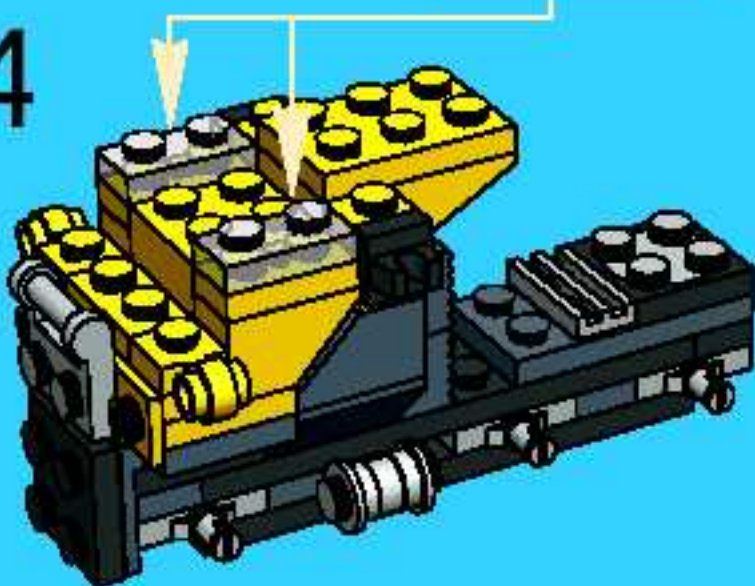

15

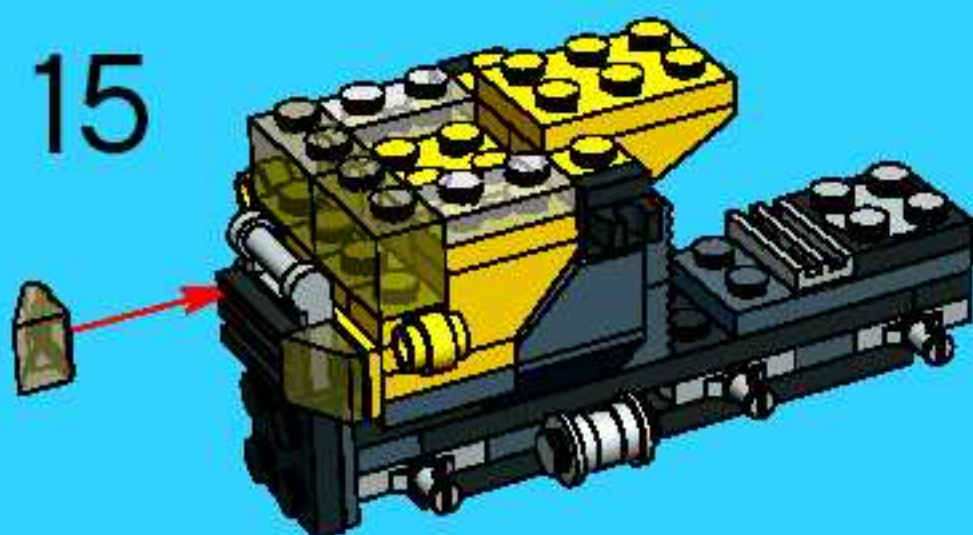

1



2



3



16





17

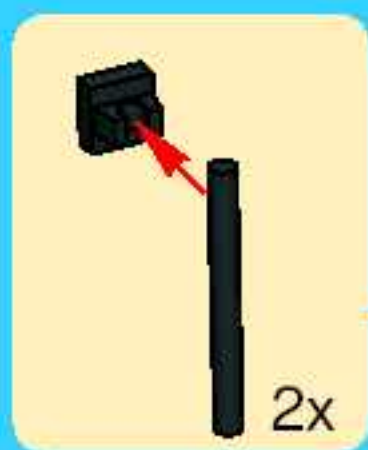
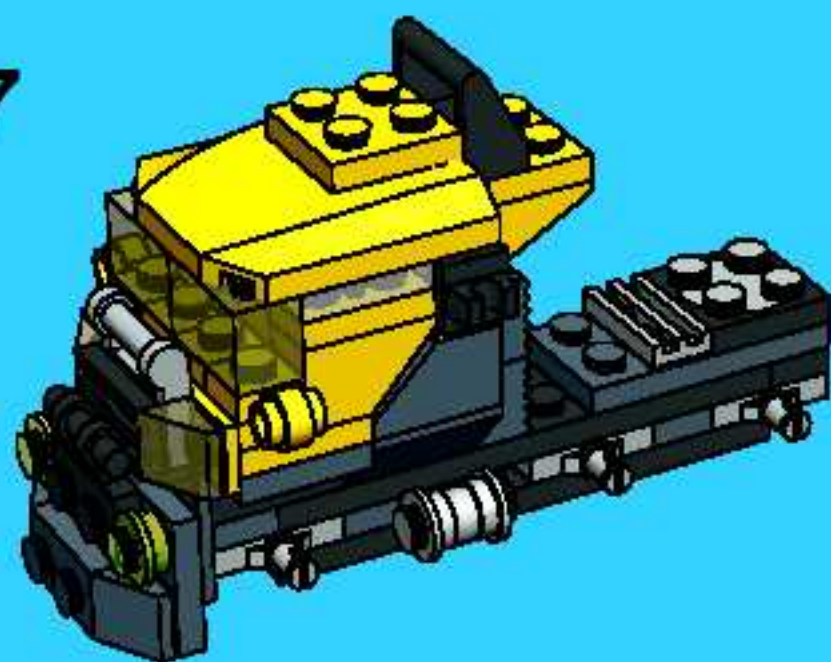

18





1

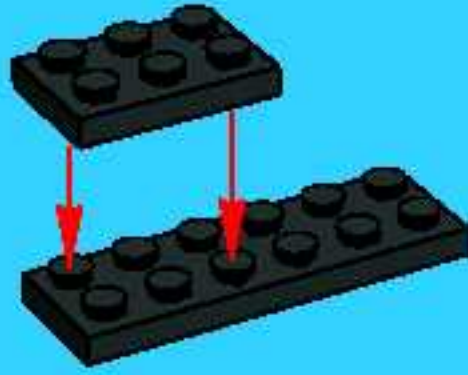

2



3





4



5



6

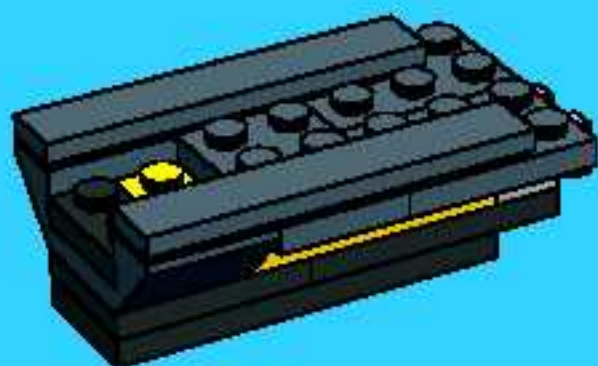

7



1



2



3



8







1



2

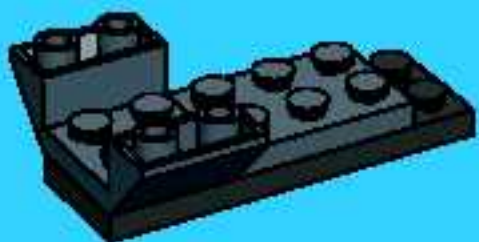

3

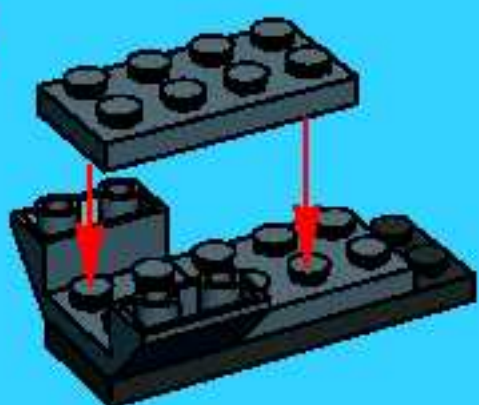

4



5



6

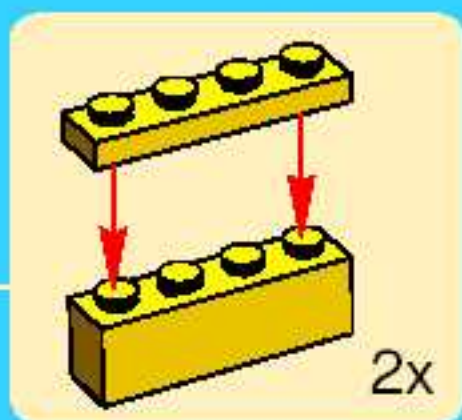

7





8



9



10



11



9

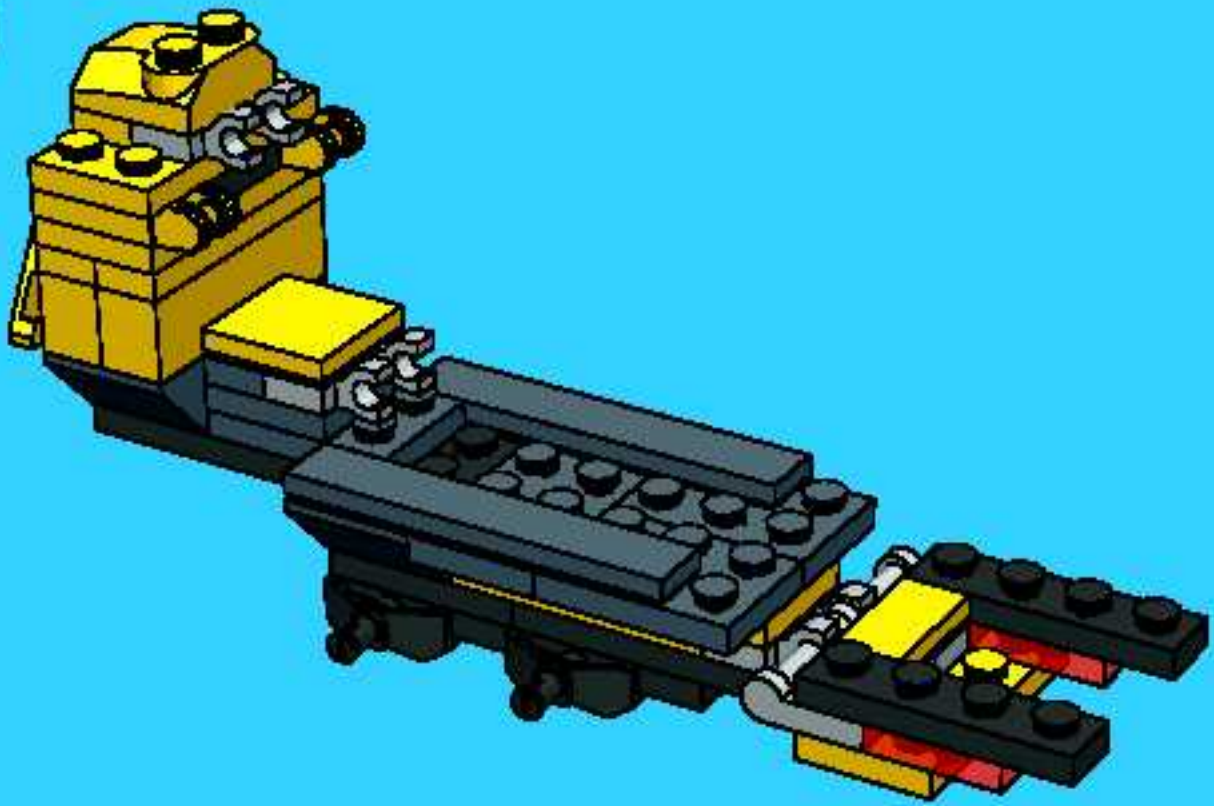

10

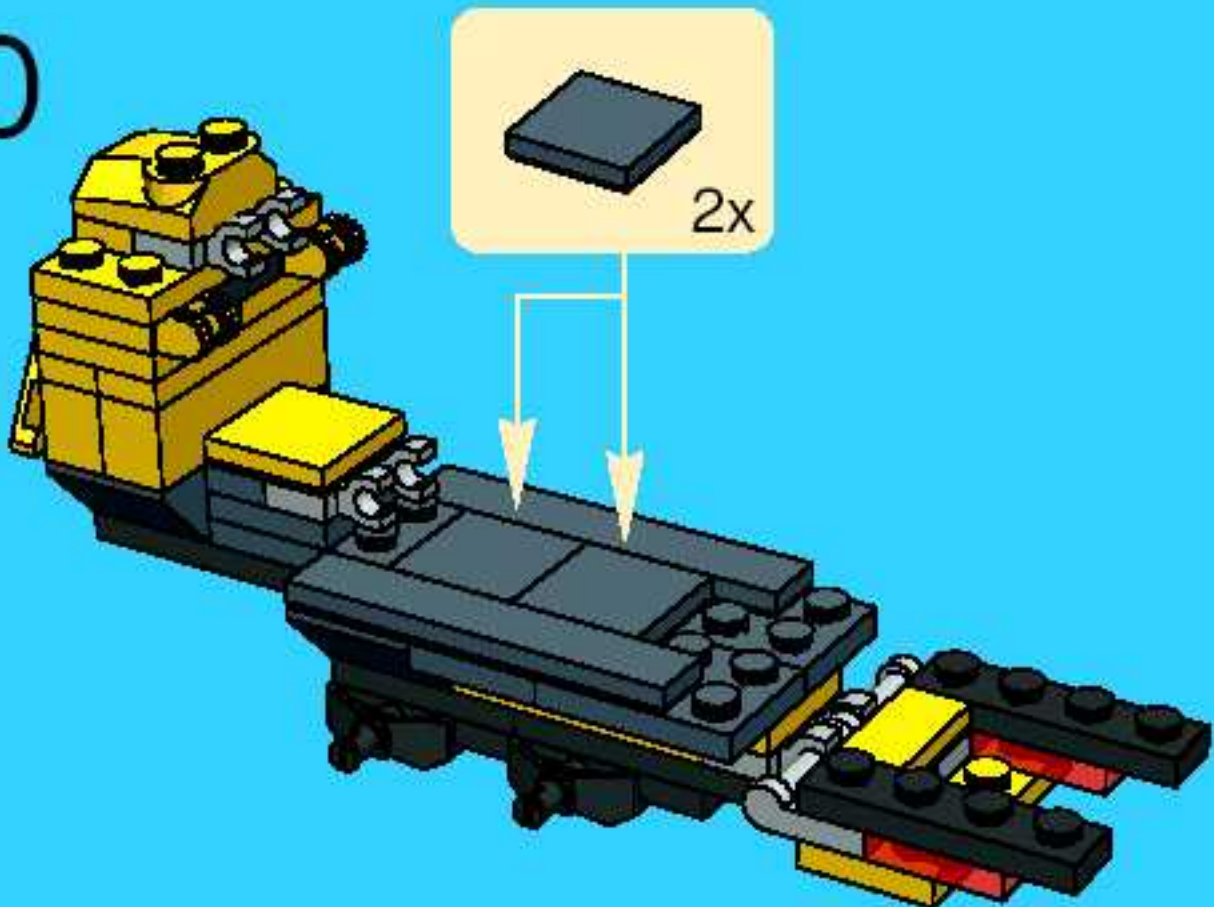



1

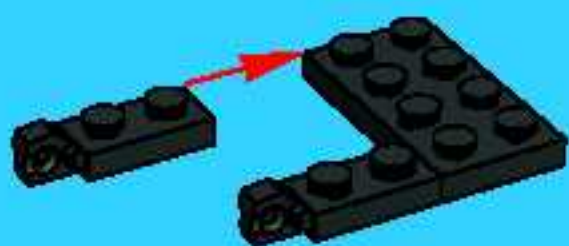

2

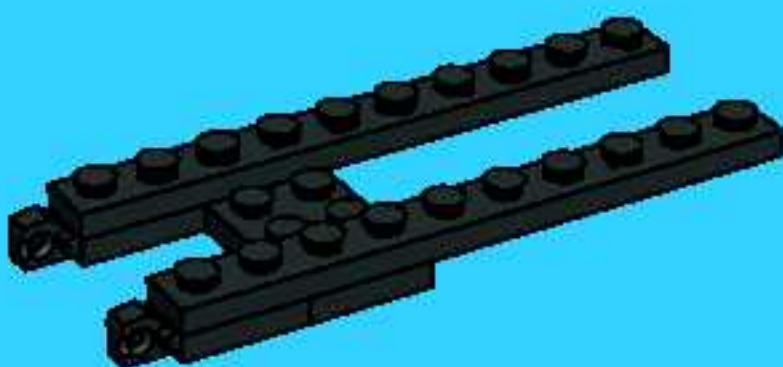

3

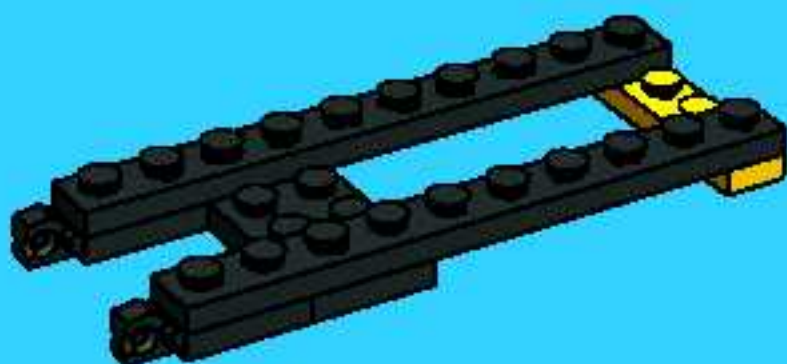

4

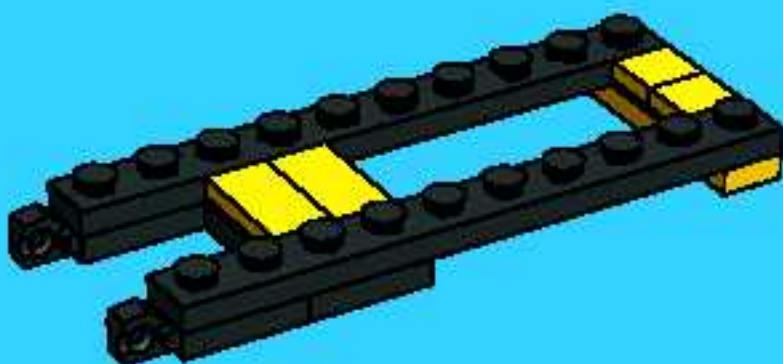

11

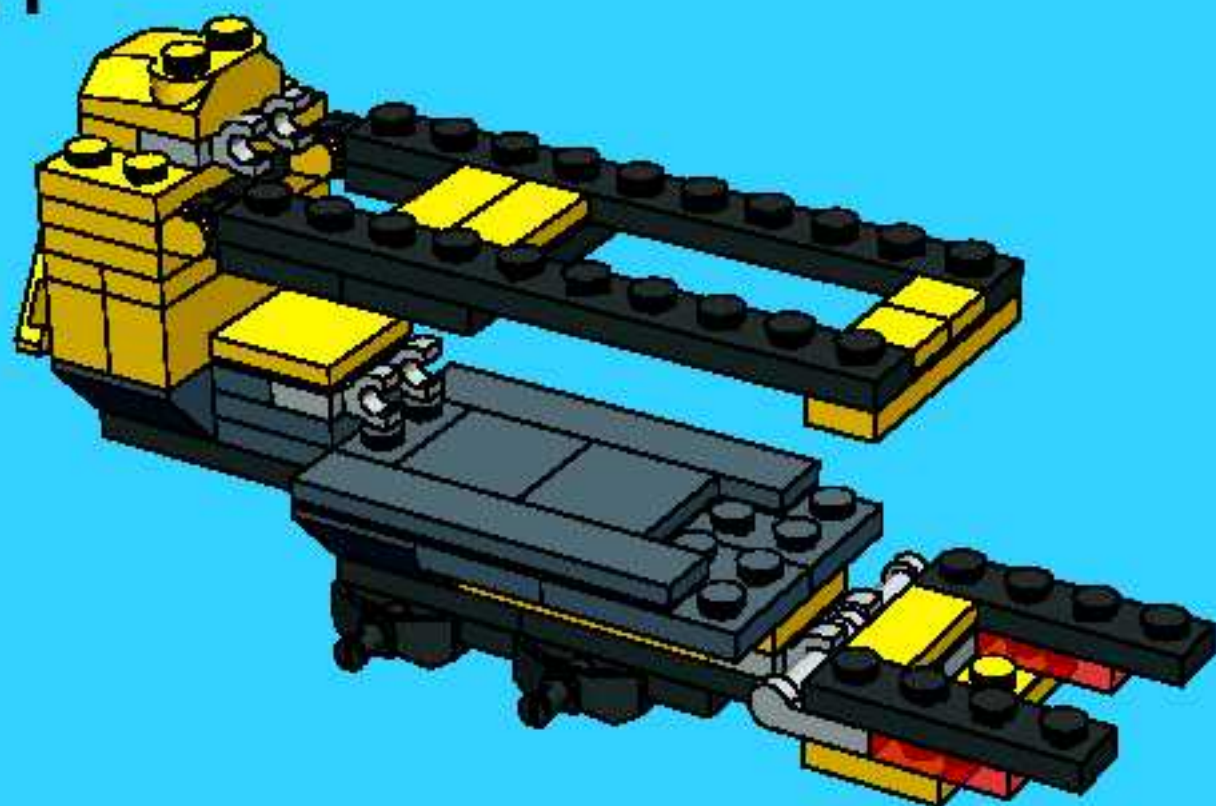

1



2



3



12









1

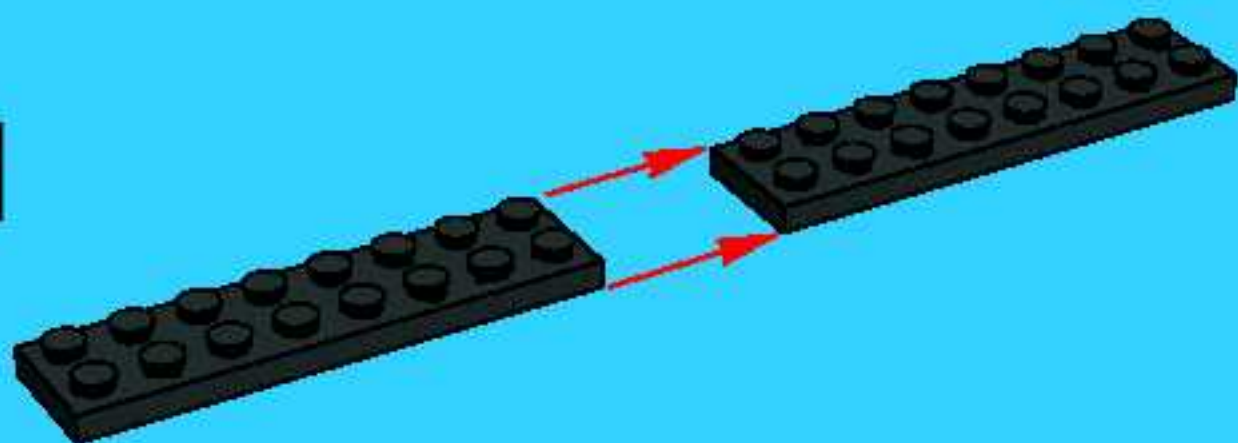

2



3

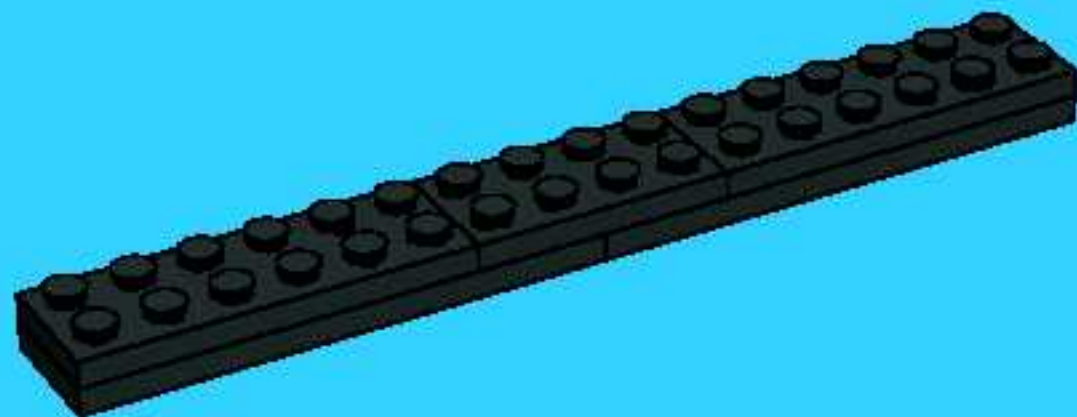



4

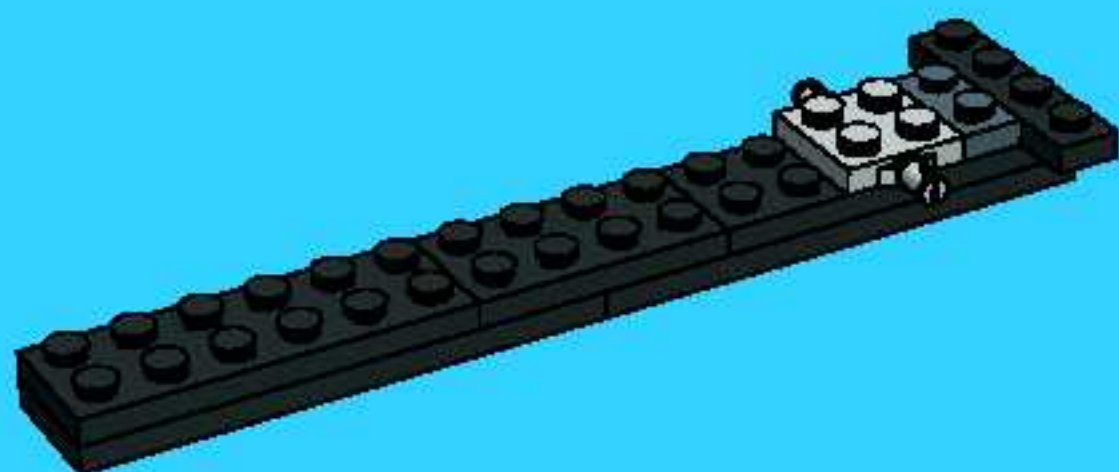

5

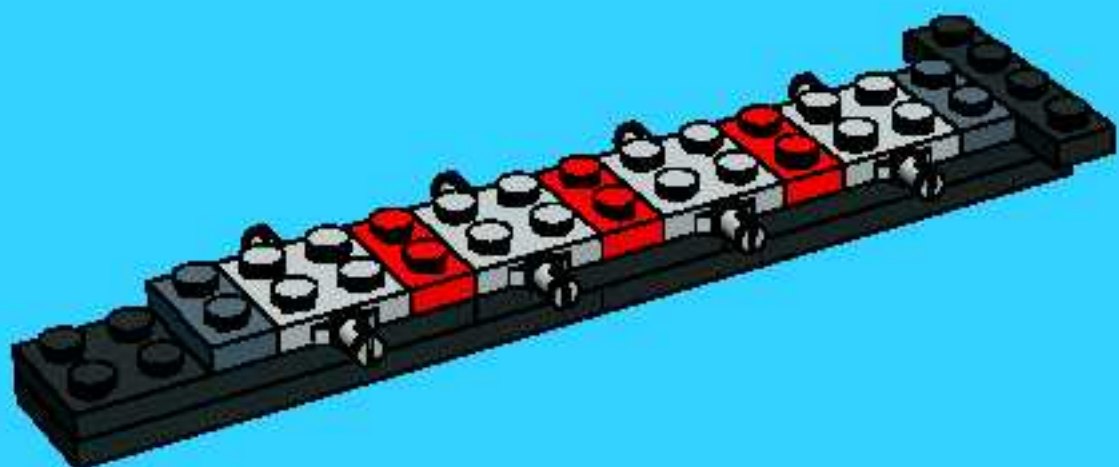

6

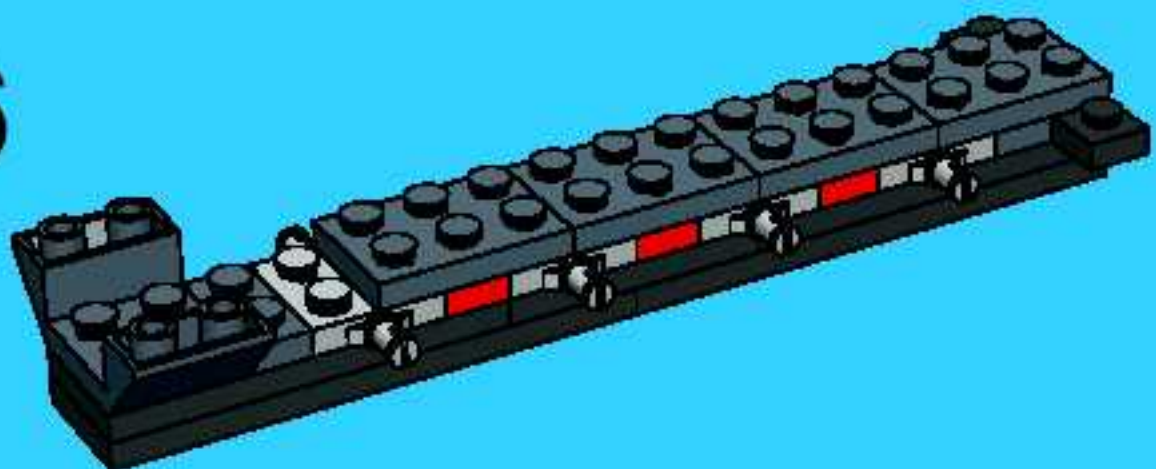

7

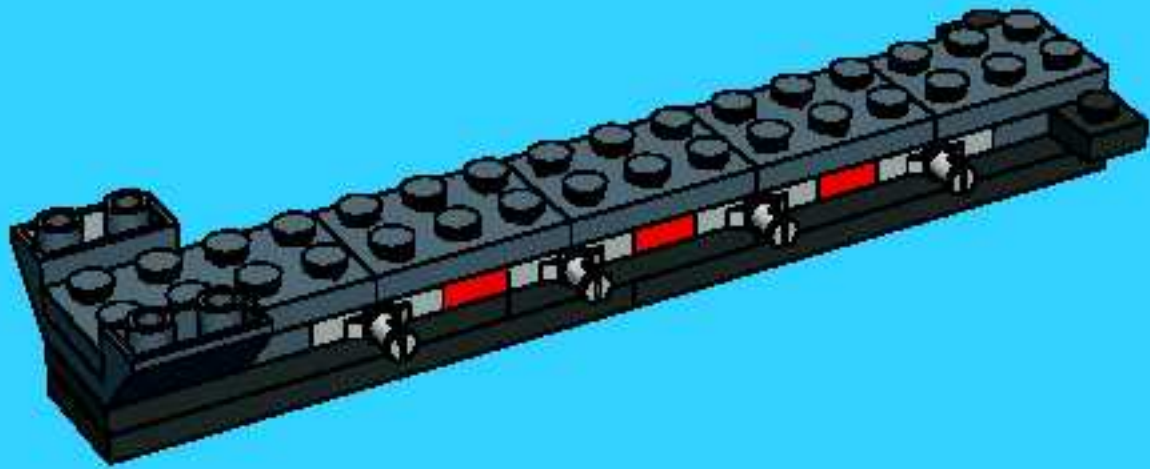

8

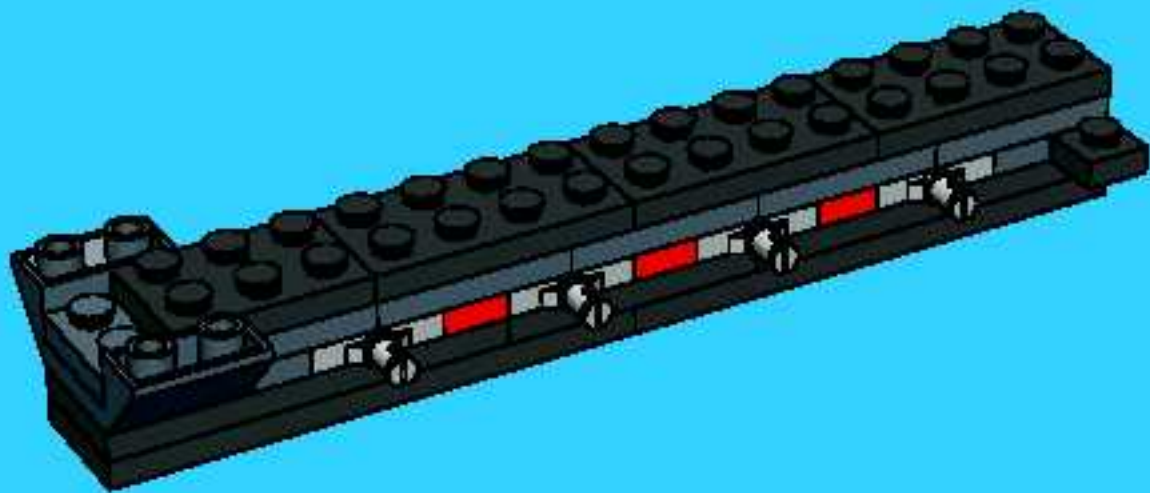

1



2



9

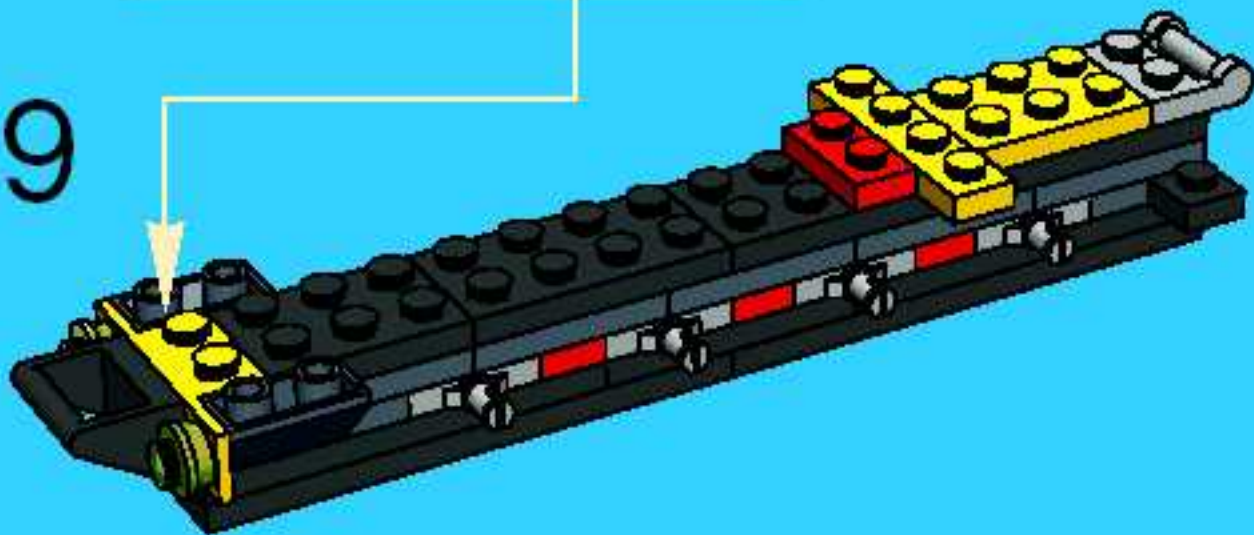



10

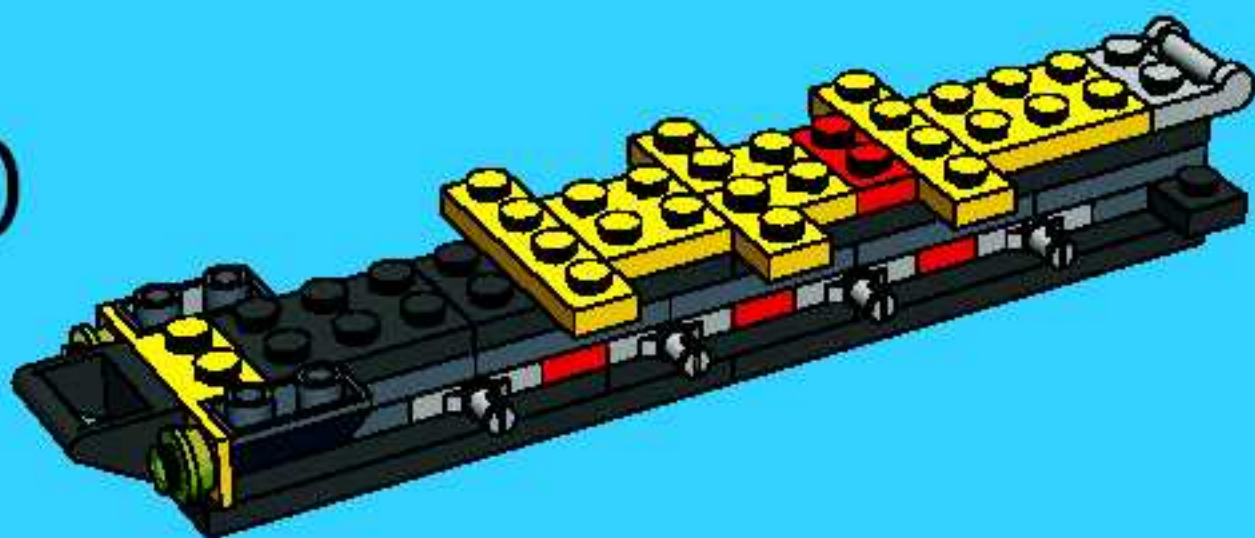

11

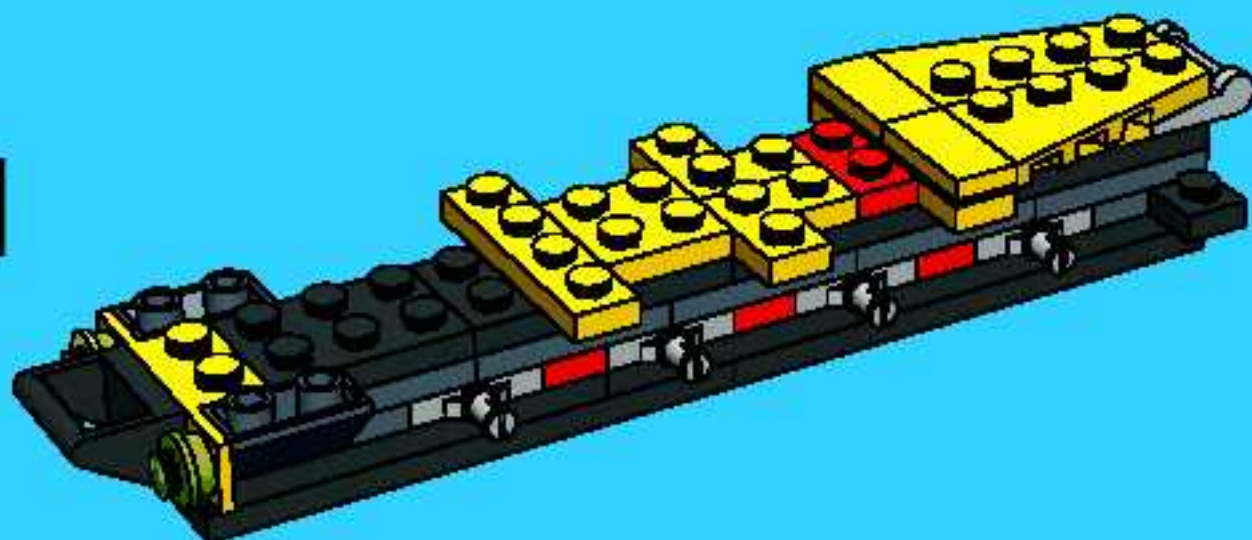

12

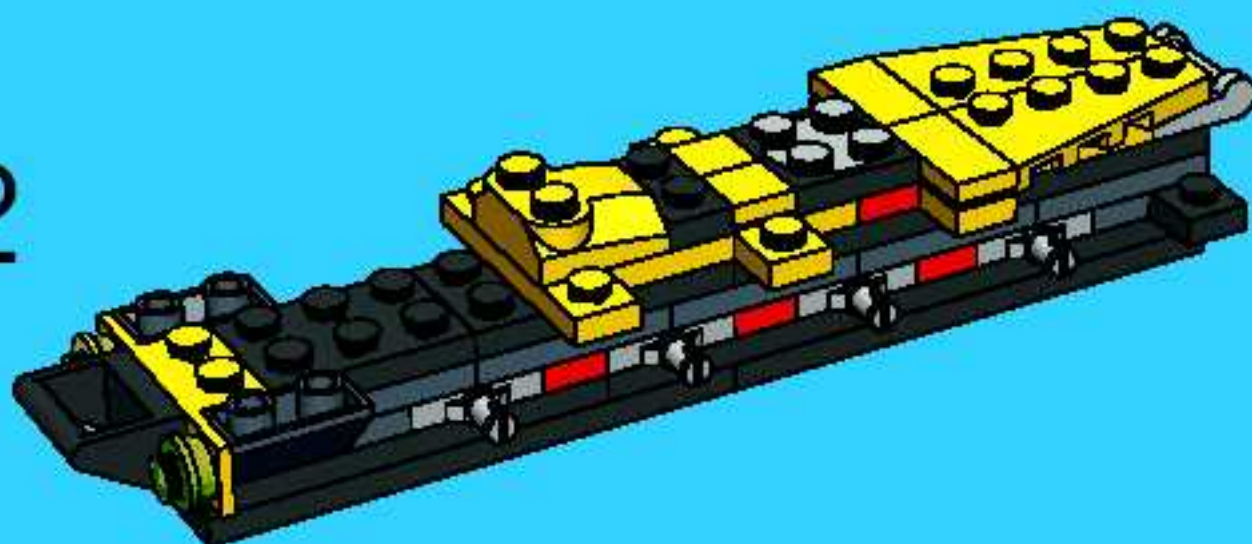

13

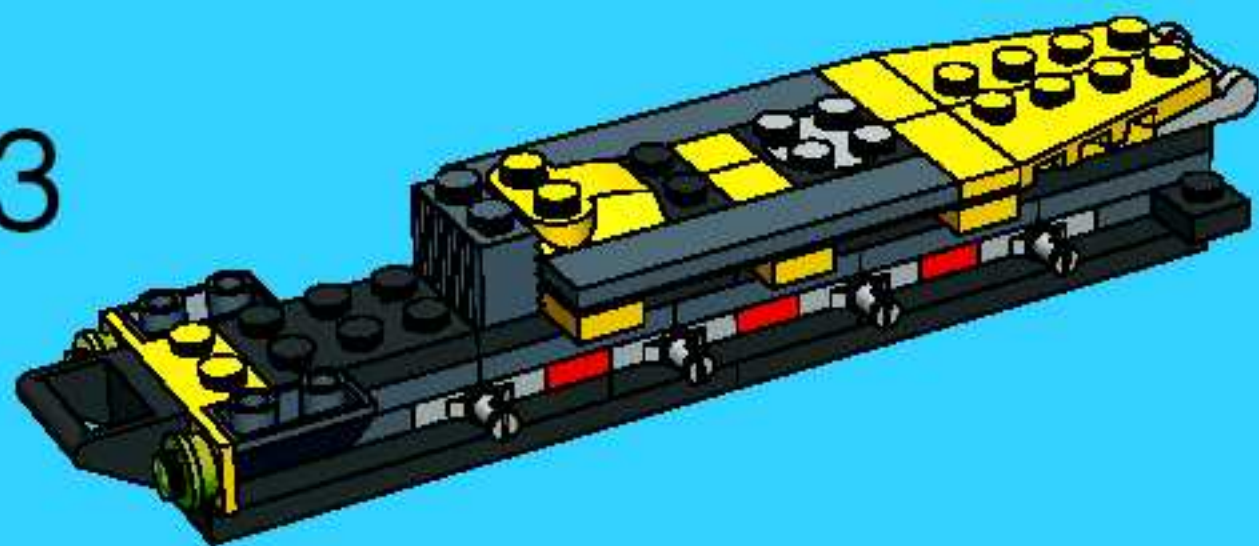

14

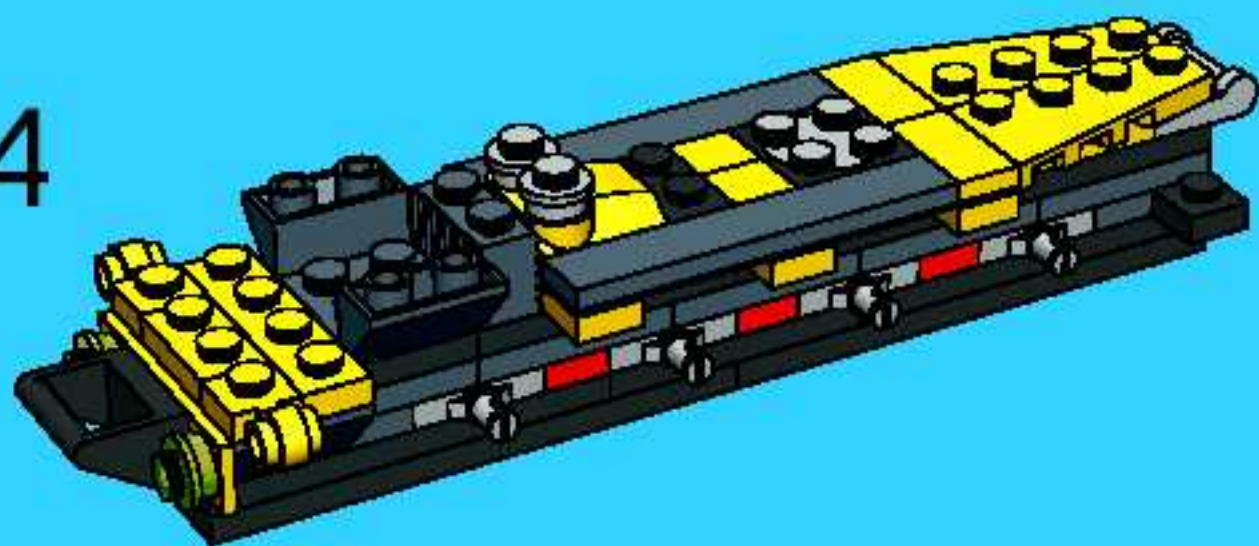



15

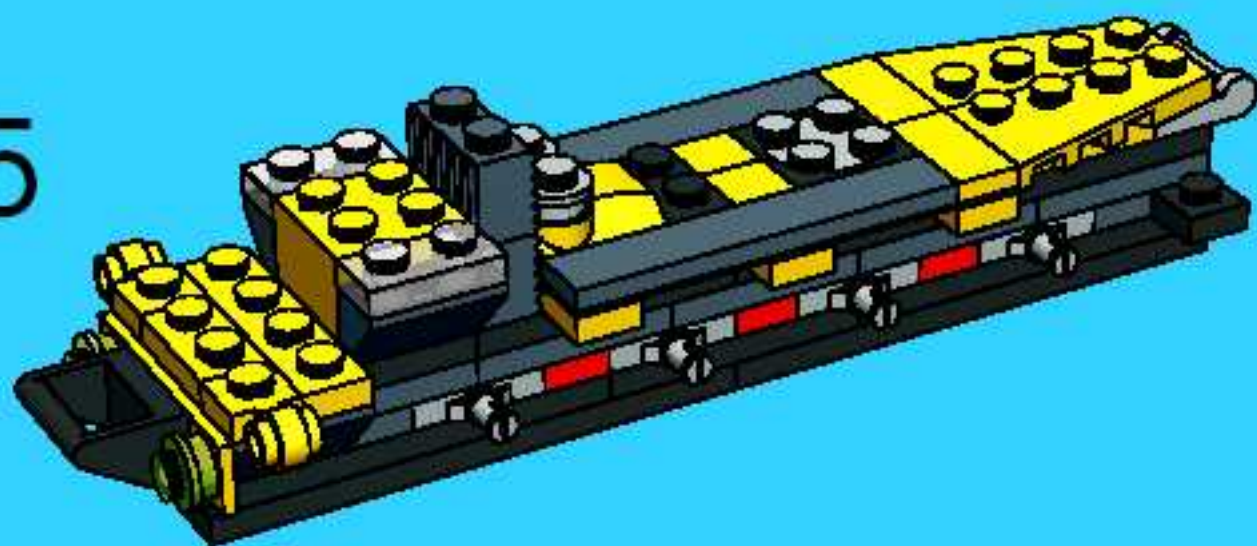

16

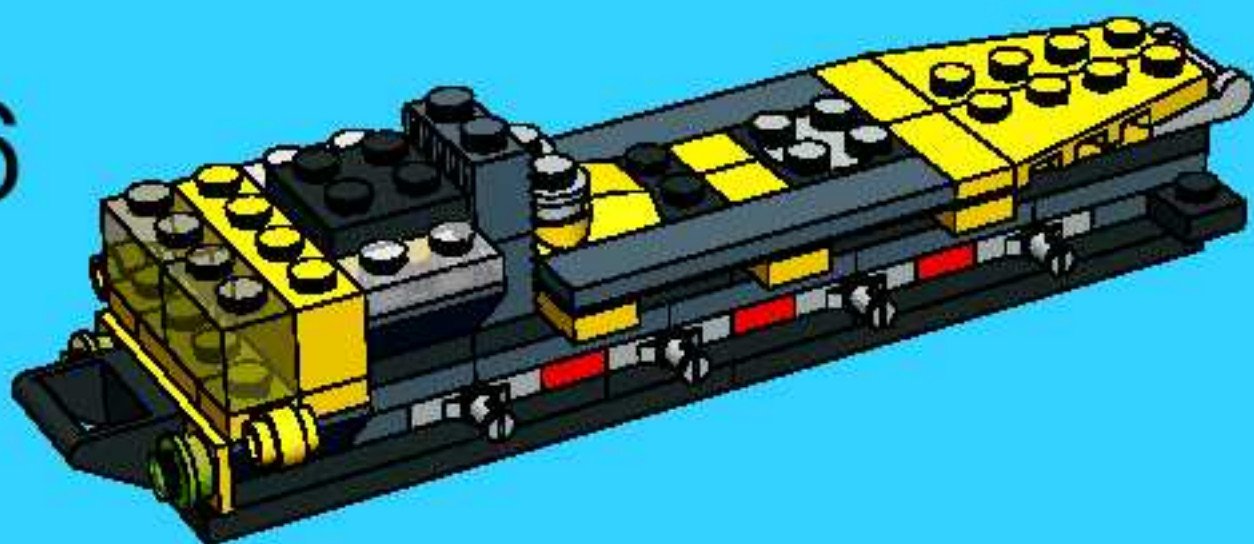

17

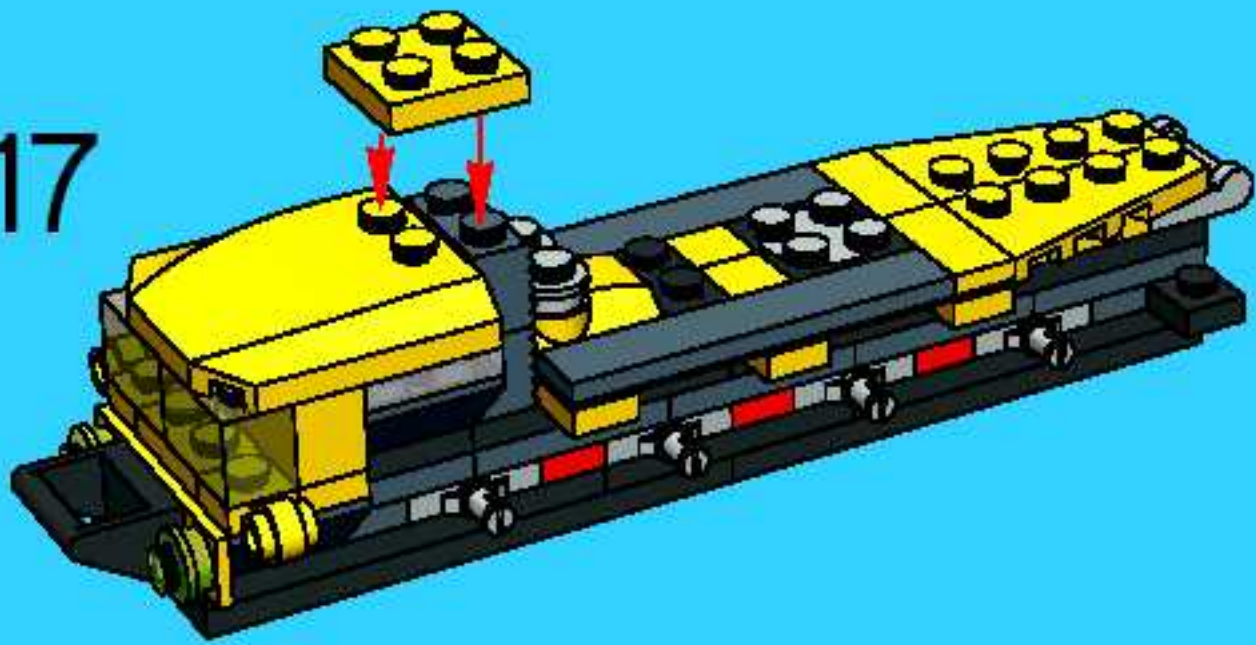

1

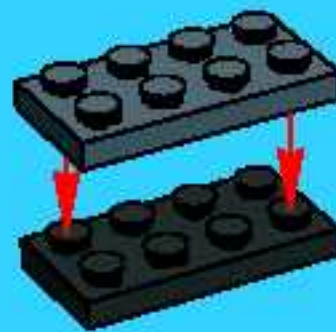

2





3



4



1

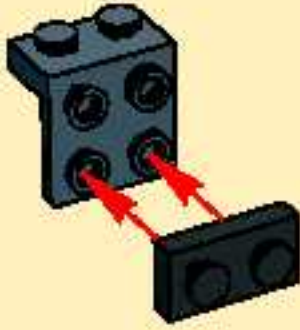

2



3



5



6

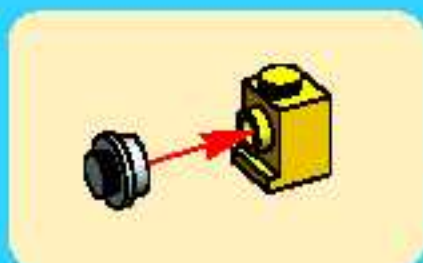
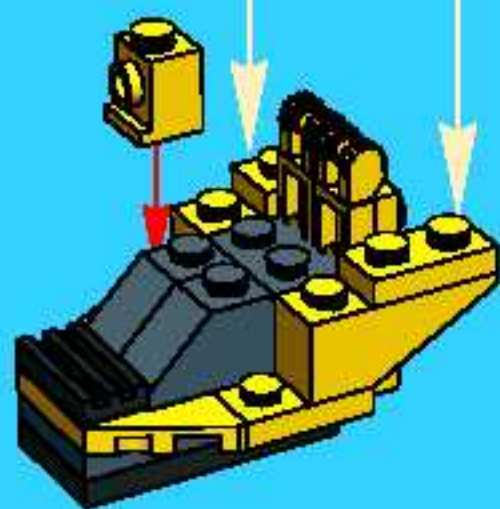

7



8

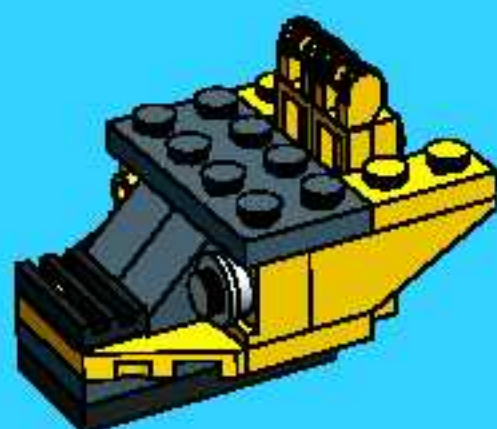



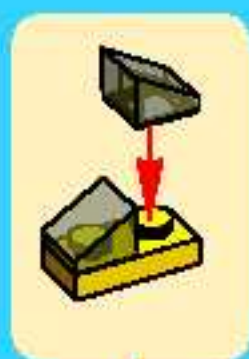

9

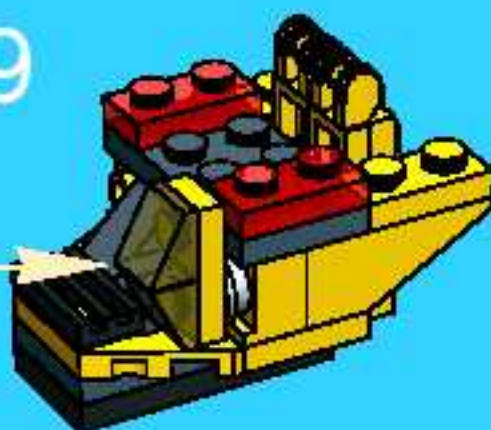

18

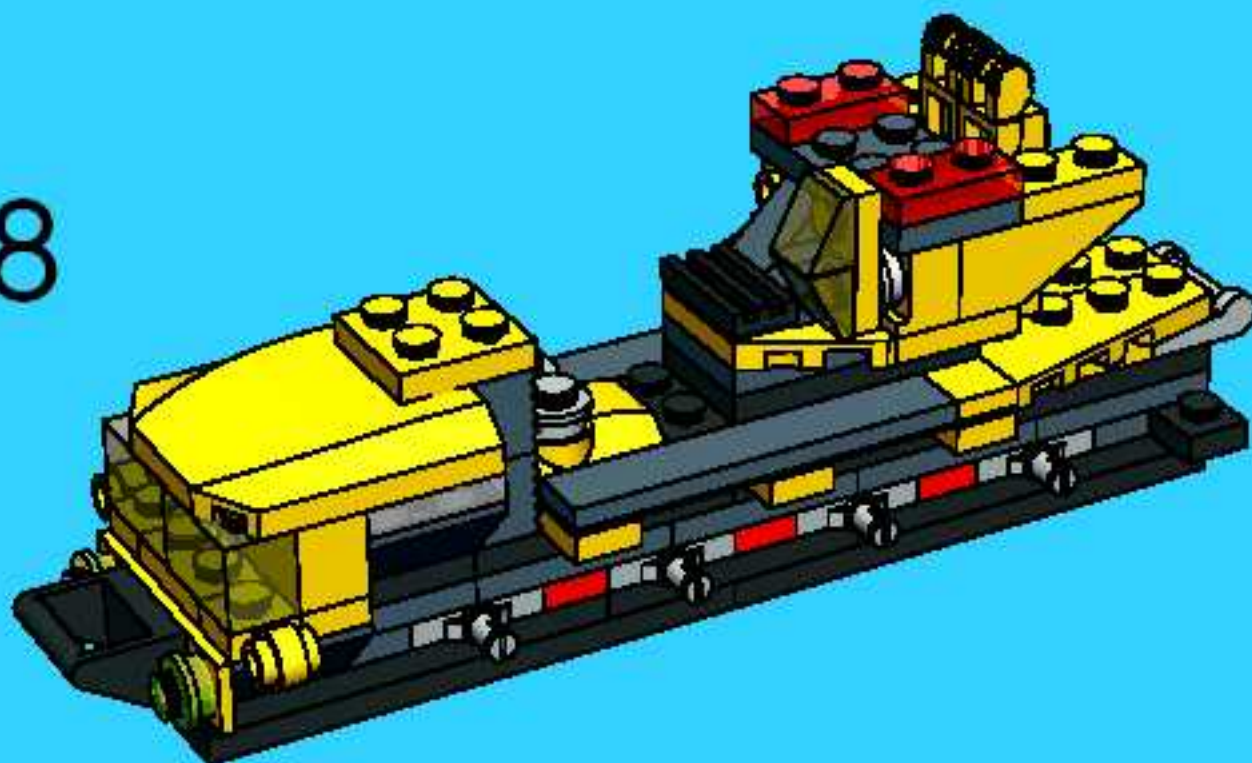

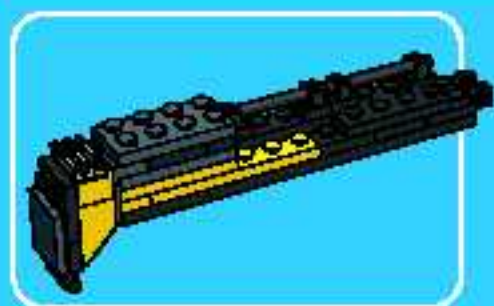

1



2

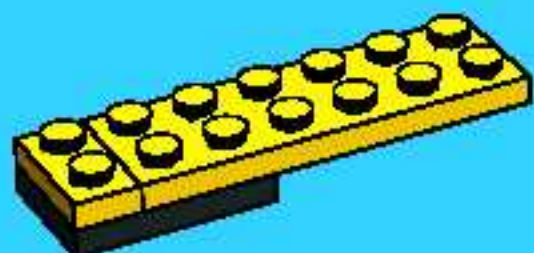

3



4





5



6

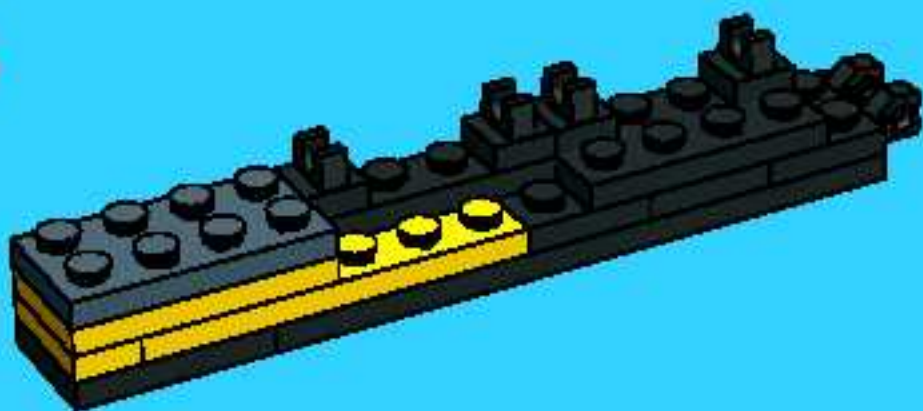

7

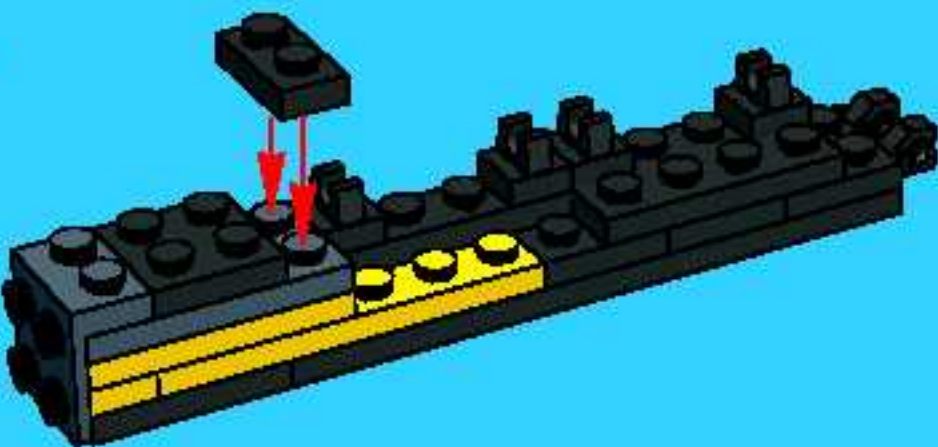

8

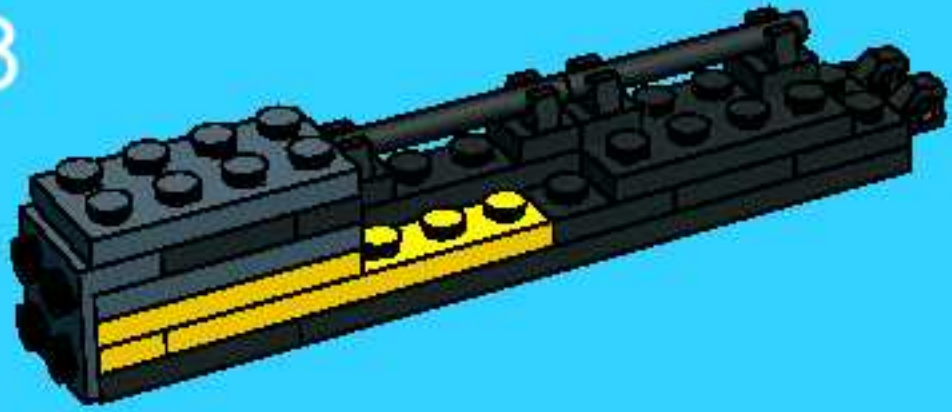

1



2



3

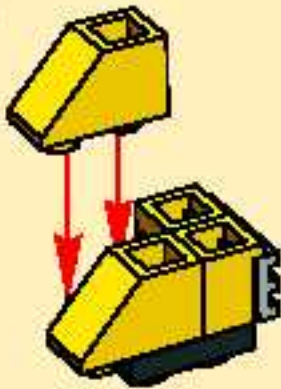

4



5



9

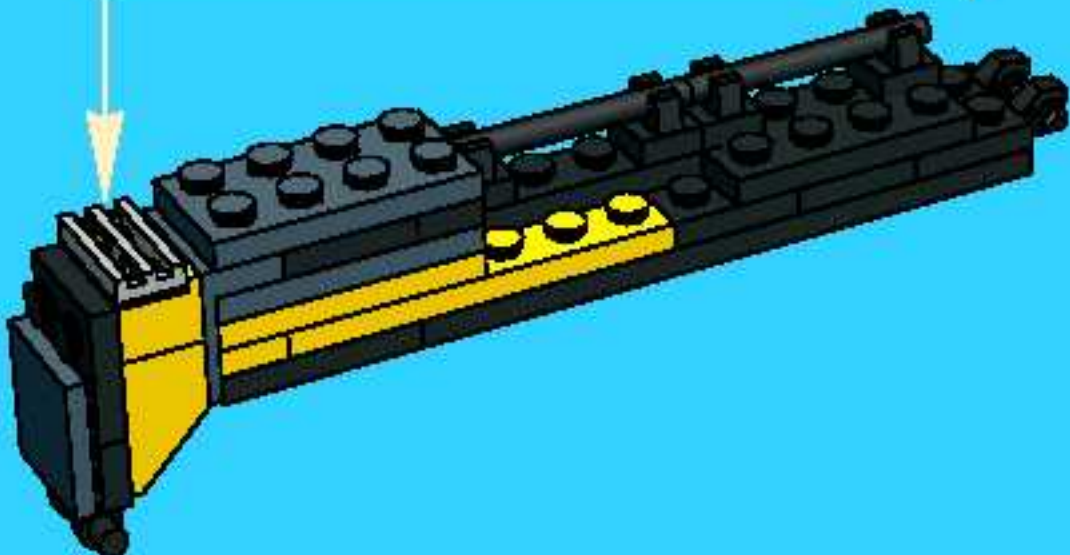



19

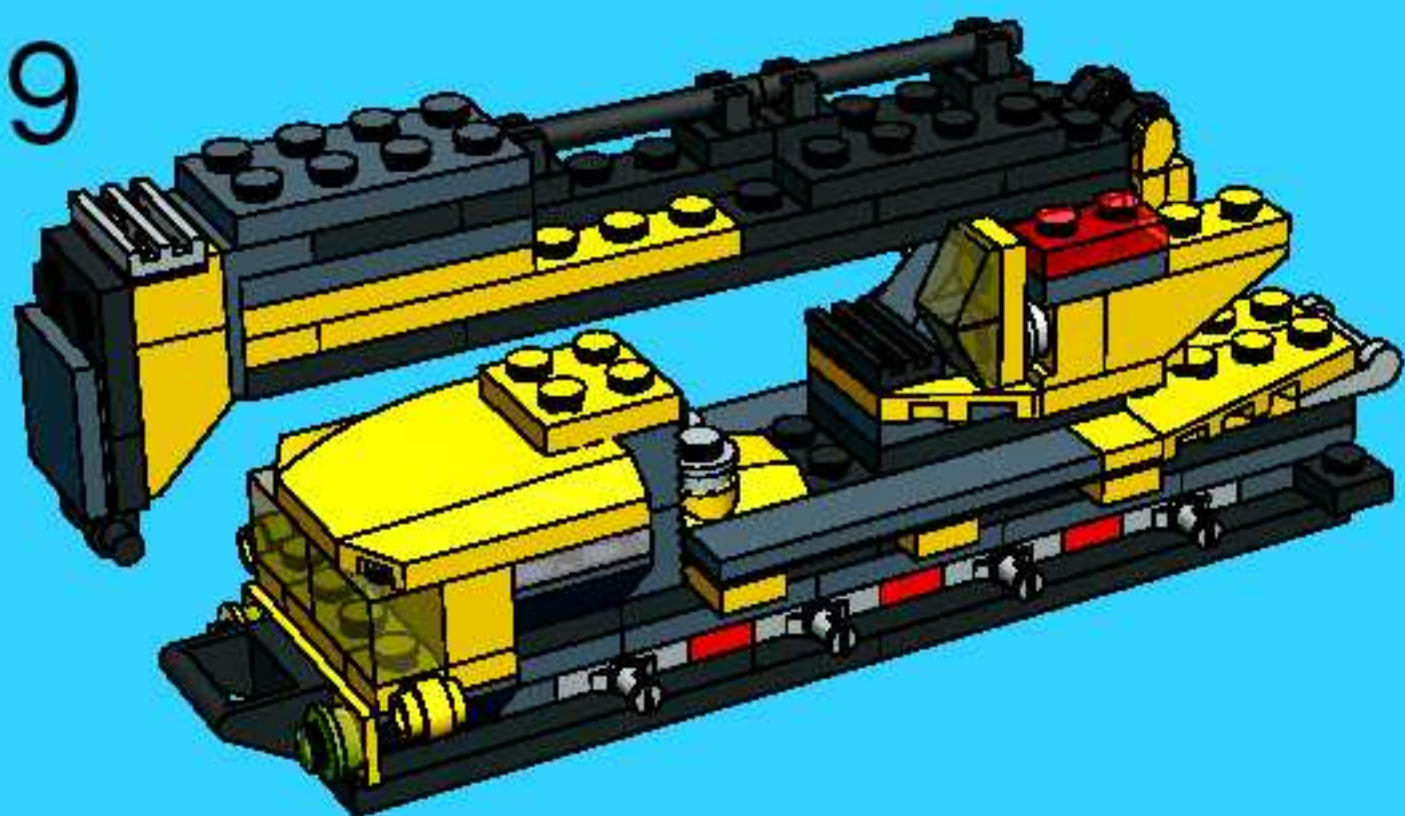

20

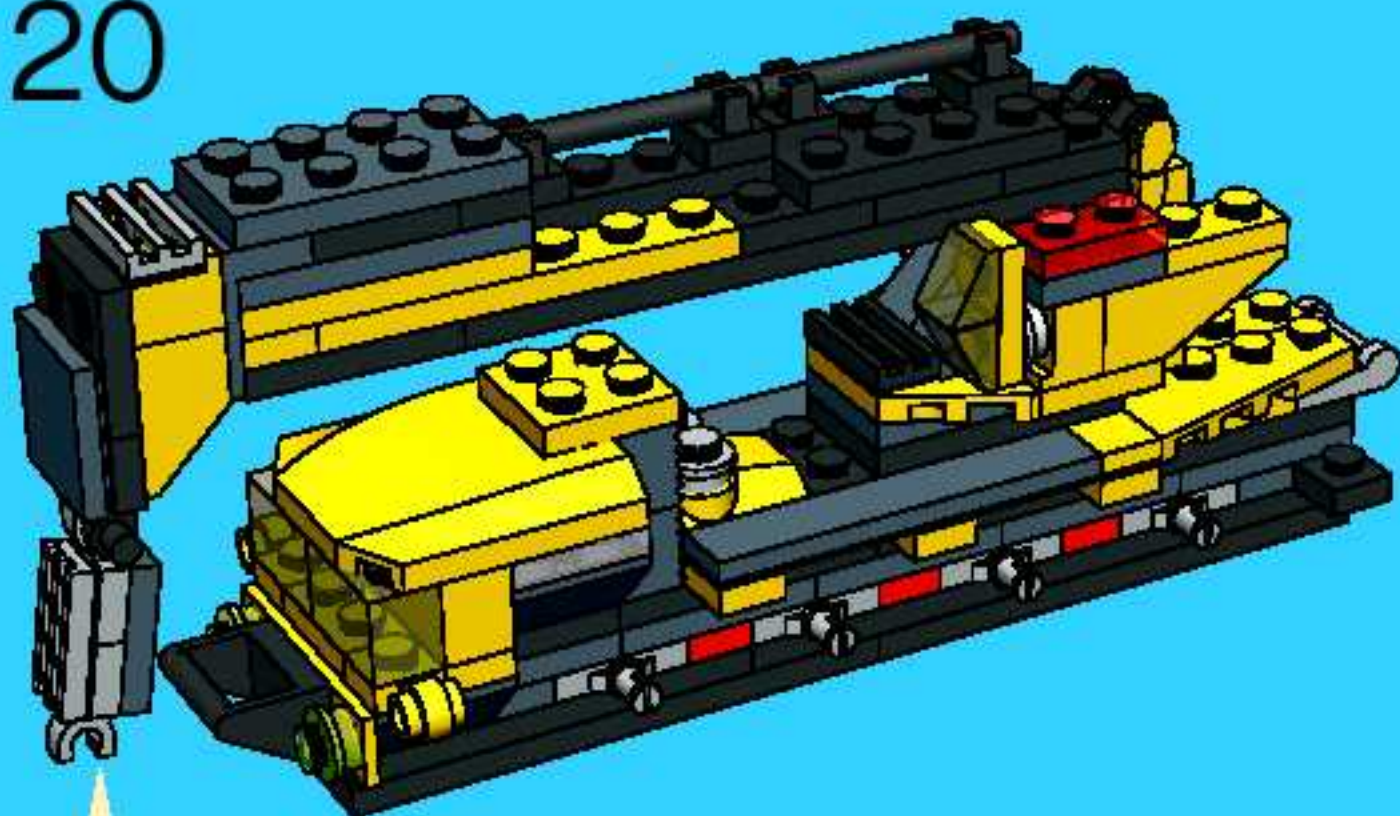

1



2



3





21



24









2x  
302021



2x  
302221



4x  
302321



2x  
306921



8x  
4211765



10x  
4211764



6x  
4244627



2x  
4211350



7x  
4211504



8x  
4211518



2x  
4211477



4x  
4211525



2x  
3005749



6x  
4244368



2x  
4226179



2x  
4217722



2x  
4201019



2x  
4167842



1x  
4221774



2x  
4210651

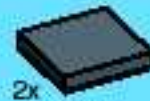

2x  
4211055



4x  
4211063



4x  
4211043



6x  
4211065



3x  
4211076



2x  
4211135



2x  
4210636



2x  
4244373



2x  
4277928





2x  
303426



2x  
379526



6x  
302026



2x  
302126



5x  
302226



6x  
302326



2x  
371026



2x  
447726



2x  
4140303



2x  
4183043



1x  
241226



1x  
4140588



4x  
255526



2x  
615726



1x  
243226



8x  
3002826



10 x  
601526



4x  
407024



1x  
4163718



2x  
4183981



2x  
408124



2x  
242024



2x  
428724



2x  
366524



1x  
300324



2x  
301024



1x  
4282745



2x  
302424



6x  
302324



3x  
371024



2x  
302224



2x  
302124



3x  
302024



1x  
379524



1x  
4161331

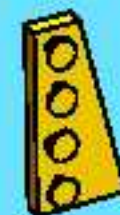

1x  
4160868



1x  
4260192



1x  
4193073



2x  
307024



3x  
306924



1x  
306824



Discover the **LEGO® UNIVERSE!**  
 Entdecke das **LEGO® UNIVERSUM!**  
 Découvre **L'UNIVERS LEGO® !**



FREE LEGO Magazines  
 KOSTENLOSE LEGO Magazine  
 Des Magazines LEGO GRATUITS !



**SHOP** at HOME



BIC26 BIC26 BI06U BI06U BI06F BI06C BI06C BI06C

Sign up now! Jetzt anmelden! Abonne-toi maintenant!

<http://club.LEGO.com/signup>

[www.LEGOshop.com/catalog](http://www.LEGOshop.com/catalog)



# Win!

## Gagne! 当たります

## Gewinne!

### Win LEGO products

We would like to know what you think about your new LEGO product. Log on to the web address below for further instructions.

### Gagne des produits LEGO

Nous aimerions savoir ce que tu penses de ton nouveau produit LEGO. Tu obtiendras davantage d'informations en visitant le site Internet indiqué ci-dessous.

### Gewinne LEGO produkte

Wir sind sehr an deiner Meinung über dein neues LEGO Produkt interessiert. Gehe einfach zu der unten angegebenen Webadresse – dort findest du weitere Informationen.

### Estimado usuario LEGO

Al contestar algunas preguntas en inglés, francés, alemán o japonés, en el sitio [www.acnielsen.aim.dk/lego](http://www.acnielsen.aim.dk/lego), podrás participar en el sorteo de algunos valiosos premios LEGO.

### Caro Consumidor da LEGO

Ao responder a algumas perguntas em Inglês, Francês, Alemão ou Japonês no endereço [www.acnielsen.aim.dk/lego](http://www.acnielsen.aim.dk/lego) irá participar num concurso para ganhar valiosos prémios da LEGO.

### Kedves ifjú LEGO Vásárló

Ha ellátogatsz a [www.acnielsen.aim.dk/lego](http://www.acnielsen.aim.dk/lego) honlapra és ott angol, francia, német vagy japán nyelven megválaszolsz néhány kérdést, akkor részt veszel egy versenyben, amelyben értékes LEGO díjakat nyerhetsz.

### 抽選でLEGO製品が当たります

私たちは、皆様がご購入いただいたLEGO製品についてどんな感想をお持ちか、知りたいと思っています。質問に答えて、素晴らしいLEGO製品の抽選に応募してください。アンケートの回答には、あなたの名前どしかがかりません。詳しくは、以下のウェブアドレスまでアクセスしてください。

[www.acnielsen.aim.dk/LEGO](http://www.acnielsen.aim.dk/LEGO)



Any questions regarding your new LEGO product, please contact:

Customer Service

Kundenservice

Service Consommateurs

Servicio Al Consumidor at

[www.lego.com/service](http://www.lego.com/service)







# CREATOR



4892



4417



4416



4418



4415



4292939

©2006 The LEGO Group.