



6164



Pictured models cannot be built simultaneously

Die abgebildeten Modelle lassen sich nicht gleichzeitig bauen

Les modèles présentés ne peuvent pas être construits simultanément

I modelli illustrati non possono essere costruiti simultaneamente

De afgebeelde modellen zijn niet tegelijkertijd te bouwen

Los modelos ilustrados no pueden construirse simultáneamente

De vasts modeller kan kun byggas én ad gangen

Kuvissa näkyvät mallit voidaan rakentaa yksi kerrallaan

Modellerna som visas kan inte byggas samtidigt

De modelos nse imogens não podem ser construídas em simultâneo

Tq jorvákó nny mteknv/ovraí ósv juropógv va katarakuzuarrovúv tautógvova

A képek jstíthető modelleként nem építhetők meg egyszerre

35



14



5



30



10



44



1

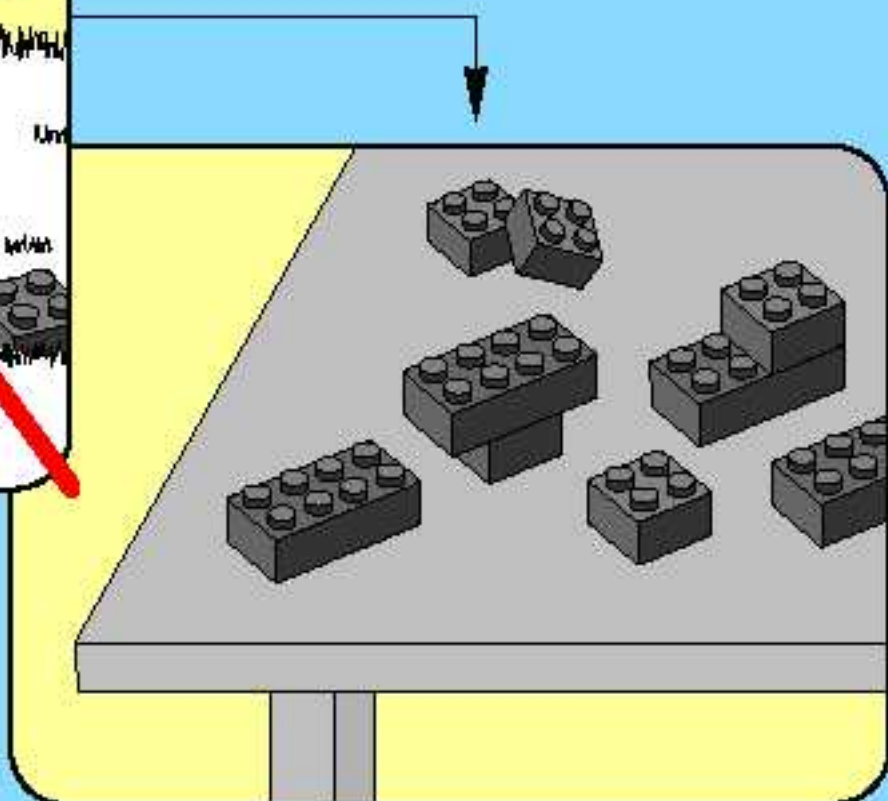
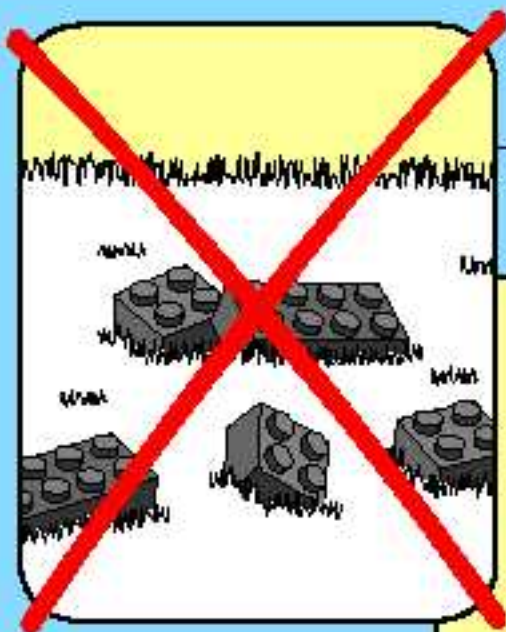

2



3

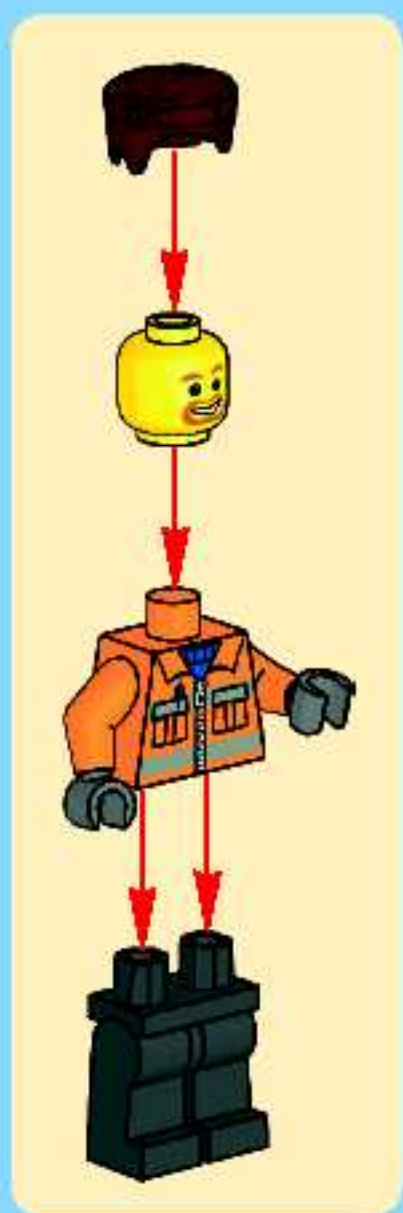



1

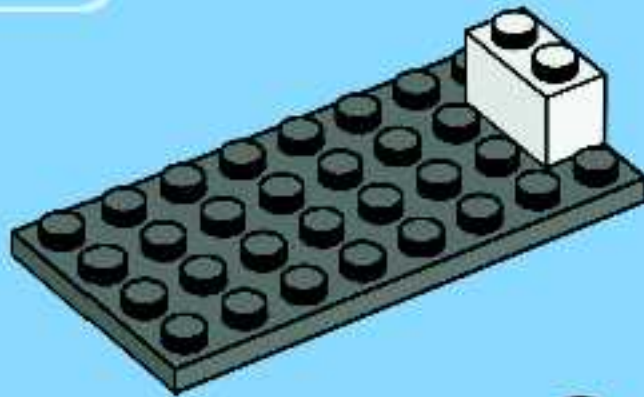

2

2

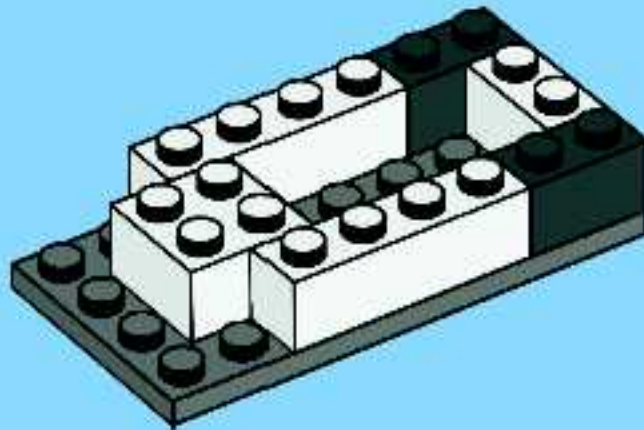

3

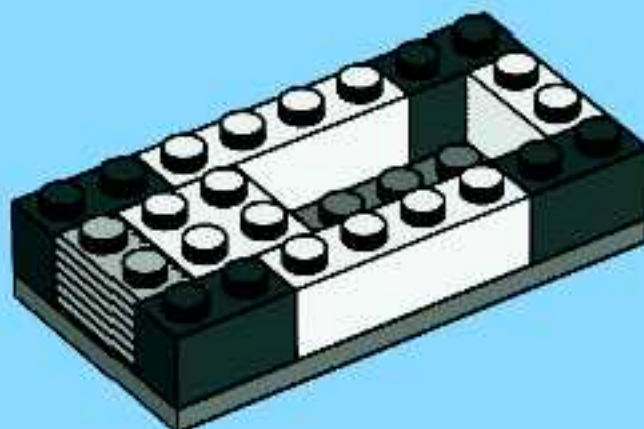

4

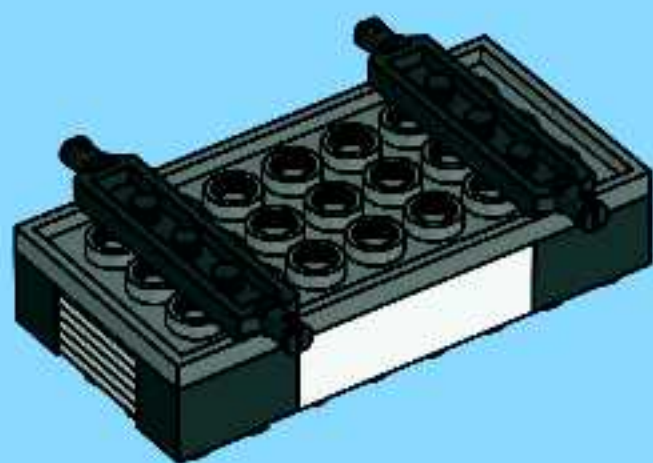

5

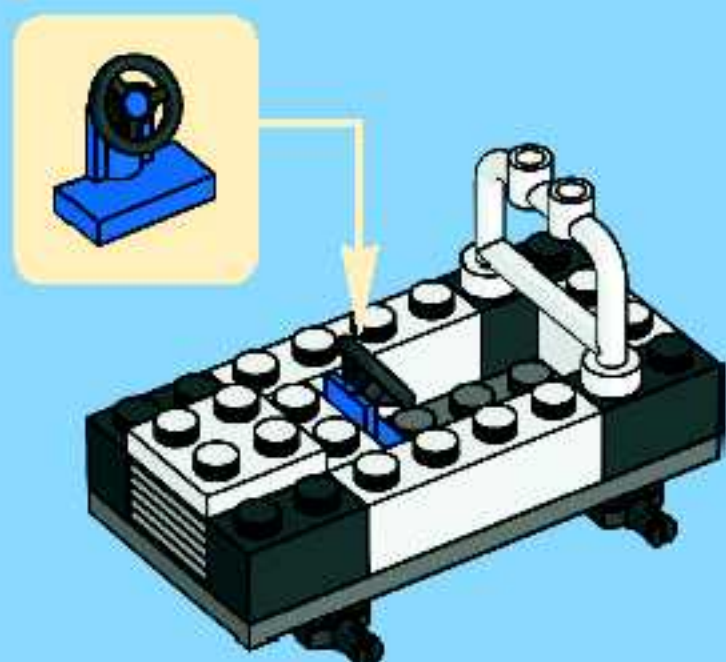

6



7

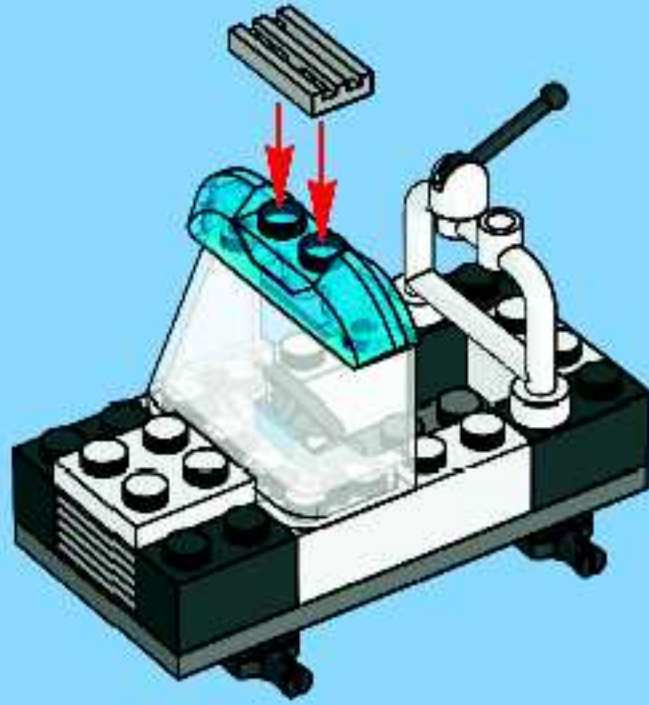

8

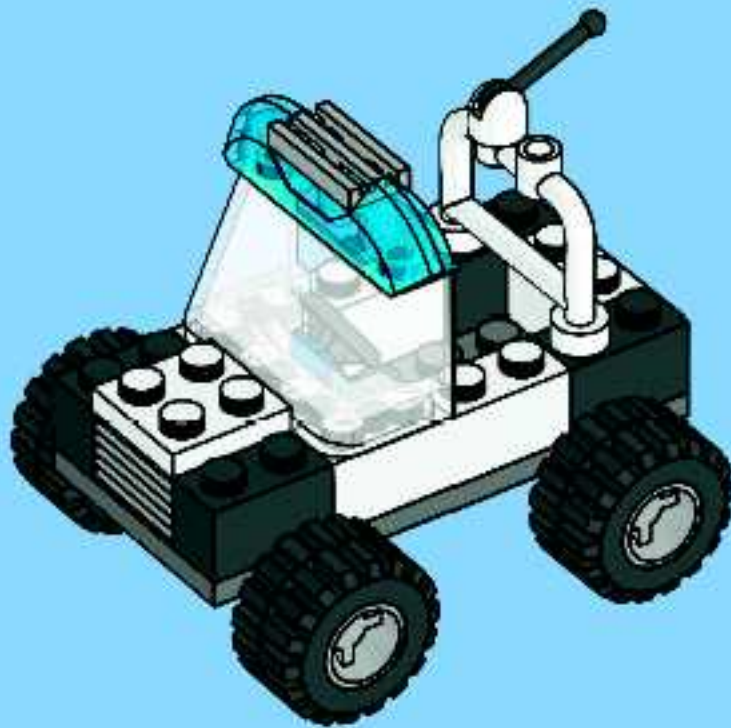







1

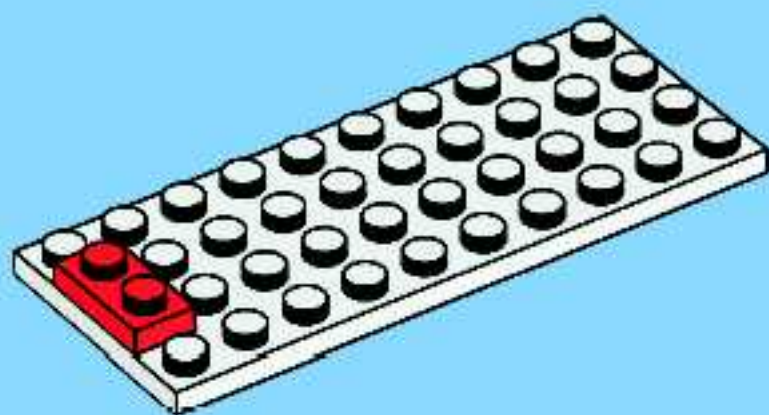

2

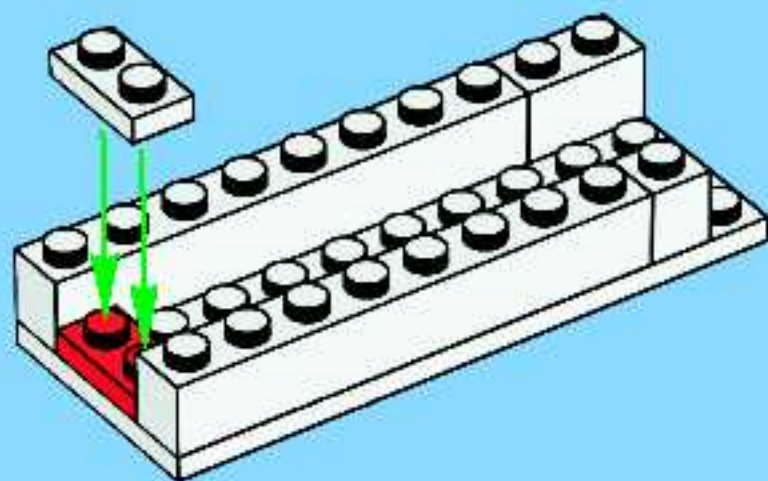

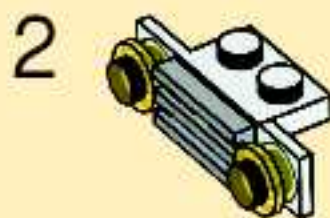
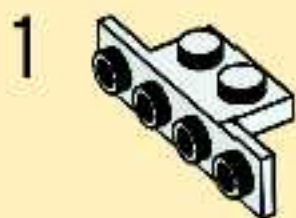

3

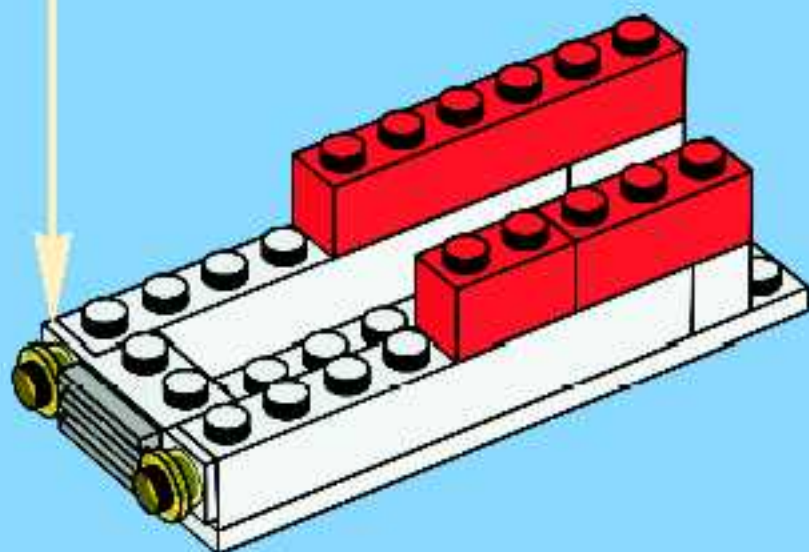

4

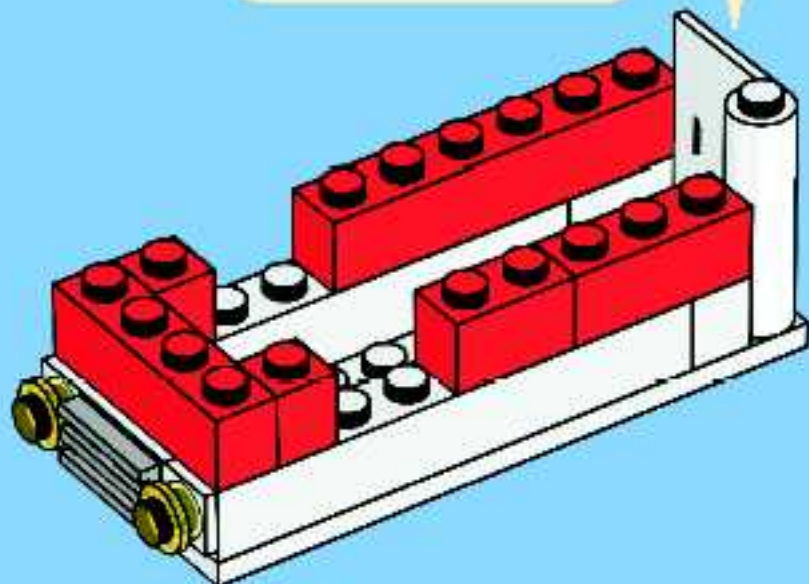
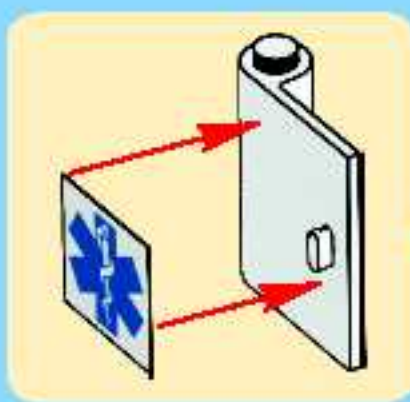

5

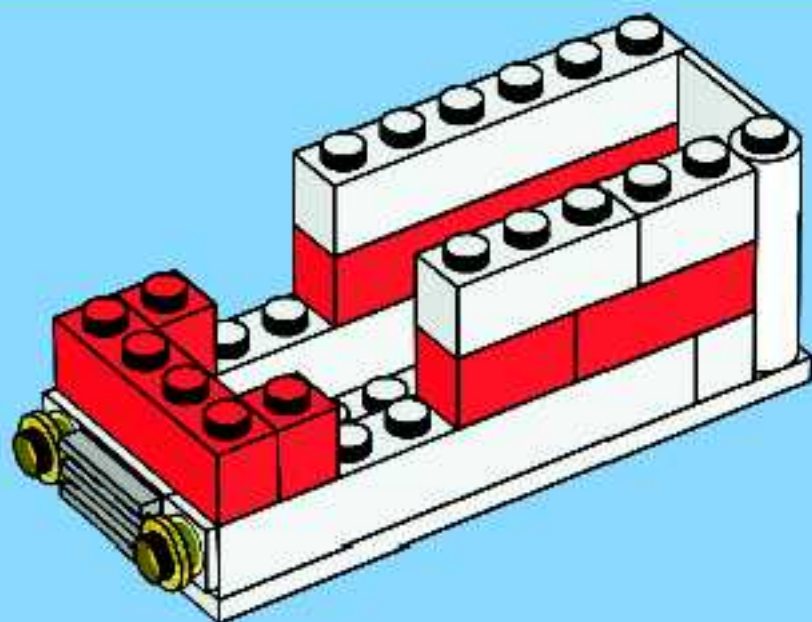

6

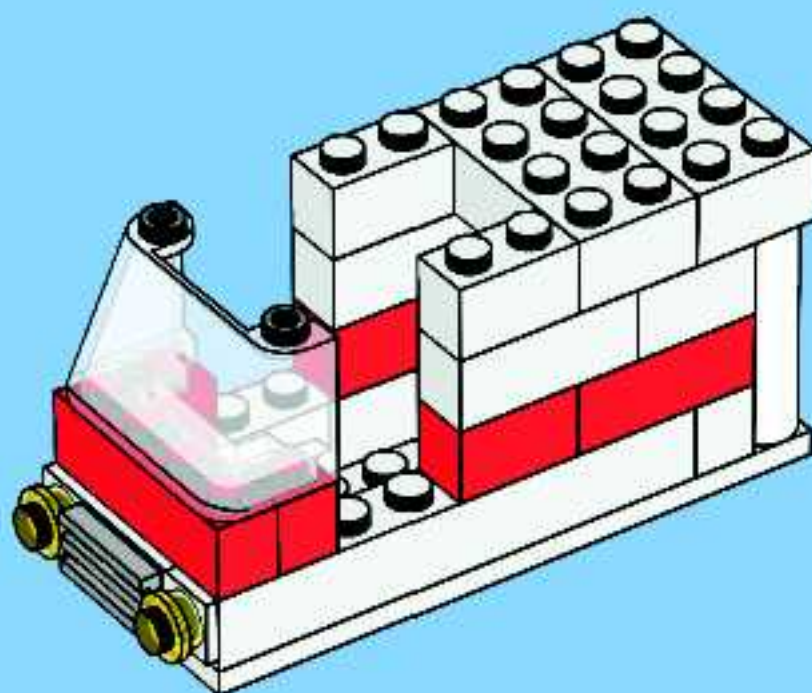

7

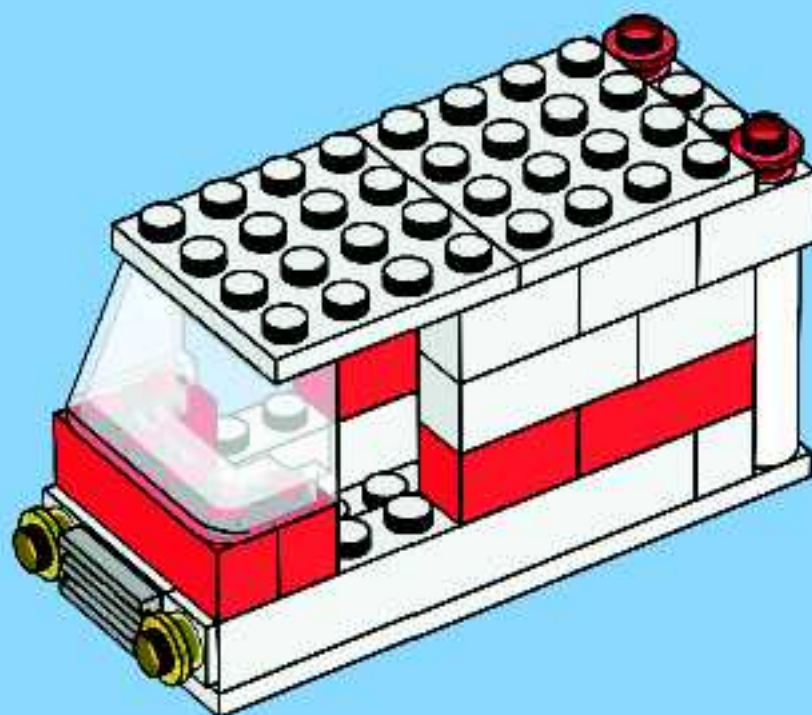

8

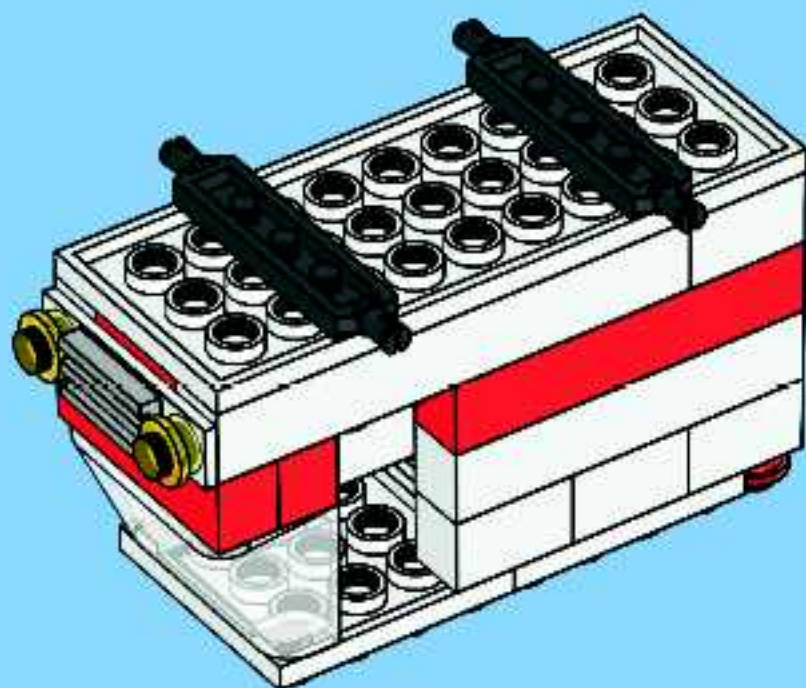

9

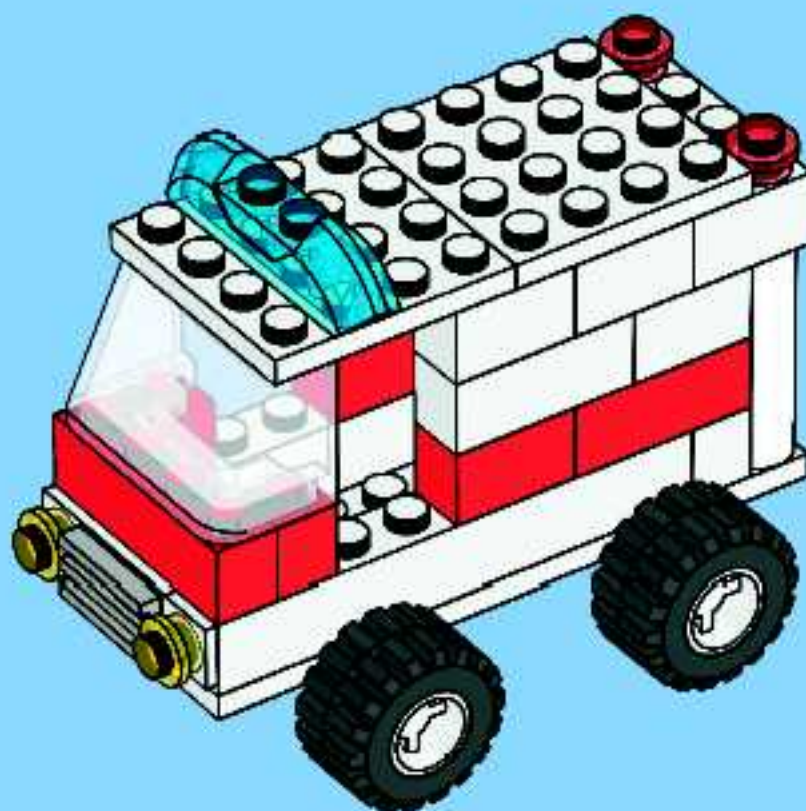



1

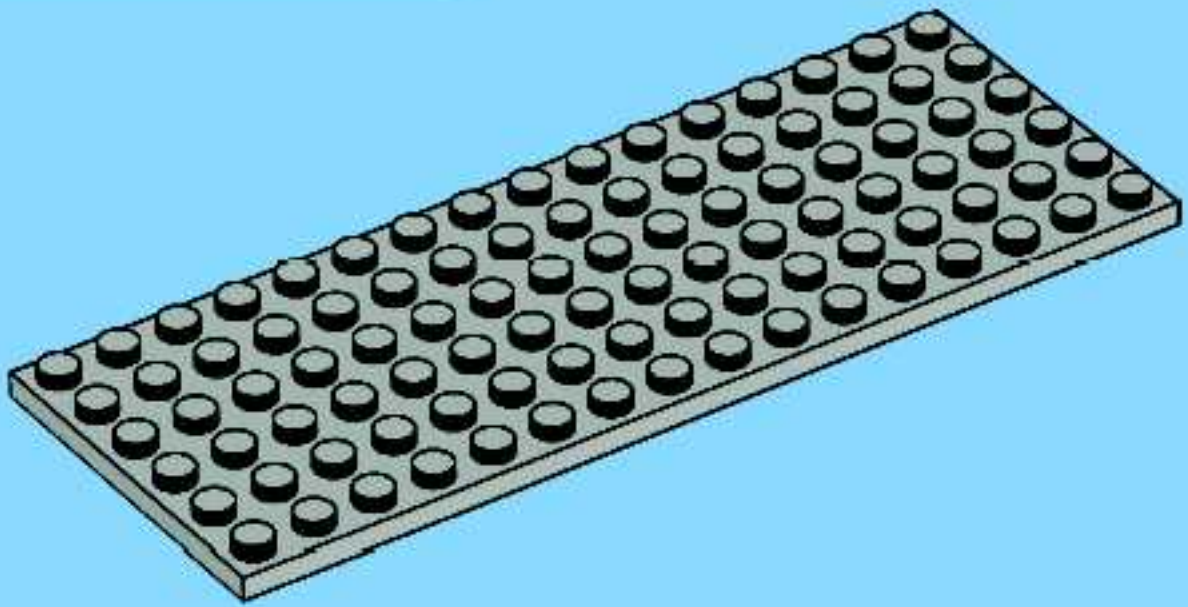

2

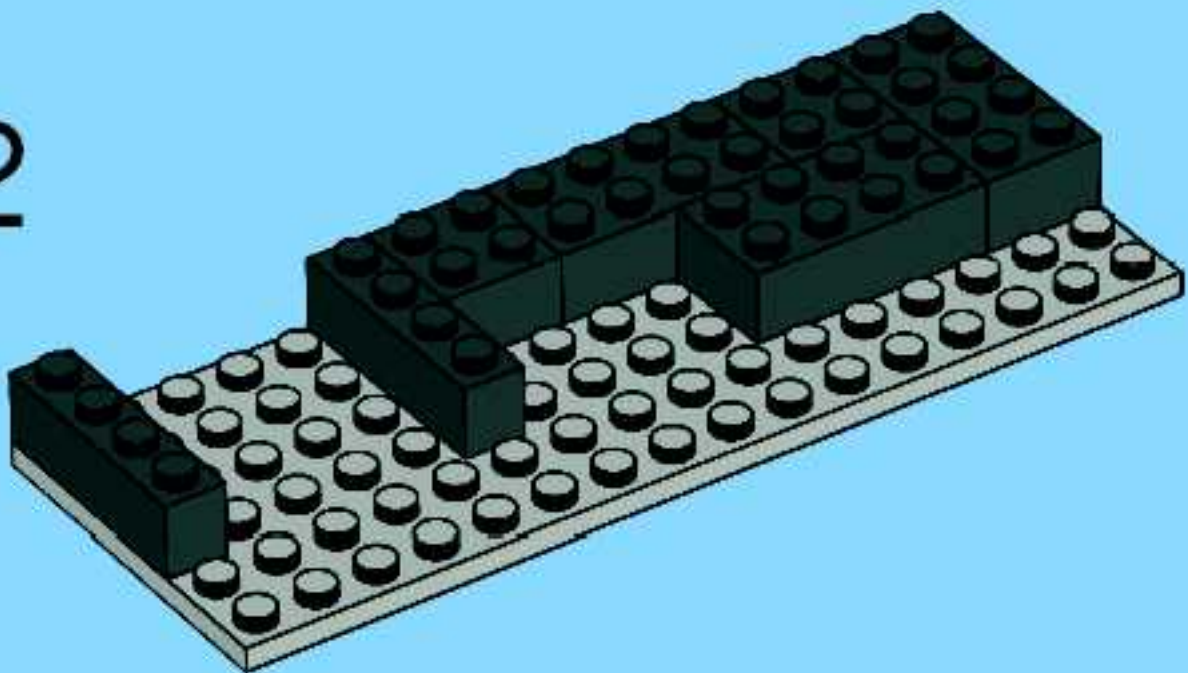

3

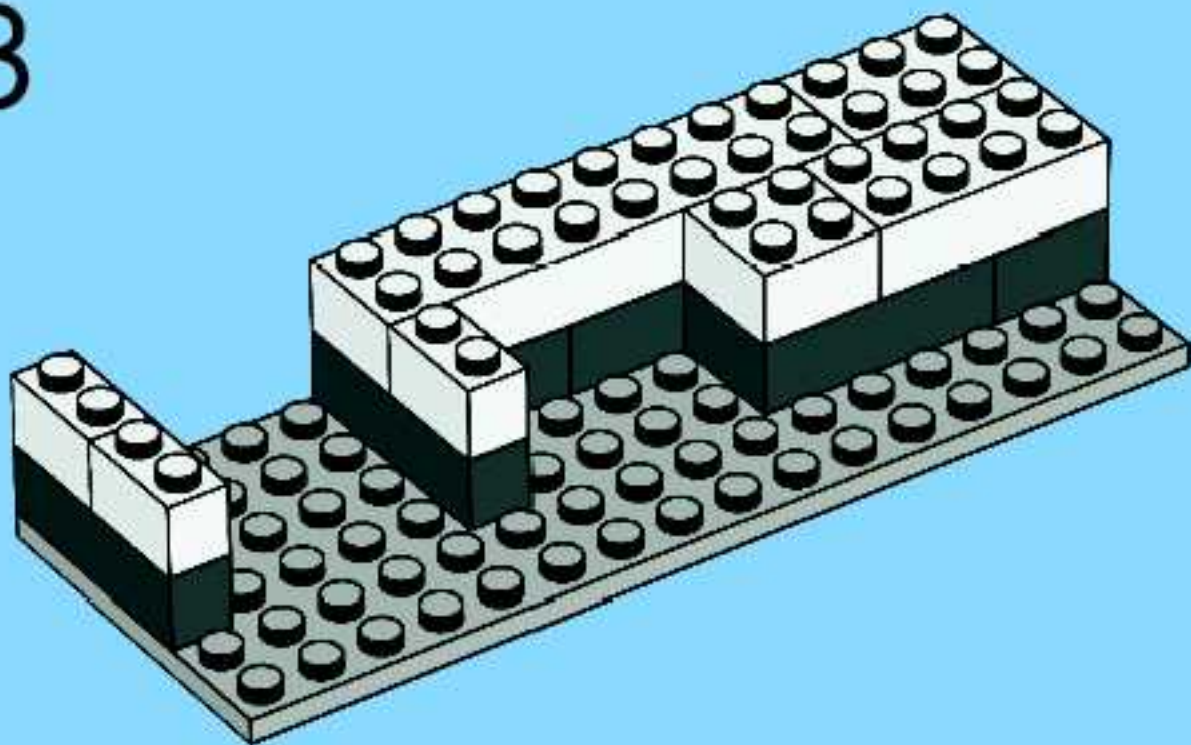

4

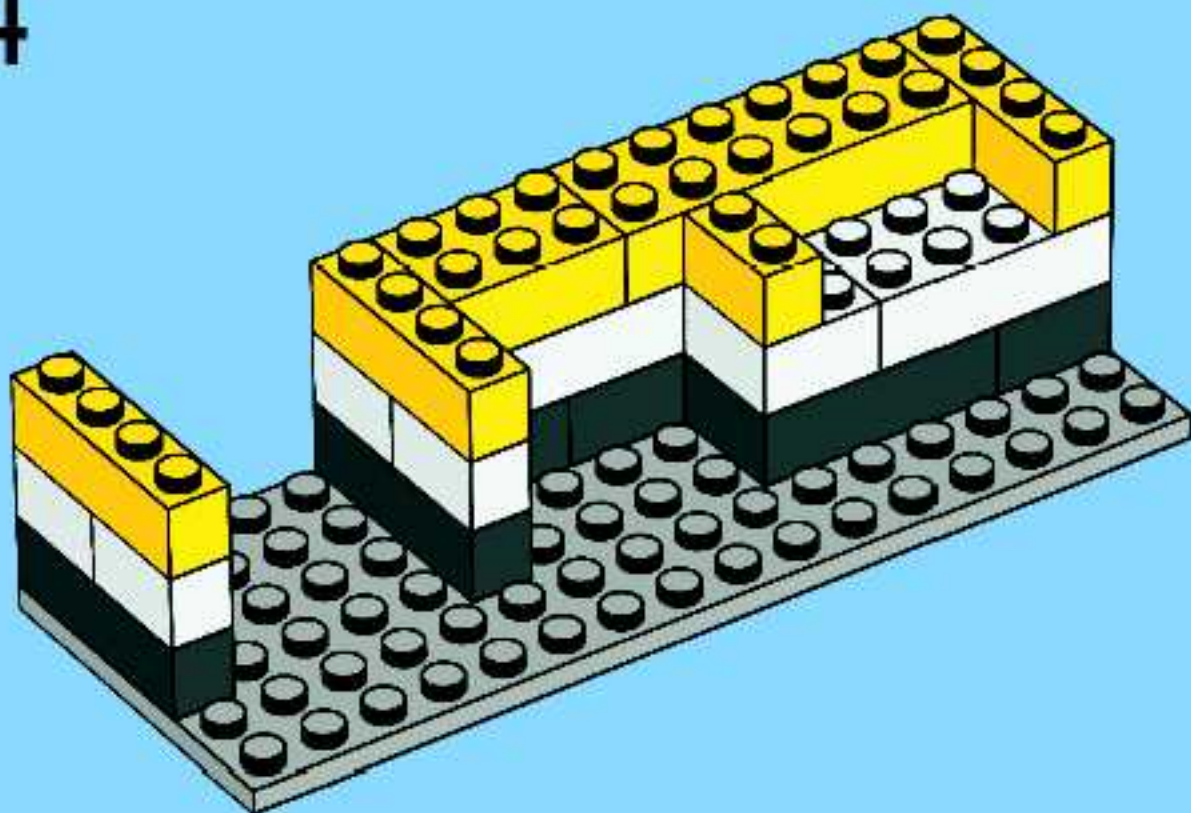

5

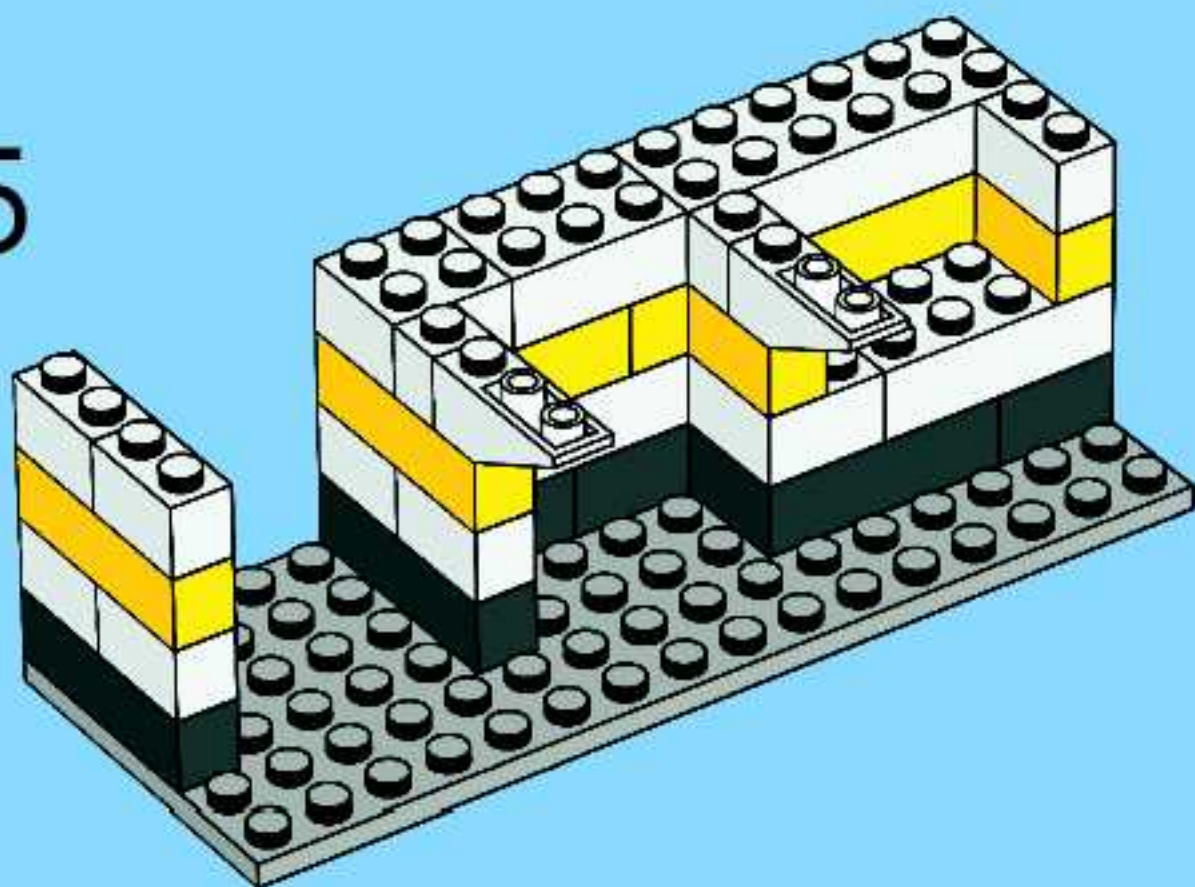

6

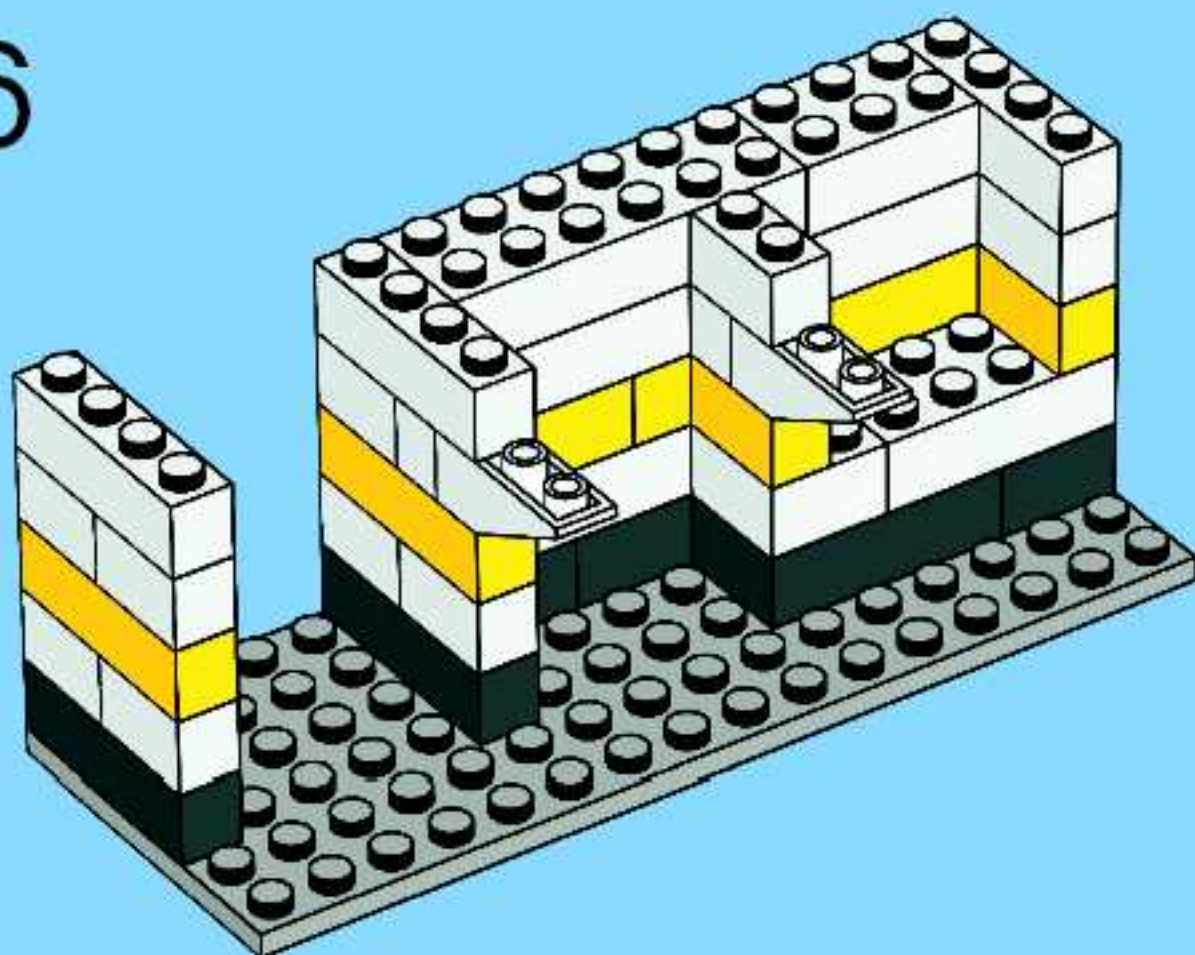

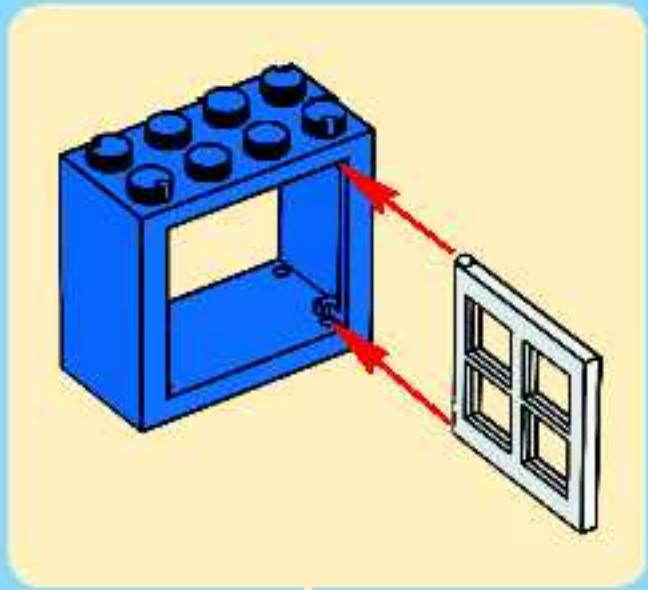
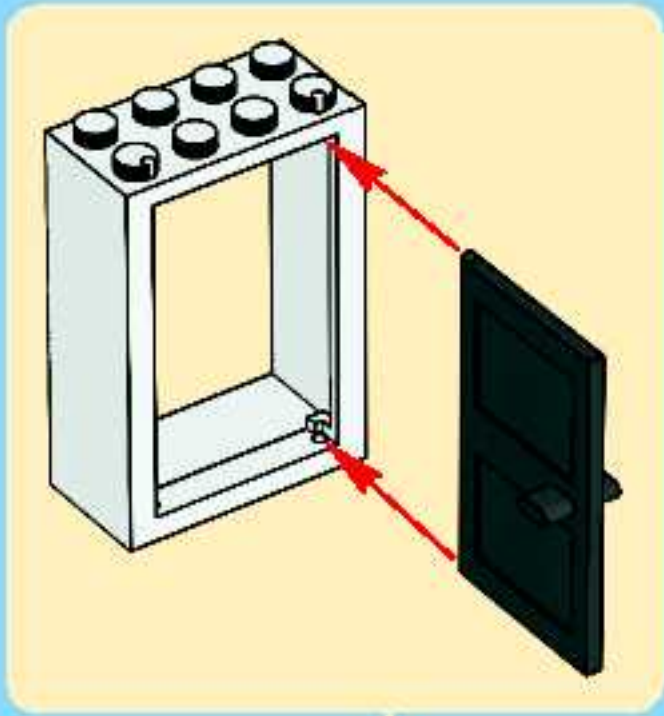

7

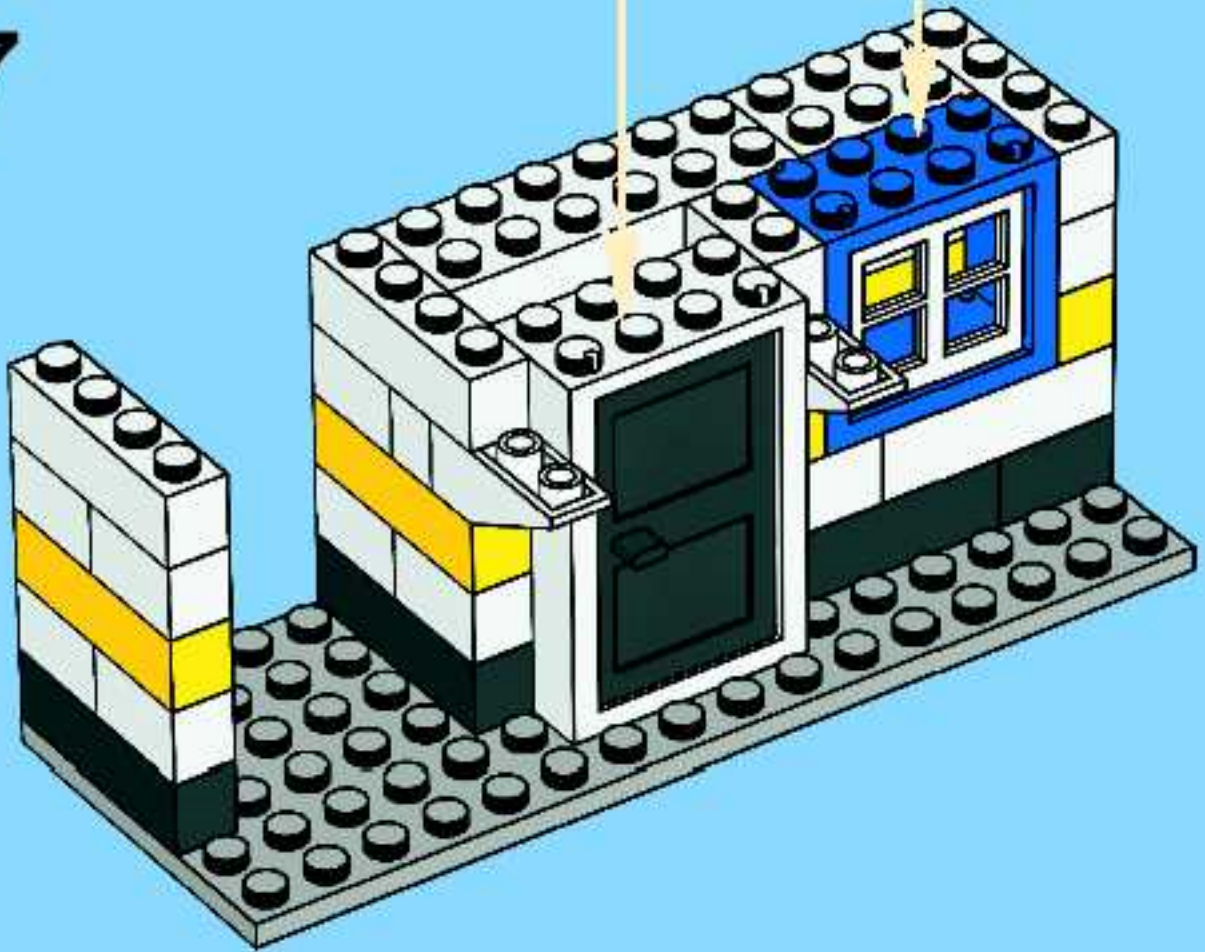

8

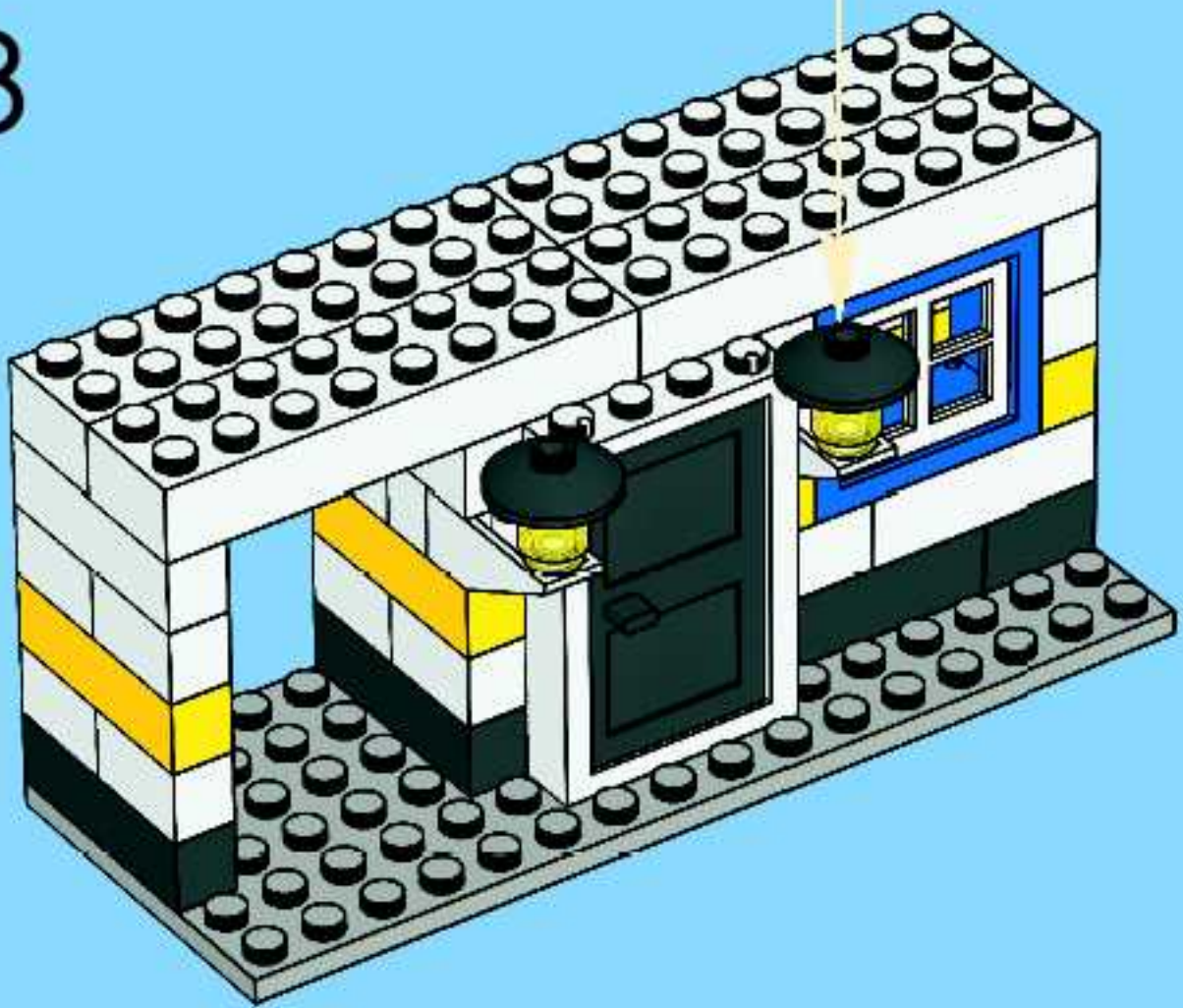
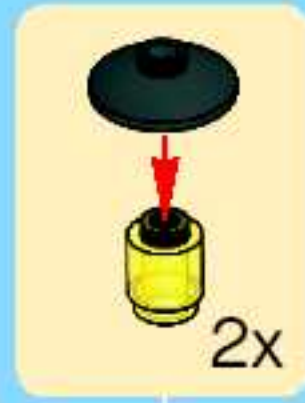

9

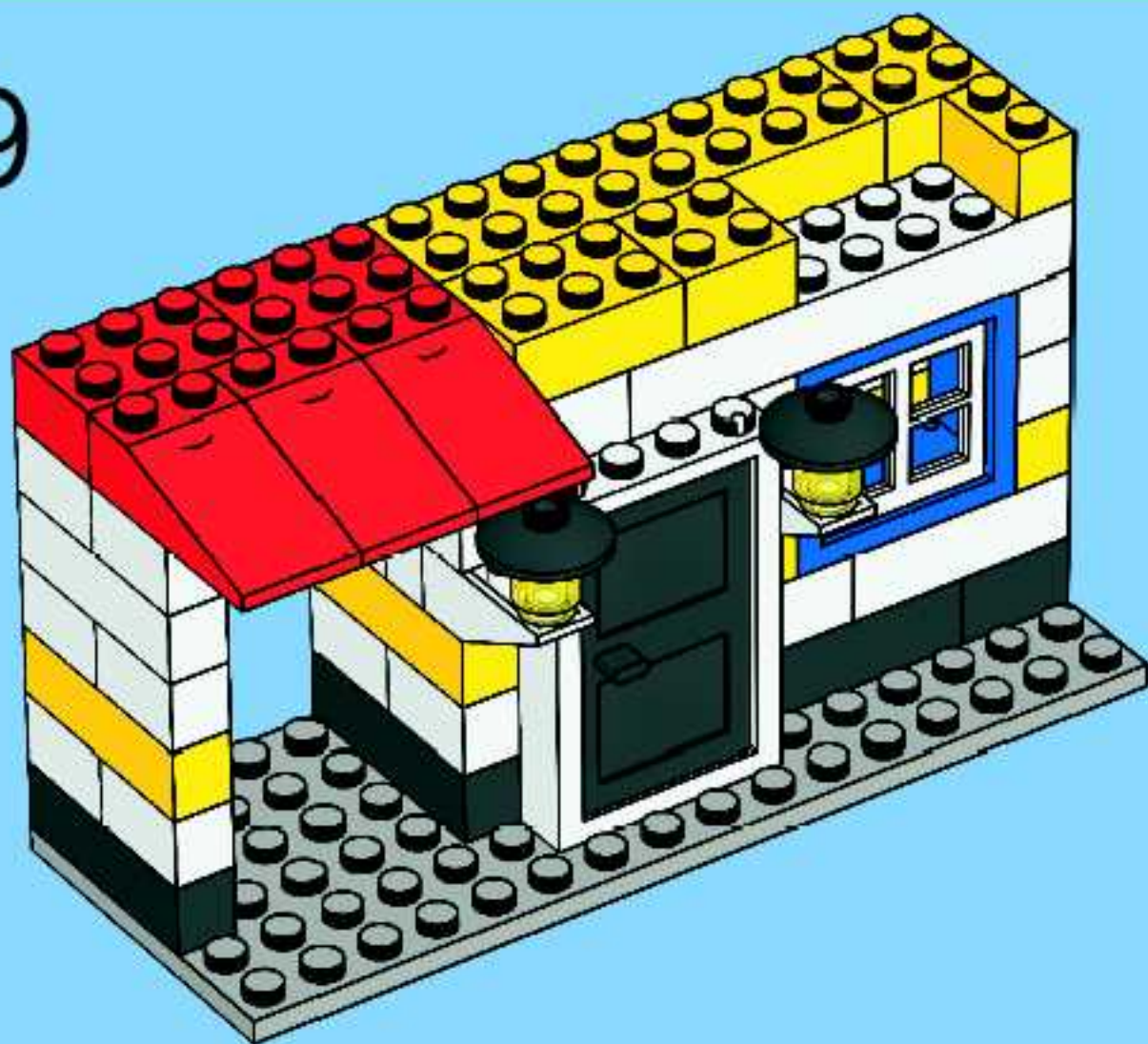

10



11



12

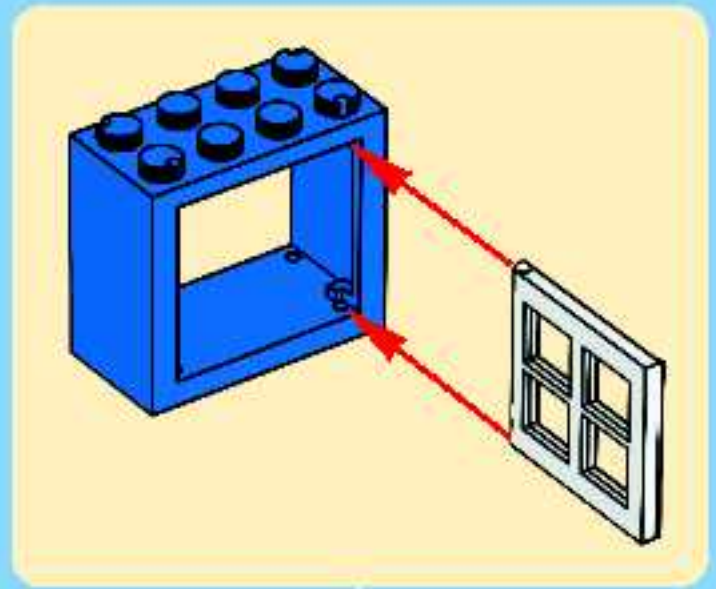

1

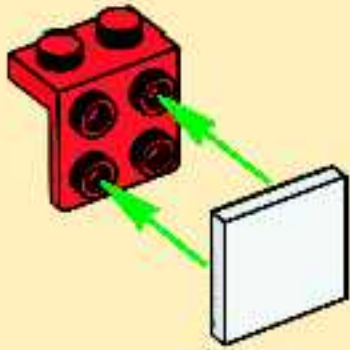

2



13



14

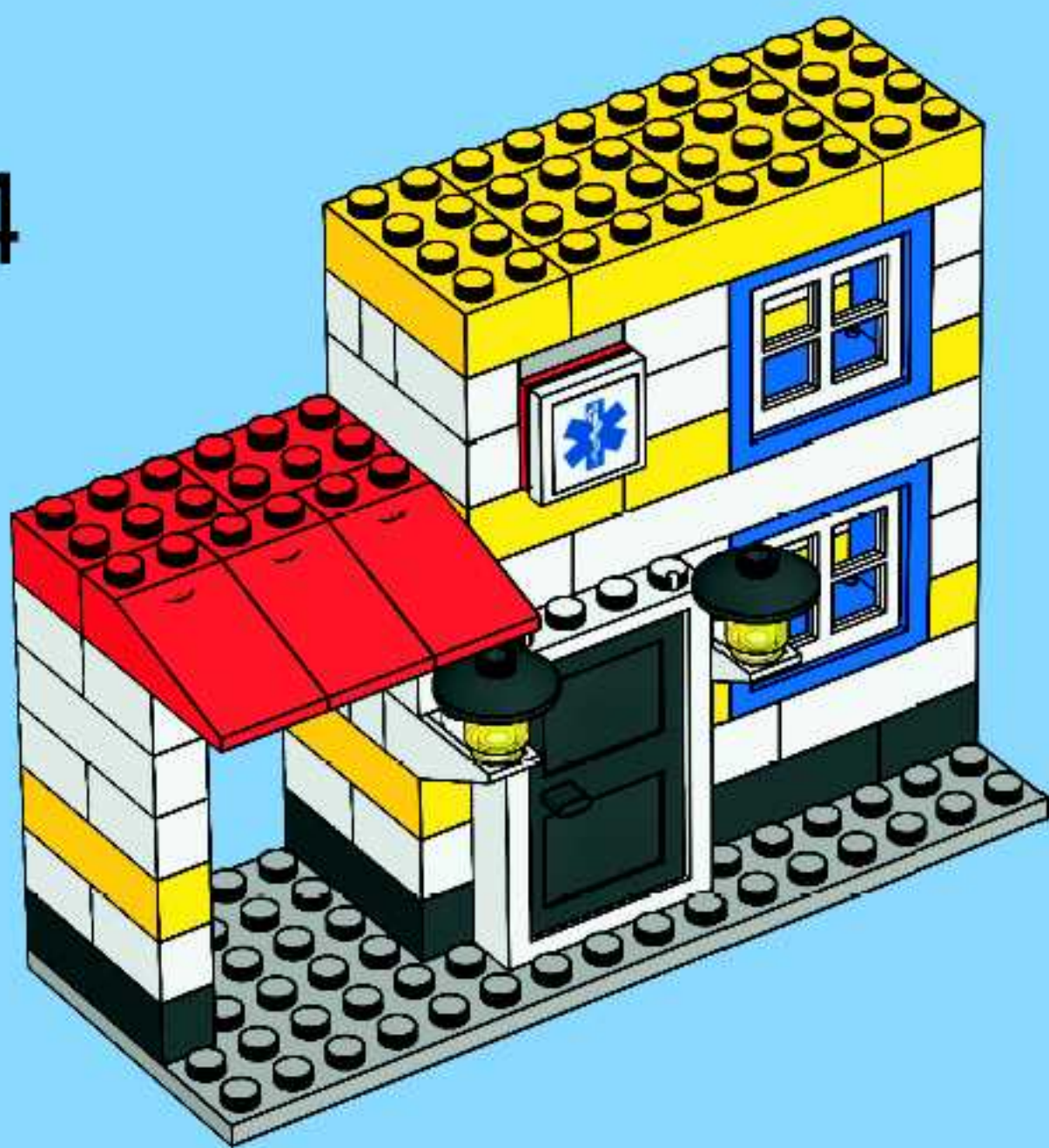

15



16



17

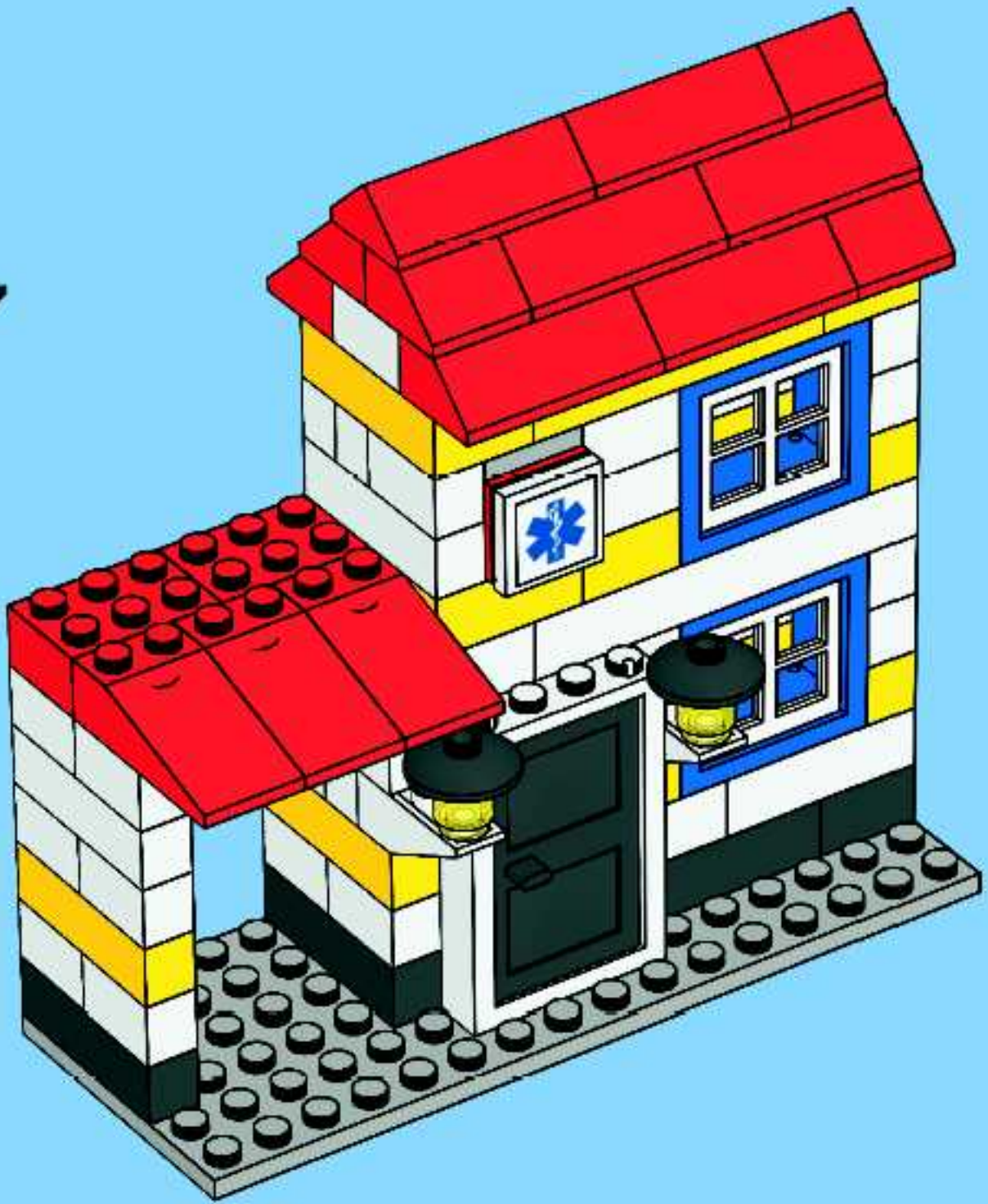

18

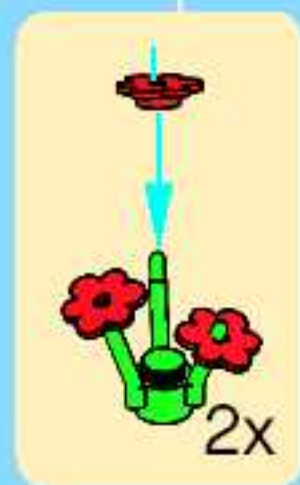







1

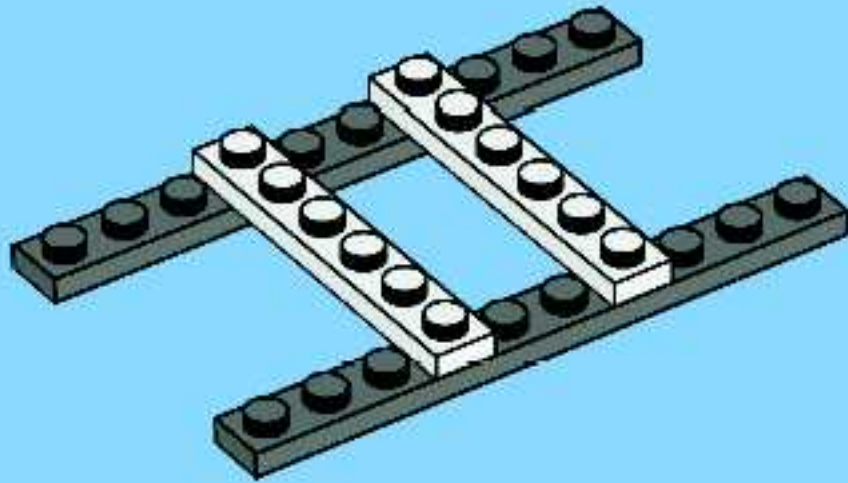

2

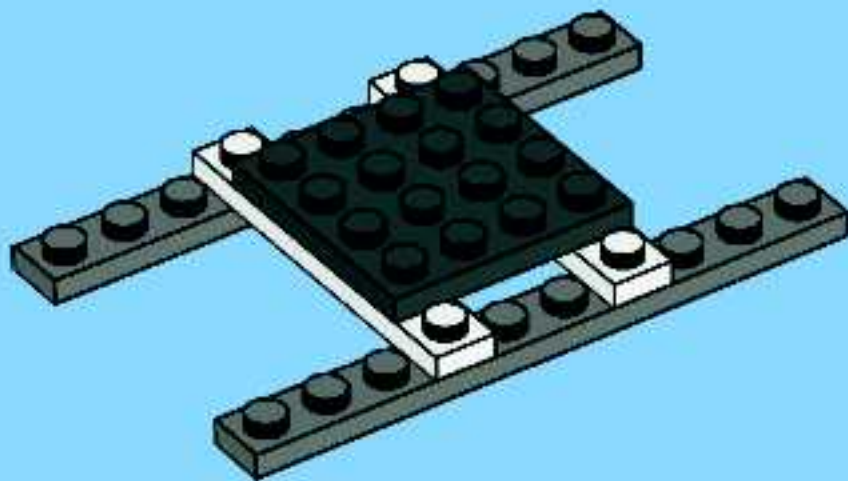

3

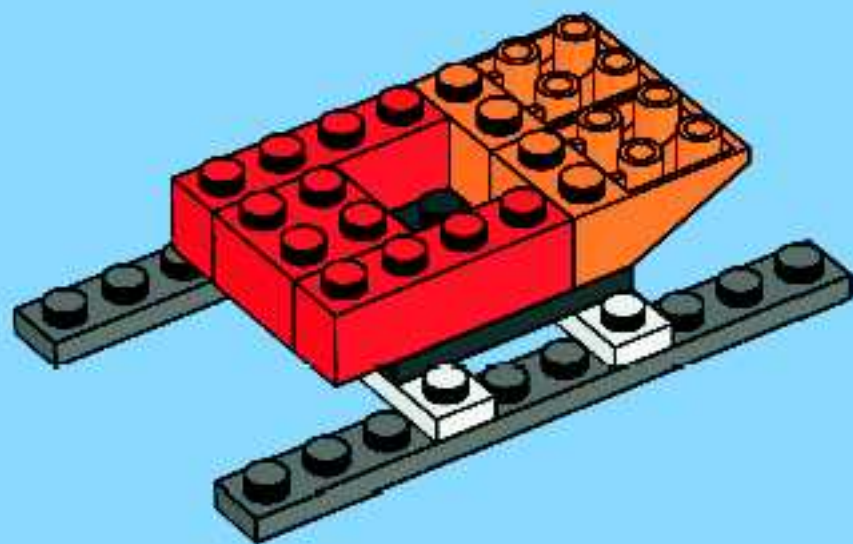

4

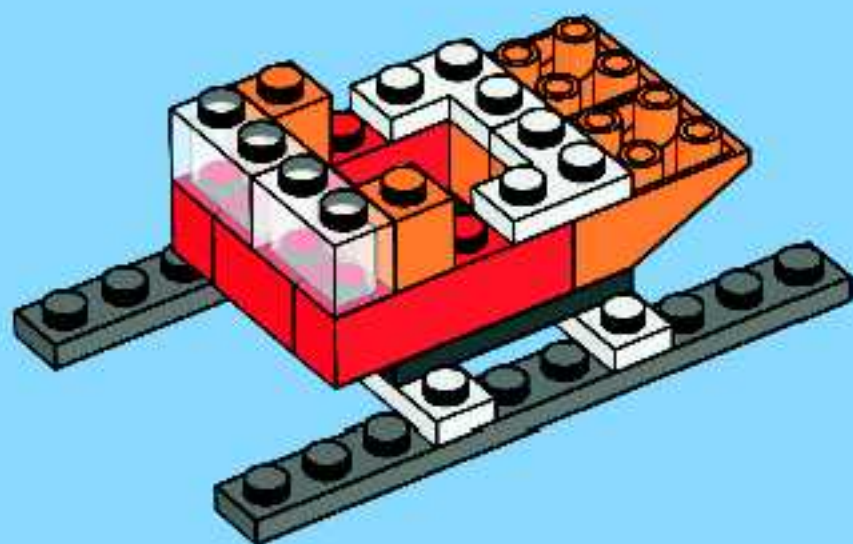

5

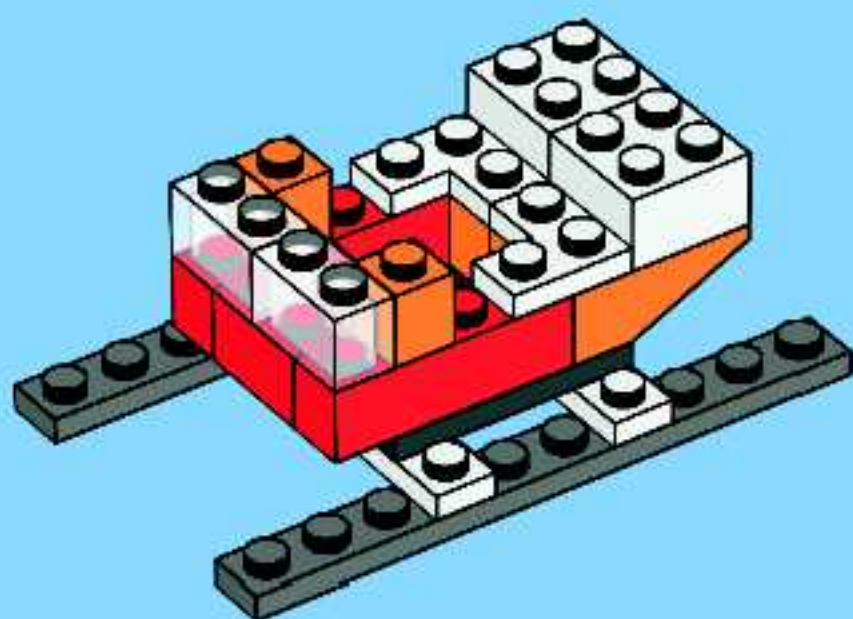

1

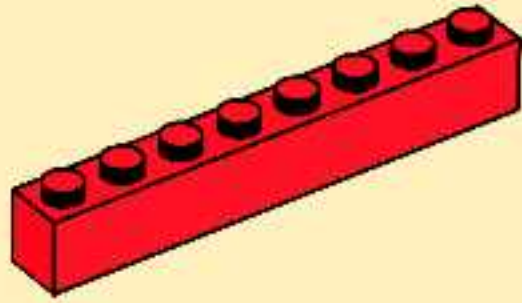

2

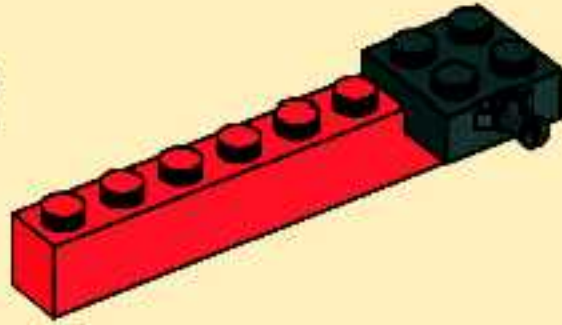

3

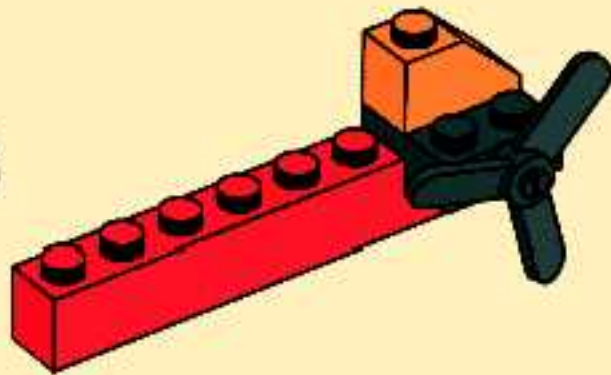

6

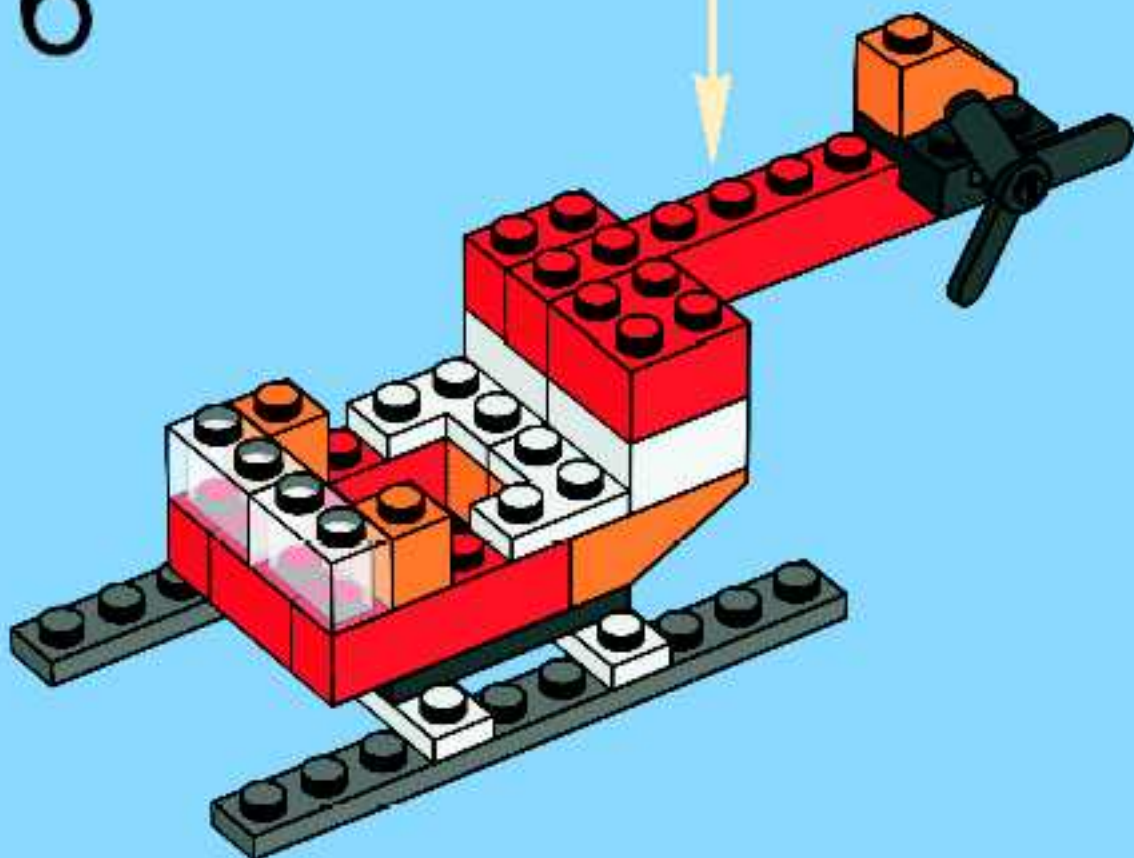

7

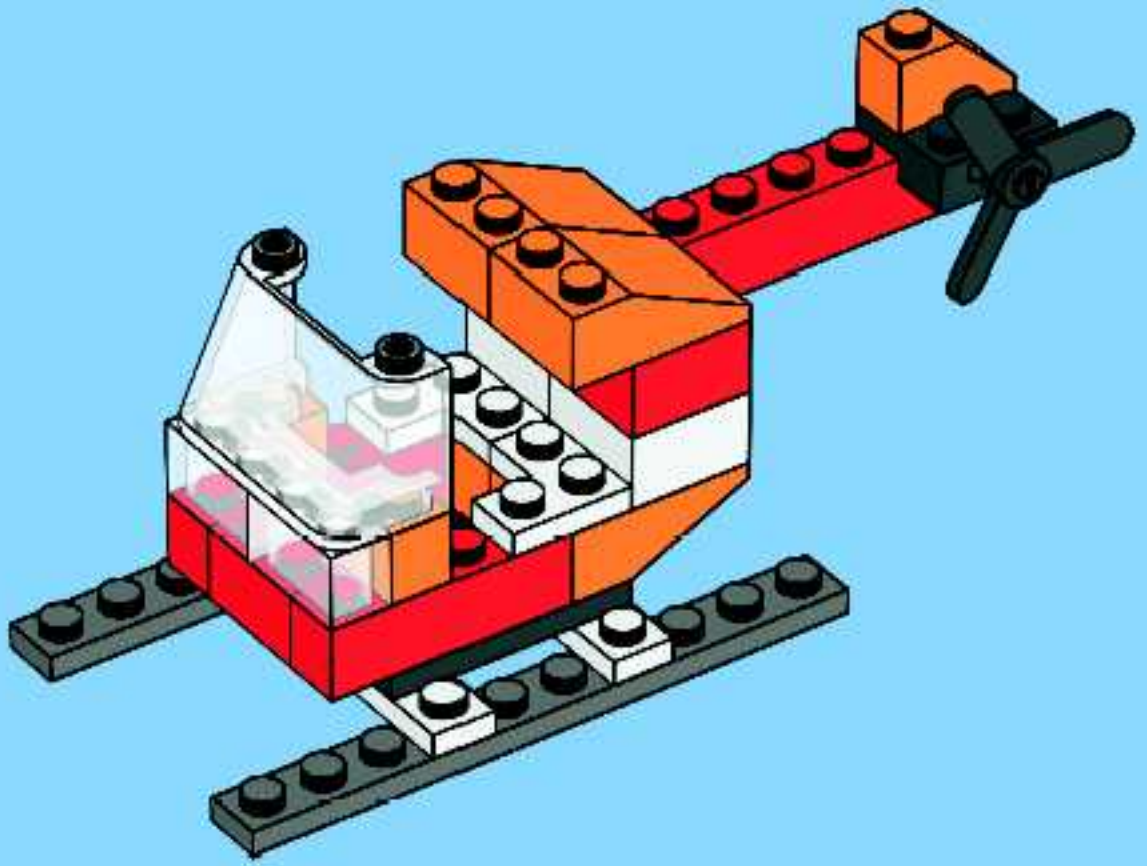

8

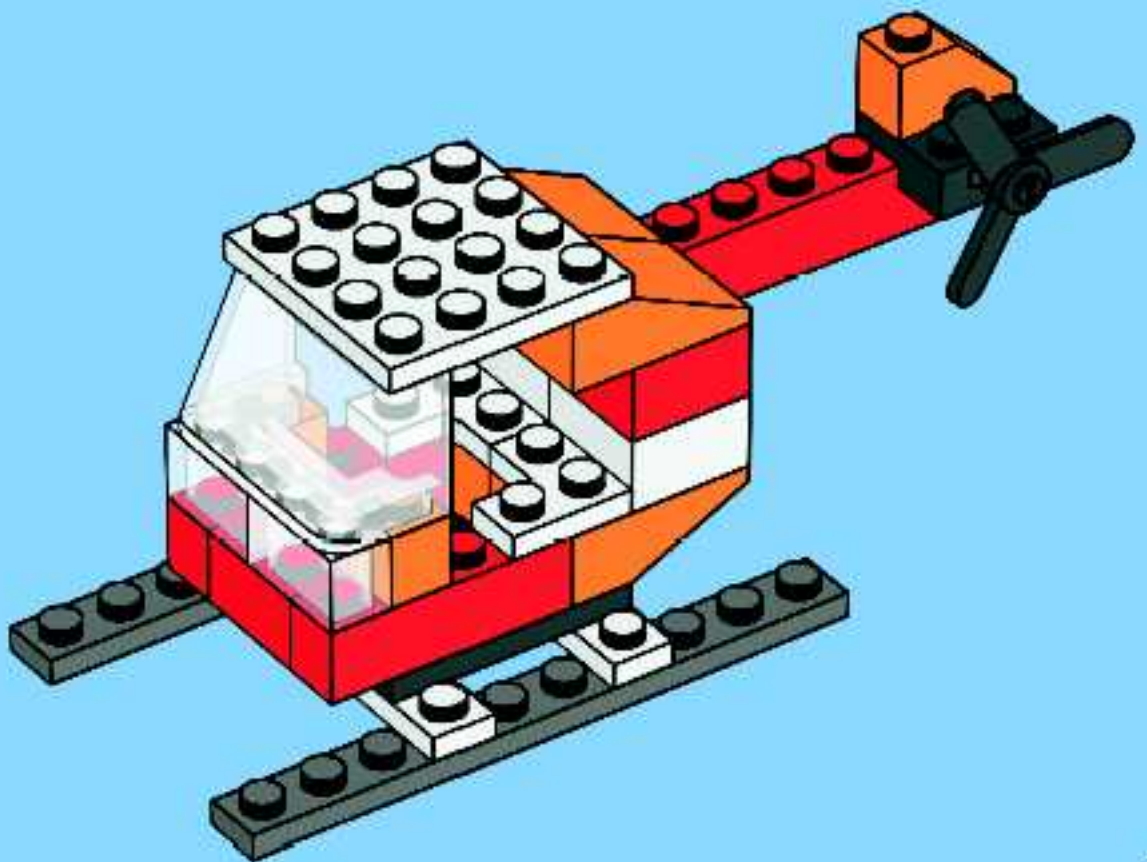

9

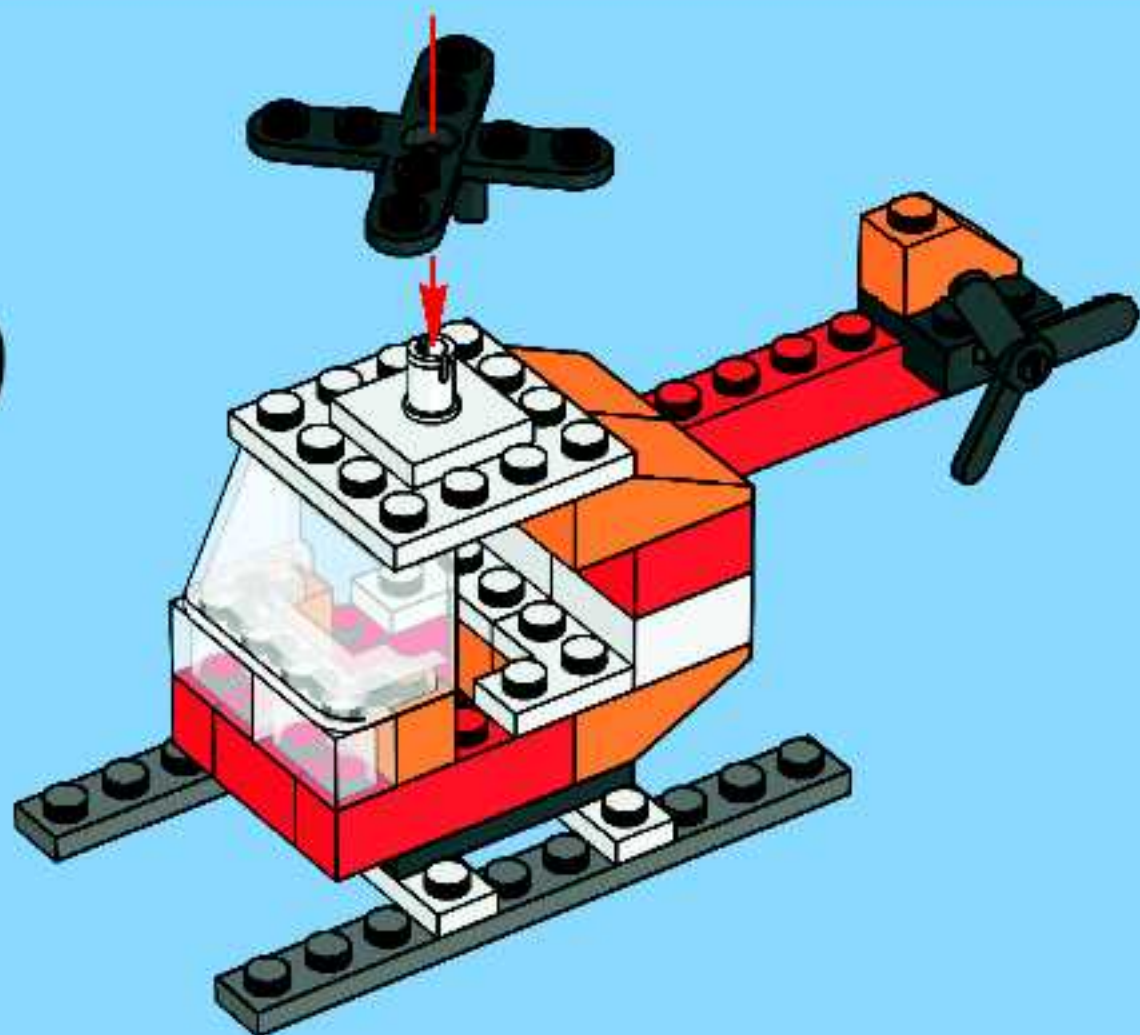

10

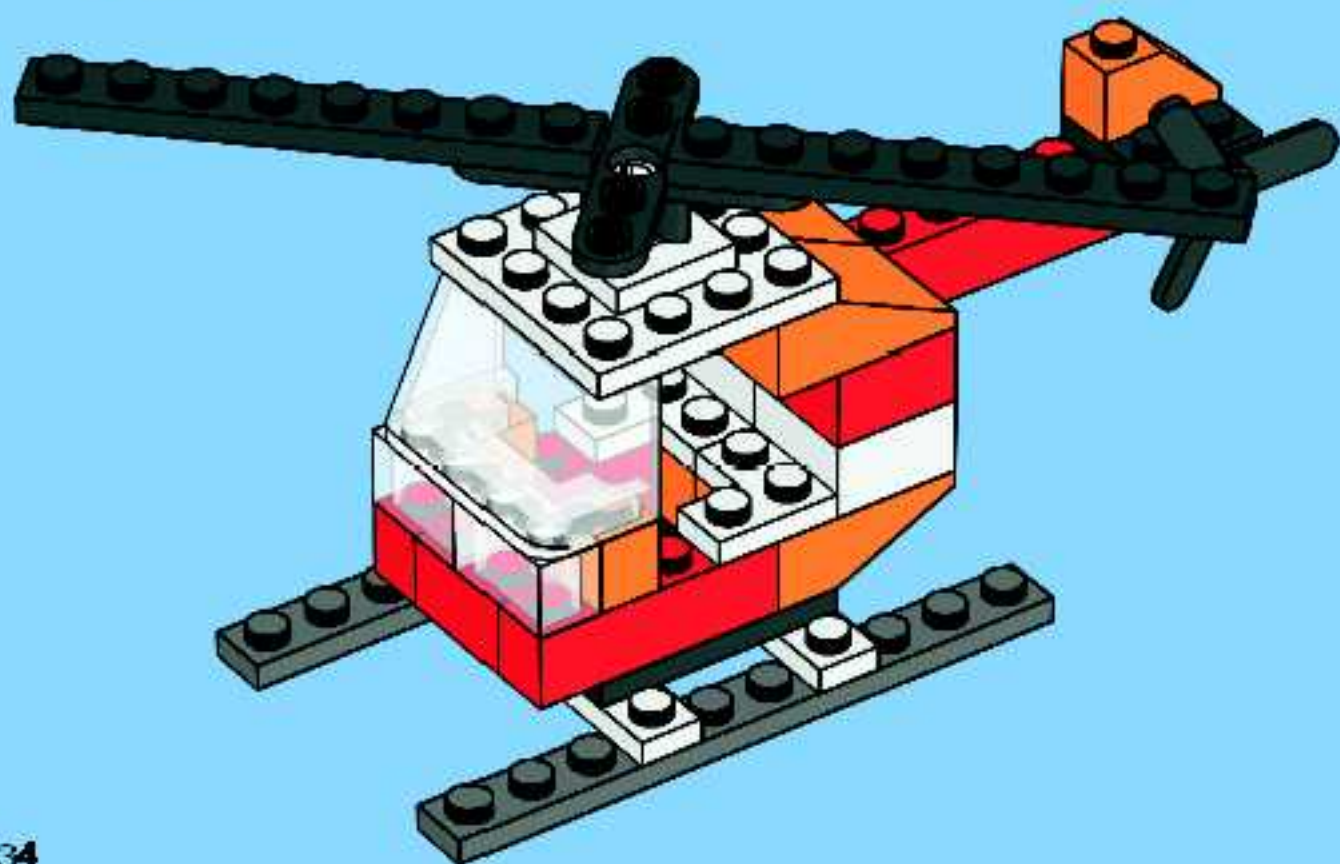



1

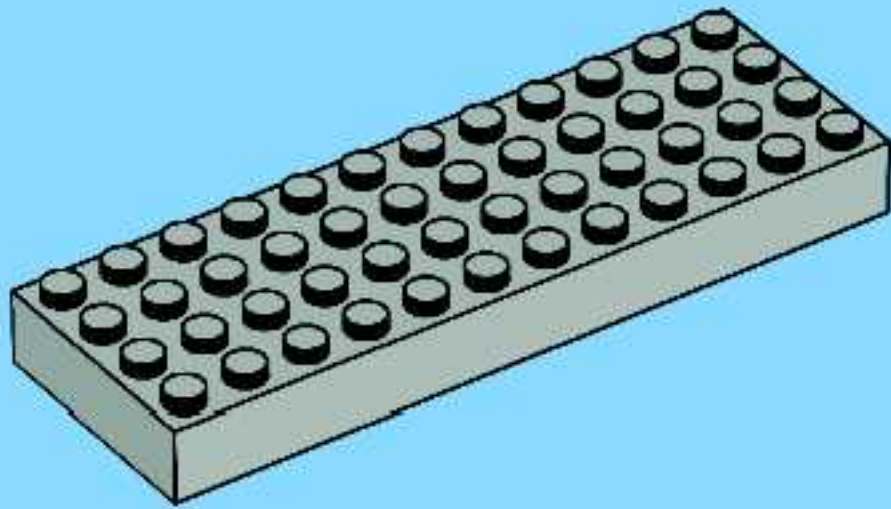

2

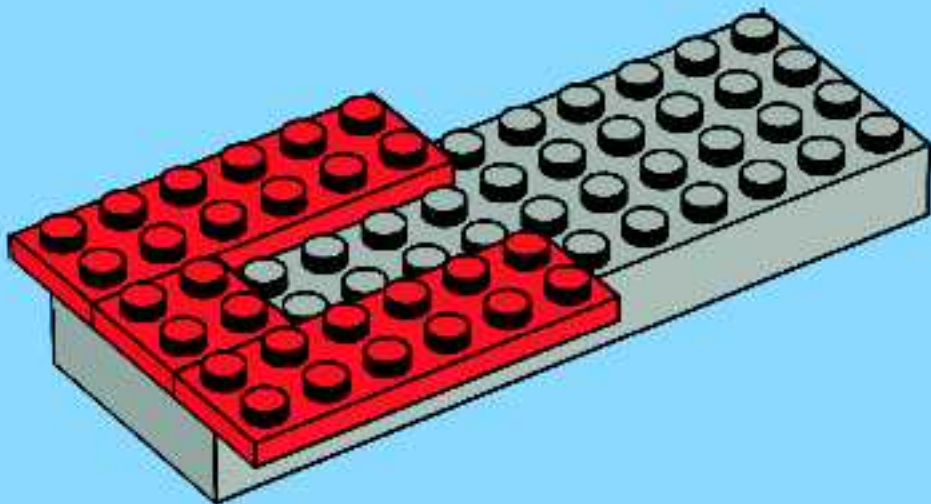

3

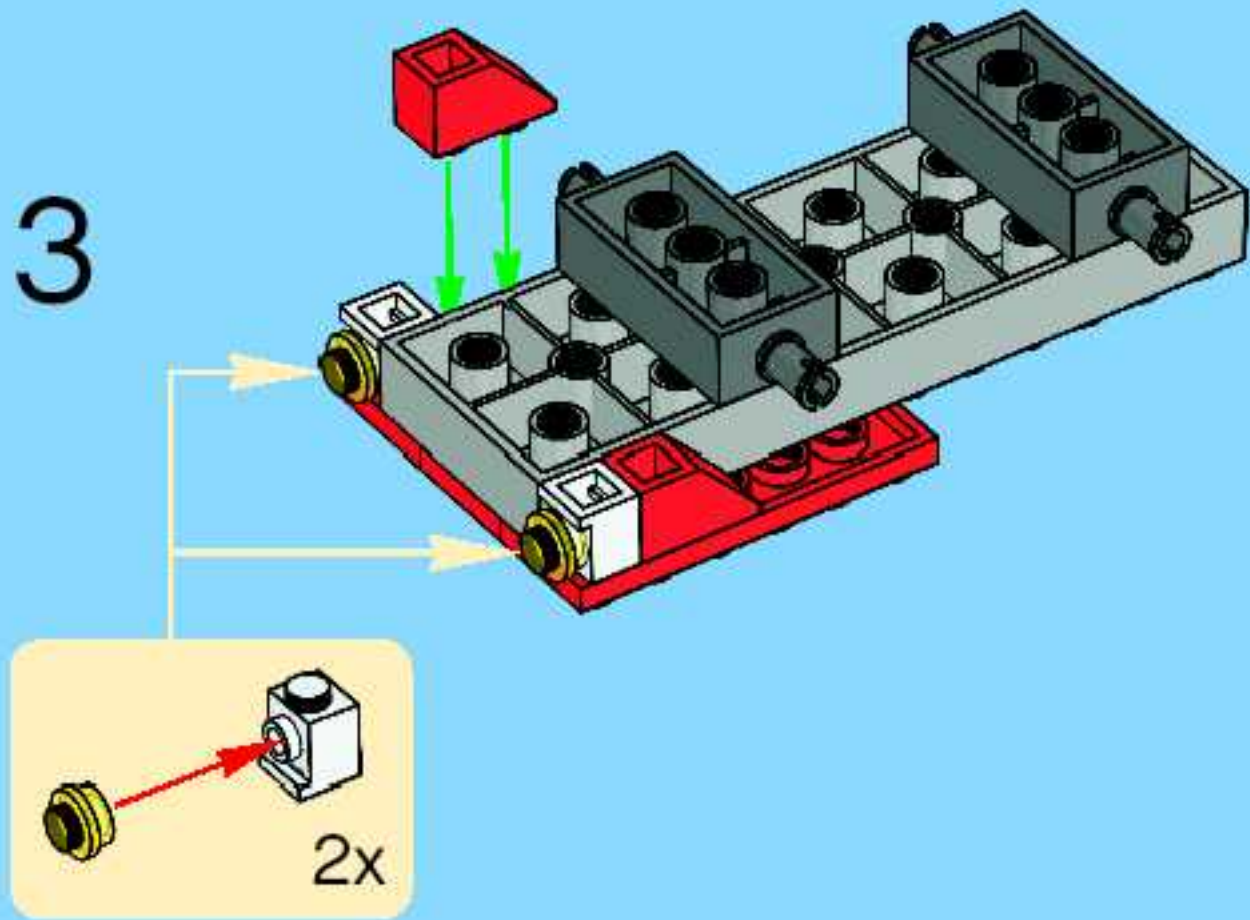

4

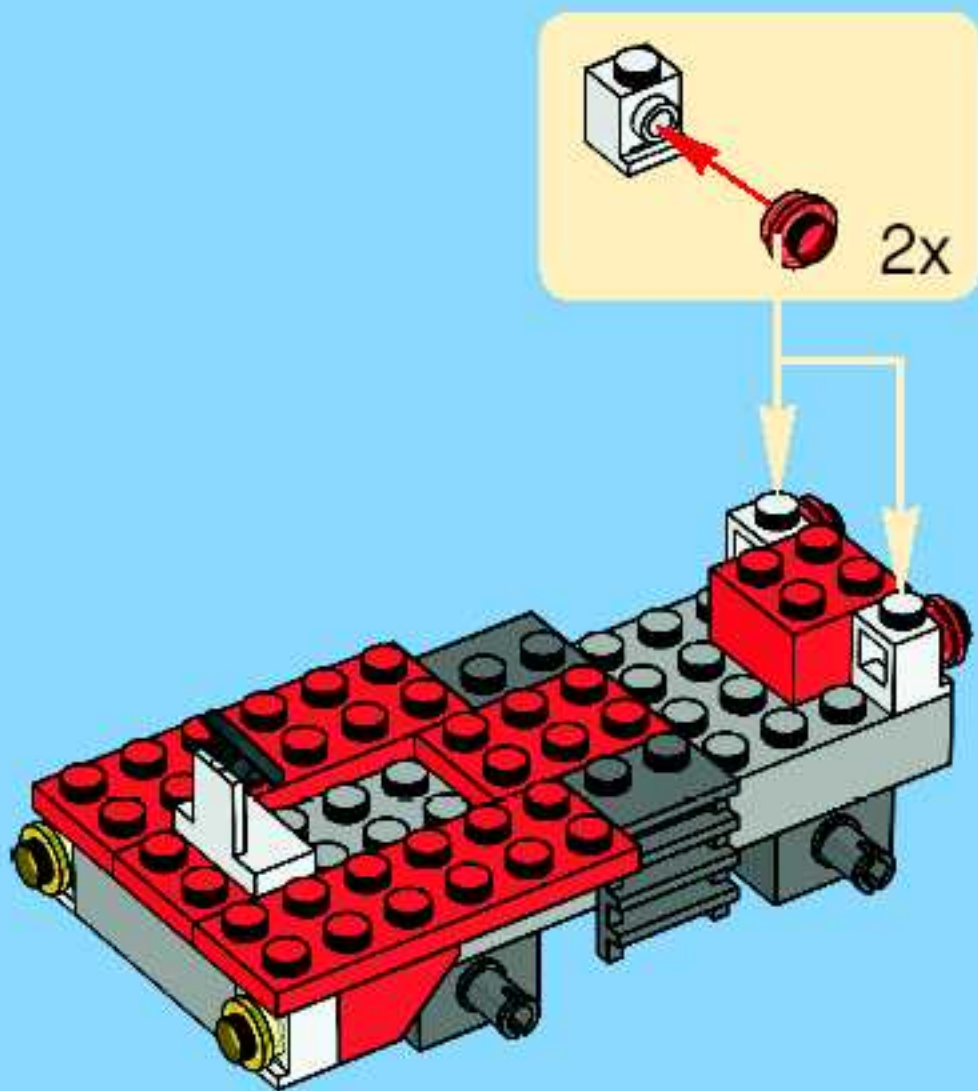

5

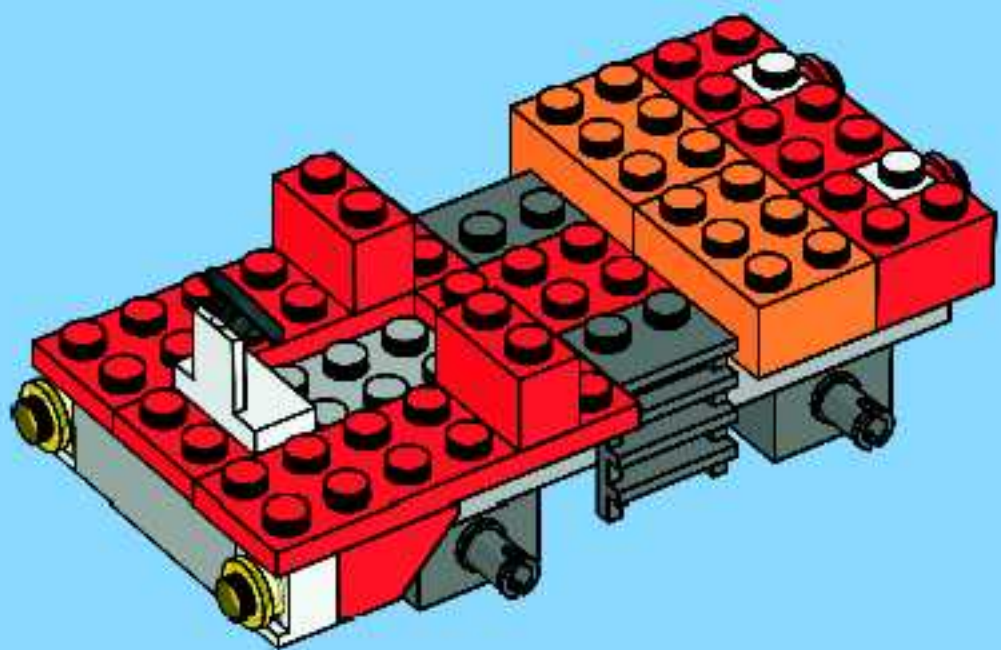

6

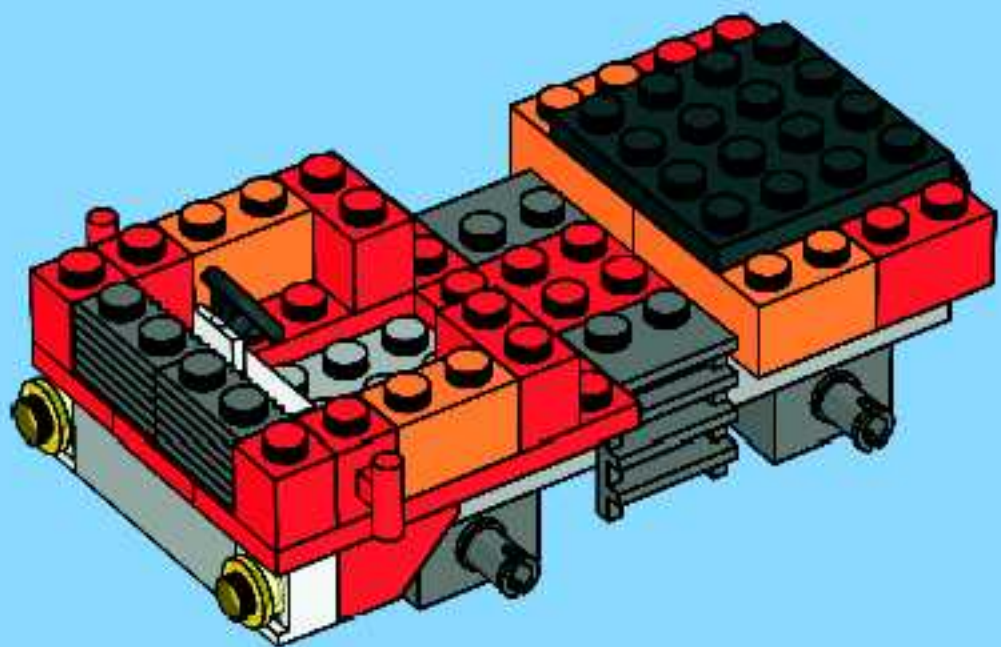

7

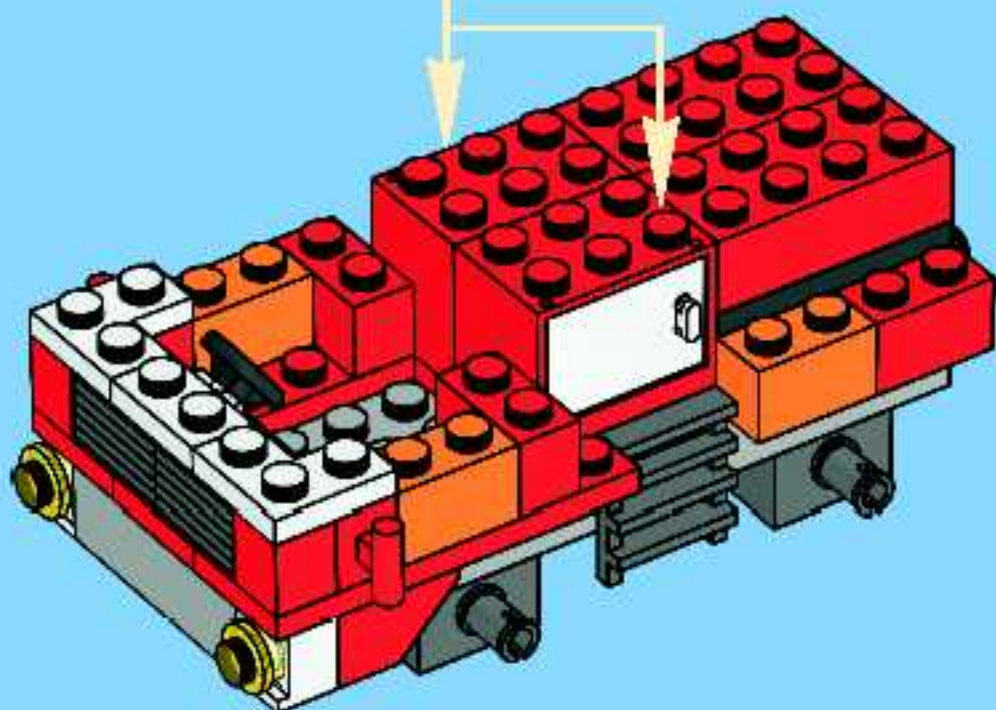
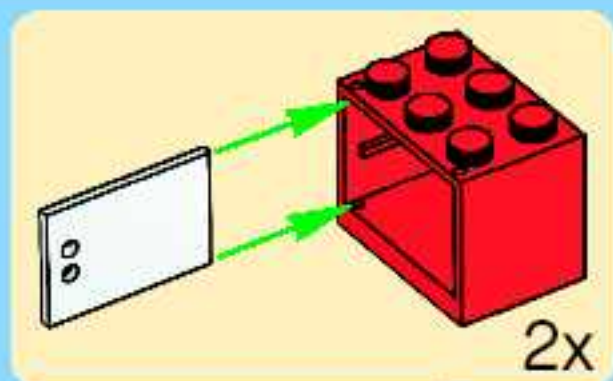

8

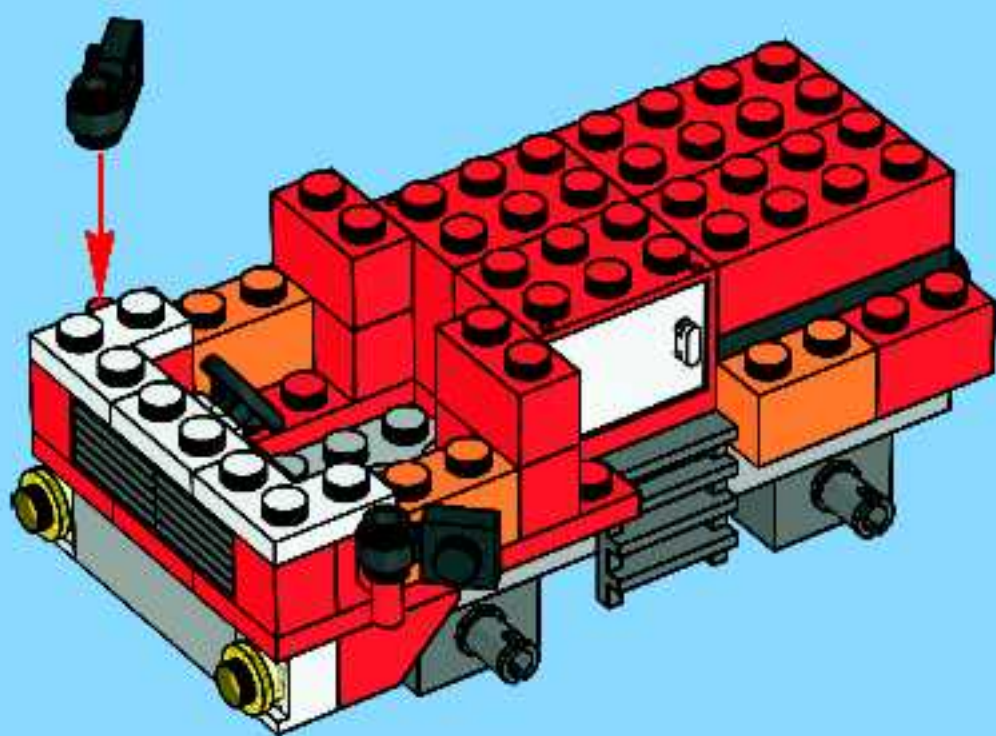

9

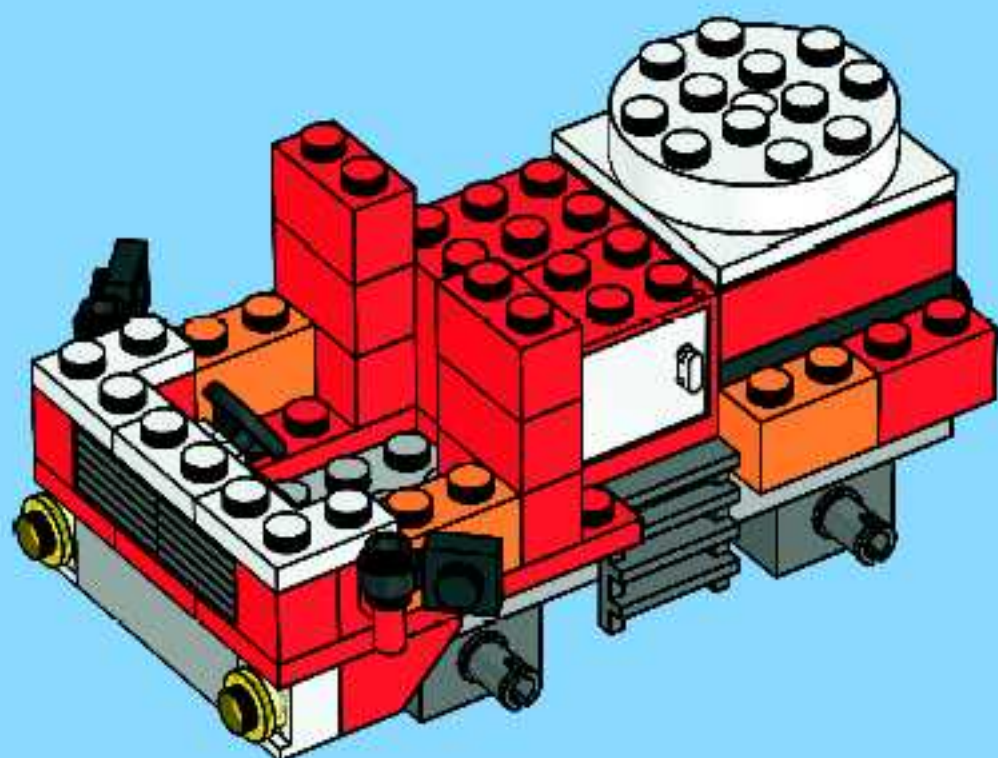

10

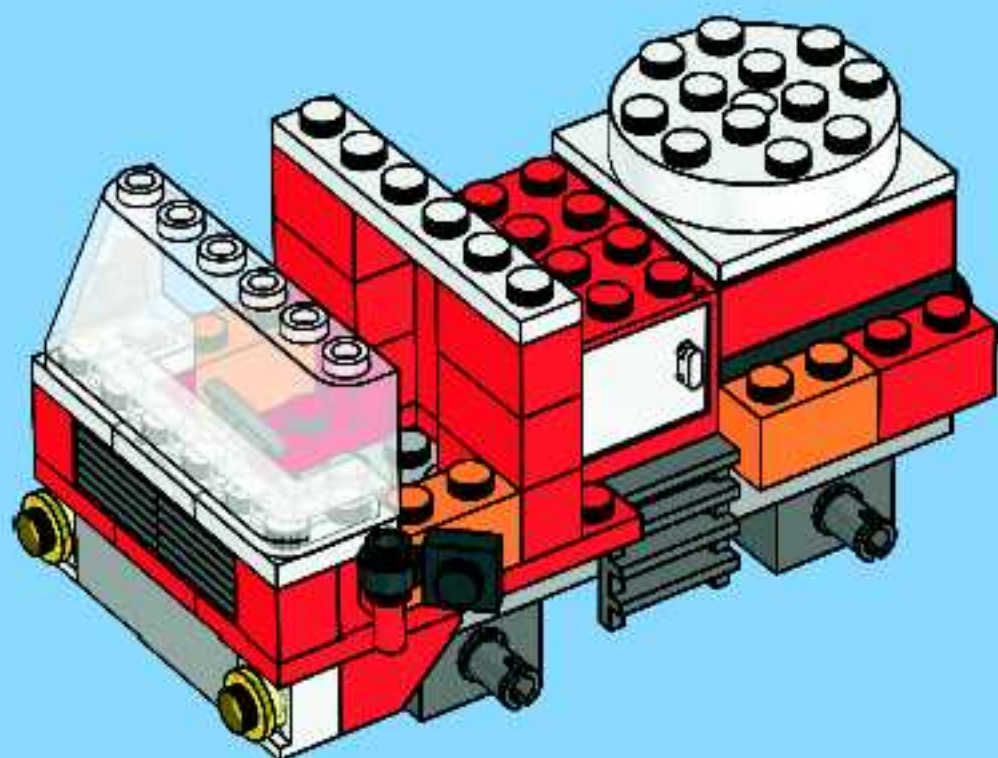

11

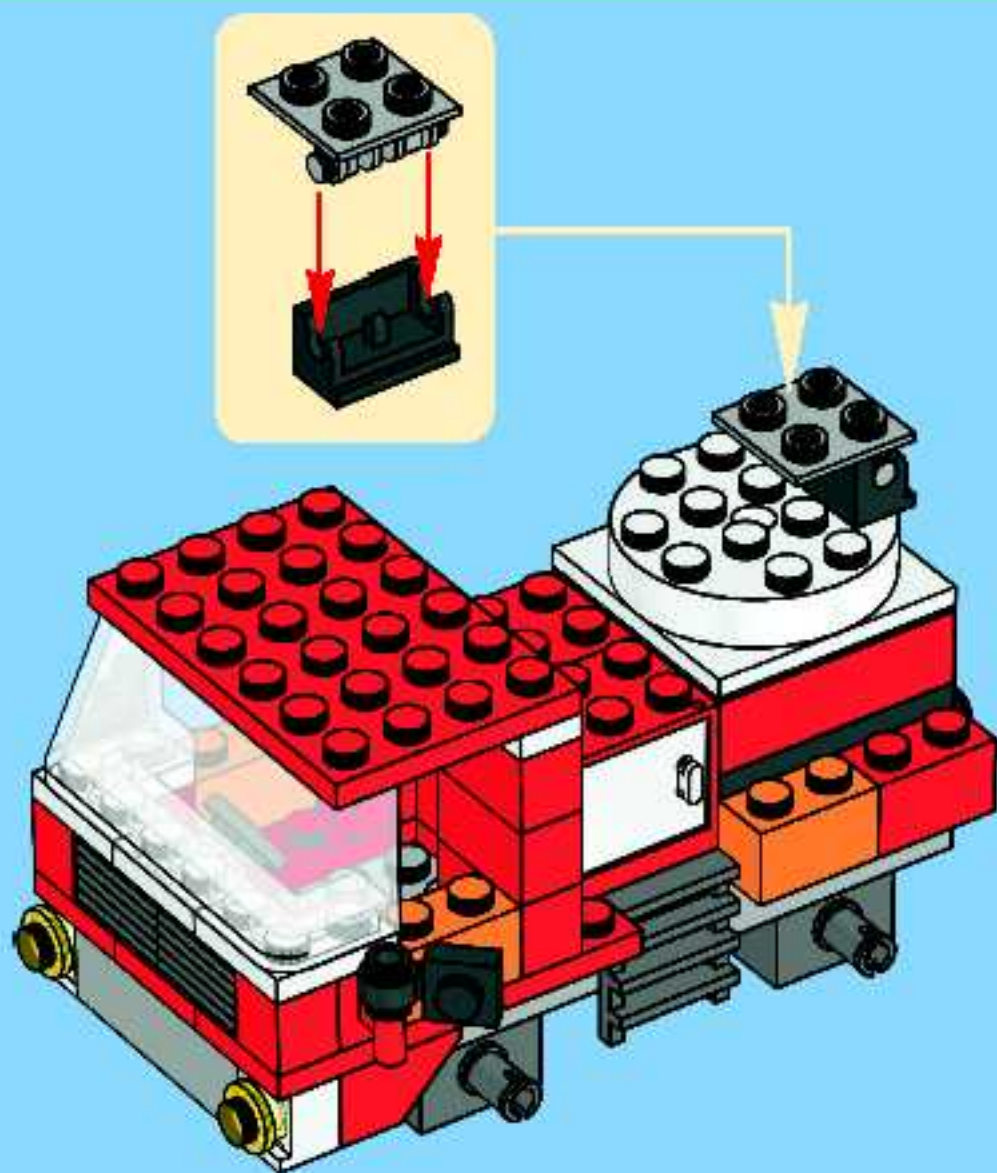

12

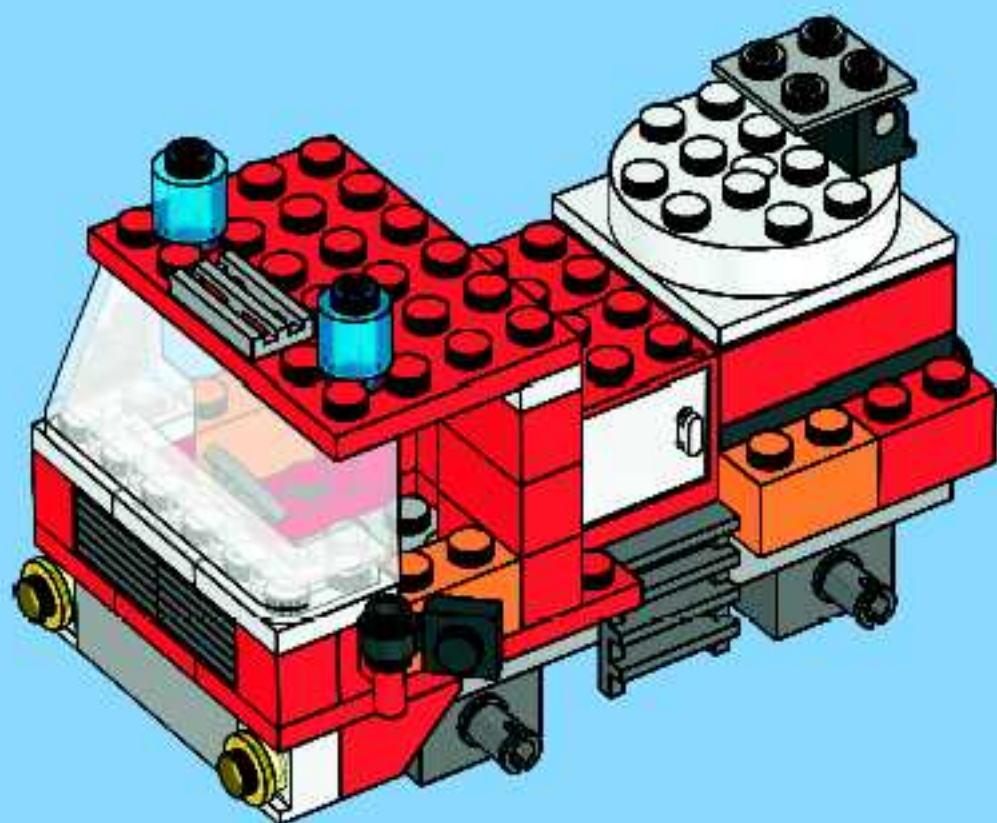

13

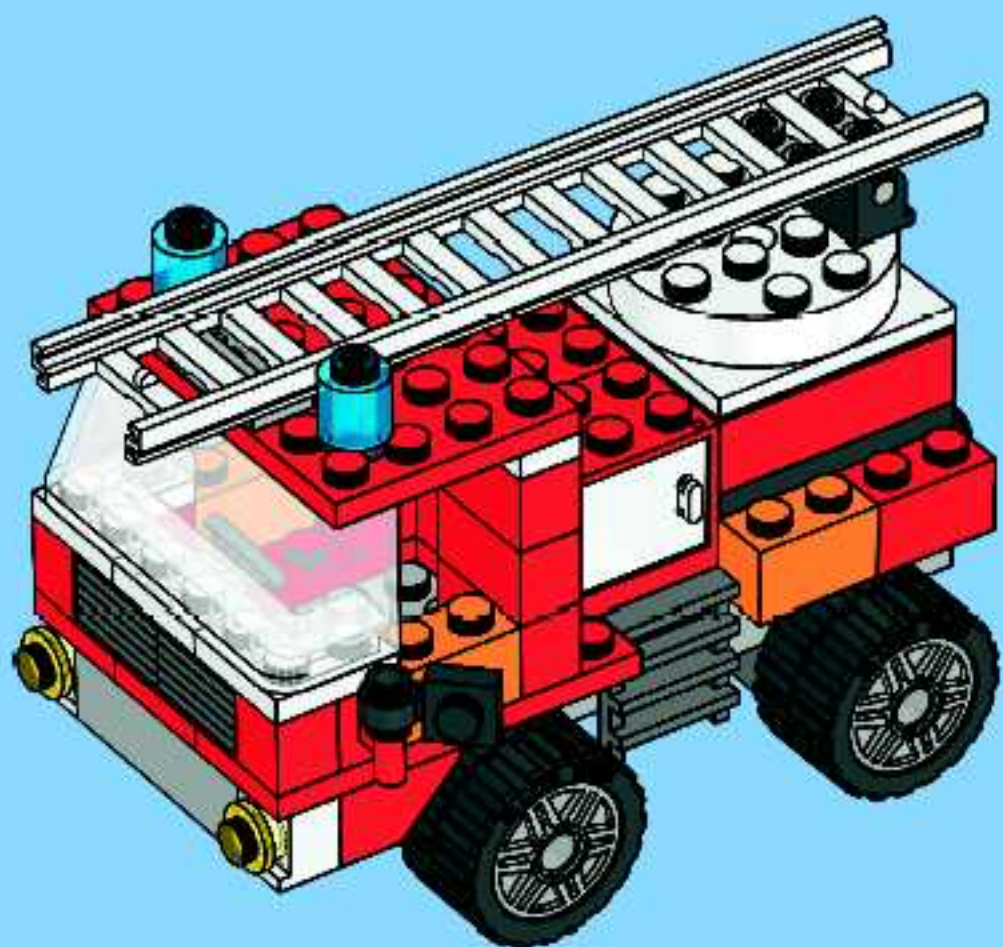





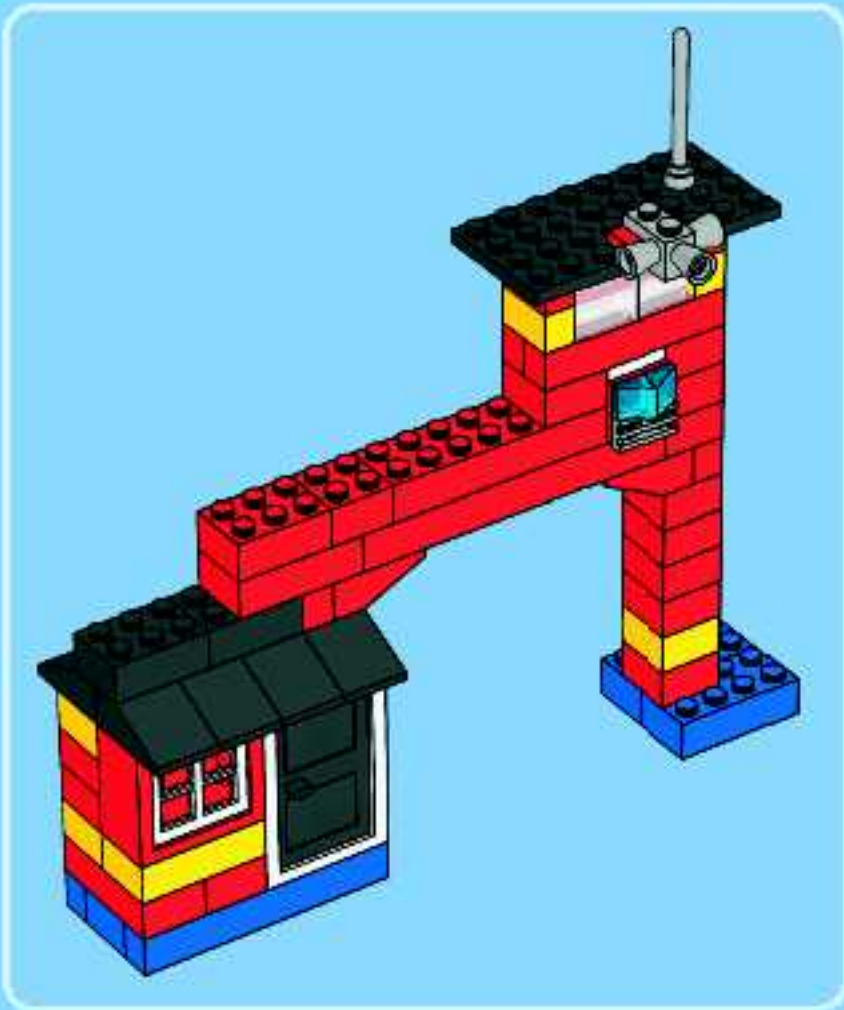

1

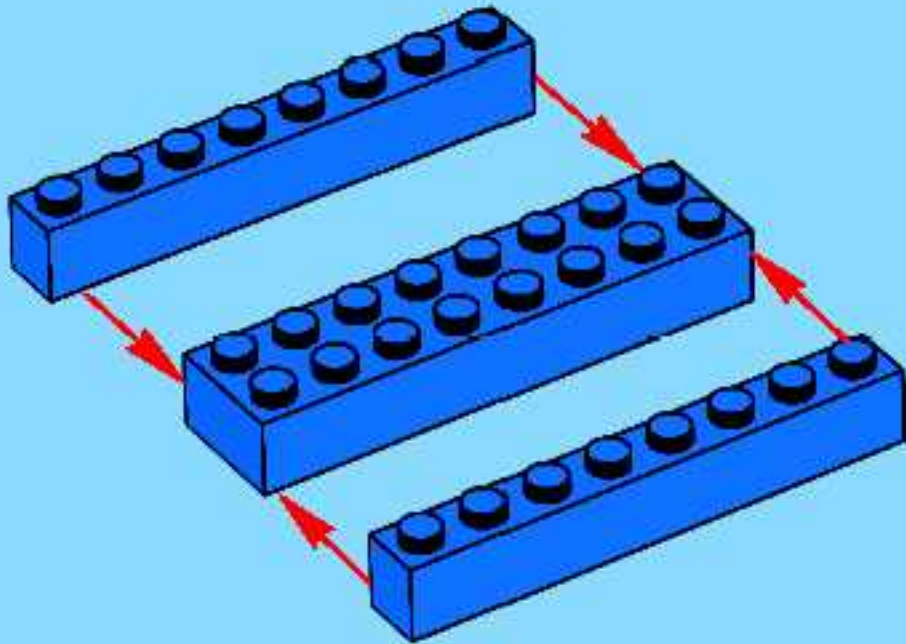

2

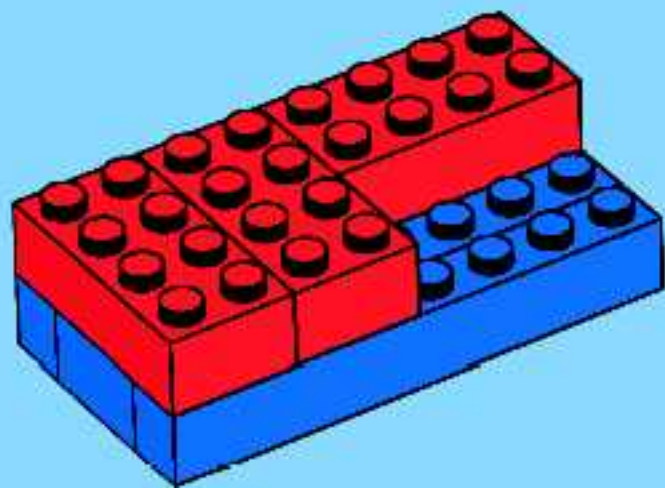

3

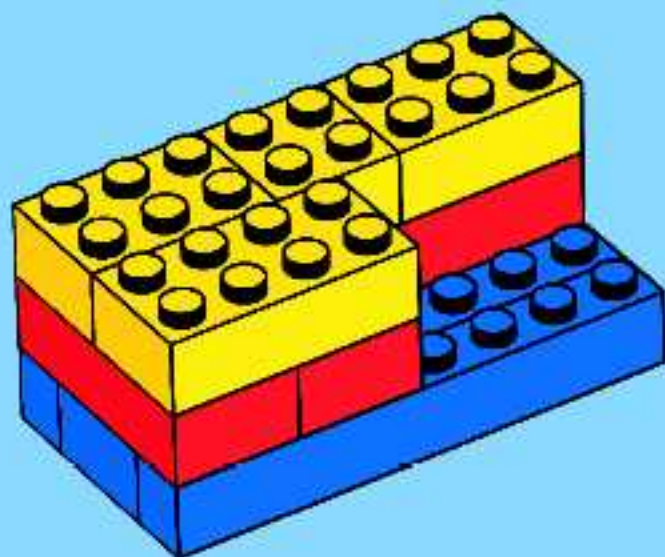

4

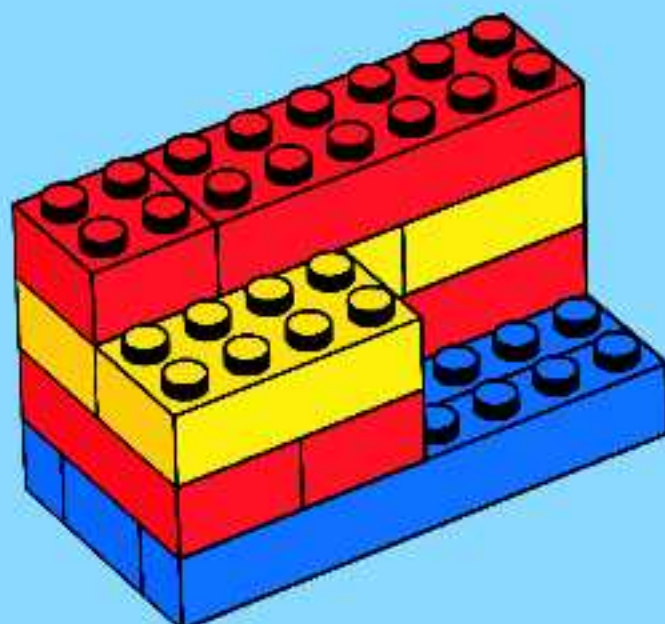

5

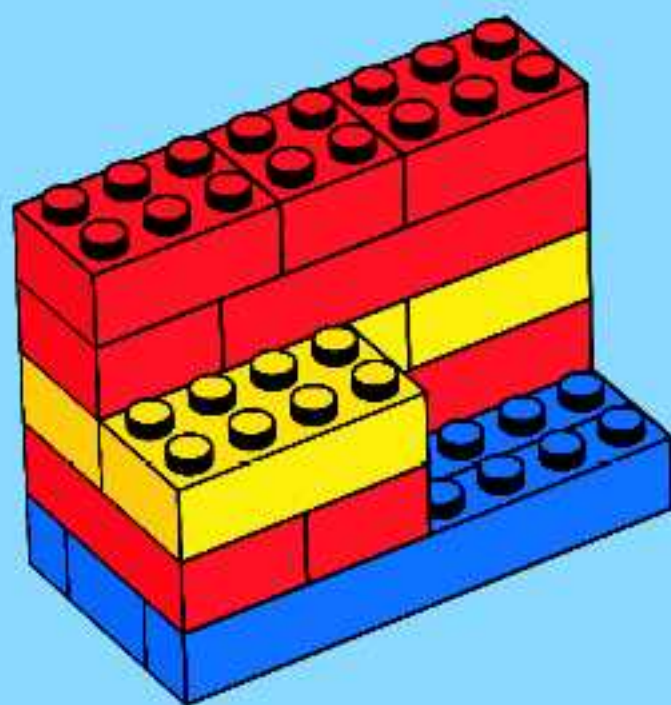

6

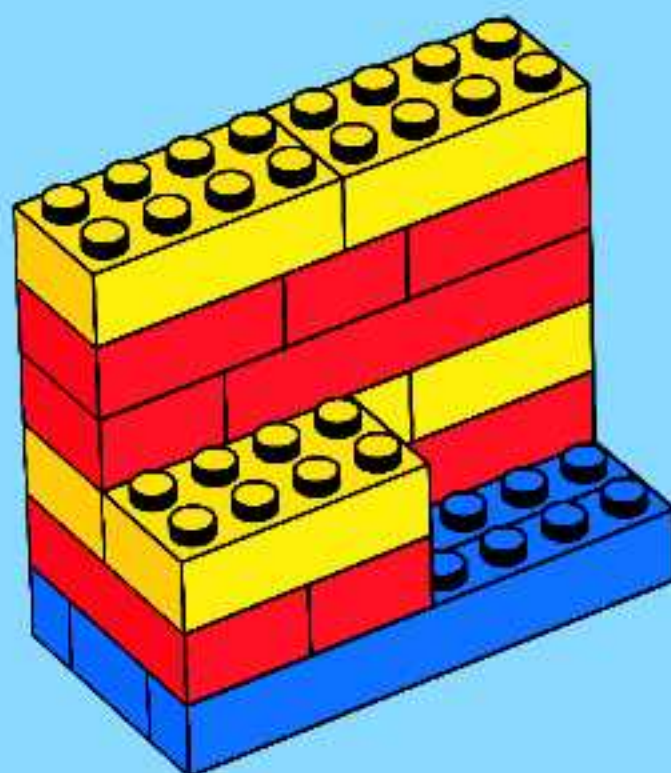

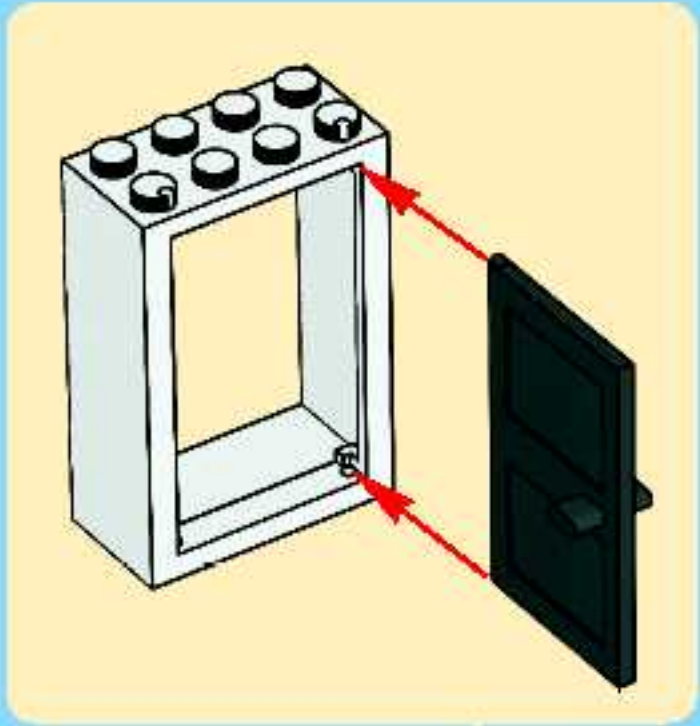
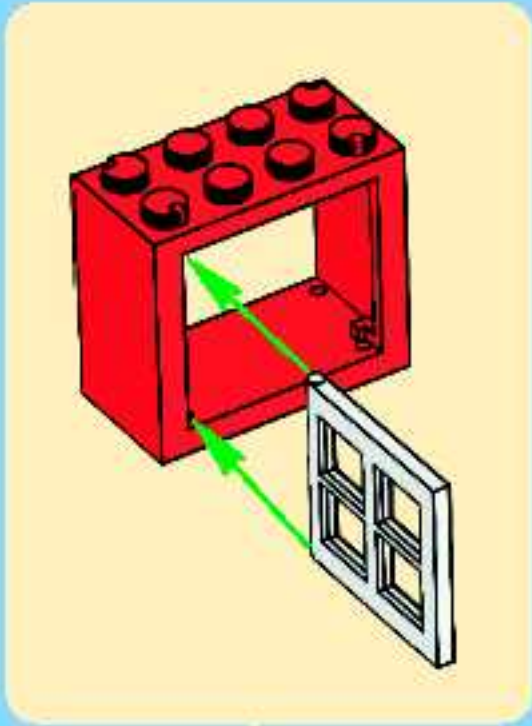

7

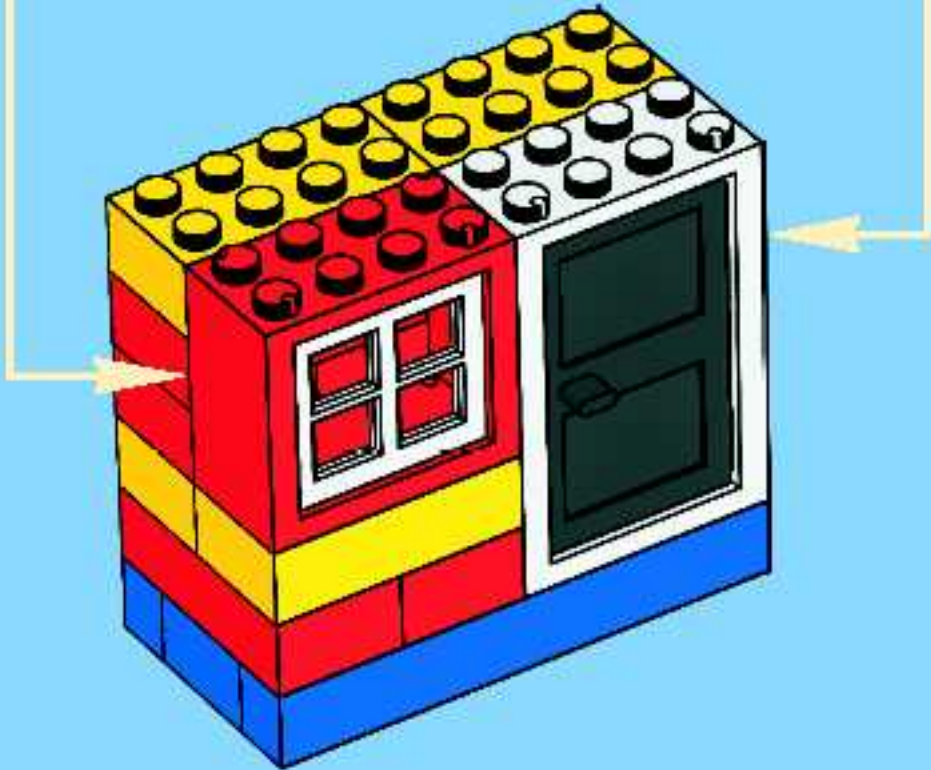

8



9



1

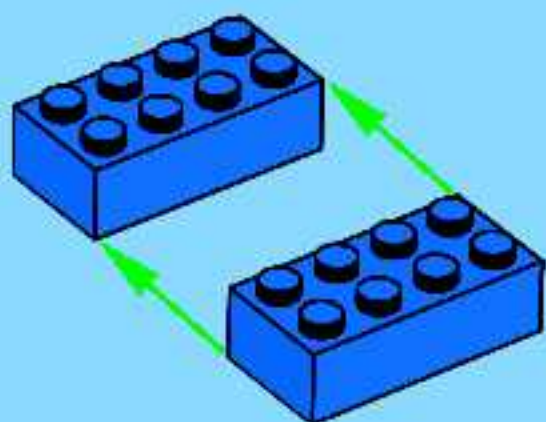

2

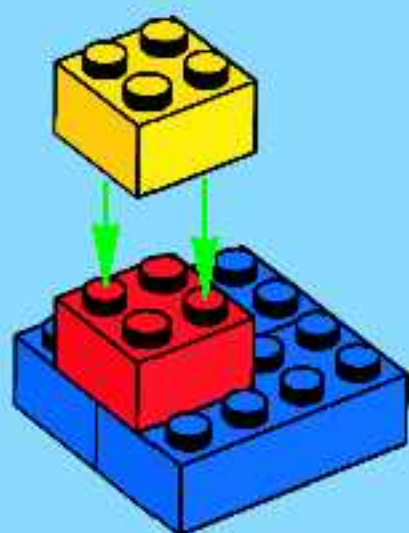

3

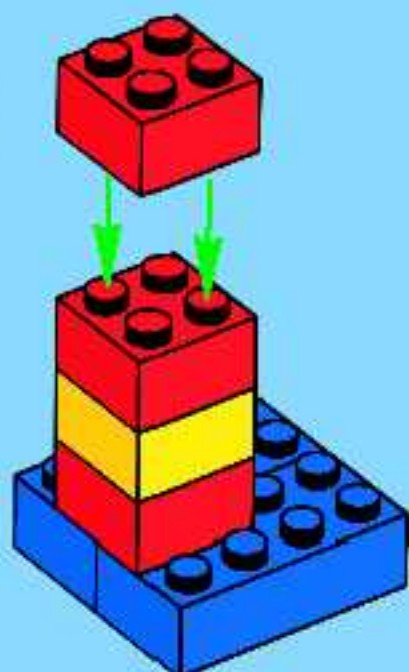

4

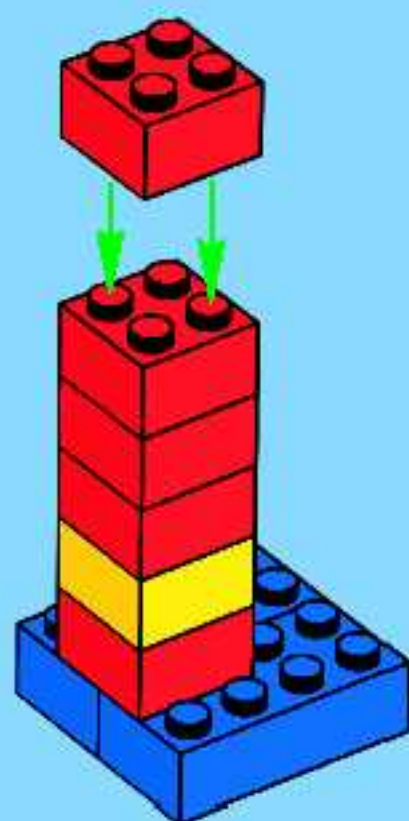

5

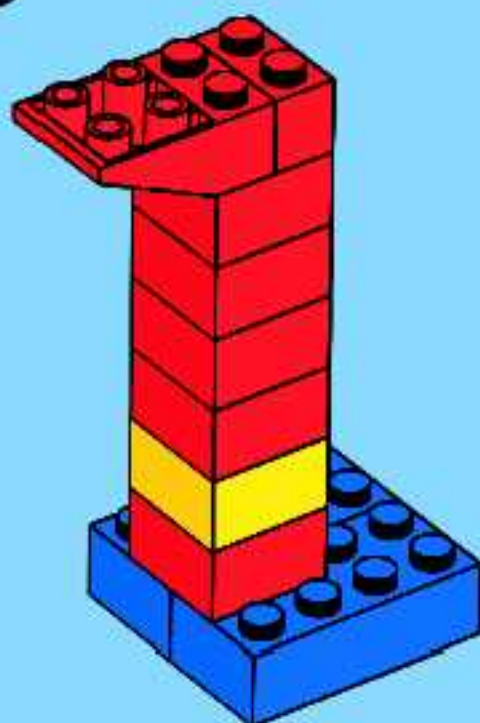

6

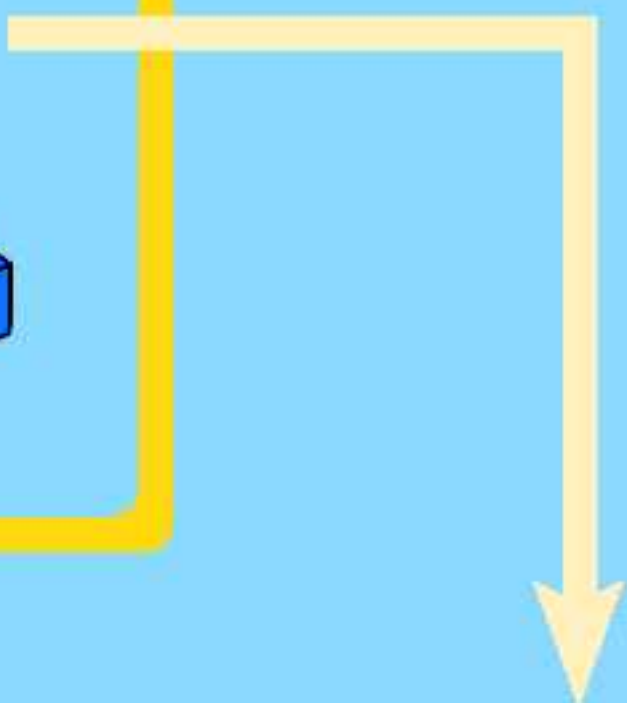
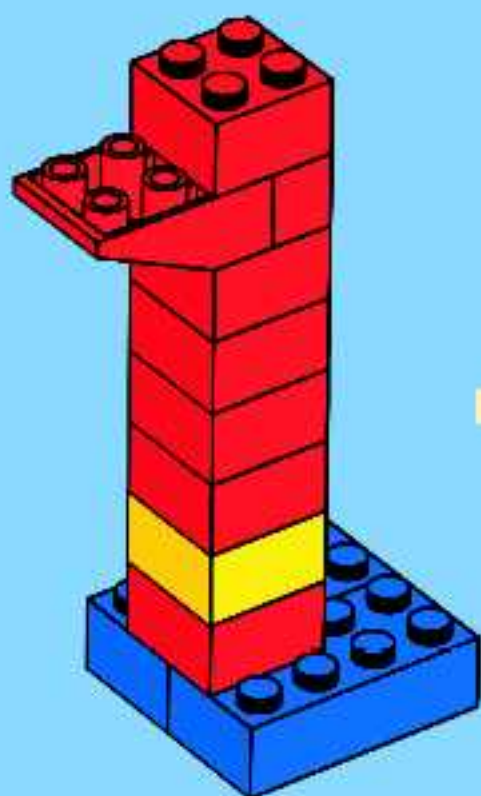

10

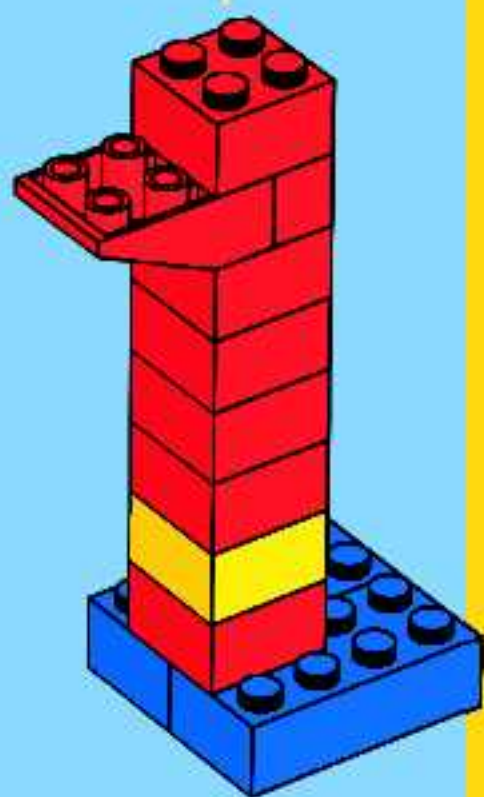

11

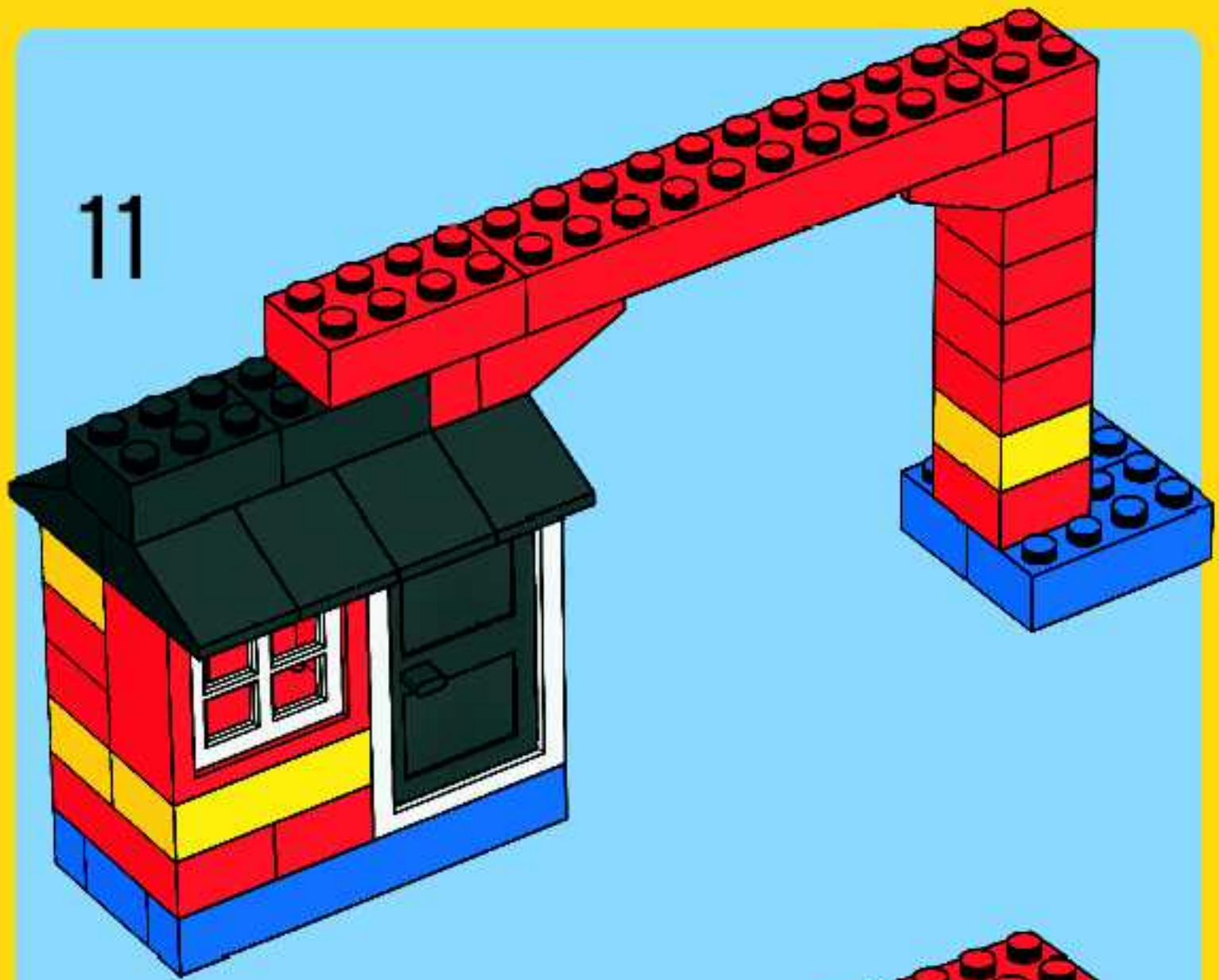

12

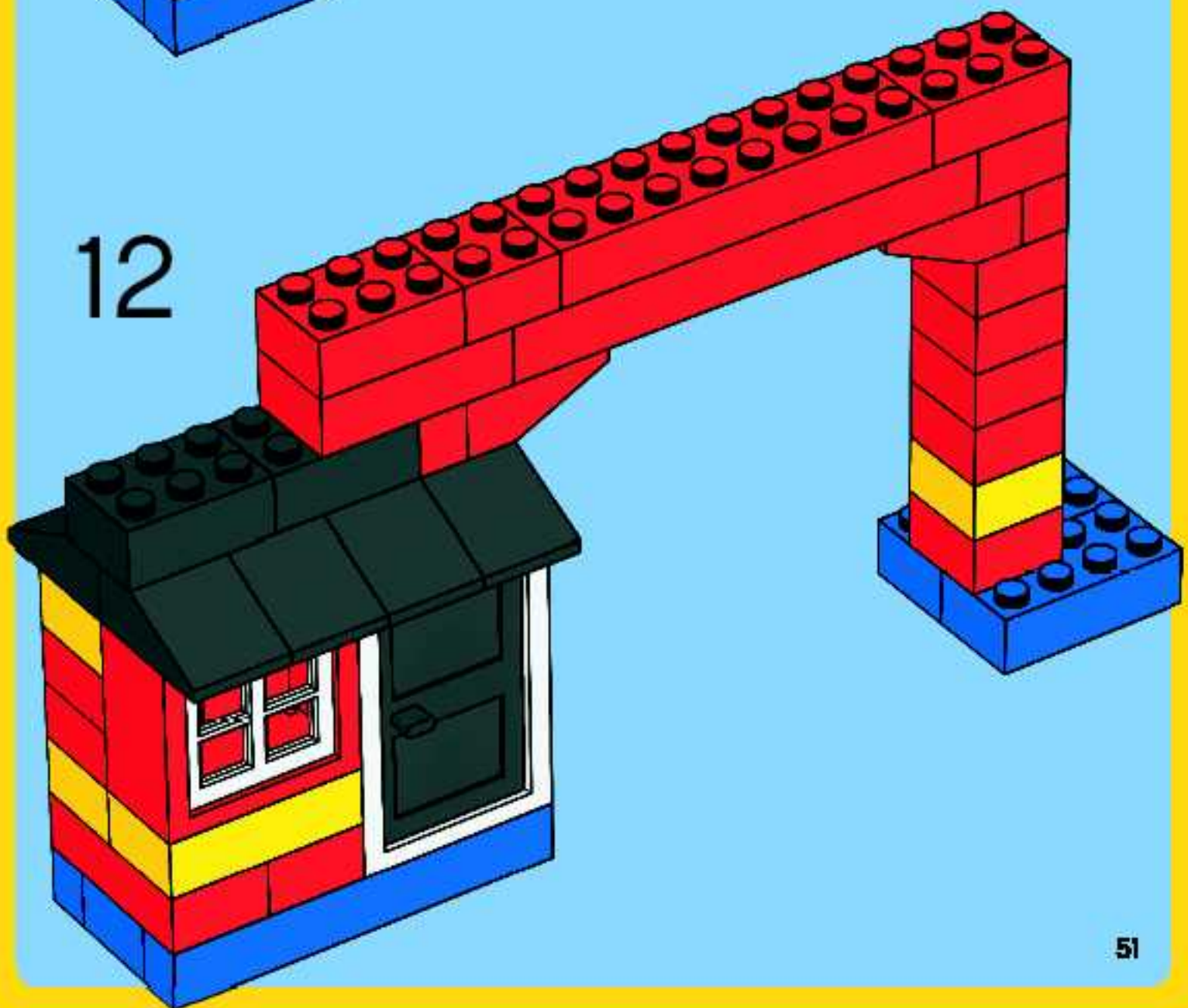

13

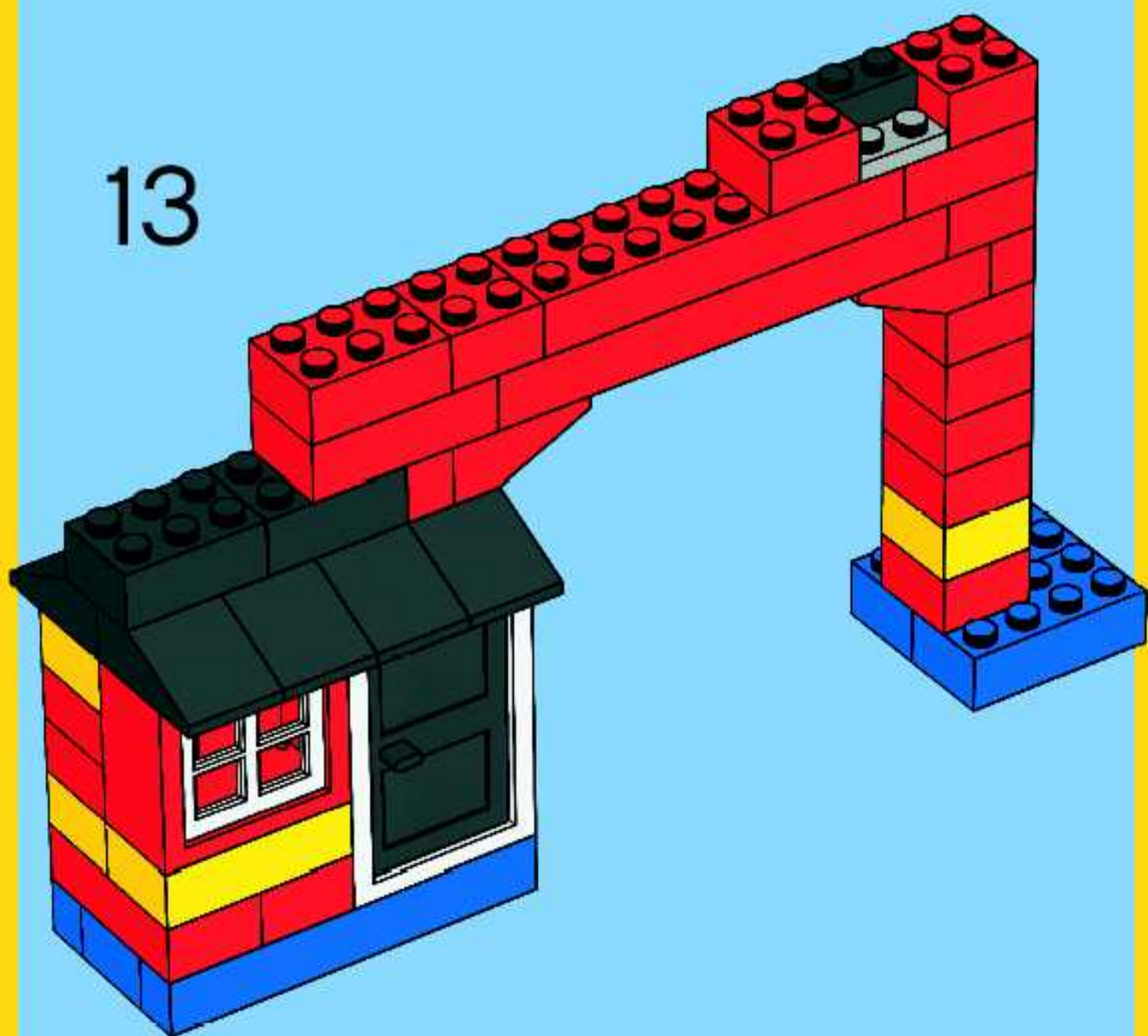

1

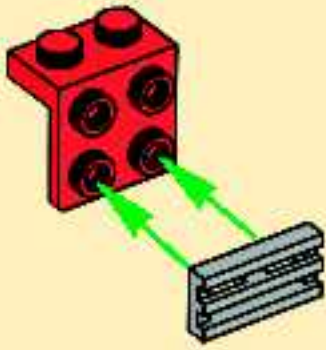

2

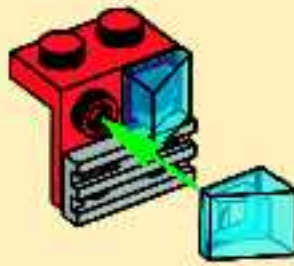

3



14

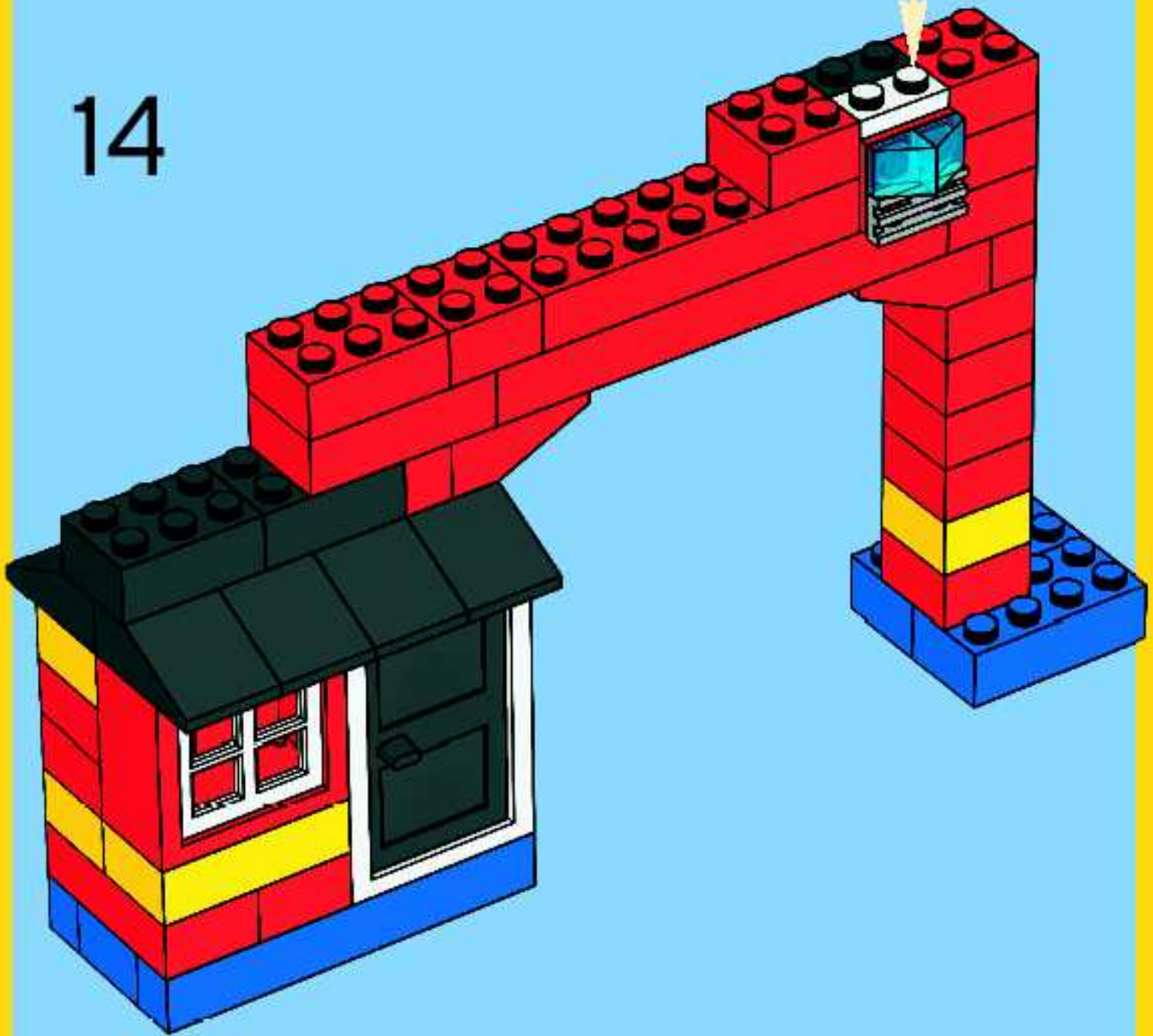

15

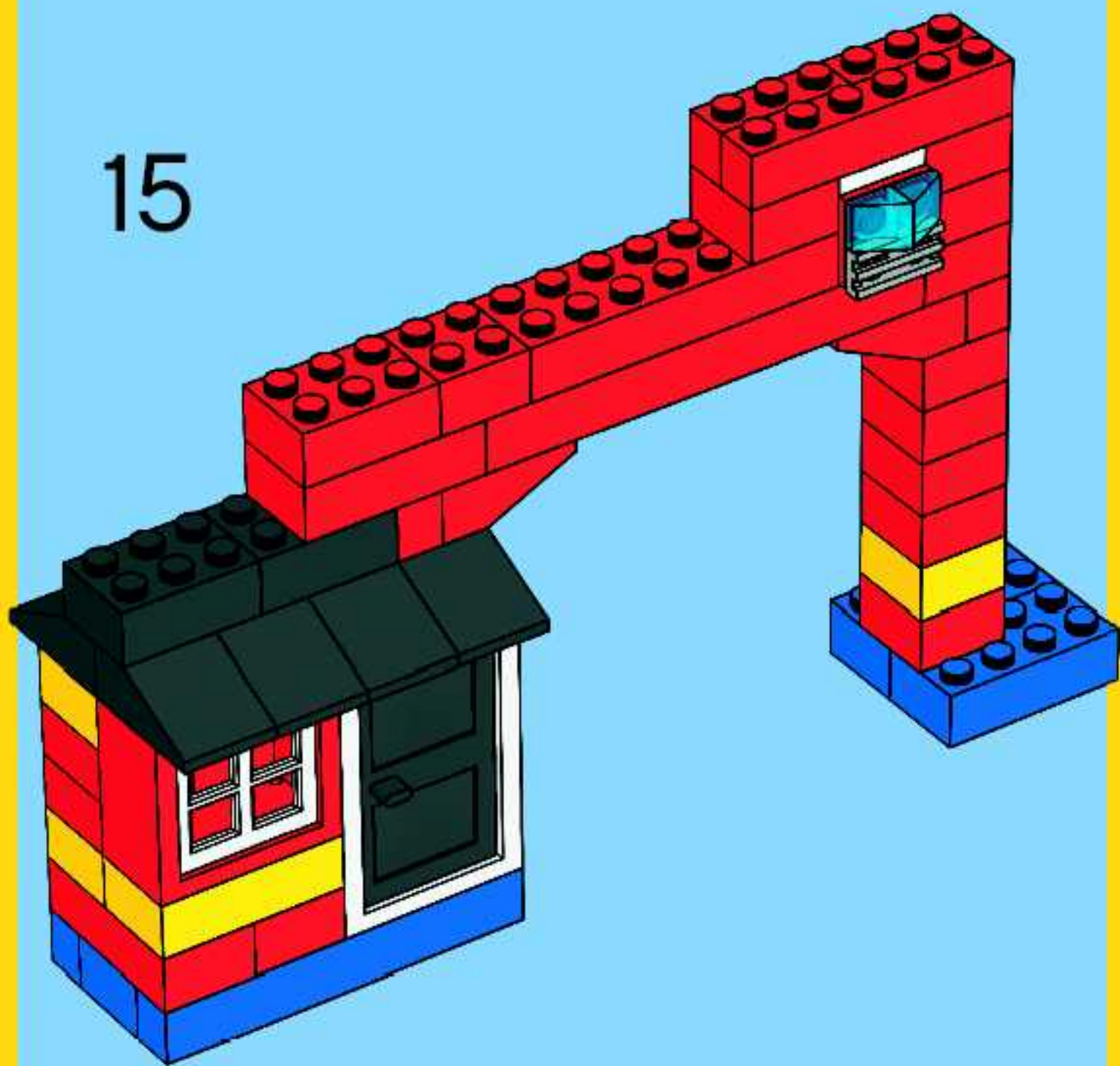

16

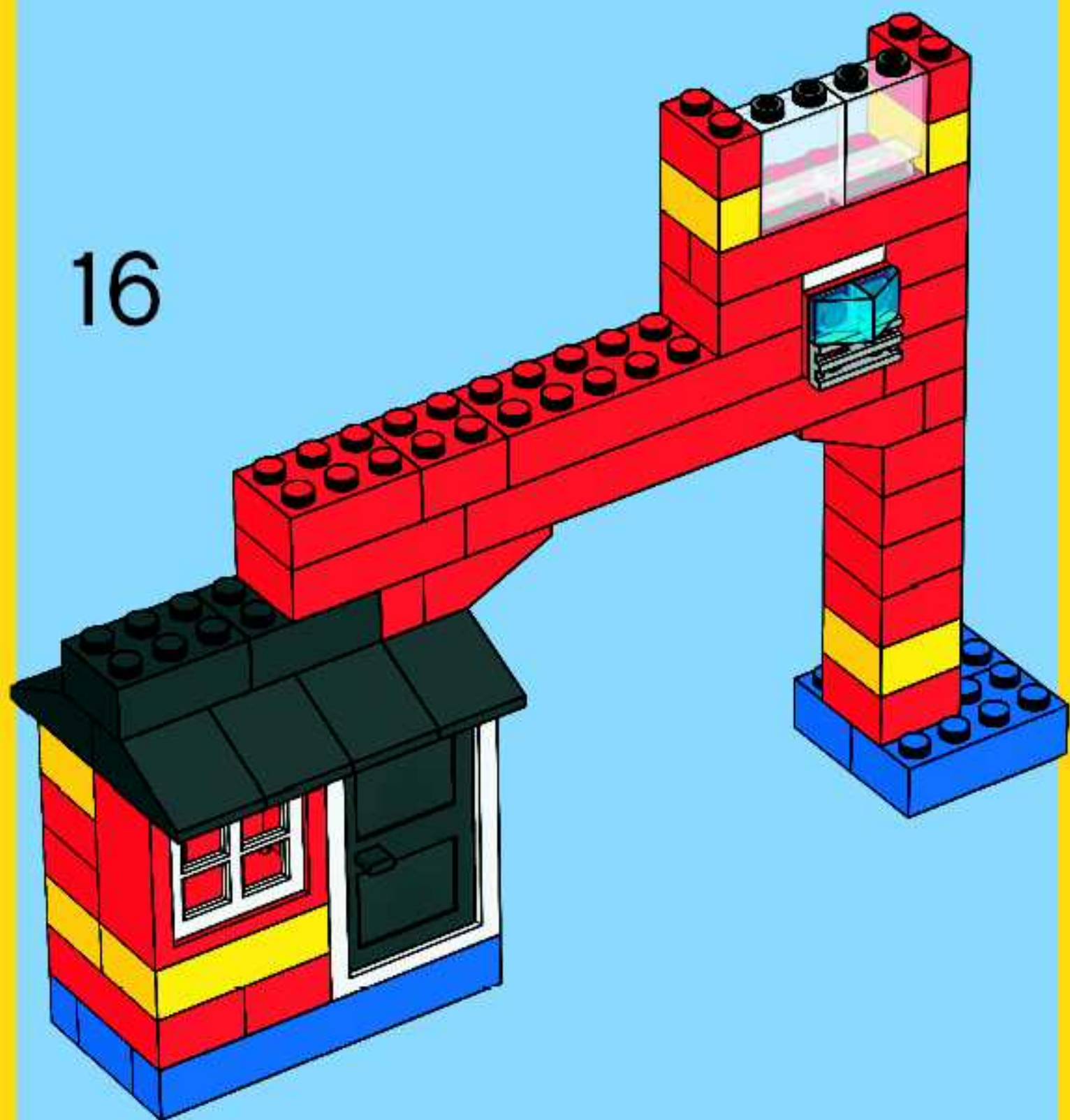

17

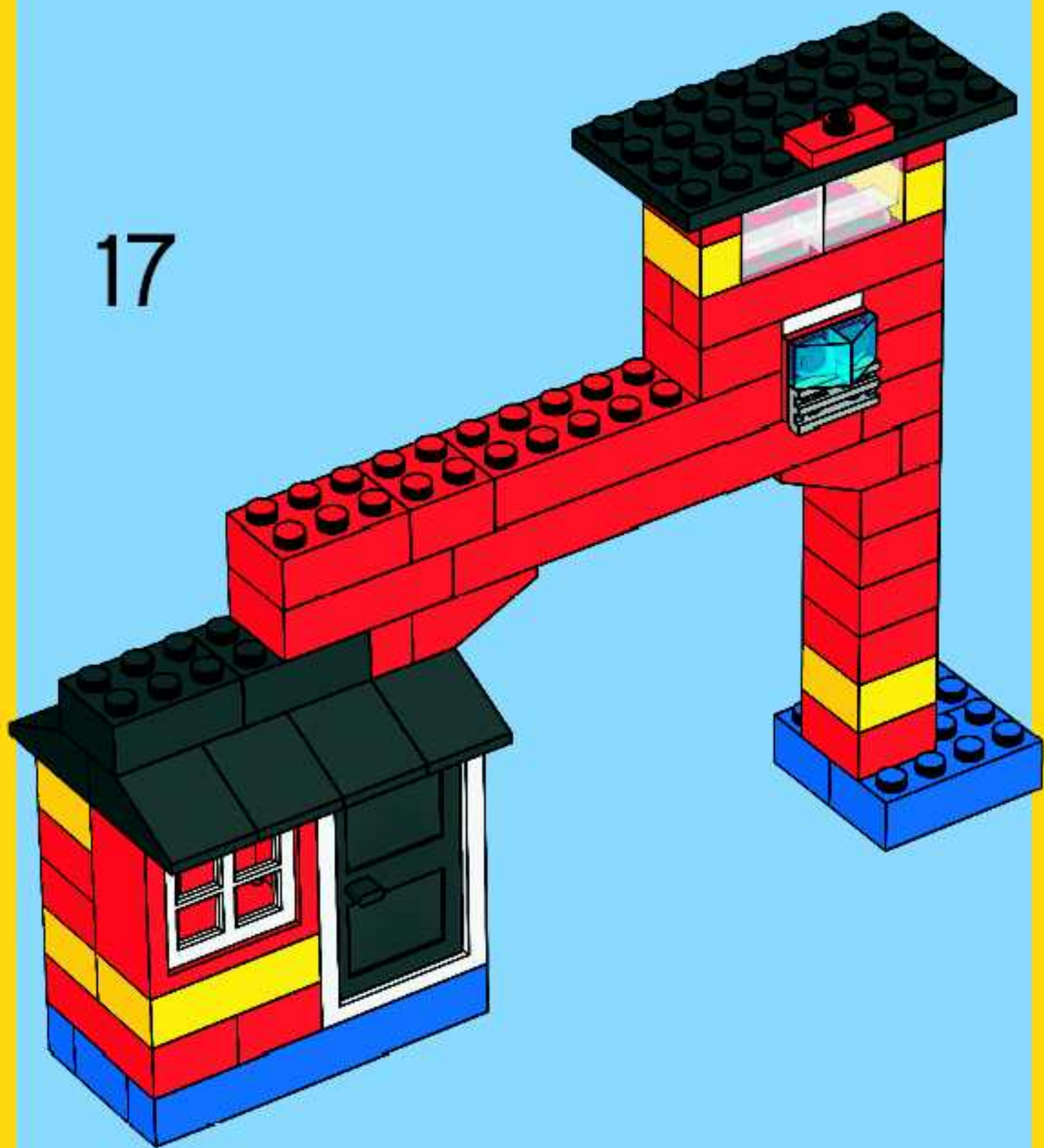

18

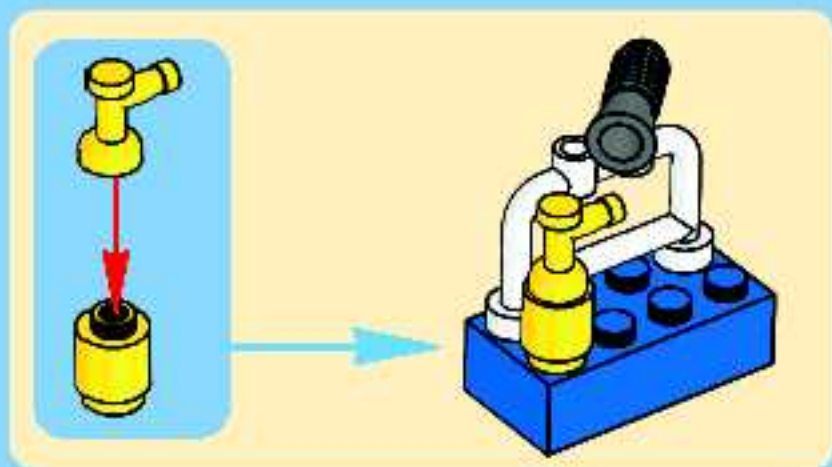







4x
407001



8x
300501



15x
300401



4x
362201



6x
301001



3x
300901



2x
300801



16x
300301



6x
300201



6x
300101



1x
302201



2x
418142



3x
4243812



5x
300701



1x
420701



1x
4503008



1x
9551



2x
4261470



1x
4492344



1x
4282737



4x
242001



3x
302301



3x
366601



1x
340301

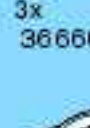

1x
246001



1x
302201



1x
302201



1x
4275843



2x
4173805



2x
4121739



2x
4121967



2x
4121967



2x
73737



4x
4170457



2x
428701



1x
306801



3x
4113220



2x
408301



2x
4218637



1x
4221661



1x
4211232



1x
4275843



2x
4173805



2x
4121739



2x
4121967



2x
4121967



2x
4121967



2x
4121967



2x
4121742



2x
4121737



2x
4153825



2x
4153826



2x
4277933



8x
300521



2x
292121



12x
300421



4x
362221



4x
301021



2x
300821



2x
300821



2x
235721



2x
453221



2x
453221



2x
453221



1x
413221



16x
300321



6x
300221



6x
300121

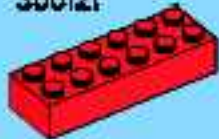

1x
418138



1x
300721

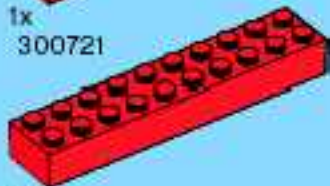

1x
300621



1x
379421



2x
302321



1x
302221



1x
302121



2x
379521



1x
303221



2x
4106915



1x
304321



2x
4144003



2x
366521



4x
303921



2x
4500462



8x
303721



3x
4129539



4x
3005741



4x
3005744



2x
3006844



2x
4154079



2x
4244366



2x
3006843



1x
9566



8x
300523



12x
300423



4x
362223

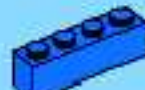

3x
301023



3x
300923



2x
300823



16x
300323



6x
300223



6x
300123

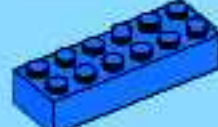

2x
4181139

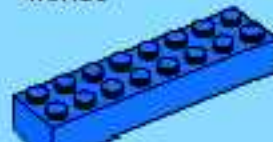

1x
300723



2x
4143291



8x
300524



12x
300424



4x
362224



3x
301024



2x
300924

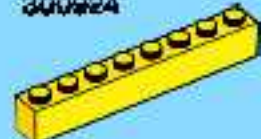

1x
300824



16x
300324



6x
300224

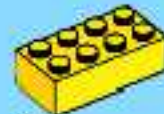

6x
300124

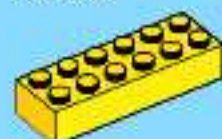

1x
4181143

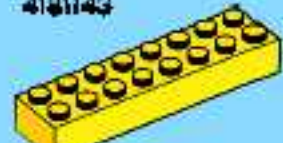

1x
300724



1x
9553



1x
4256320



1x
4186392



1x
306224

1x
393726

8x
329826

4x
300526

6x
300426

2x
362226

2x
301026

8x
300326

3x
300226

3x
300126

2x
4217795

2x
408126

1x
9339

2x
474026

1x
448826

2x
4243819

1x
303526

4x
~~282426~~

2x
346026

1x
4289255

1x
247926

4x
4153005

8x
601526

2x
374128

4x
300528

6x
4107736

2x
4109679

2x
4112838

8x
300328

3x
4109674

3x
4106356

1x
4211473

3x
4211398

1x
4211881

4x
4211350

1x
4211383

4x
4211764

4x
4299119

1x
~~4223363~~

1x
4211717

1x
4211733

2x
306540

2x
4113028

3x
382340

1x
4502193

2x
4210718

2x
4257526

1x
4211061

2x
4210801

1x
4210698

2x
4210636

Win!

Gagne! 当たります

Gewinne!



Win LEGO products

We would like to know what you think about your new LEGO product. Log on to the web address below for further instructions.

Gagne des produits LEGO

Nous aimerions savoir ce que tu penses de ton nouveau produit LEGO. Tu obtiendras davantage d'informations en visitant le site Internet indique ci-dessous.

Gewinne LEGO produkte

Wir sind sehr an deiner Meinung über dein neues LEGO Produkt interessiert. Gehe einfach zu der unten angegebenen Webadresse – dort findest du weitere Informationen.

Estimado usuario LEGO

Al contestar algunas preguntas en inglés, francés, alemán o japonés, en el sitio www.acnielsen.aim.dk/lego, podrás participar en el sorteo de algunos valiosos premios LEGO.

Caro Consumidor da LEGO

Ao responder a algumas perguntas em Inglês, Francês, Alemão ou Japonês no endereço www.acnielsen.aim.dk/lego irá participar num concurso para ganhar valiosos prémios da LEGO.

Kedves ifjú LEGO Vásárló

Ha ellátogatsz a www.acnielsen.aim.dk/lego honlapra és ott angol, francia, német vagy japán nyelven megválaszolsz néhány kérdést, akkor részt veszel egy versenyben, amelyben értékes LEGO díjakat nyerhetsz.

抽選でレゴ製品が当たります

私たちは、皆さんがご買い求めのレゴ製品についてどんな感想をお持ちか、知りたいと思っています。質問に答えて、楽しいレゴ製品の抽選に当選しちゃうかも。アンケートの回答には、ほんのわずかですがお礼をさせていただきます。詳しくは、以下のウェブアドレスまでアクセスしてください。

www.acnielsen.aim.dk/LEGO



Any questions regarding your new LEGO product, please contact:

Customer Service | Kundenservice

Service Consommateurs

Servicio Al Consumidor at

www.lego.com/service or dial

:

00800 5346 5555

:

1-800-422-5346





club™



FREE LEGO Magazine • GRATUIT • GRATIS LEGO Magazin



Join Today!
.....
Abonne-toi
dès aujourd'hui !
.....
Meld je nu aan!
.....
Jetzt anmelden!



US & Canada only

1-866-534-6258 / 1-877-518-5346

(en français)

00800 5346 5555



www.LEGOclub.com



VISIT THE
**WORLD'S BIGGEST
LEGO® SHOP!**
www.LEGOshop.com