

# BIONICLE®



8618

VAHKI RORZAKH





# METRU NUI



PO-METRU



ONU-METRU



KO-METRU

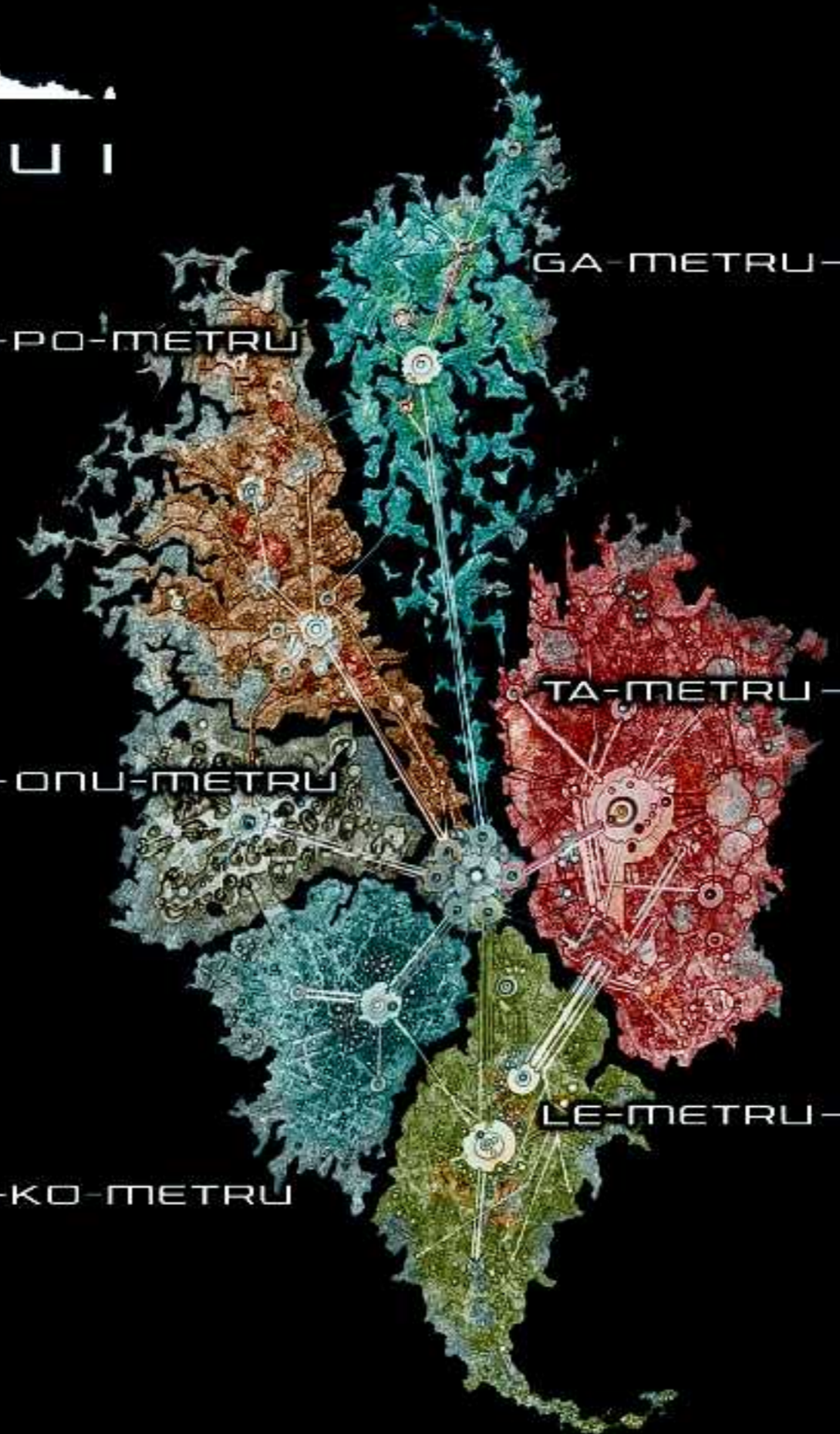

GA-METRU

TA-METRU

LE-METRU





1



2

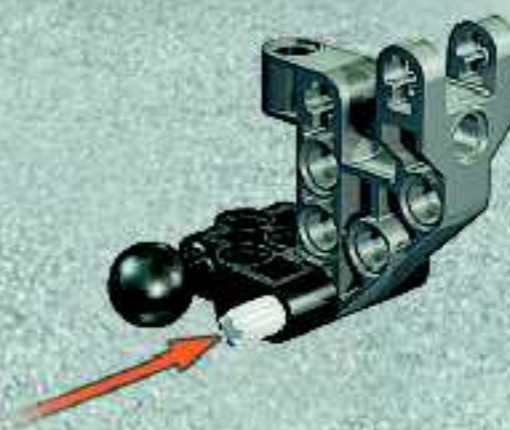

3

1:1

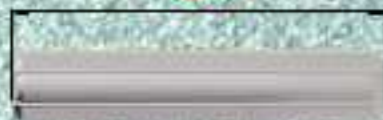



3

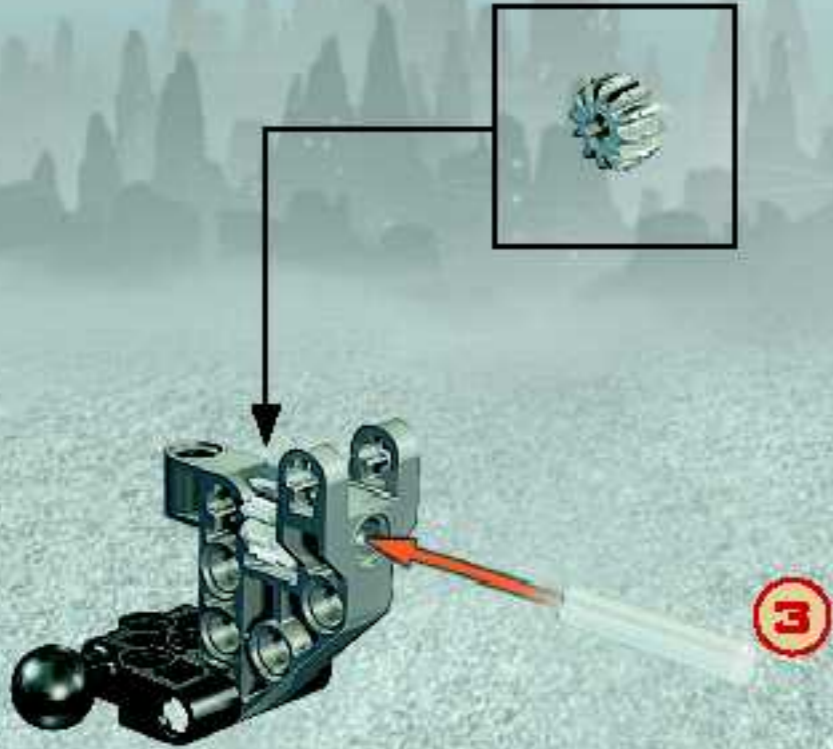

4





5

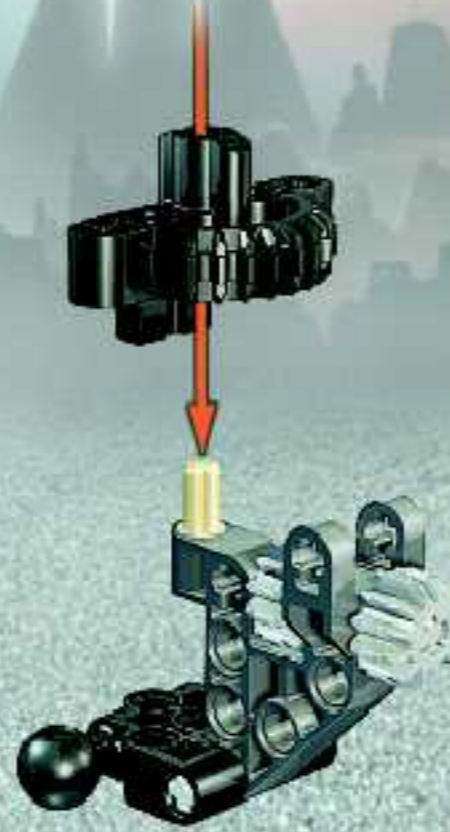



6

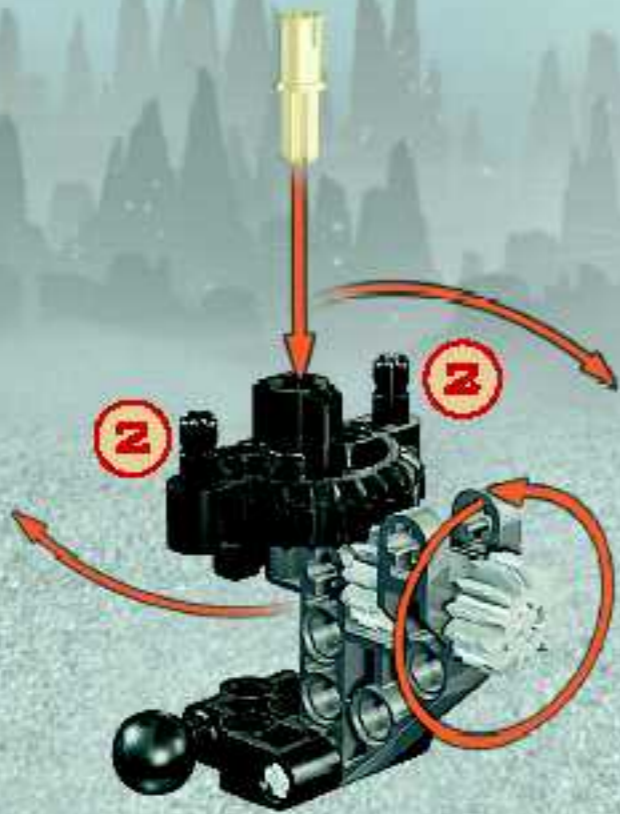

7

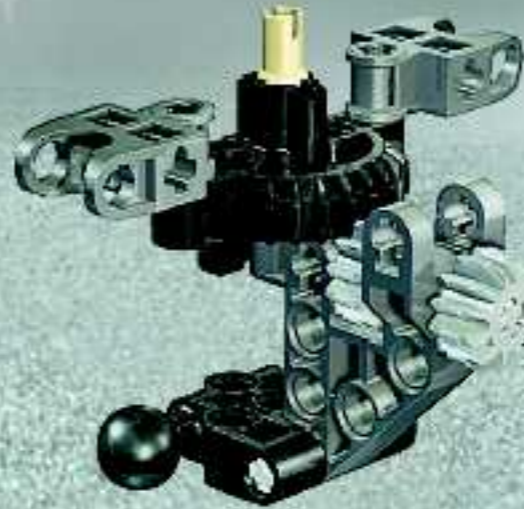

2

1:1





8

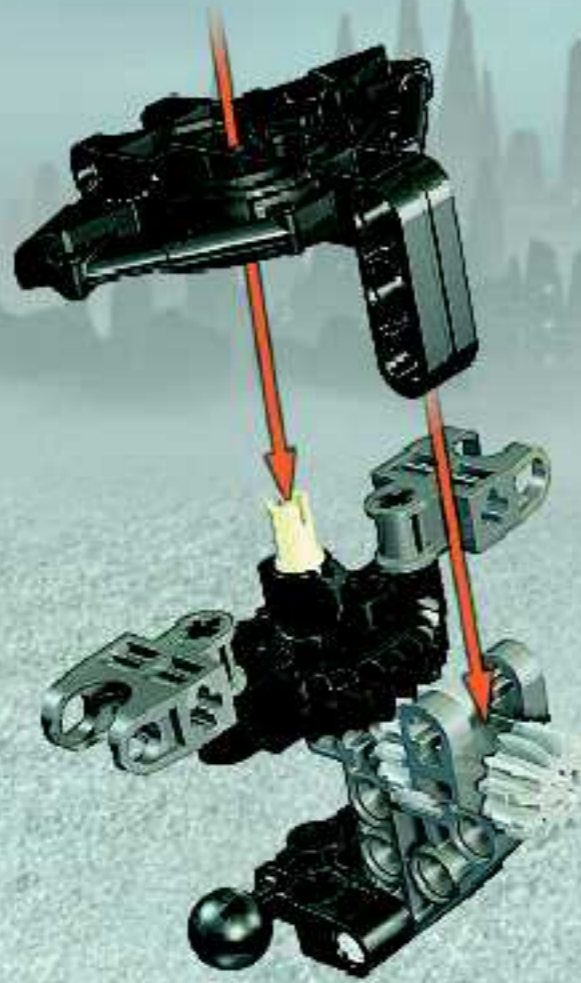

9

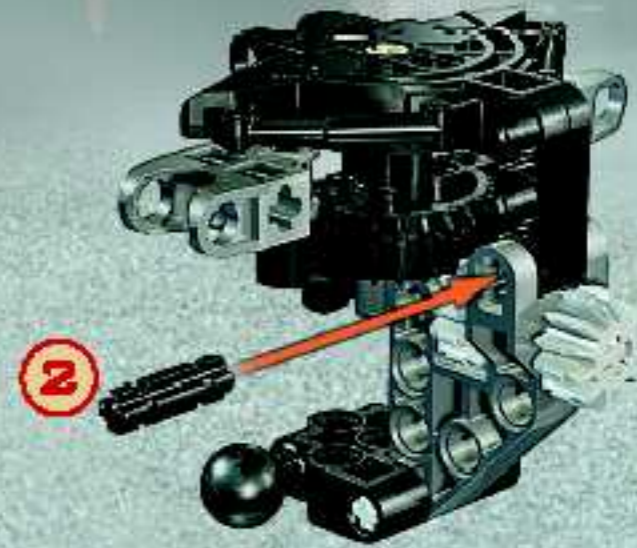

1:1

2





1



8

2



3



2x



11



12

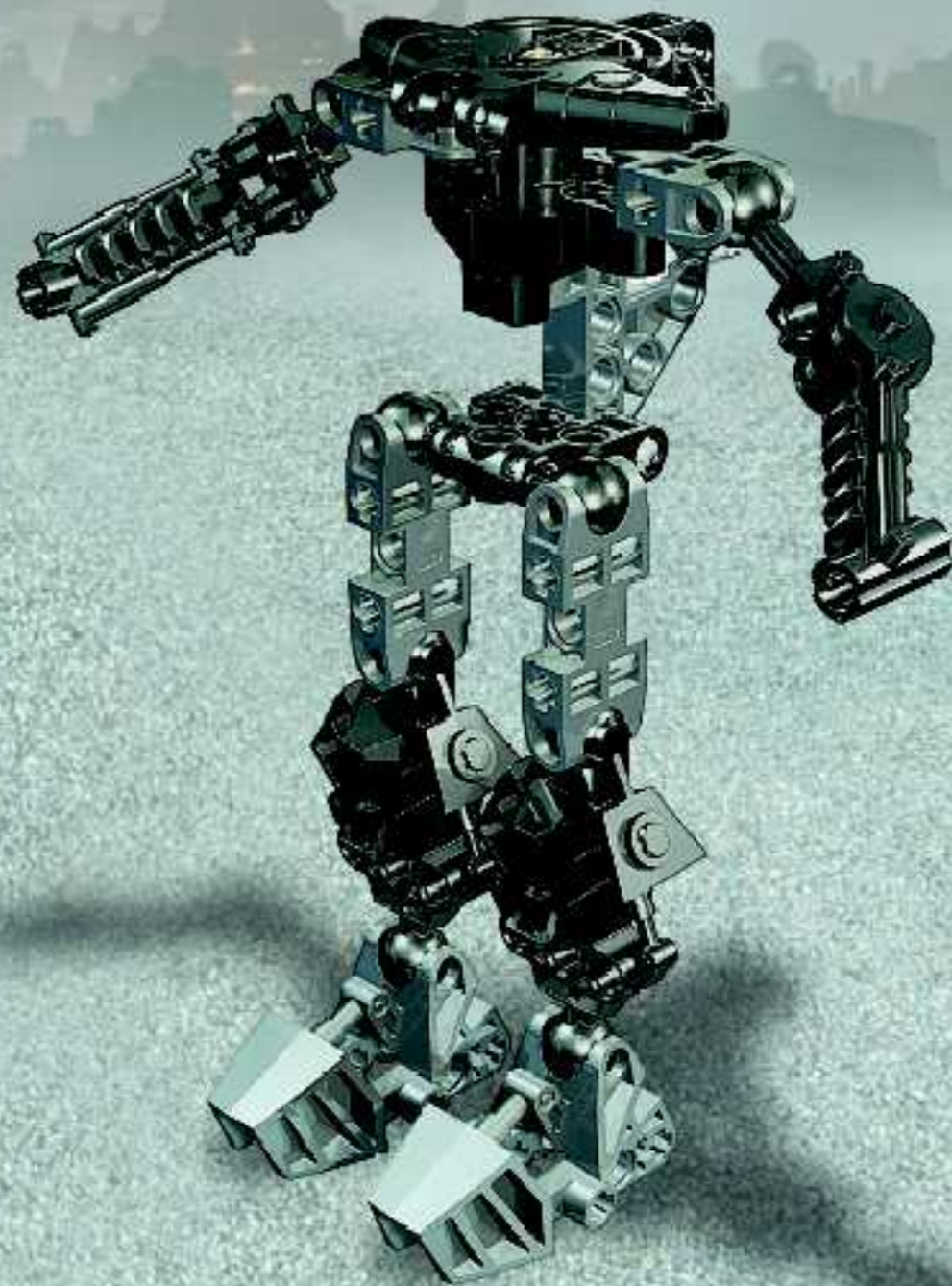



13

1

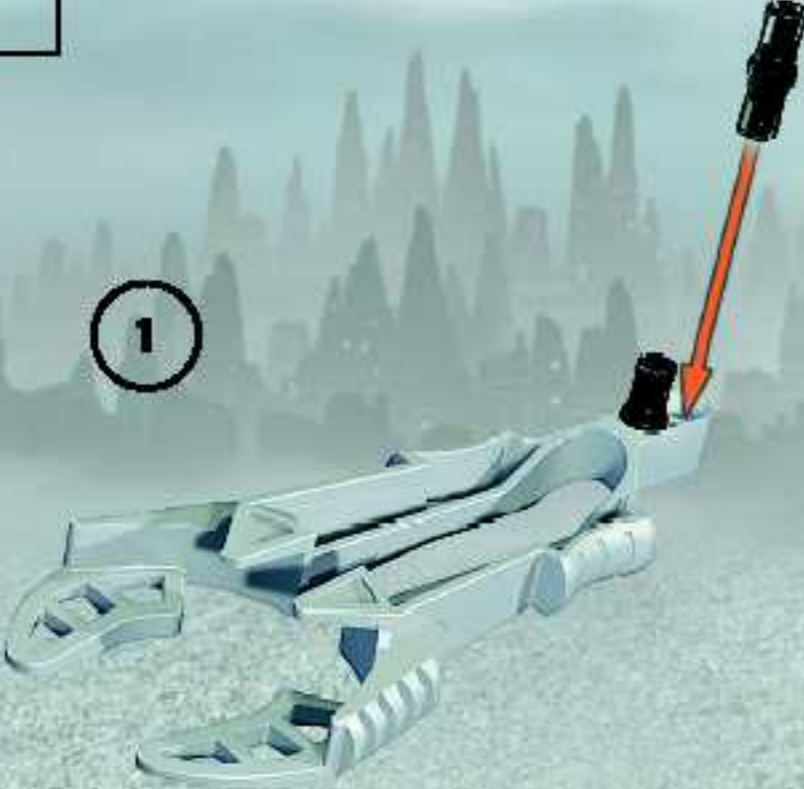

2





3



4

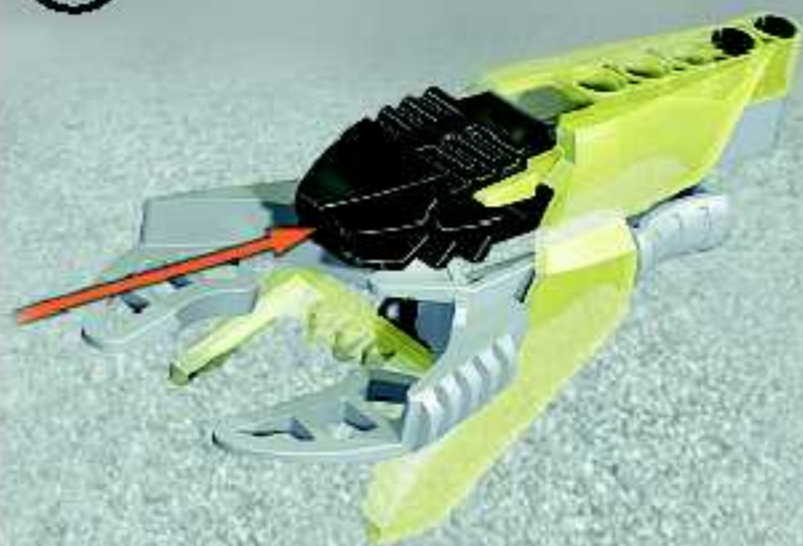

5









15





1

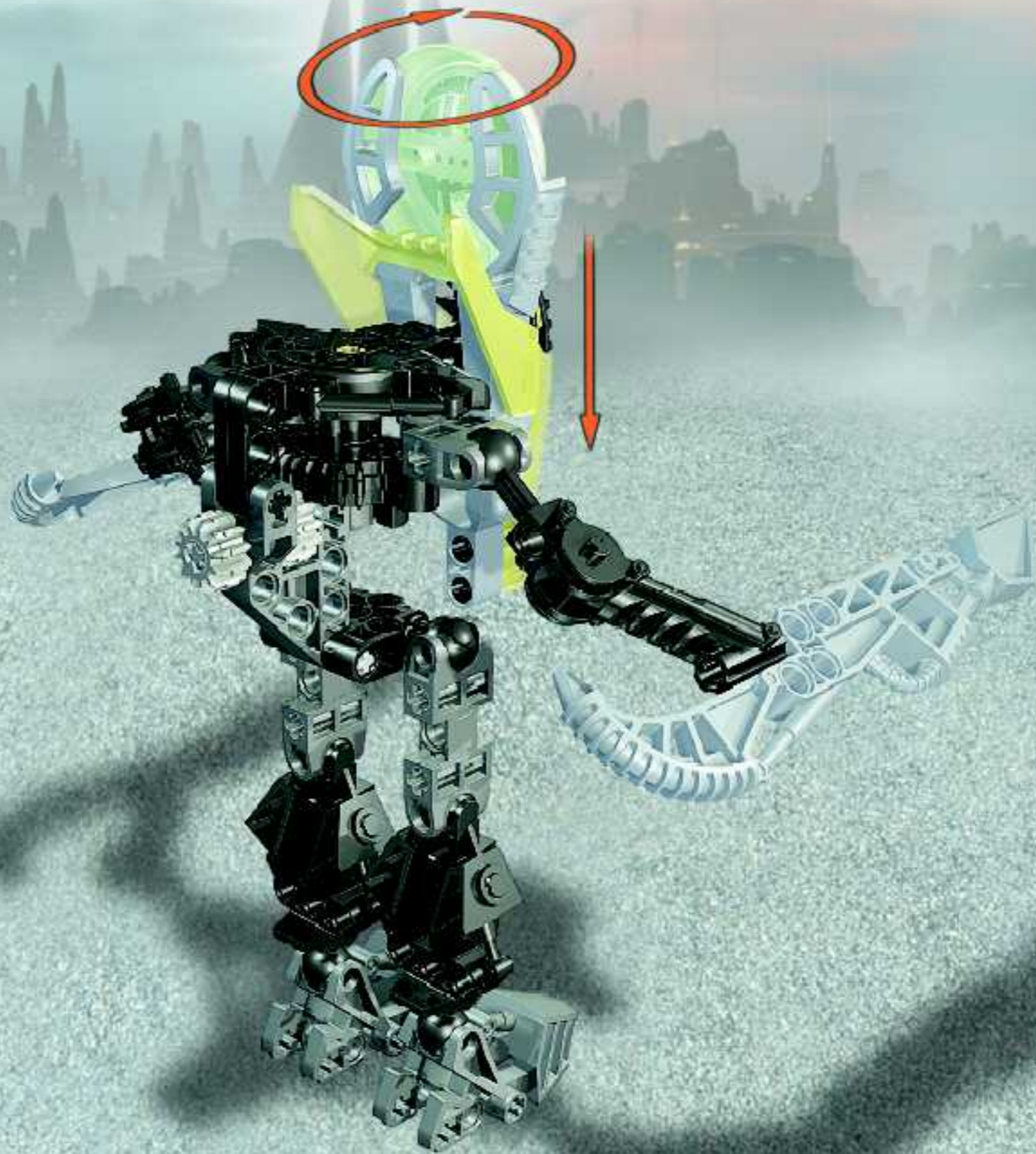



2





3

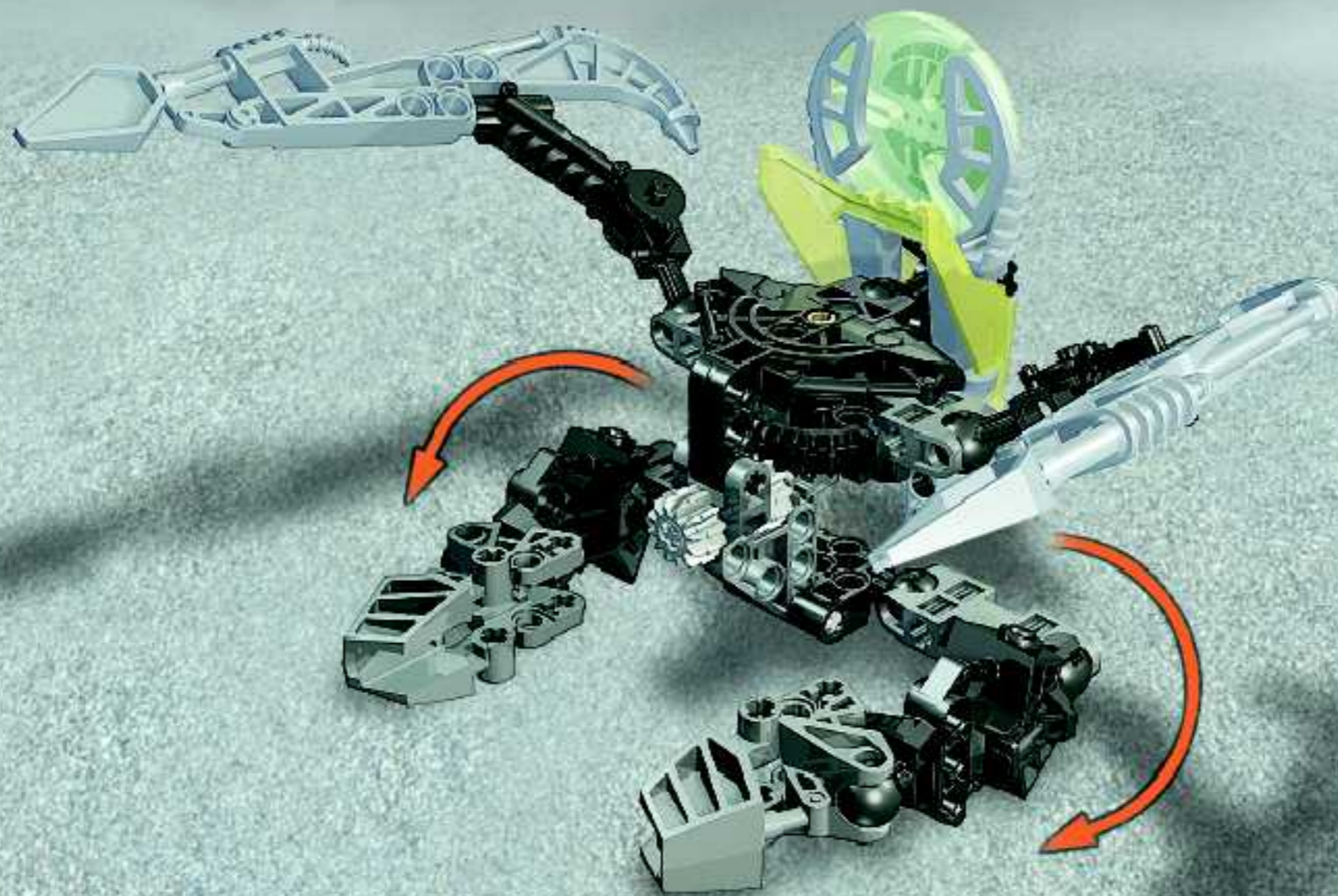



4





1



2









8614



+

8616



+

8618





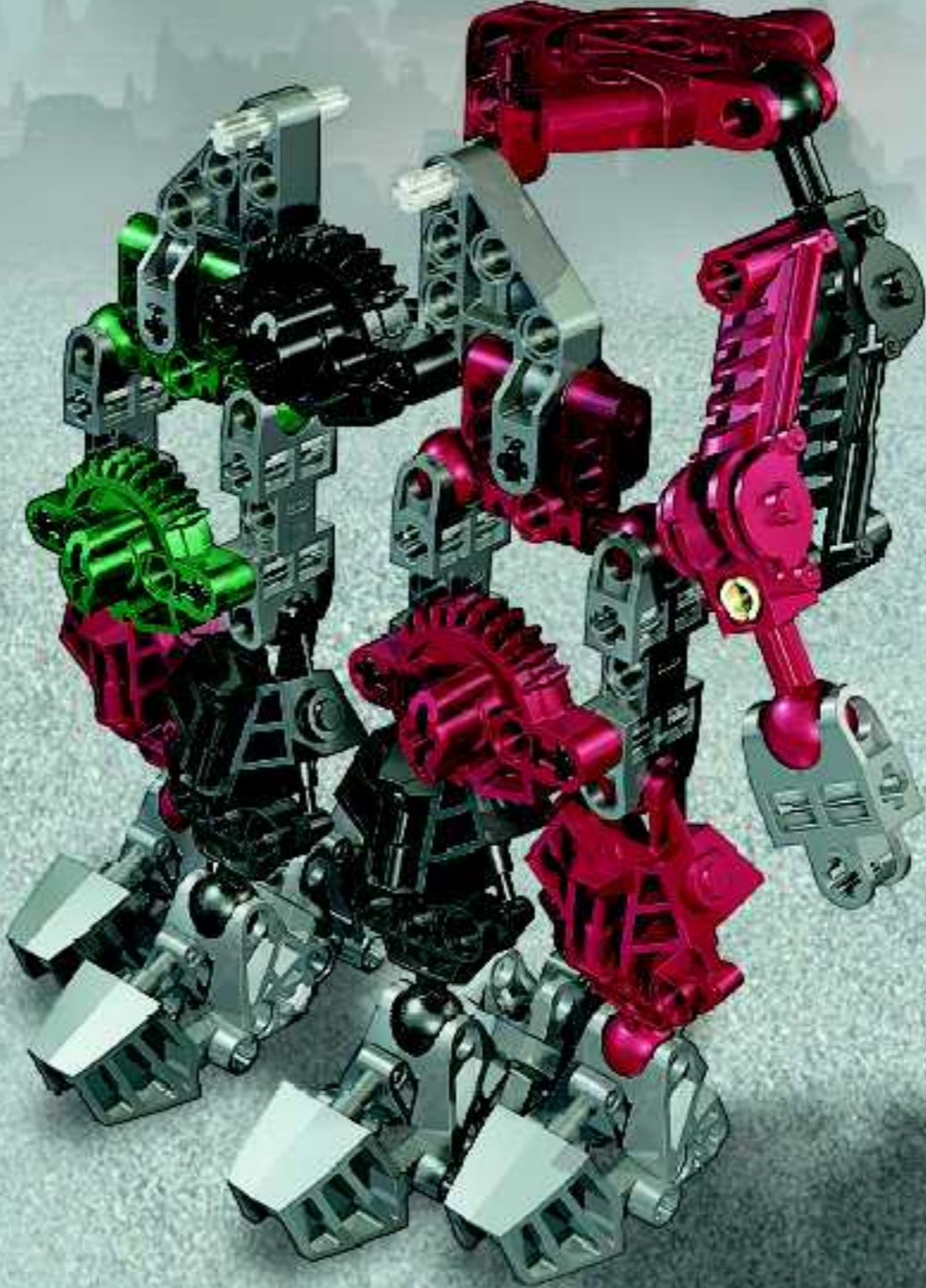



1



2





3









15

1



2





3



4









VAHKI  
KEERAKH  
8619



VAHKI  
VORZAKH  
8616

VAHKI  
PUURAKH  
8614







VAHKI  
RORZAKH  
8618

A LEGO Bionicle Vahki Rorzakh, a black and yellow mechanical warrior with a large, complex headpiece and multiple articulated limbs. It is shown in a dynamic pose, appearing to be in the process of being assembled or disassembled, with its parts floating in the air. The background is a warm, orange and red gradient.



VAHKI  
BORDAKH  
8615

A LEGO Bionicle Vahki Bordakh, a blue and orange mechanical warrior with a large, complex headpiece and multiple articulated limbs. It is shown in a dynamic pose, appearing to be in the process of being assembled or disassembled, with its parts floating in the air. The background is a cool, blue and white gradient.



VAHKI  
ZADAKH  
8617

A LEGO Bionicle Vahki Zadakh, a blue and red mechanical warrior with a large, complex headpiece and multiple articulated limbs. It is shown in a dynamic pose, appearing to be in the process of being assembled or disassembled, with its parts floating in the air. The background is a warm, orange and red gradient.





8607 NUHRRI



8608 VHISOLA



8609 TEHUTTI



8610 AHKMOU

# M A T O R A N



8611 ORKAHM



8612 EHRVE



7+

8613

LEGO



[www.bionicle.com](http://www.bionicle.com)



# Win! Gagne! Gewinne! 当たります



## WIN LEGO® PRODUCTS

We would like to know what you think about our new LEGO® product. If you could help us by answering a few questions you are in with a chance of winning an exciting LEGO prize. It will only take you about 3 minutes! Log on to the web address below for further instructions.



## Estimado usuario LEGO®

Al contestar algunas preguntas en Inglés, francés, alemán o japonés, en el sitio [www.acnielsen.aim.dk/lego](http://www.acnielsen.aim.dk/lego), podrás participar en el sorteo de algunos valiosos premios LEGO®.



## 英語でLEGO®製品が当たります

私たちは、皆さんが新しいLEGO®製品についてどんな感想をお持ちか、知りたく思っています。質問に答えて、新しいLEGO®製品の抽選に参加できます。アンケートの回答には、日本のLEGO®ショップが当たるチャンスです。以下ウェブアドレスまでアクセスしてください。



## GAGNE DES PRODUITS LEGO®

Nous aimerions savoir ce que tu penses de ton nouveau produit LEGO®. Si tu veux bien nous aider en répondant à quelques questions, tu recevras peut-être bientôt un fantastique prix LEGO. Et cela ne te prendra que 3 minutes environ ! Tu obtiendras davantage d'informations en visitant le site Internet indiqué ci-dessous.



## Caro Consumidor da LEGO®

Ao responder a algumas perguntas em Inglês, Francês, Alemão ou Japonês no endereço [www.acnielsen.aim.dk/lego](http://www.acnielsen.aim.dk/lego) irá participar num concurso para ganhar valiosos prémios da LEGO®.



## GEWINNE LEGO® PRODUKTE

Wir sind sehr an deiner Meinung über dein neues LEGO® Produkt interessiert. Wenn du uns den Gefallen tust und ein paar Fragen beantwortest, kannst du einen tollen LEGO Preis gewinnen. Das Ganze dauert nur etwa 3 Minuten! Gehe einfach zu der unten angegebenen Webadresse - dort findest du weitere Informationen.



## Kedves Új LEGO® Vásárló

Ha elértogat az [www.acnielsen.aim.dk/lego](http://www.acnielsen.aim.dk/lego) honlapra és ott angol, francia, német vagy japán nyelven megválaszolsz néhány kérdést, akkor részt vehetsz egy versenyben, amelyben értékes LEGO® díjakat nyerhetsz.

[www.acnielsen.aim.dk/LEGO](http://www.acnielsen.aim.dk/LEGO)







BIONICLE<sup>®</sup>

# 2

LEGENDS OF  
METRU NUI



[www.bioniclemovies.com](http://www.bioniclemovies.com)

