



CITY

5-12  
7901

4294924



1

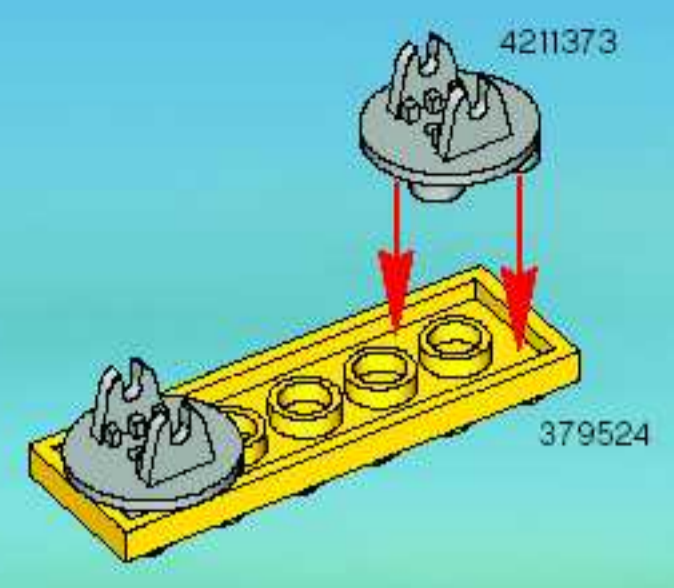

2

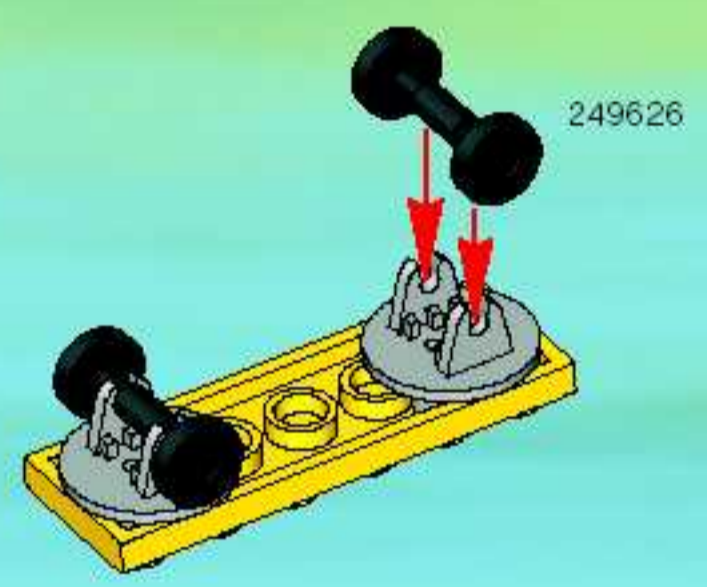

3

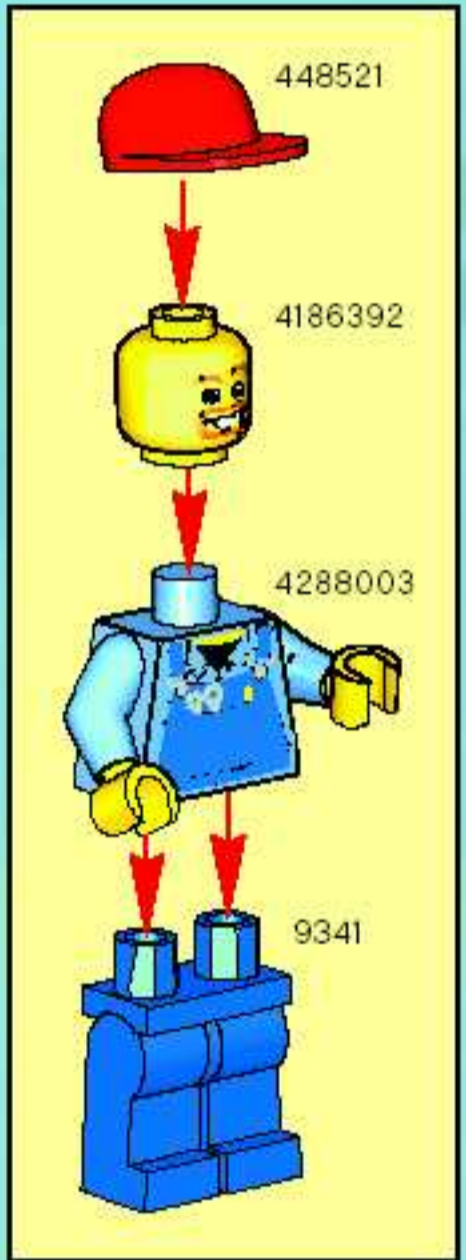
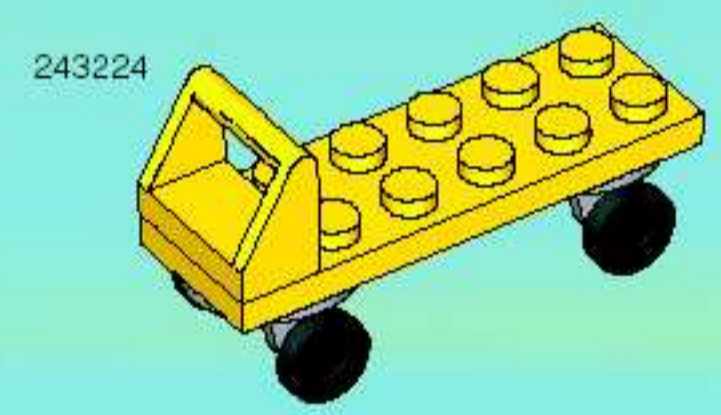

1

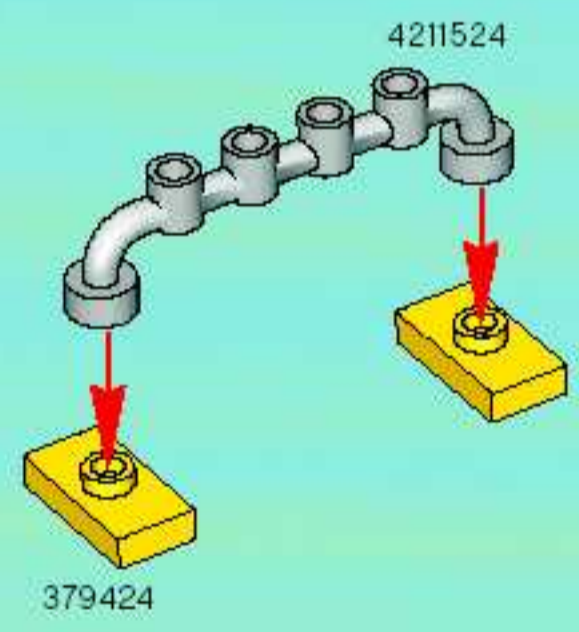

2



1

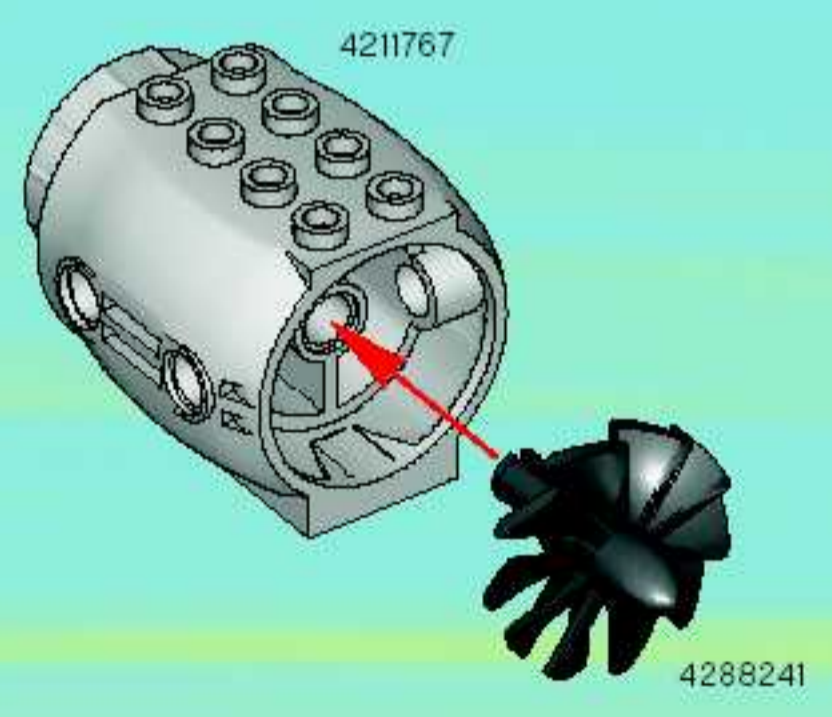

2



1

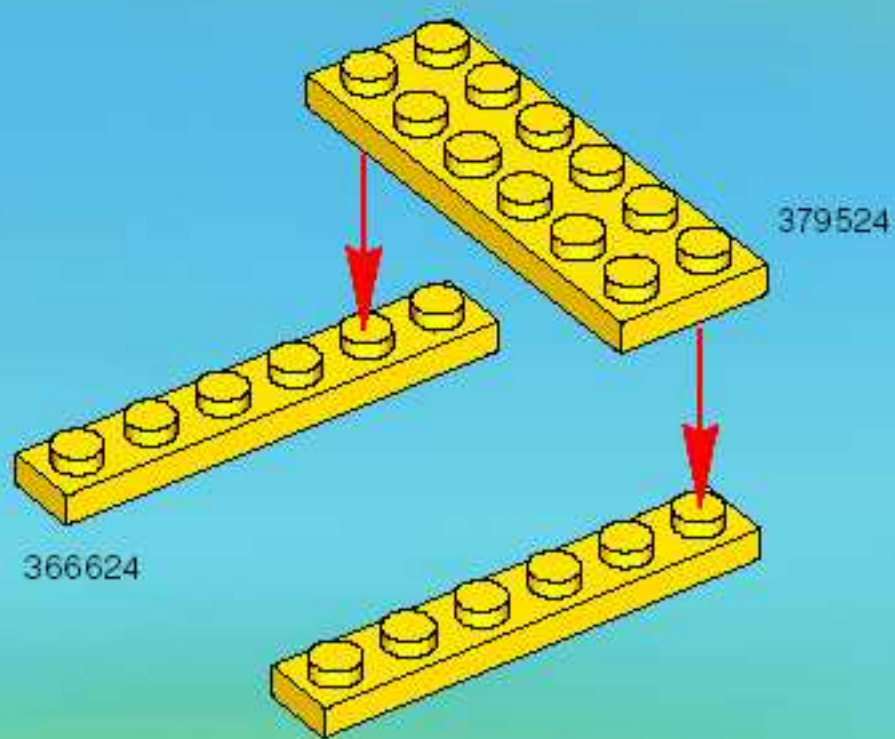

2

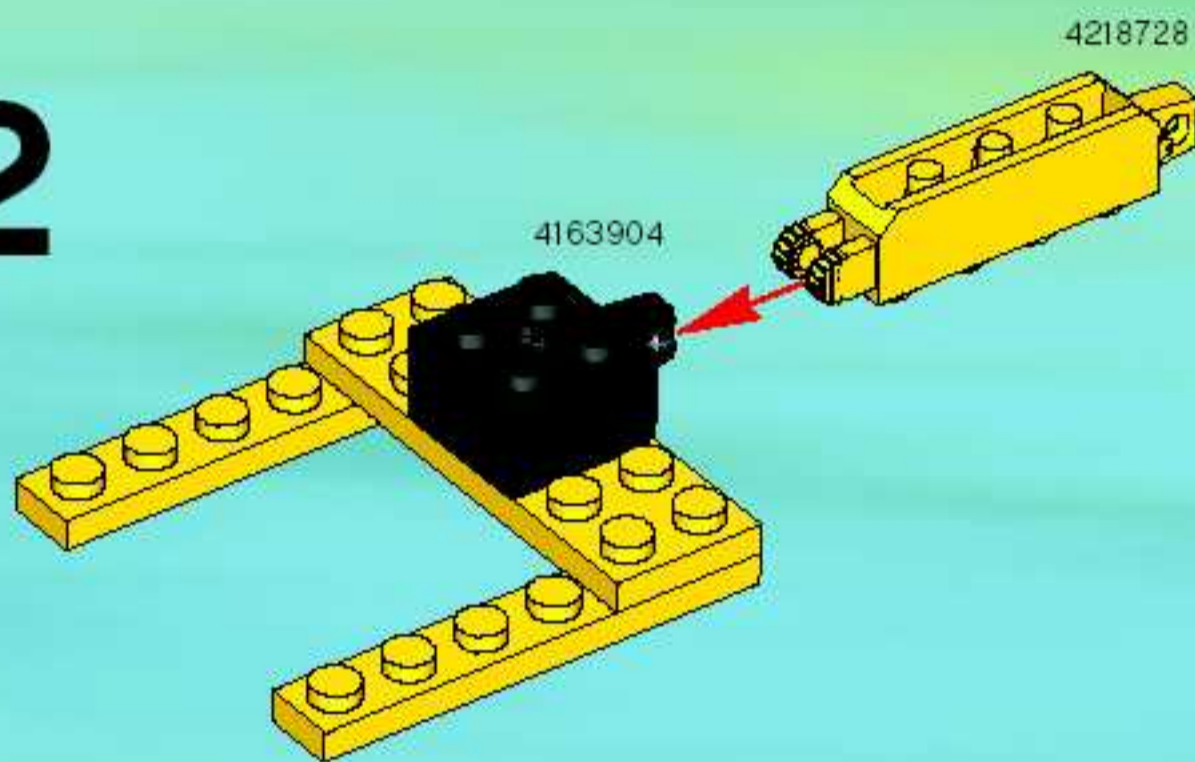

3

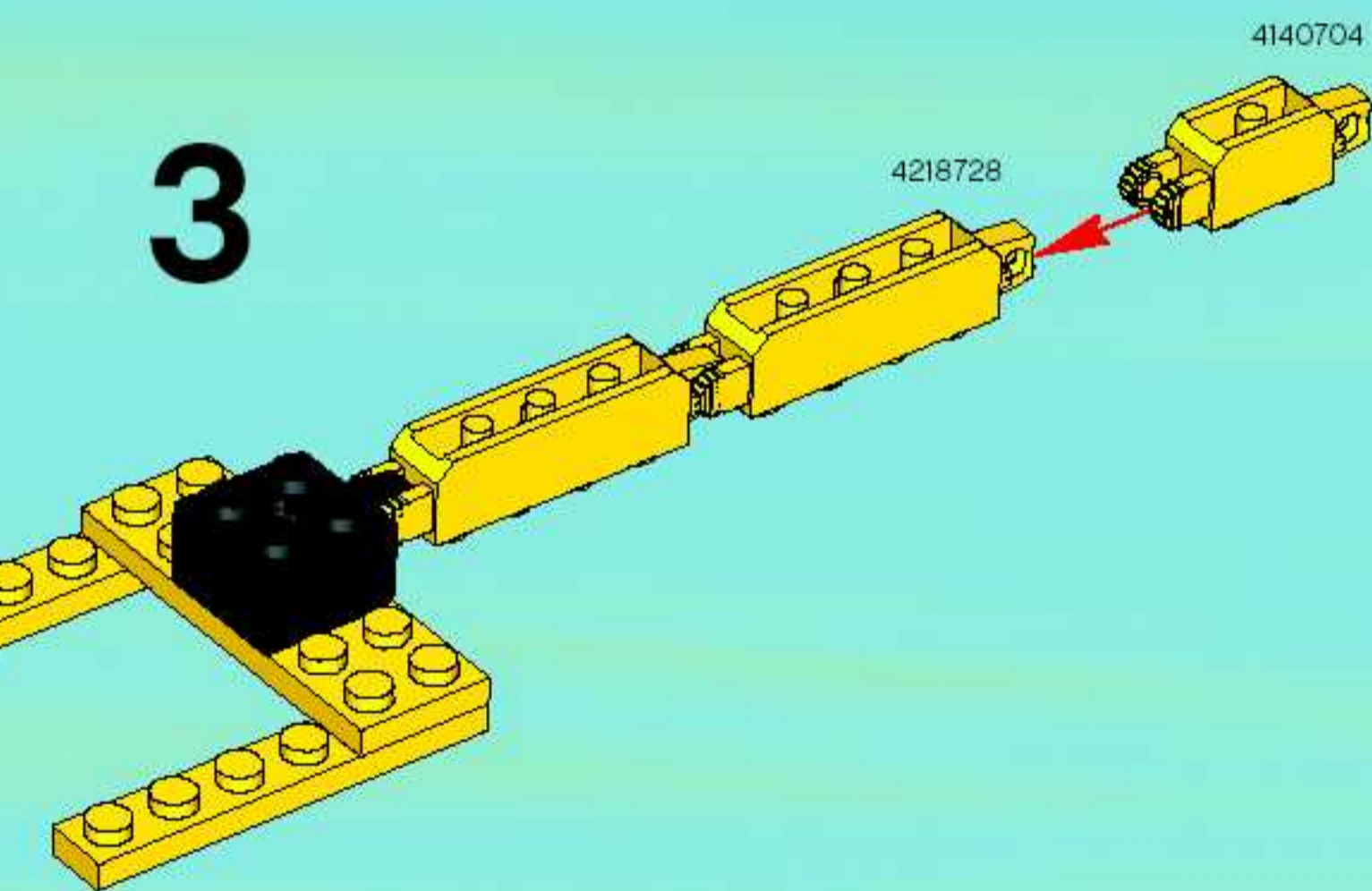

4

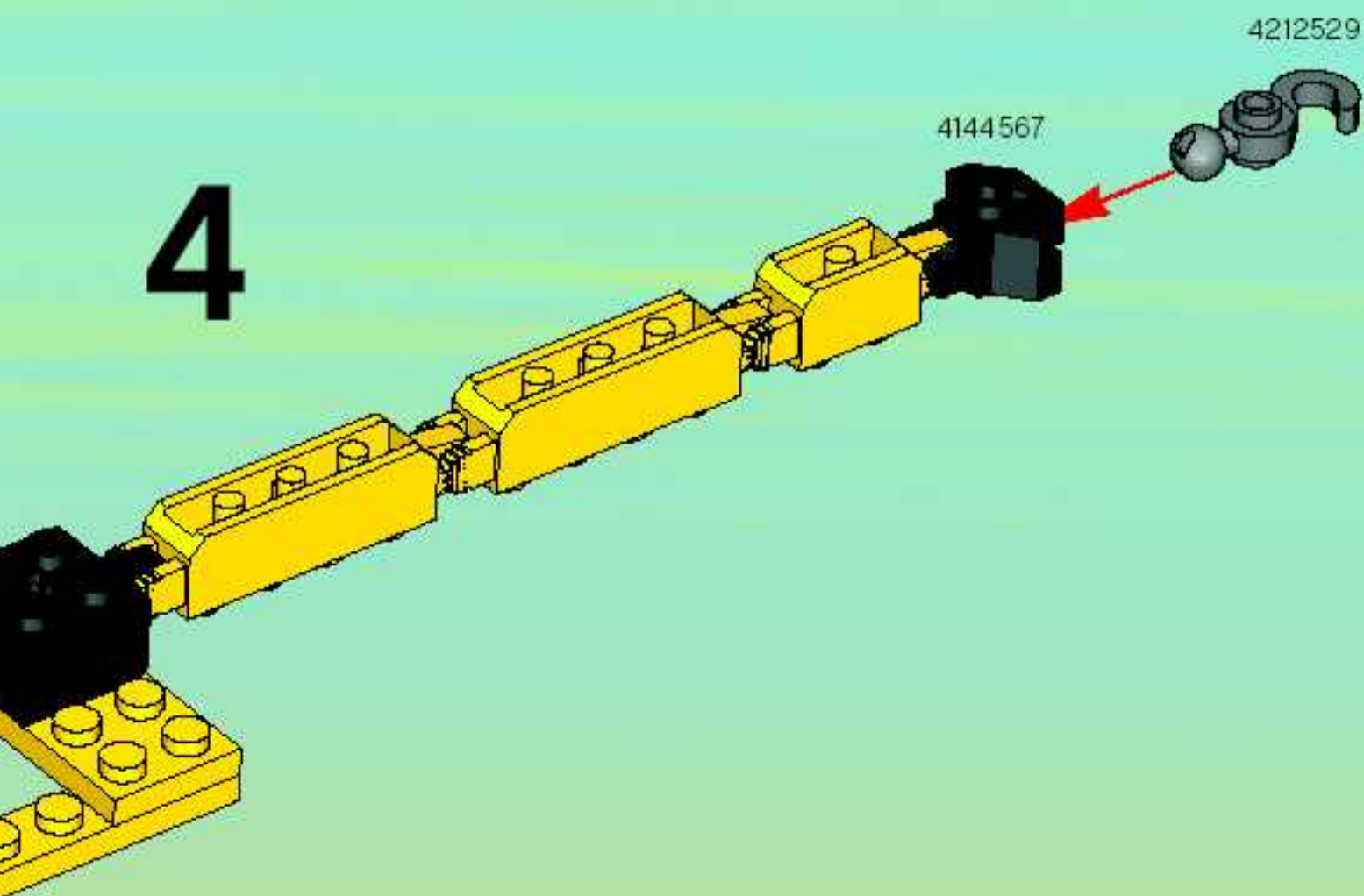

5

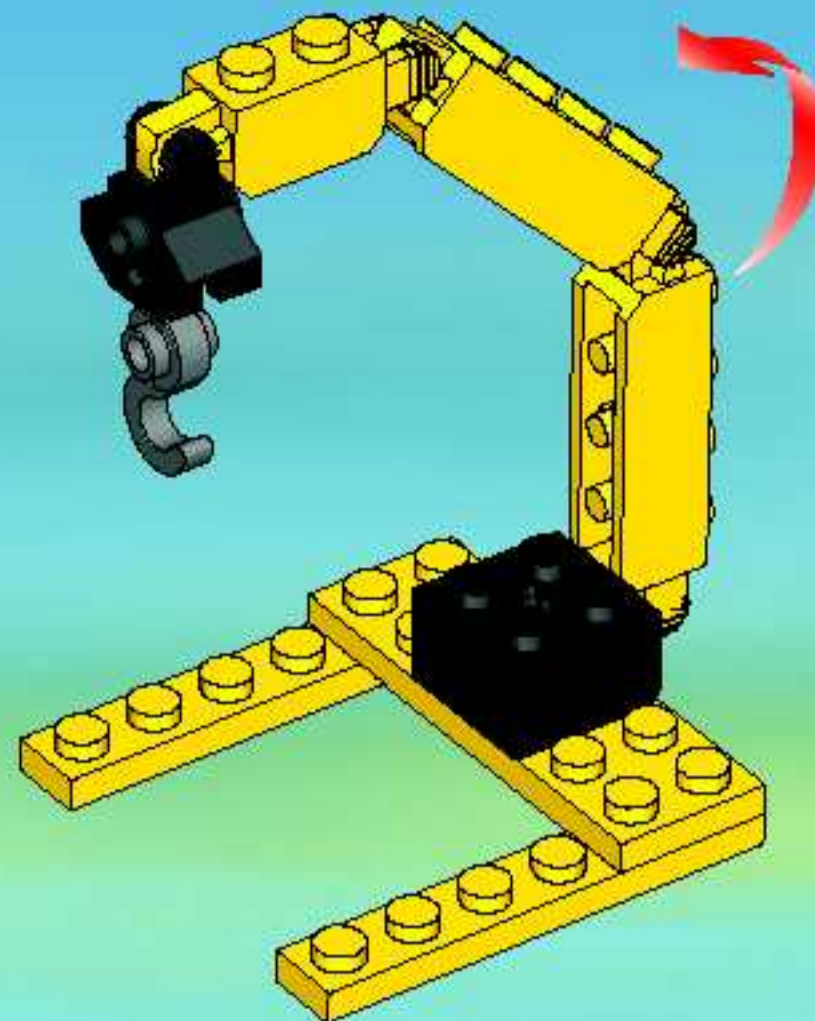

6

