

The LEGO logo is displayed in its characteristic white font with a black outline, set against a red rectangular background.

DC UNIVERSE™

**SUPER
HEROES**



6863



WARNING: CHOKING HAZARD.
Toy contains small parts and a small ball.
Not for children under 3 years.



TM

1

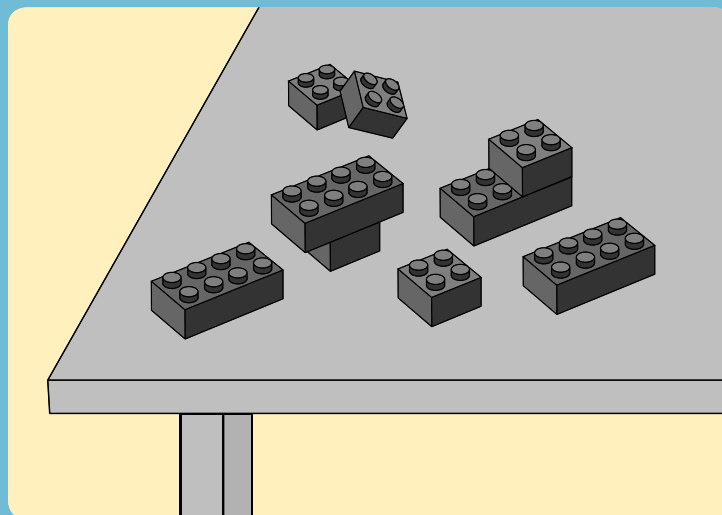
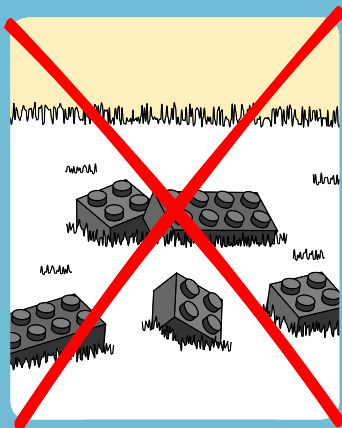

2



⚠️ AVERTISSEMENT : RISQUE D'ÉTOUFFEMENT.
Le jouet contient des petites pièces ainsi qu'une petite boule.
Il ne convient pas aux enfants de moins de 3 ans.

⚠️ ADVERTENCIA: PELIGRO DE ASFIXIA.
Juguete que contiene partes pequeñas y una pelota pequeña.
No recomendado para niños menores de 3 años.

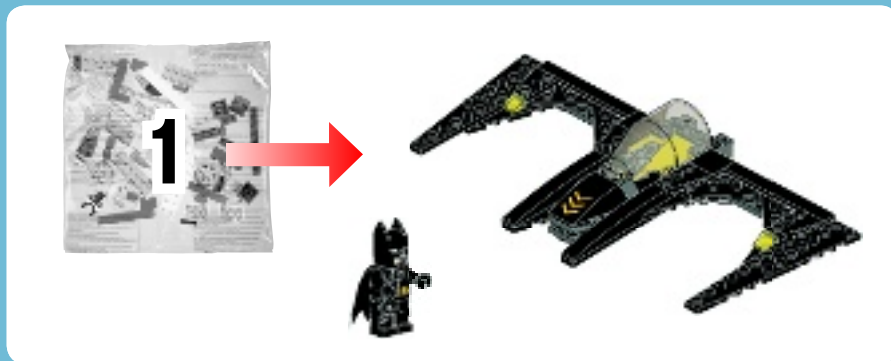
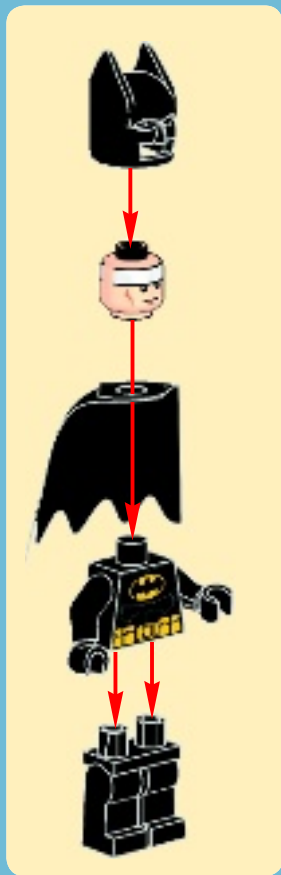



1



2

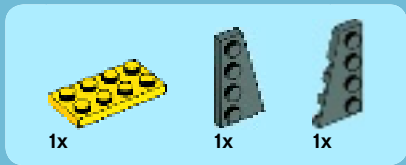

3

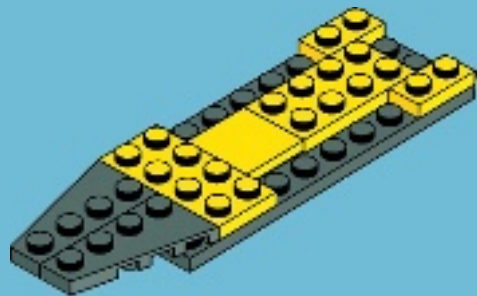



1x

4

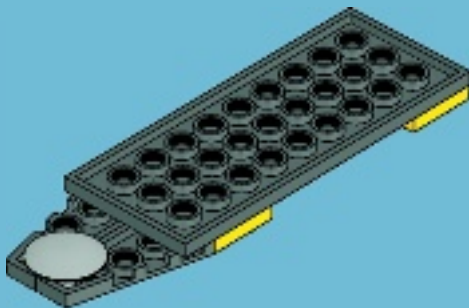

2x



1x



2x

5

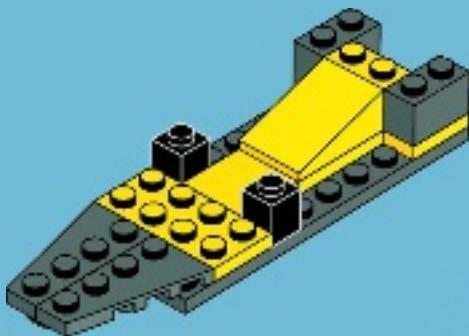

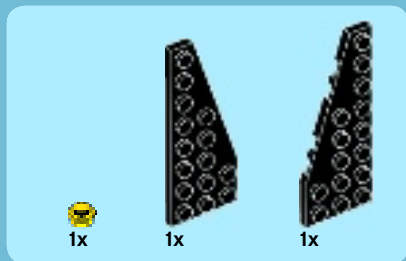

6

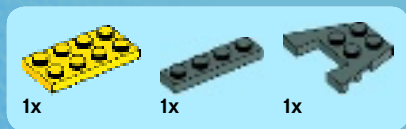
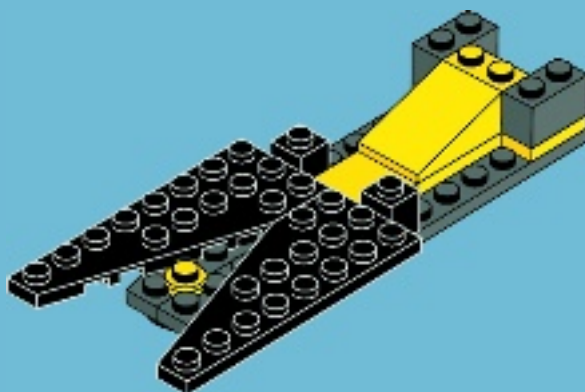

7

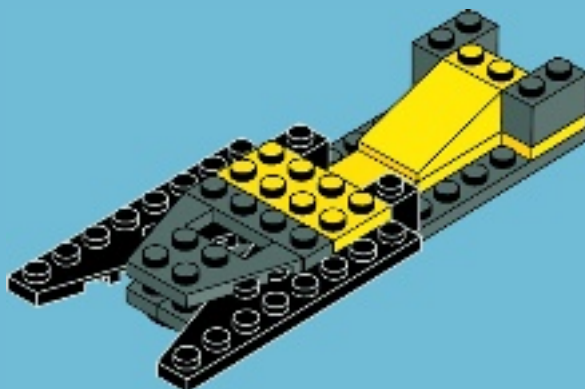



2x



2x

8

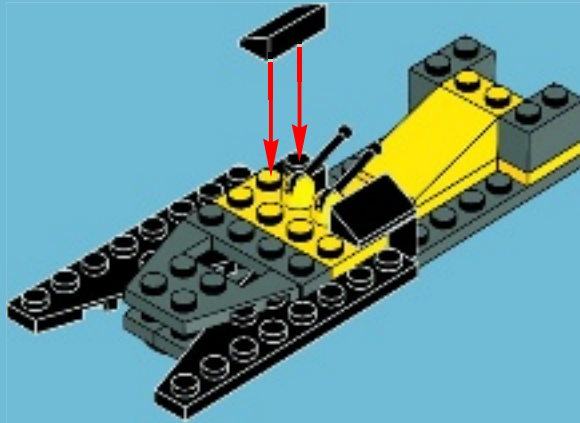

1x



2x

9

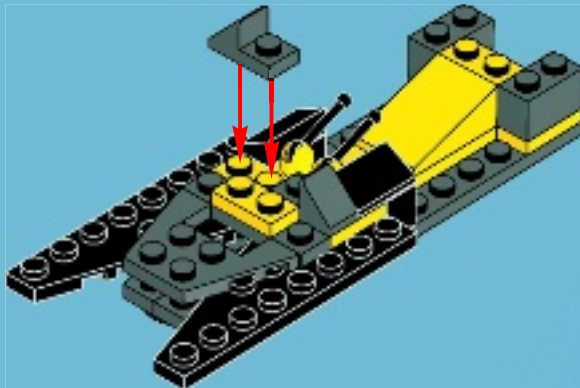



2x

10

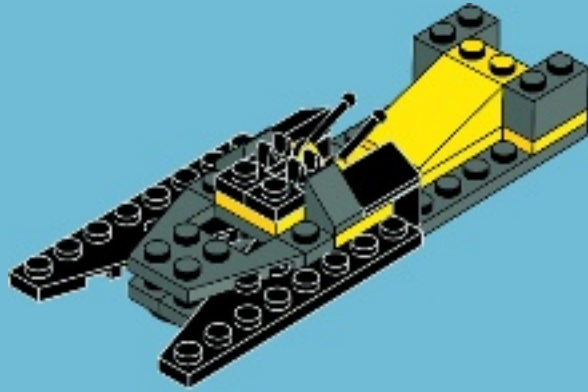

1x

11

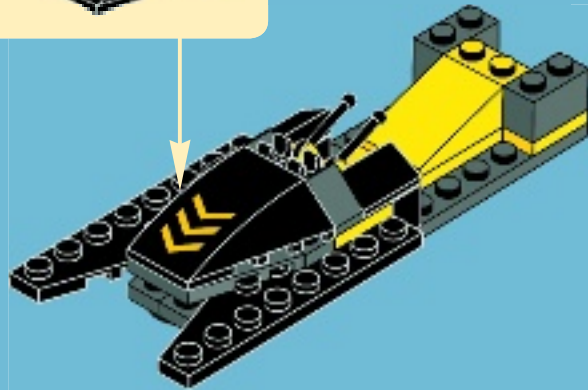
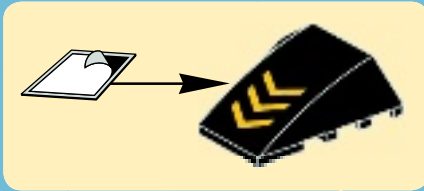

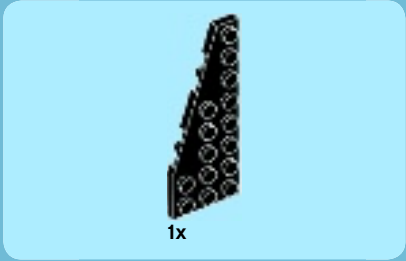

1

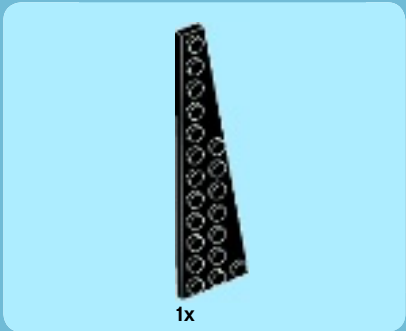
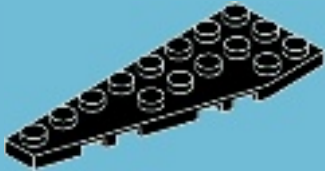

2

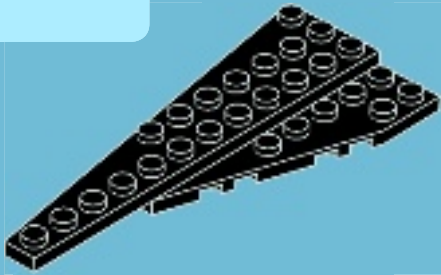

3

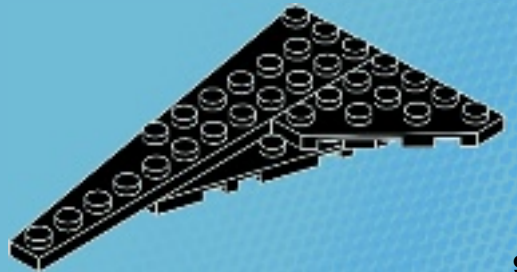



1x

4

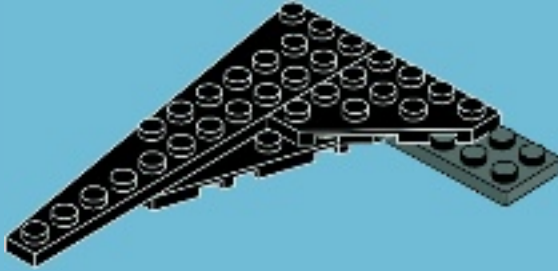

1x



1x

5





6



7

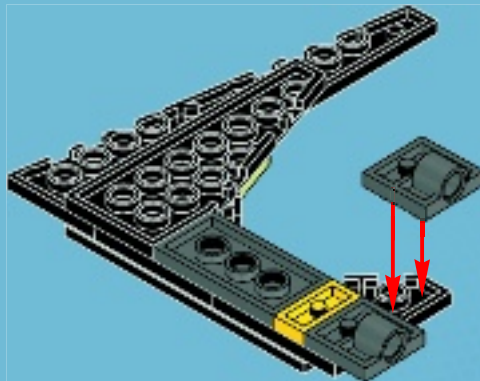



1x



1x

8

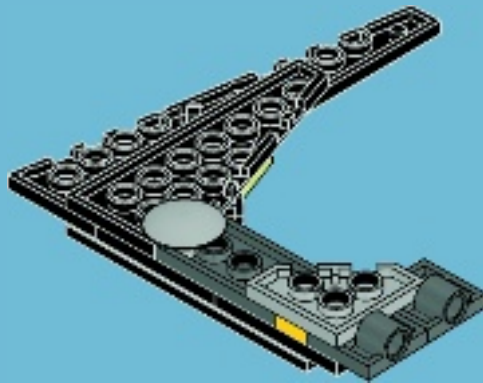

2x

9

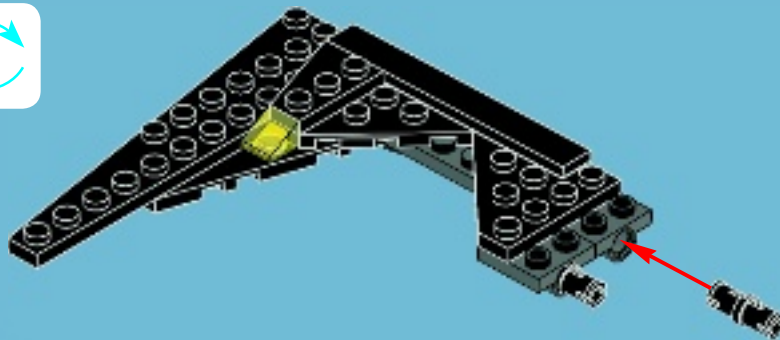



1x

10

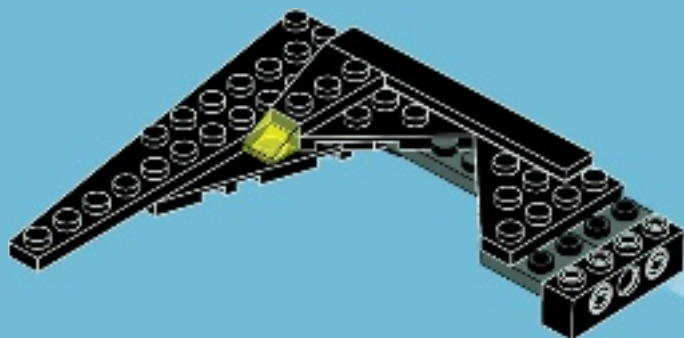

2x

11

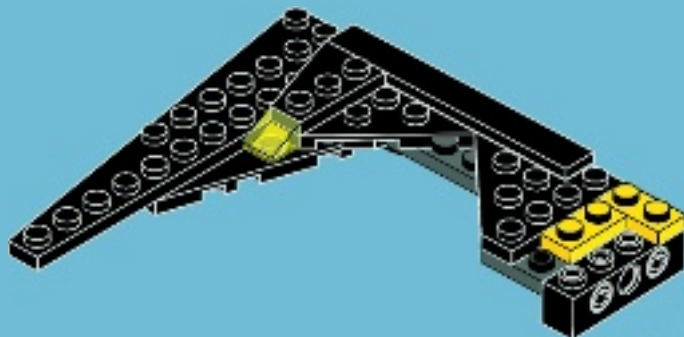

12

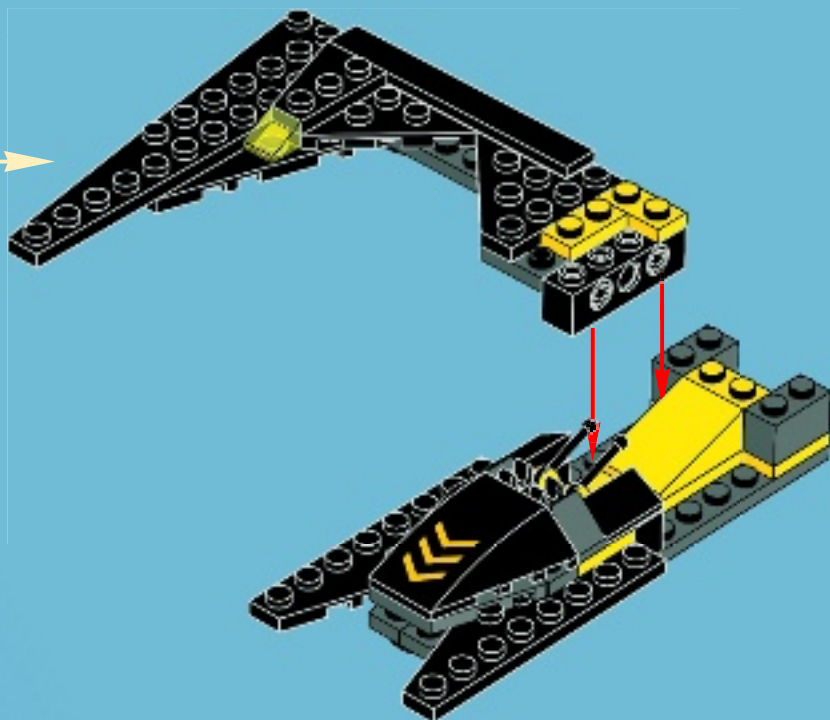

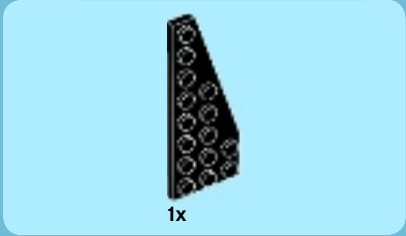

1

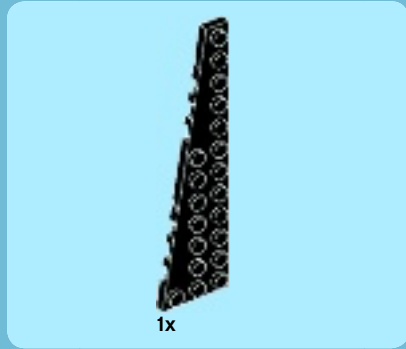
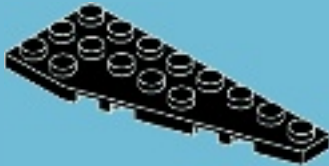

2

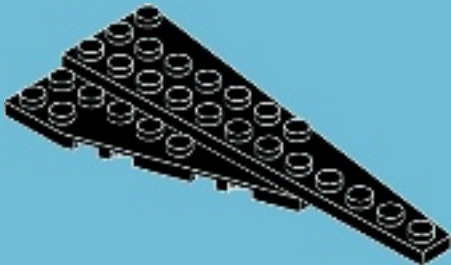

3

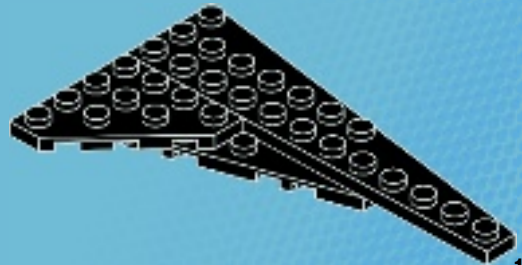



1x

4

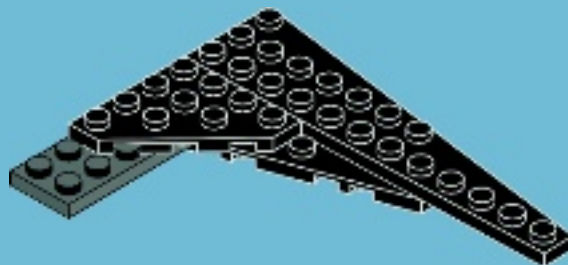

1x



1x

5





6

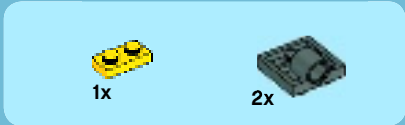
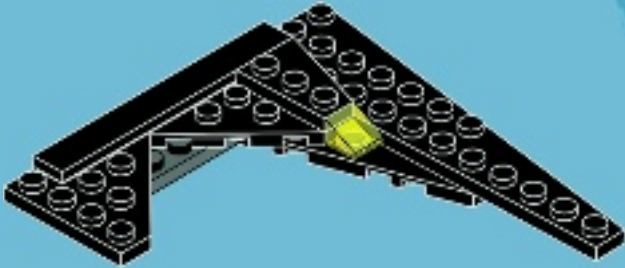

7

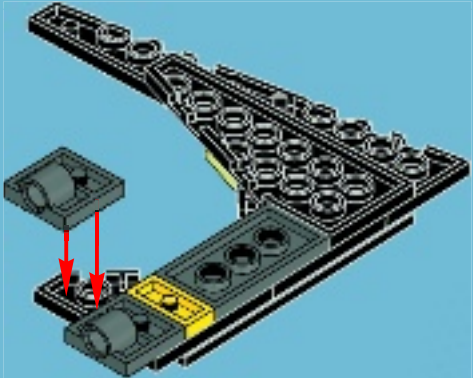



1x



1x

8

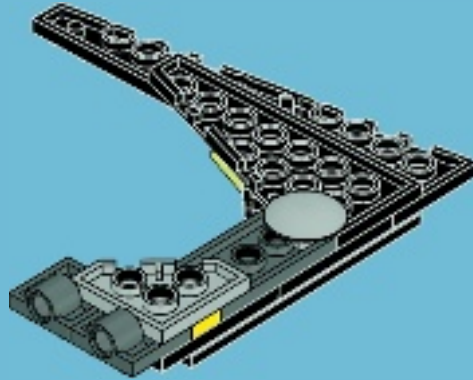

2x

9

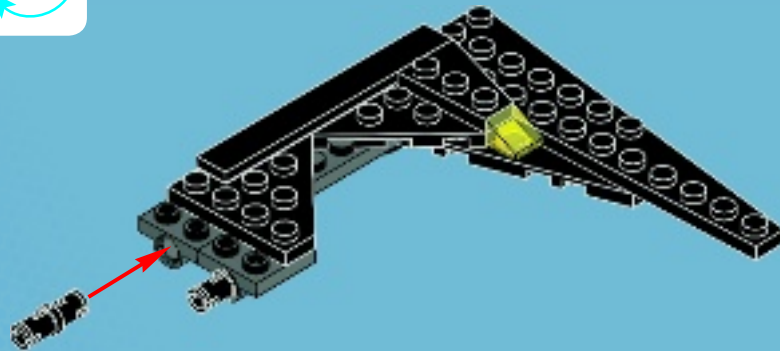



1x

10

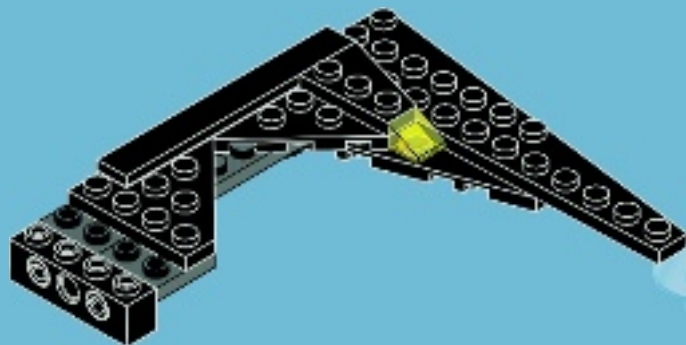

2x

11

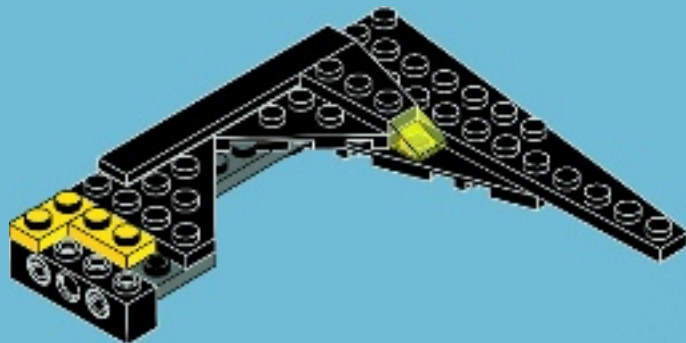

12





1x



1x

13

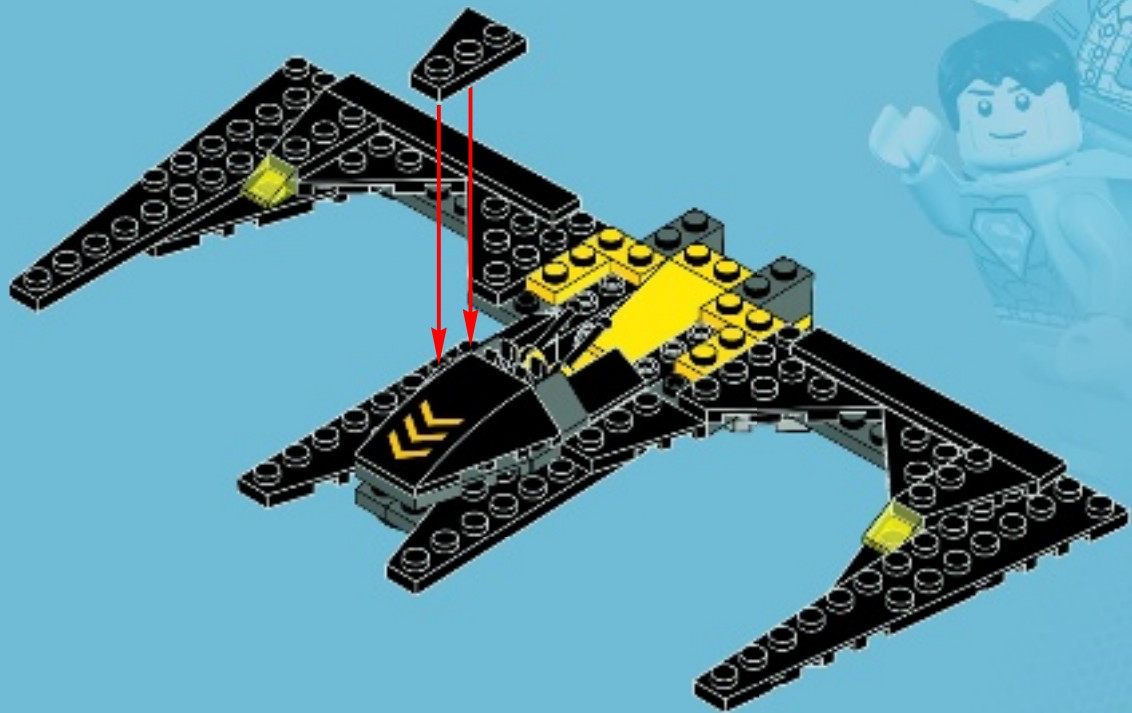



2x

14

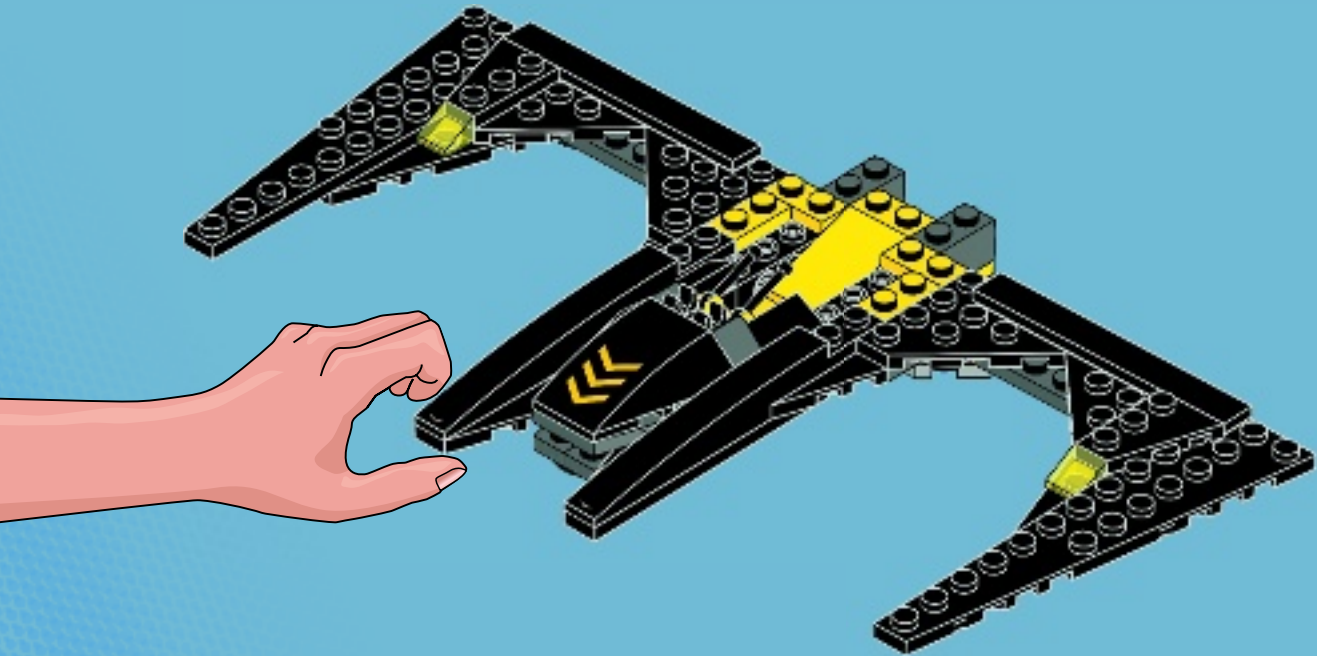



1x



1x



2x

15

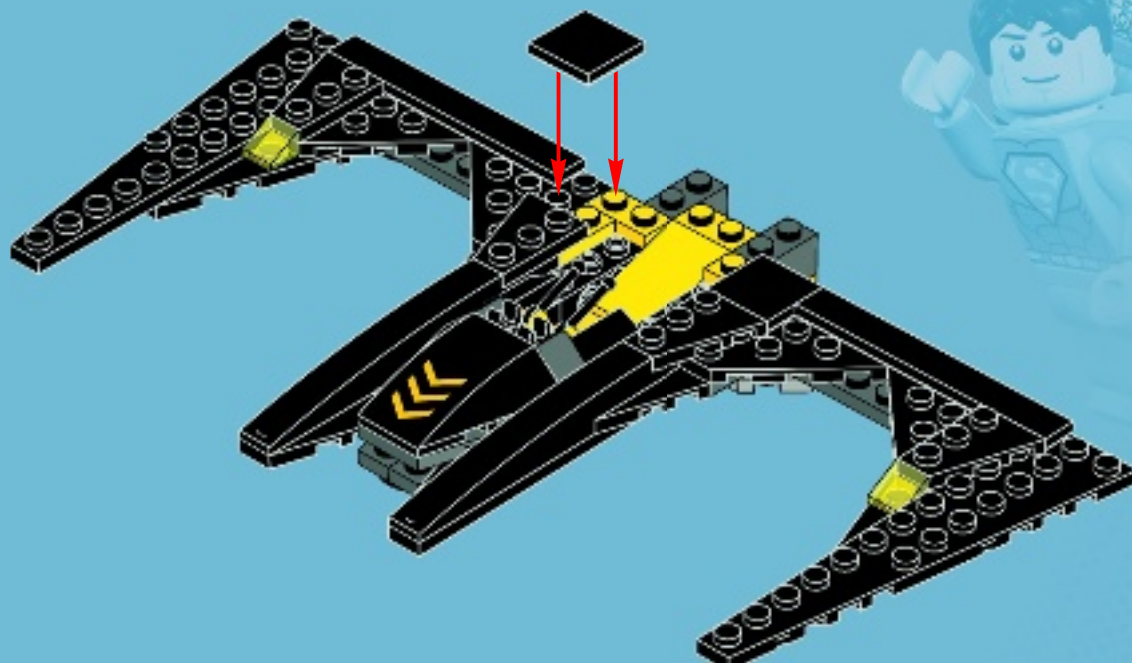



2x

16

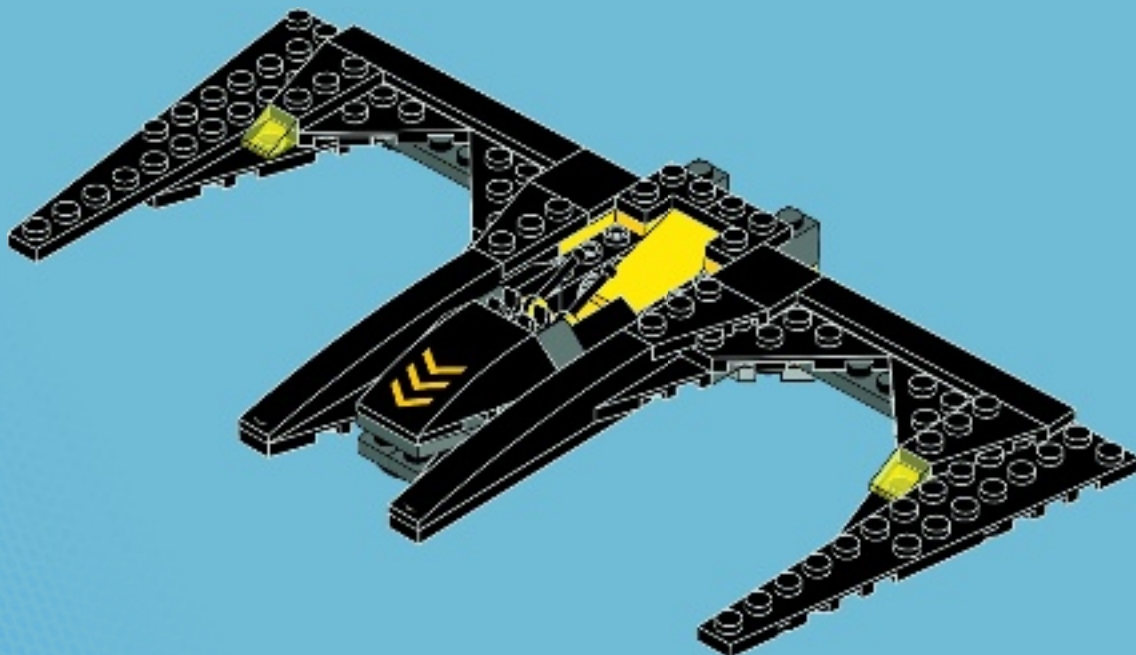



17

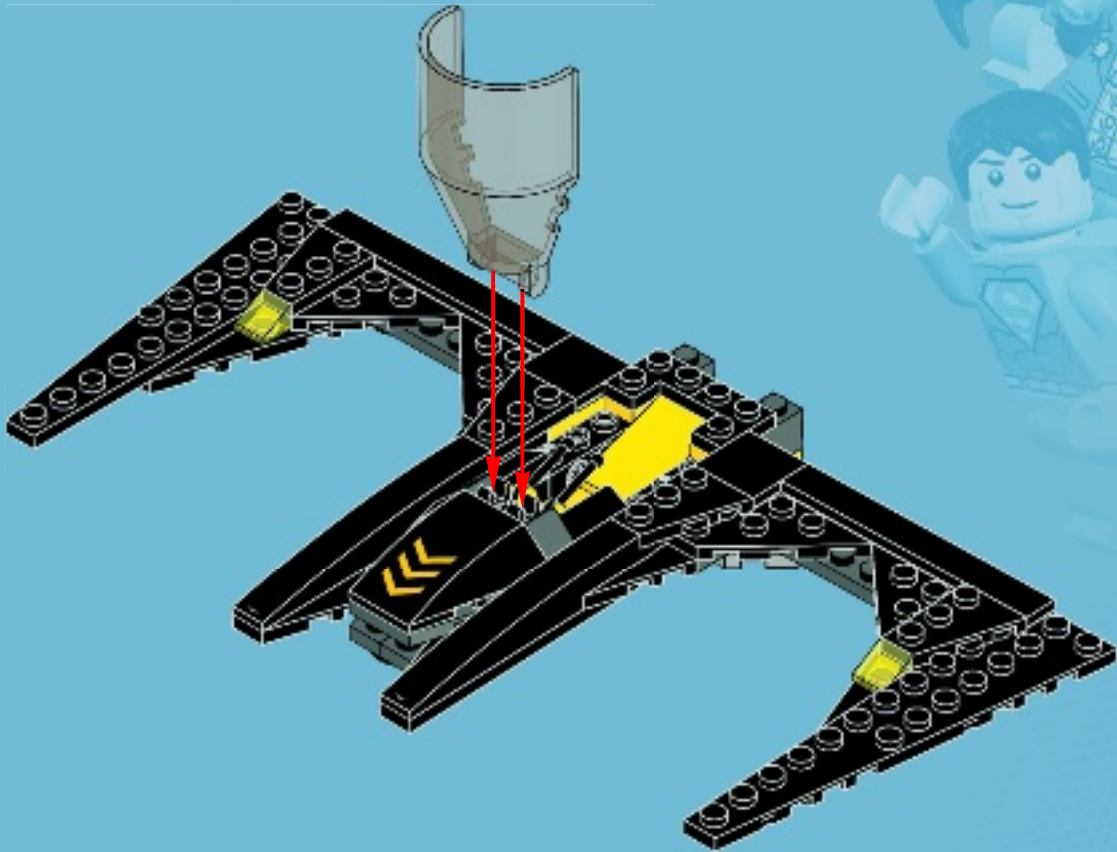

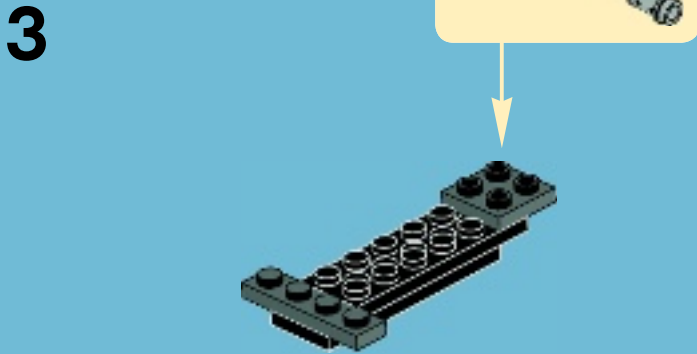
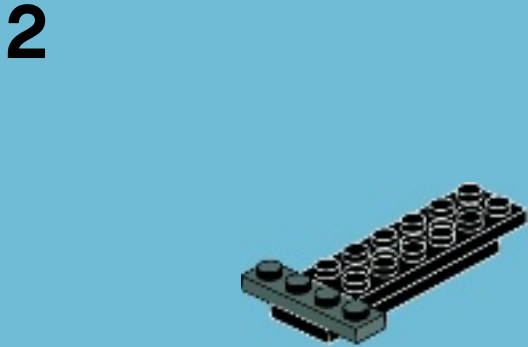
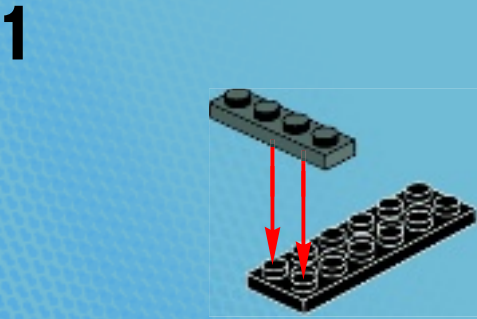
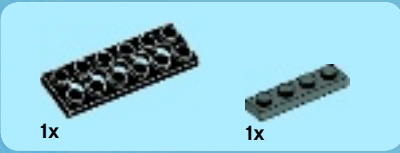
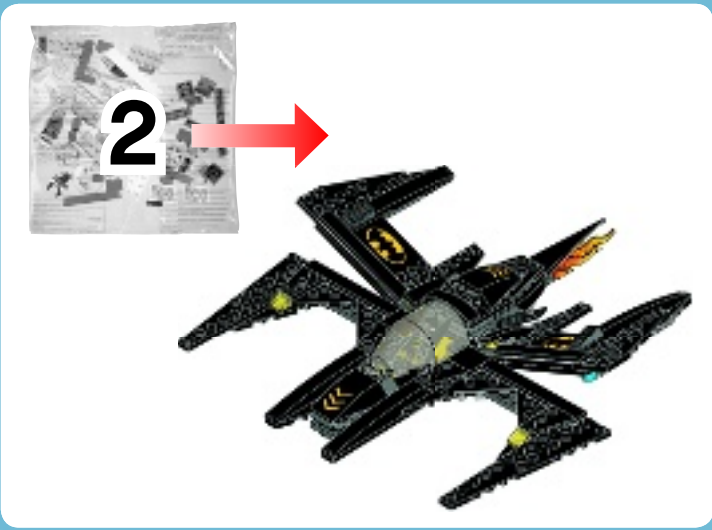



6x

4

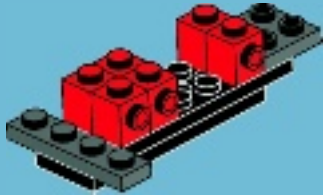

1x



1x

5

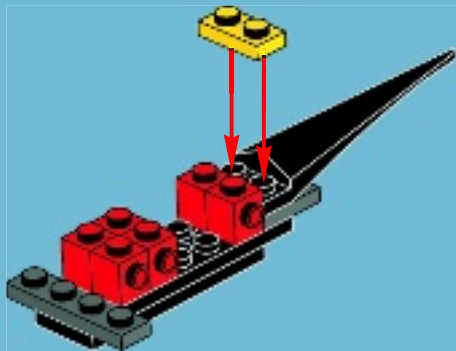

4x



2x

6

1

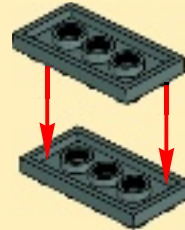

2

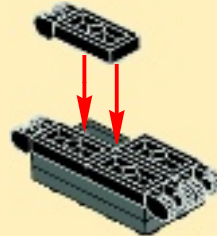

3

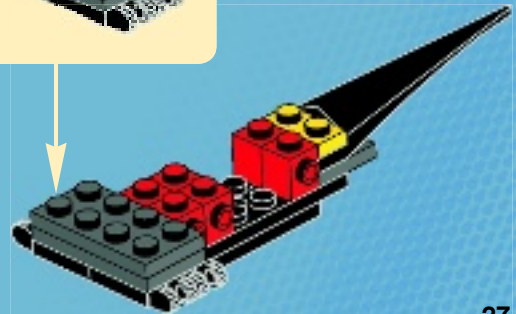

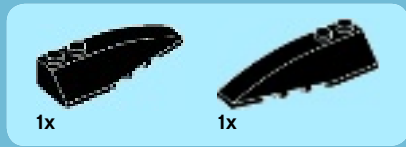

7

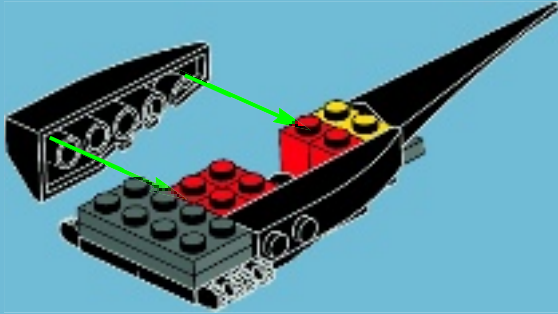

8

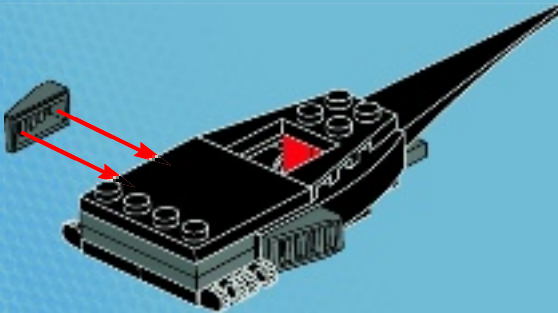

28



9

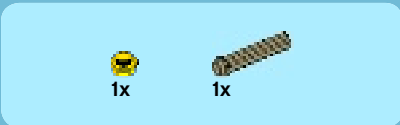
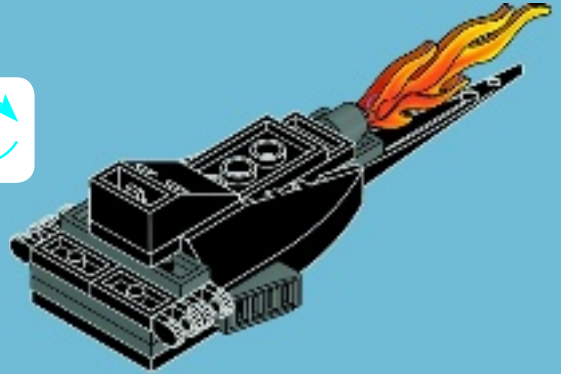

10

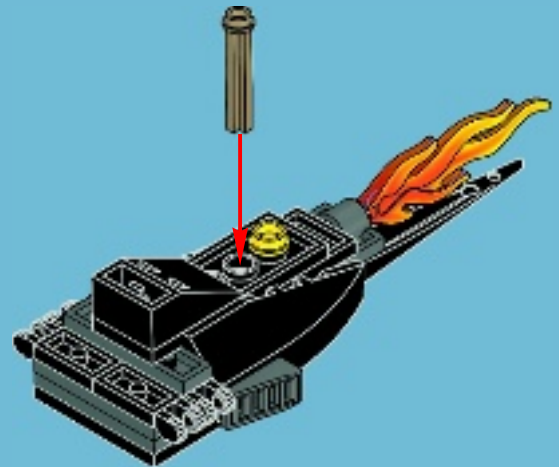



11

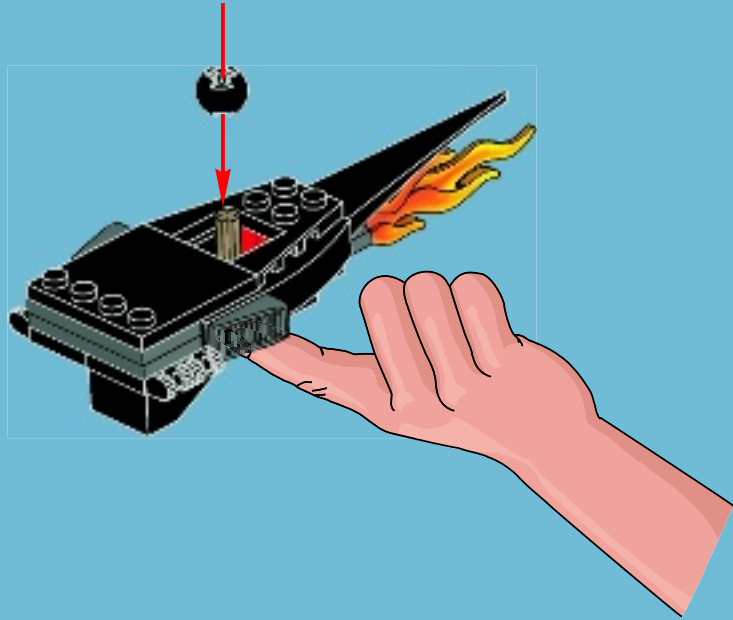

12

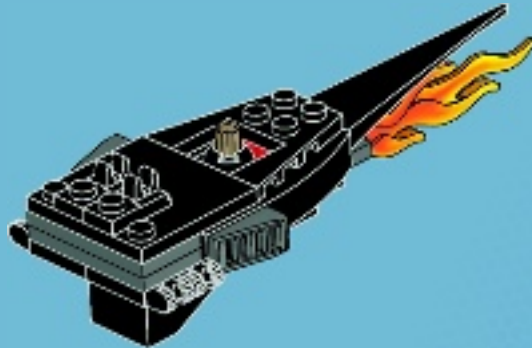



1x

13

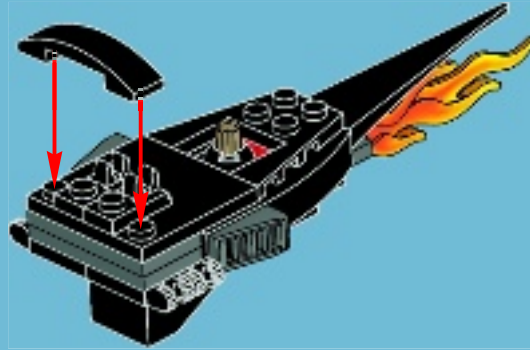

1x



1x



1x

14

1

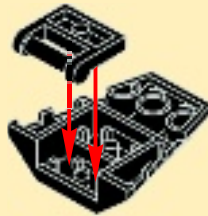

2

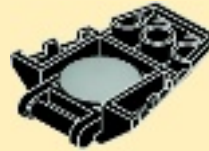

3

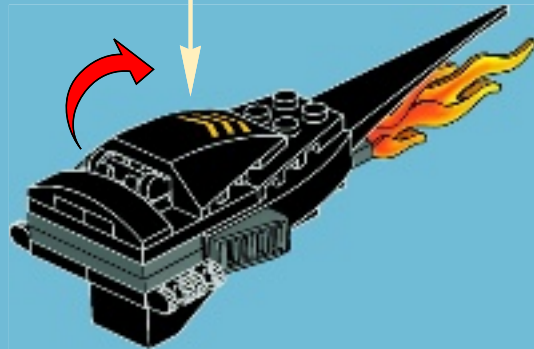
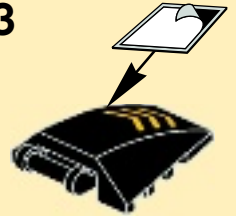



1x



1x



2x



1x

15

1

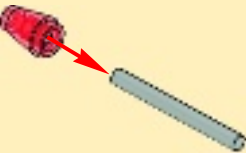

2



3

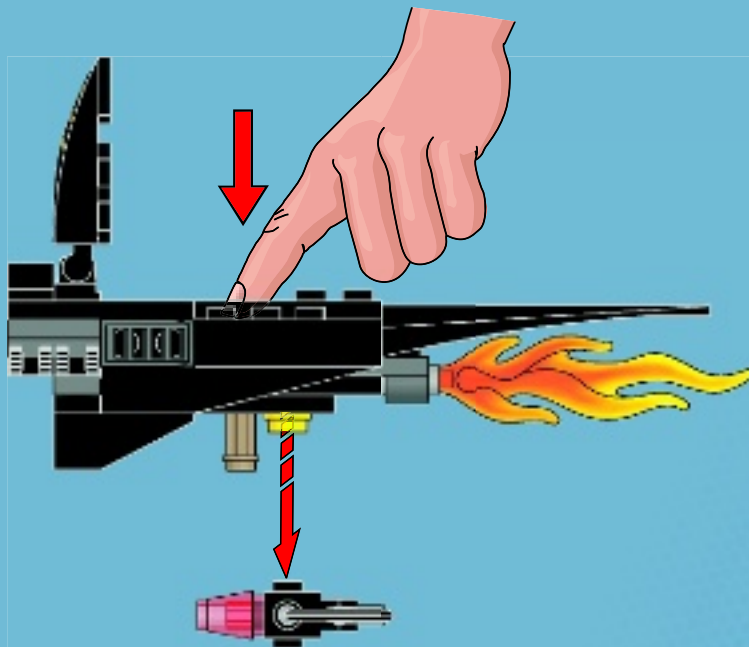
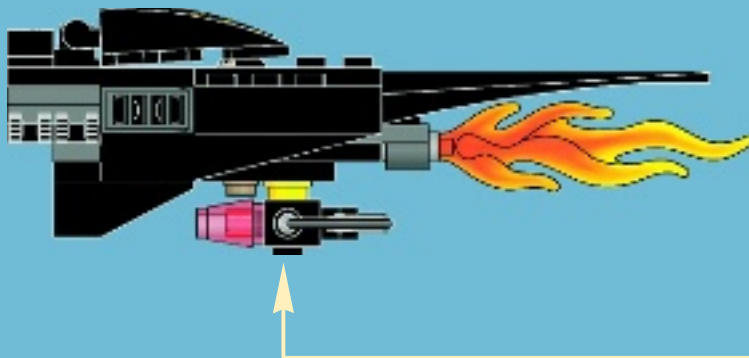
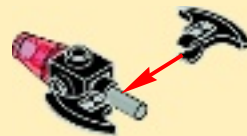

18

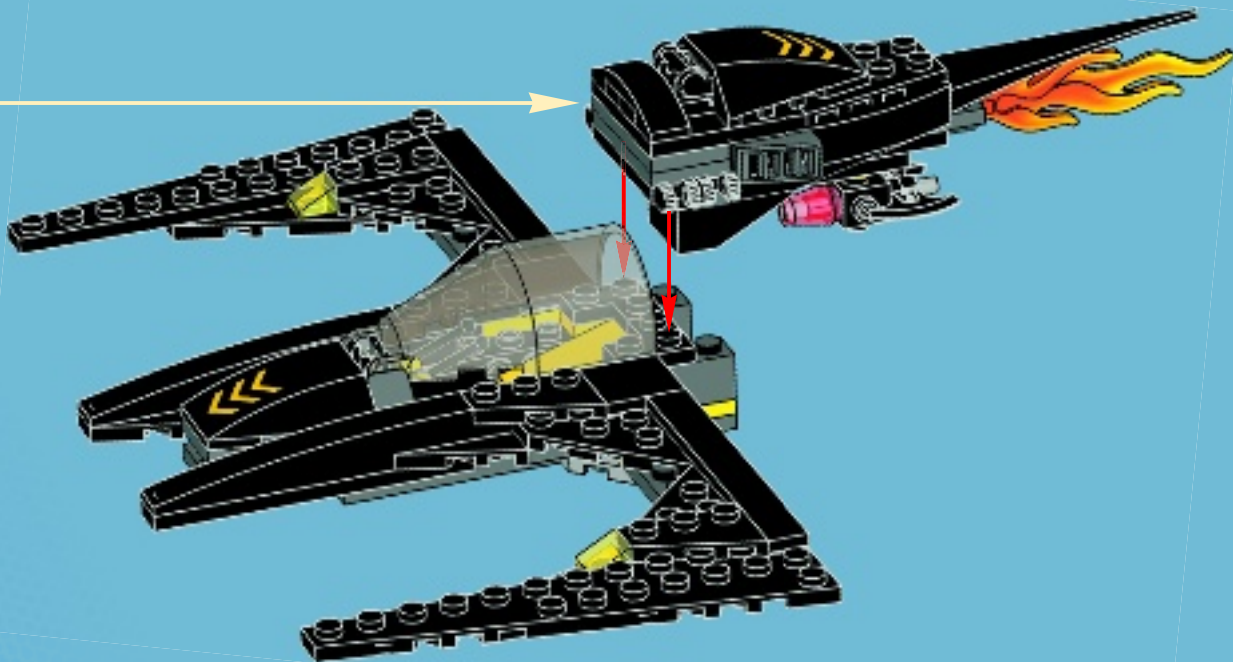



1x

1

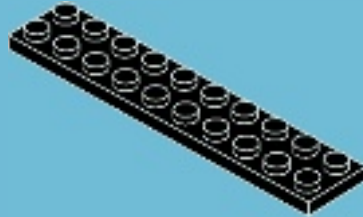

1x



1x

2

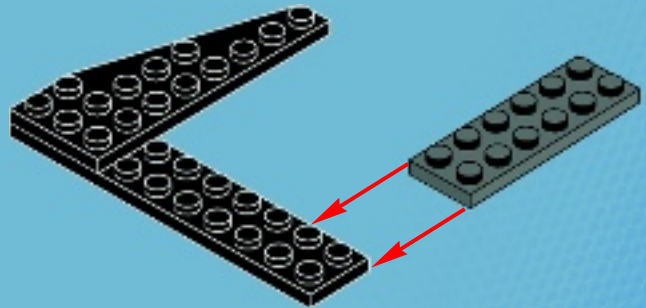



3

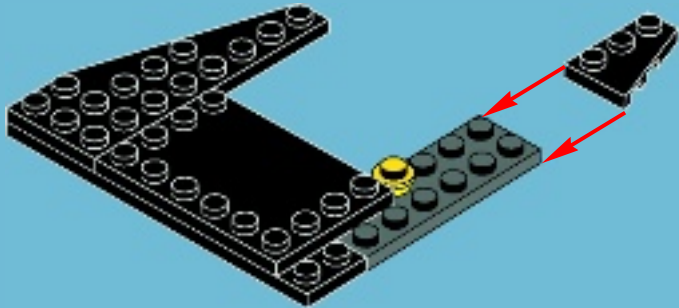

4

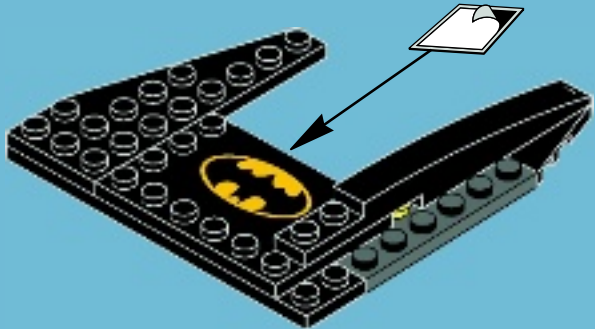



1x



1x

5

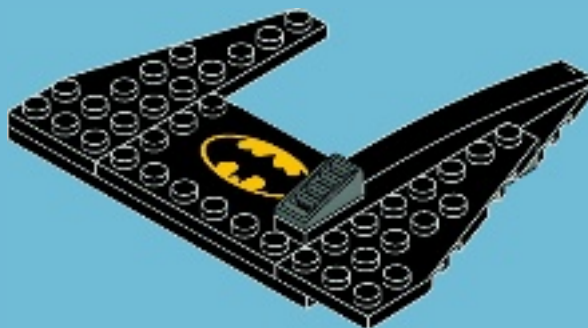

1x



2x

6





7

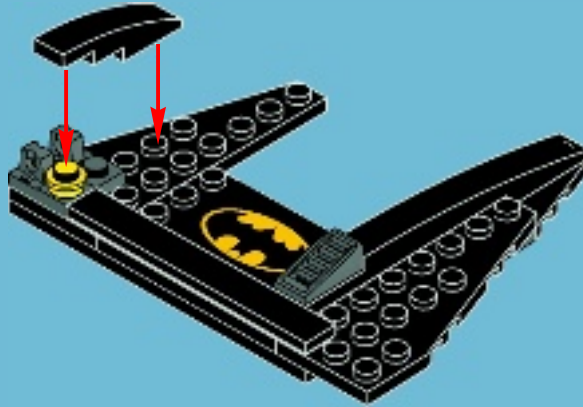

8

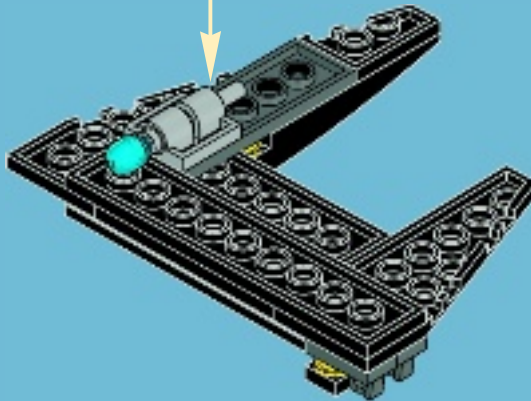
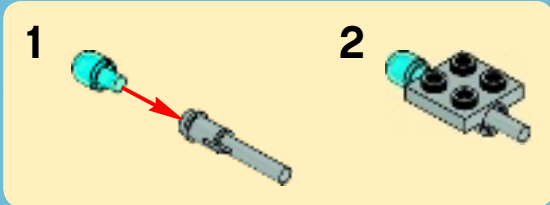

19



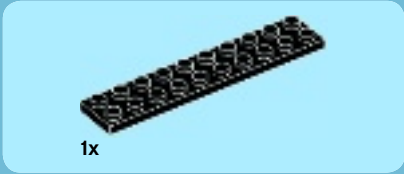

1

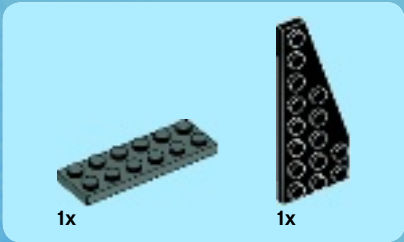
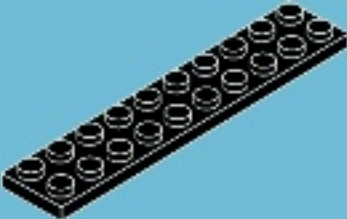

2

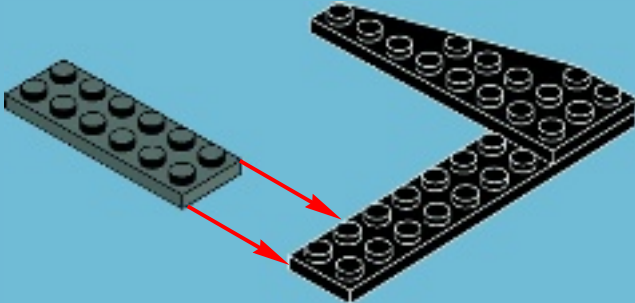



3

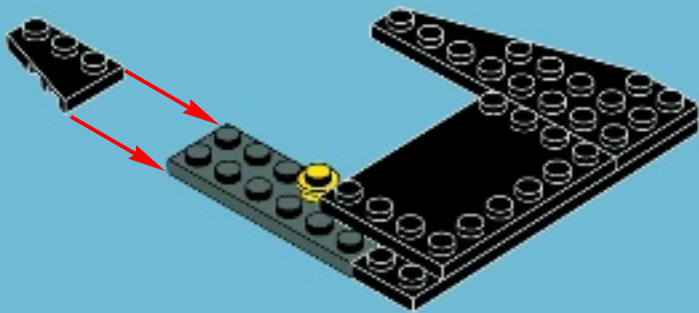

4

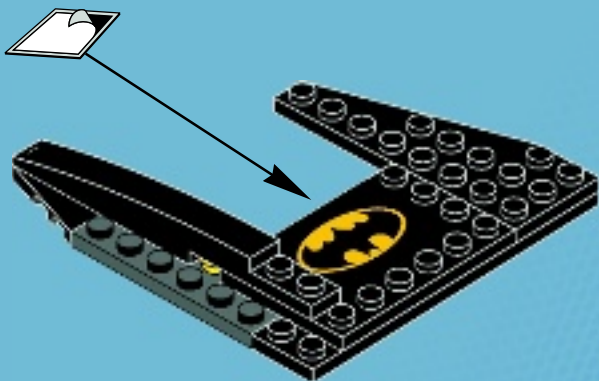

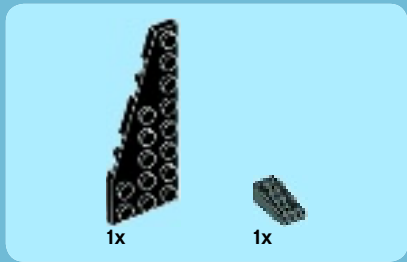

5



6





1x



1x

7

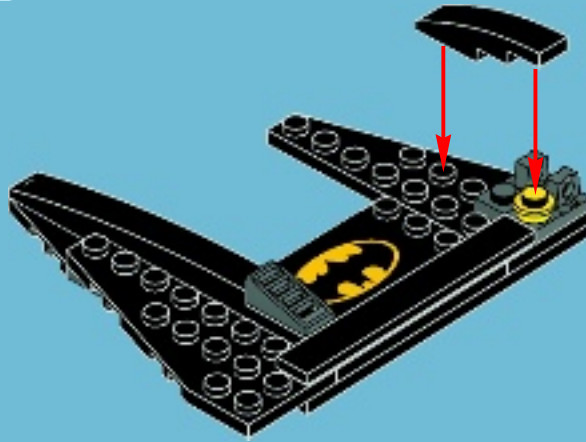

1x



1x



1x

8



1

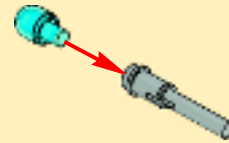

2

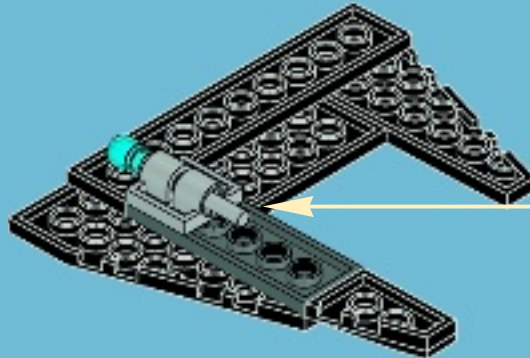

20





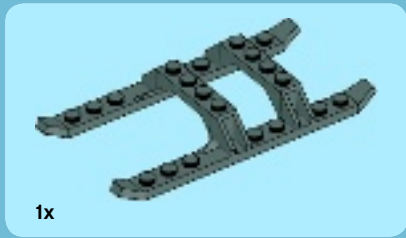
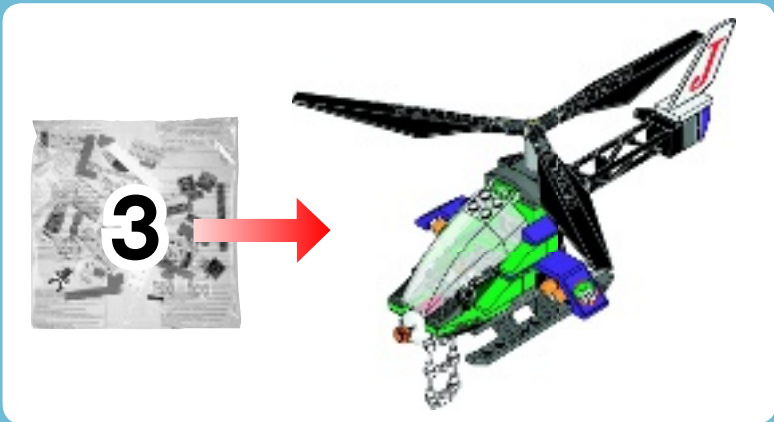

1

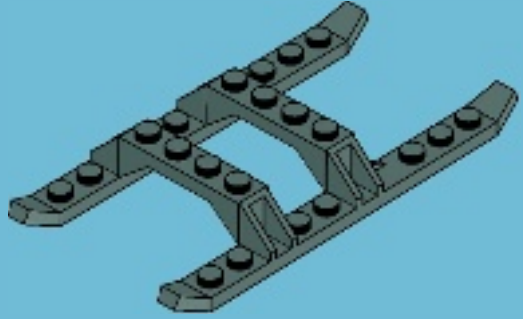
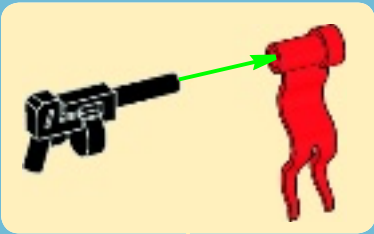



1x

2

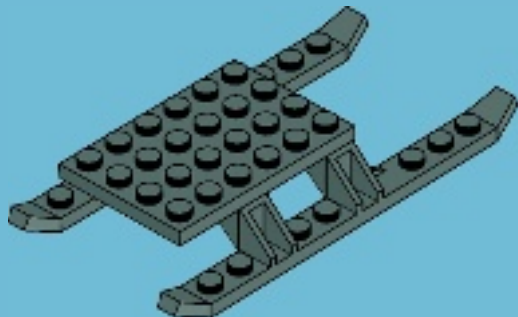

1x

3

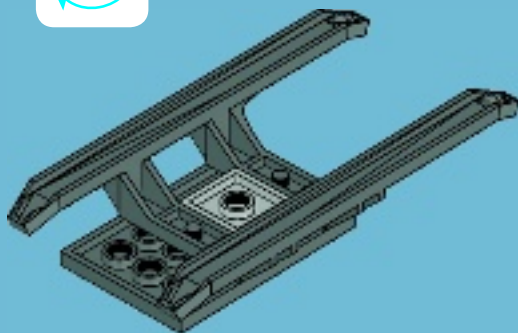

2x

4

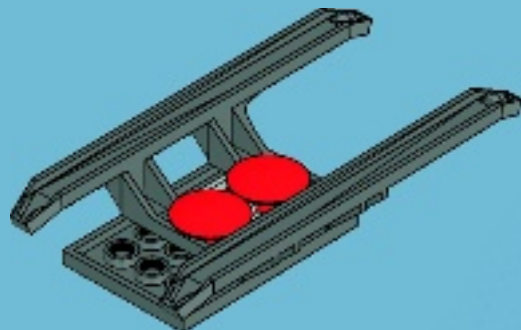

2x



2x

5

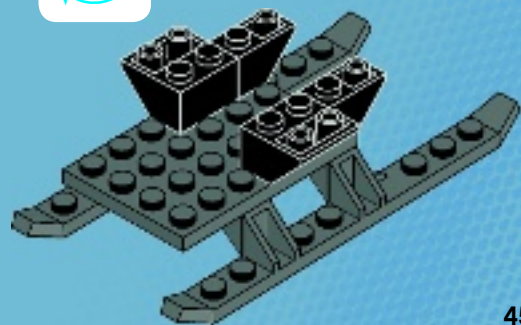



2x



1x

6

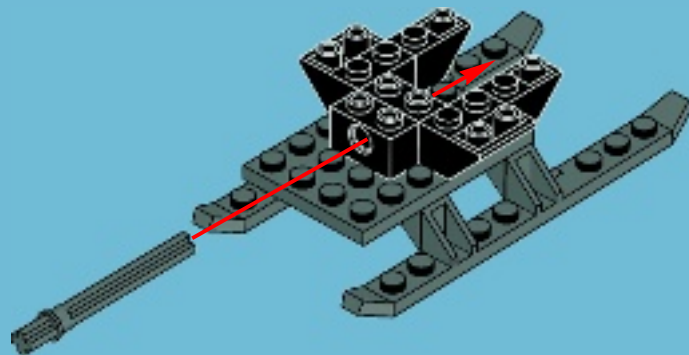

1x

7

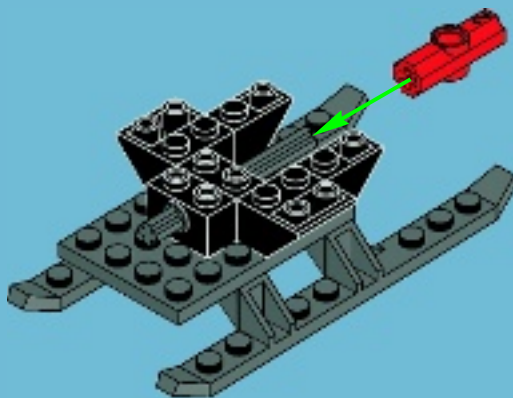



1x



1x

8

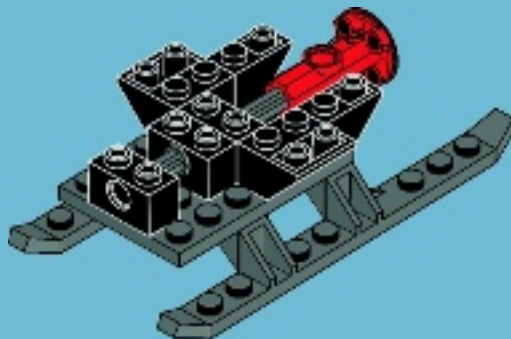

1x



1x

9

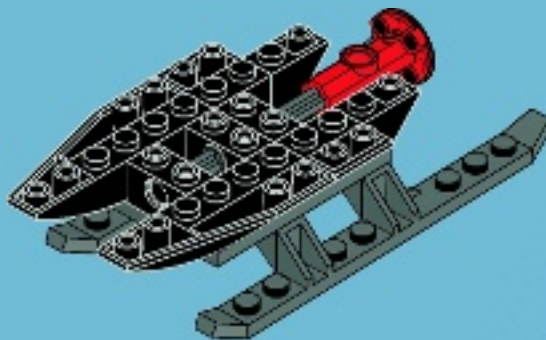

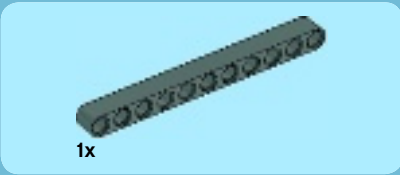
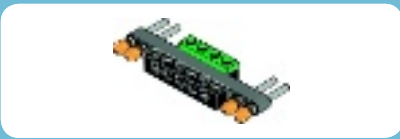

1

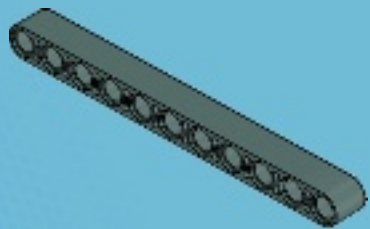

2

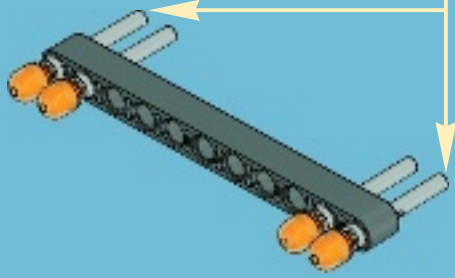
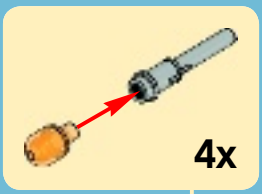

3

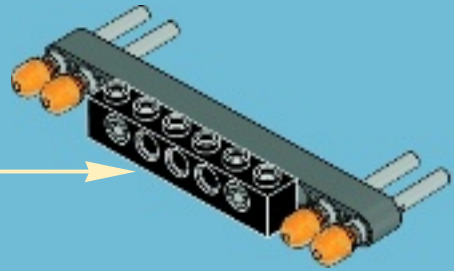
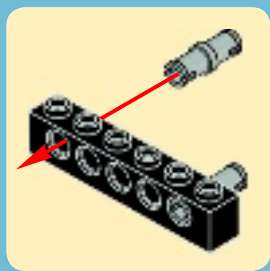

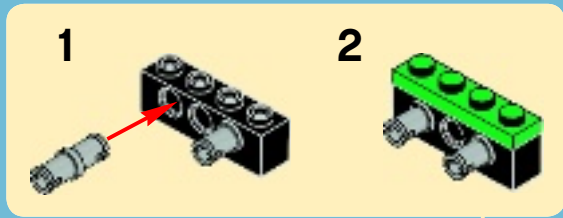
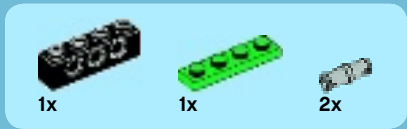

2

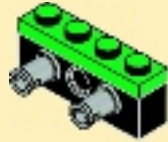

4

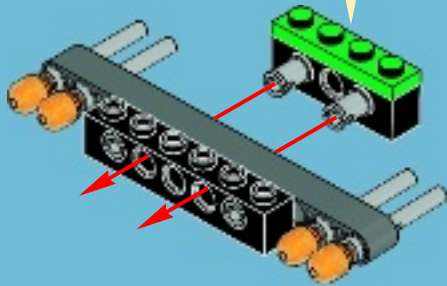

10

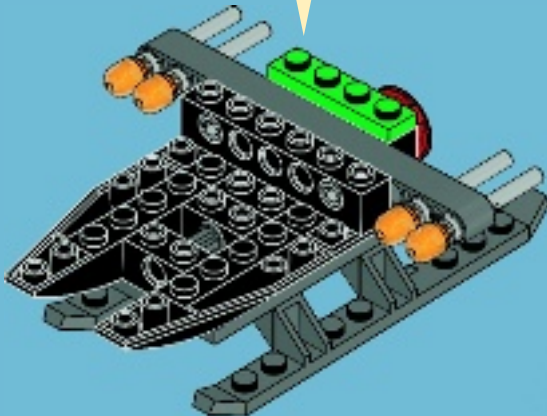



1x



1x

11

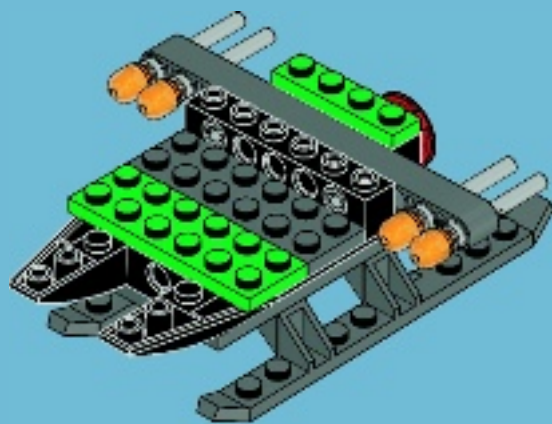

1x



1x

12

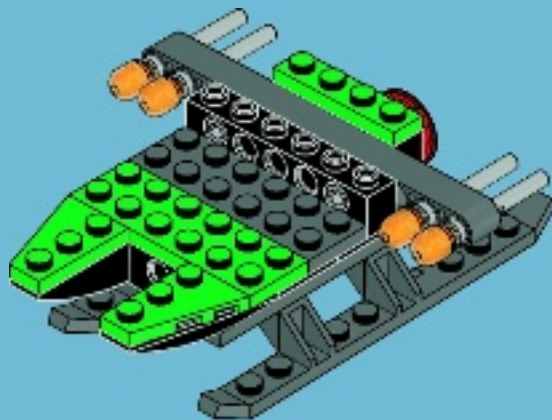

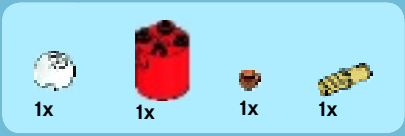

13

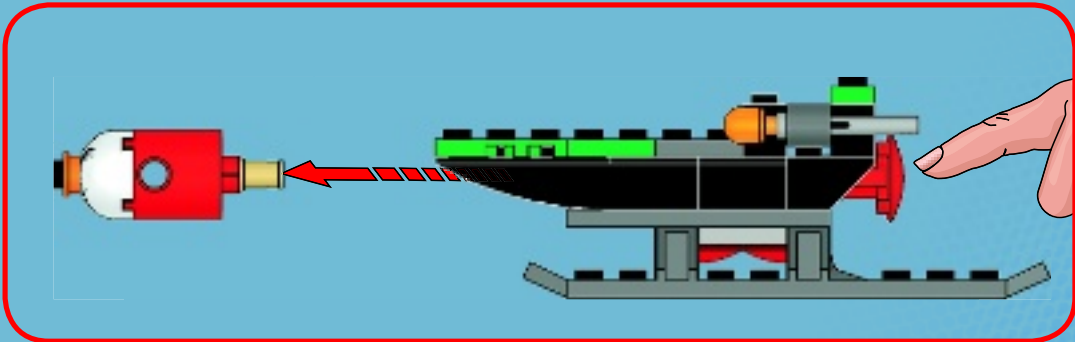
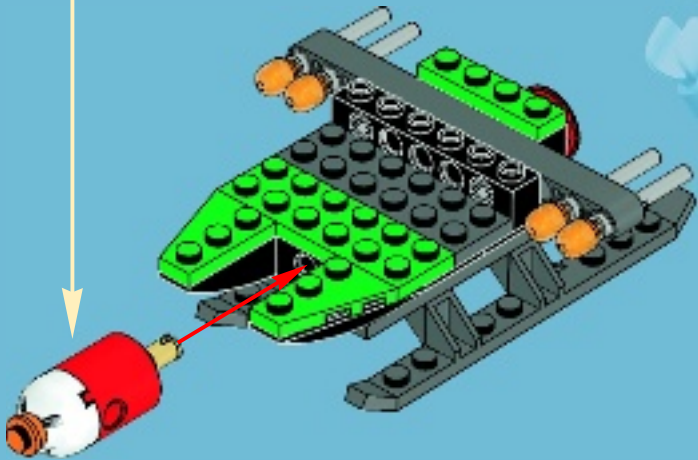
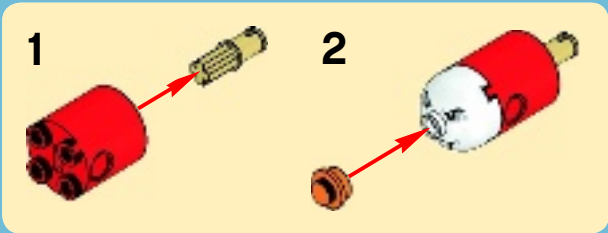



2x



1x



2x

14

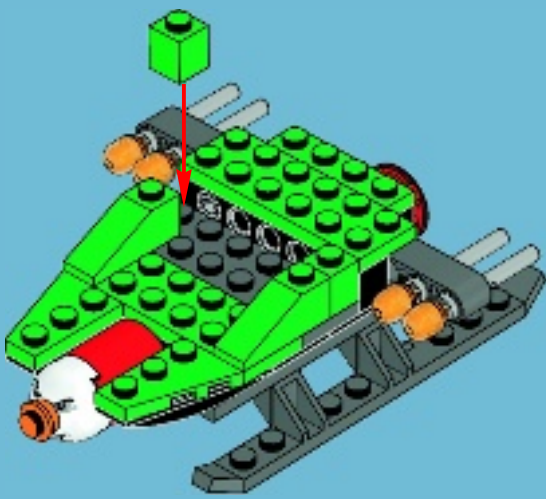

1x



2x

15

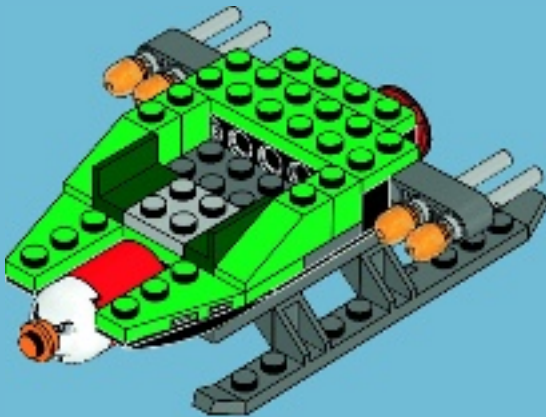



18

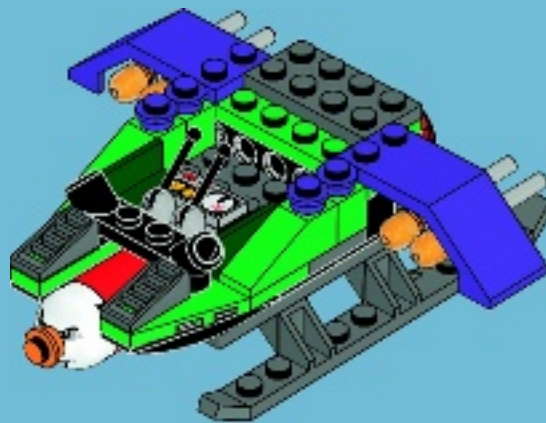

19

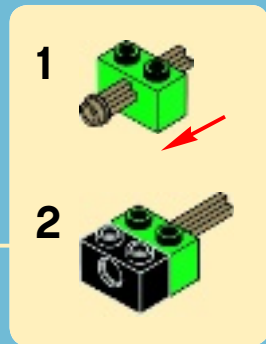
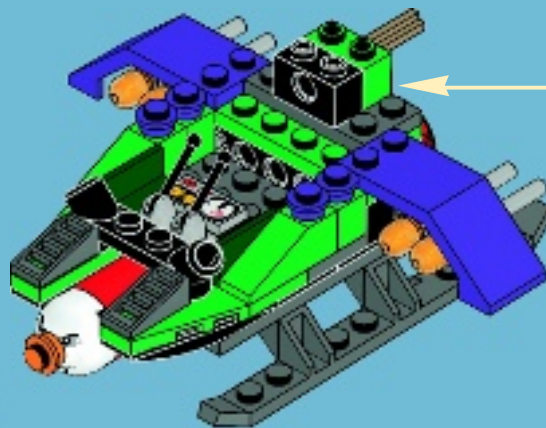



2x



2x

20

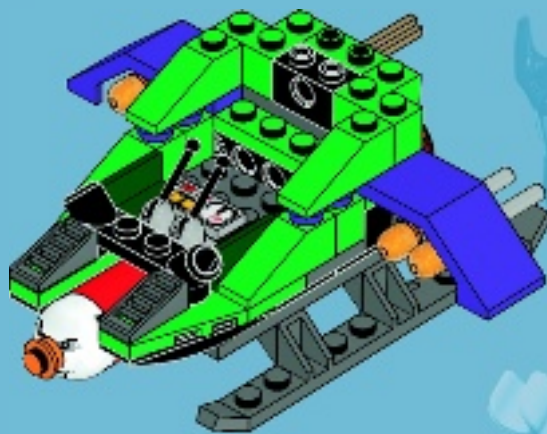

1x



2x

21

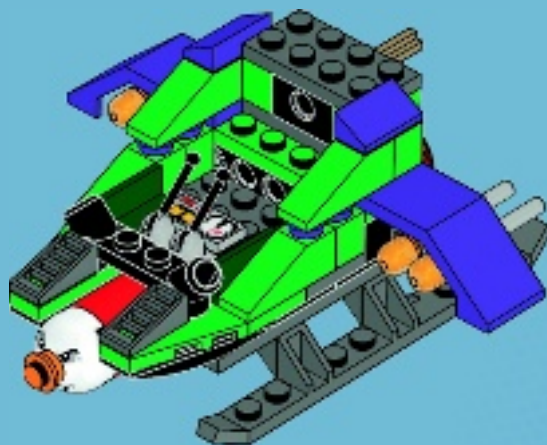

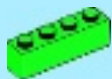

1x



1x

22

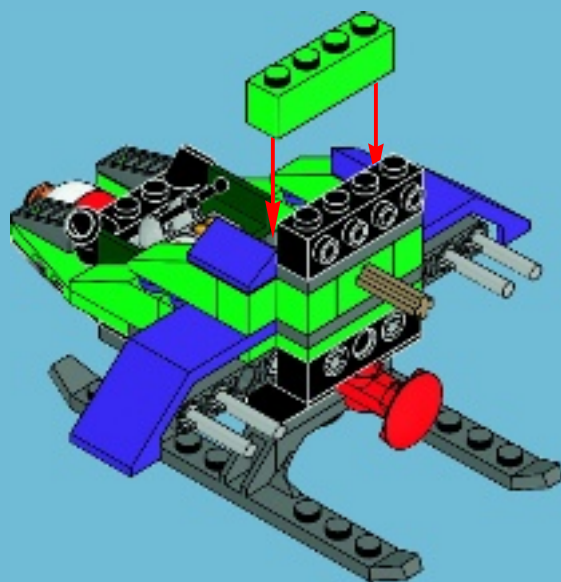

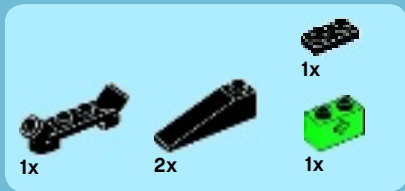

23

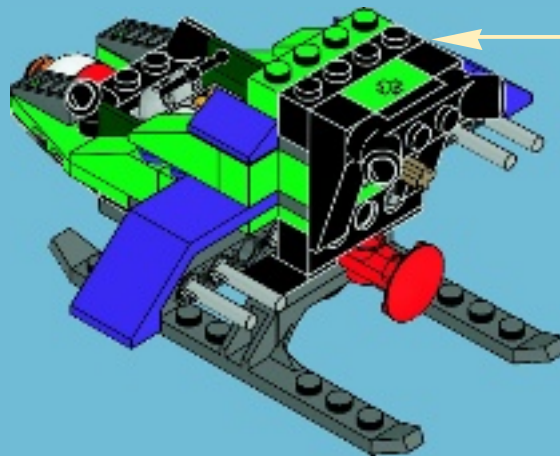
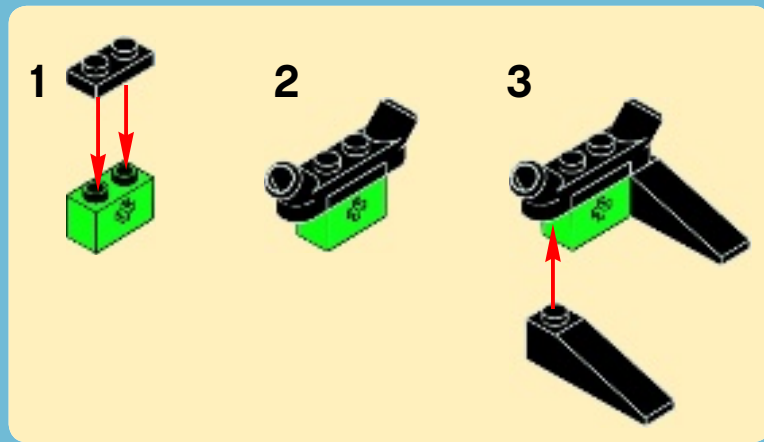

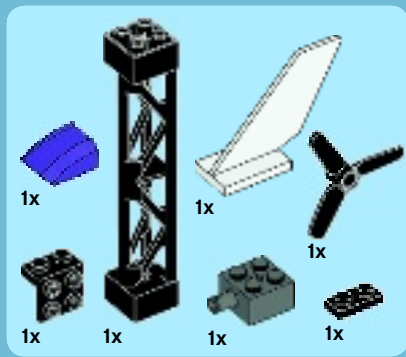

24

1



2

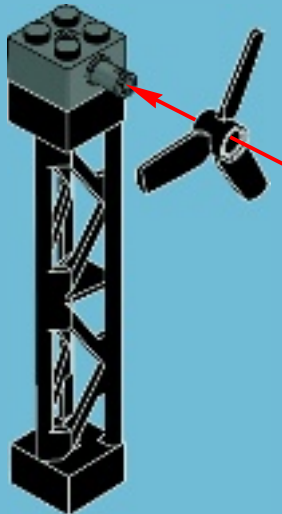

3



4



5



1

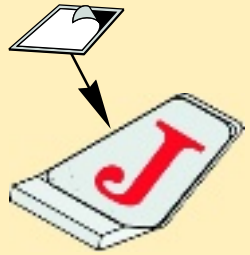

2

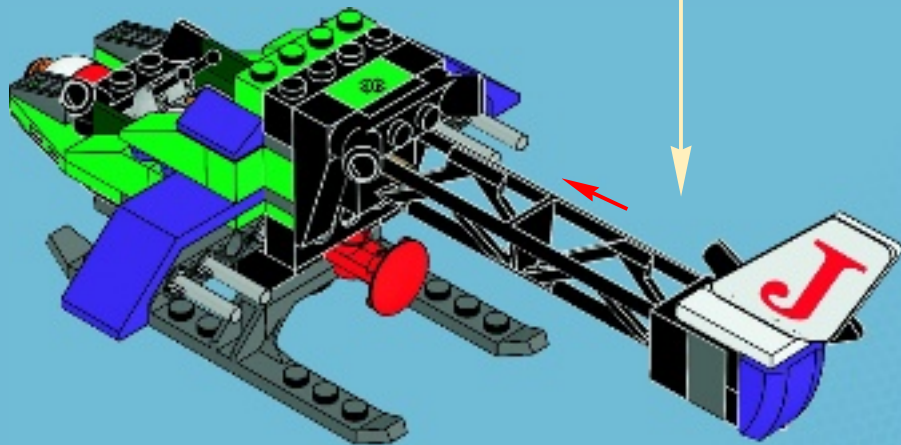
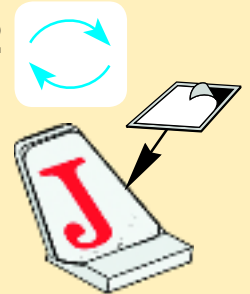



2x



1x

25

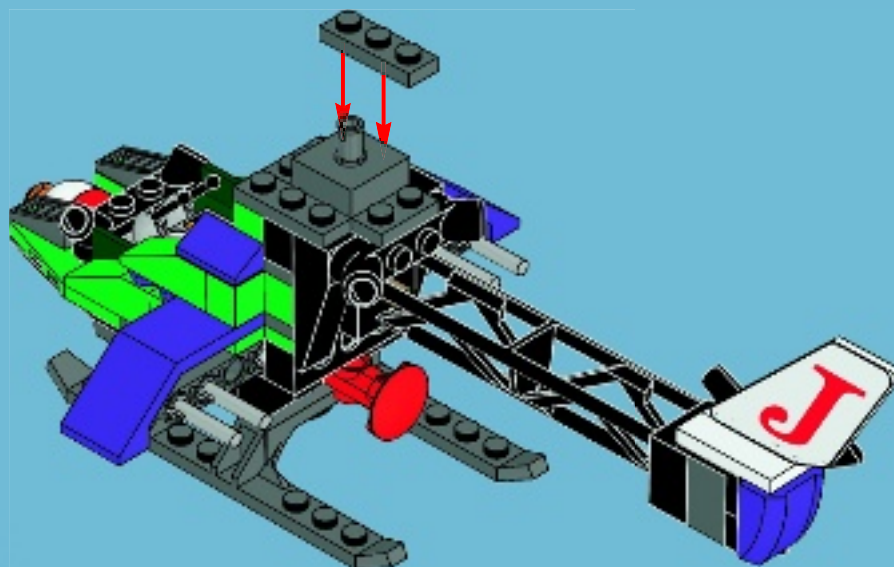



1x



1x

26

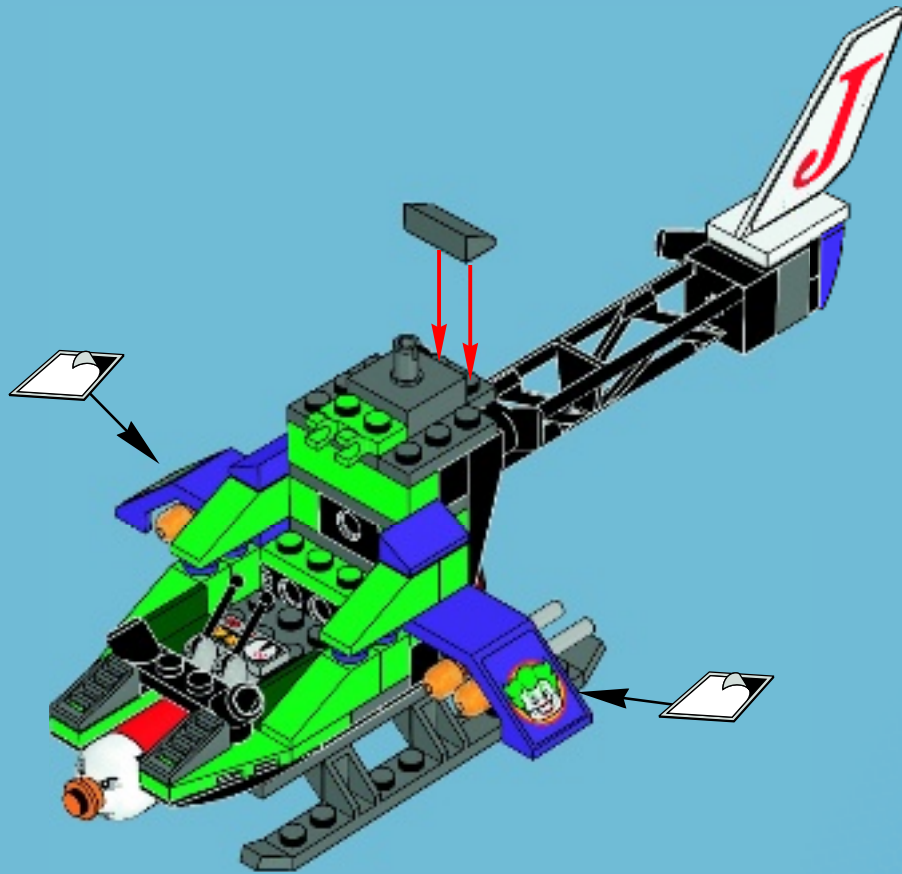



2x



1x

27

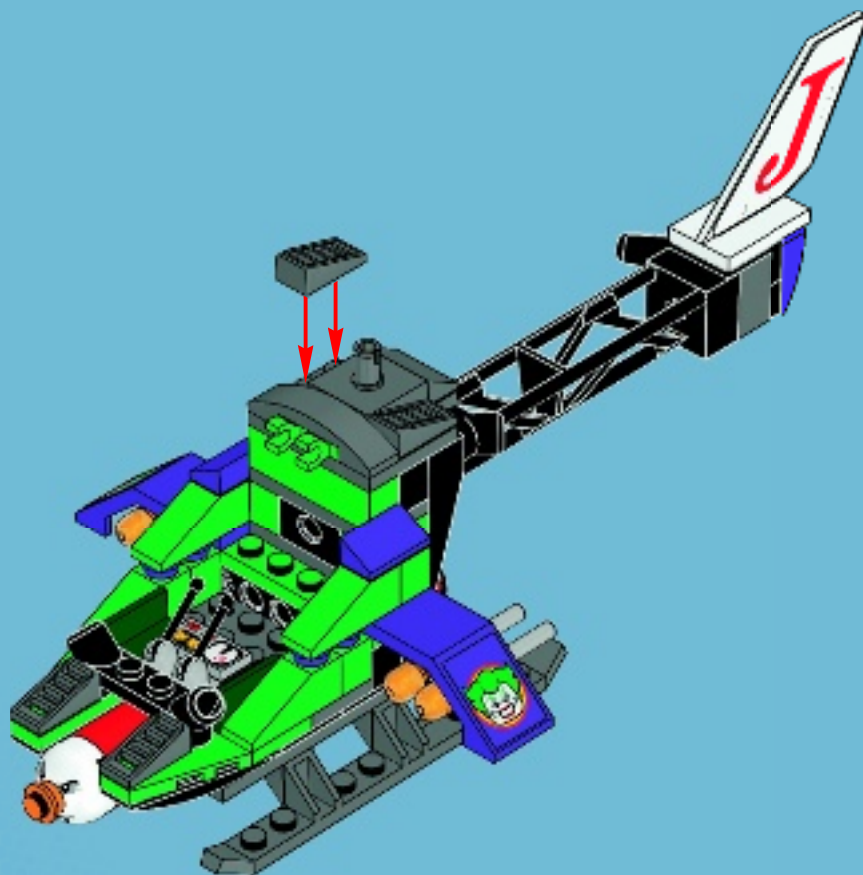



1x

28

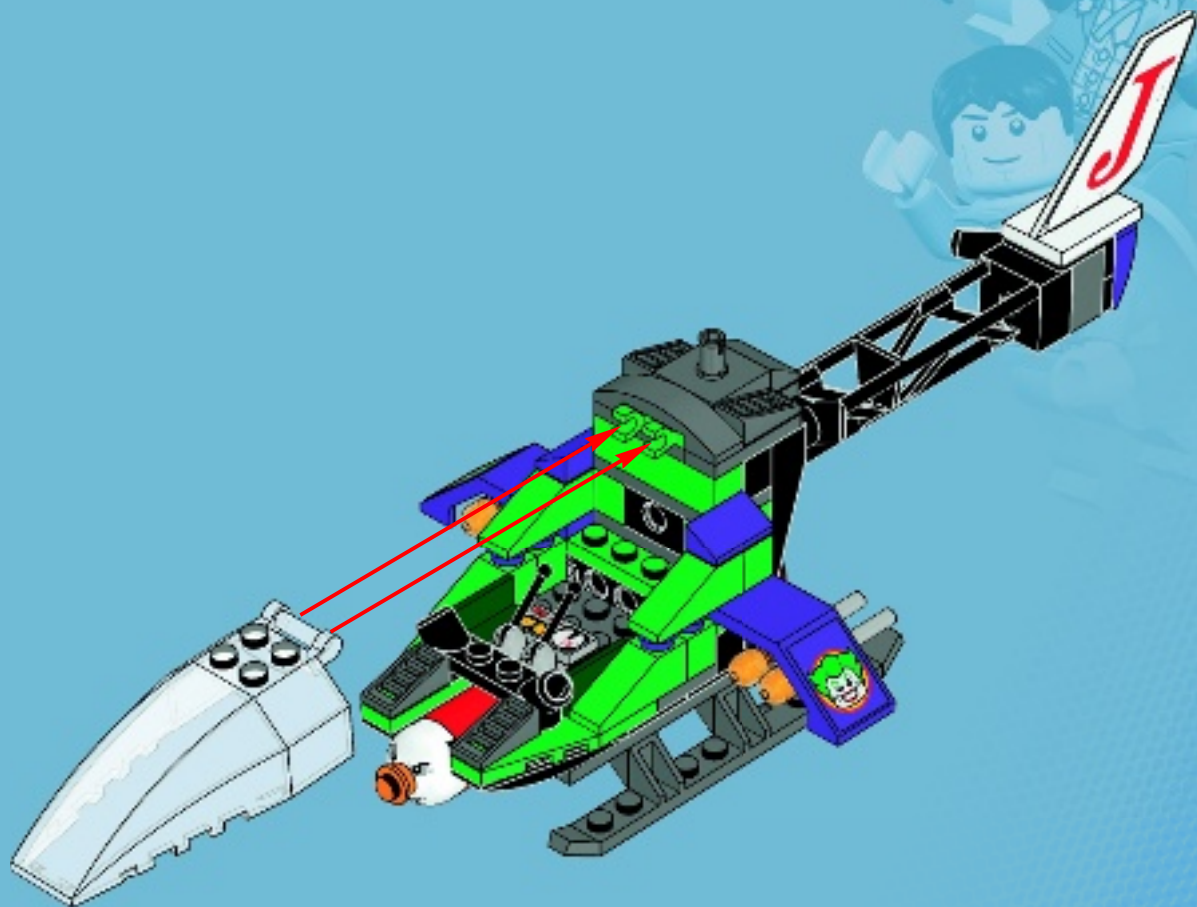



1x



1x

29





1x

30





31

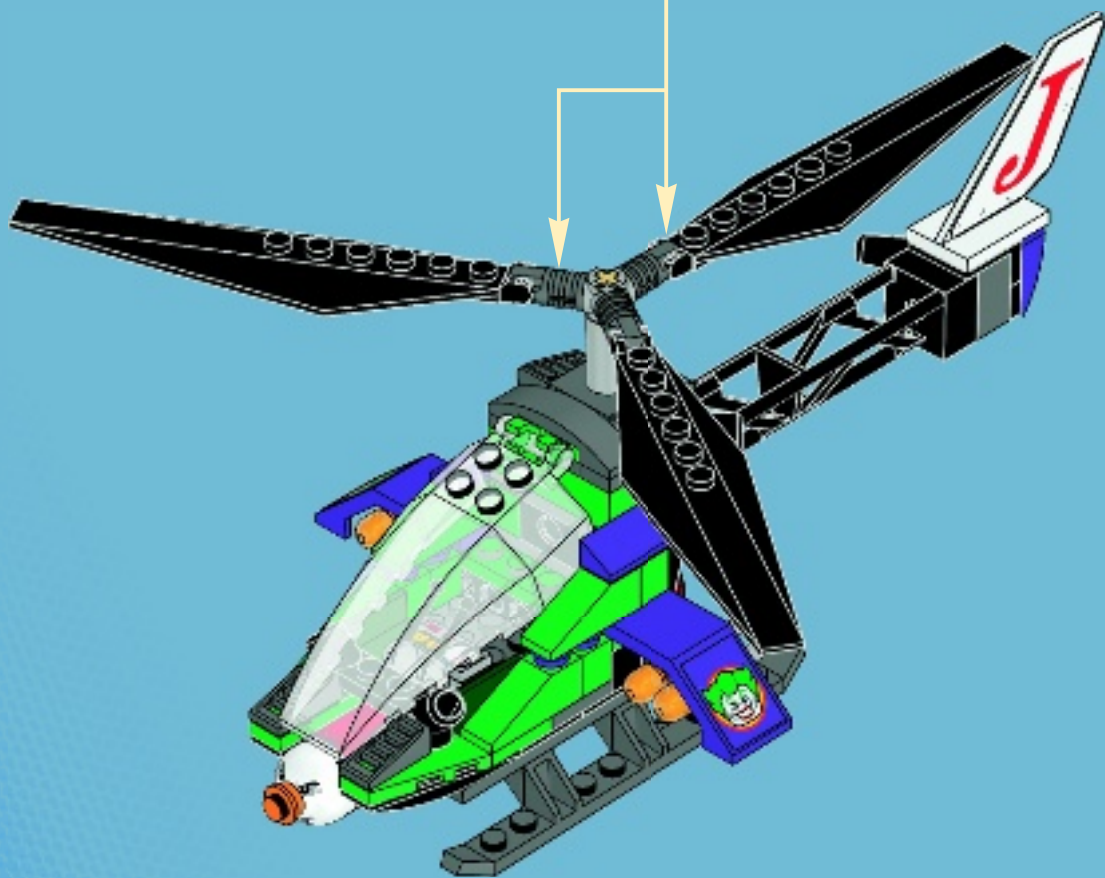

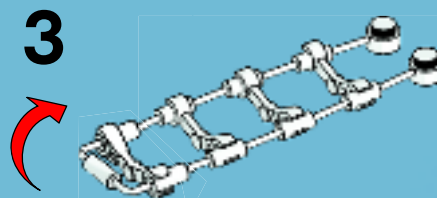
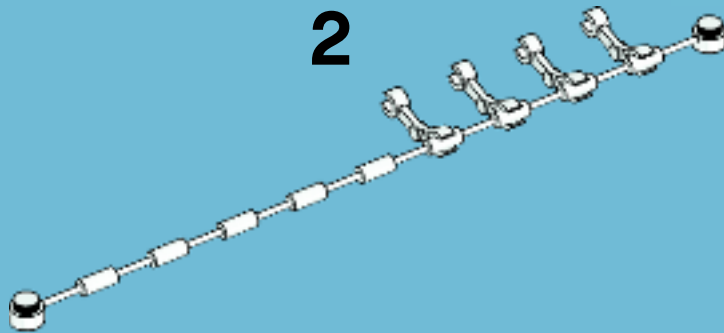
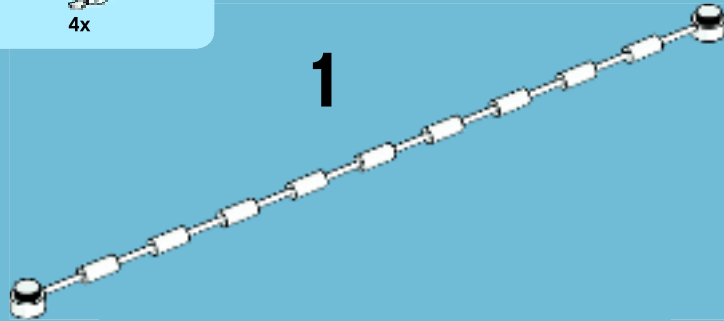
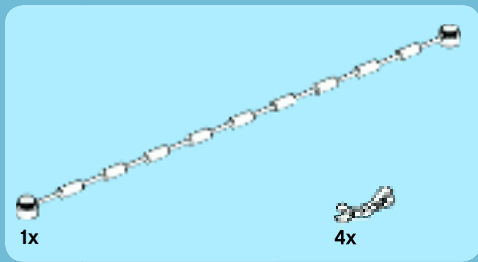

32

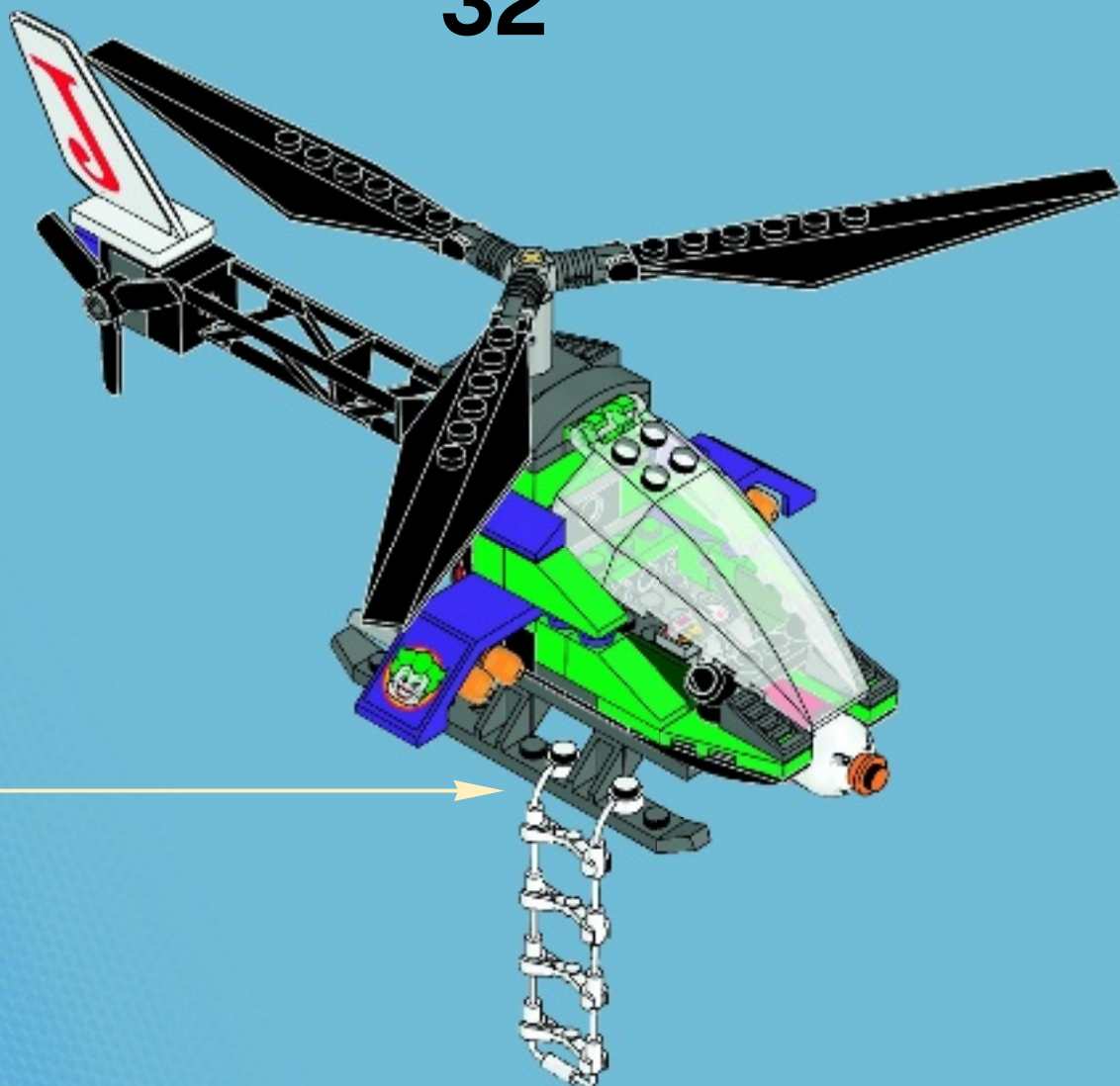



1x
4157103
1x
4655683
1x
4652373



4x
4260649
1x
623901
2x
4666579

6x
4558886

1x
4244747

3x
4278275

1x
449521

1x
4234429

1x
4124463

10x
302324

3x
302024

70

1x
306824
6x
614124
2x
74156



1x
4650624
2x
300526
1x
473326

1x
4162443

4x
370026

3x
370126

1x
389426

2x
366026

1x
374726

2x
4515362

1x
4613153

2x
4522034

4x
4567440

2x
4219107

1x
4161266

1x
4160108

1x
4160130

1x
4161281

2x
302326

2x
242026

1x
617926

2x
4100378

2x
383226

4x
4598528

1x
4277932

1x
4225201

2x
306826

4x
4183060

2x
3200126

4x
416226

3x
4636410

4x
4180508

4x
4180536

1x
4209003

4x
4251394

4x
4251393

1x
4209013

1x
4561035

4x
4160025

1x
4655565

1x
4157108

1x
4653244

2x
4273400

1x
4549989

1x
4650620
1x
4652745

2x
4516196

1x
4599984

1x
4667463

1x
9339

1x
4286267

4x
4121715

2x
366526

2x
4548180

2x
4497952
2x
4260942



2x
4125281



1x
4112838



2x
4233489



4x
4107637



1x
371028



2x
379528



1x
4556159



1x
4621946



1x
4621947



1x
4655389



2x
300528



1x
4597715



1x
4548009



1x
4655631



2x
4566927



2x
4528713



4x
4524365



2x
4211397



1x
4227776



2x
4211376



4x
4278273



2x
4211361



2x
4221775



1x
4211628



6x
4520320



1x
4211483



4x
4211807



1x
4544720



1x
4526985



1x
4502595



2x
4211088



1x
4211046



1x
4239373



1x
4567887



2x
4621917



1x
4648256



2x
4211133



2x
4211001



6x
4211065



3x
4211002



1x
4211115



1x
4211122



4x
4210726



5x
4196768



1x
4210782



1x
4210788



1x
4596895



1x
4546207



8x
4540386



3x
4210694



1x
4603472



1x
4508553



2x
4566607



4x
4566522



2x
4586410



1x
4655387



2x
4650619



1x
4566523



1x
4650628



1x
4655535



1x
4652294

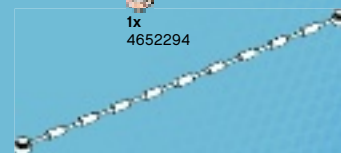

1x
4655670

Customer Service

Kundenservice

Service Consommateurs

Servicio Al Consumidor

LEGO.com/service or dial



: 00800 5346 5555

: 1-800-422-5346

LEGO CITY



4440



4439



4441



4437



4436

THE JOKER

BATMAN™

GREEN LANTERN



DC UNIVERSE™
SUPER HEROES

DCUNIVERSESUPERHEROES.LEGO.COM



4527



4526



4528



BATMAN 2

DC SUPER HEROES

DCUniverseSuperHeroes.LEGO.com



©2012 The LEGO Group.™ & © WBIE. (s12)

LEGO club
FREE! GRATIS! GRATUIT!



www.LEGOclub.com



LEGO Club Magazine



LEGO Club Email

VISIT THE WORLD'S
BIGGEST LEGO SHOP!

www.LEGOshop.com

00800 5346 5555

1-866-534-6258 • 1-877-518-5346

- * Freephone. Mobile charges may apply.
- * Numéro sans frais. Des frais peuvent s'appliquer avec les téléphones cellulaires.
- * Gebührenfrei. Kosten für Anrufe aus Mobilfunknetzen können abweichen.
- * Gratis telefonnummer vanaf vaste lijn.
- * Det er gratis nummer, når du ringer fra fasttelefon.
- * Det är gratis, när du ringer från en fast telefon.
- * Numéro sans frais. Des frais peuvent s'appliquer avec les téléphones portables.



8115

YES! I want to join the LEGO® Club FREE! **OUI!** Je veux m'abonner au LEGO® Club GRATUITEMENT!
Ja! Ich möchte Mitglied im kostenlosen LEGO® Club werden. **Ja!** Ik wil graag GRATIS lid worden van de LEGO® Club.
Ja! Jeg ønsker å melde meg inn i LEGO® Club gratis! **Ja!** Jag vill gå med i LEGO® Club GRATIS!

First name • Prénom
Vorname • Voornaam
Fornavn • Förnamn

Last name • Nom de famille
Name • Achternaam •
Etternavn • Efternamn

Date of Birth • Date de naissance
Geburtsdag • Geboortedatum
Fødselsdato • Födelsedatum

Boy • Garçon
Junge • Jongen
Gutt • Pojk

Girl • Fille
Mädchen • Meisje
Jente • Flicka

Street • Adresse
Straße, Hausnr.
Straat, huisnr. • Adress

City • Ville
Ort • Woonplaats
Poststed • Postort

State
Prov.
Country

Zip/Postcode
Code Postal • PLZ
Postcode
Postnummer

Country
Pays
Land

Email • Courriel
E-Mail • E-post

- Fill in your email address and we will send you a membership confirmation and monthly email newsletters. If you do not wish to receive the newsletters please tick here. Remplis ton adresse e-mail et nous t'enverrons une confirmation d'adhésion ainsi que le bulletin e-mail mensuel. Si tu ne désires pas recevoir le bulletin, coche cette case. Vul je e-mailadres in en we sturen je een bevestiging van je lidmaatschap en maandelijke e-mail nieuwsbrieven. Als je geen e-mail wilt ontvangen, kruis dan dit vakje aan.
- Ich möchte per E-Mail den monatlichen LEGO Club Newsletter erhalten. Ønsker du at vi skal sende en liten lisen til barnet ditt for å bekrefte medlemskapet, ber vi deg kryssse av i feltet, samt oppgi e-postadressen som hilsenen skal sendes til. Om du vill att vi ska skicka en bekräftelse på ditt barns medlemskap, ber vi dig sätta ett kryss i rutan och skriva den e-post adress som bekräftelsen ska skickas till.
- If you do not wish to receive additional mailings from the LEGO Club please tick here. Si tu ne désires pas recevoir de courriel supplémentaire du Club LEGO, coche cette case. Als je geen verdere post van de LEGO Club wilt ontvangen, kruis dan dit vakje aan.
- Dersom du ønsker å motta annen informasjon fra LEGO Gruppen, setter du et kryss her.

Mail to: / Poster à: **LEGO® Club**
P.O. Box 1157
Enfield, CT USA
06083-1157

Per Post an: **LEGO® Club**
Postfach 14 15
D-36243 Niederaula

Send til: **LEGO® Club Norge**
Postboks 58
1314 Vøyenenga

Mail to: **LEGO® Club**
33 Bath Road
Slough SL1 3UF
United Kingdom

Stuur op naar: **LEGO® Club**
Postbus 40250
3504 AB Utrecht

Skickas till: **LEGO® Club Sverige**
Ubox 841
202 29 Malmö

Post à: **LEGO® Club**
21 rue de la banque
75 002 PARIS
FRANCE

ENGLISH The English language version of the magazine can only be mailed to addresses in the US, Canada, the UK, and Republic of Ireland. Club membership is valid for two years and includes free copies of the LEGO Club Magazine and e-mail newsletters. In the US and Canada please allow up to 6 weeks for delivery of your first magazine. In the UK and Republic of Ireland please allow six to 14 weeks for delivery of your first magazine. By signing this form you consent the LEGO Club to use your child's data for LEGO mailings. The data will only be used for LEGO mailings and will not be sold, rented or otherwise disclosed to any company outside the LEGO Company except for disclosure to companies acting as our agents to help us provide services requested by the child. This coupon is valid for one free membership per person, group or organization. Photocopies of coupons are accepted. La version française du magazine peut être postée uniquement au Canada. L'abonnement est valide pour 2 ans et inclut des exemplaires gratuits du Magazine LEGO, Aux E-U et au Canada, allouer 6 semaines pour la livraison initiale. En remplissant ce formulaire, vous consentez à ce que LEGO utilise les informations de votre enfant pour des envois postaux de LEGO. L'information sera utilisée uniquement pour des envois postaux par LEGO et ne sera en aucun cas, vendue, louée, échangée ou divulguée à d'autres compagnies autres que la compagnie LEGO, à l'exception des compagnies affiliées qui nous procurent des services auxuels l'enfant en a fait la demande. Formulaire photocopies acceptées. Mit der folgenden Unterschrift erkläre ich, für mein Kind den Beitritt als Mitglied zum kostenlosen LEGO Club, der von der LEGO GmbH, D-85627 Garabrunn, betrieben wird. Die Mitgliedschaft beinhaltet die Zusendung des LEGO Club Magazine und kann beiderseits getriggert beendet werden. Mit der Mitgliedschaft im LEGO Club sind keine Verpflichtungen verbunden. Das deutschsprachige LEGO Club Magazine wird nur an Adressen in Deutschland, Österreich und der Schweiz versendet. Eine Anmeldebestätigung kann nur per E-Mail geschickt werden. Das Magazin erscheint fünfmal jährlich. Ich bestätige die Zustellung des ersten Heftes bis zu drei Monate dauern. Die Mitgliedschaft ist beidseitig jederzeit kündbar, ohne dass Ihnen Kosten entstehen. Sie können der werblichen Nutzung Ihrer Daten jederzeit widersprechen, Kündigung und Widerspruch können Sie telefonisch erklären (00800 / 5346 5555, Anruf gebührenfrei, Kosten für Anrufe aus dem Mobilfunknetz können abweichen) oder an die LEGO GmbH senden. Het Nederlandse LEGO Club Magazine kan alleen worden gestuurd naar adressen in Nederland. Het lidmaatschap is 2 jaar geldig en geeft recht op toezending van het gratis LEGO Club Magazine en LEGO Club e-mails. Het eerste magazine zal binnen 12 tot 14 weken toegestuurd worden. Het lidmaatschap kan op ieder moment opgezegd worden en kan na 2 jaar gratis worden verlengd, tenzij LEGO met deze activiteit stopt. Uw gegevens worden uitsluitend gebruikt voor mailings van LEGO en zullen niet worden verkocht, verhuurd of op welke wijze ook vast verstrekt aan derden buiten de LEGO Groep, uitgezonderd de organisaties die namens ons optreden om de informatie te sturen waarvoor toestemming is verleend. Den norske utgaven av magasinet sendes kun til adresser i Norge. Medlemskap i klubben gjelder i 2 år og inkluderer gratisutgaver av LEGO Club Magazine. Påregnet minimum opp til seks uker leveringstid for første magasin. Ved å undertegne dette skjemaet, gir du ditt samtykke til at LEGO Club kan bruke opplysningene om barnet ditt i LEGO forsendelser. Dataene vil utelukkende bli brukt i LEGO forsendelser og vil ikke bli solgt, utleid eller på annen måte gjøres tilgjengelig for selskaper utenfor LEGO gruppen, unntatt selskaper som vi våre agenter og som hjelper oss å tilby tjenestene barnet etterseer. Dette skjemaet gjelder for ett gratis medlemskap per person, gruppe eller organisasjon. Den svenska versionen av tidningen kan endast skickas till adresser i Sverige. Club-medlemskapet är giltigt i 2 år och innefattar gratis exemplar av LEGO Club Magazine. Villigen räknas med minimum 6 veckor för leverans av din första tidning. Genom att skicka in det här formuläret godkänner du att LEGO Club använder barnets uppgifter för LEGO utskick. Uppgifterna kommer bara att användas för LEGO utskick och kommer inte att säljas, hyras ut eller vidarebefordras till något företag som inte tillhör LEGO Gruppen, med undantag av företag som agerar som våra ombud för att tillhandahålla tjänster som barnet har begärt. Den här kupongen gäller för ett gratis medlemskap per person, grupp eller organisation. En complément ce bulletin d'adhésion, vous acceptez que LEGO Club utilise les données relatives à votre enfant pour l'envoi de courriers concernant LEGO. Ces données seront uniquement utilisées pour l'envoi d'information concernant LEGO et ne seront ni vendues, ni louées, ni utilisées par d'autres sociétés que le groupe LEGO, à l'exception des sociétés agissant pour le compte de LEGO en tant que sous-traitant de services divers. L'abonnement au LEGO Club est valable pour une période de 2 ans. Il inclut LEGO par courrier du magazine LEGO Club et par email des newsletters. Un délai de 6 à 14 semaines est à prévoir pour la réception de votre premier magazine. Ce bulletin d'adhésion gratuit est valable pour l'inscription d'une seule personne. Les photocopies sont acceptées. ATTENTION! Le bulletin d'adhésion doit être rempli et signé par un parent ou un tuteur.

Parent's signature • Signature d'un parent ou d'un tuteur •
Unterschrift Erziehungsberechtigter • Handtekening ouders •
Föreläres/foresattes underskrift • Förälders förmyndares underskrift

Date
Datum
Date



WIN!

Go to www.LEGOsurvey.com/product to fill out a survey for a chance to win a cool LEGO® Product.

No purchase necessary.

Open to all residents where not prohibited.



LEGO.com



www.LEGOsurvey.com/product

GEWINNE! WIN!

Nimm an der Umfrage auf www.LEGOsurvey.com/product teil und hab die Chance ein cooles LEGO® Produkt zu gewinnen!

Die Teilnahme am Gewinnspiel führt zu keinerlei Kaufverpflichtungen. Teilnahme in allen nicht ausgeschlossenen Ländern möglich.

Ga naar www.LEGOsurvey.com/product, vul een enquêteformulier in en maak kans op een cool LEGO® product.

Geen aankoopverplichting. Iedereen mag deelnemen, uitgezonderd ingezetenden van landen waar een enquêteverbod geldt.

GAGNE! 当てよう!

Visite www.LEGOsurvey.com/product pour répondre à un questionnaire et avoir une chance de gagner un produit LEGO® très cool!

Aucune obligation d'achat. Ouvert à tous les résidents des pays autorisés.

www.LEGOsurvey.com/product にアクセスしアンケートにご記入ください。当選者には1製品を差し上げます。

お買い上げの必要はありません。

禁止されていない限り、すべての皆様にご利用いただけます。