



# NEXO KNIGHTS



70358





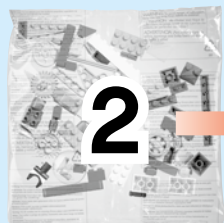

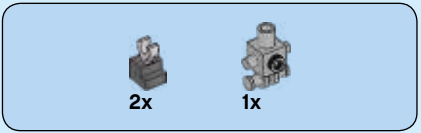
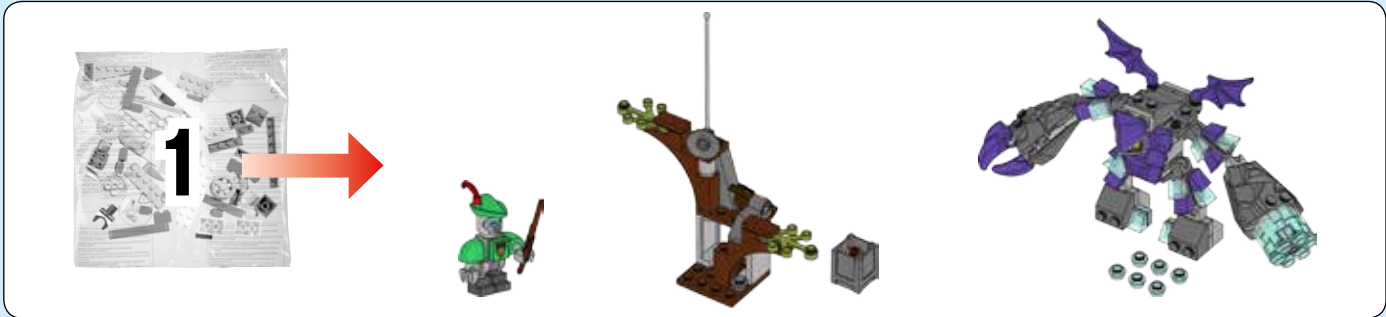

1

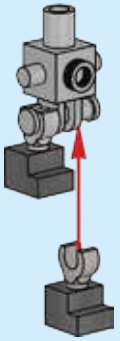

4



2

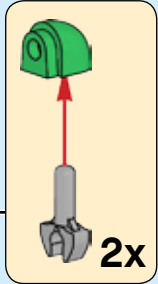
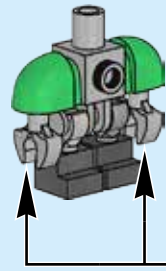





1x



1x

3



1x



1x



1x

4

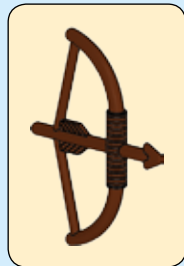
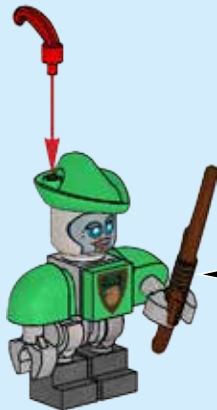

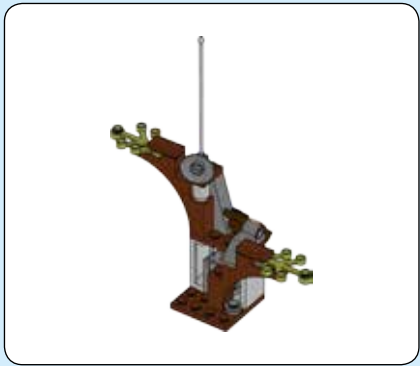

1x

1



6

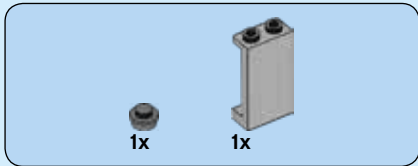

1x

1x

2



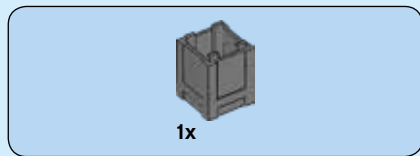

3

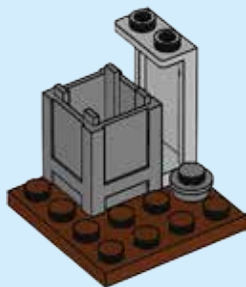

4

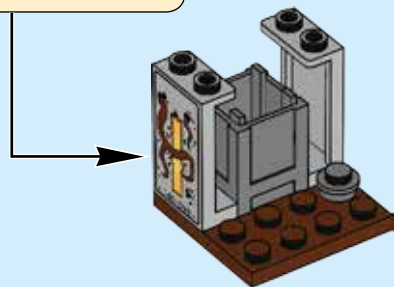
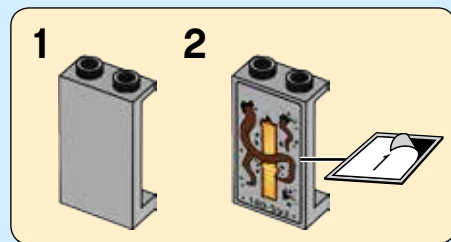



1x

5

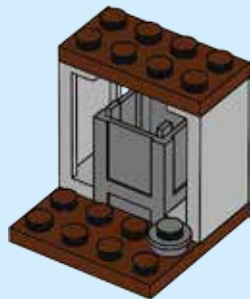

8



1x

6

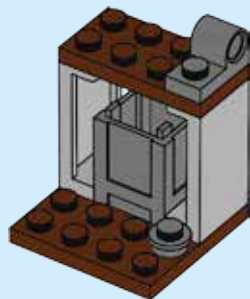

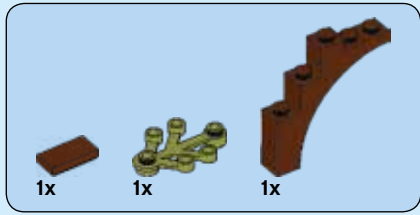

7

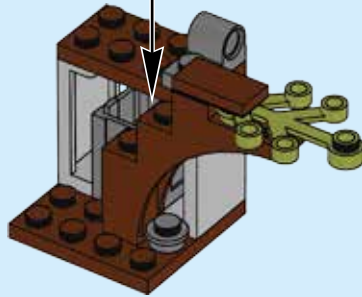
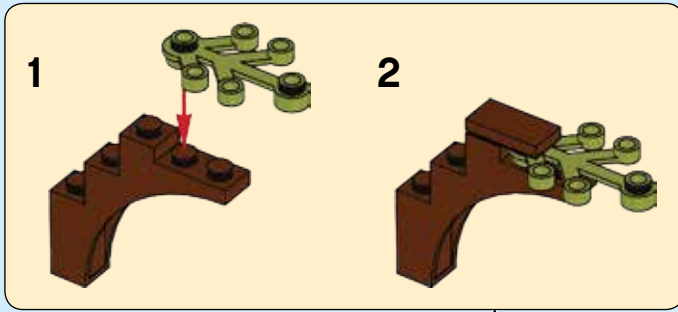





1x

8

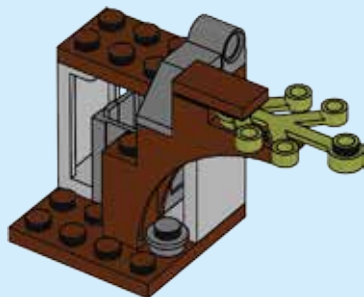

10

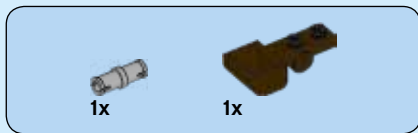

9

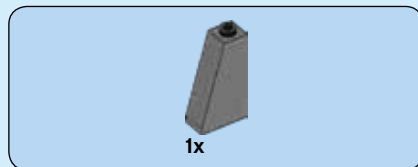
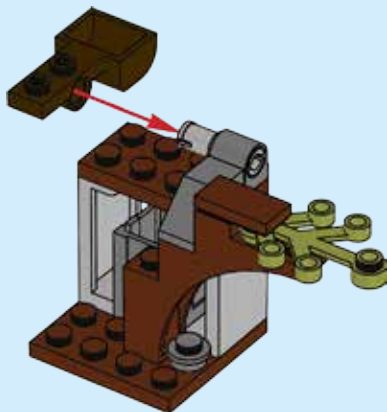

10

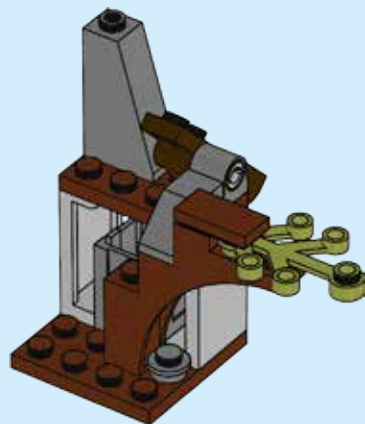

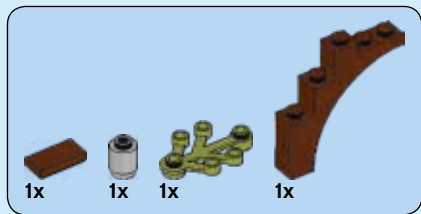

11

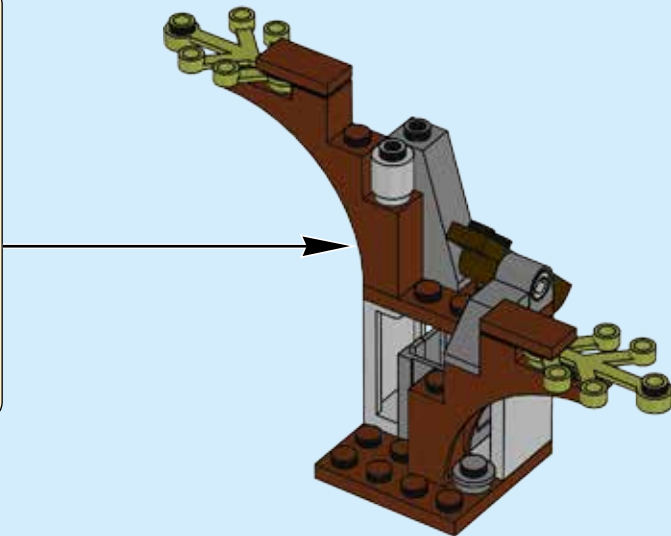
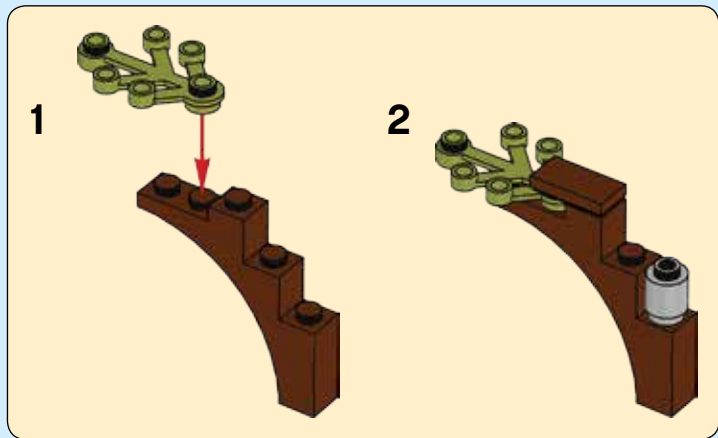

12



1x

12

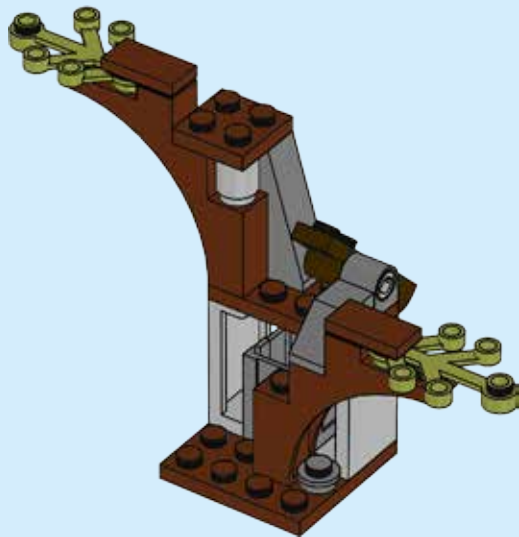

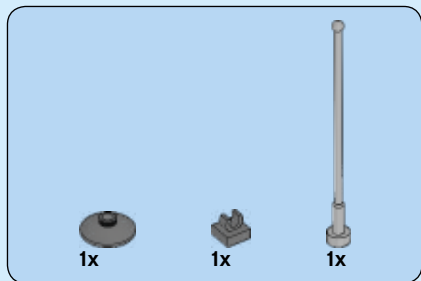

13

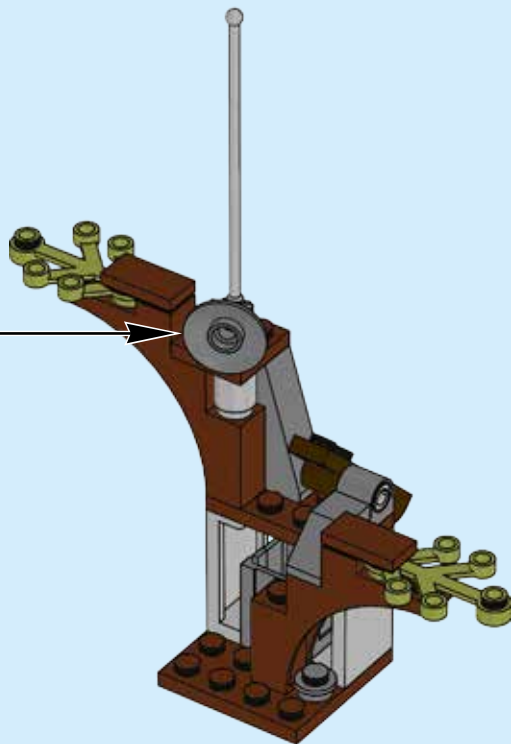
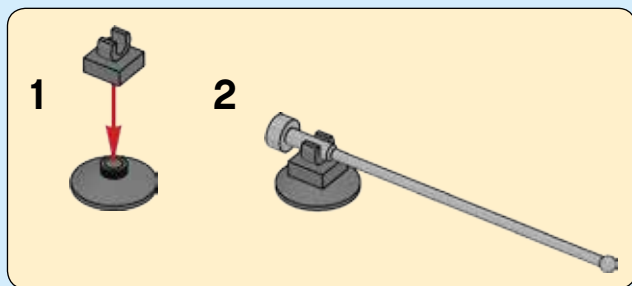





2x

14

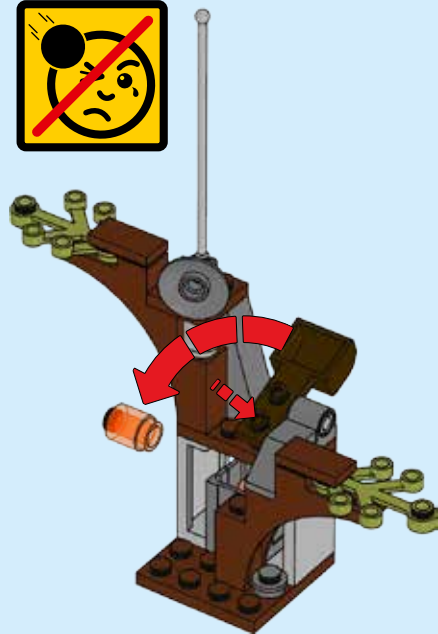
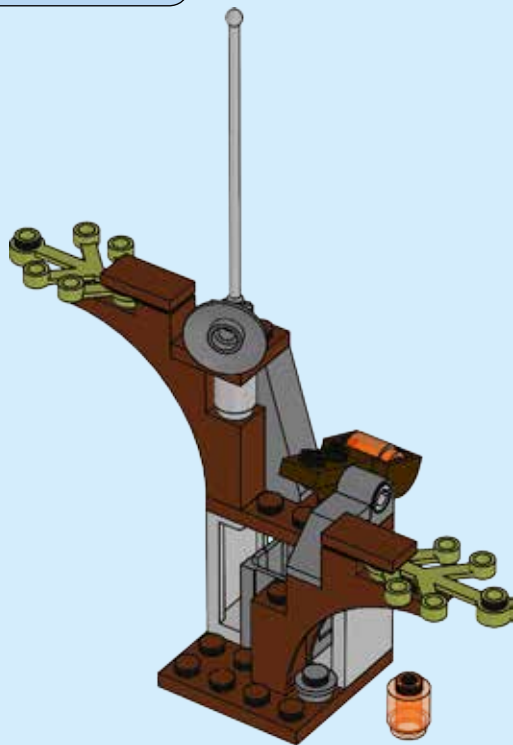



1x

1x

1

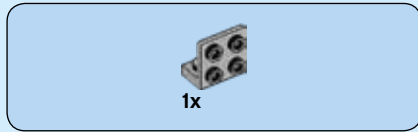
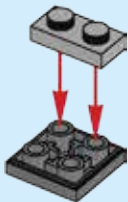

1x

2

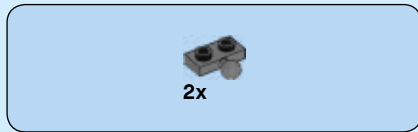
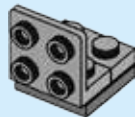

2x

3



2x

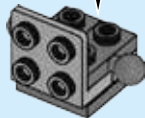



1x

4

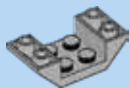
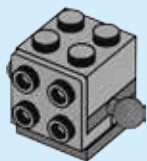

1x

5

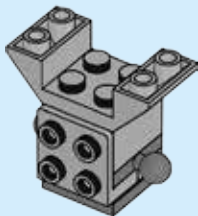

2x



1x

6

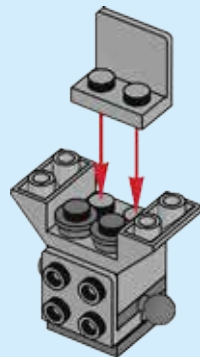



1x

7

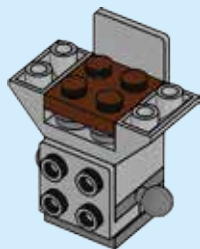

1x



2x

8

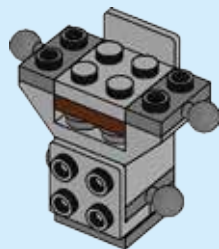



1x



1x

9

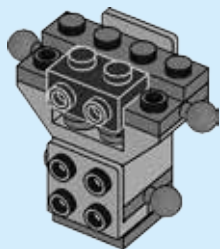

1x

10

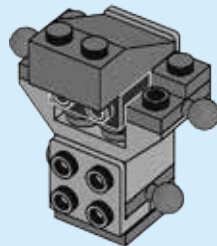





11

1

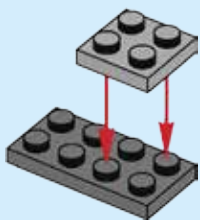

2

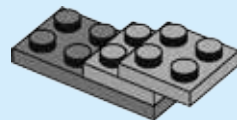

3

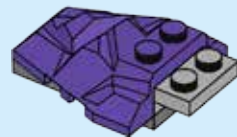

4

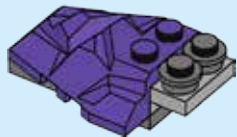

5

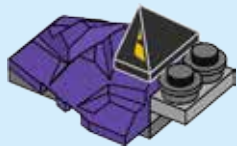

6

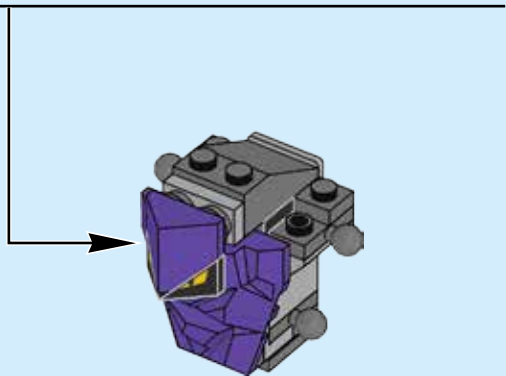



2x

12

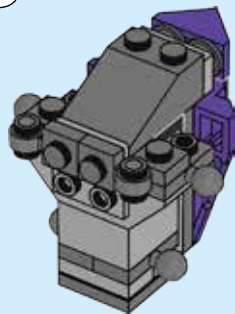
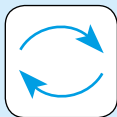

1x

13

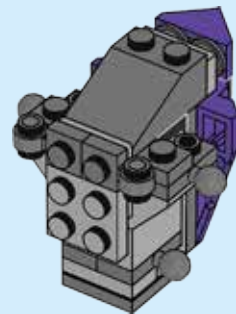



1x

14

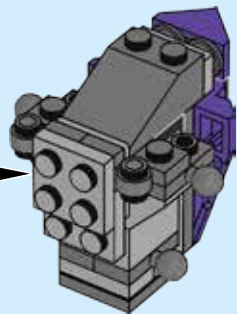

2x

15

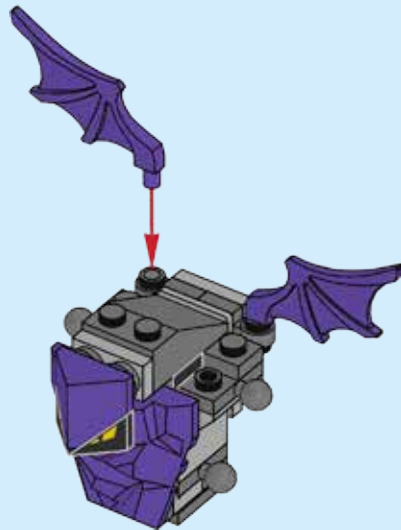
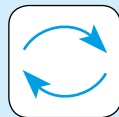

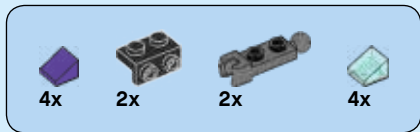

16

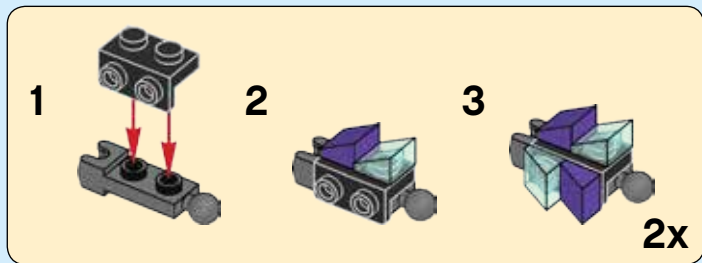
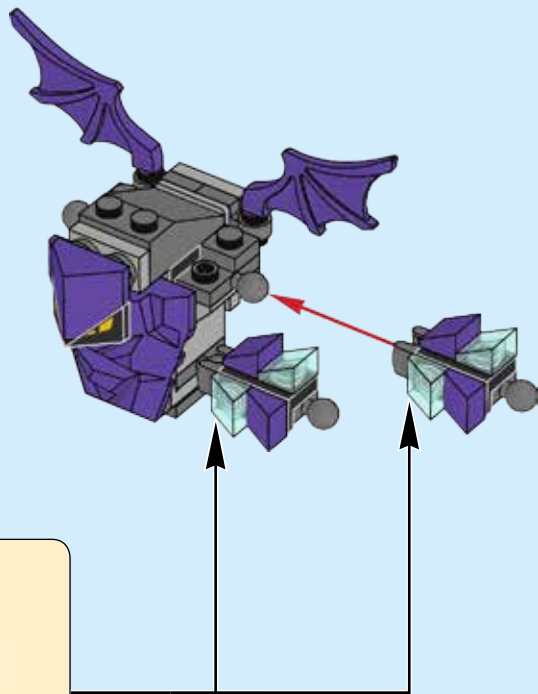



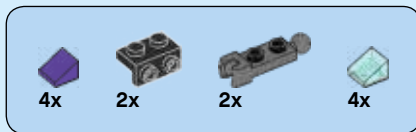

17

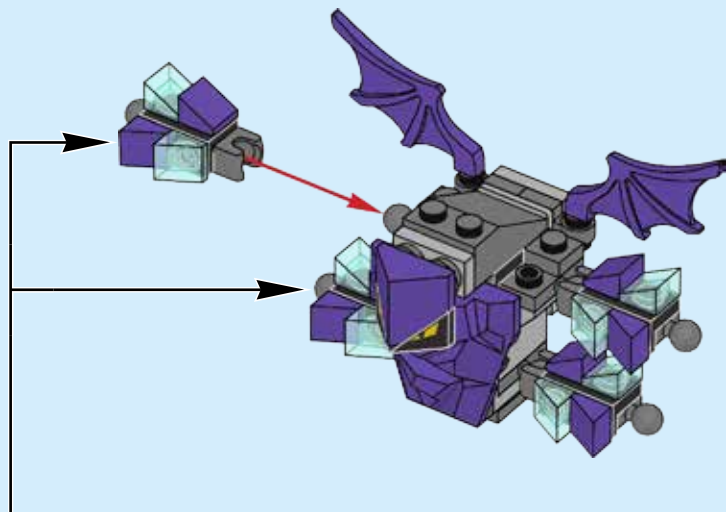

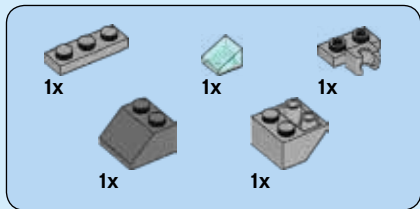

18

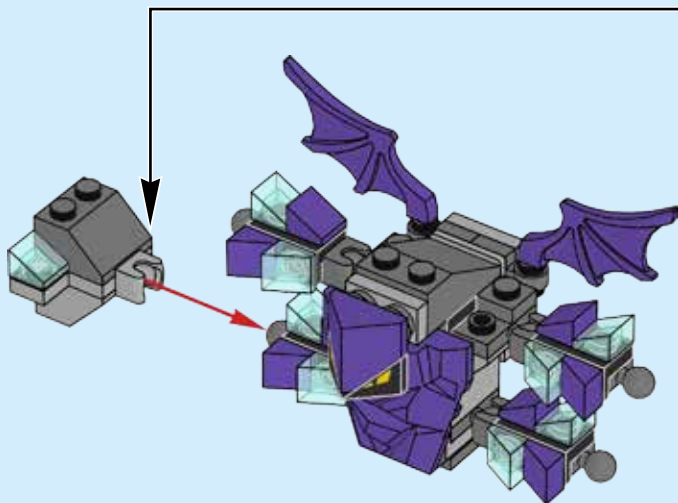
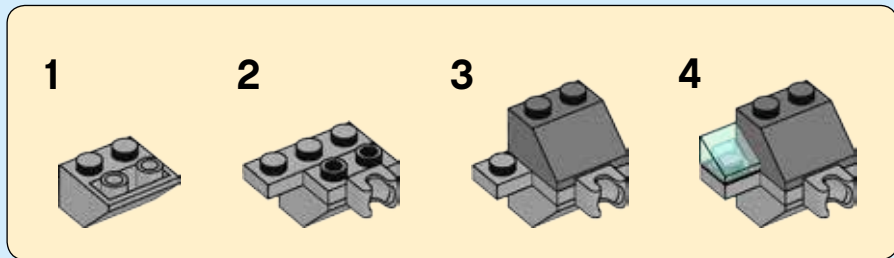

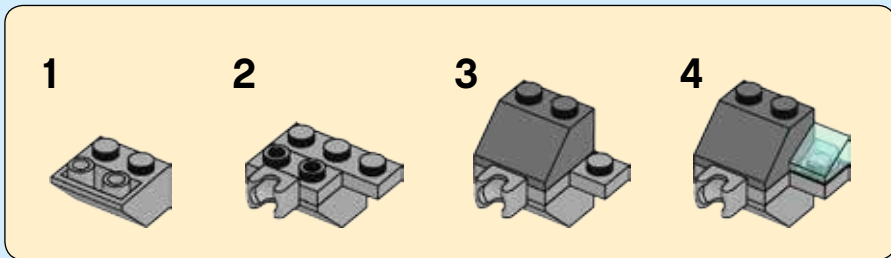
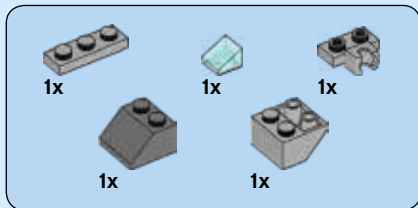

19

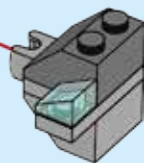
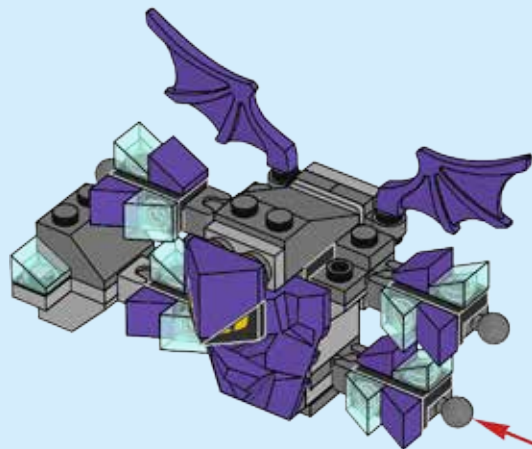

20

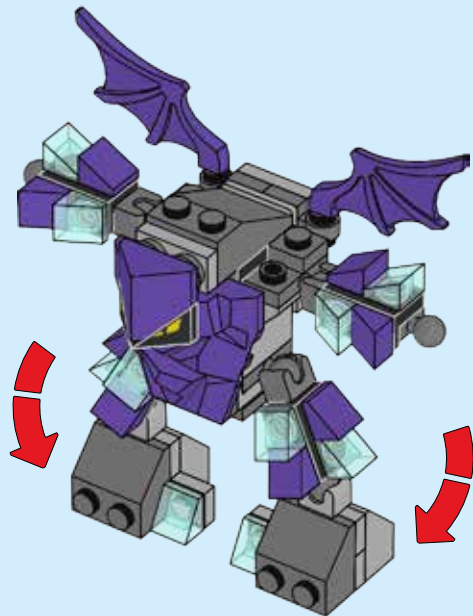

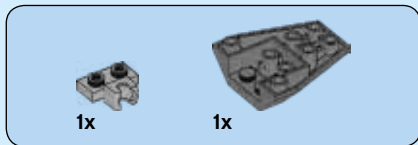

21

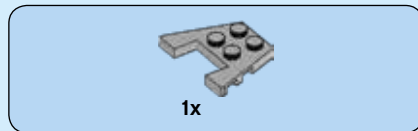
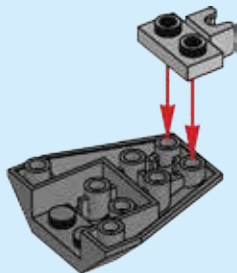

22

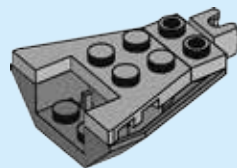

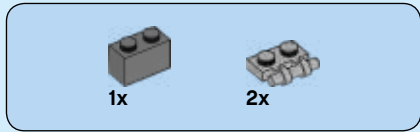

23

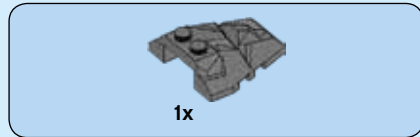
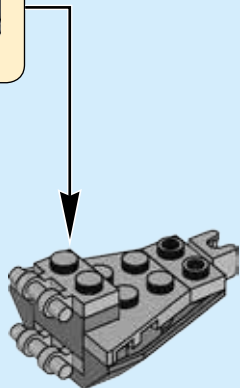
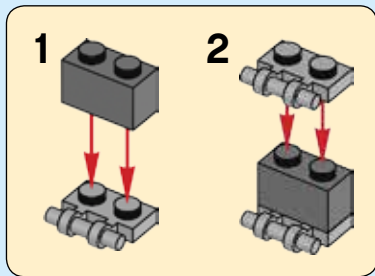

24

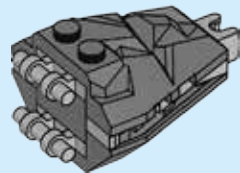

25

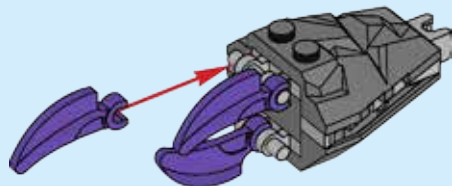

26

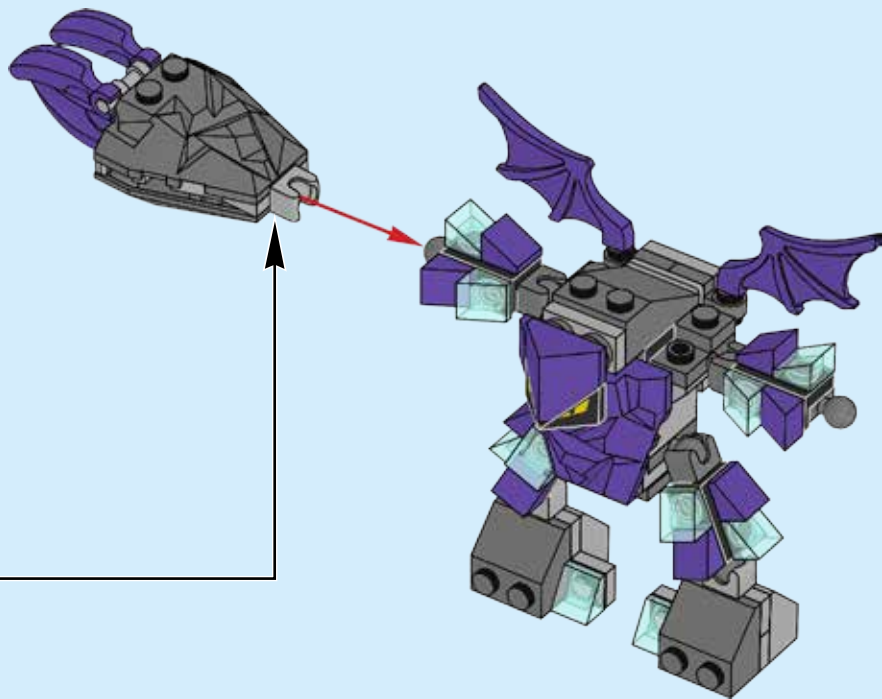

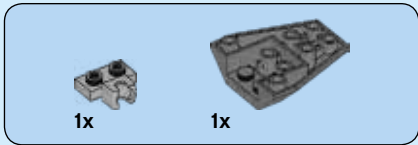

27

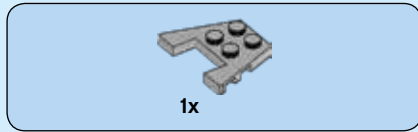
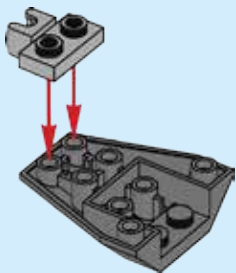

28







2x



1x

# 29

1

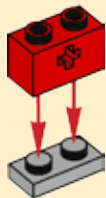

2

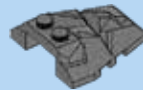

1x

# 30

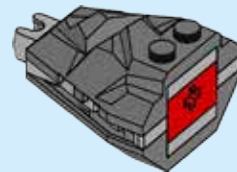

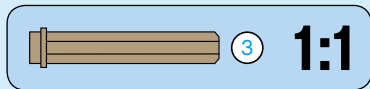
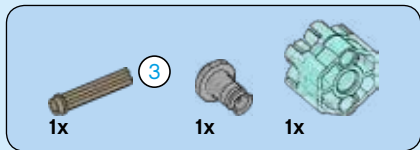

31

1

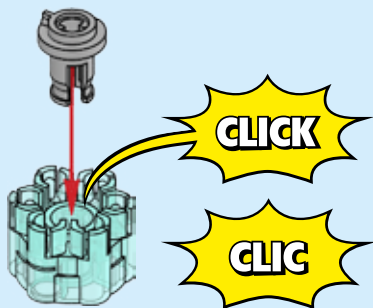

2

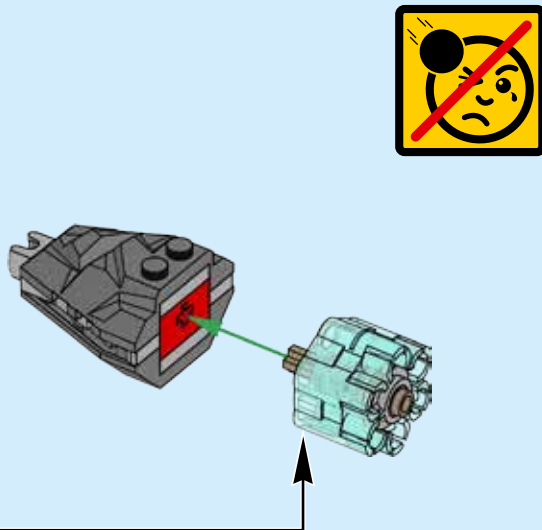
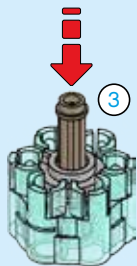

32

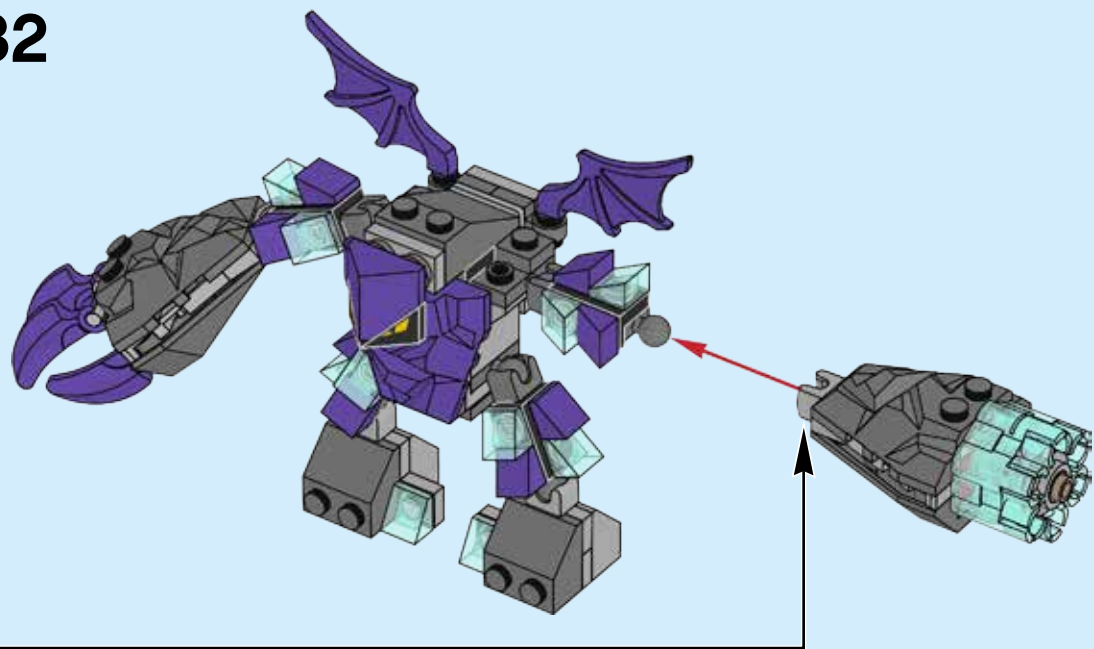



12x

33

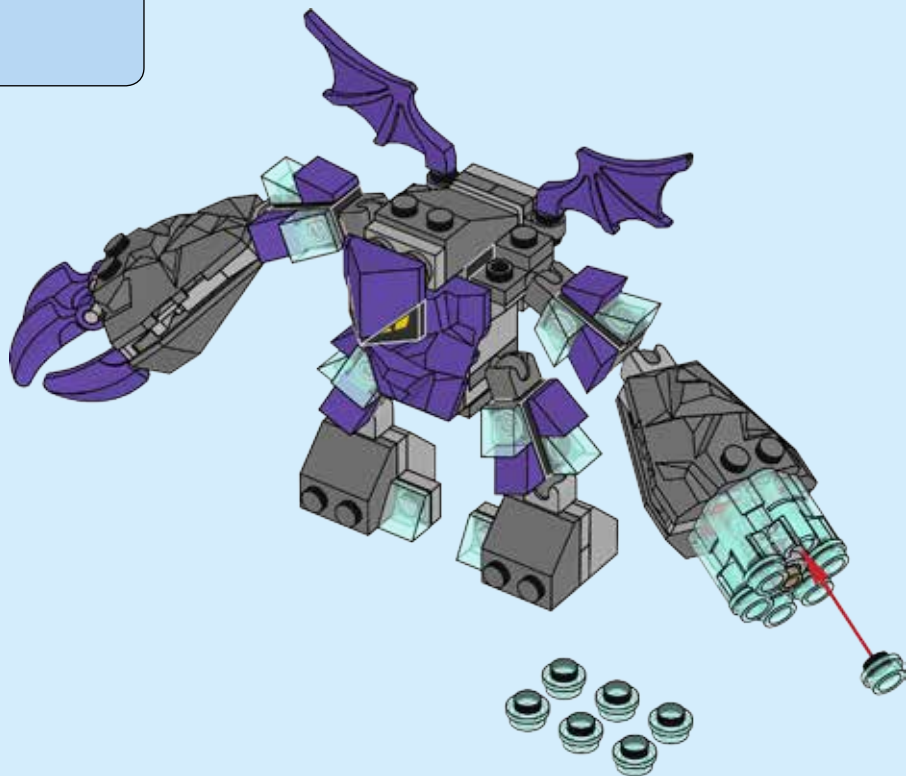

36

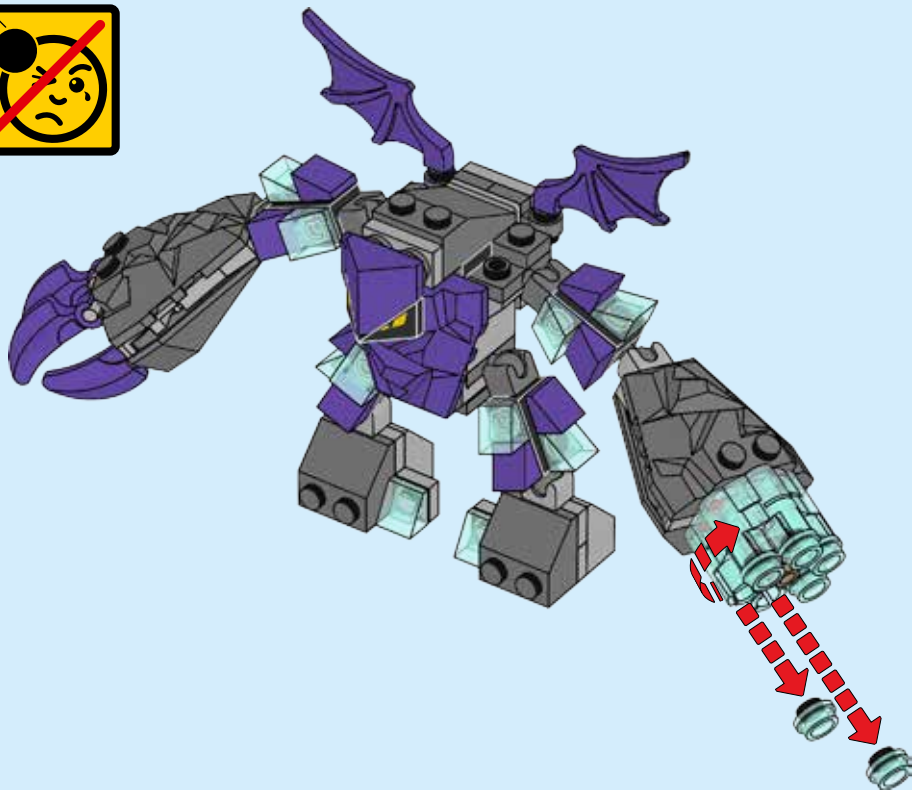

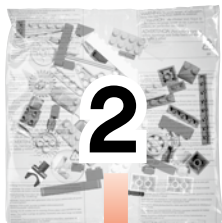

1





1x



1x

2

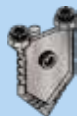
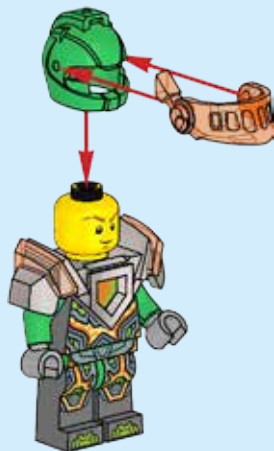

1x



1x



1x

3



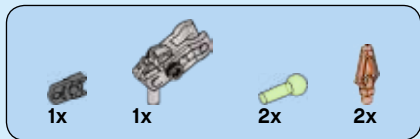

4

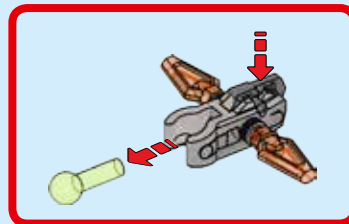



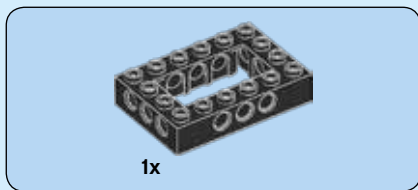
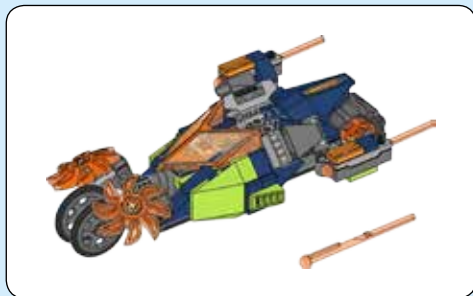

**1**

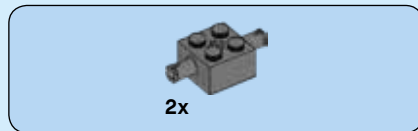
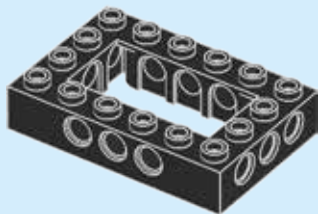

**2**

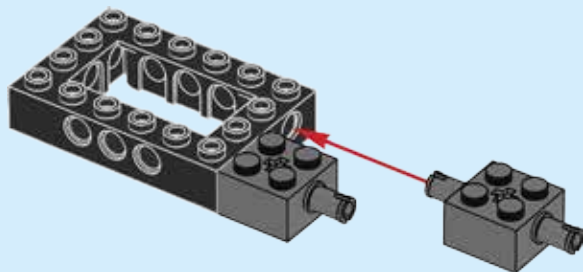

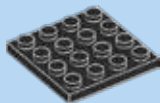

1x

3

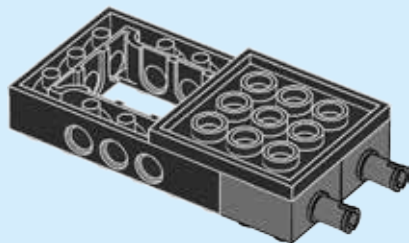
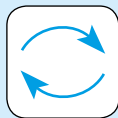

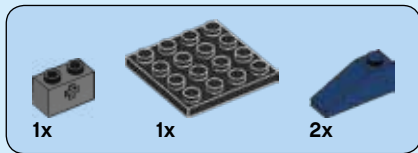

4

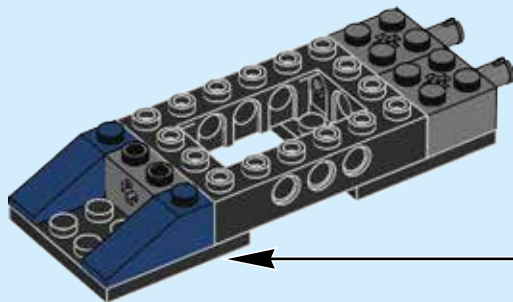
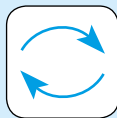



2x

5

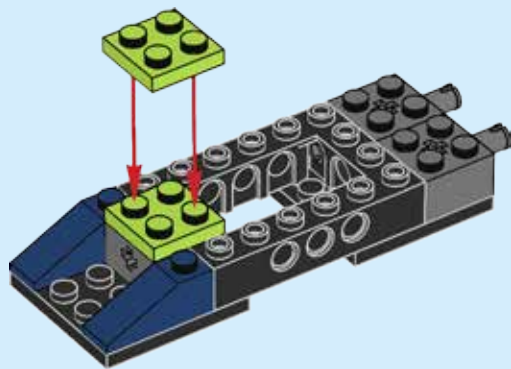

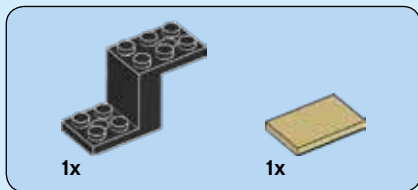

6

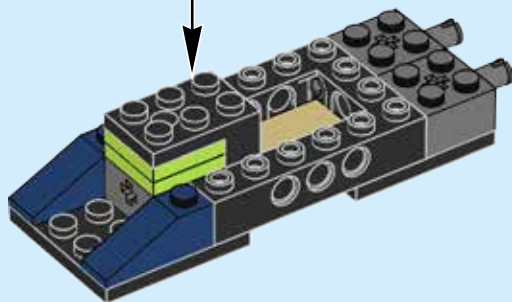
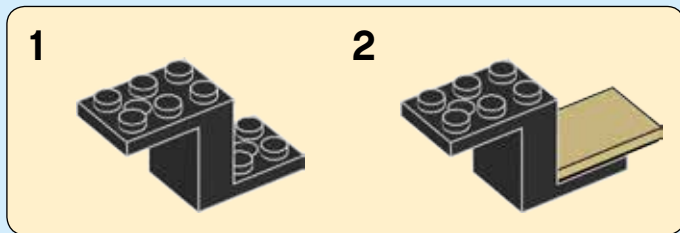



7

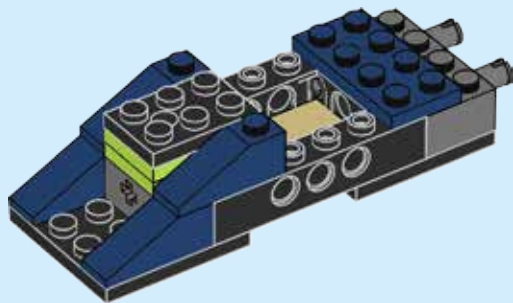

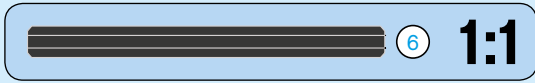
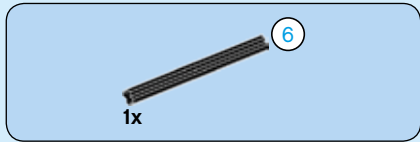

8

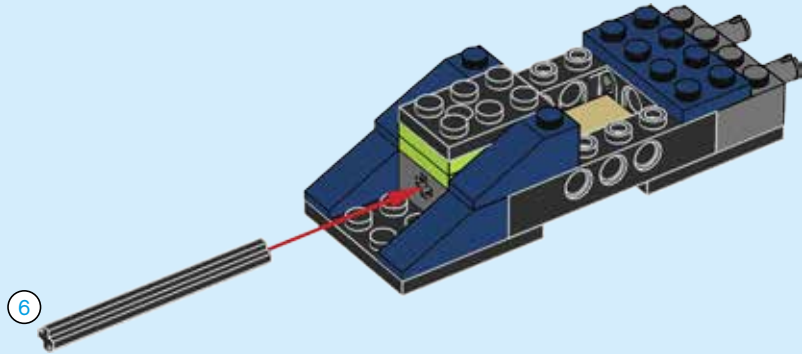



1x

9

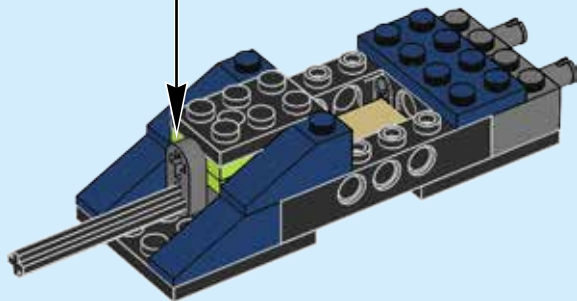



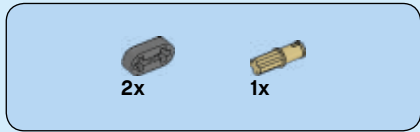

10

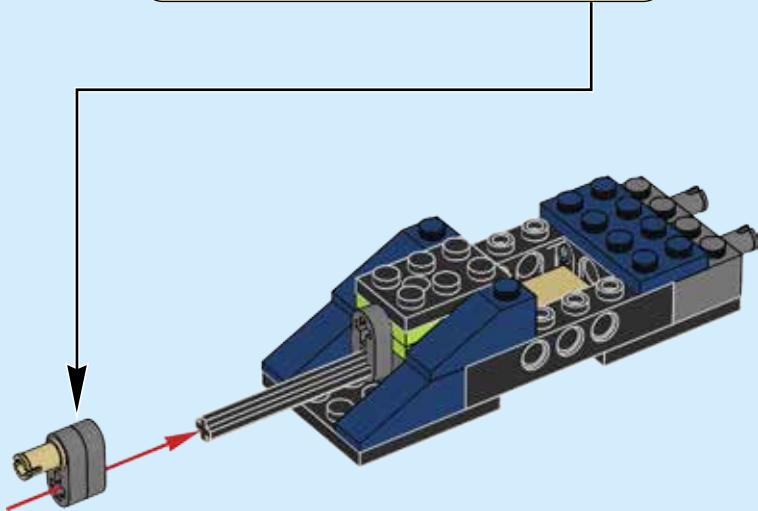
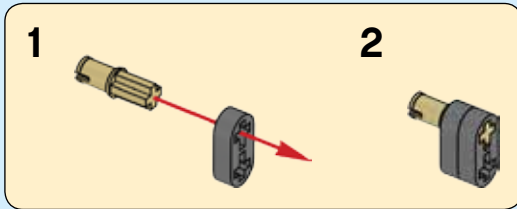

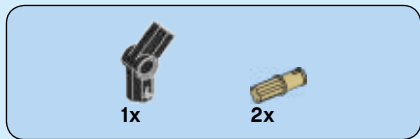

11

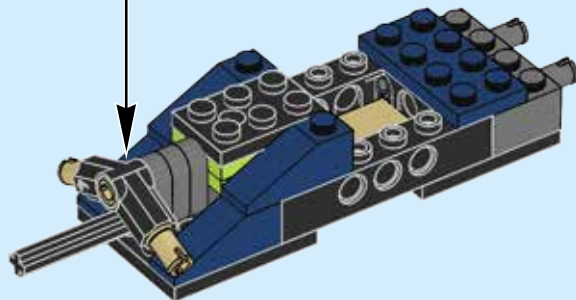
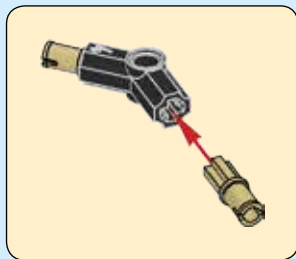



1x

# 12

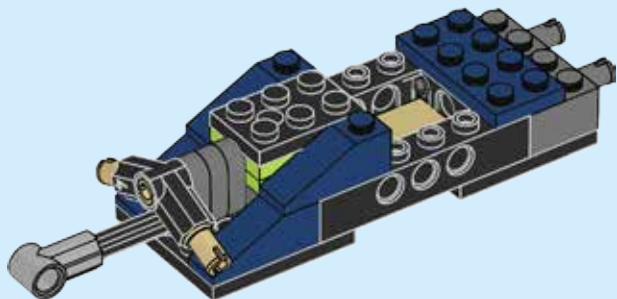

1x



1x



1x

# 13

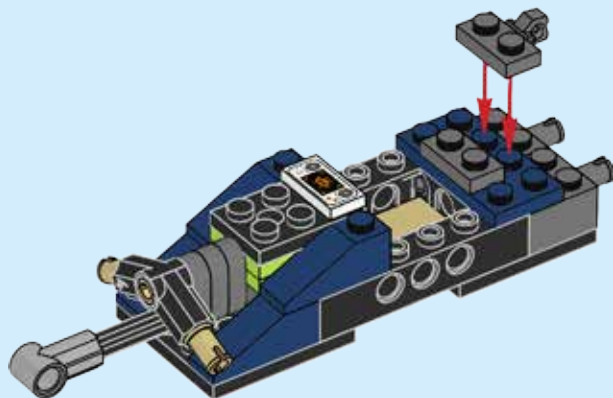



2x



2x

# 14

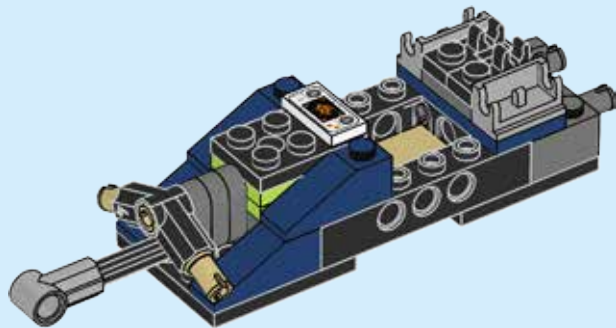

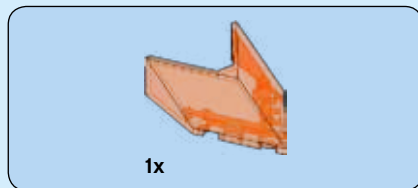

15

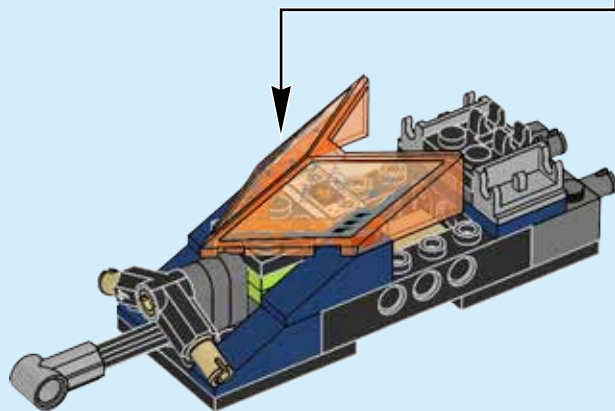
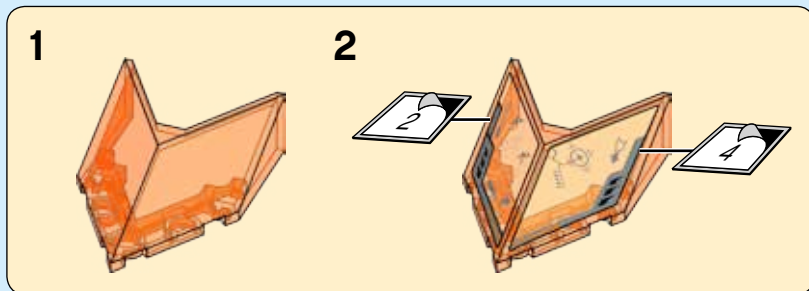

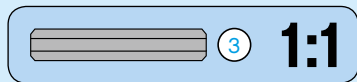
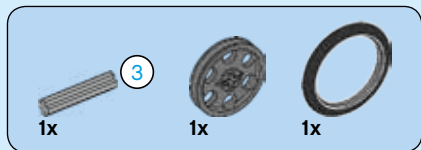

16

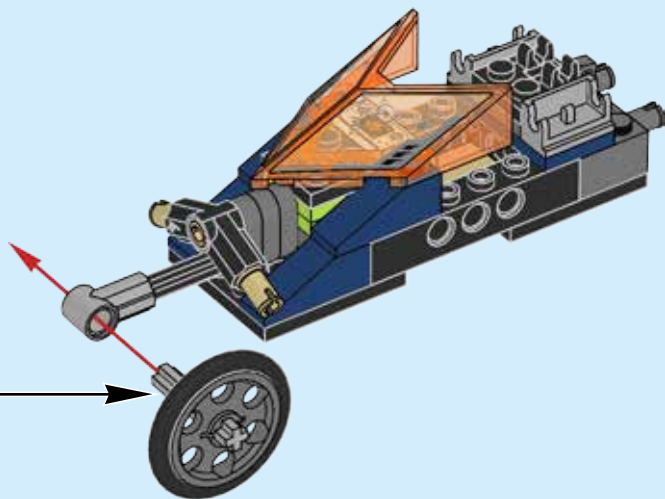
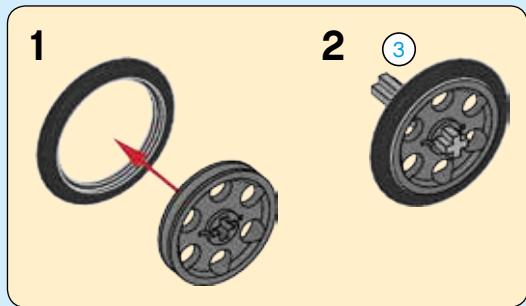

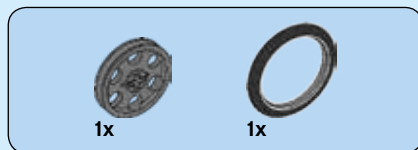

17

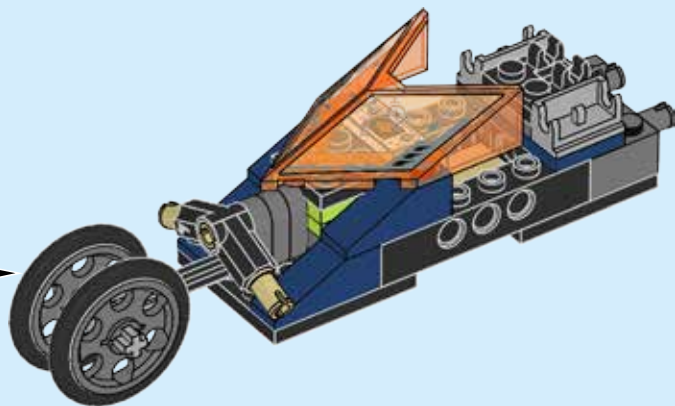
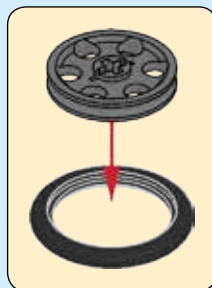



1x

18

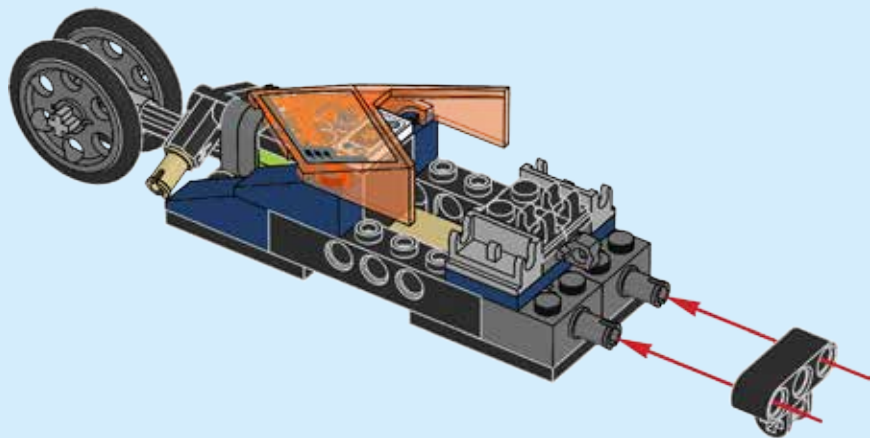



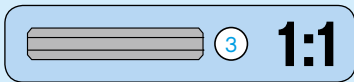

19

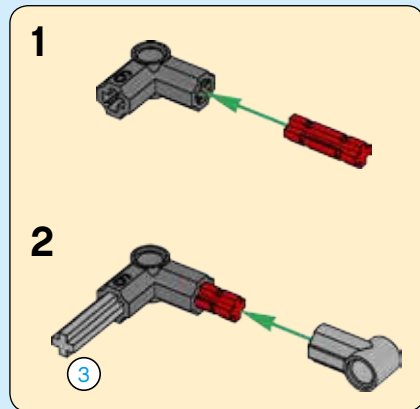
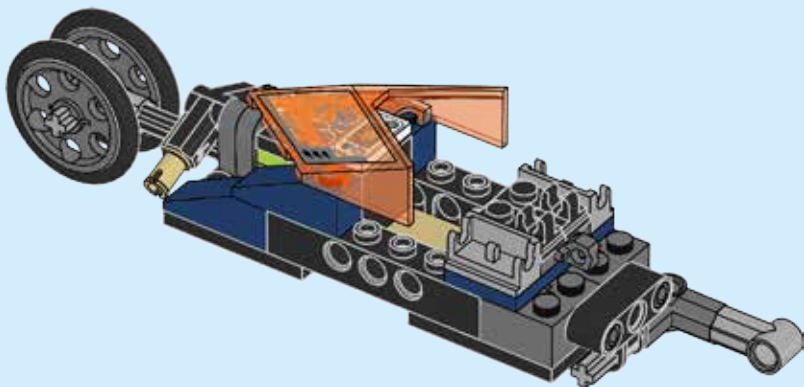

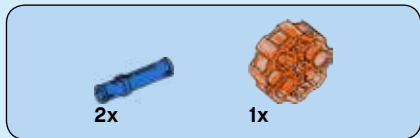

20

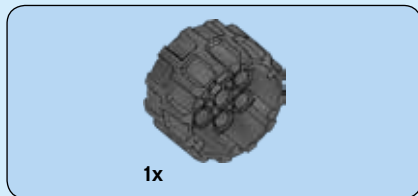
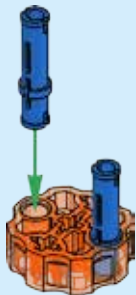

21

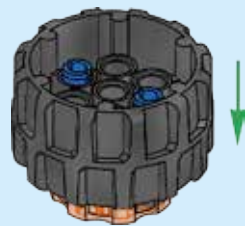



1x

# 22

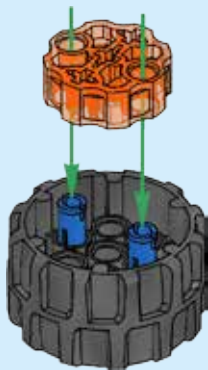

1x

# 23

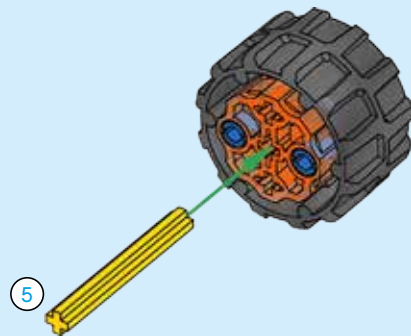
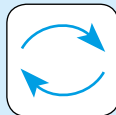

5

# 1:1

24

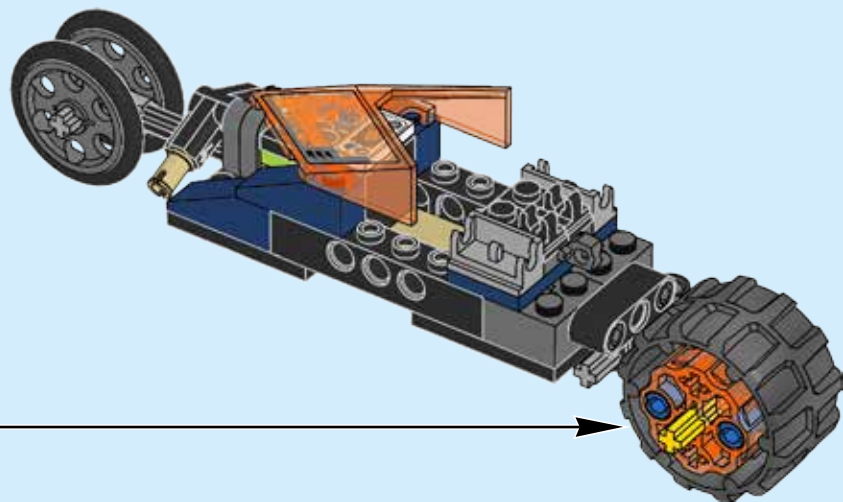

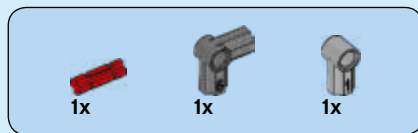

# 25

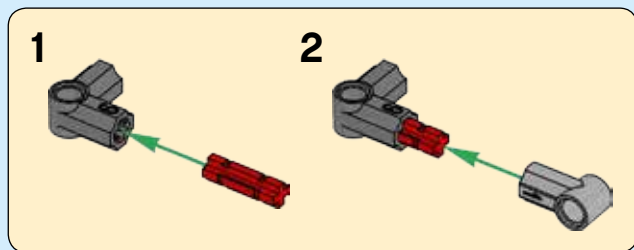
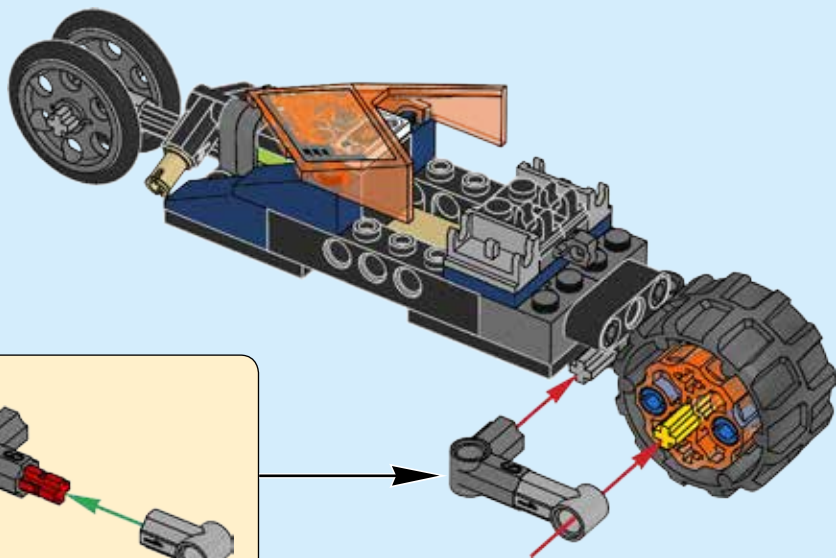



2x



2x



2x



4x



4x



2x



2x

# 26

1

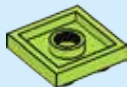

2

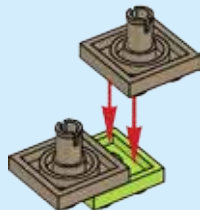

3

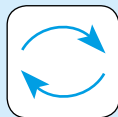

4

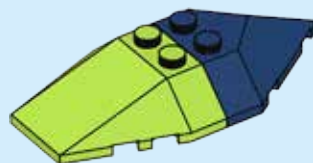

5

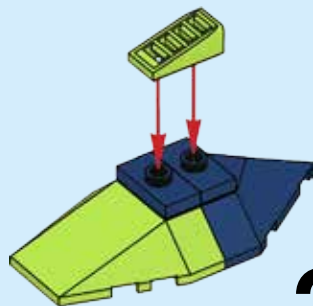

2x

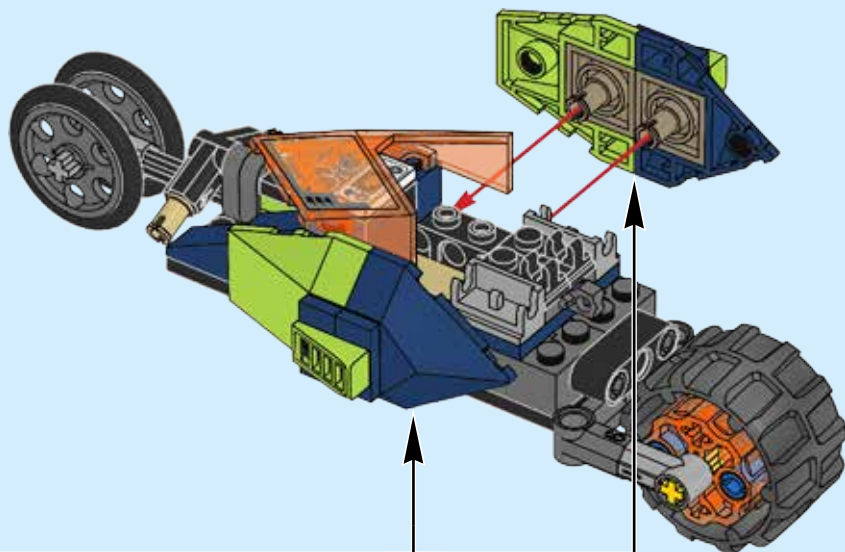



2x

27

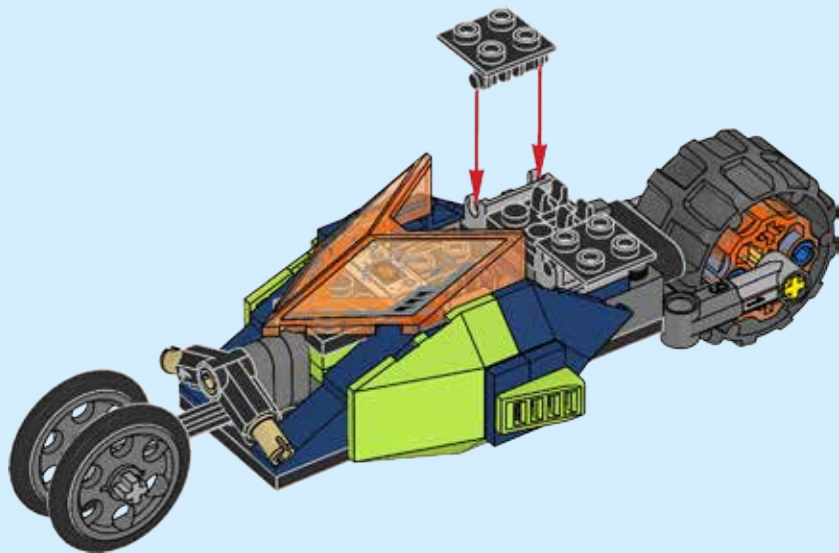



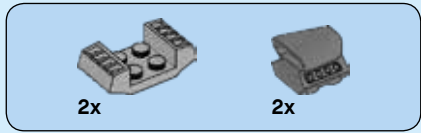

28

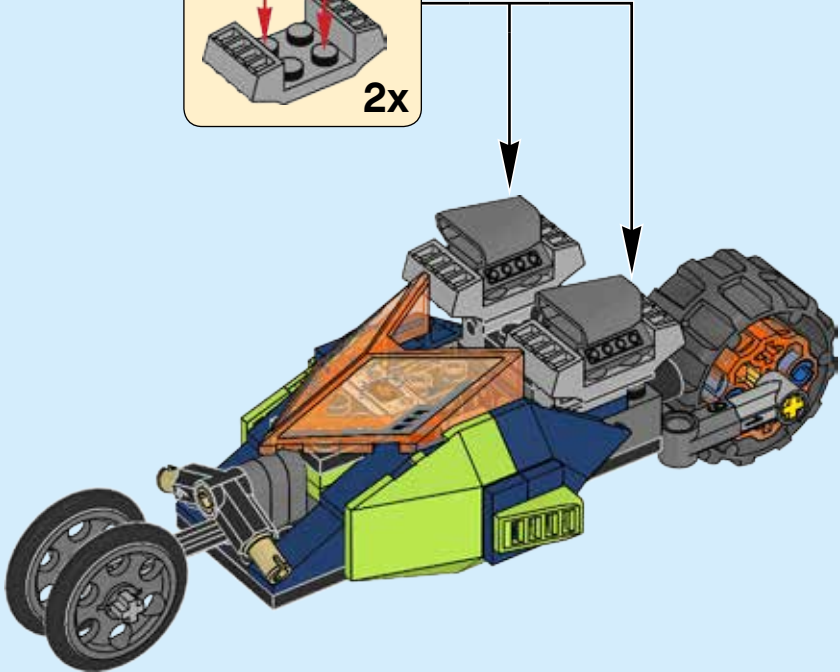
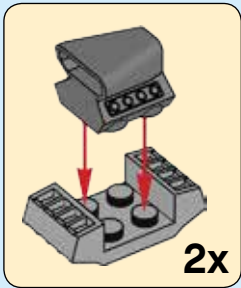

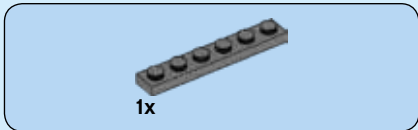
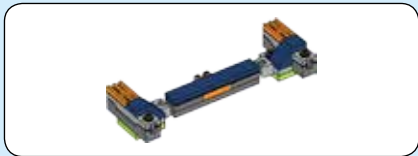

29

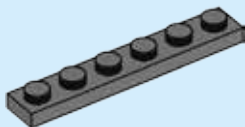

66



30

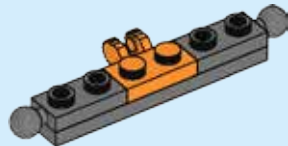

31

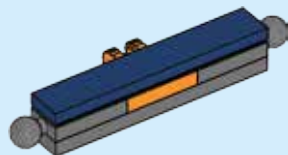

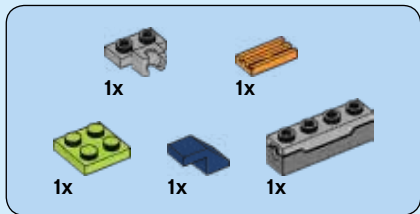

32

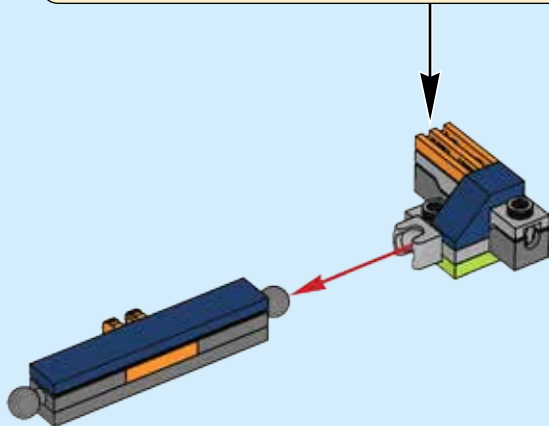
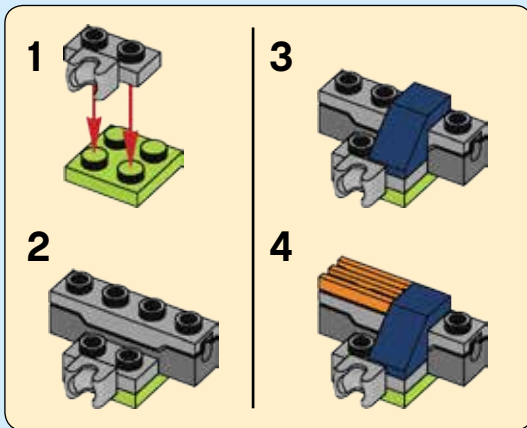

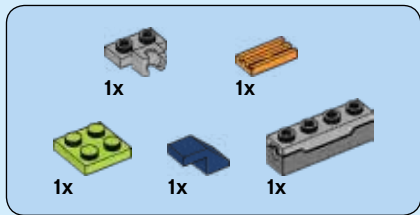

33

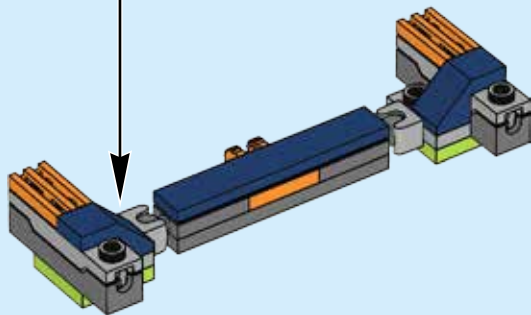
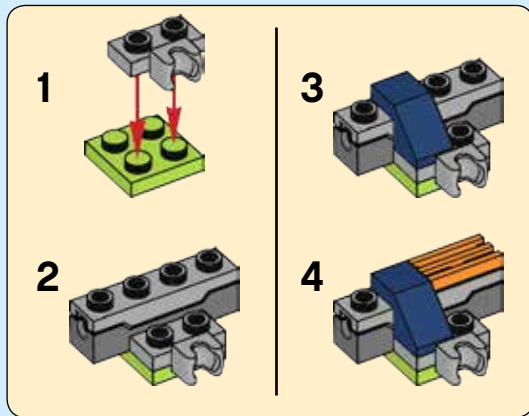

34

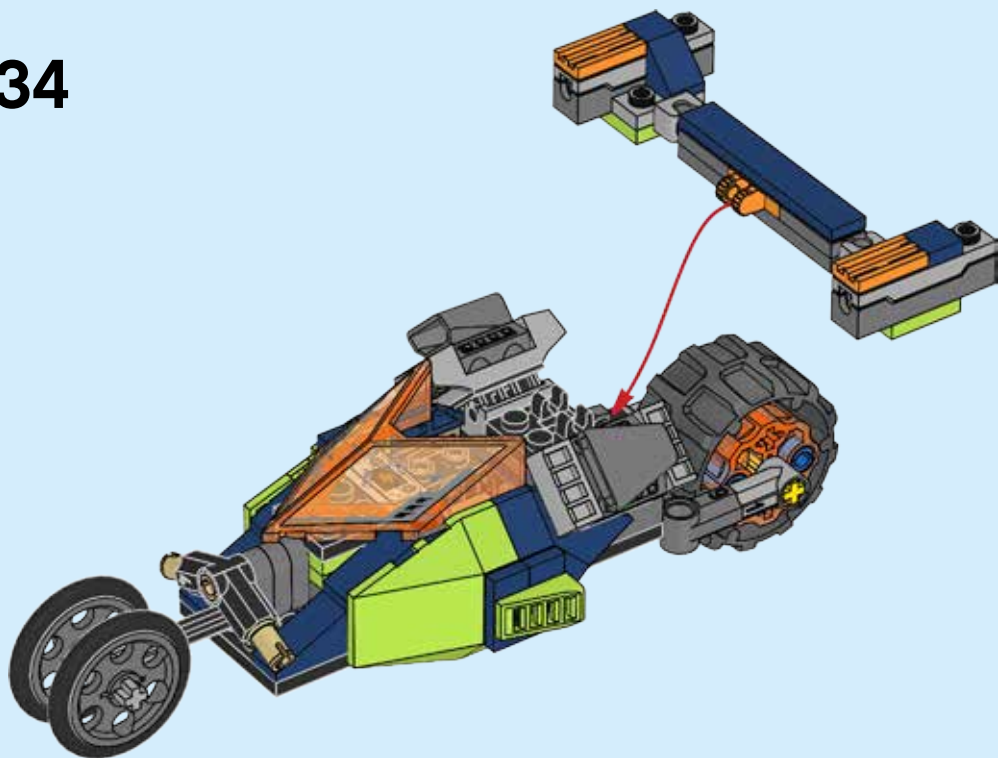



1x

# 35

1



2

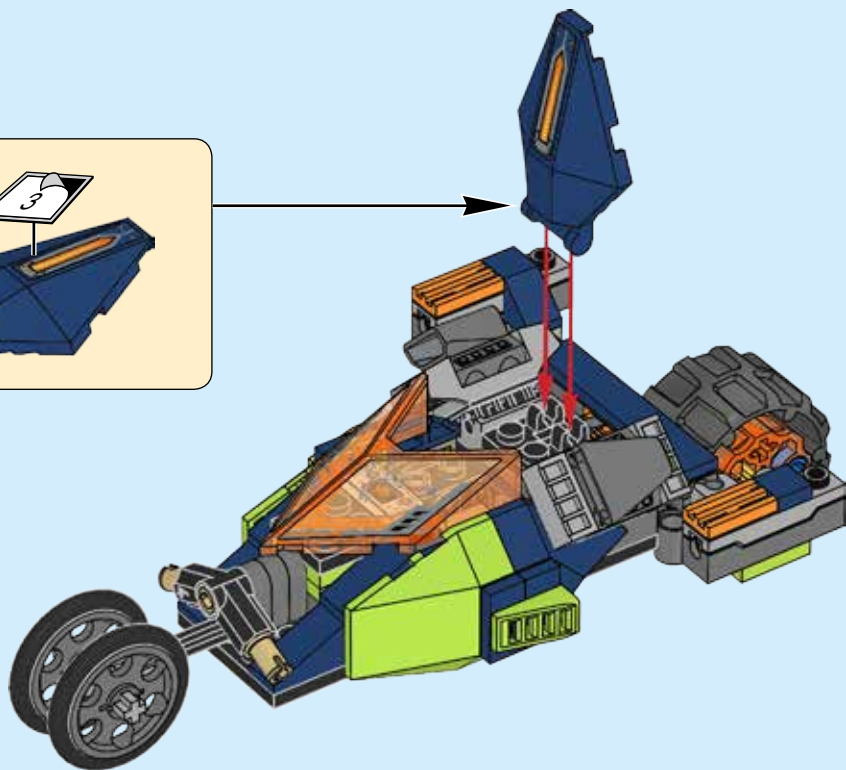

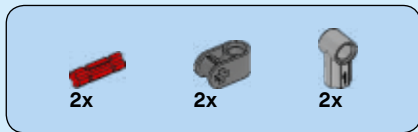

# 36

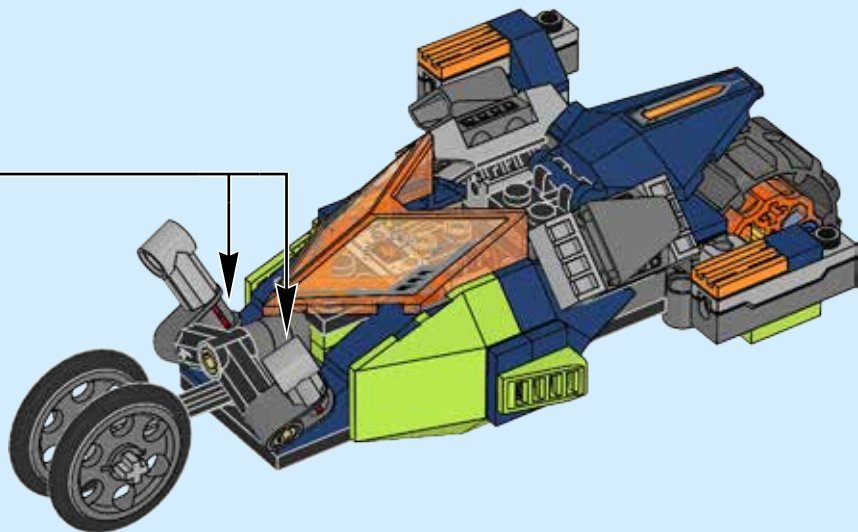
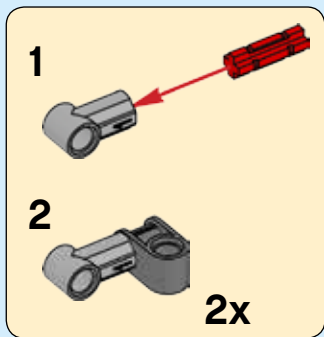



37

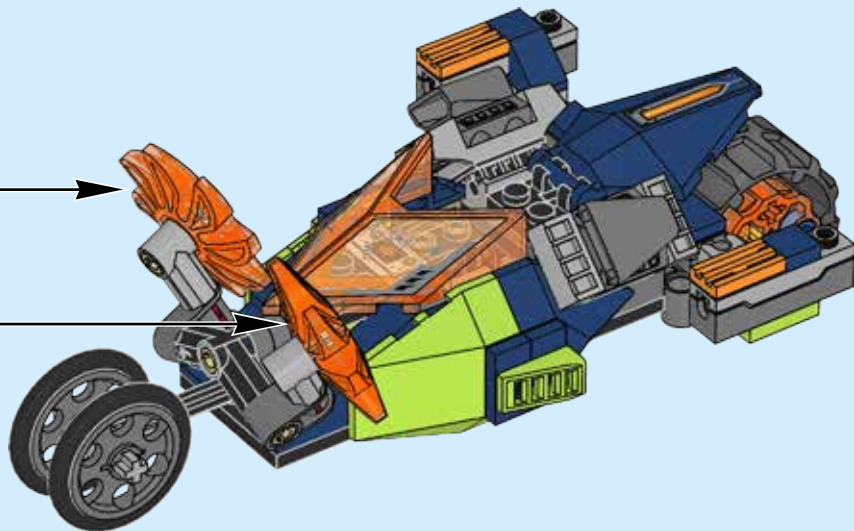
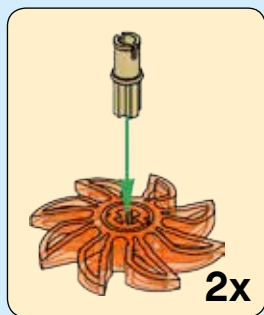



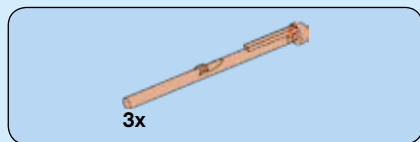



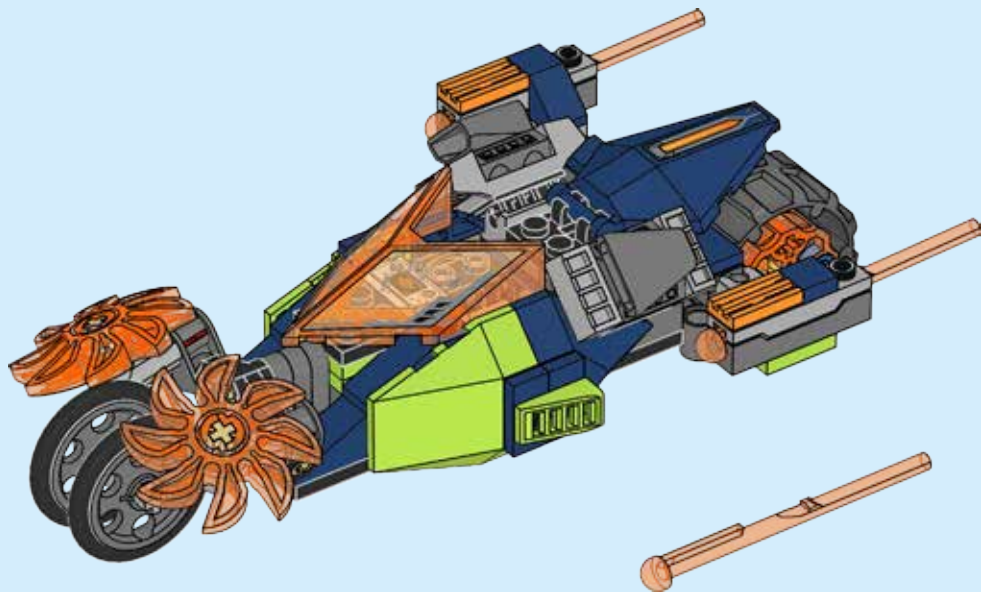

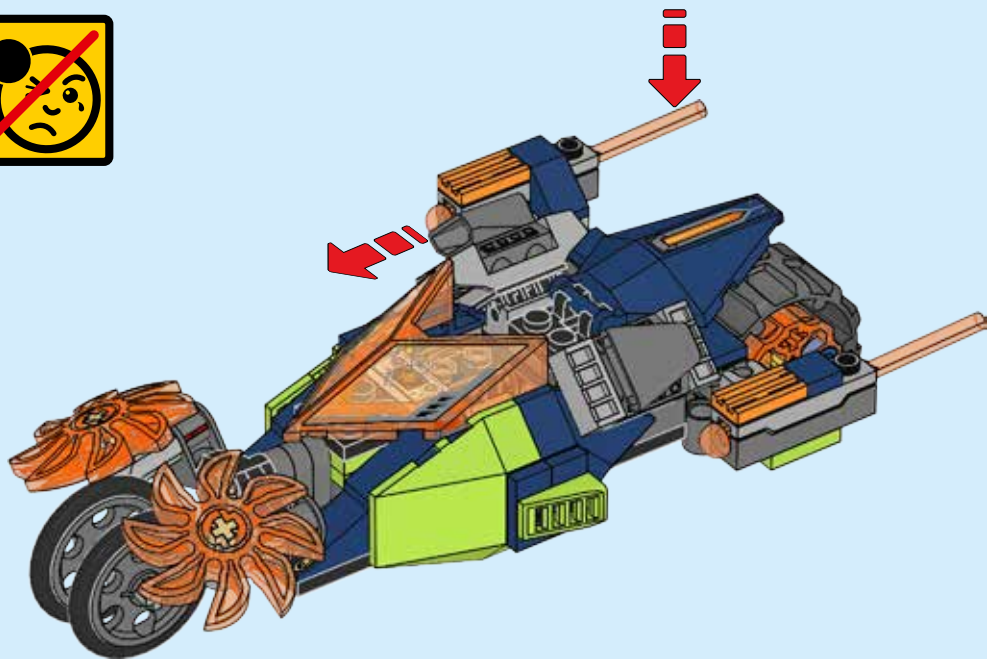











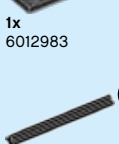























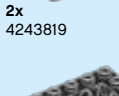

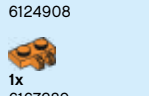







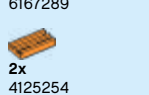





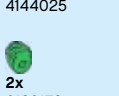







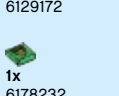

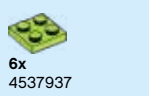



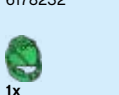

38





 1x 6141652	 1x 4121610	 1x 6012983	 1x 6172935	 2x 6172943	 4x 4541618	 2x 4211151	 3x 6132861
 5x 4666579	 1x 6143953	 1x 370626	 1x 6172170	 1x 6129592	 1x 6031821	 2x 4216695	 2x 6133818
 1x 6175367	 2x 4598528	 2x 4243819	 12x 4163917	 3x 6124908	 2x 6166857	 1x 4507139	 2x 6133818
 1x 6172938	 5x 6016172	 1x 4144025	 10x 6073445	 1x 6167289	 4x 6092588	 1x 6169917	 1x 6169917
 4x 4142865	 2x 4124096	 2x 6129172	 1x 6100096	 2x 4125254	 4x 6103774	 1x 6164381	 1x 6164381
 1x 4513987	 2x 6007966	 2x 6178232	 2x 6166891	 2x 4540385	 2x 6129858	 2x 6044725	 1x 6164381
 2x 4514553	 1x 6007966	 2x 6129172	 2x 4153989	 6x 4537937	 1x 4667595	 1x 4243838	 1x 4211412
 1x 6164527	 1x 6164527	 1x 6178232	 1x 6161315	 2x 4540385	 1x 4252437	 8x 4567509	 2x 4542590
 1x 6164649	 2x 6028041	 1x 6127159	 2x 6124679	 2x 6172945	 1x 6166852	 1x 6172940	 5x 4211550



1x  
6129994



1x  
4211807



1x  
6097090



6x  
6043656



2x  
4211469



3x  
4211398



2x  
4585429



2x  
4654580



2x  
4211632



5x  
4211397



1x  
4211387



2x  
4211436



2x  
4211815



2x  
4211429



2x  
6170521



2x  
4211748



1x  
4211517

3



1x  
6124875



1x  
6130008



2x  
6048898



5x  
4210633



1x  
6051334



1x  
6071226



3x  
4210980



1x  
4211010



2x  
4632574



2x  
4210851

5



1x  
4210892



2x  
4210671



1x  
4211088



1x  
6019987



1x  
4221745



4x  
6039479



1x  
6168776



1x  
4211063



1x  
6178919



2x  
6123814



2x  
4587275



1x  
6013082



2x  
4502068



2x  
4211054



1x  
4520307



4x  
6039482



4x  
6039482



1x  
4211106



2x  
4211024



1x  
4211001



1x  
4211065



2x  
6055063



2x  
6079036



1x  
4211056



1x  
4568951



1x  
6139234



2x  
6139234



1x  
6178327



1x  
6178239



1x  
6129534



1x  
6131790



1x  
6170534



2x  
6125856



1x  
6122170



2x  
6006425



2x  
6006425



Customer Service

Kundenservice

Service Consommateurs

Servicio Al Consumidor

LEGO.com/service or dial



00800 5346 5555 :

1-800-422-5346 :





70364

1



70358

2



70364 + 70358

3

COMBINE  
YOUR POWERS  
COMBINE  
TES POUVOIRS  
COMBINA  
TUS PODERES







70362



70353



70154



70365



70356



70348



70351



DISCOVER MORE  
COMBINATIONS  
DÉCOUVRE PLUS DE  
COMBINAISONS  
DESCUBRE MÁS  
COMBINACIONES



[LEGO.COM/COMBONATOR](http://LEGO.COM/COMBONATOR)



# NEXO KNIGHTS™



LEGO® NEXO KNIGHTS™: MERLOK 2.0



1



2



3

[LEGO.COM/DEVICECHECK](http://LEGO.COM/DEVICECHECK)



# NEXO KNIGHTS



COMBINE TES  
POUVOIRS

COMBINA TUS  
PODERES

COMBINE YOUR  
POWERS



70362



70363



70364



70365



70366



70372





- ❖ SINGLE NEXO POWER
- ❖ POUVOIR NEXO UNIQUE
- ❖ PODER NEXO SENCILLO



- ❖ COMBO NEXO POWERS
- ❖ COMBO DE POUVOIRS NEXO
- ❖ PODERES NEXO COMBINADOS

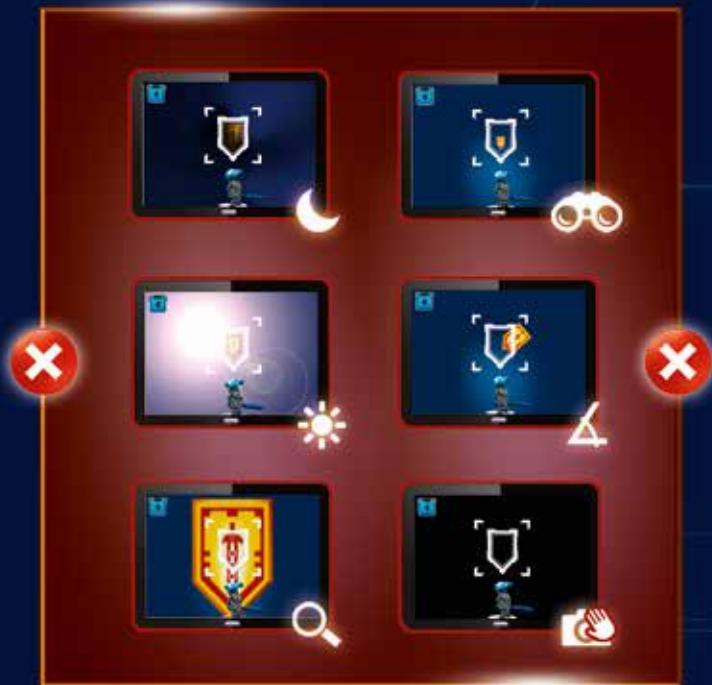



# NEXO KNIGHTS™



**DOWNLOAD THE FREE APP:**  
**TÉLÉCHARGE L'APPLI GRATUITE :**  
**DESCARGA LA APP GRATIS:**

**LEGO® NEXO KNIGHTS™: MERLOK 2.0**  
[LEGO.com/devicecheck](http://LEGO.com/devicecheck)

All materials might not be available in all markets.  
Certains matériels peuvent ne pas être disponibles dans certains marchés.  
Ciertos materiales podrían no estar disponibles en todos los mercados.

[LEGO.COM/NEXOKNIGHTS](http://LEGO.COM/NEXOKNIGHTS)



# NEXO KNIGHTS



70352



70351



70350



70349



70348



70347



70362



70363



70364



70365



70366



70372



# WIN

GO TO [WWW.LEGO.COM/PRODUCTFEEDBACK](http://WWW.LEGO.COM/PRODUCTFEEDBACK) AND  
GIVE US YOUR SHORT **FEEDBACK** ABOUT THIS  
LEGO® SET FOR A CHANCE TO WIN  
A COOL LEGO PRIZE.

Terms & Conditions apply

## LEGO.com/productfeedback



### GEWINNE



Erzähle uns auf  
[www.LEGO.com/productfeedback](http://www.LEGO.com/productfeedback)

etwas über die Erfahrungen, die du mit  
diesem LEGO® Set gemacht hast, und  
sichere dir die Chance auf einen coolen  
LEGO Preis!

Es gelten die Teilnahmebedingungen

### GAGNE



Rends-toi sur  
[www.LEGO.com/productfeedback](http://www.LEGO.com/productfeedback)

et donne-nous quelques commentaires sur  
ce produit LEGO® pour avoir une chance  
de gagner un prix LEGO !

Voir Conditions Générales

### GANAN



Visita  
[www.LEGO.com/productfeedback](http://www.LEGO.com/productfeedback)

y envíanos tu opinión acerca de este set  
LEGO®. ¡Participarás en el sorteo de un  
premio LEGO!

Términos y Condiciones aplicables

### 获取奖品



登录  
[www.LEGO.com/productfeedback](http://www.LEGO.com/productfeedback)

给出关于此乐高®套装的简短反馈，  
就有机会获得炫酷乐高奖品

《条款及条件》适用

LEGO, the LEGO logo, NEXO KNIGHTS and the NEXO KNIGHTS logo are trademarks of the/son des marques de commerce du/son marcas registradas de LEGO Group.  
©2017 The LEGO Group.

6188124