

**WIN**  
 GO TO [WWW.LEGO.COM/PRODUCTFEEDBACK](http://WWW.LEGO.COM/PRODUCTFEEDBACK)  
 AND GIVE US YOUR SHORT FEEDBACK  
 ABOUT THIS LEGO® SET FOR A CHANCE  
 TO WIN A COOL LEGO PRIZE.

Terms & Conditions apply  
[LEGO.com/productfeedback](http://LEGO.com/productfeedback)



**GEWINNE**

Etabliše uns auf [www.LEGO.com/productfeedback](http://www.LEGO.com/productfeedback) etwas über die Erfahrungen, die du mit diesem LEGO® Set gemacht hast, und sichere dir die Chance auf einen coolen LEGO Preis!

Es gelten die Teilnahmebedingungen!

**GAGNE**

Rends-t'as sur [www.LEGO.com/productfeedback](http://www.LEGO.com/productfeedback) et donne-nous quelques commentaires sur ce produit LEGO® pour avoir une chance de gagner un prix LEGO!

Voir Conditions Générales

**GANÀ**

Visita [www.LEGO.com/productfeedback](http://www.LEGO.com/productfeedback) y exprésanos tu opinión acerca de este set LEGO®, para participar en el sorteo de un premio LEGO!

Términos y Condiciones aplicables

**获取奖品**

请登录 [www.LEGO.com/productfeedback](http://www.LEGO.com/productfeedback) 给出关于此乐高®套装的简短反馈, 就有机会获得炫酷乐高奖品!

《条款及条件》适用

**경품 당첨 기회**

[www.LEGO.com/productfeedback](http://www.LEGO.com/productfeedback) 페이지로 이동하여 이 레고® 세트에 대한 간단한 피드백을 보내 주시고 멋진 레고 경품을 탈 수 있는 기회도 잡으십시오!

약관 적용

**ЗАПОЛНИ АНКЕТУ И ПОЛУЧИ ПРИЗ**

Перейди по ссылке [www.LEGO.com/productfeedback](http://www.LEGO.com/productfeedback) ответь всего на несколько вопросов об этом наборе LEGO®, и у тебя появится шанс выиграть замечательный приз от компании LEGO!

Применяются Условия и правила участия

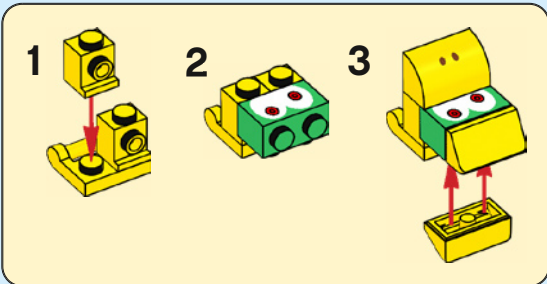

1. Yellow 1x2 Technic brick with 2 holes is placed on a yellow 1x2 Technic brick with 2 holes.

2. Green 1x2 Technic brick with 2 holes and 2 studs is placed on top of the yellow brick.

3. Yellow 1x2 Technic brick with 2 holes is placed on top of the green brick.

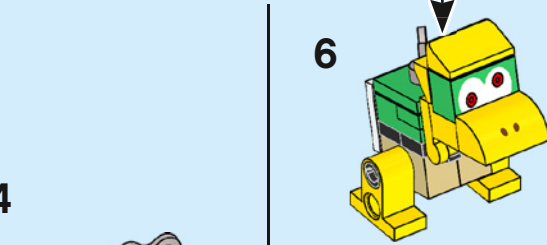

6. The yellow and green component from step 3 is attached to the front of a larger yellow and green assembly.

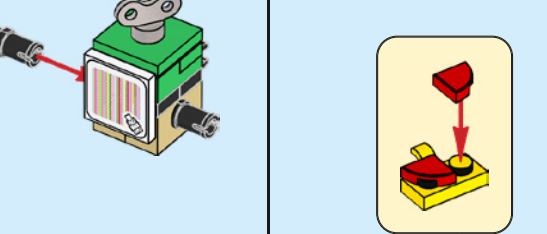

7. A red 1x2 Technic brick with 2 holes is attached to the yellow and green component from step 6.

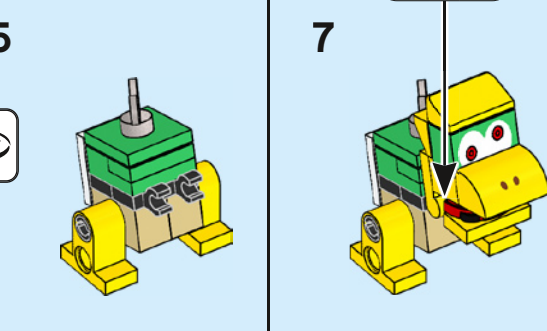

5. A green 1x2 Technic brick with 2 holes and a motor is attached to the yellow and green component from step 7.

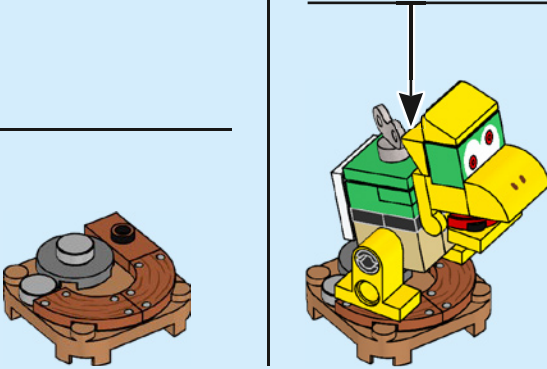

The final assembly is shown being attached to a brown base.



**LEGO**  
**SUPER MARIO**

71402  
 6399129

[LEGO.com/supermario](http://LEGO.com/supermario)

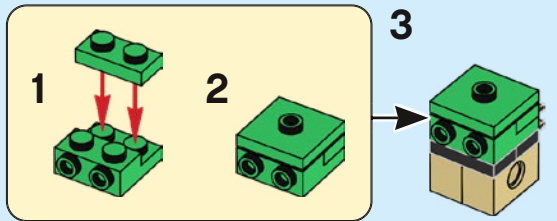

1. Green 1x2 Technic brick with 2 holes is placed on a green 1x2 Technic brick with 2 holes.

2. Green 1x2 Technic brick with 2 holes and 2 studs is placed on top of the green brick.

3. The green component from step 2 is attached to a brown base.

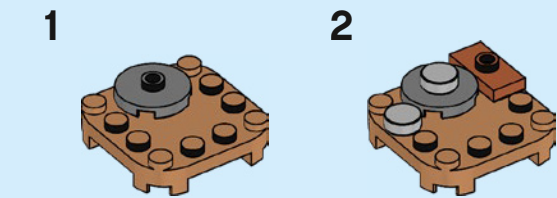

1. Brown 1x2 Technic brick with 2 holes is placed on a brown 1x2 Technic brick with 2 holes.

2. Brown 1x2 Technic brick with 2 holes and 2 studs is placed on top of the brown brick.

3. The brown component from step 2 is attached to a brown base.

71360 OR/OU/O 71387

Starter Course 71360 or 71387 needed

Niveau de départ 71360 ou 71387 nécessaire

Se necesitan los sets Recorrido Inicial 71360 o 71387



71402



Get the latest version of the app!  
Téléchargez la dernière version de l'appli !  
¡Descarga la versión más reciente de la app!

Check for compatibility  
Vérifier la compatibilité  
Comprueba tu compatibilidad  
[LEGO.com/devicecheck](https://LEGO.com/devicecheck)



LEGO® Super Mario™



Freeze  
Congelo  
Tempanito



Mechakoopa  
Méca-Koopa  
Mecakoopa



Ant Trooper  
Fourmilli  
Hormigoide



Goombrat  
Goombalissou  
Goombiño



Scaresly Rat  
Souriboo  
Ratacante



Bully  
Voyou  
Peleón



baby penguin  
petit pingouin  
pingüinito



Stingby  
Buttine  
Abejorro



CoIn Coffe  
Crapognon  
Monerrana



Para-Biddybud  
Paracoccinelly  
Catina Alada

[LEGO.com/service](https://LEGO.com/service)  
LEGO, the LEGO logo and the Brick and Knob configurations are trademarks of the /ont des marques de commerce du/son marcas registradas de LEGO Group. ©2022 The LEGO Group. All rights reserved./Tous droits réservés/ Todos los derechos reservados.

6399129

TM & © 2022 Nintendo.