



# NINJAGO

71759







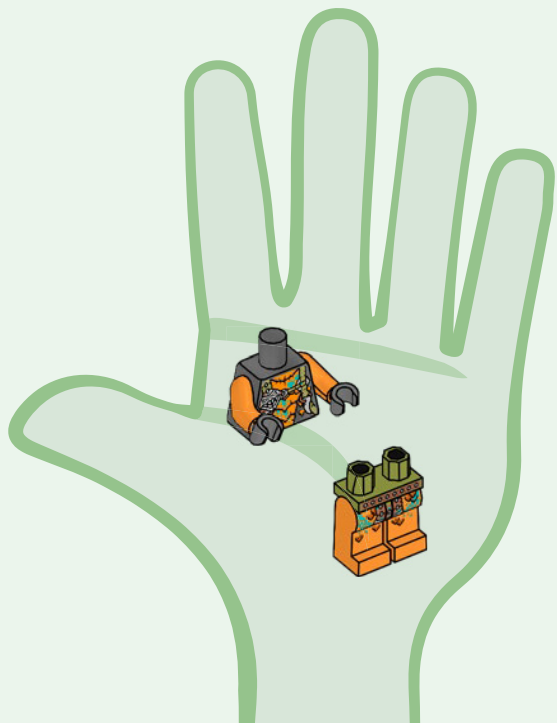

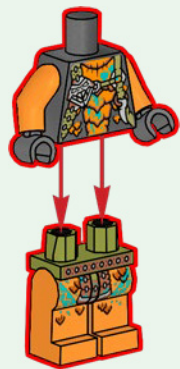

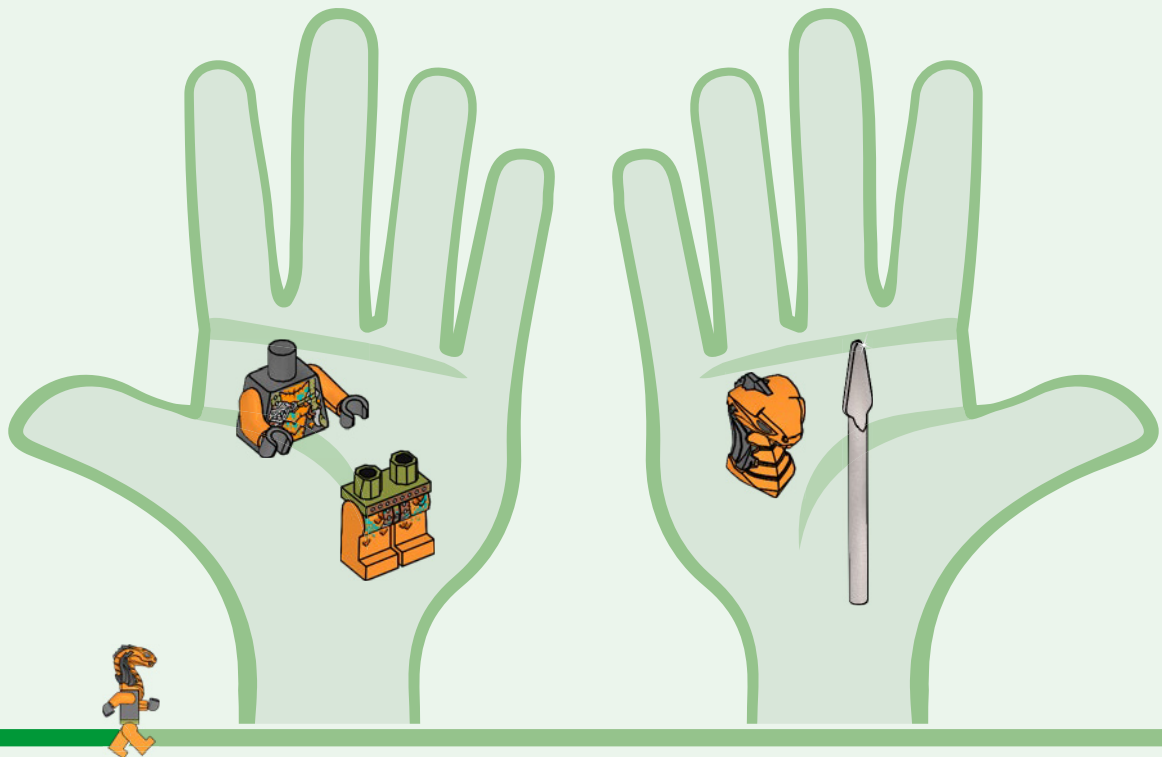

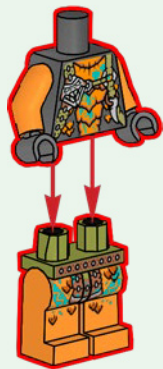

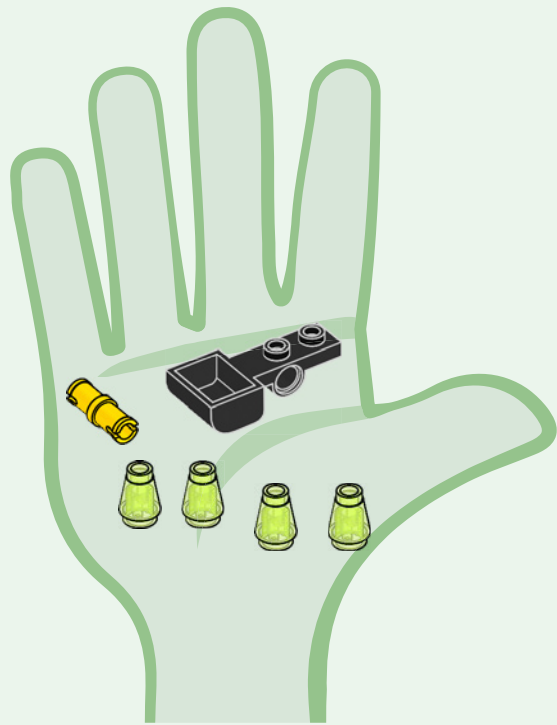
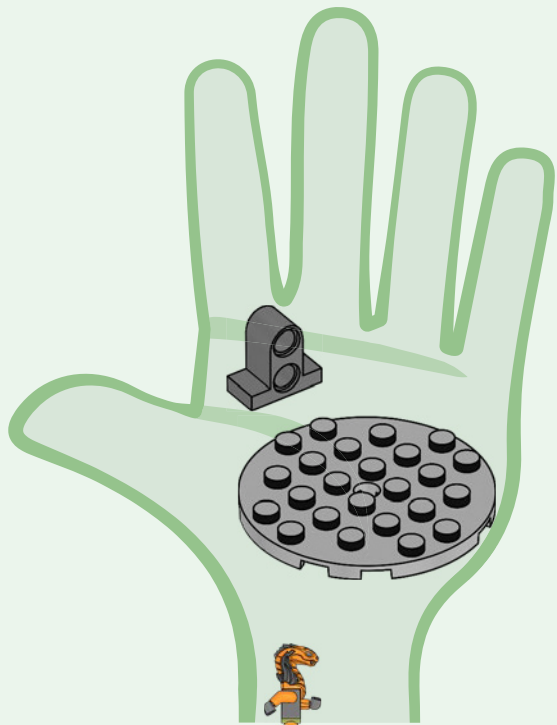



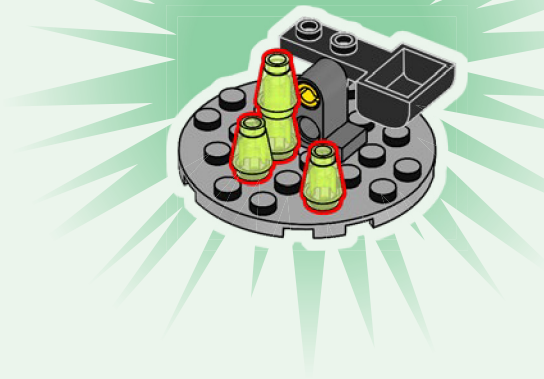
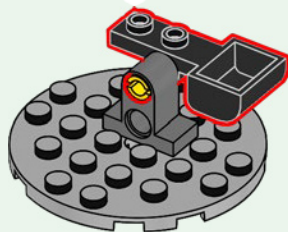
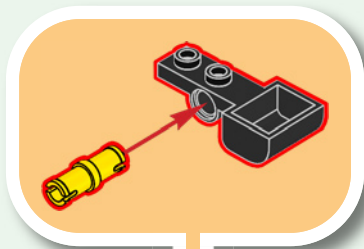
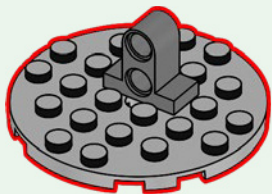





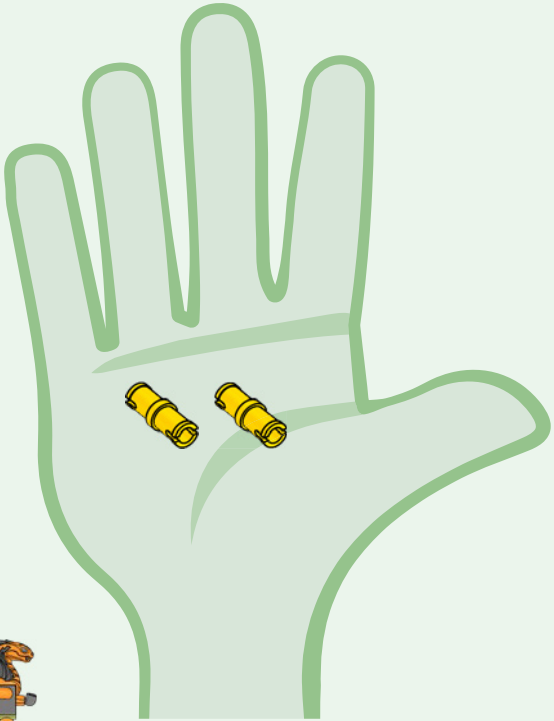
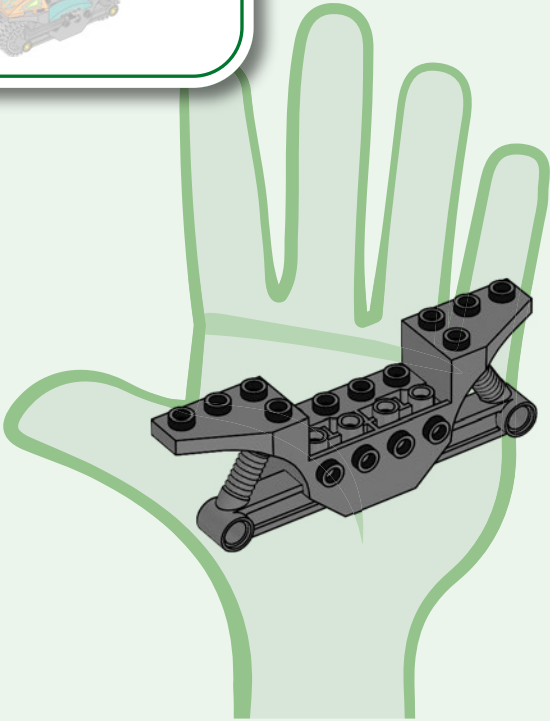
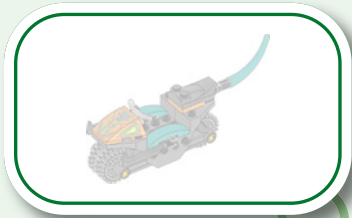

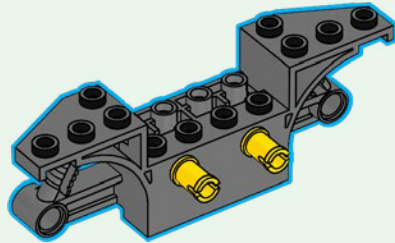

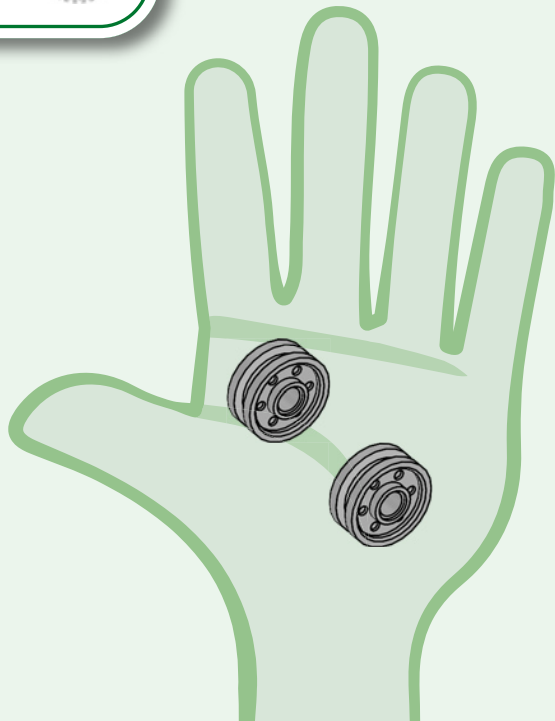
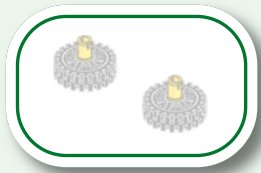

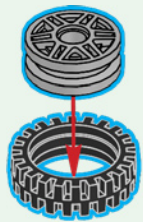

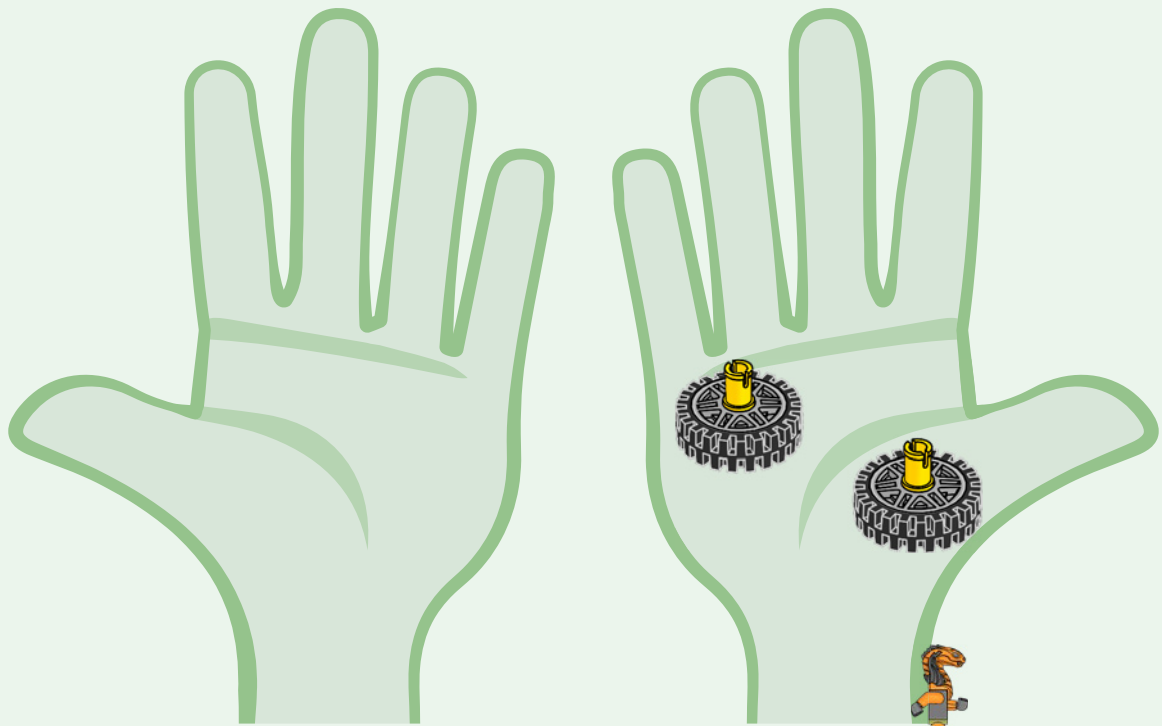



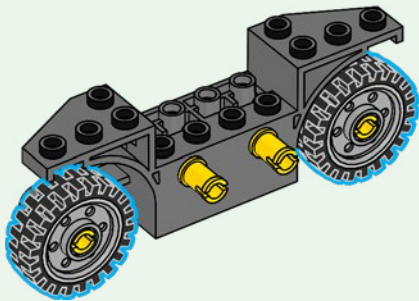

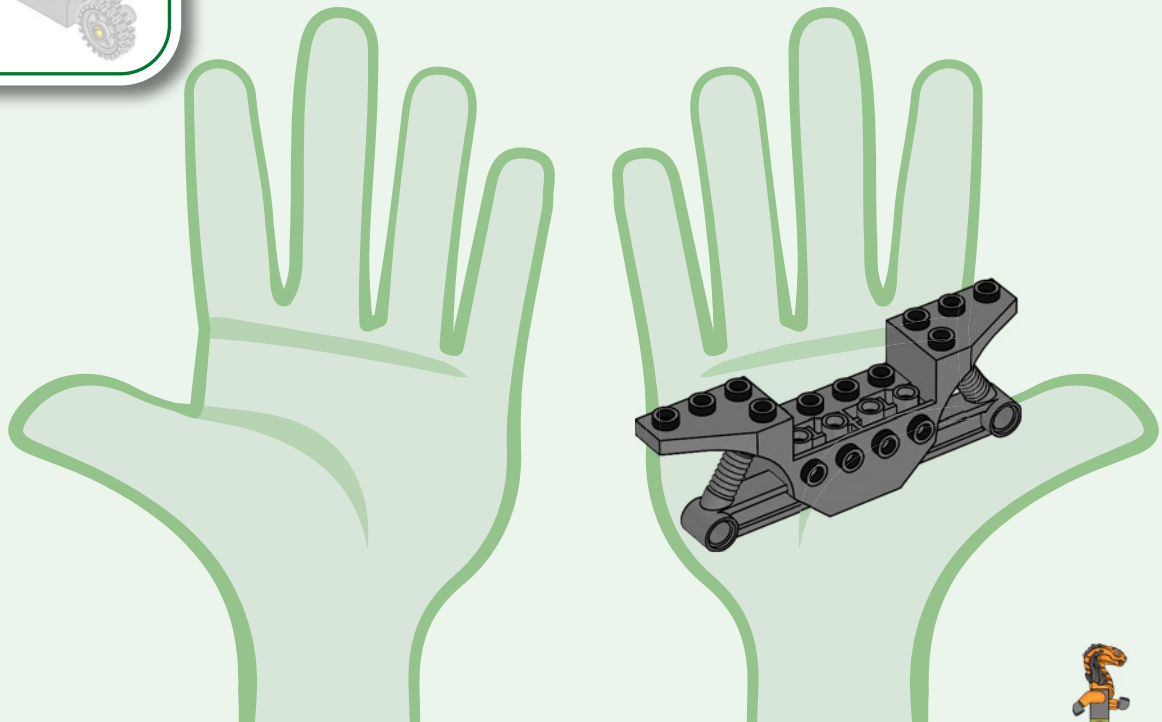
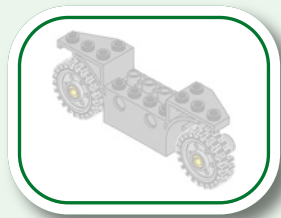

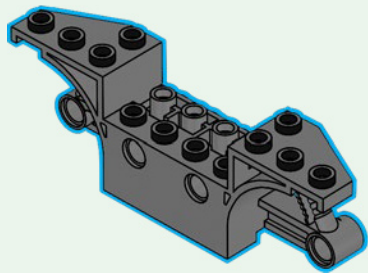

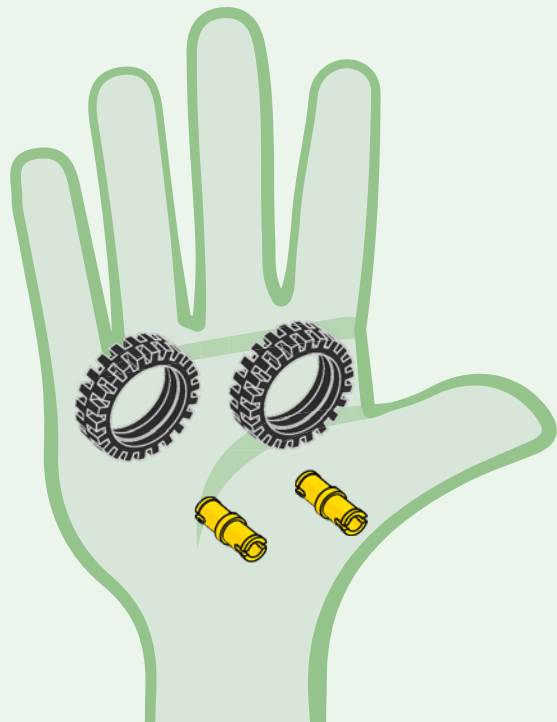
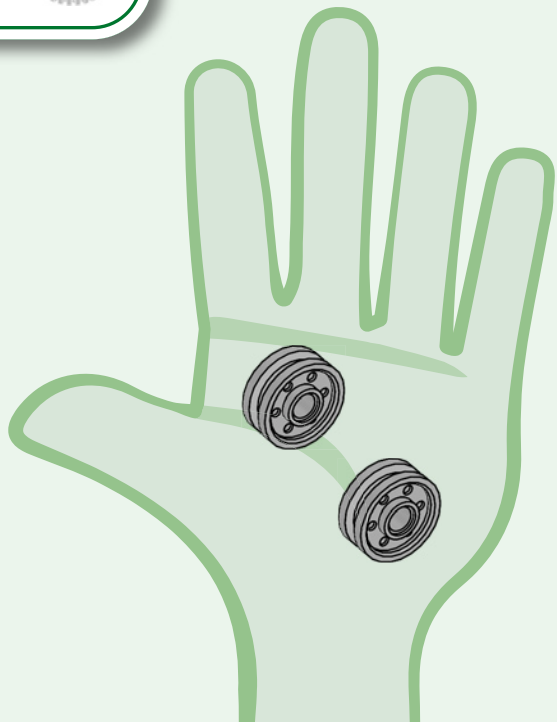

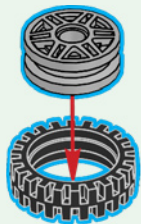

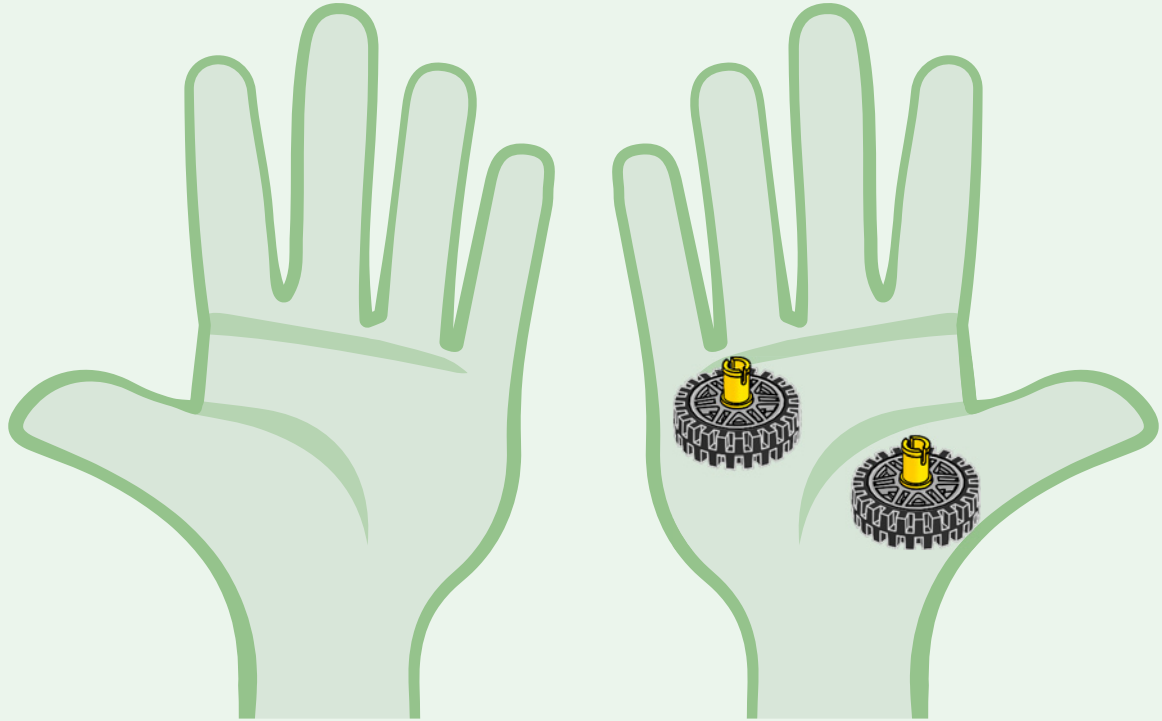

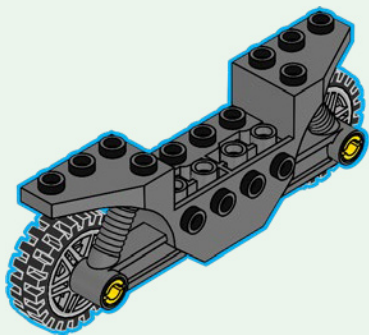

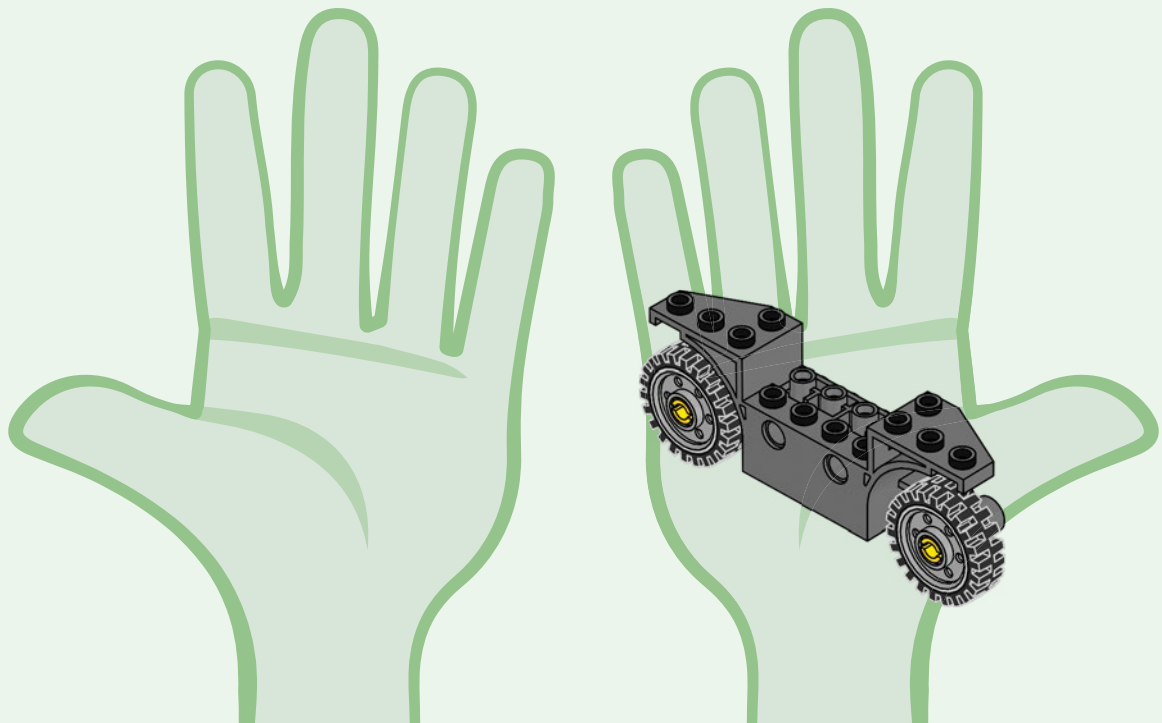



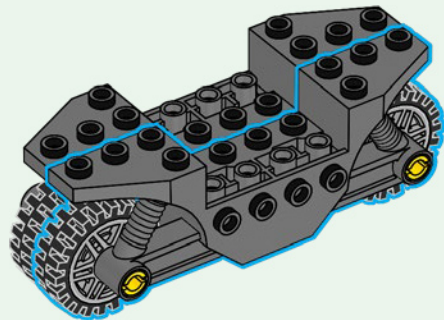

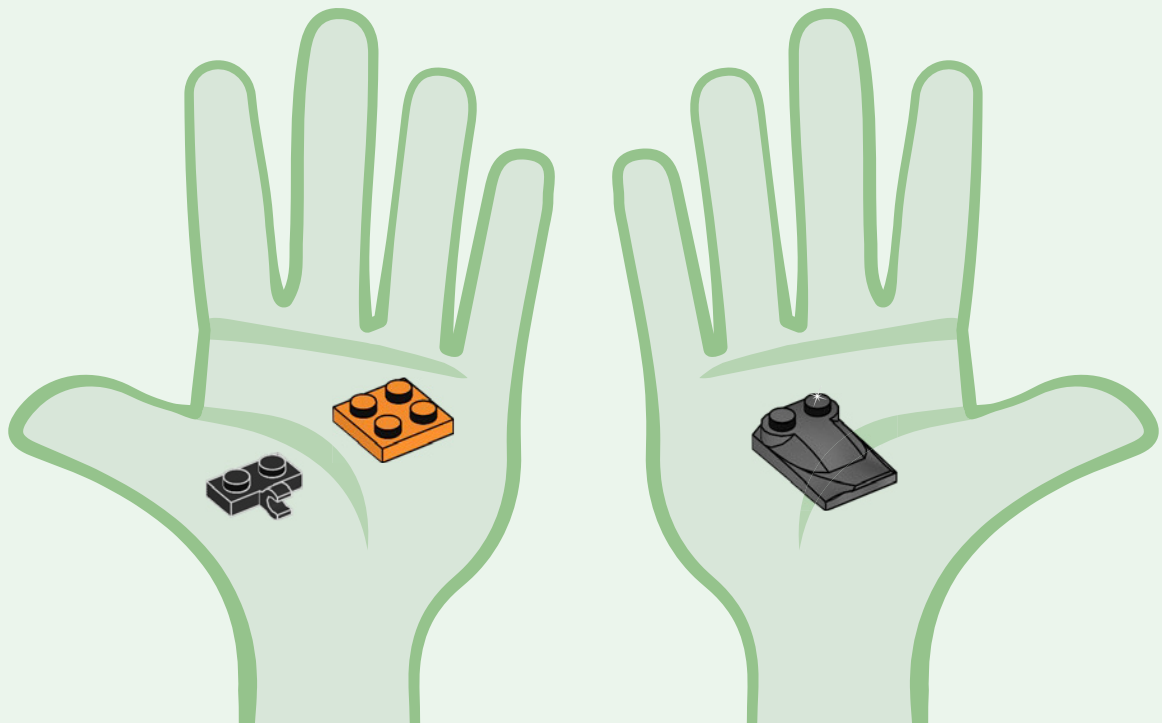

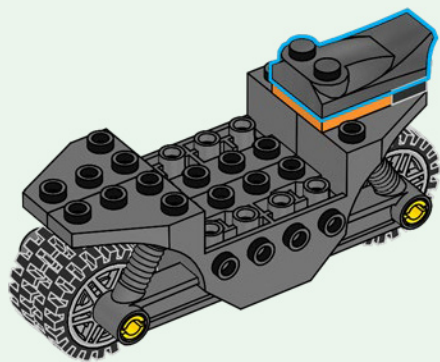
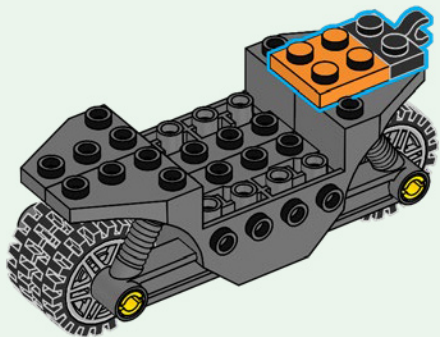

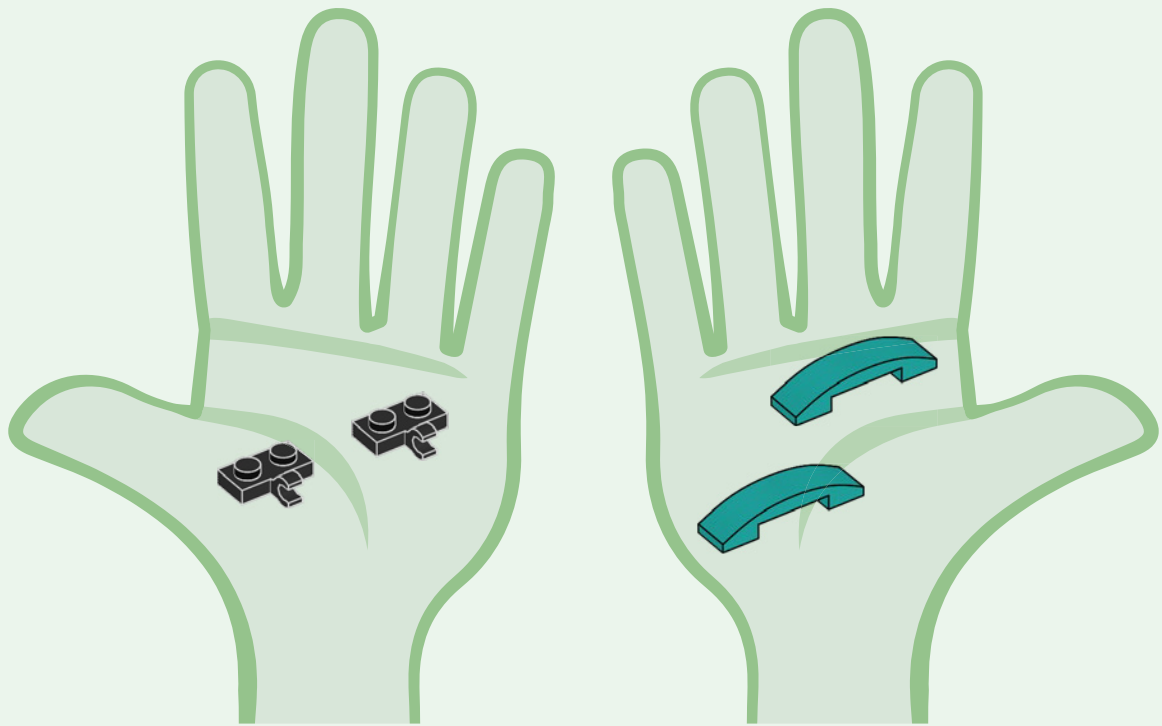

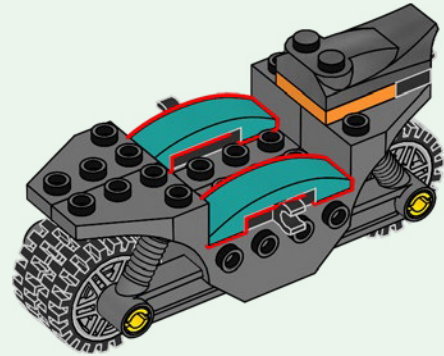
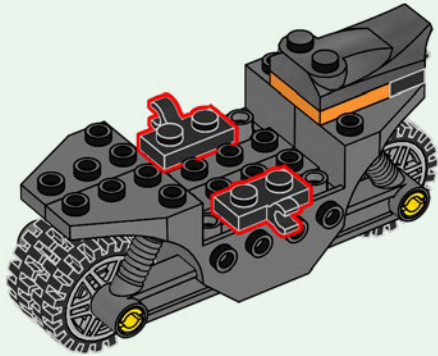

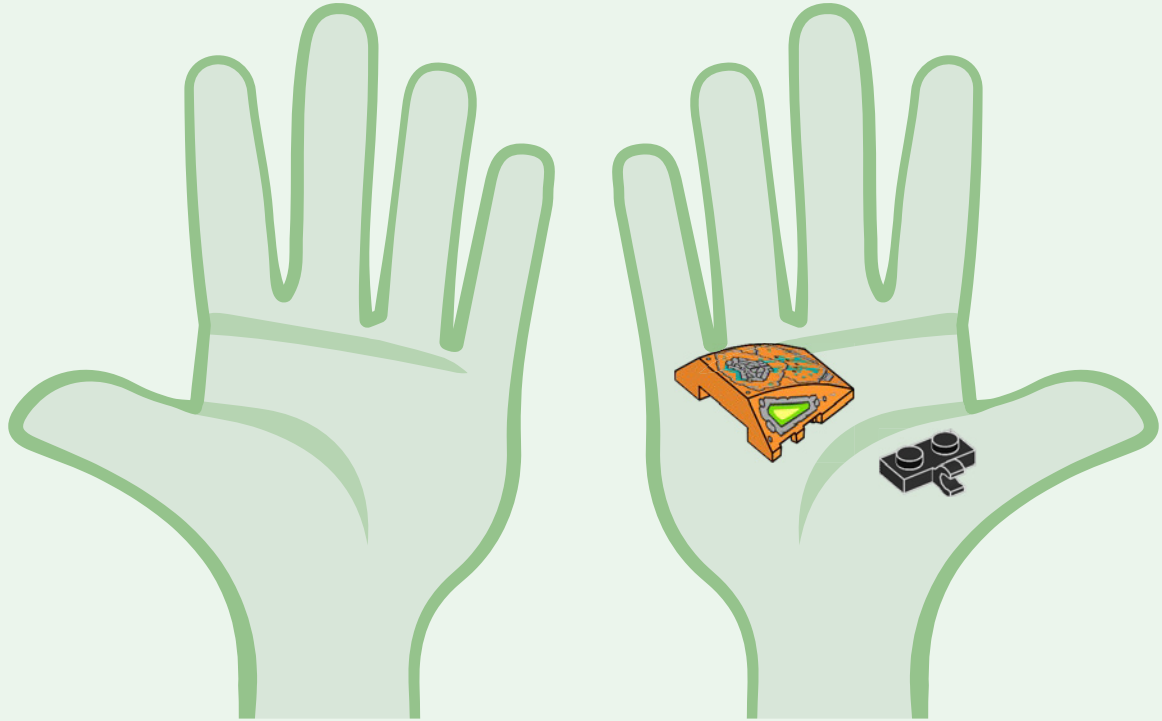

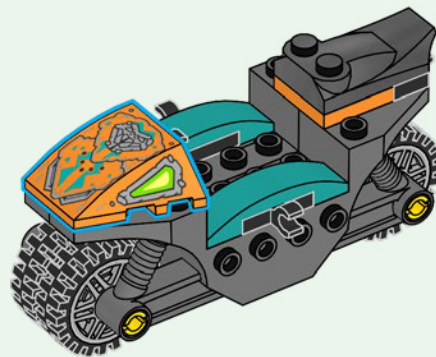
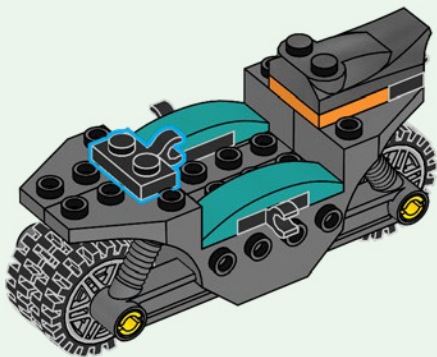

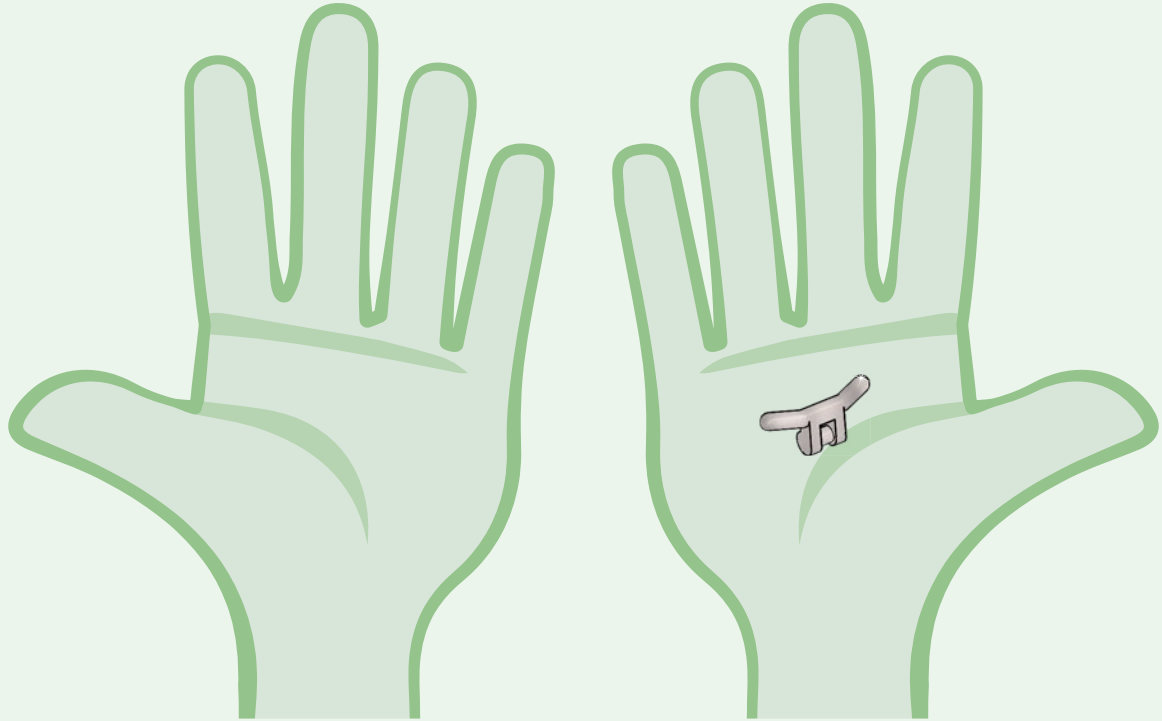



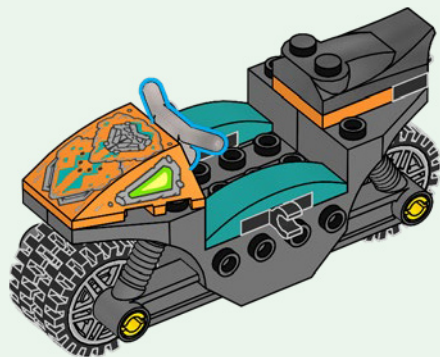

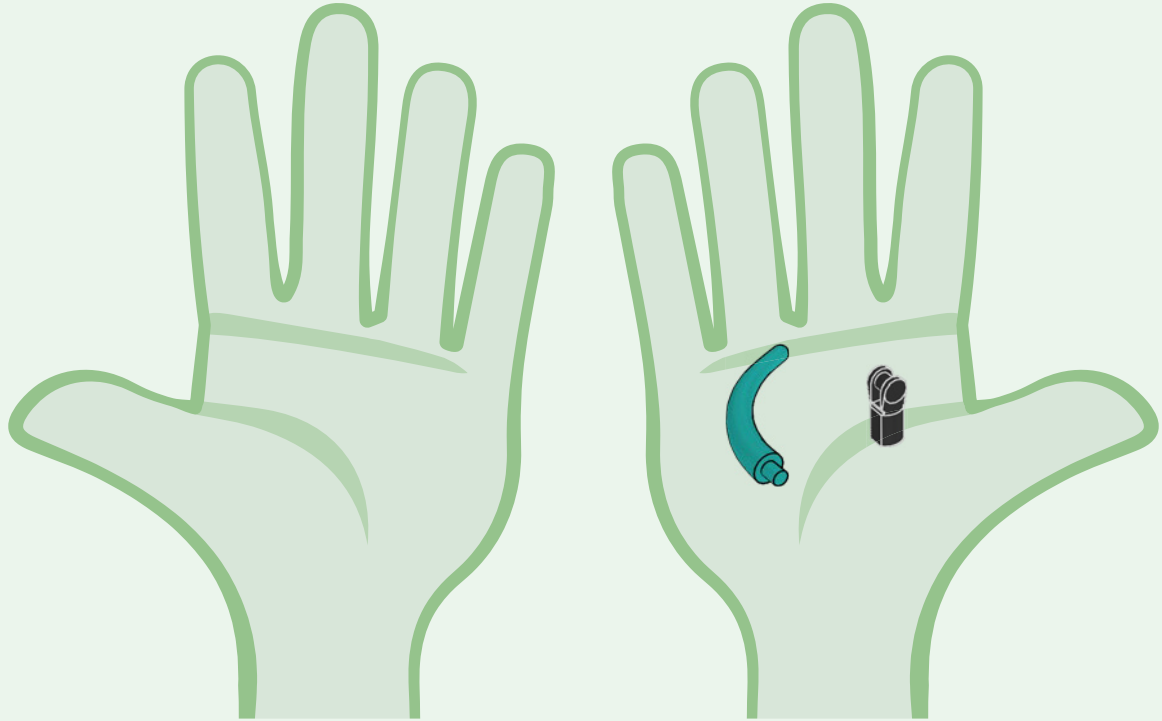

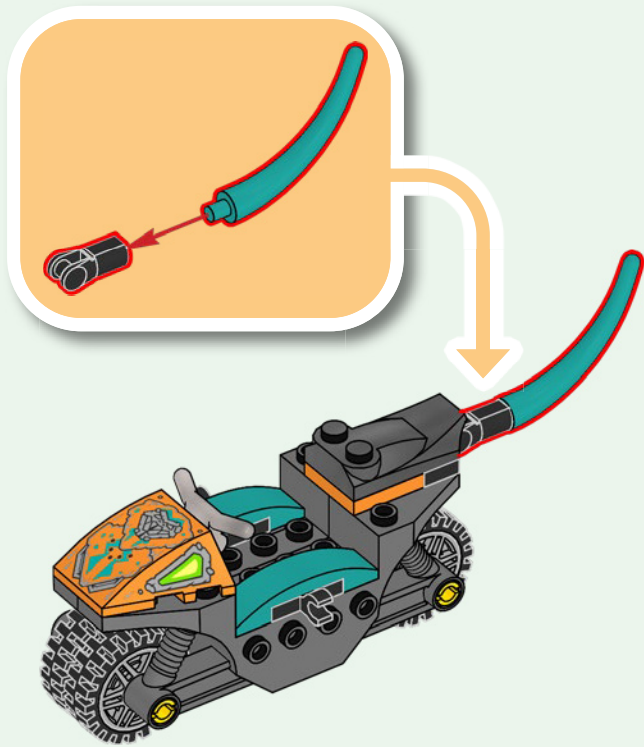

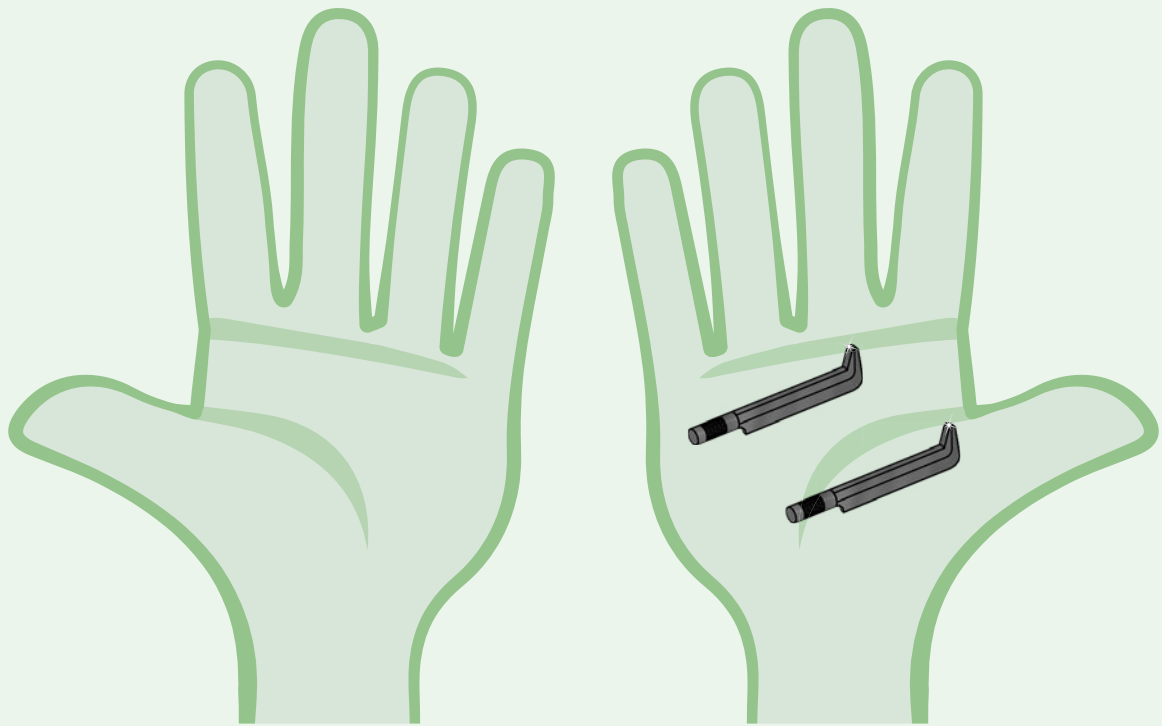

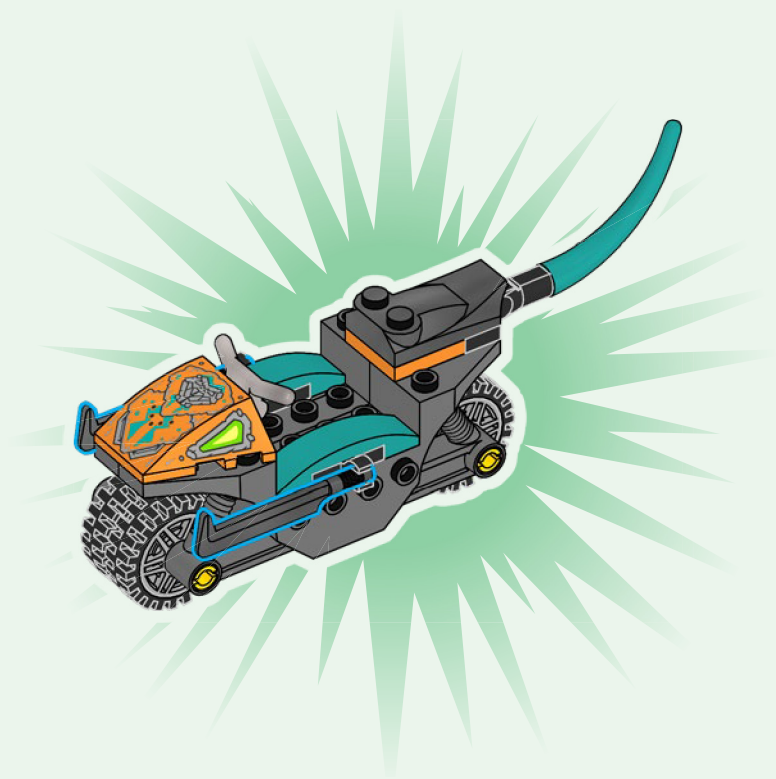

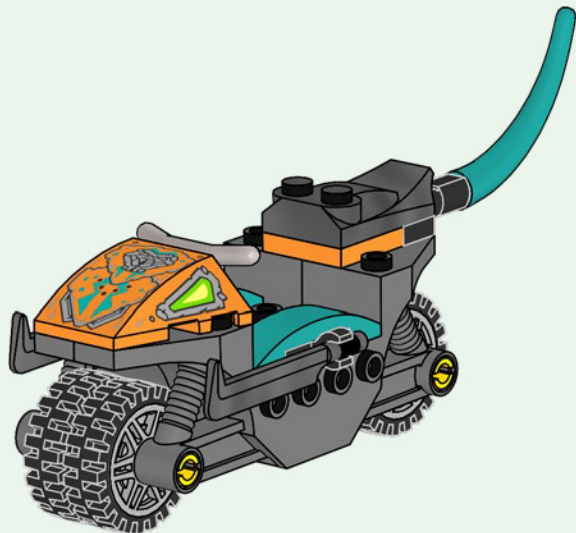





Rebuild  
the  
world™



LEGO, the LEGO logo and NINJAGO are trademarks of the LEGO Group.  
©2022 The LEGO Group. 6415227