



WICKED

75681



LEGO® Builder



Get excited about our new packaging!

We're switching from plastic to paper-based packaging. That's why you might find a mix of paper and plastic in our boxes!

Nos nouveaux emballages vous emballeront !

Nous passons des emballages en plastique aux emballages à base de papier. C'est pourquoi vous pourriez trouver un mélange de papier et de plastique dans nos boîtes !

¡Te presentamos nuestros nuevos empaques!

Estamos sustituyendo las bolsas de plástico por bolsas con base de papel. ¡Por eso, puedes encontrar una mezcla de papel y de plástico en nuestras cajas!

[LEGO.com/sustainable-packaging](https://www.lego.com/sustainable-packaging)

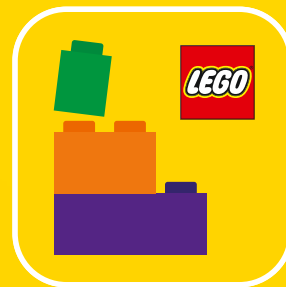

🔍 LEGO® Builder

BUILDER



Apple and the Apple logo are trademarks of Apple Inc., registered in the U.S. and other countries and regions. App Store is a service mark of Apple Inc. Google Play and the Google Play logo are trademarks of Google LLC. Tencent and the Tencent logo are trademarks of Tencent Inc.

🔍 LEGO.com/devicecheck

EN Ask parents' permission before going online | DE Eltern um Erlaubnis bitten, bevor du online gehst | FR Demande l'autorisation d'un parent avant d'aller en ligne | IT Chiedi il permesso ai tuoi genitori prima di andare online | ES Pídeles permiso a tus papás antes de conectarte a Internet | PT Pede autorização aos pais antes de acederes online | ZH 上网前应先征得父母的同意 | PL Poproś rodziców o zgodę, zanim wejdiesz do Internetu | CS Než půjdeš na internet, požádej rodiče o svolení | SK Skôr než pôjdeš na internet, vypýtaj si povolenie od rodičov | HU Kérj szülői engedélyt, mielőtt online csatlakoznál! | RO Cere permisiunea părinților înainte de a te conecta online | BG Поискайте разрешение от родител, преди да влезете онлайн | LV Pirms došanās tiešsaistē palūdz atļauju vecākiem | ET Enne Interneti kasutamist küsi vanematelt luba | LT Prieš prisijungdami prie interneto, atsklauskite tėvų

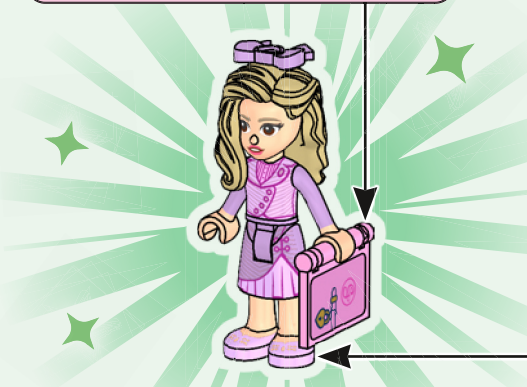
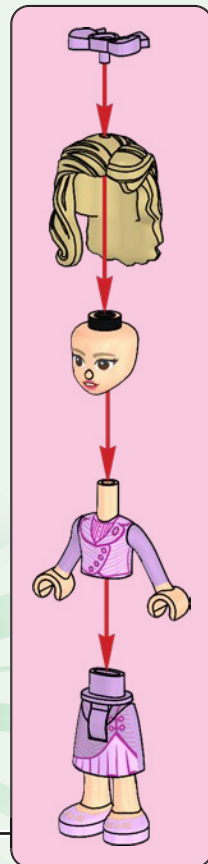
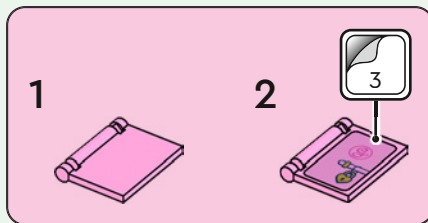
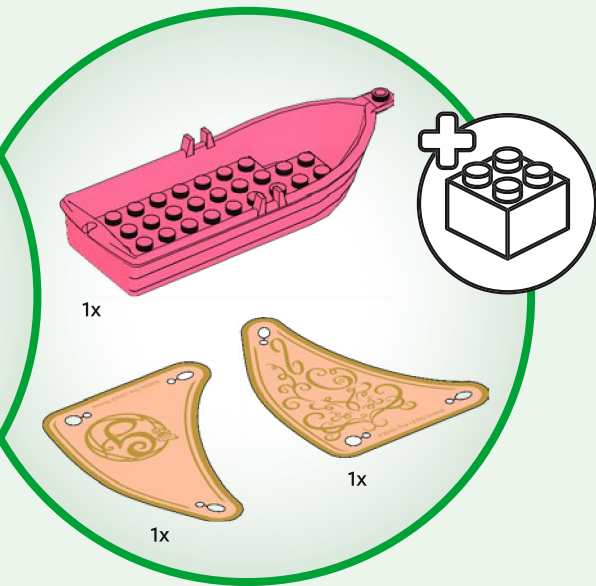

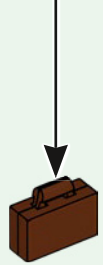
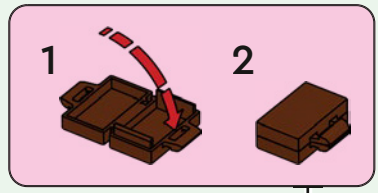
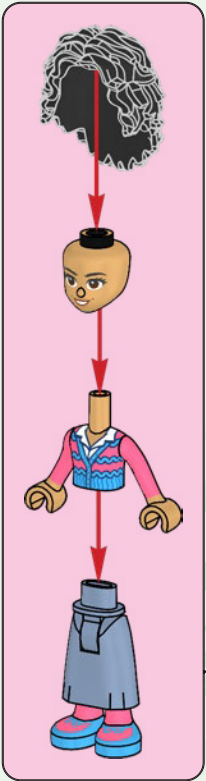
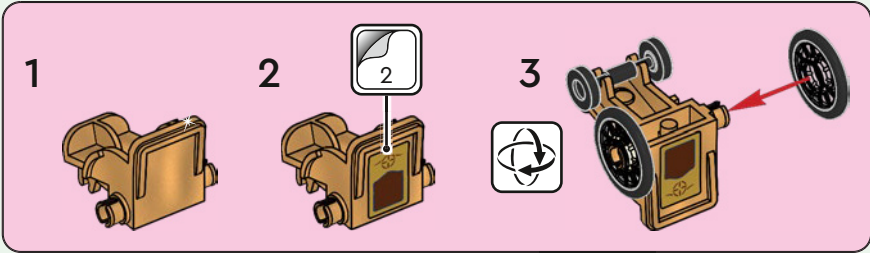

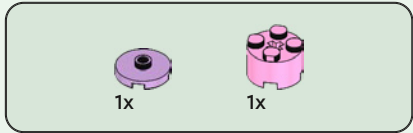
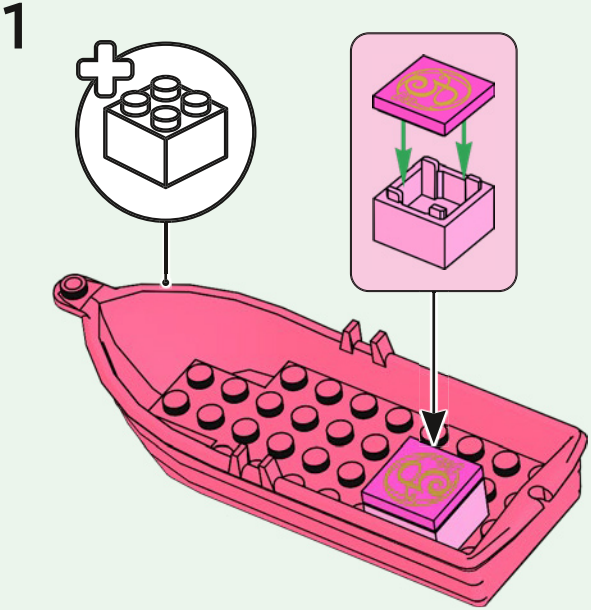
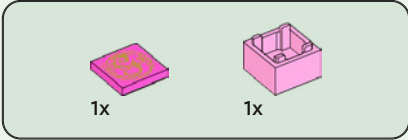
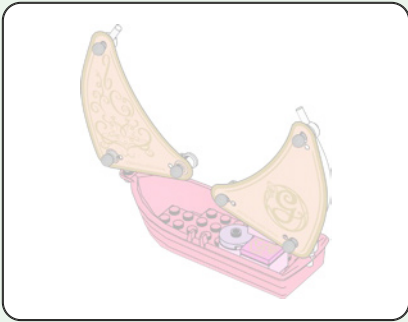

2

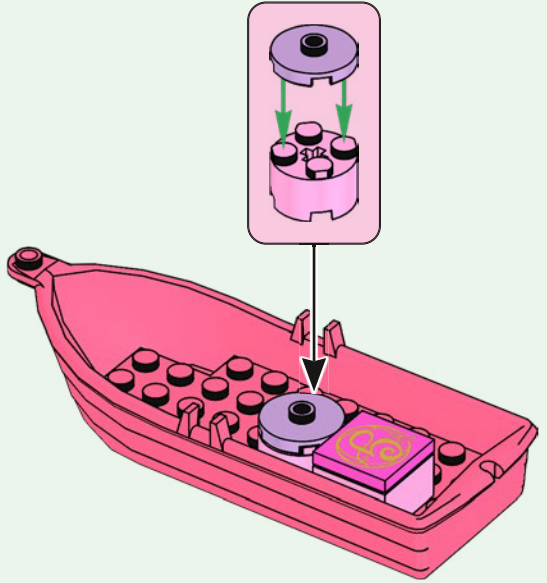

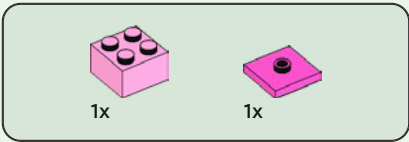

3

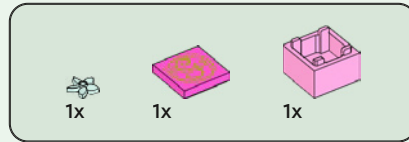
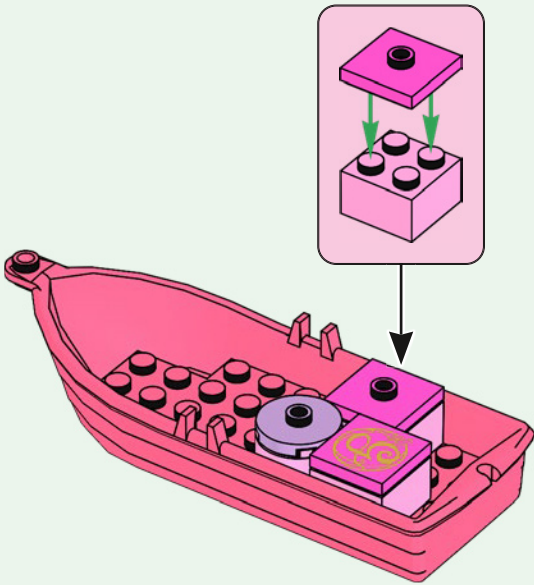

4

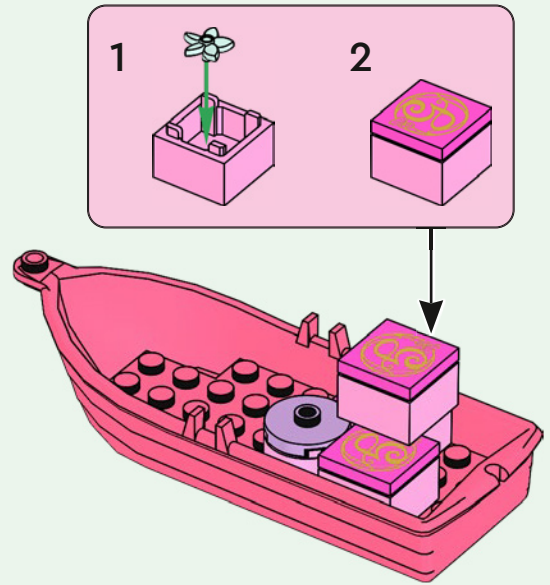

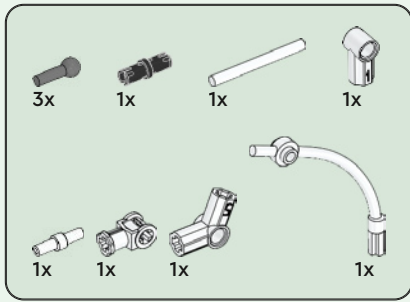

5

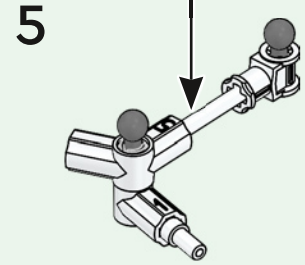
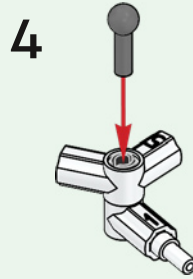
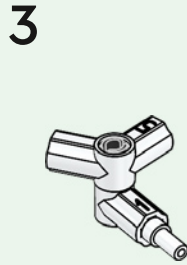
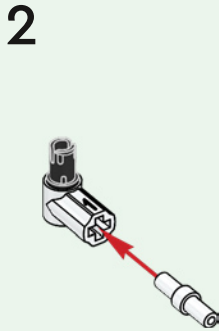
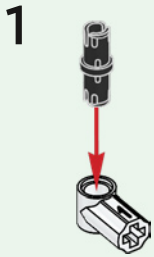
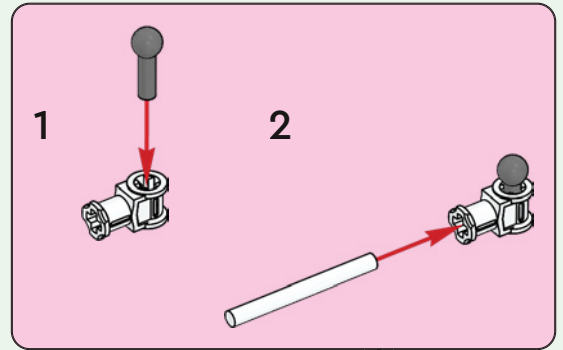

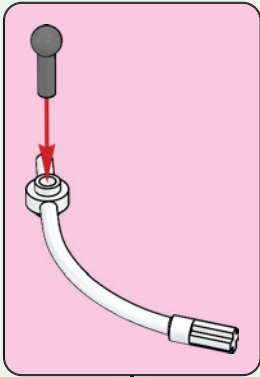

6

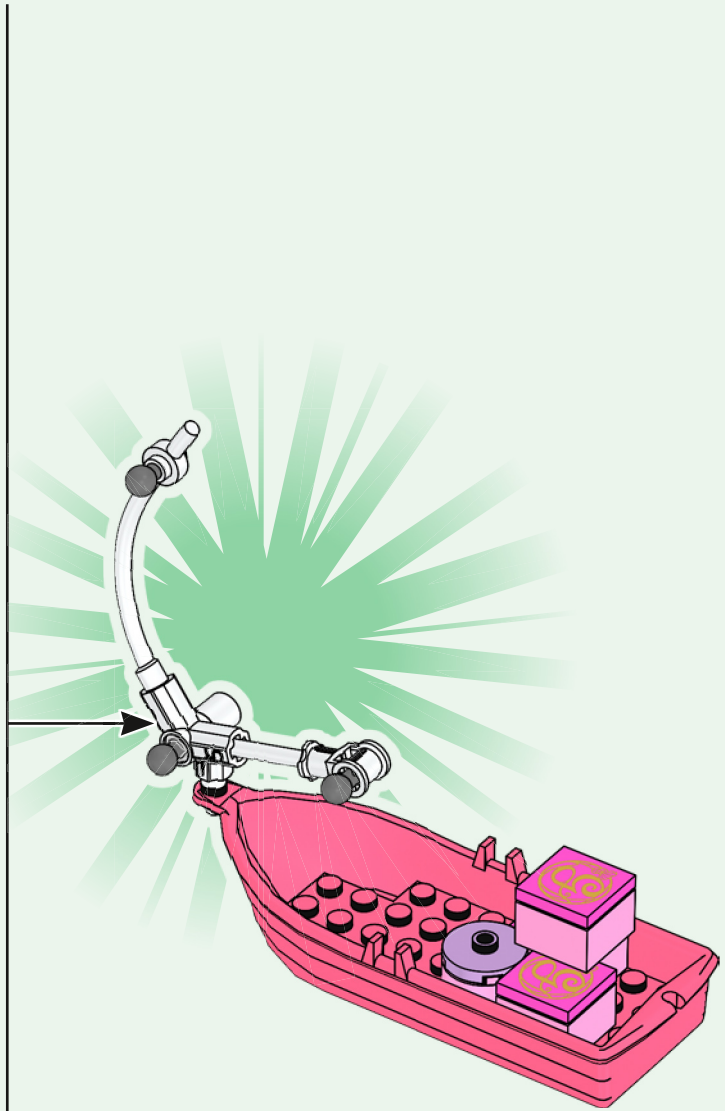
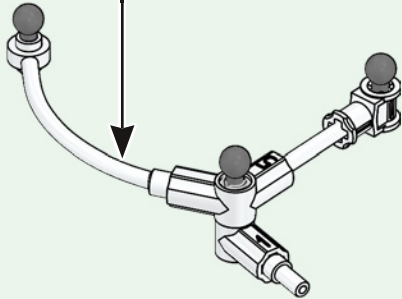

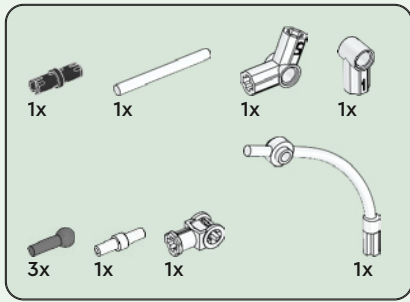

6

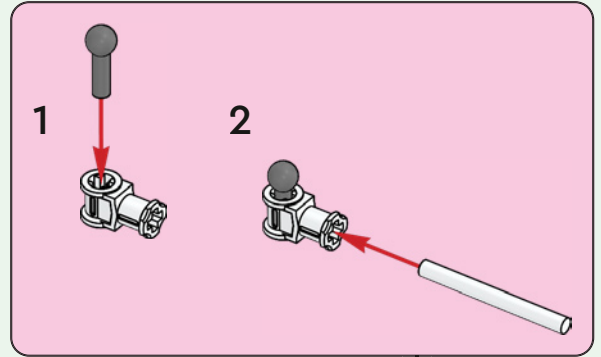

1



2

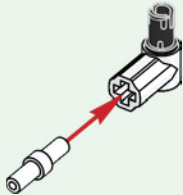

3

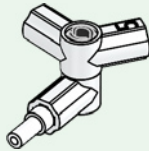

4

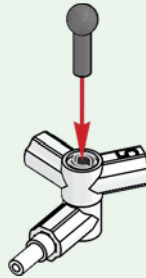

5

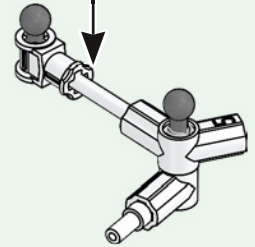

6

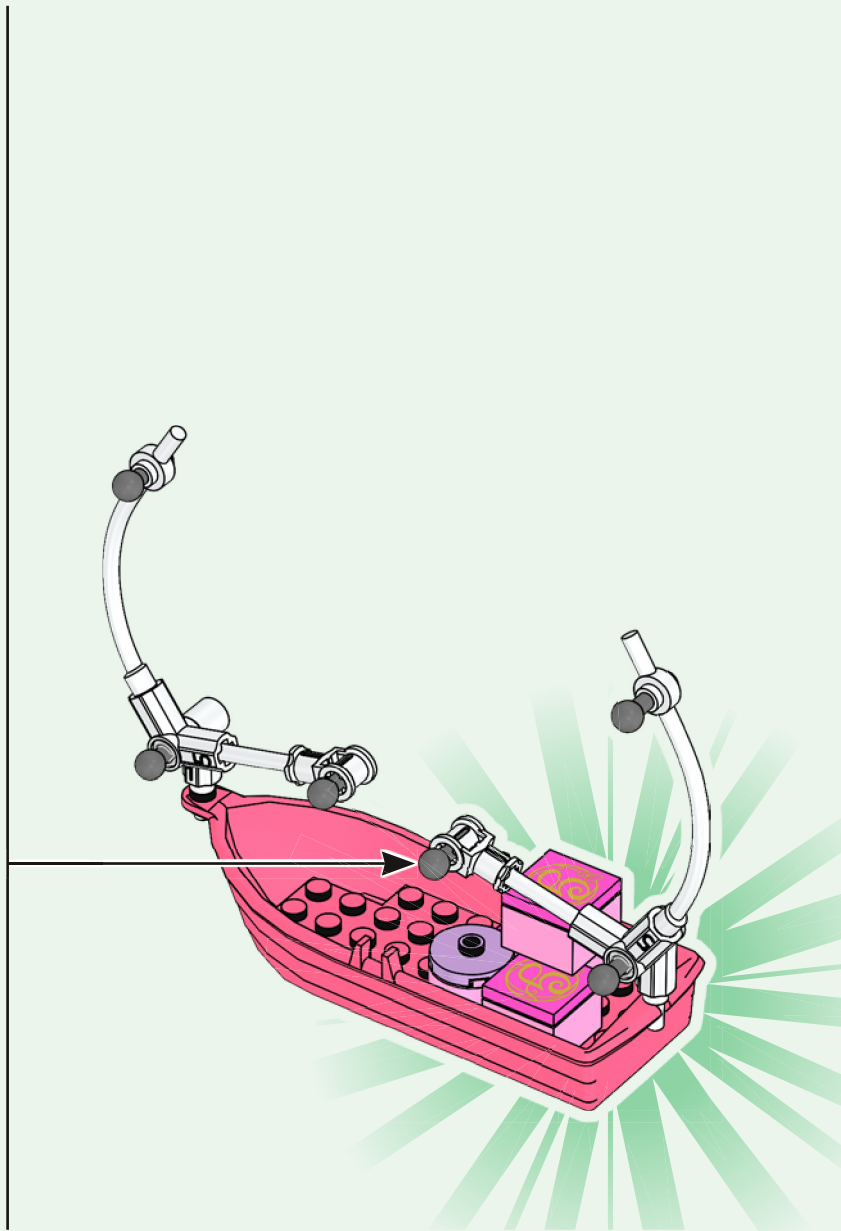
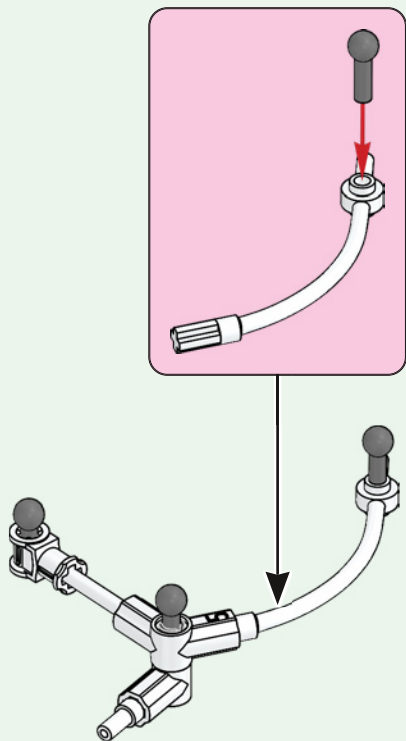

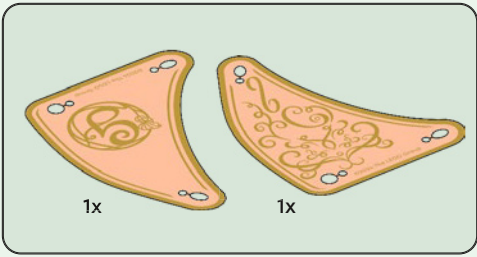

7

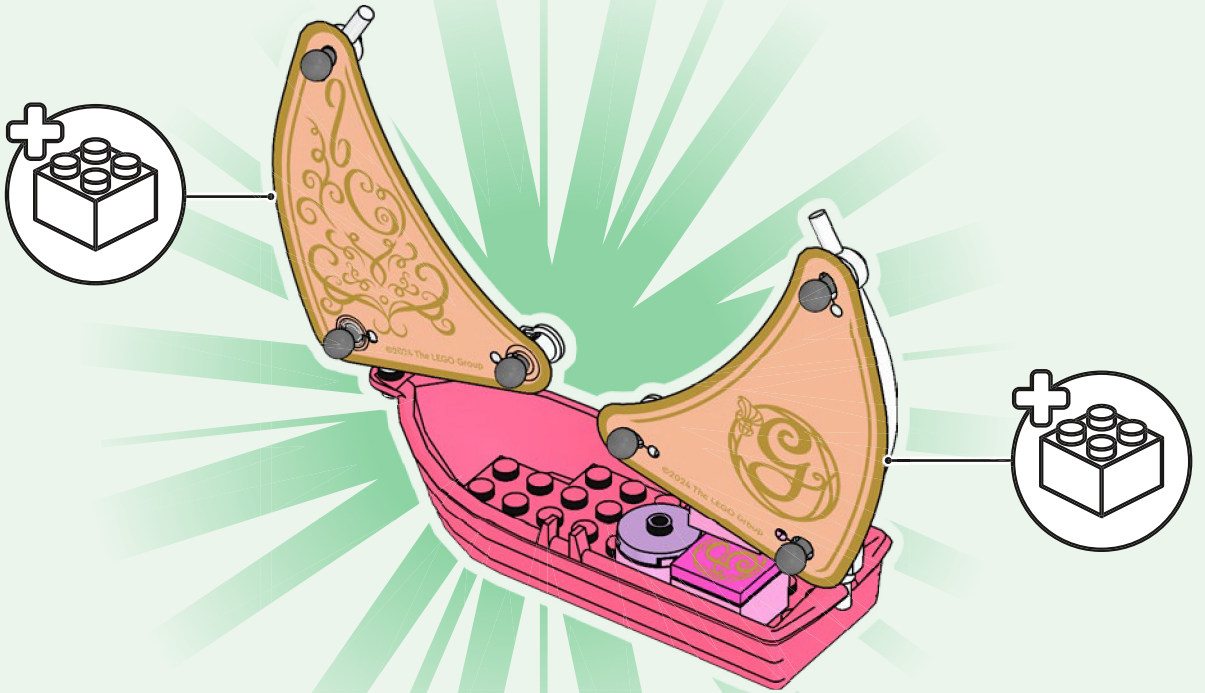

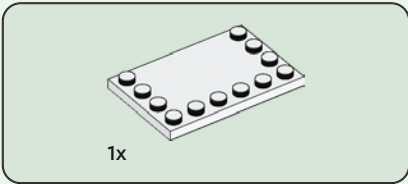
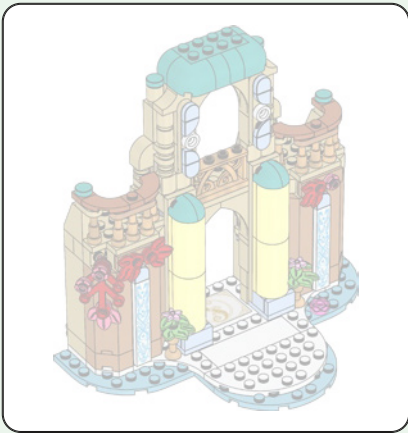

1

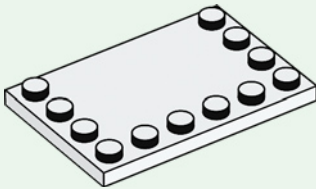

2



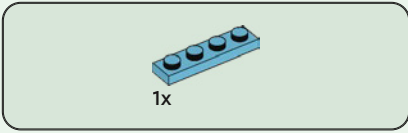

3

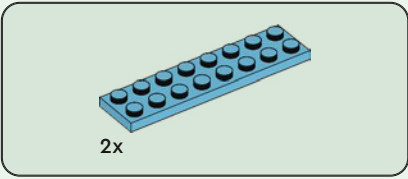
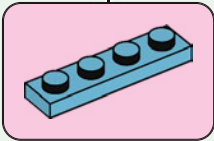
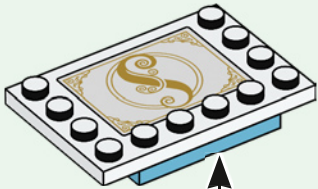

4

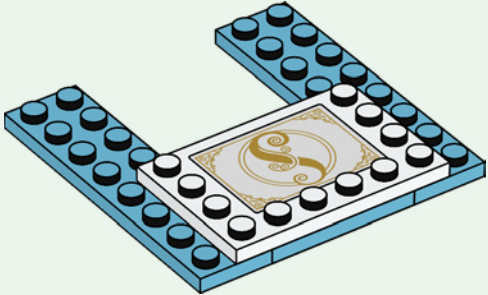

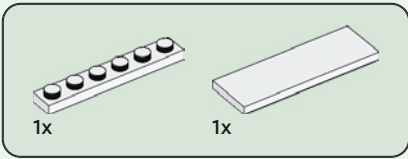

5

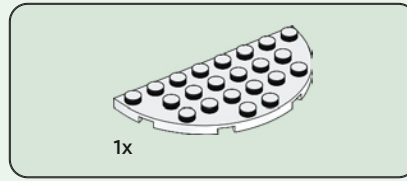
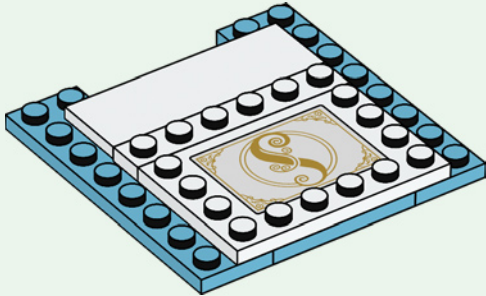

6

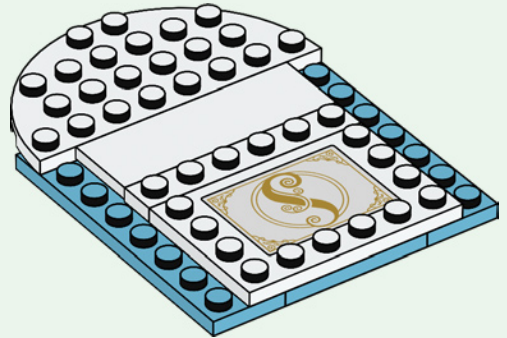

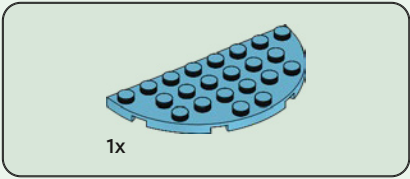

7

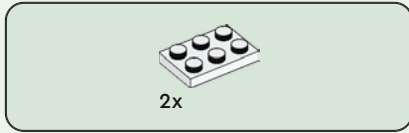
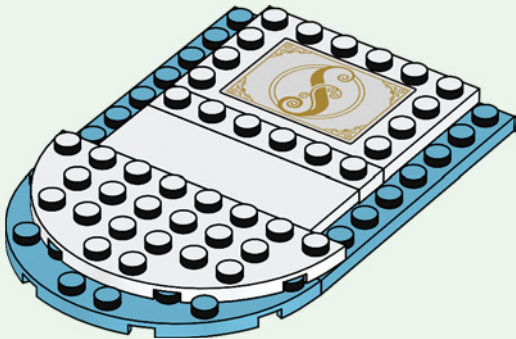

8

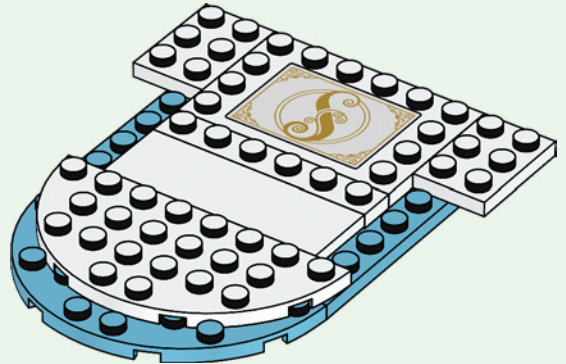

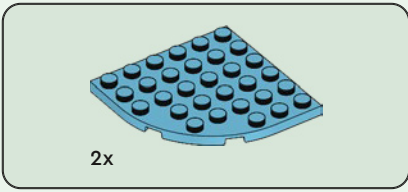

9

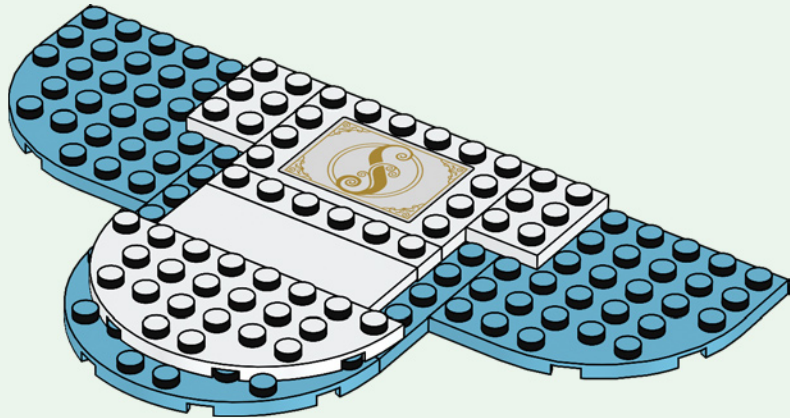



2x

10

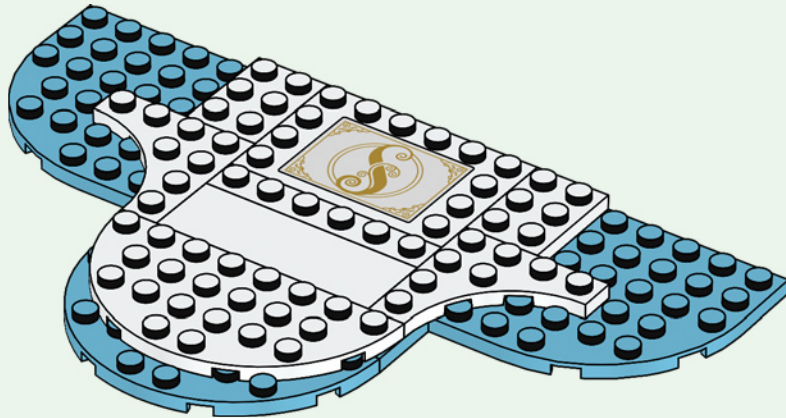

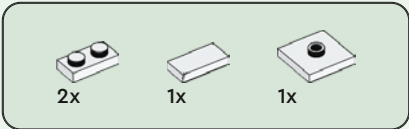

11

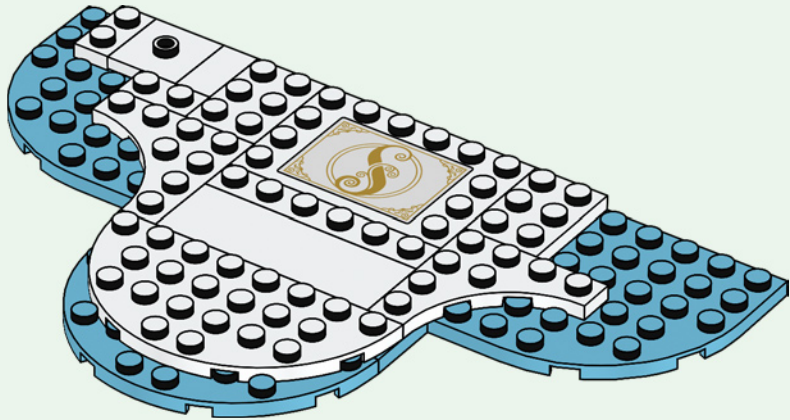



1x

12

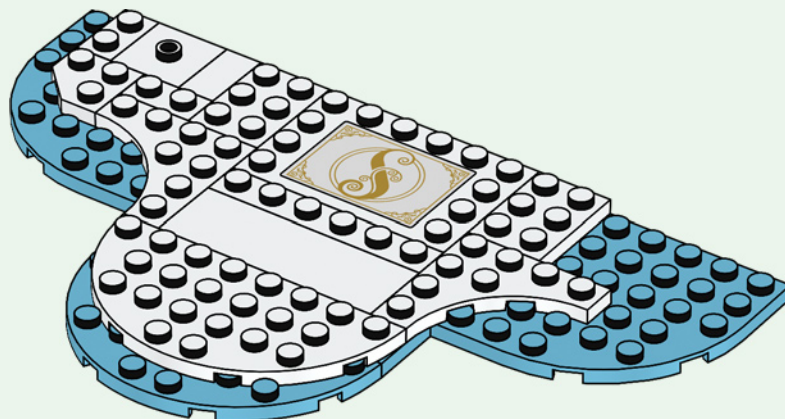

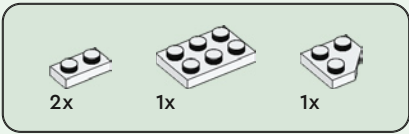

13

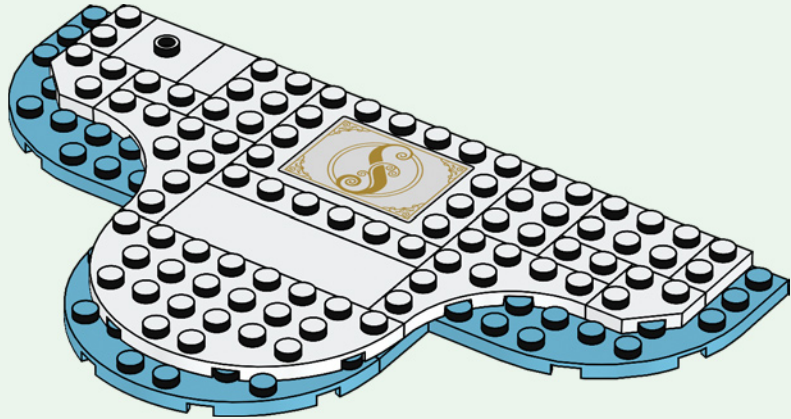

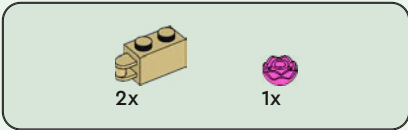

14

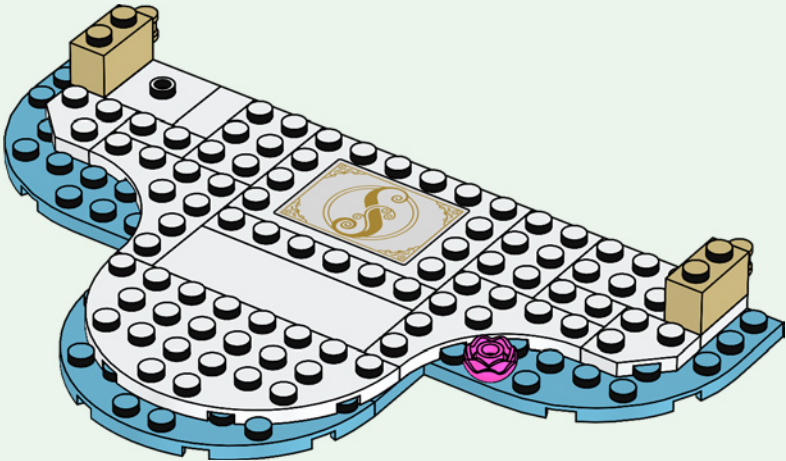



2x



4x

15

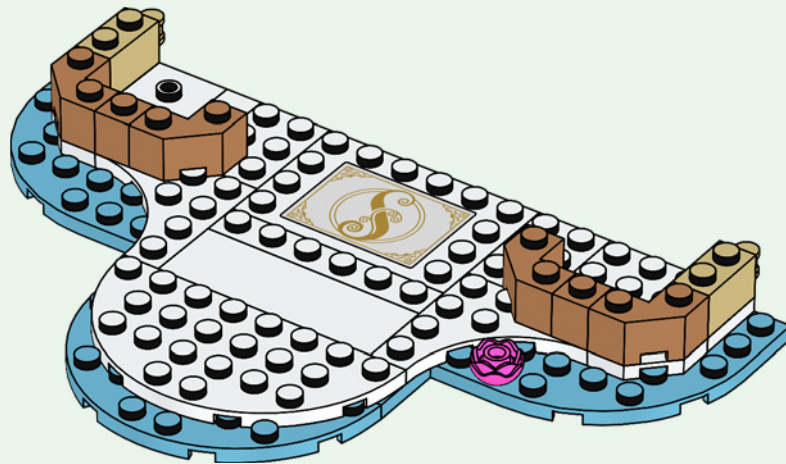

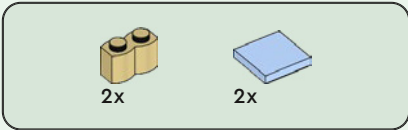

16

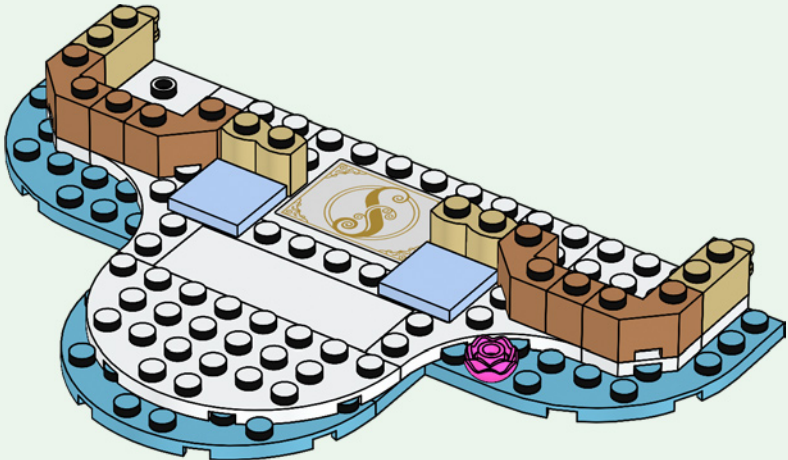



2x

17

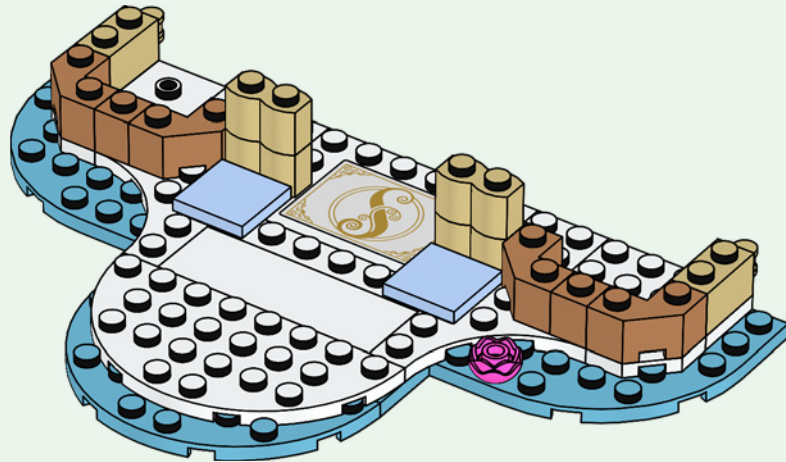



2x

18





2x



2x

19

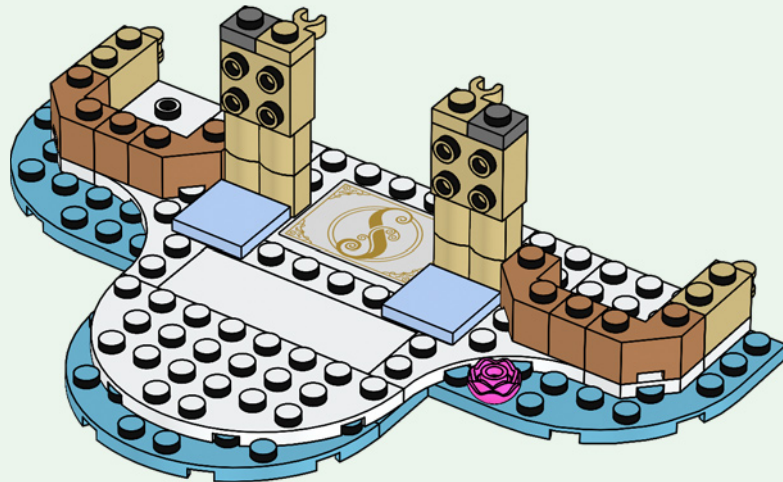

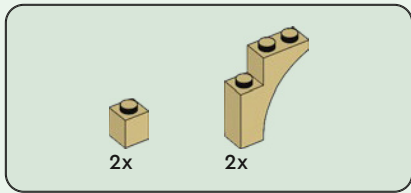

20

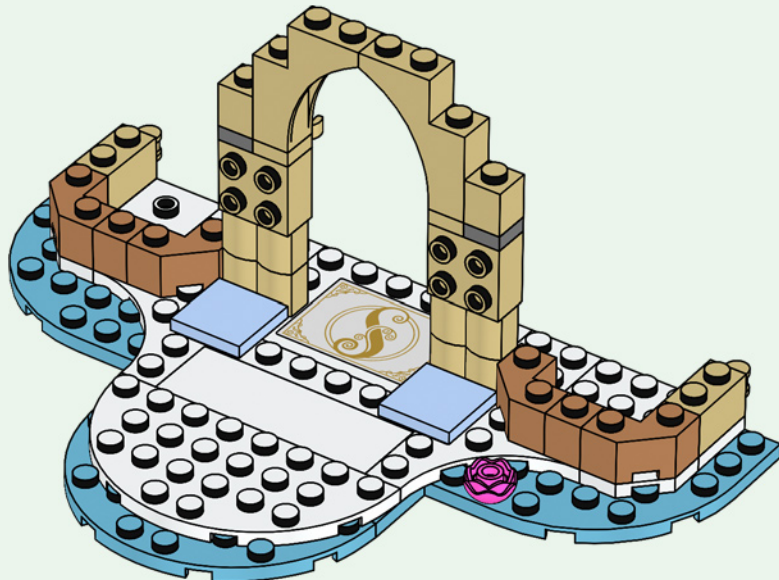



1x

21

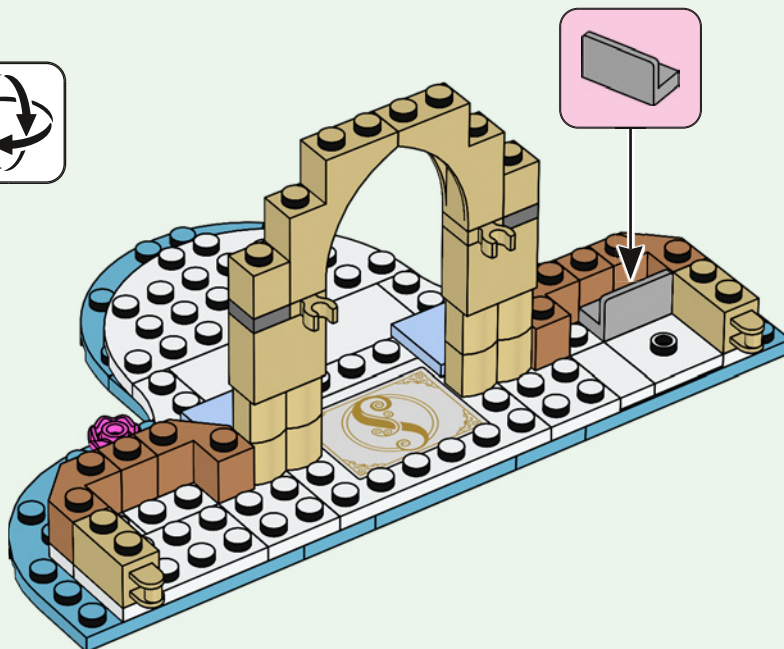

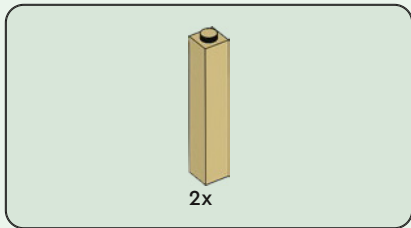

22

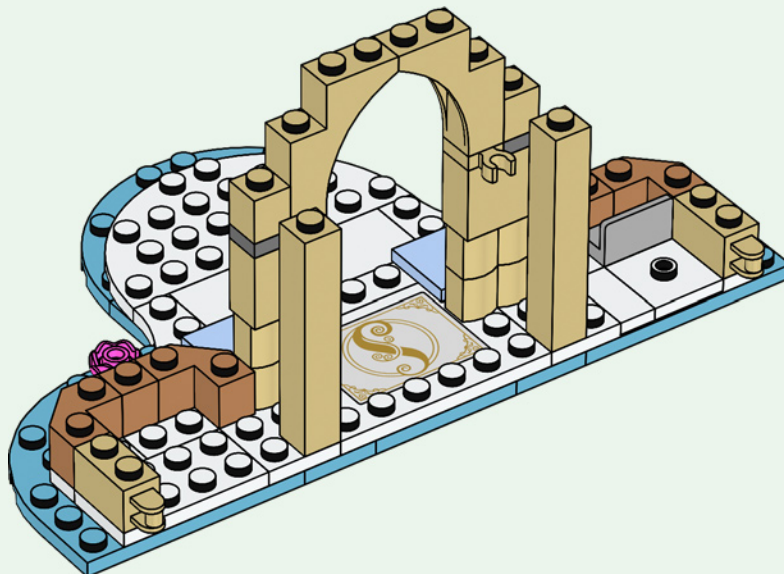



2x

23

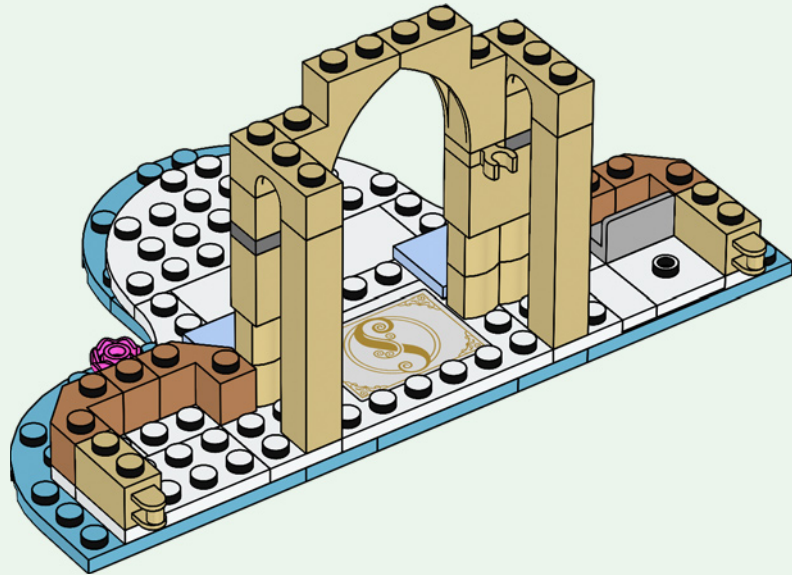



2x

24

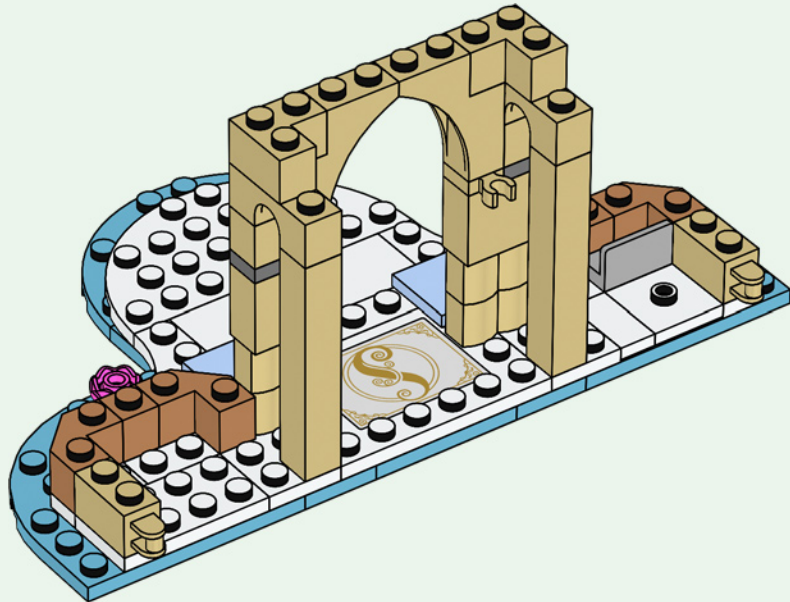

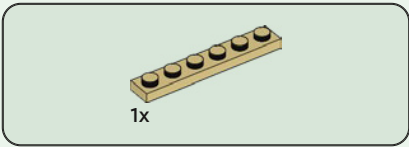

25

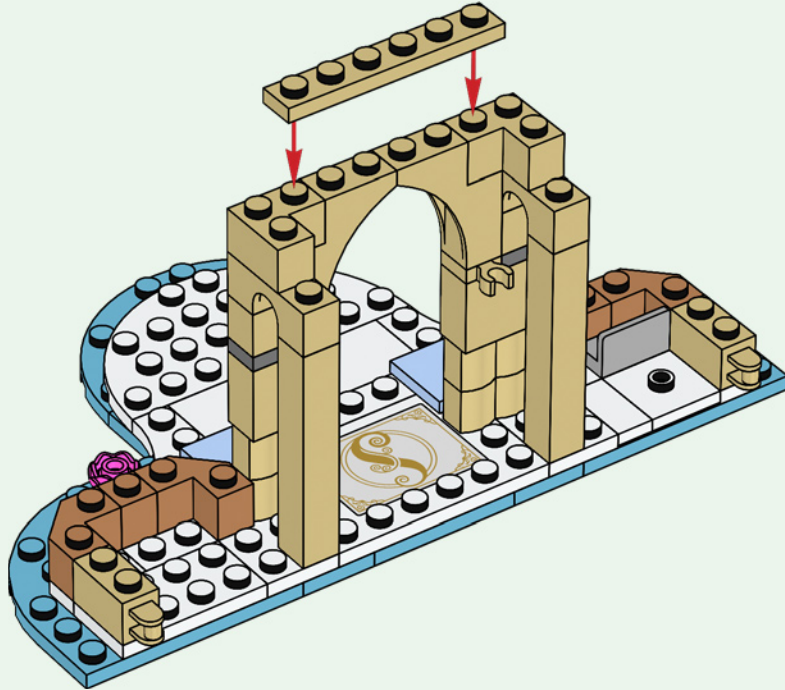



2x



2x

26

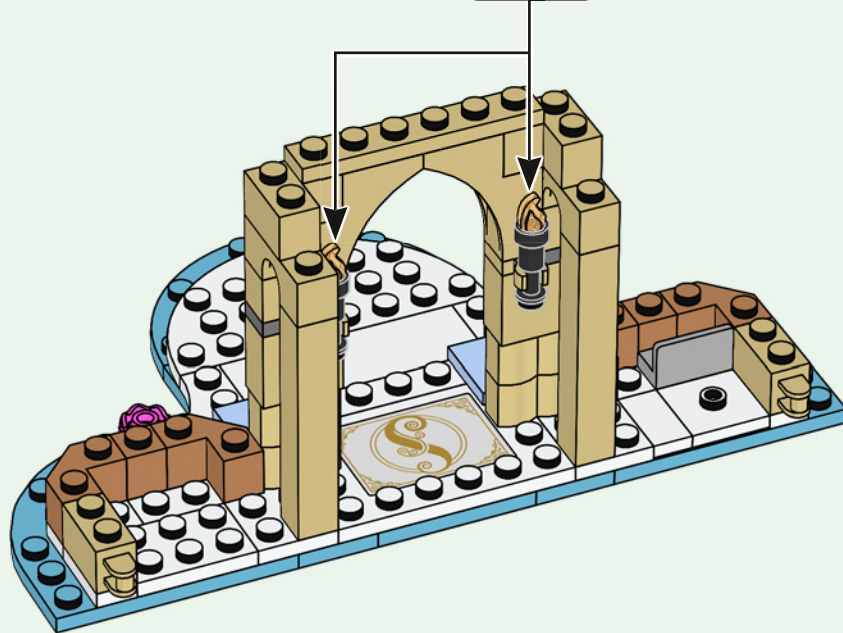
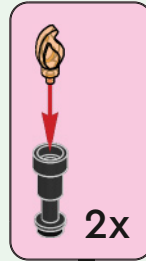



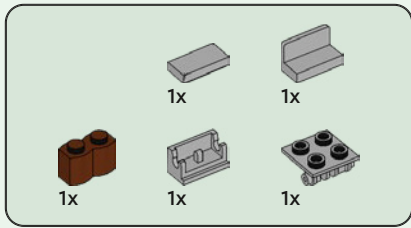

27

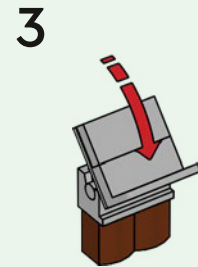
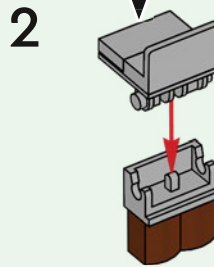
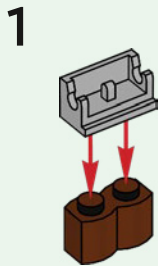
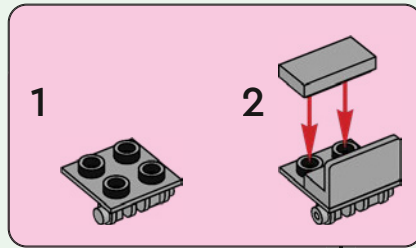

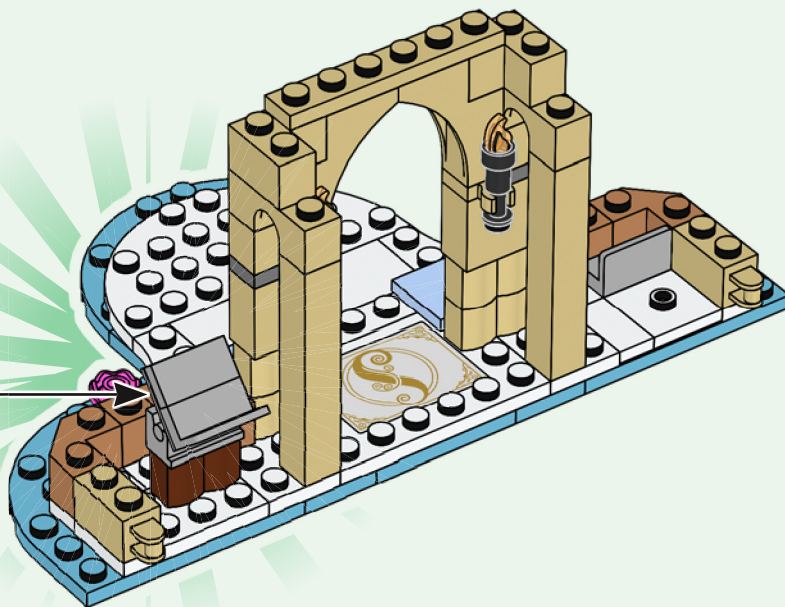



1x

28



2x

29

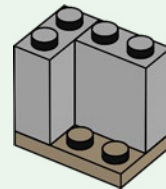



30

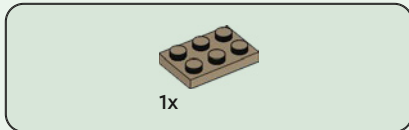
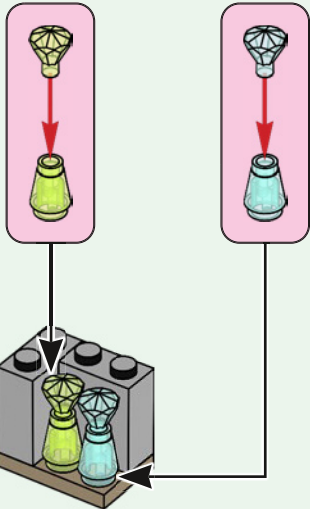

31





1x

32



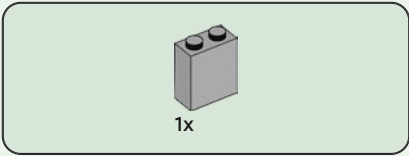

33

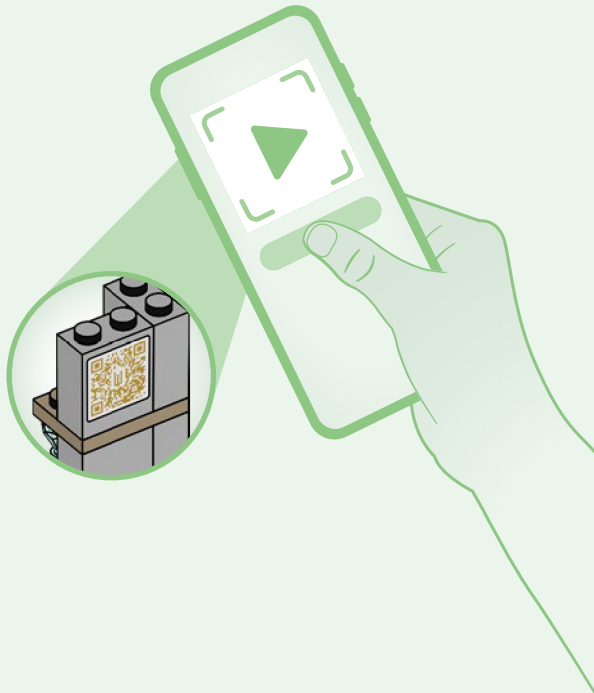
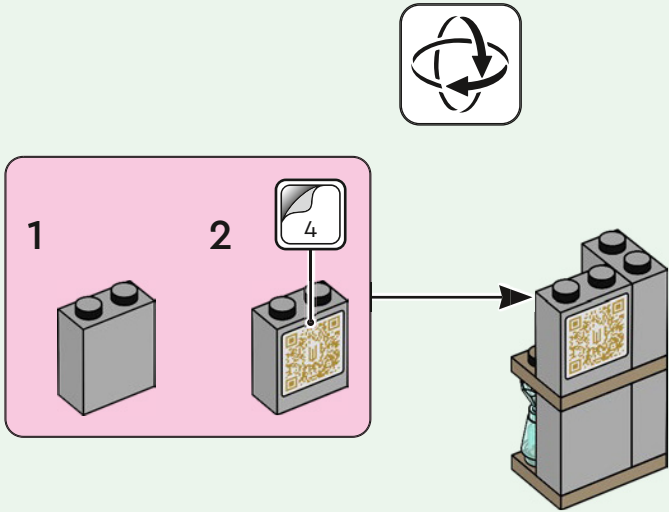

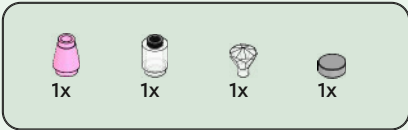

34

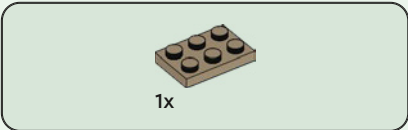
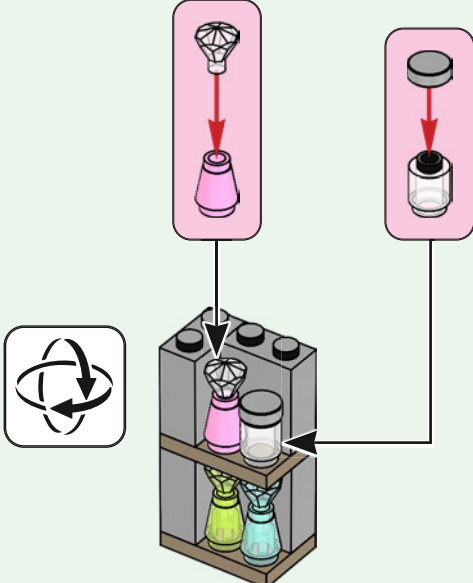

35



36

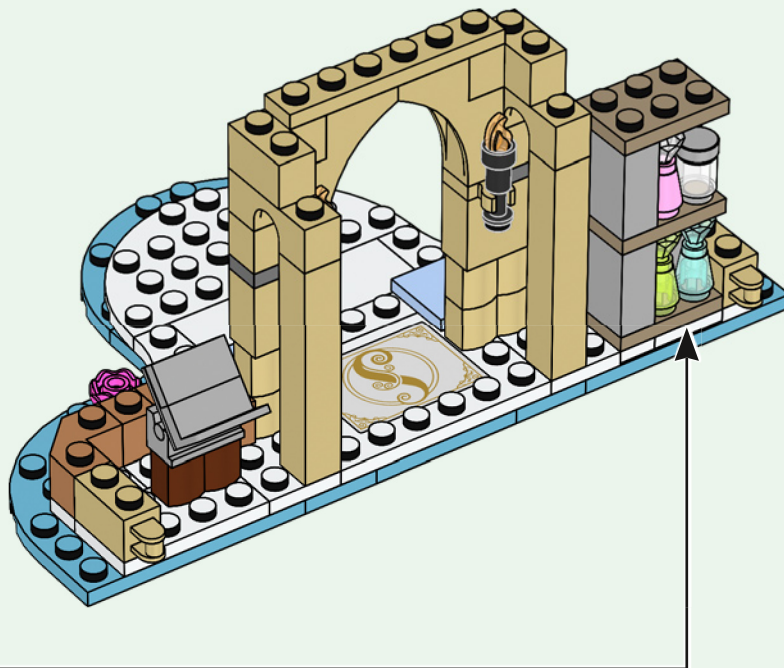

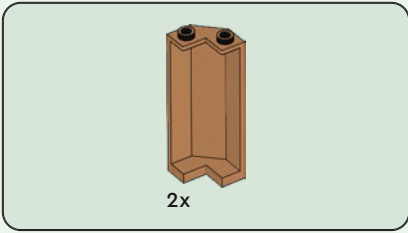

37

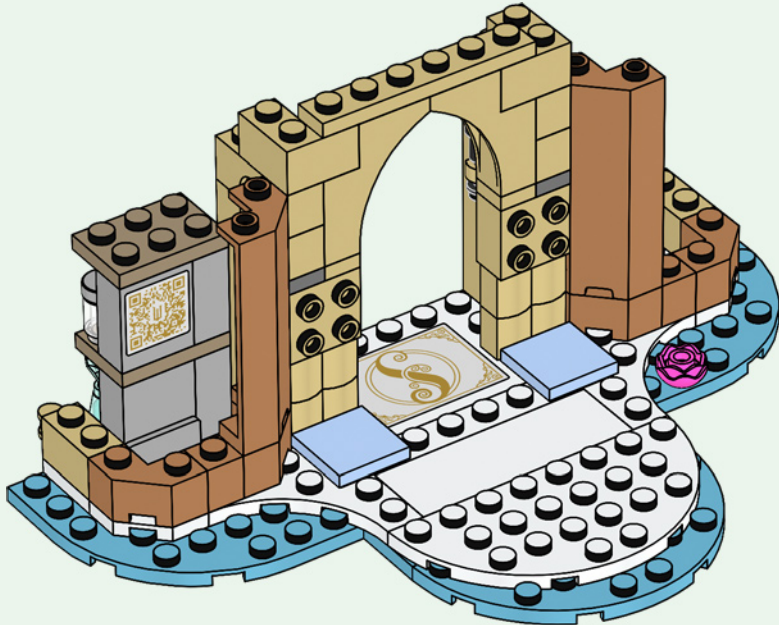

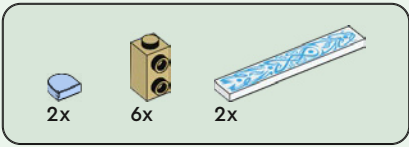

38

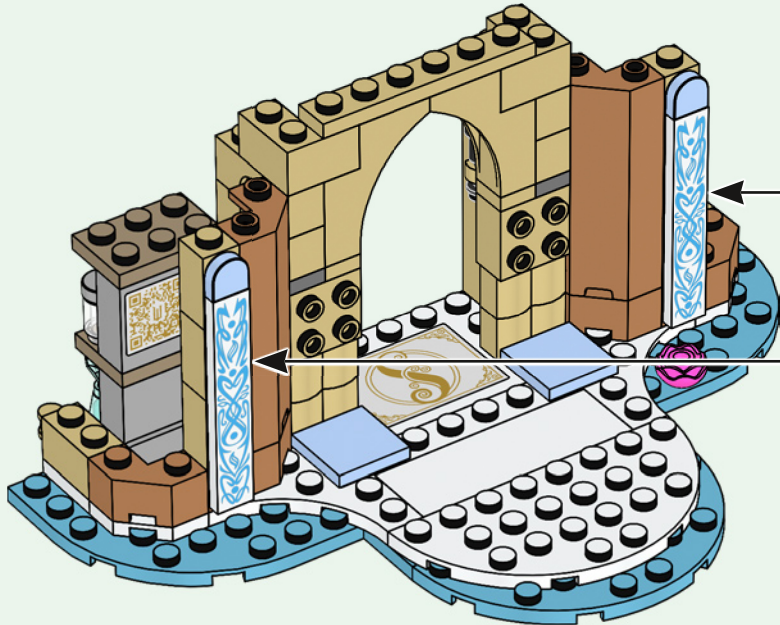
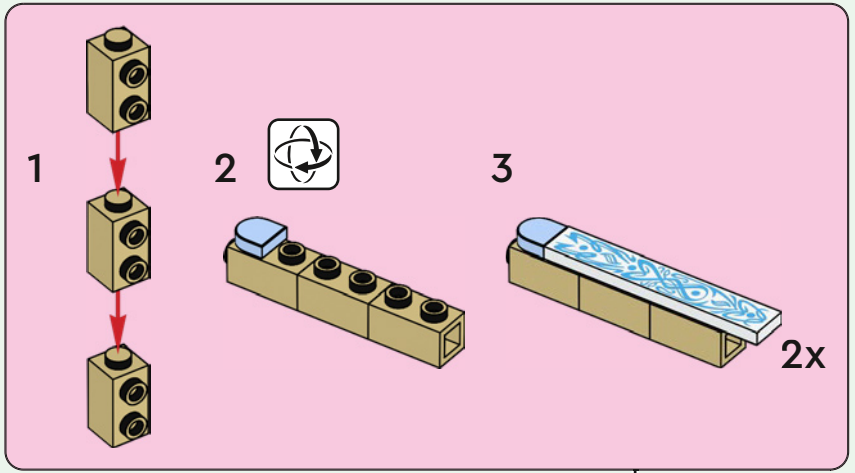

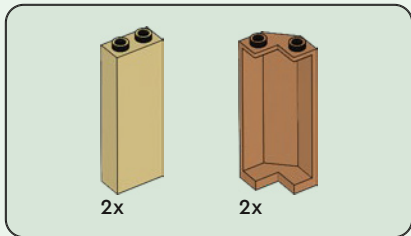

39

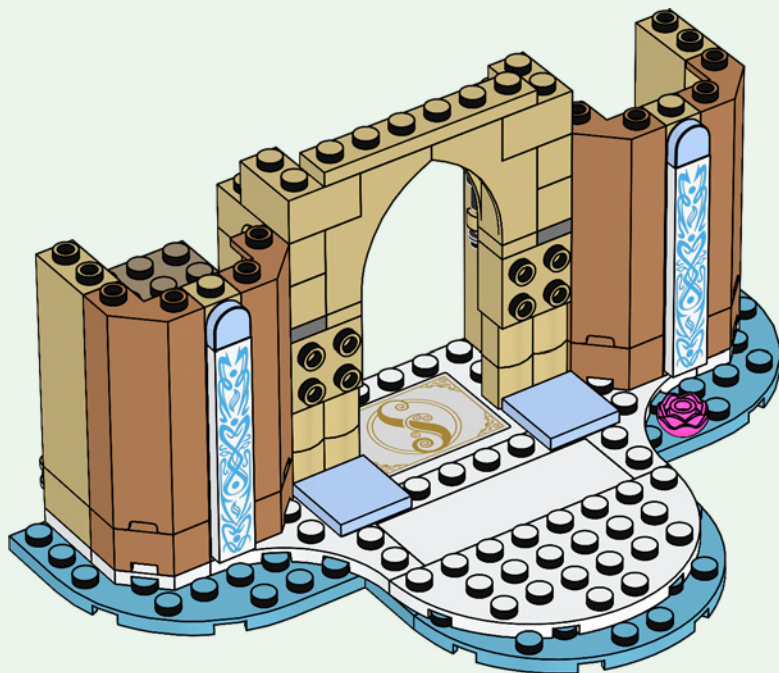

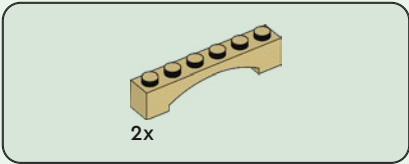

40

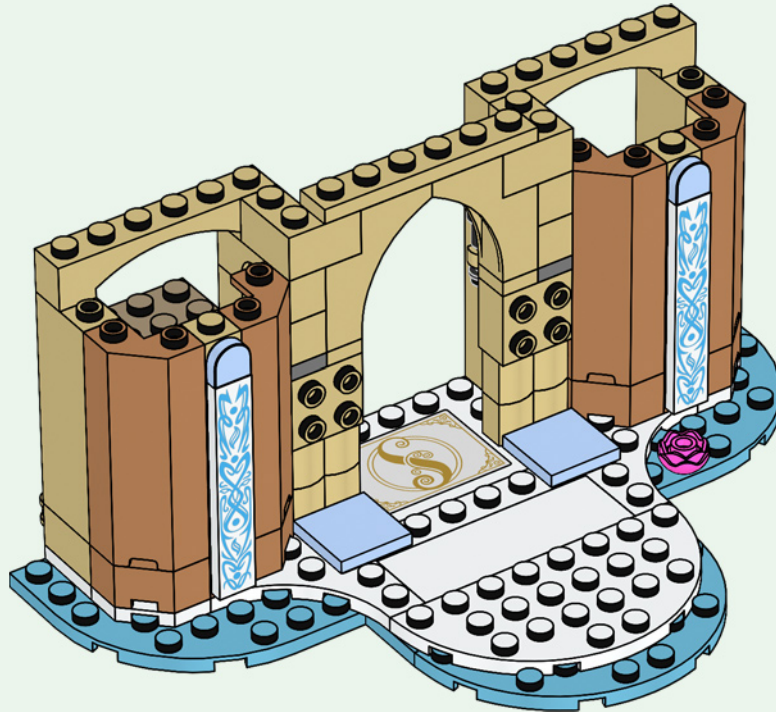



2x

41

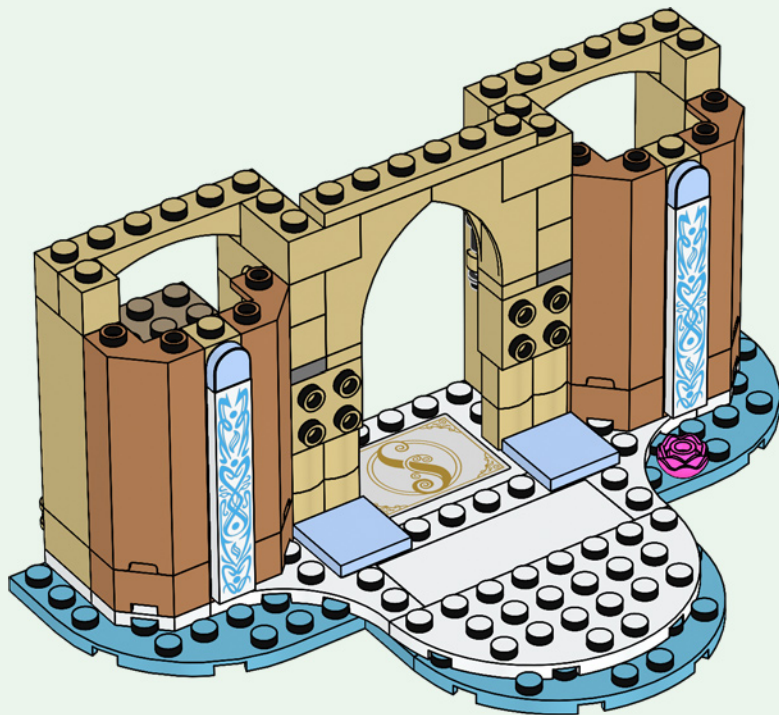



4x

42

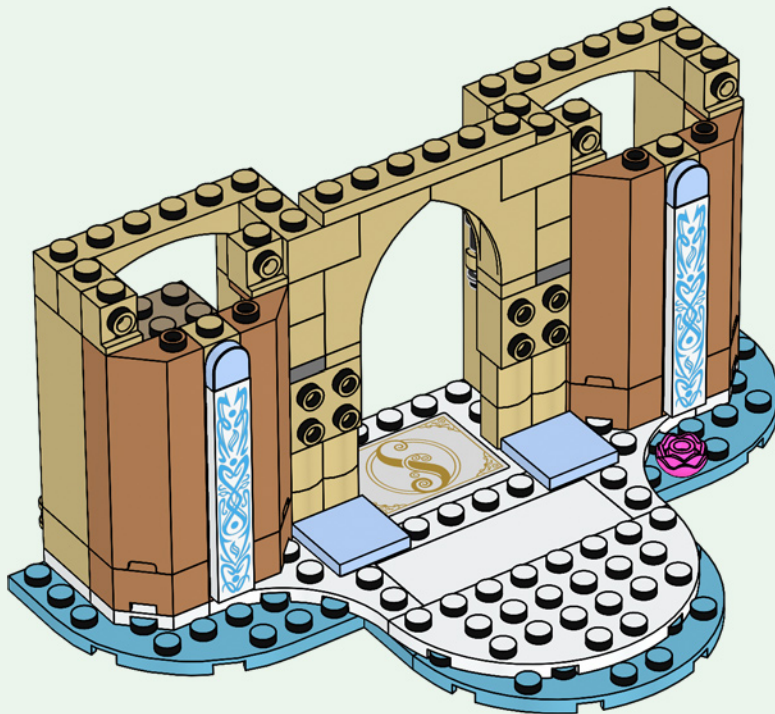



6x

43

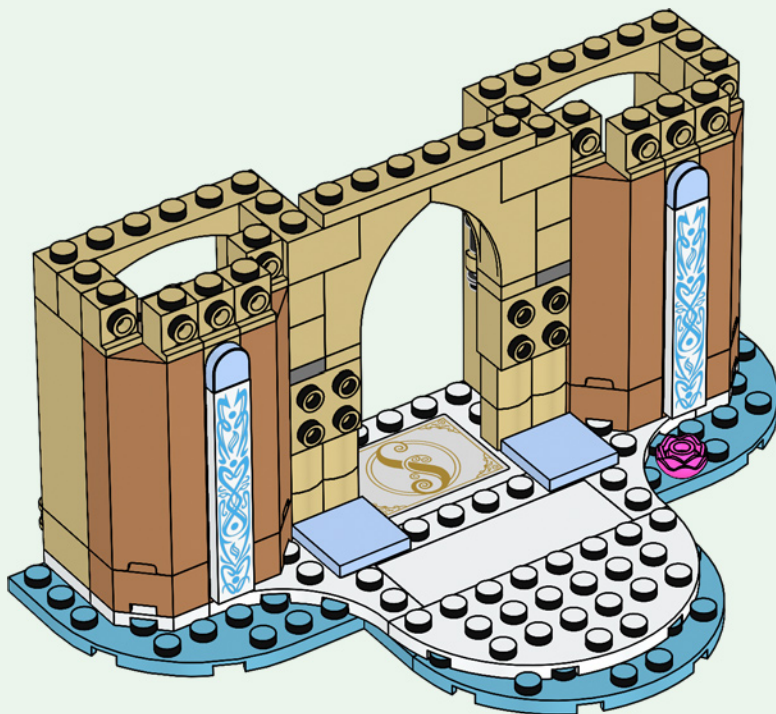

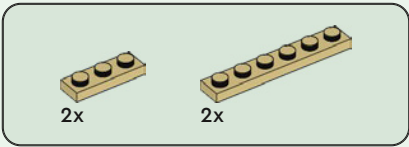

44

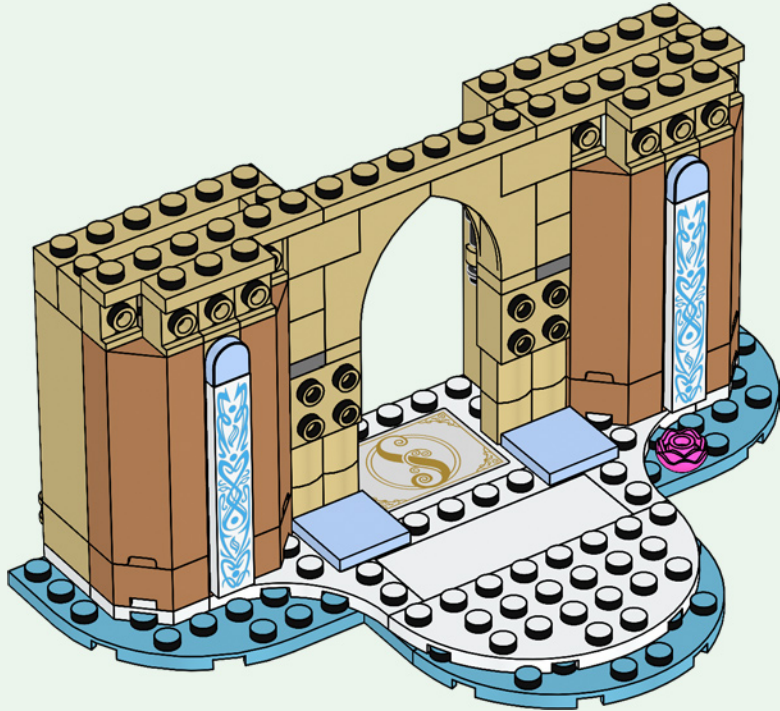

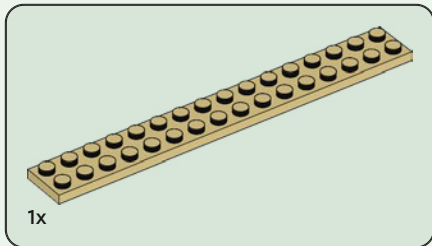

45

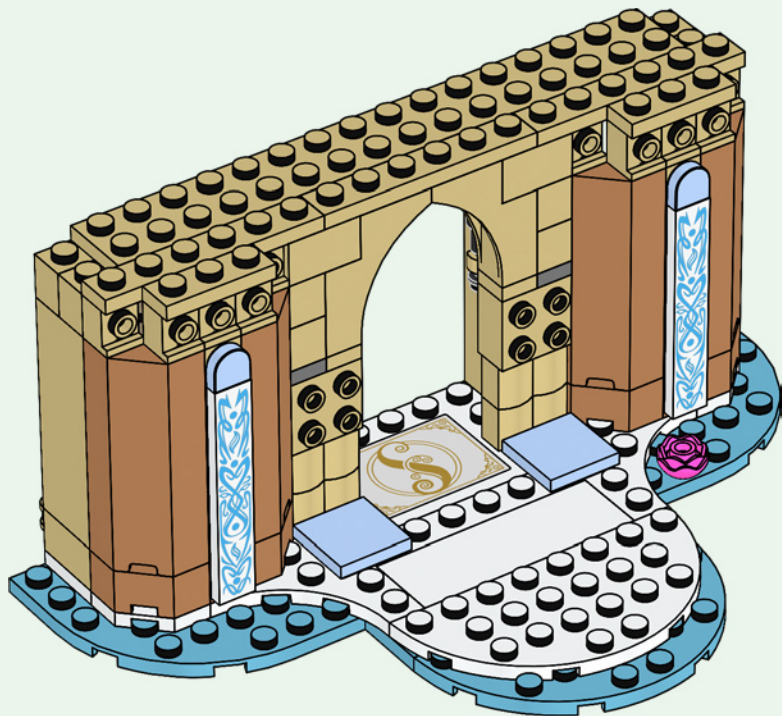



3x

46



3x

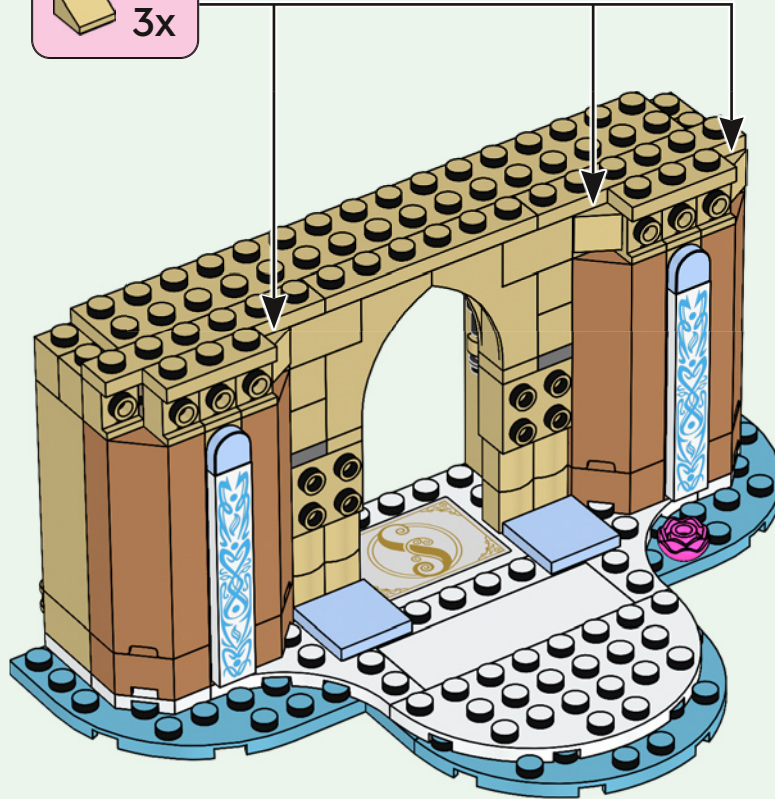

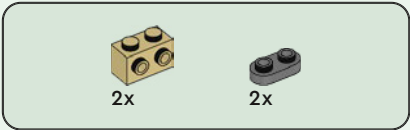

47

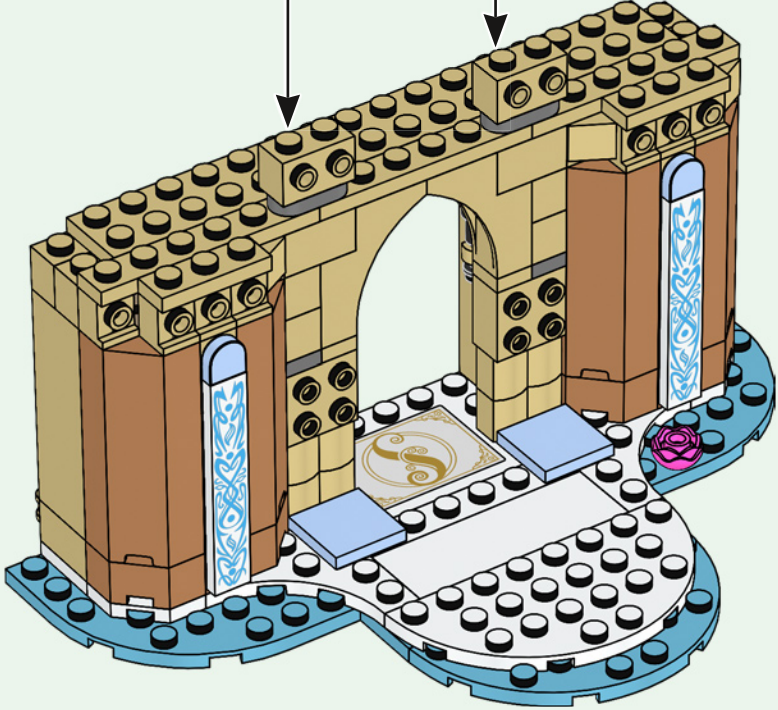
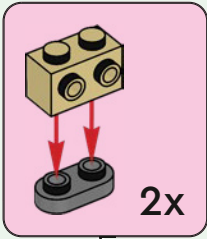



2x

48

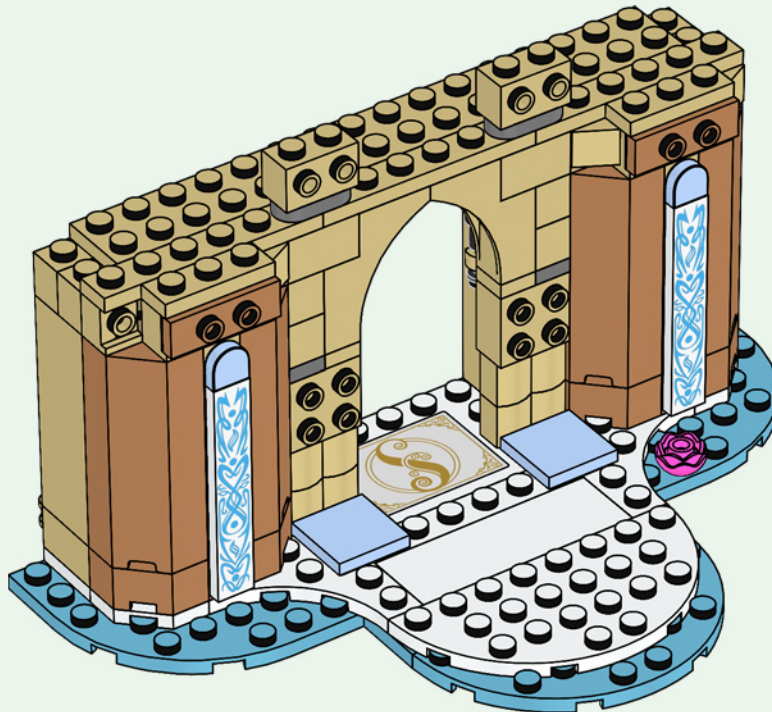

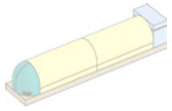

2x

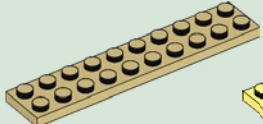

2x

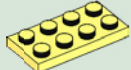

4x



2x



2x

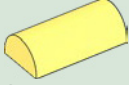

4x



4x

49

1

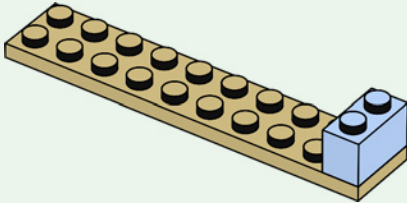

2

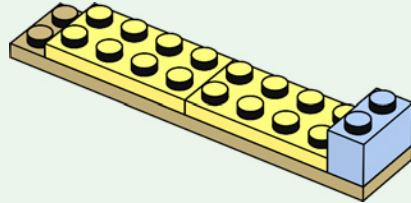

3

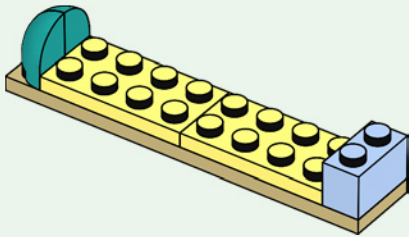

4

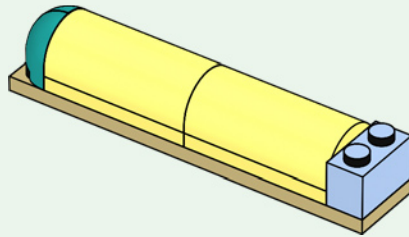

5

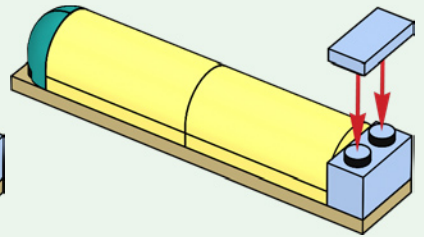

2x



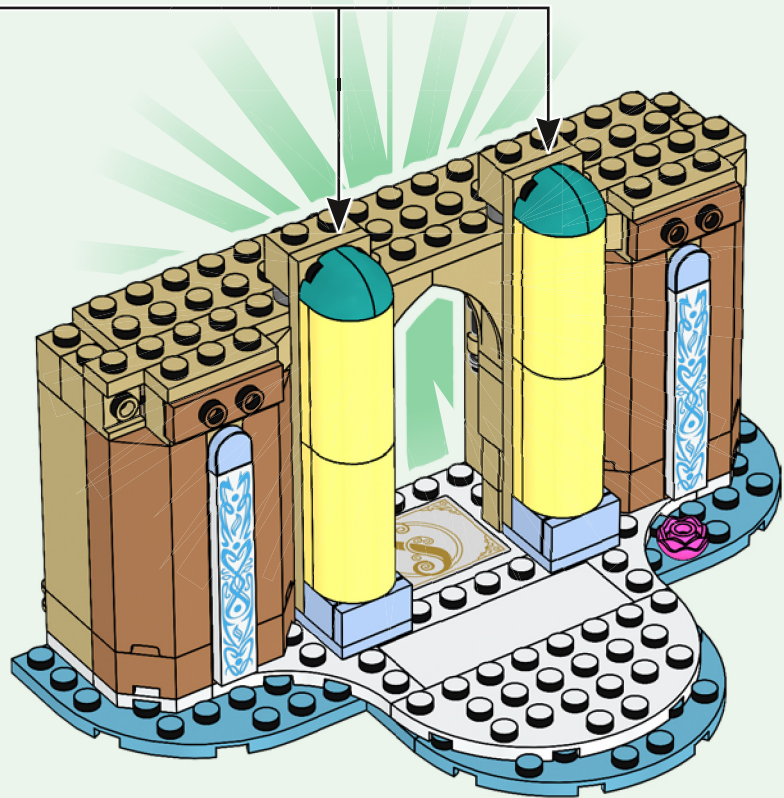



50

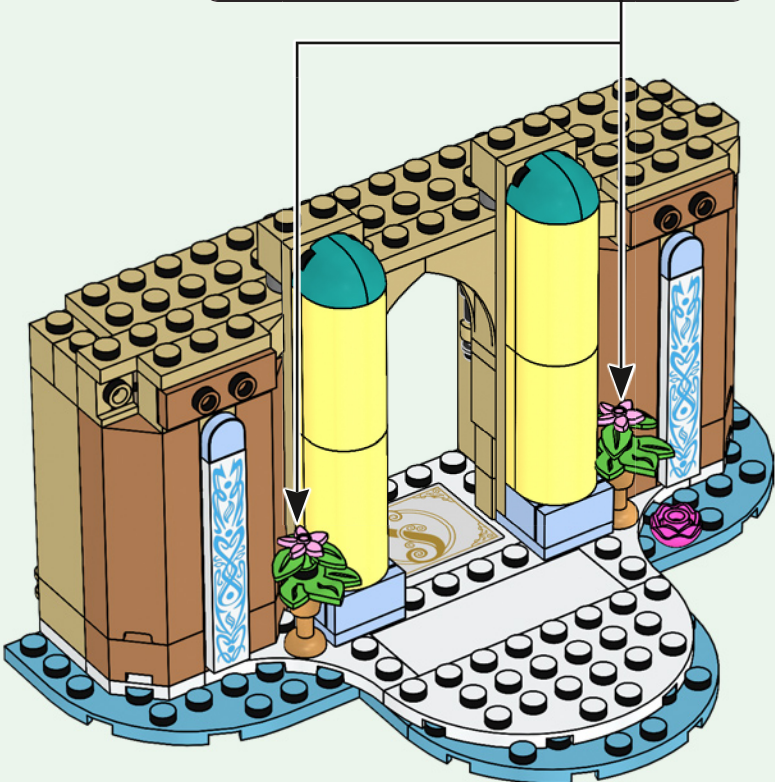
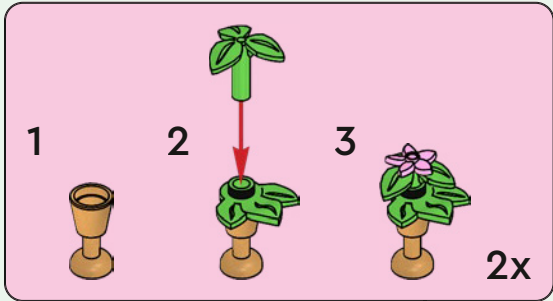



1x



3x

51

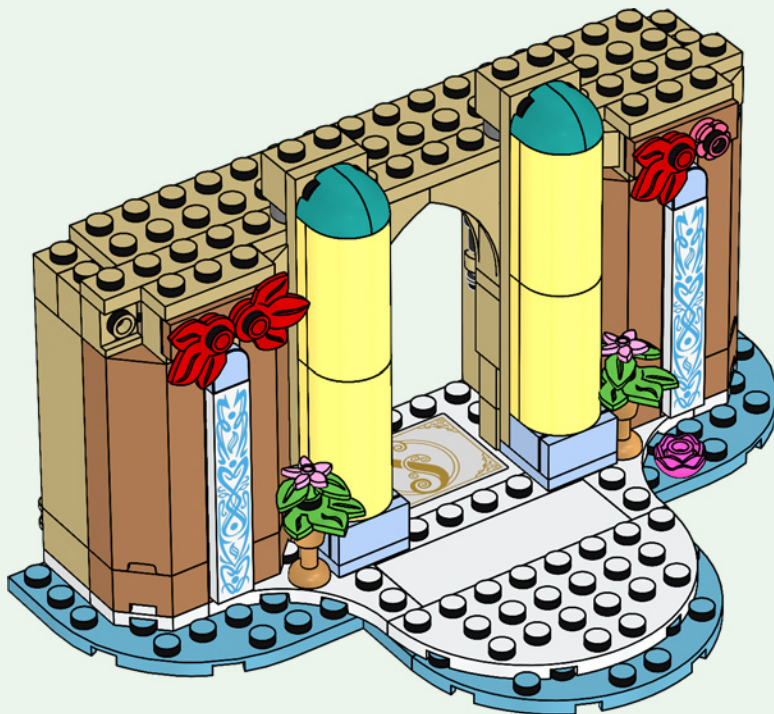



52

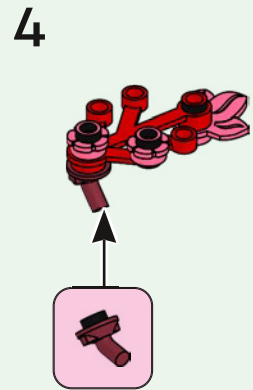
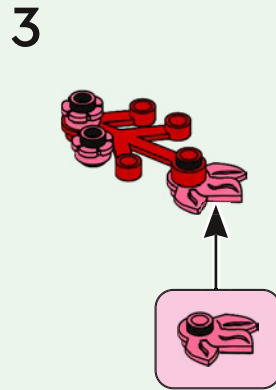
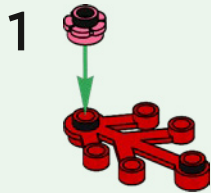



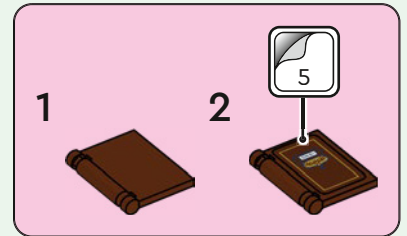
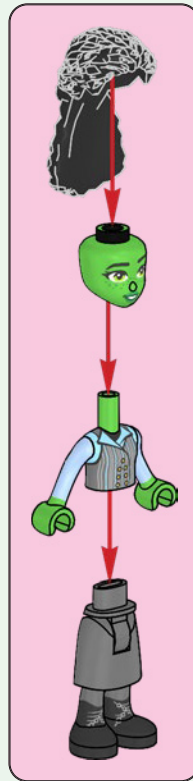



2x

53



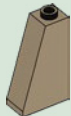

2x

54

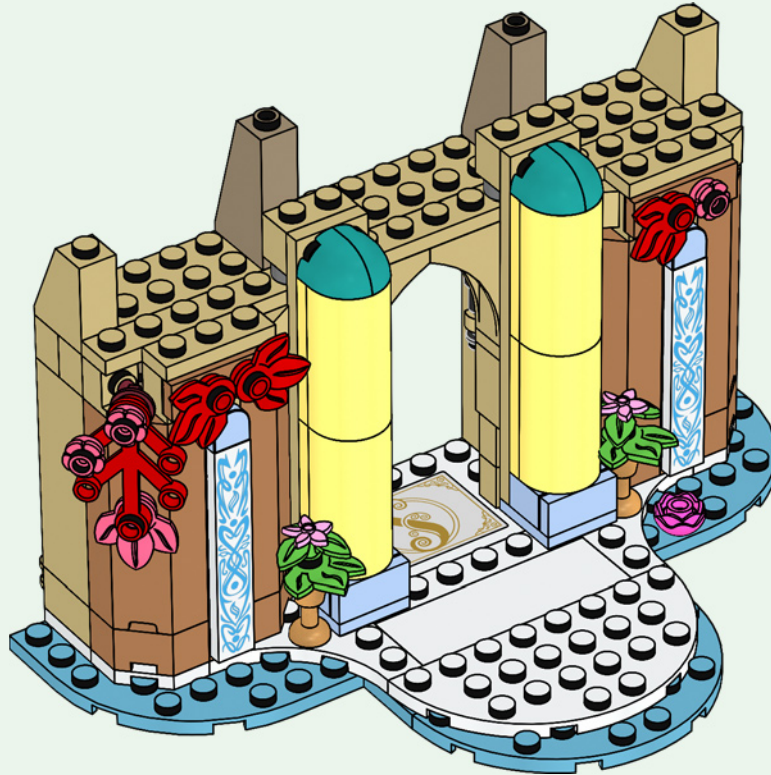



55

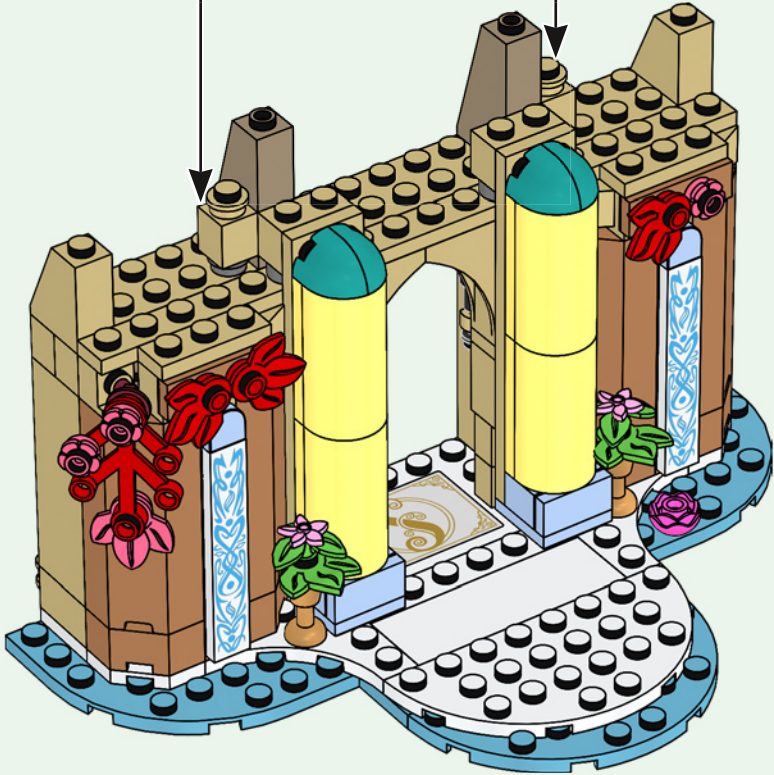
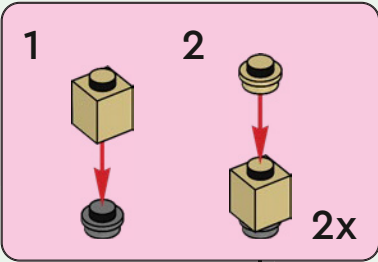



10x

56

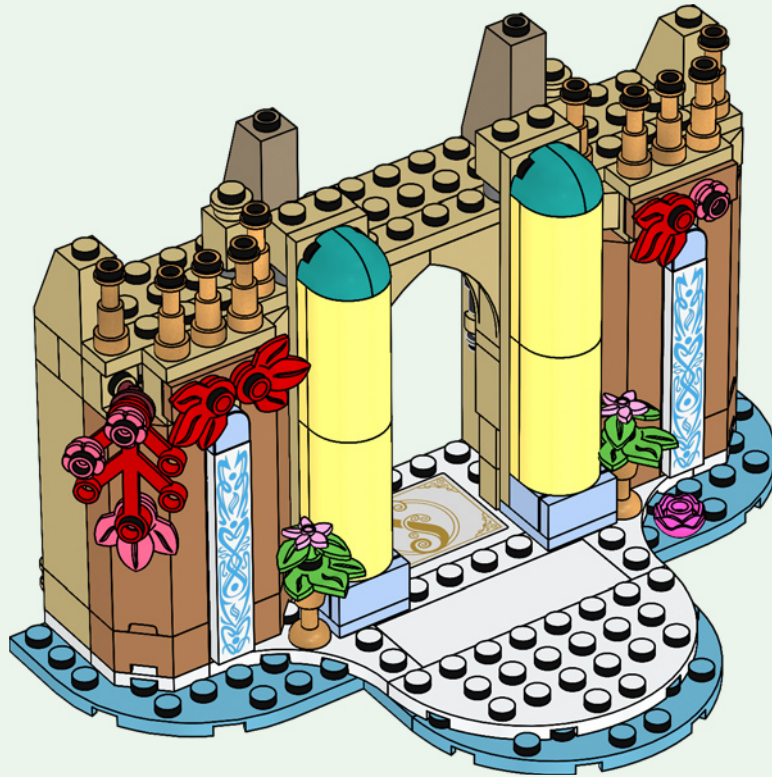



4x



2x

57

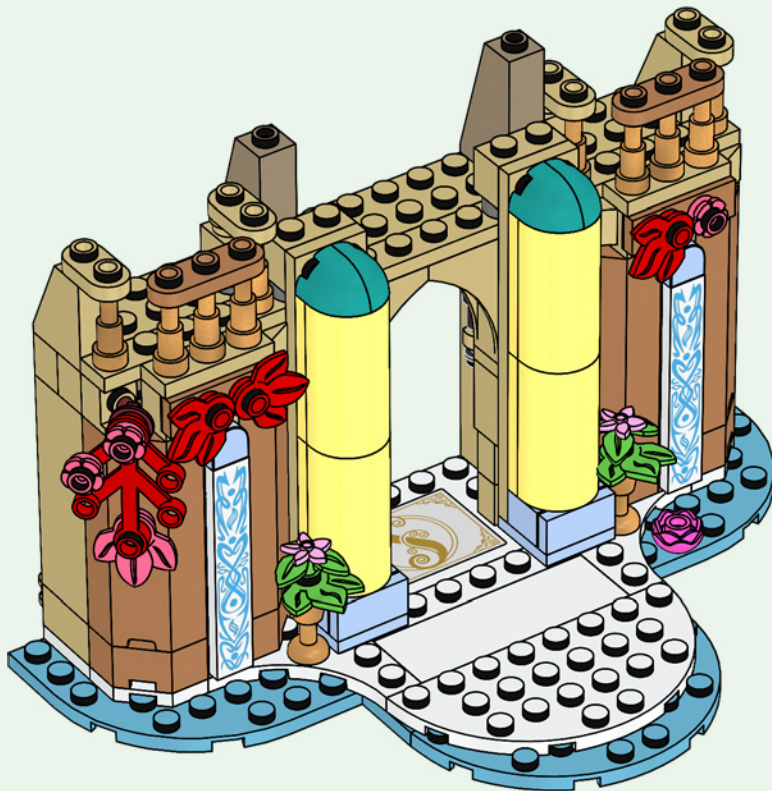

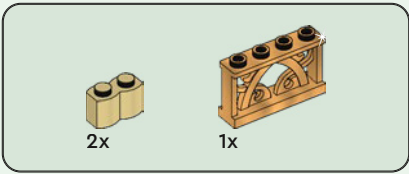

58

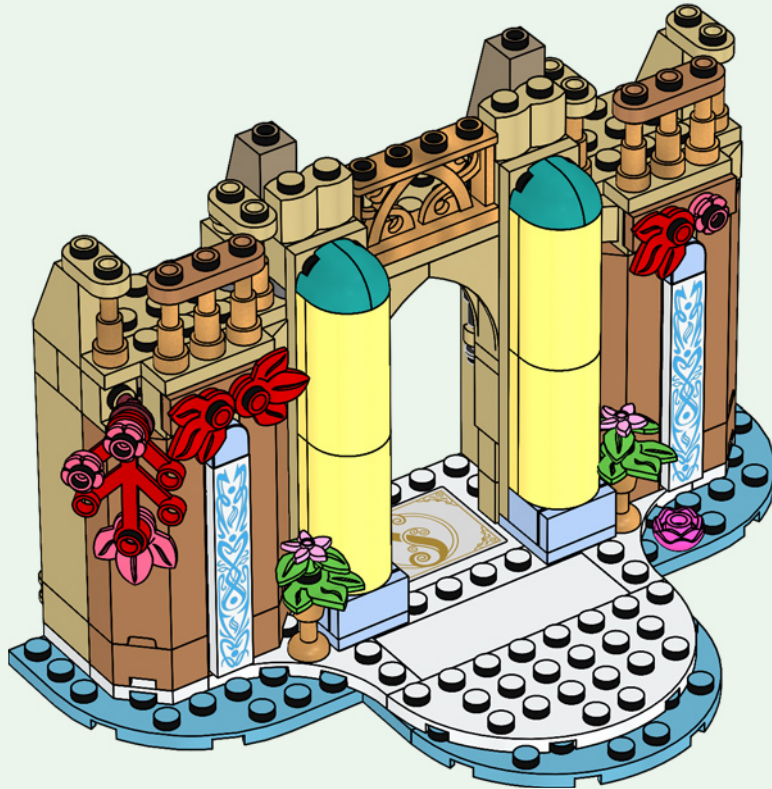



2x



4x

59

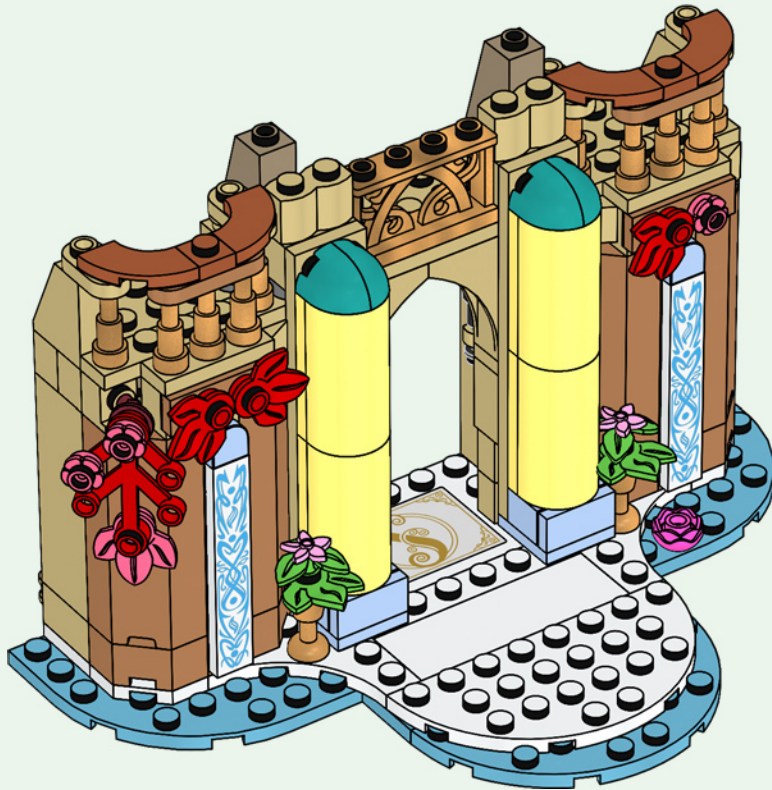



60

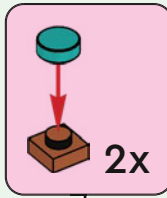



8x

61

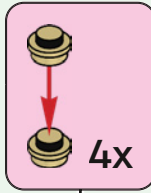

4x

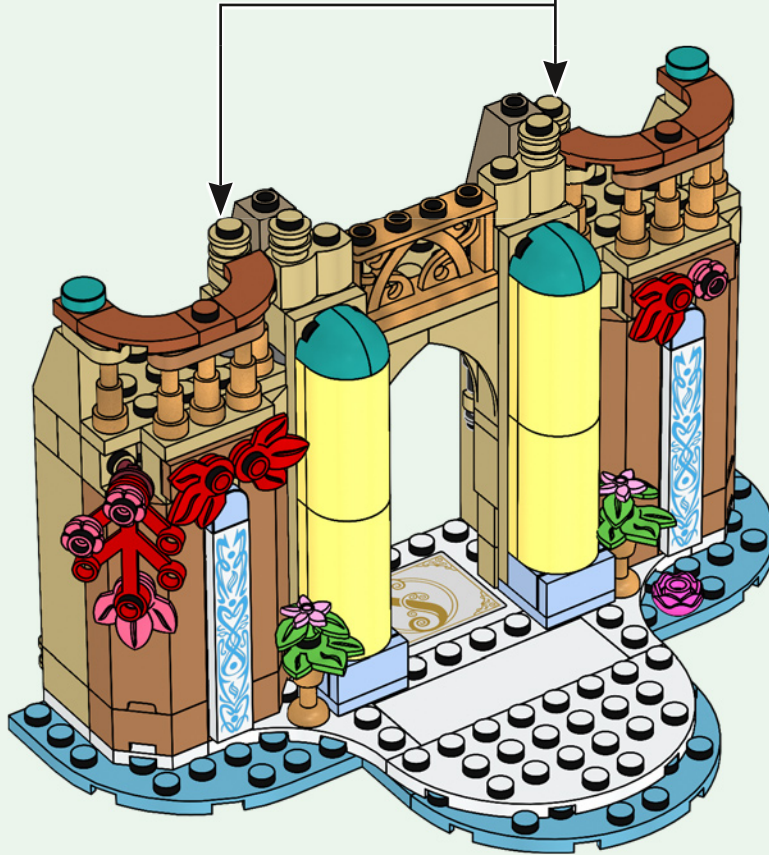



2x

62

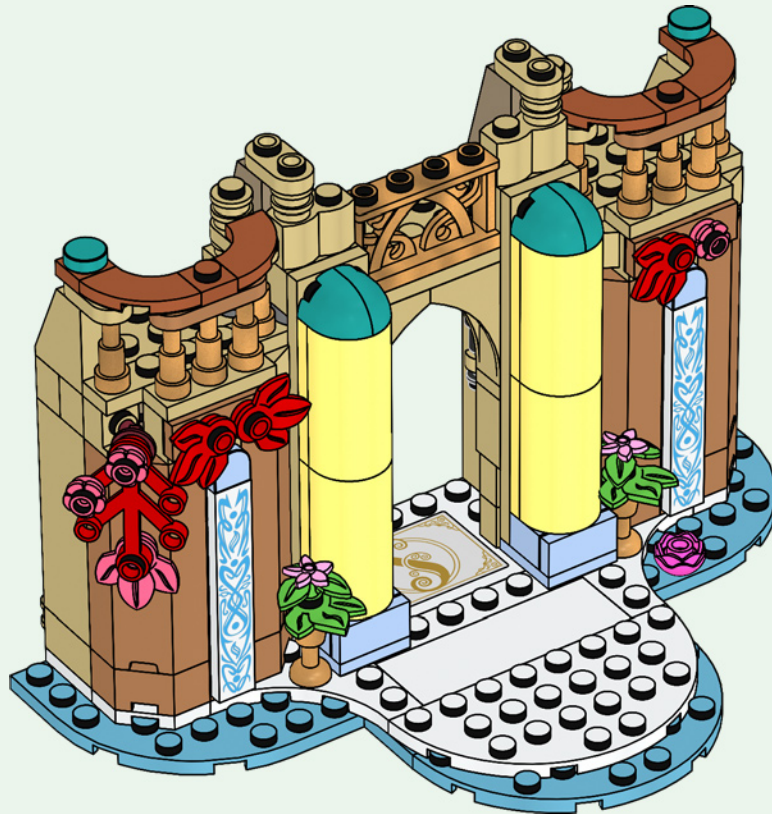



2x



2x

63





2x

64





2x

65

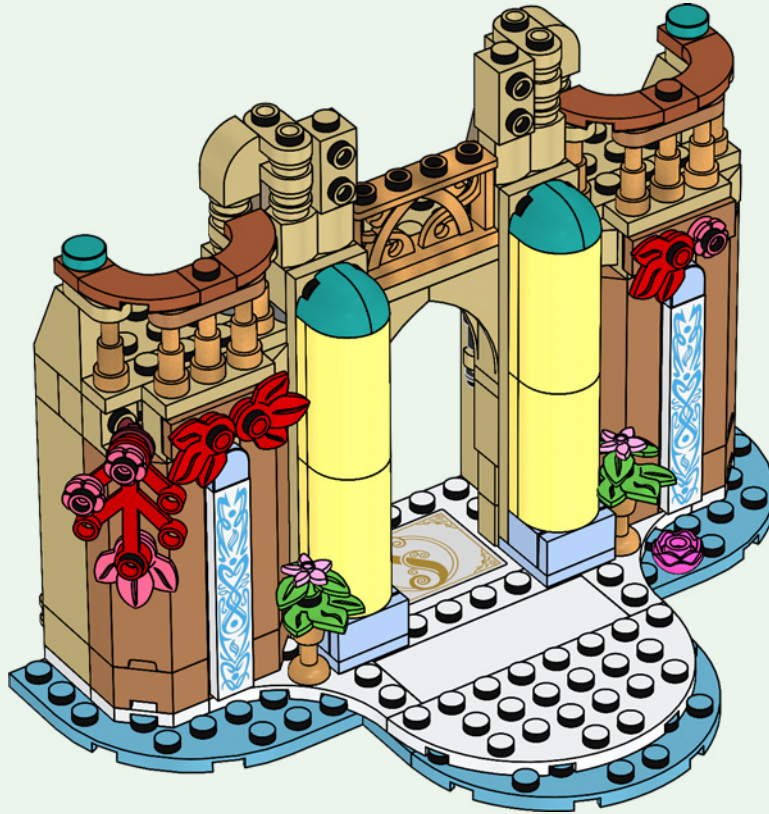

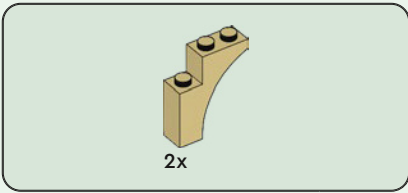

66





4x

67

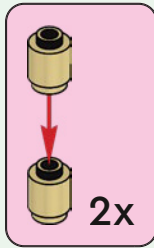

2x

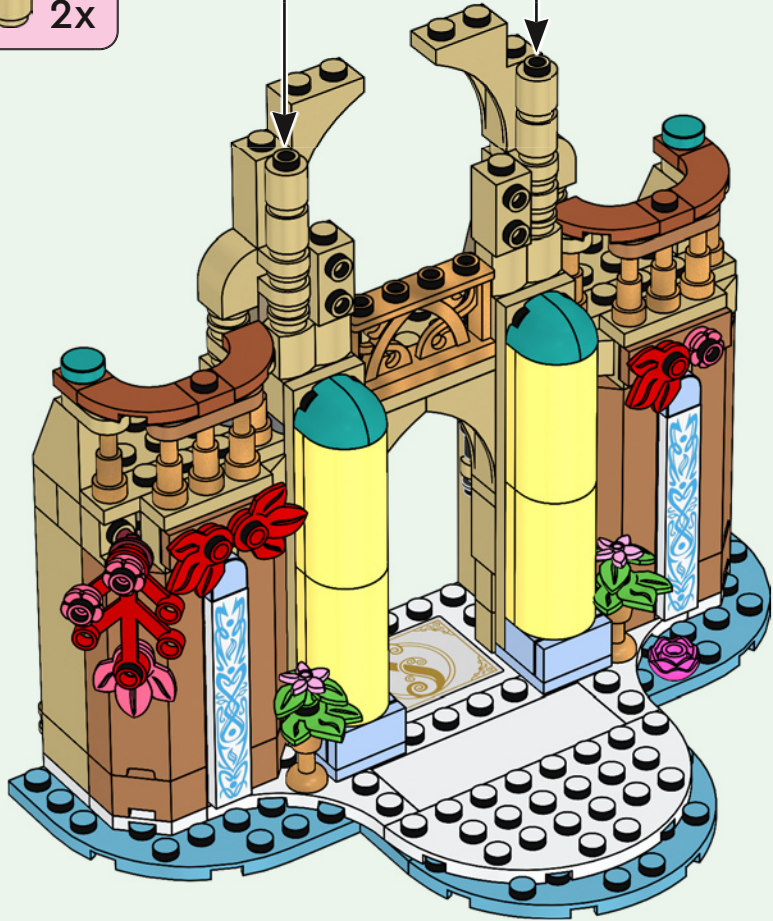

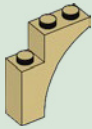

2x

68

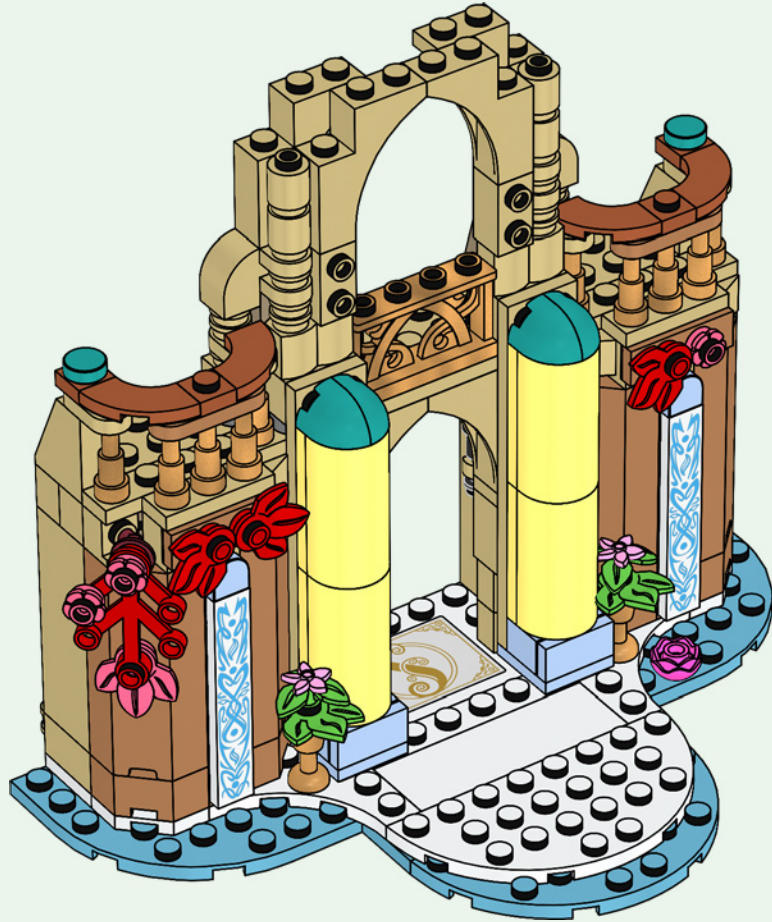



2x

69





2x

70

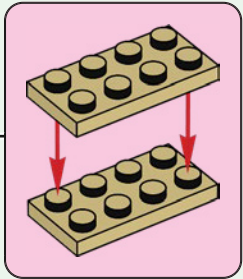



2x



2x

71

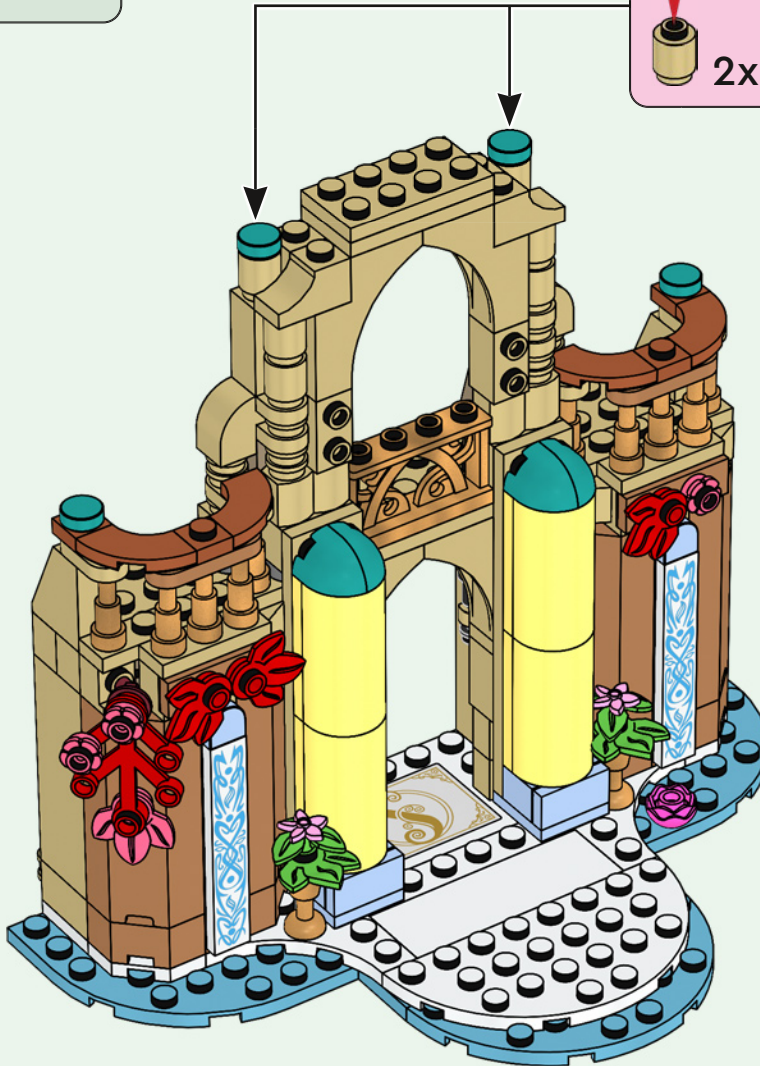
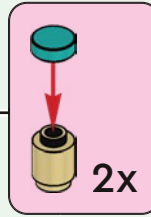



1x



2x

72





2x



2x

73



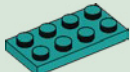

1x

74

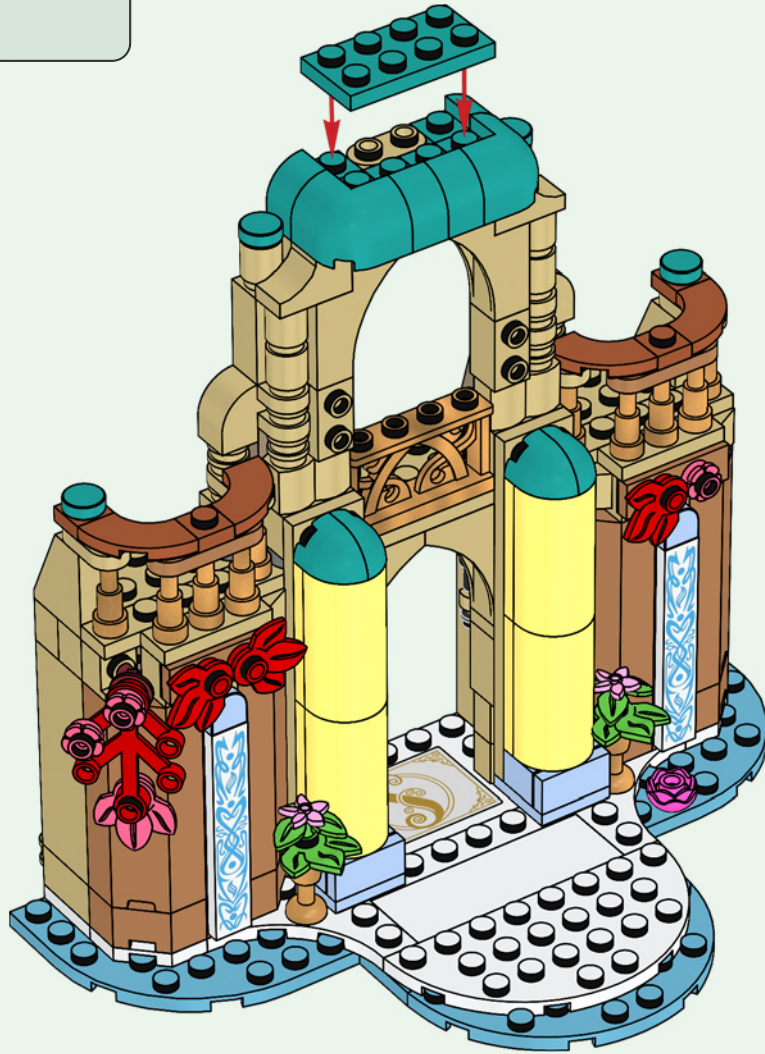

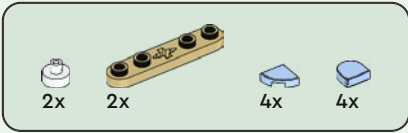

75

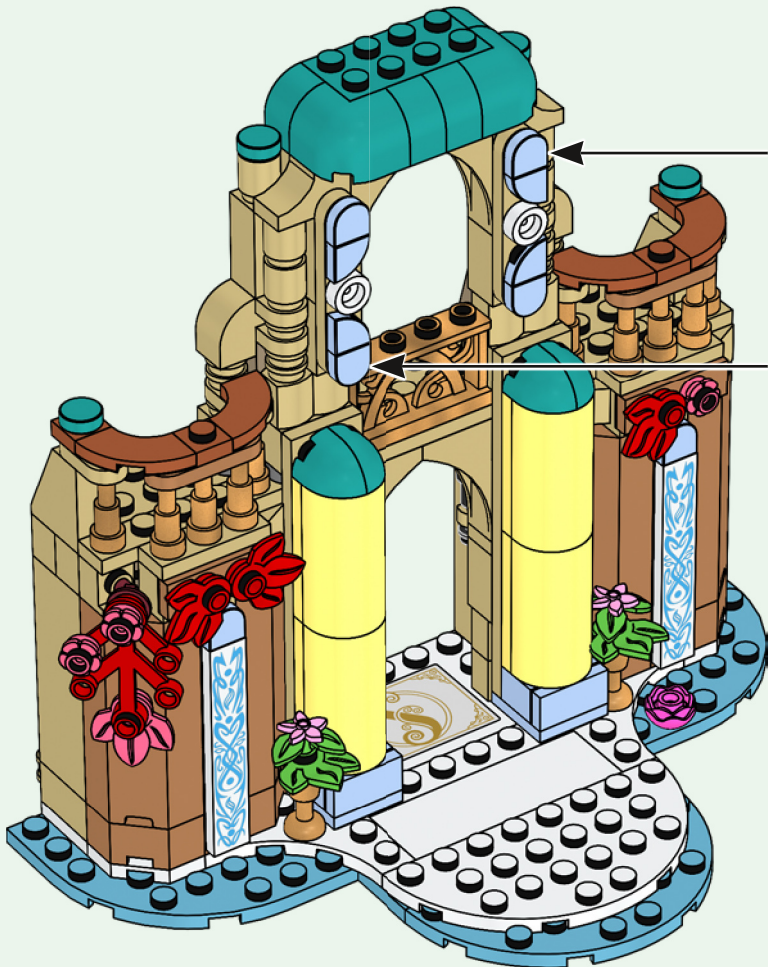
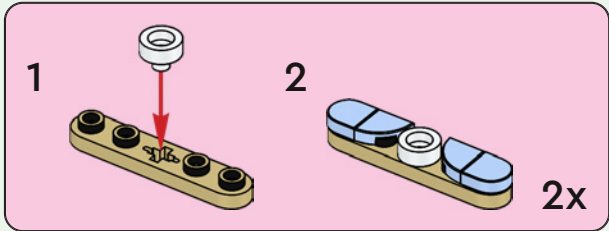





WICKED

75681



75683



75684



75682





1x
306901

4x
302301

1x
6126046

3x
302101

1x
366601

2x
6510452

1x
6332042

1x
4163986

2x
6186681

2x
6176240

2x
6254335

1x
6138699

2x
6357680

2x
6116602

1x
6518025

1x
6518130

2x
6332573

2x
6375684

2x
6271349

2x
6515510

2x
4112980

6x
4218749

2x
4114064

6x
4113915

2x
4124455

10x
4118793

8x
6232135

2x
6214334

2x
6024495

2x
6226564

6x
4117070

3x
4516055

2x
4626200

2x
6383295

2x
6411329

6x
6058093

2x
6352222

12x
4161734

9x
6212758

1x
6512662

2x
4618651

2x
4121921

2x
6311104

2x
4618876

2x
4114309

3x
4124067

2x
4249019

1x
6030980

1x
6172658

3x
6372723

1x
6512663

1x
6527286

2x
4538456

1x
249626

2x
6279875

2x
6503251

2x
6235080

2x
6182261

1x
6510386

4x
6186012

4x
6340042

1x
6512372

1x
6223655

1x
6247798

1x
6514027

1x
6247792

4x
6519763

4x
6399564

2x
6393823

1x
6338181

4x
6311437

1x
6518095

2x
4653509

3x
6035540

1x
6510194

2x
6514274

1x 4211180
1x 6174229
1x 6268857
4x 4211564
1x 4211414
1x 6284071
2x 6146223
1x 4211469
1x 4211881
2x 4210719
2x 4210633
2x 6221607
1x 6517952
6x 6364352

2x 6097861
2x 6100322
2x 6162894
6x 6372233
4x 6316571
2x 6510453
1x 6134285
1x 6513737
1x 4550359
1x 6381793
1x 6498748
2x 6517936
2x 6096990
1x 6519761

1x 6510390
1x 6097234
2x 4505990
10x 4538126
1x 6510628
1x 6514024
1x 6247800
2x 6057986
4x 6469952
2x 6292145
2x 6492538
4x 6499103

1x 6500671
1x 6518131
1x 6510448
1x 6070757
2x 6253666
1x 6138571
2x 6133693
4x 6301838
4x 6296524

1x 6223598
1x 6518152
1x 6023826
3x 6295242
1x 6375789

1x 6519762



 [LEGO.com/service](https://www.LEGO.com/service)

YOU COULD **WIN**



Scan this QR code or go to
LEGO.COM/PRODUCTFEEDBACK and give us
your short feedback about this LEGO® set for a
chance to win a cool LEGO prize.

Terms and Conditions apply*

EN: YOU COULD WIN. Terms and Conditions apply* **DE: Du könntest GEWINNEN.** Es gelten die Teilnahmebedingungen* **FR: Tu pourrais GAGNER.** Des conditions s'appliquent* **IT: Potresti VINCERE tu.** Termini e condizioni sono applicabili* **ES: Puedes GANAR.** Aplican términos y condiciones* **PT: Poderá GANHAR.** Aplicam-se termos e condições* **ZH: 轻松获奖. 条款和条件适用*** **PL: Szansa na WYGRANĄ.** Obowiązują warunki korzystania* **CS: Máte šanci VYHRÁT.** Platí všeobecné smluvní podmínky* **SK: Máte šancu VYHRAŤ.** Platia všeobecné zmluvné podmienky* **HU: TE IS NYERHETSZ.** Felhasználási feltételek érvényesek* **RO: Ai putea CÂȘTIGA.** Se aplică termeni și condiții* **BG: Можете да СПЕЧЕЛИТЕ.** Има определени правила и условия* **LV: Tu vari LAIMĒT.** Ir spēkā noteikumi un nosacījumi.* **ET: Sul on võimalus VÕITA.** Kehtivad tingimused* **LT: Jūs galite LAIMĖTI.** Taikomos sąlygos*

*[LEGO.com/productfeedback-terms](https://www.lego.com/productfeedback-terms)

LEGO and the LEGO logo are trademarks of the/son des marques de commerce du/son marcas registradas de LEGO Group. ©2024 The LEGO Group.

© Universal City Studios LLC. All Rights Reserved.