



# SCOOBY-DOO!

75902



[LEGO.com/scoobydoo](https://www.LEGO.com/scoobydoo)





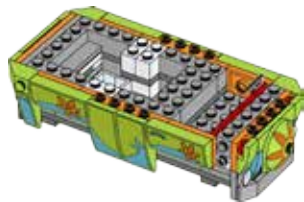

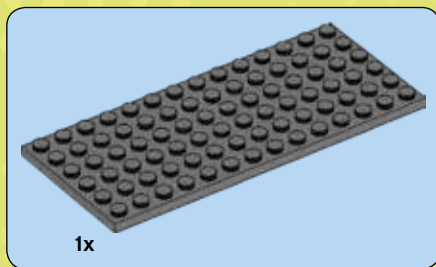

1

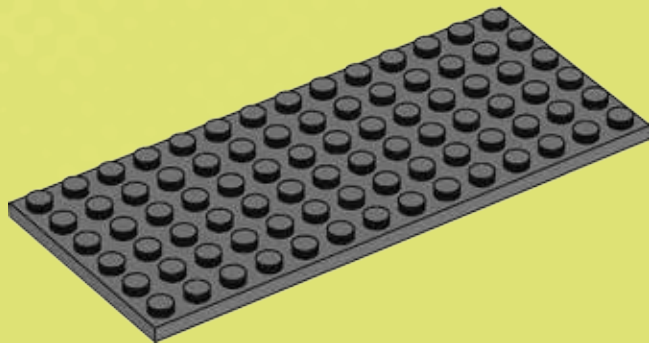



2

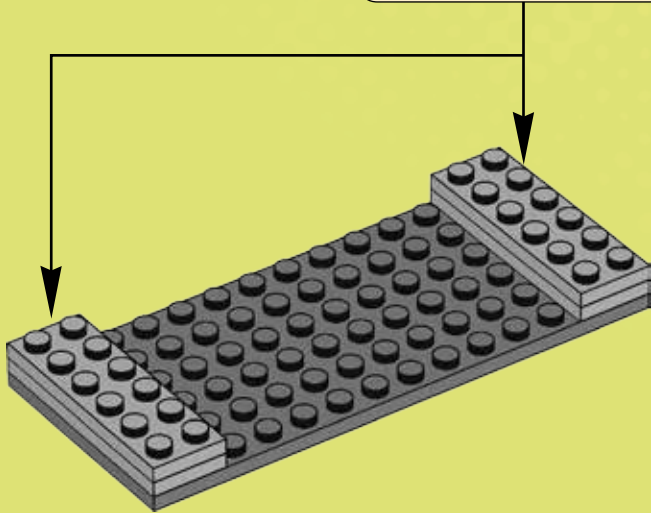
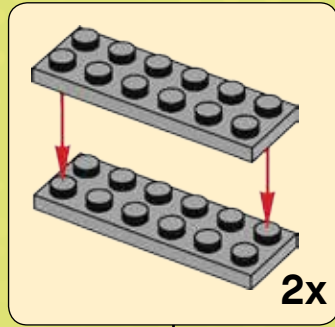



2x

3

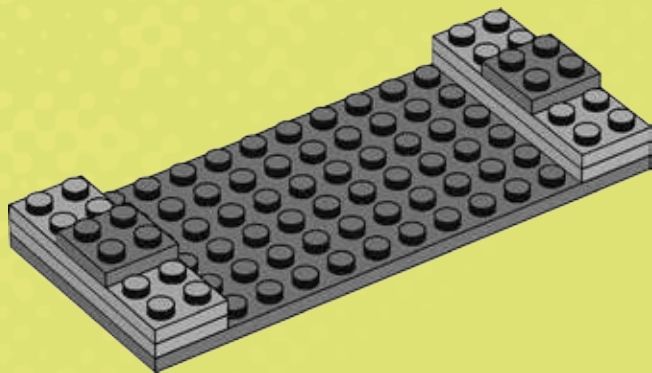



4x

4

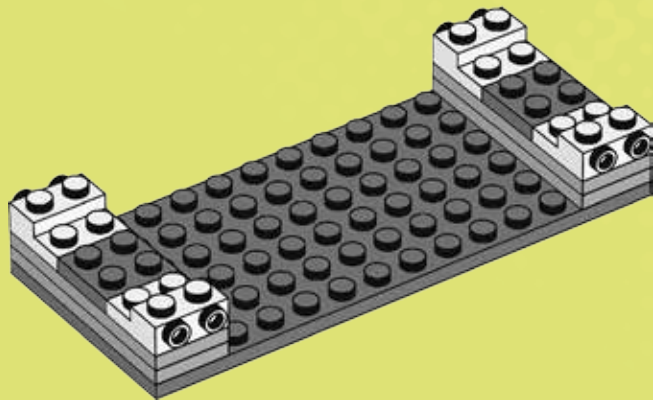



2x

5

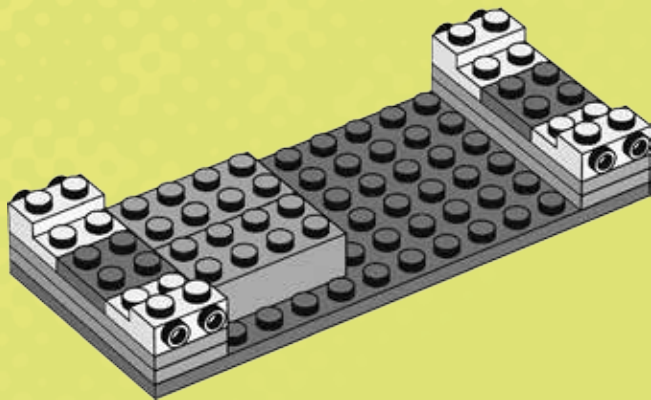

8



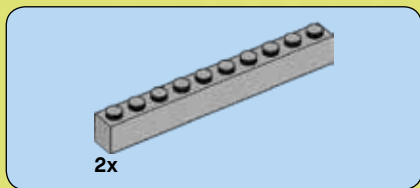

6

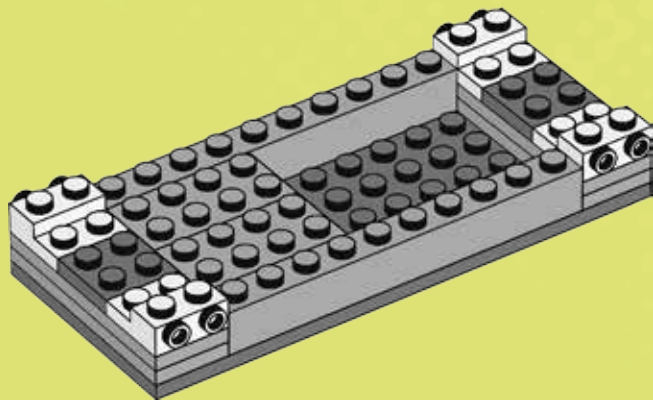



4x

7

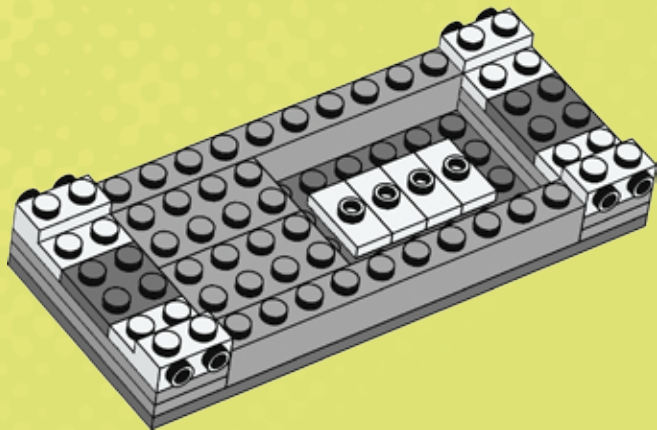



2x

8

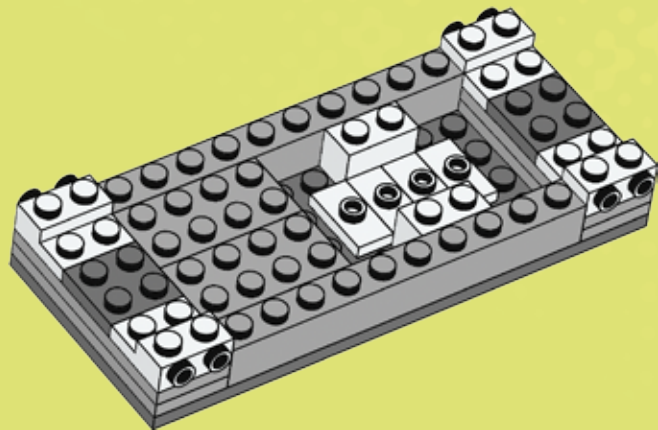



1x



2x

9

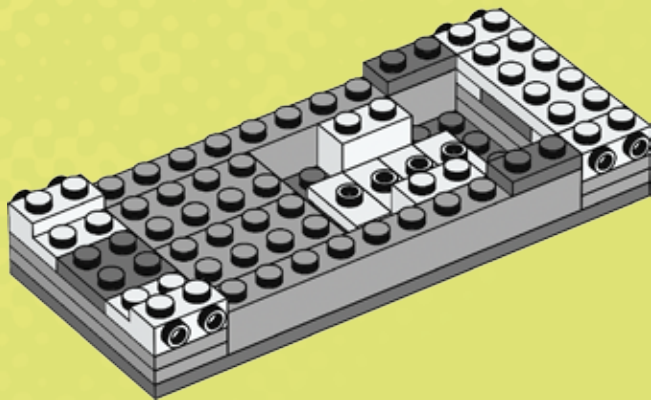



2x



2x

# 10

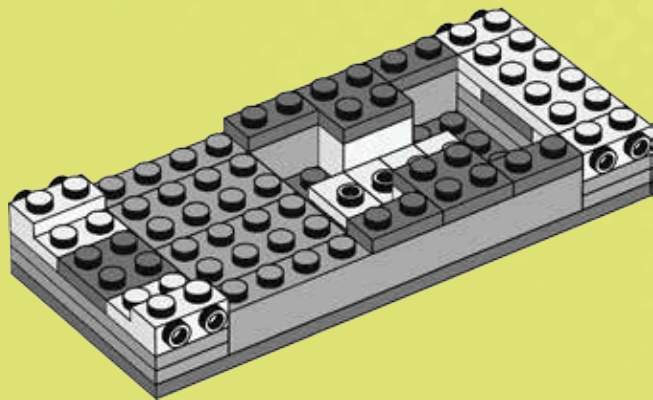



2x



1x

# 11

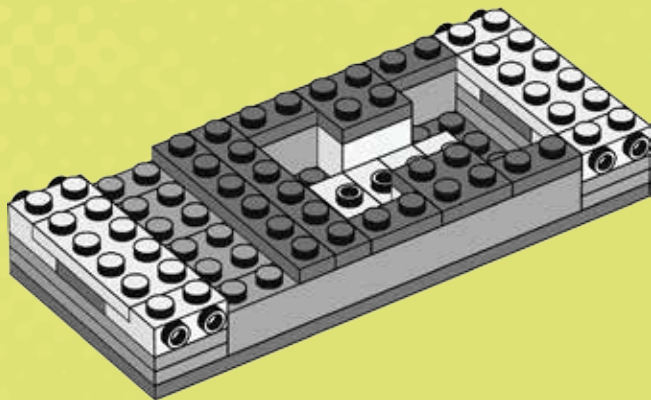

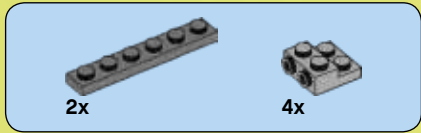

12

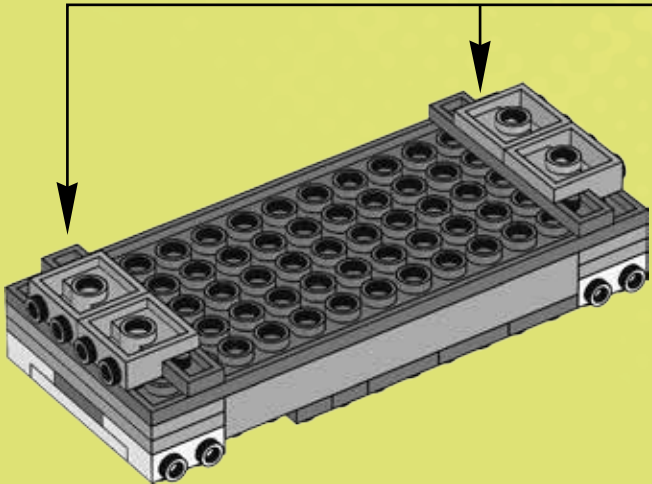
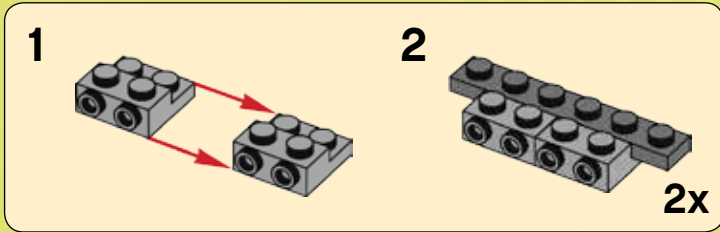



1x



1x

# 13

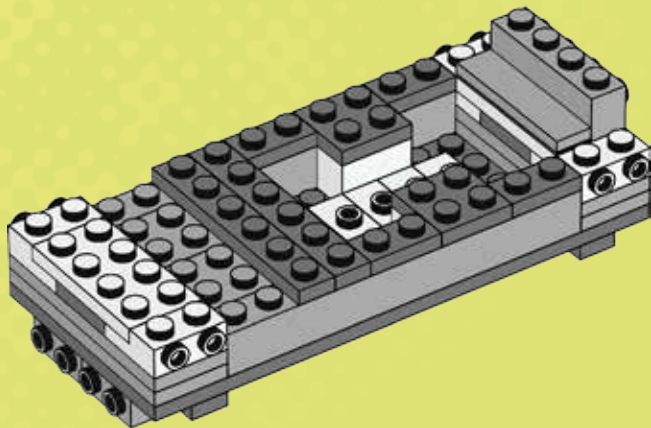





2x

# 14

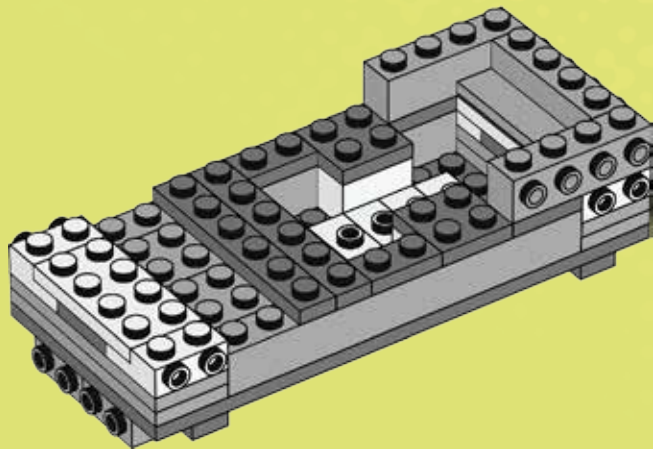



3x



2x

# 15

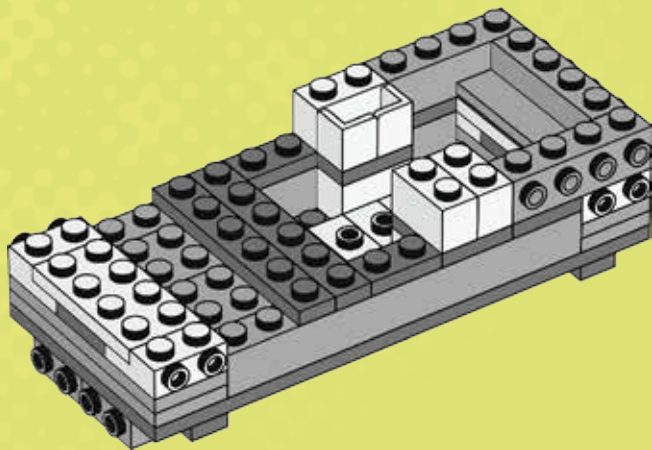



1x



2x

# 16

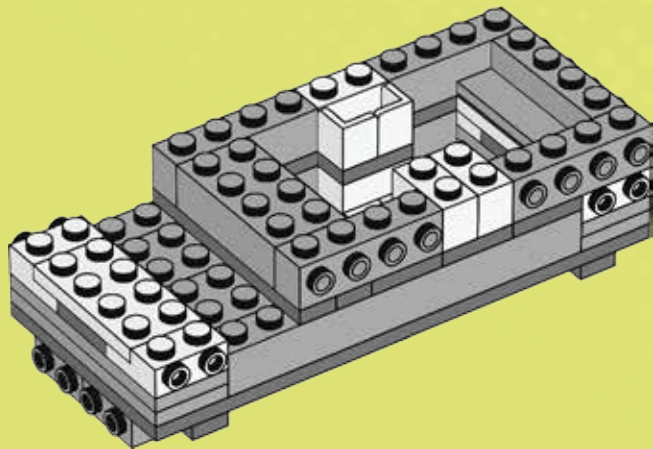



1x



1x

# 17

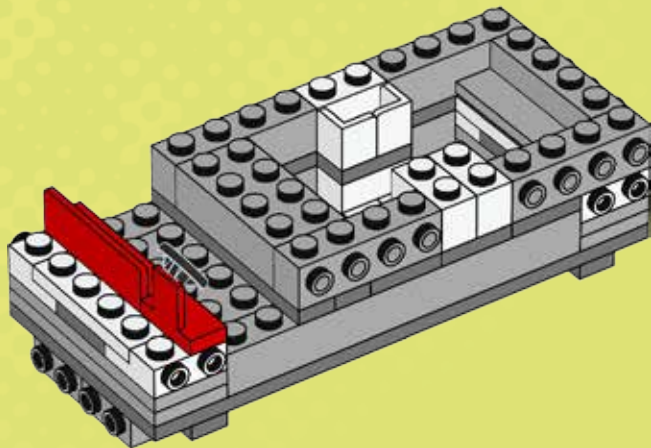



1x



2x

# 18

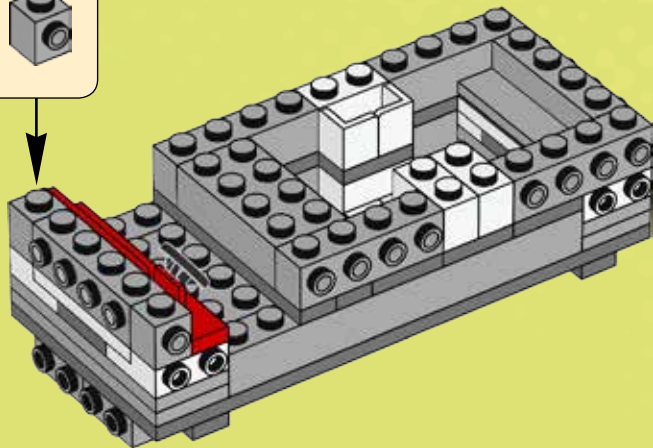

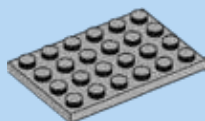

1x

1



1x

2

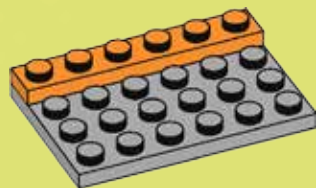

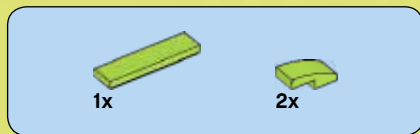

3



4

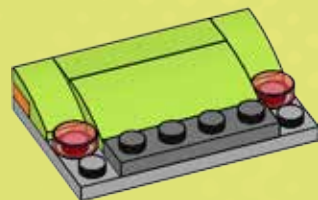



1x



2x

5

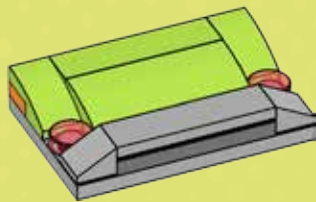



19

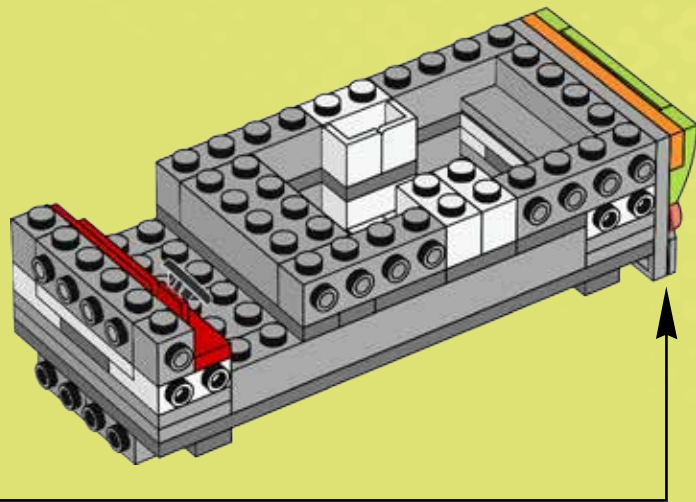

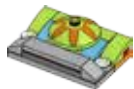

1x

1



4x



1x

2





1x



2x

3

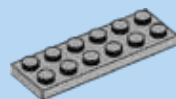
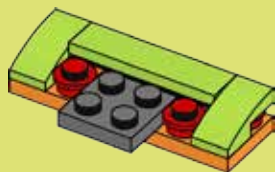

1x

4





2x



2x

5



1x



1x



1x

6

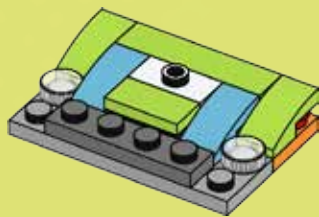

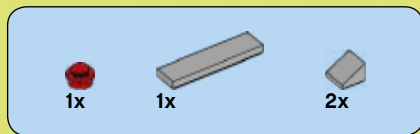

7

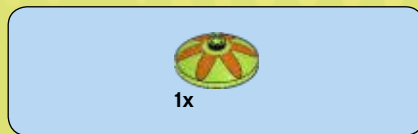
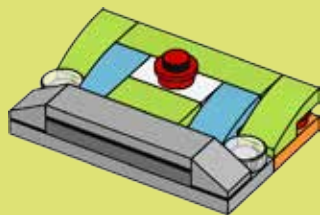

8

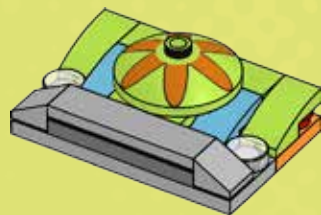

20

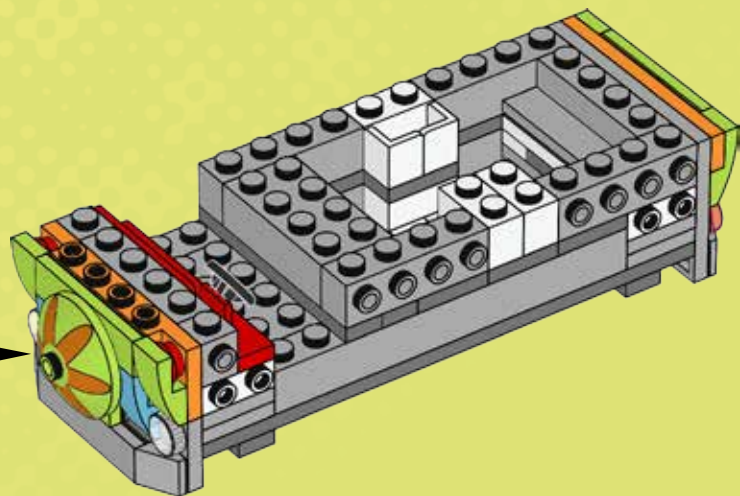

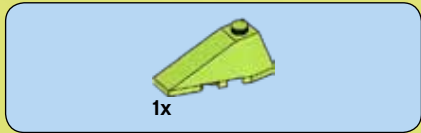

21

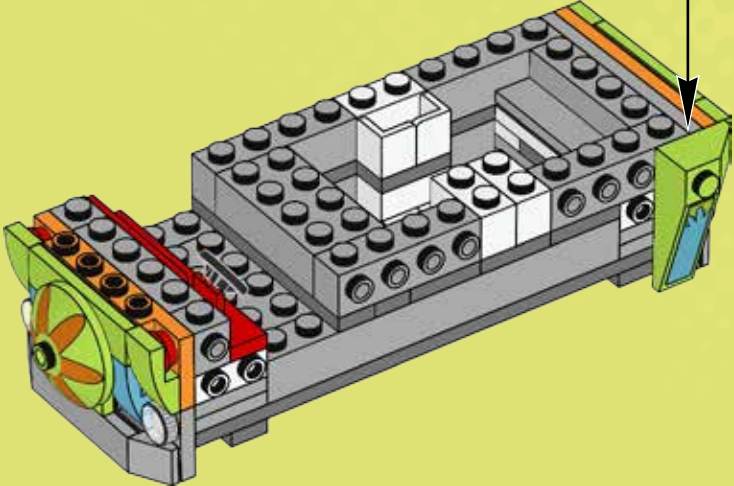
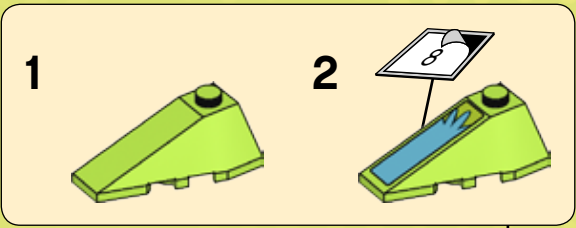

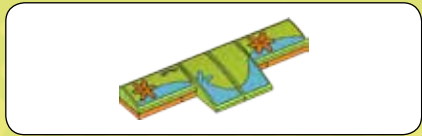

1

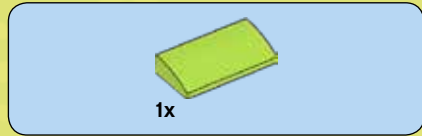

2

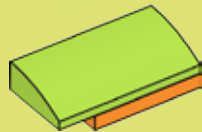





1x

3

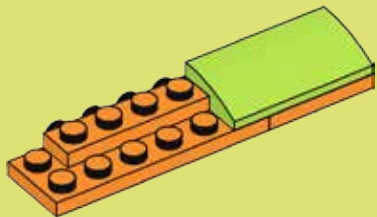

2x

4

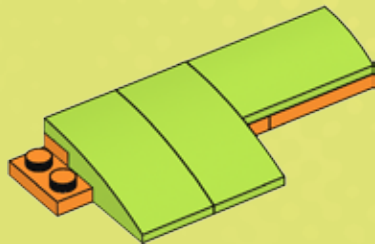



1x

5

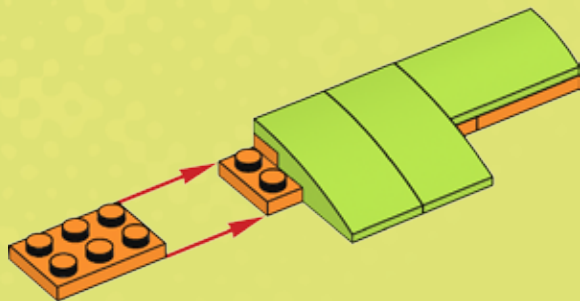

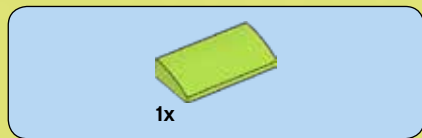

6

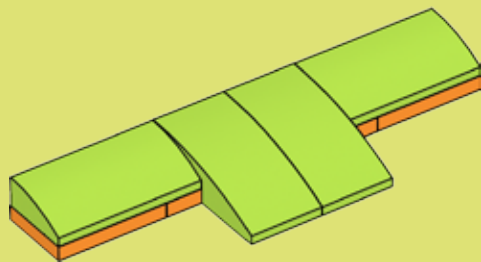

7

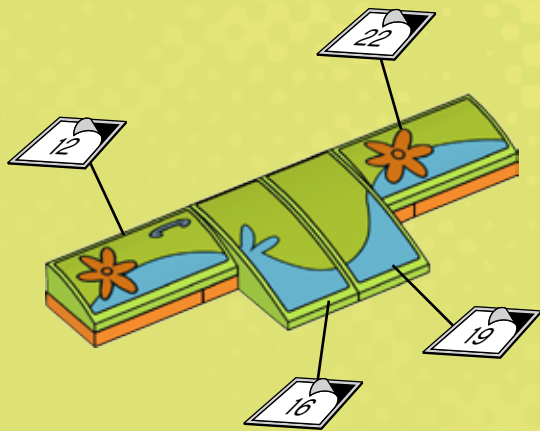

22

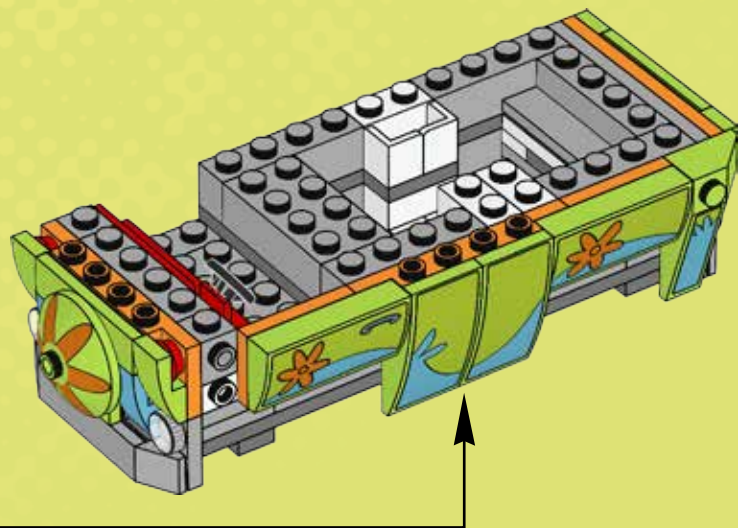



1x

# 23

1

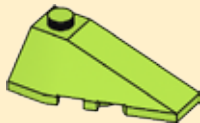

2

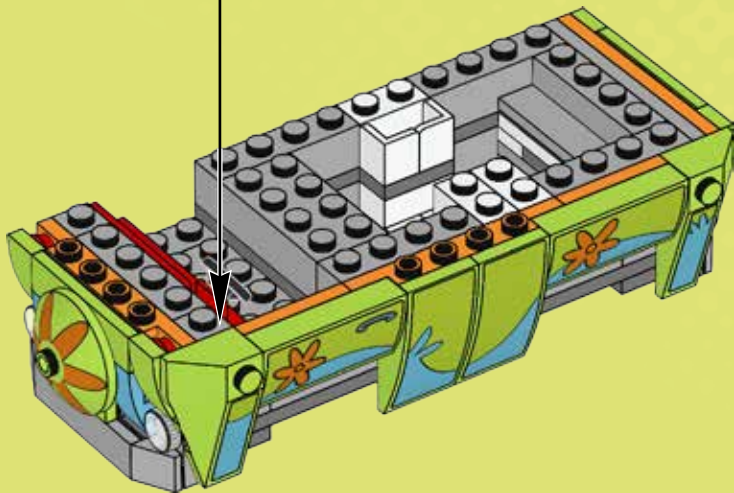



1x

24



1

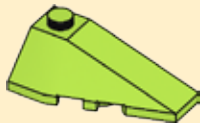

2

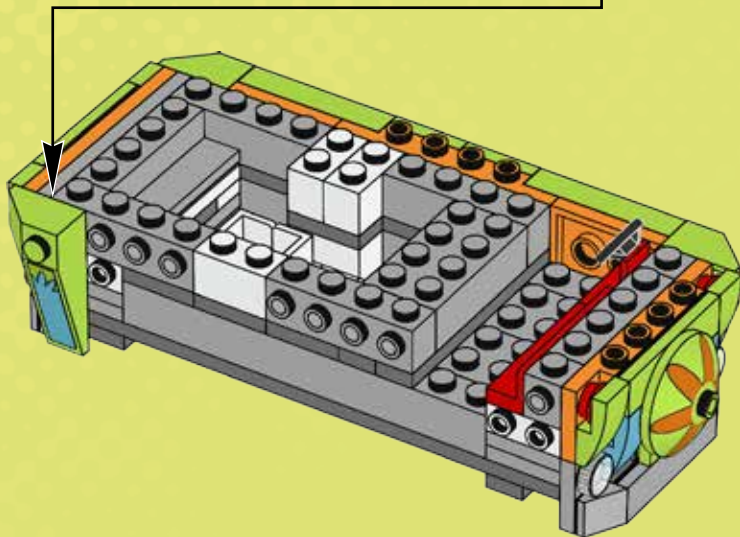
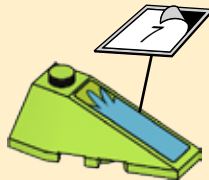

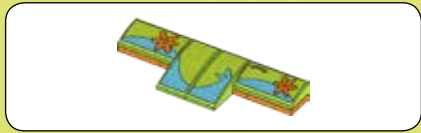

1x

1

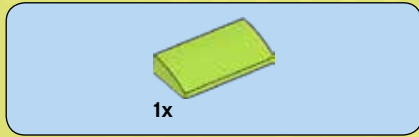

1x

2





1x

3

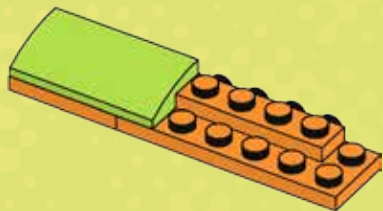

2x

4

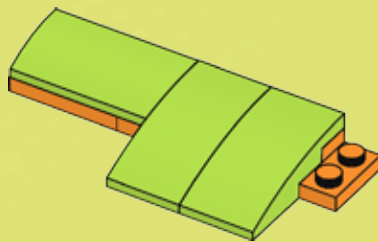





1x

5

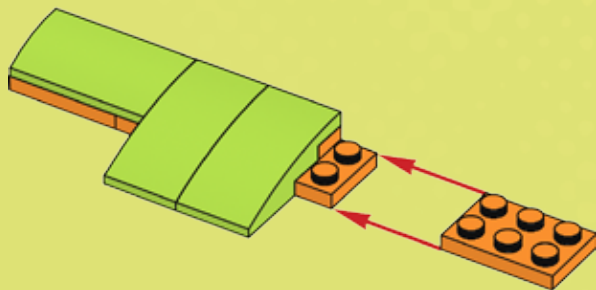

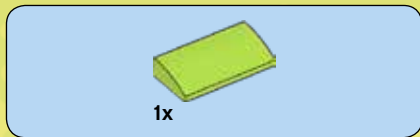

6

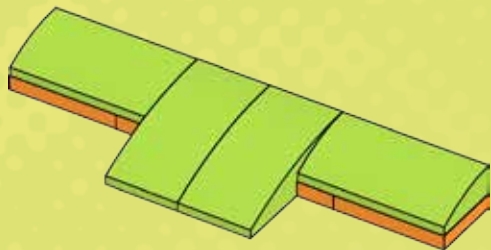

7

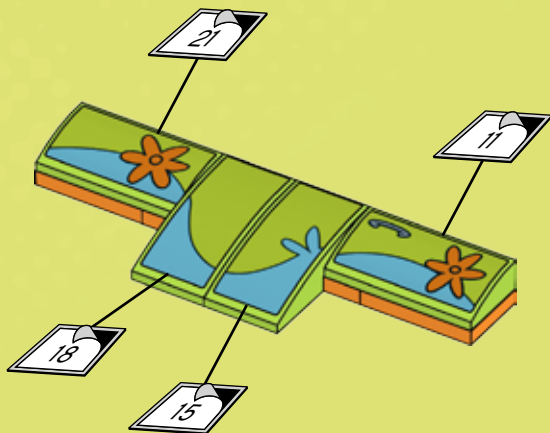

25

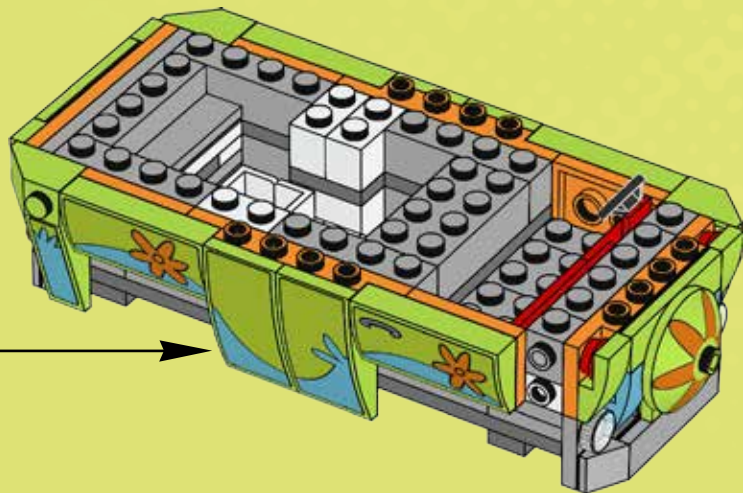

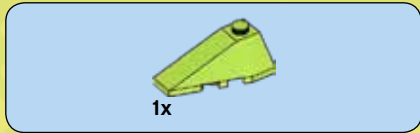

26

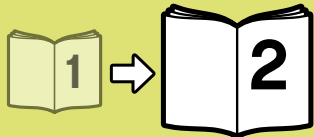
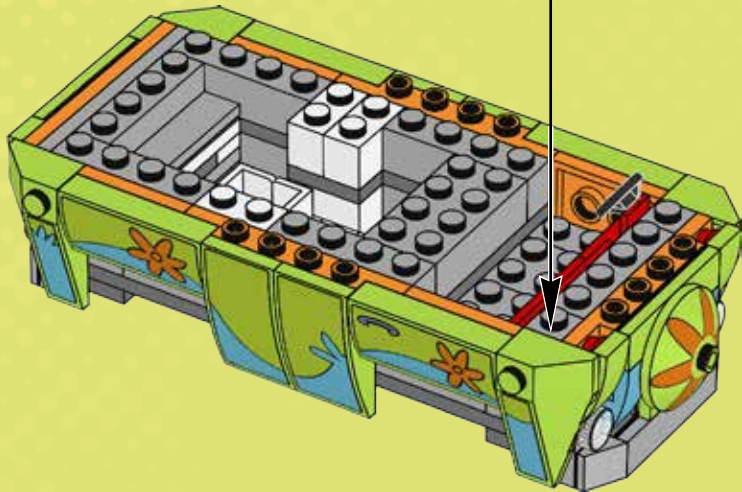
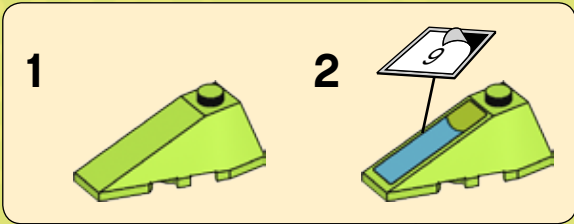



# SCOOBY-DOO!

WE'VE GOT A MYSTERY TO SOLVE  
WIR MÜSSEN EIN GEHEIMNIS LÜFTEN  
NOUS AVONS UN MYSTÈRE À RESOLVRE  
TENEMOS UN MISTERIO QUE RESOLVER  
TEMOS UM MISTERIO PARA RESOLVER  
MÁIS VAN EGY MEGOLDÁSRA VÁRO REJTELÝUNK

75900



75901



75902



75903



75904



[LEGO.COM/scoobydoo](http://LEGO.COM/scoobydoo)





*More spooky fun at  
Noch mehr Gruselspaß auf  
Plus d'amusement effrayant sur  
Màs diversión tenebrosa en  
Mais diversão arrepiante em  
További rémisztő móka itt  
**LEGO.com/scoobydoo***

**LEGO** **SCOOBY-DOO!**

Apple, the Apple logo, iPad, iPhone and iPod touch are trademarks of Apple Inc.  
Google Play is a trademark of Google Inc.

ANDROID APP ON  
Google play

Available on the  
App Store

**LEGO**

DC COMICS  
**SUPER  
HEROES**

76034

**SUPER  
JUMPER**



76035



BATMAN and all related characters and elements are trademarks of and © DC Comics.



WB SHIELD: TM & © Warner Bros. Entertainment Inc. (s15)