



# SCOOBY-DOO!

75903



[LEGO.com/scoobydoo](https://www.LEGO.com/scoobydoo)

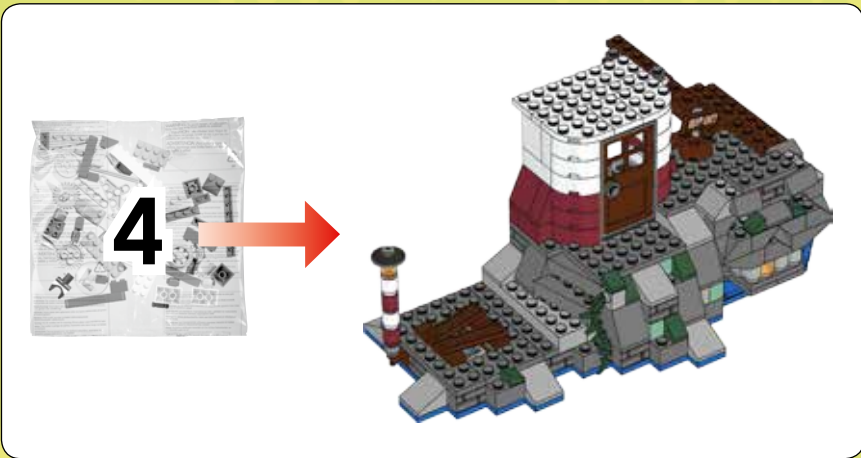

1

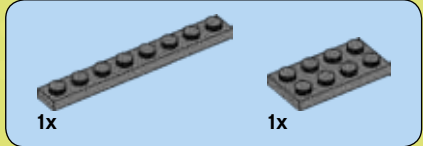
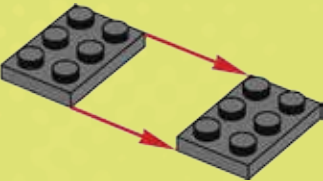

2

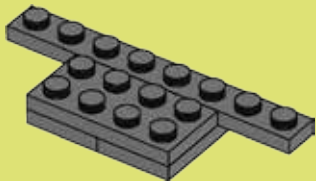

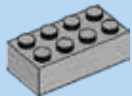

1x

**3**

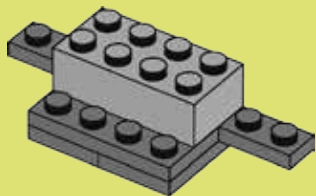

2x

**4**

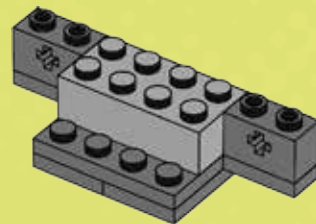



3x



1x

5



1x

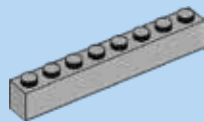

1x

6

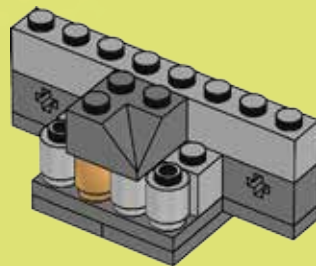

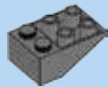

2x

7

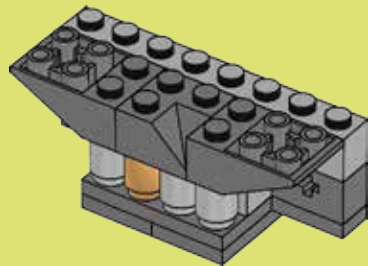

2x



1x

8

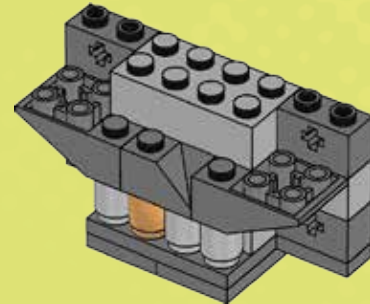







2x



1x

# 11

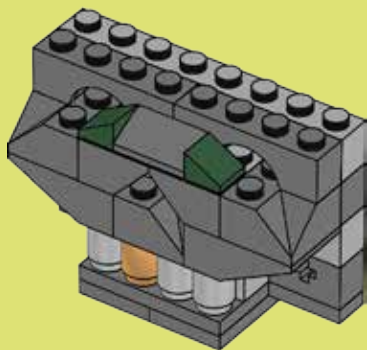

1x



2x

# 12

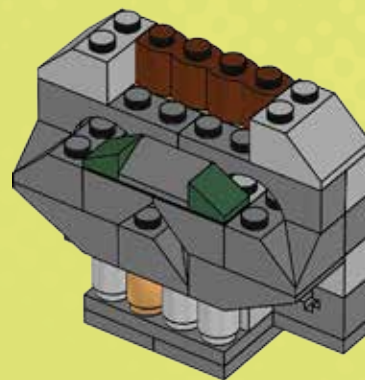



2x



1x

# 13

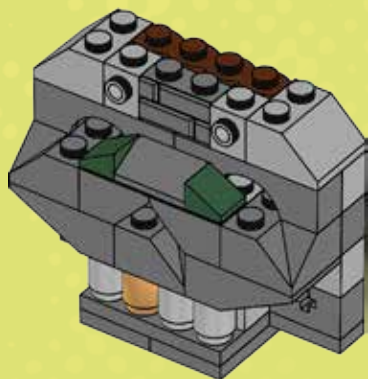

1x



2x

# 14

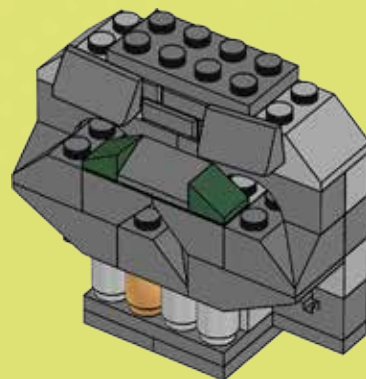



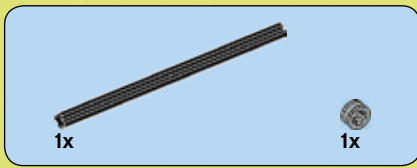

15

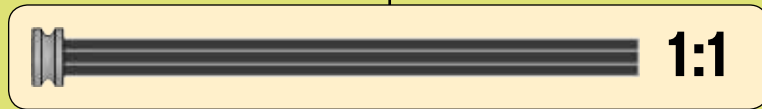
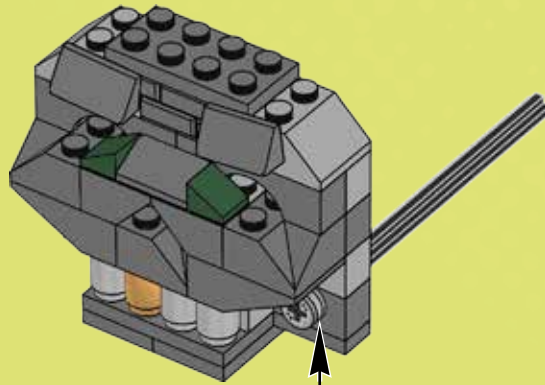

31

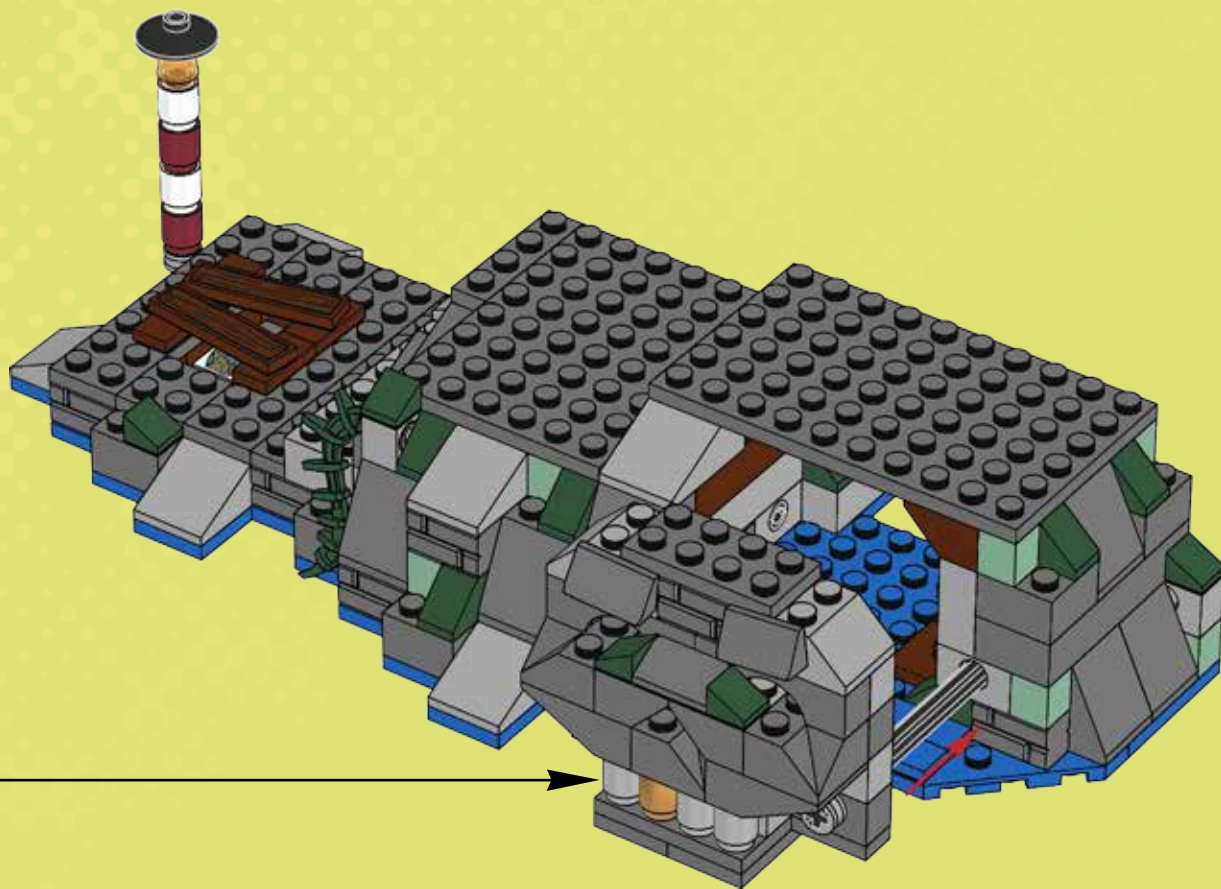



1x

# 32

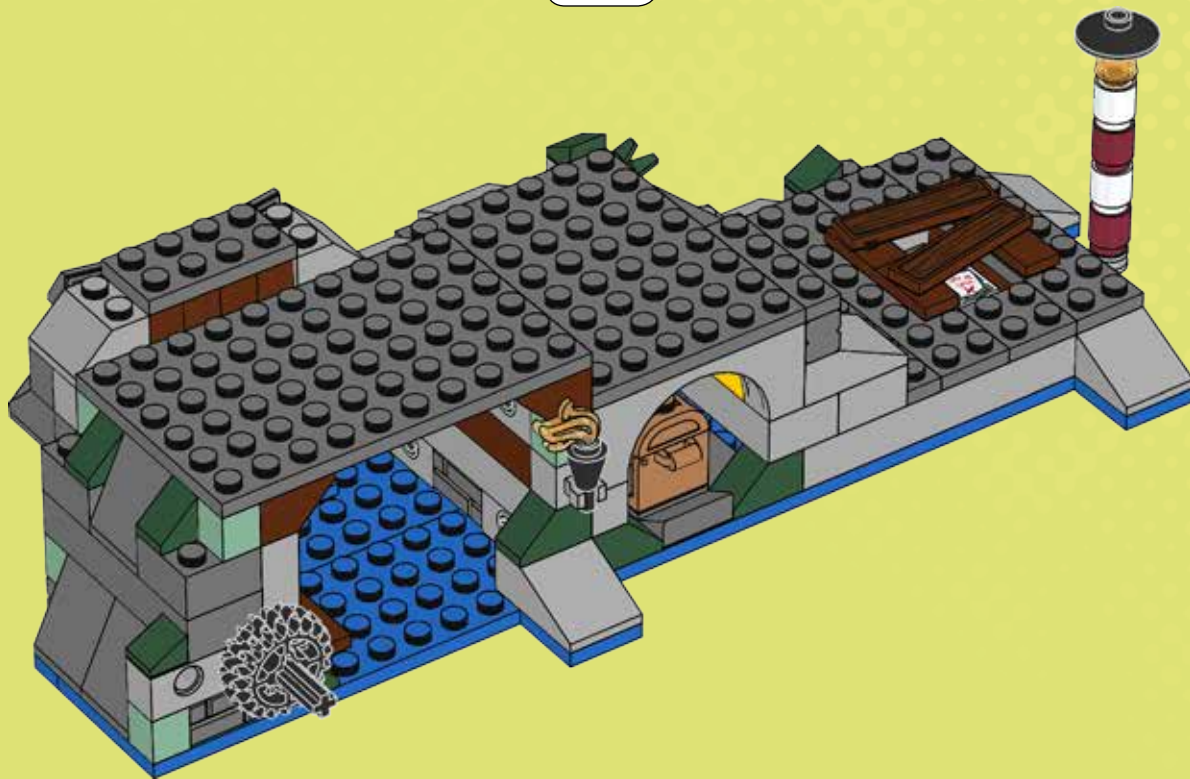
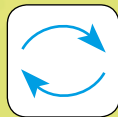



1x



1x

# 33

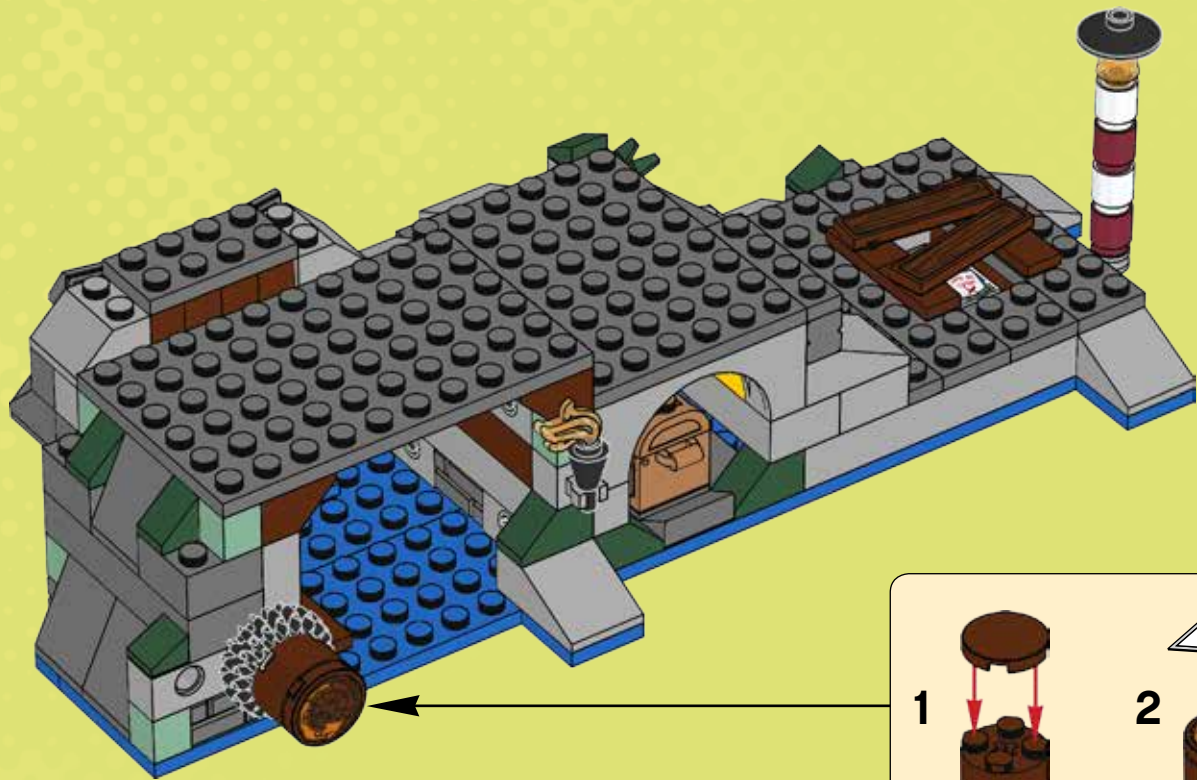

1



2





1x



1x



1x

# 34

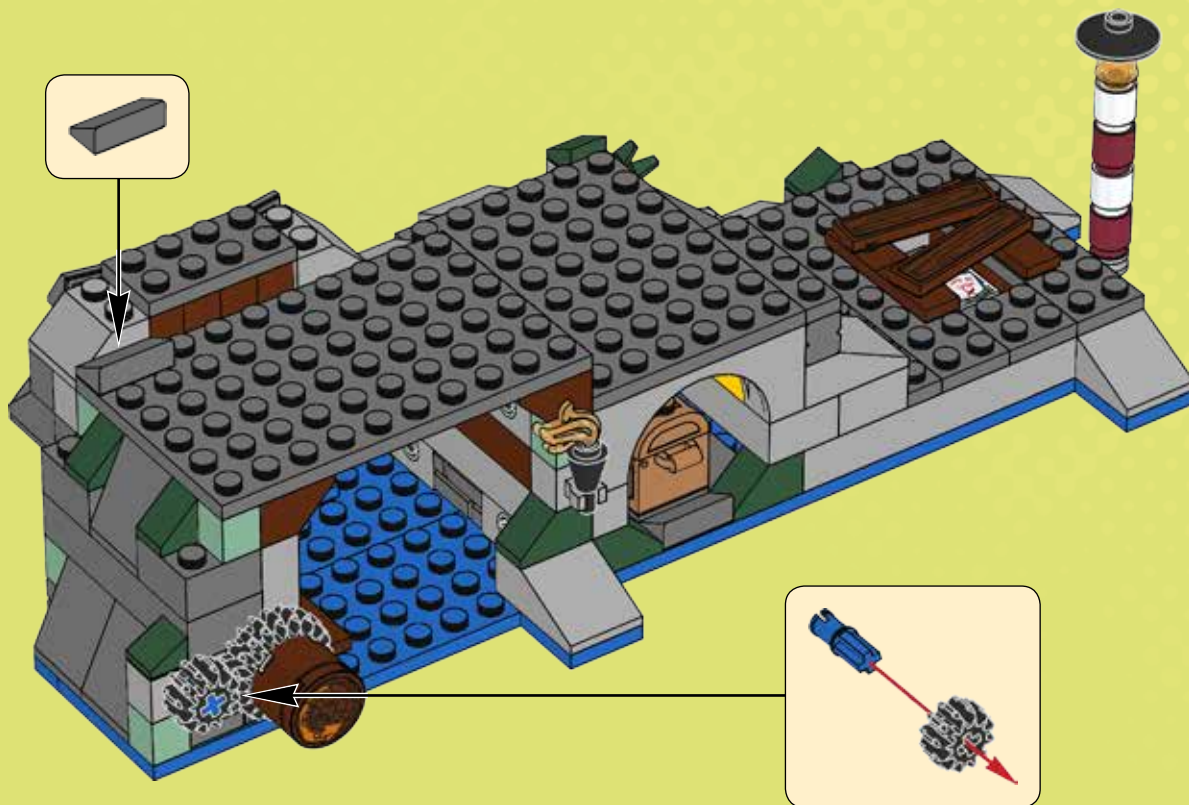



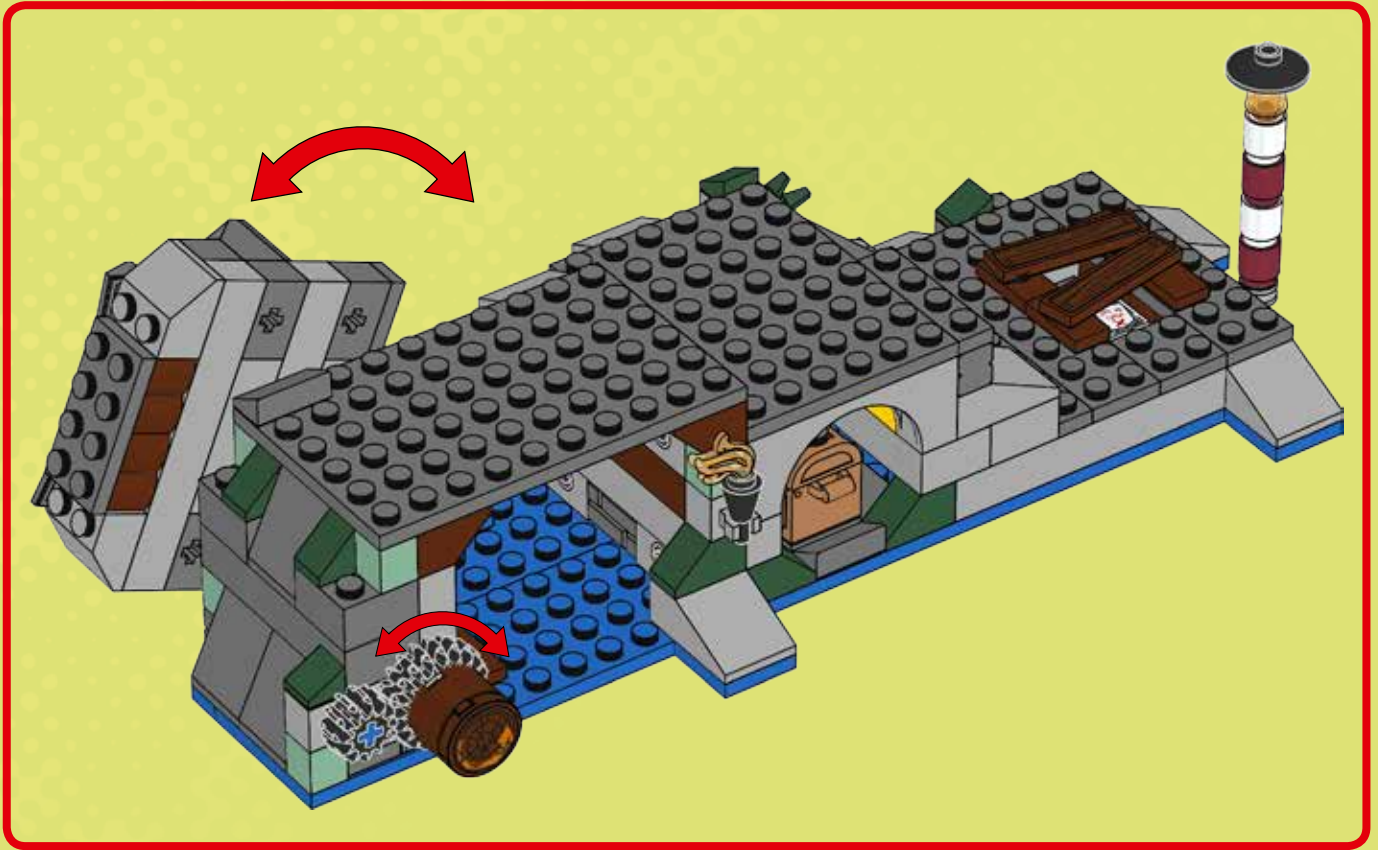



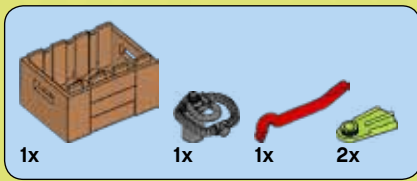

# 35

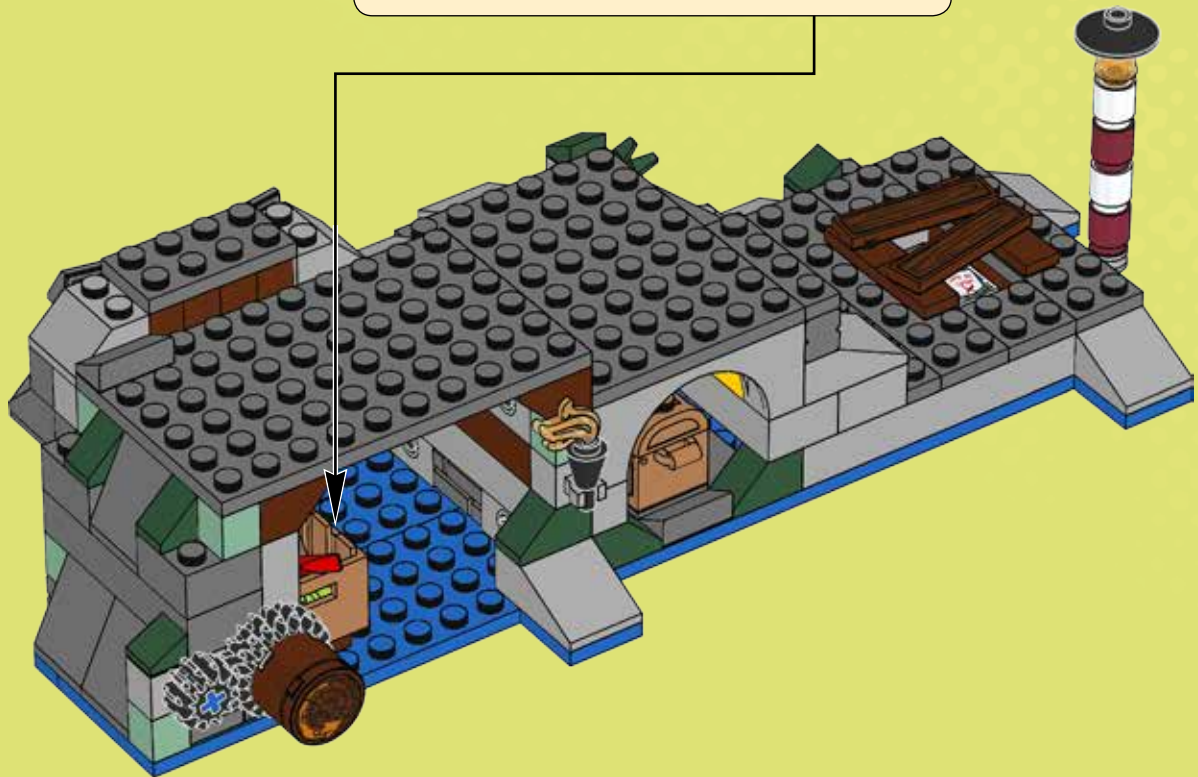
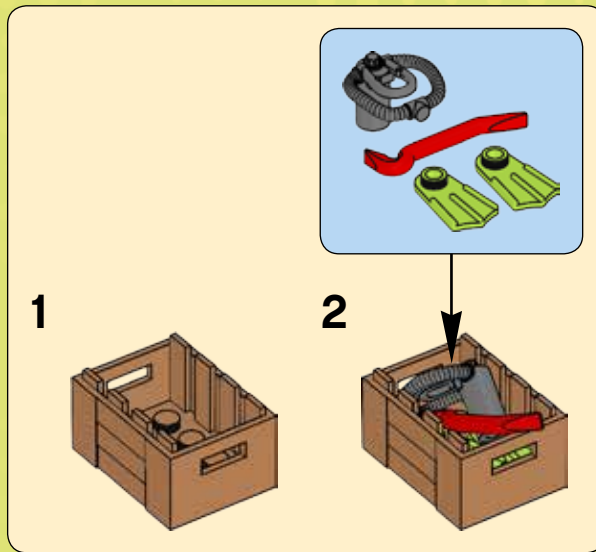



1x



1x

# 36

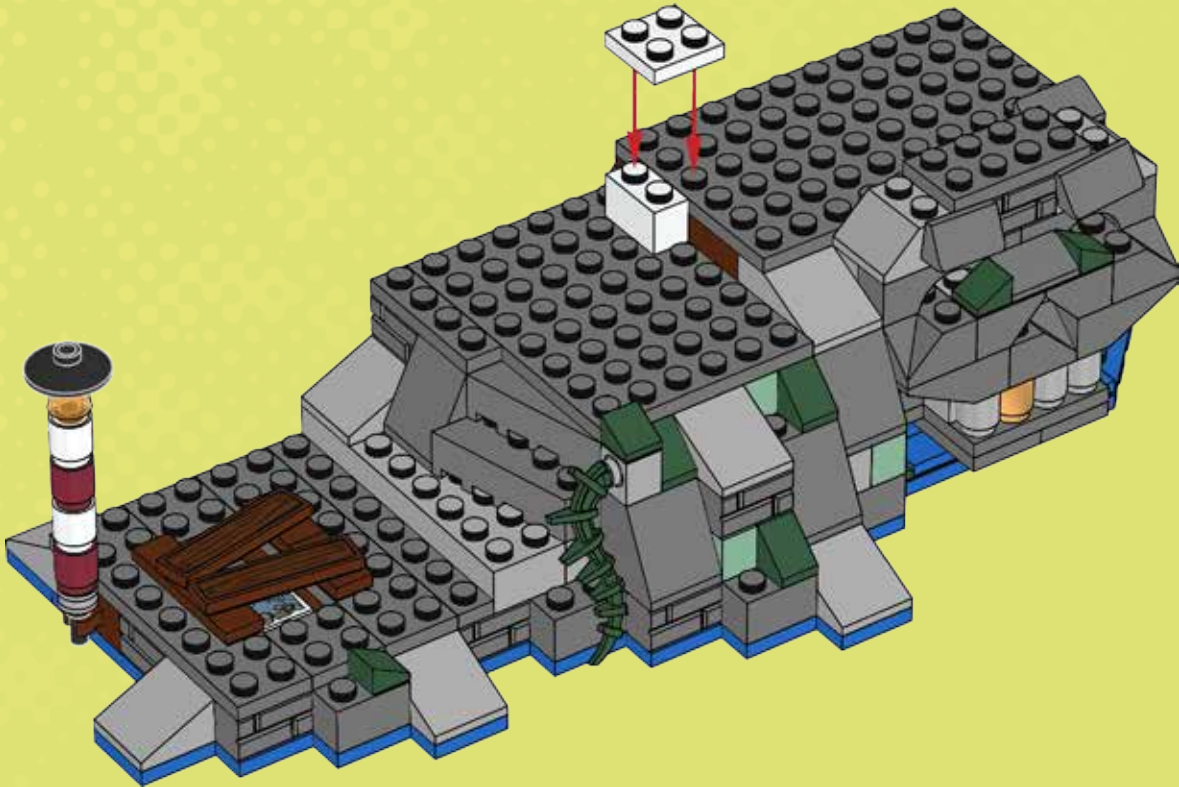
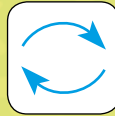



1x



1x

# 37





1x



2x

# 38

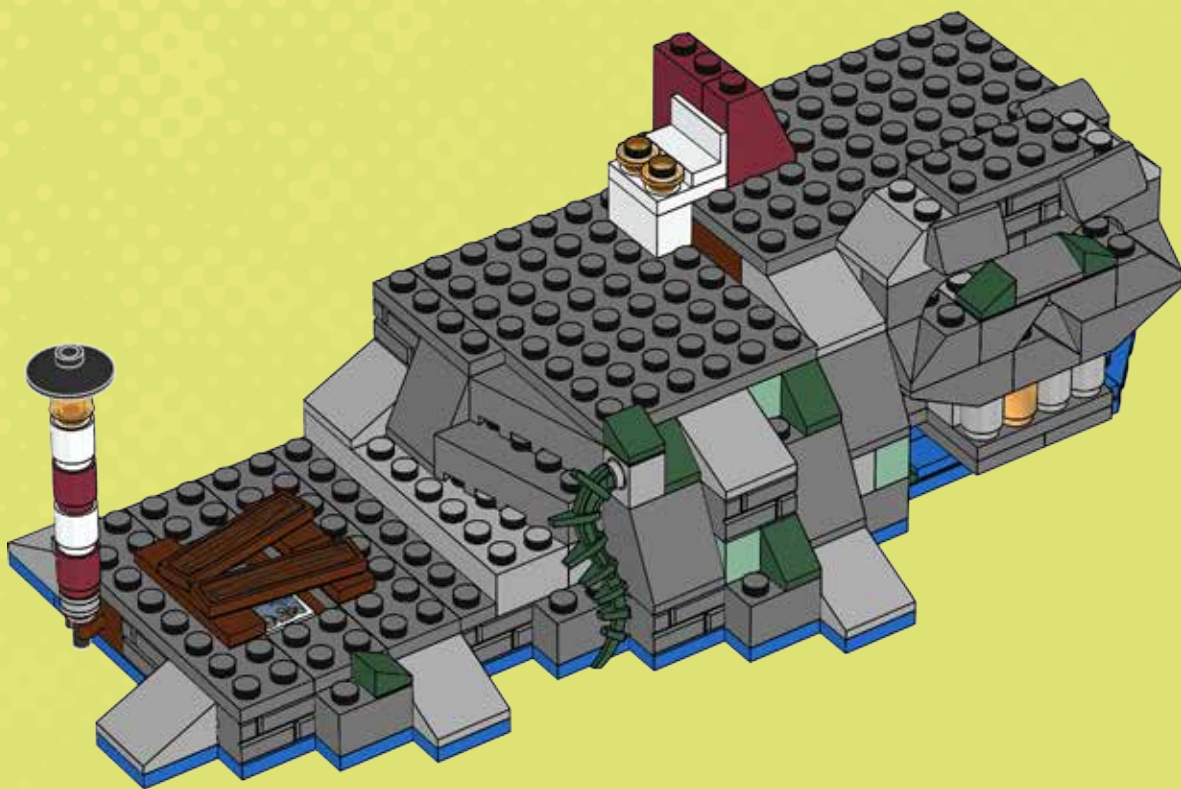



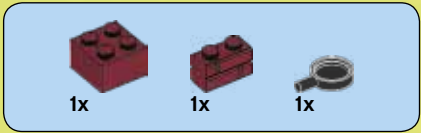

# 39



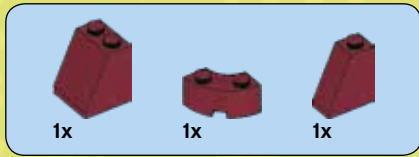

# 40

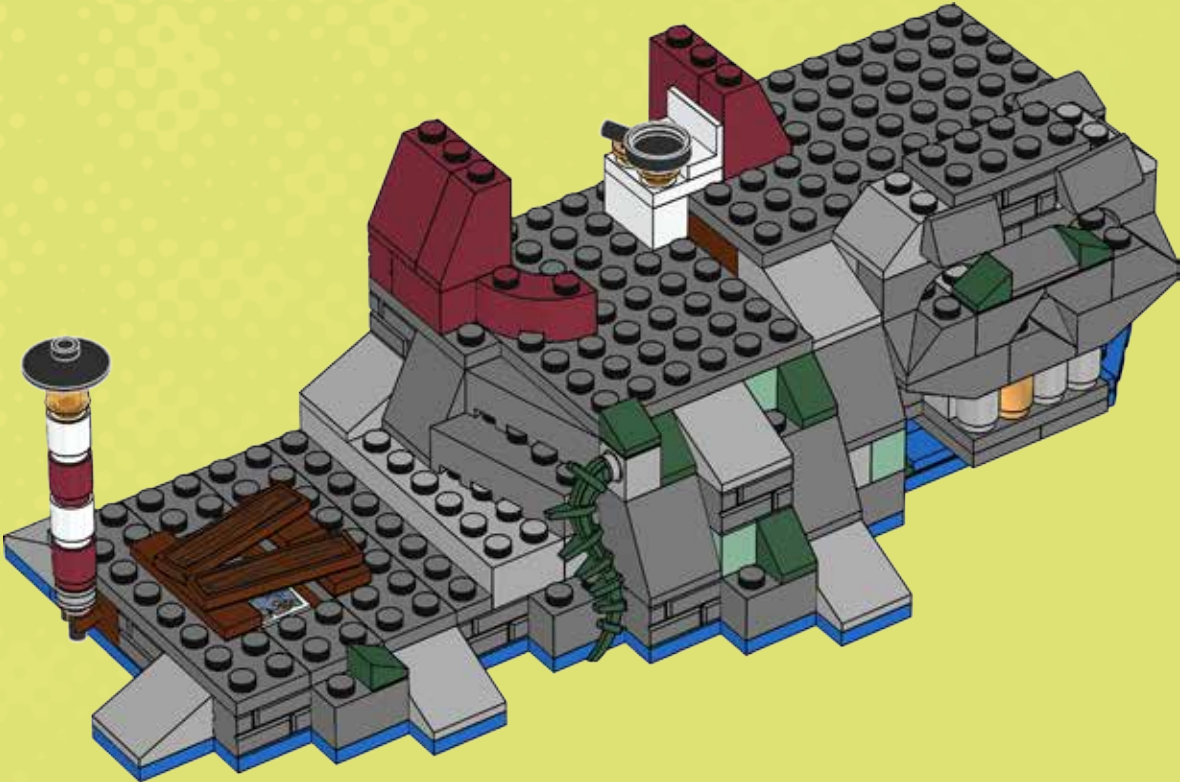





2x

# 41

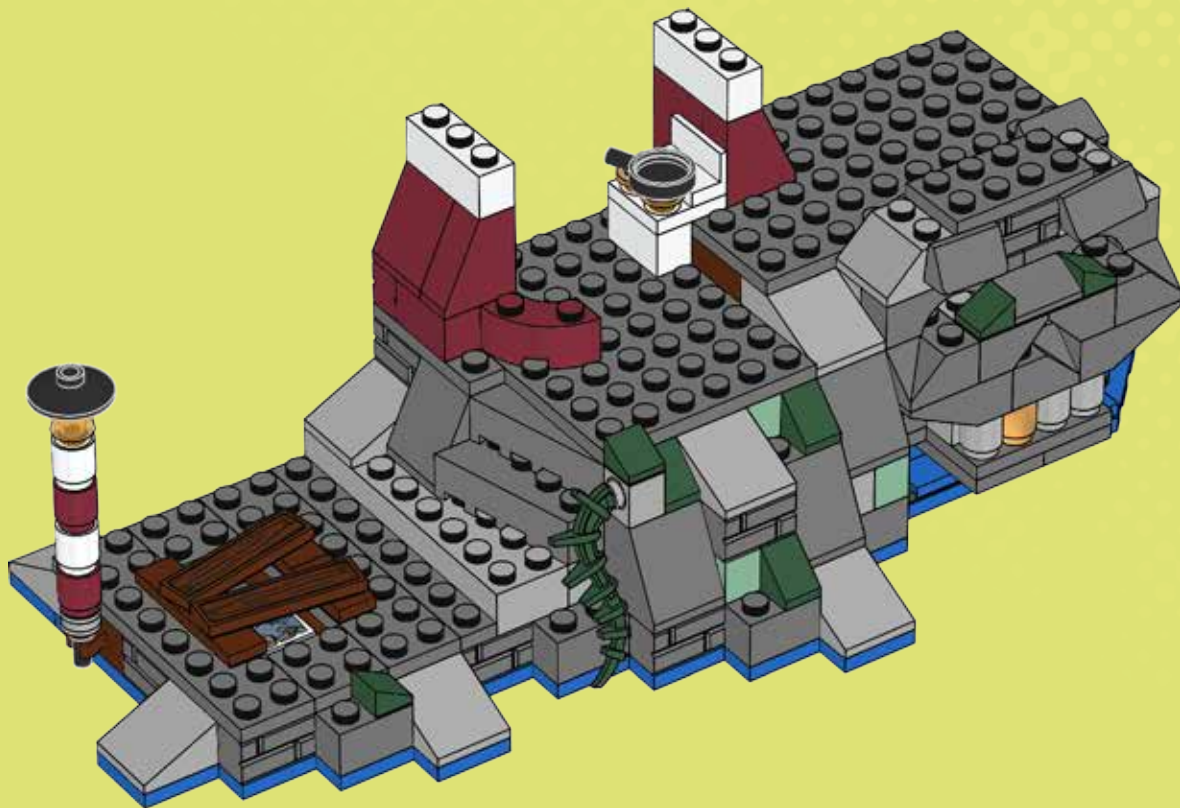



1x



1x



1x

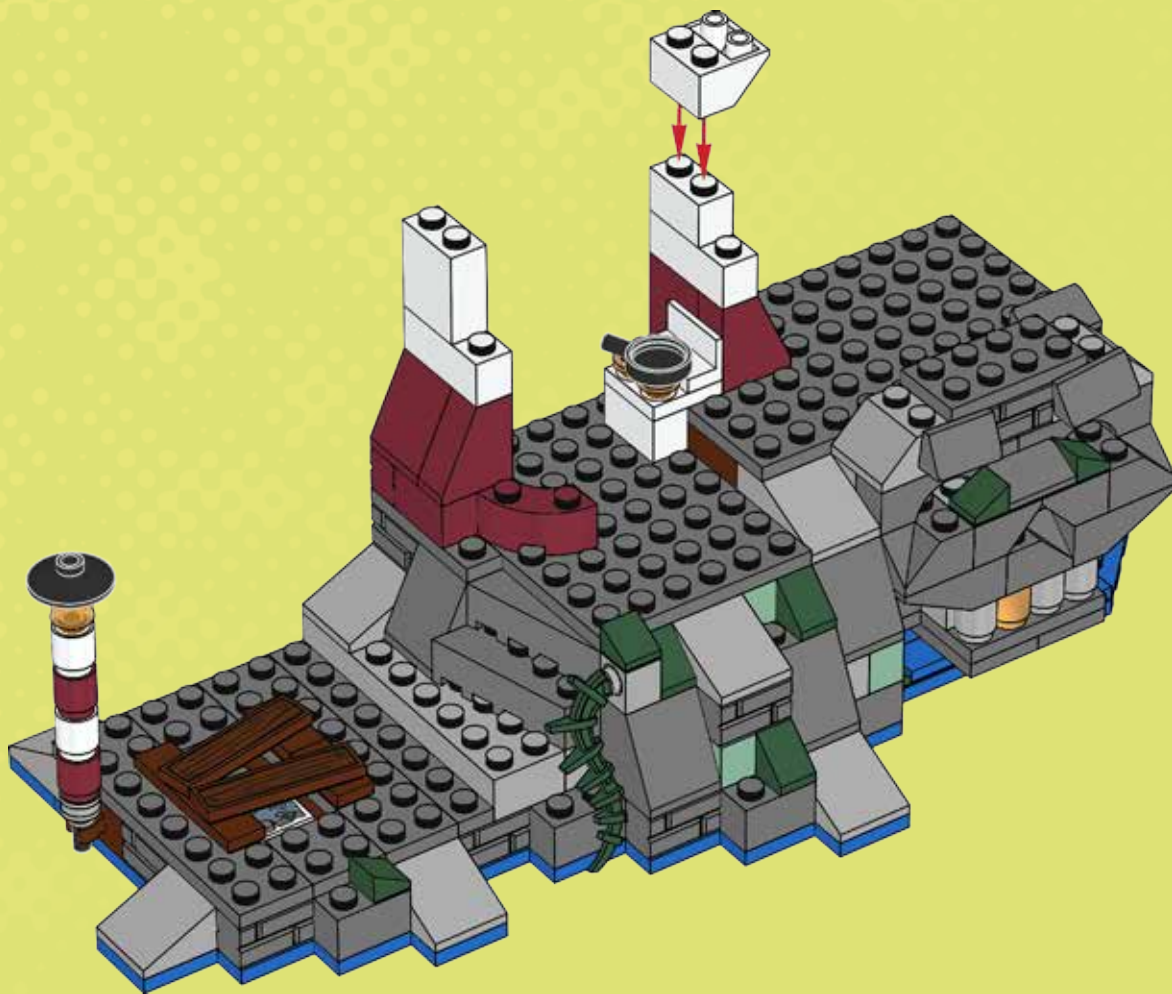

# 42

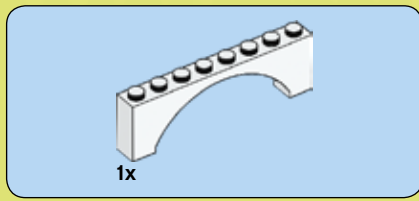

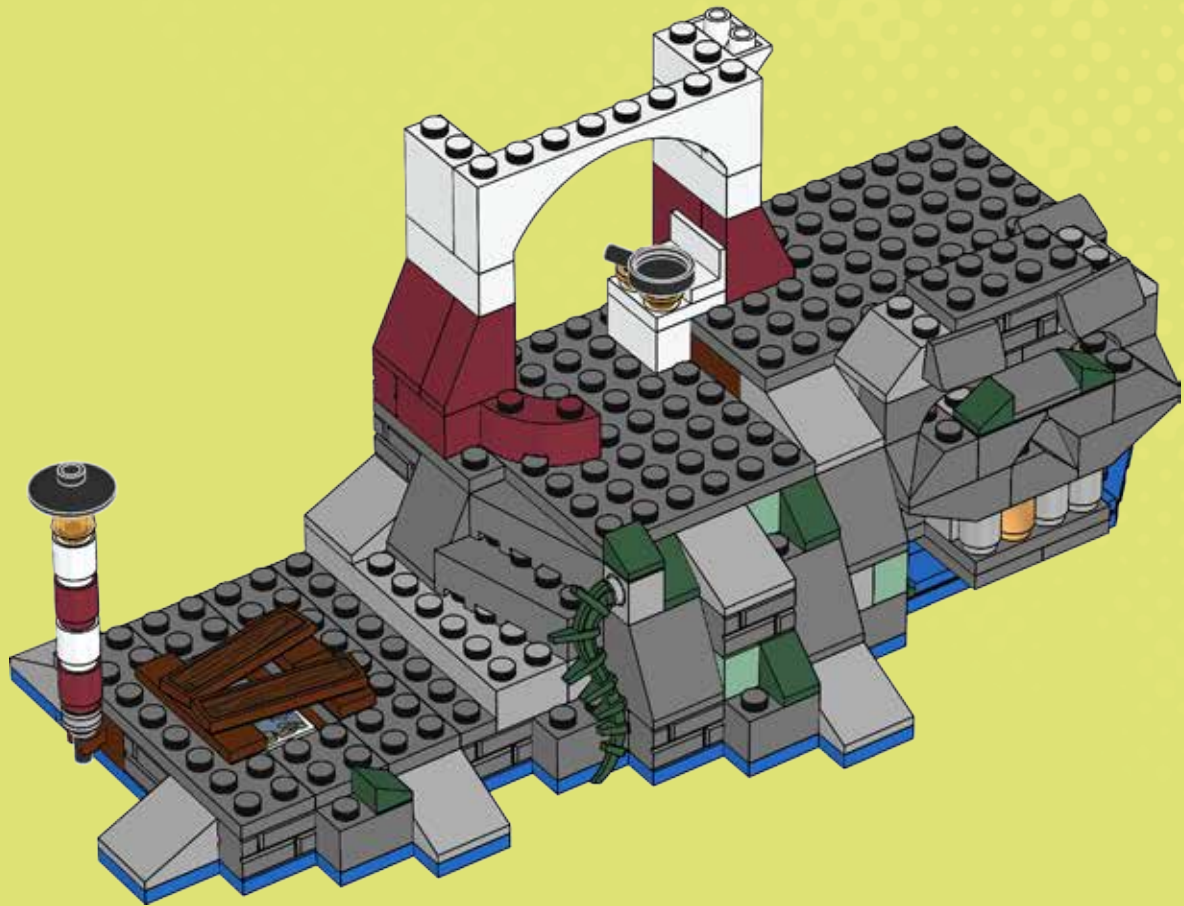

# 43



6x  4x 

44

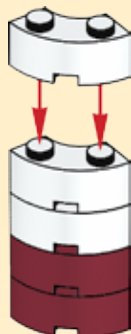
  
2x

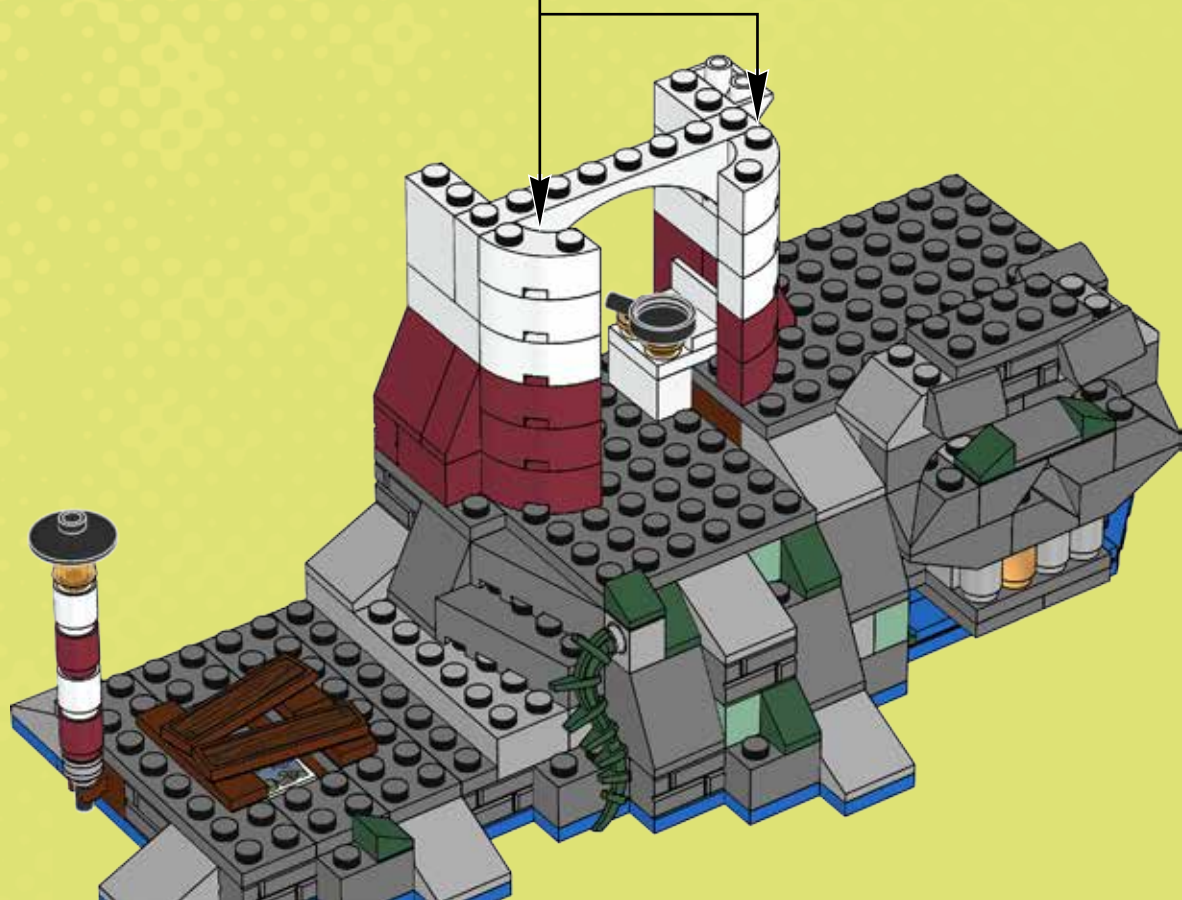



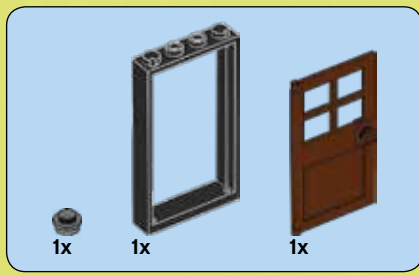

45

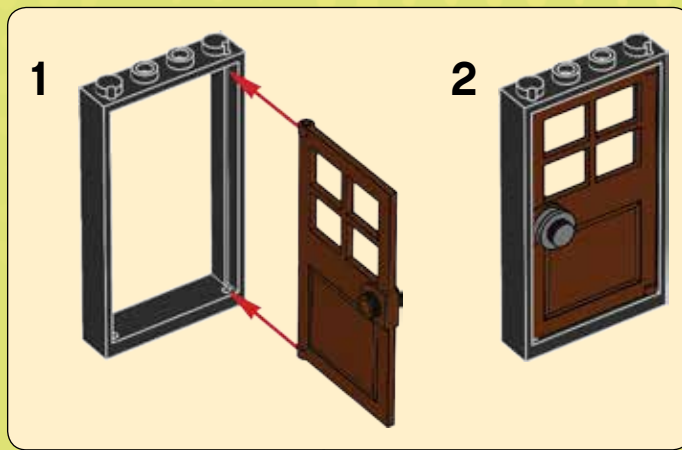



1x

# 46

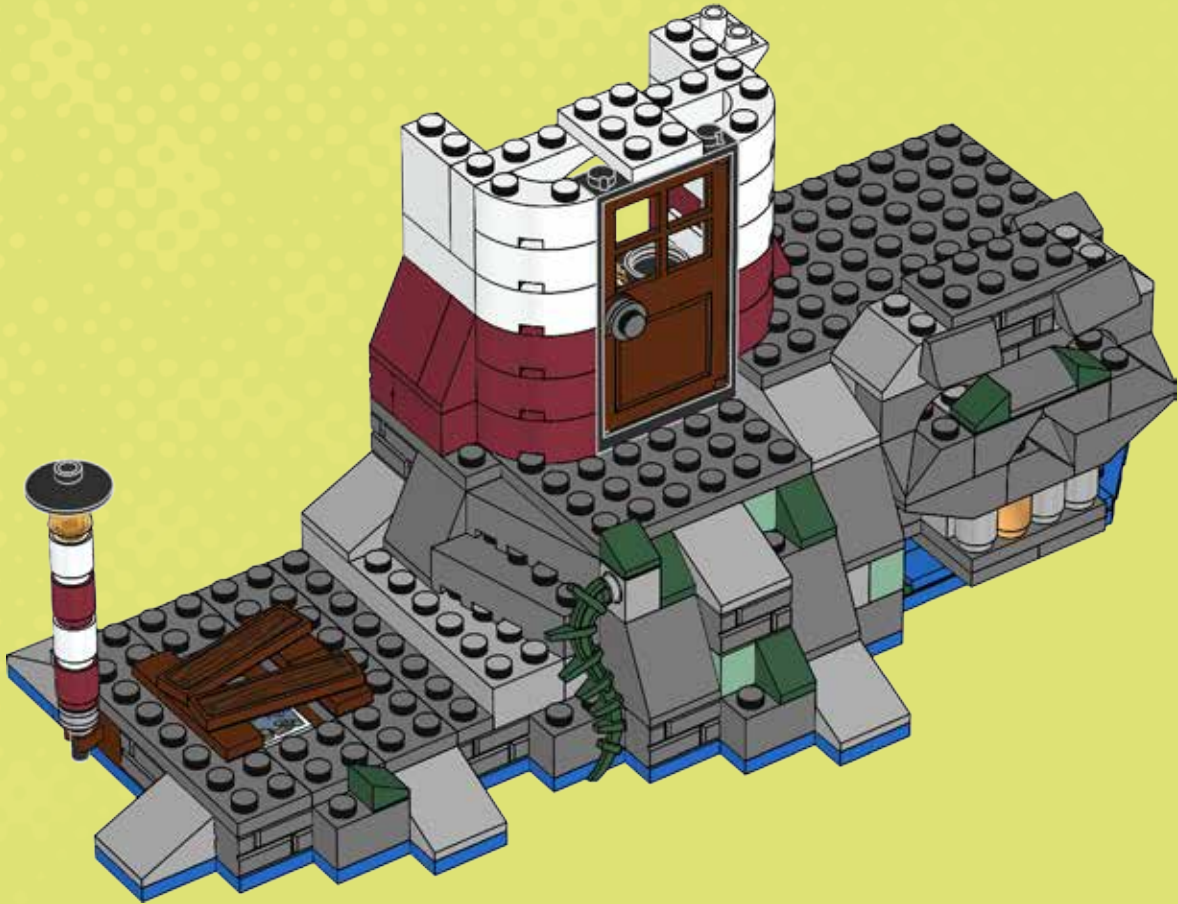





2x

# 47

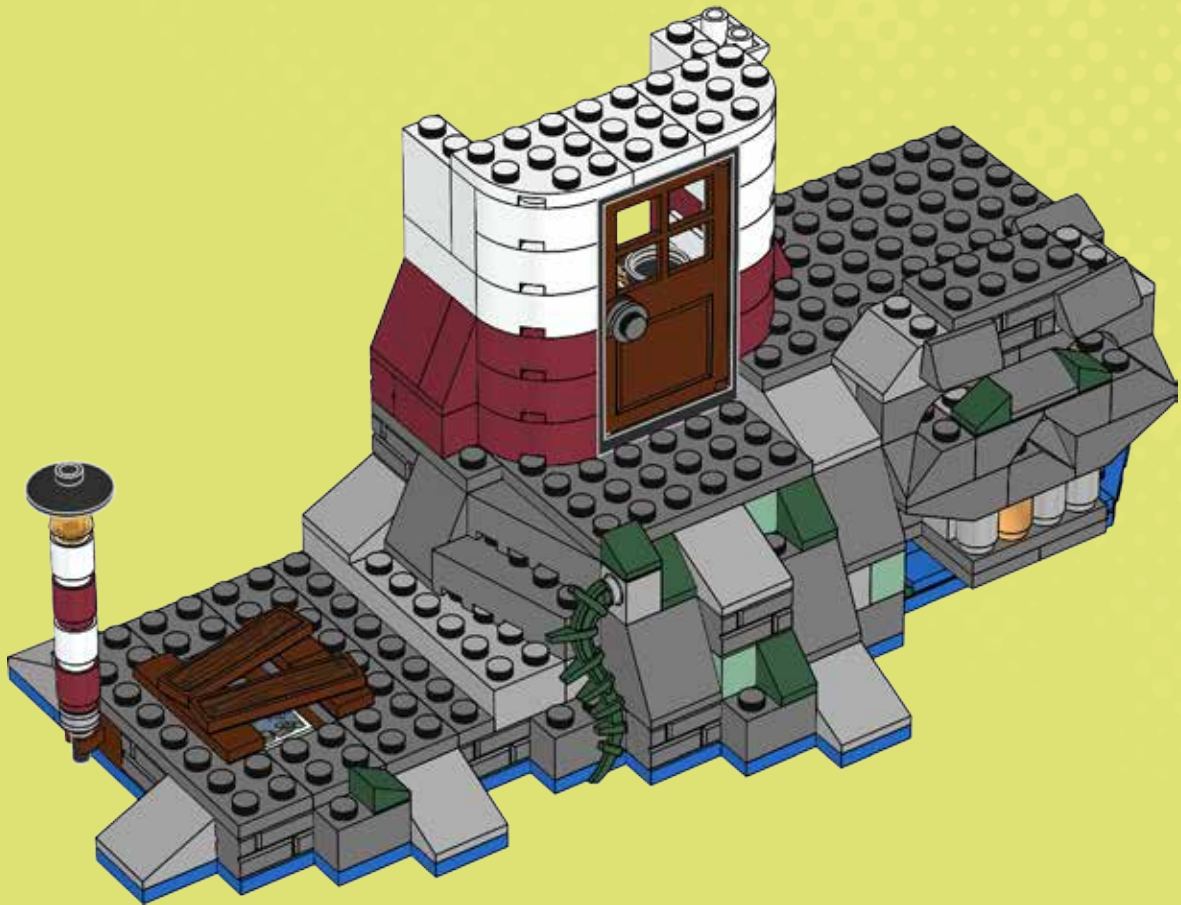

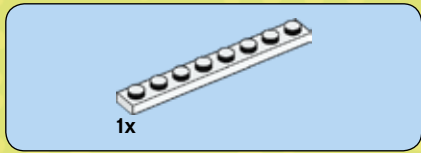

# 48

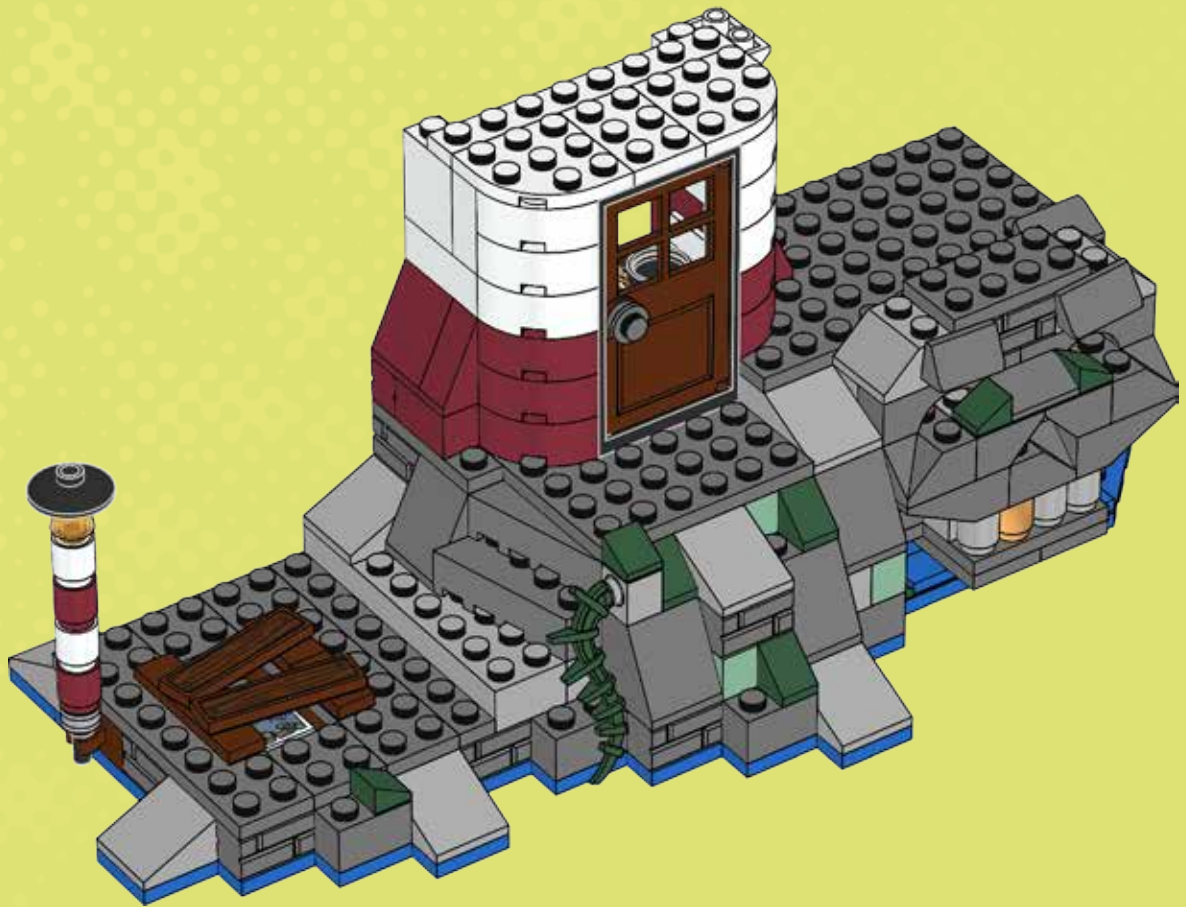



1x



1x



1x

# 49

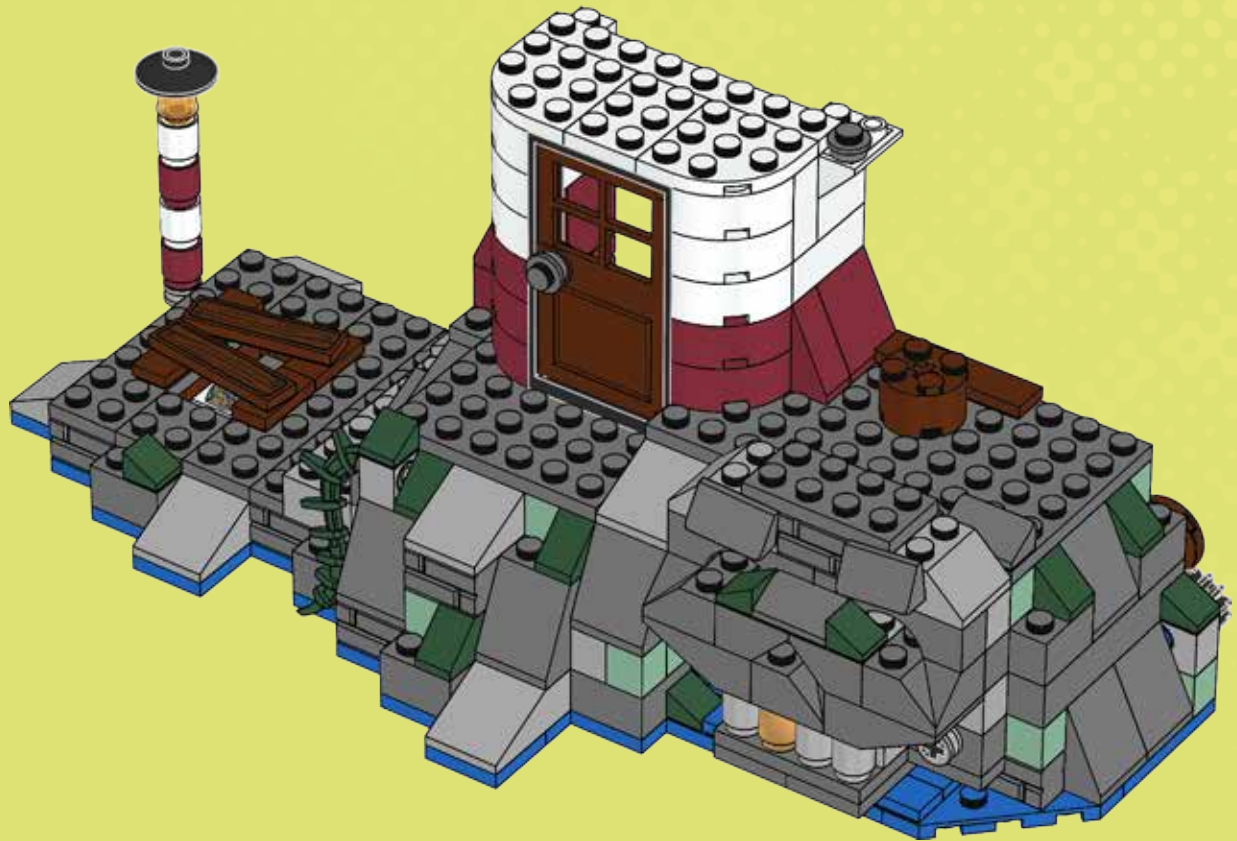

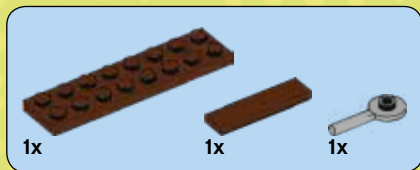

50

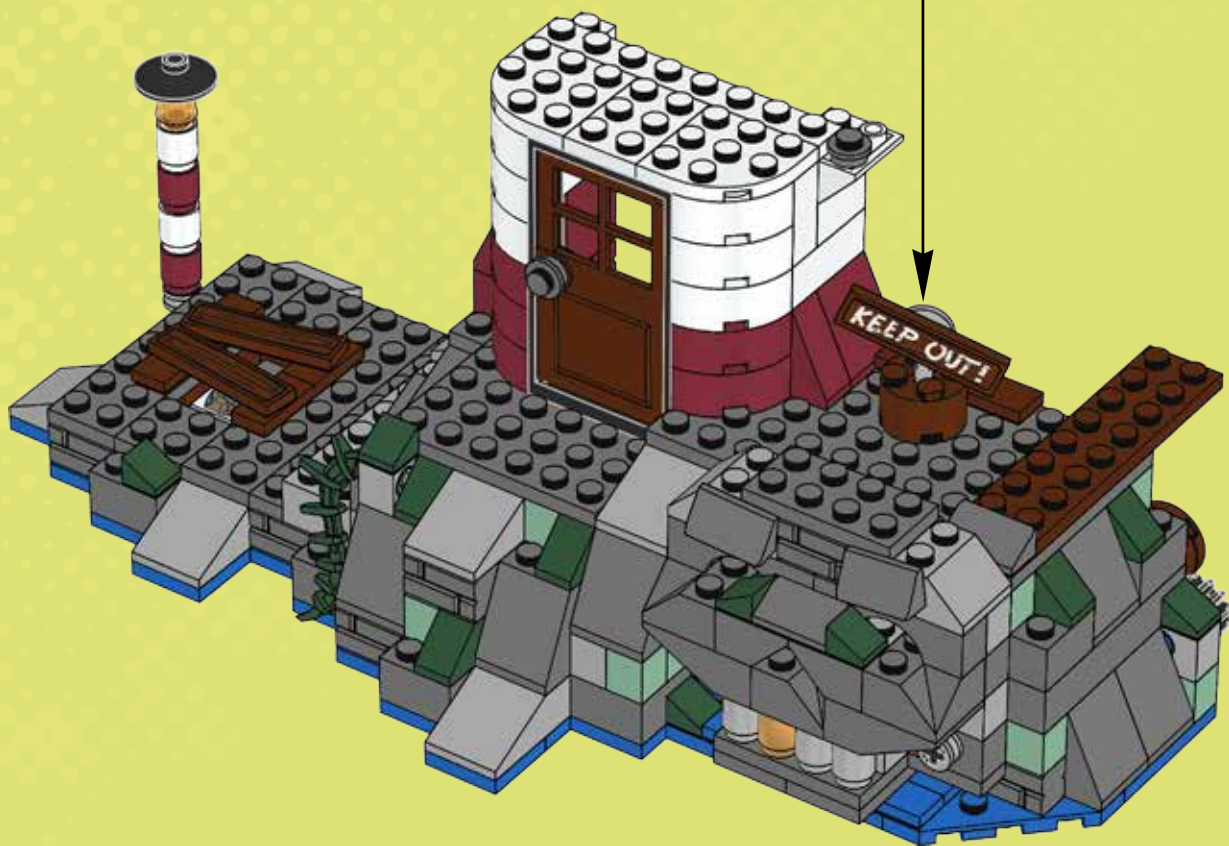
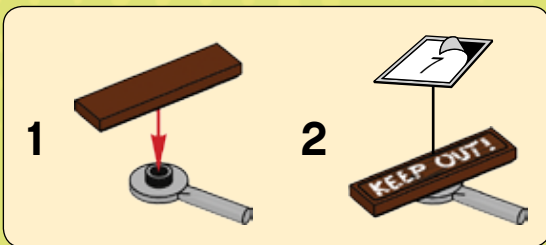



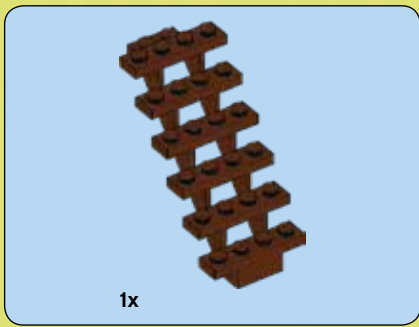

51

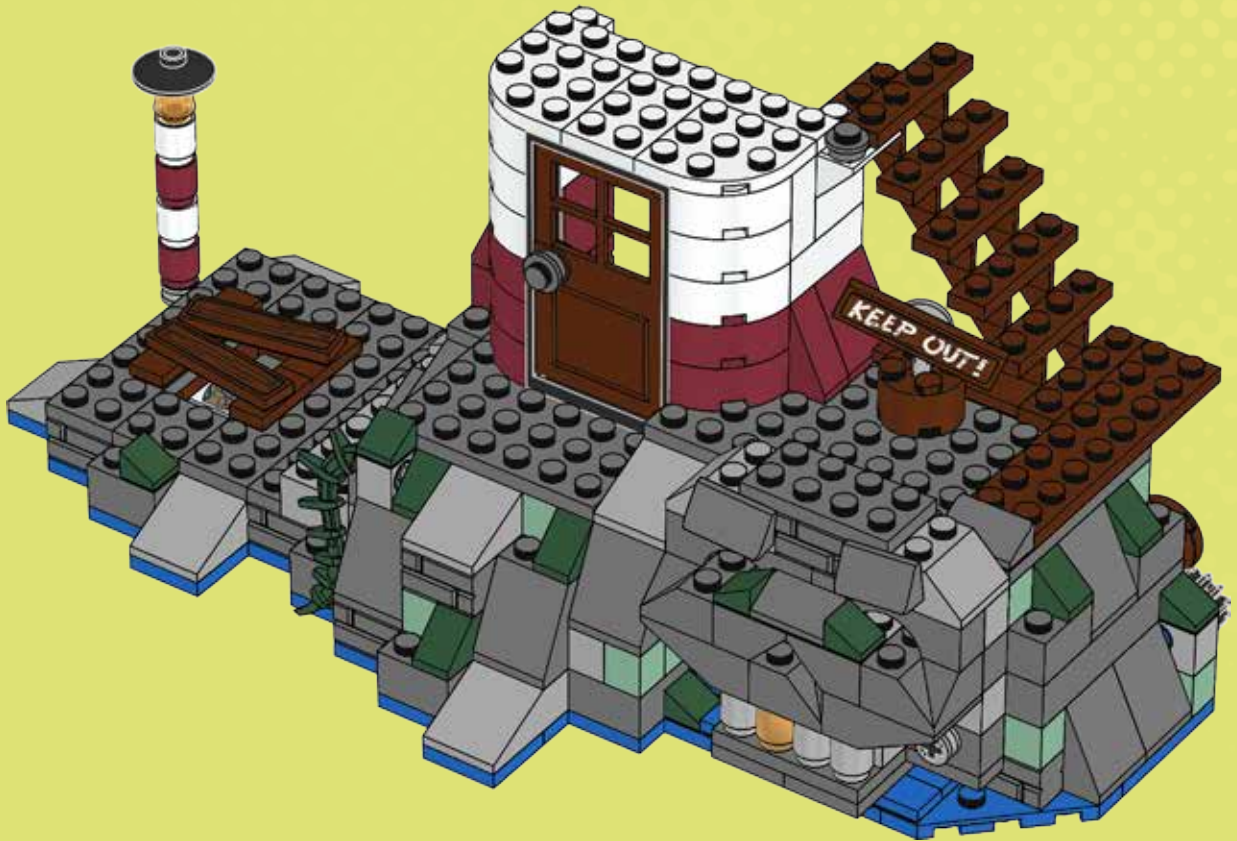

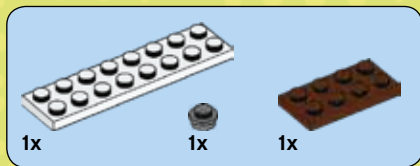

52

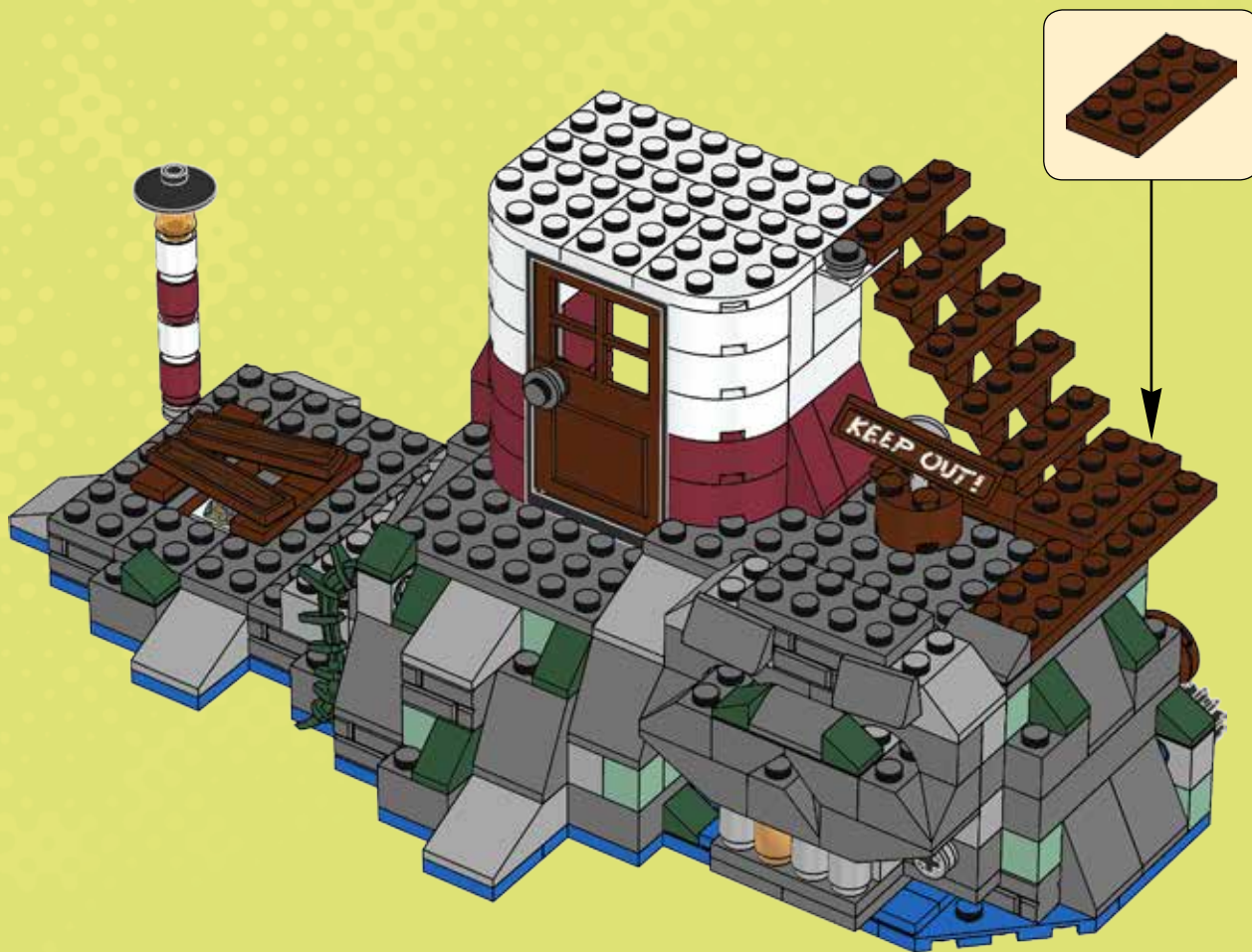



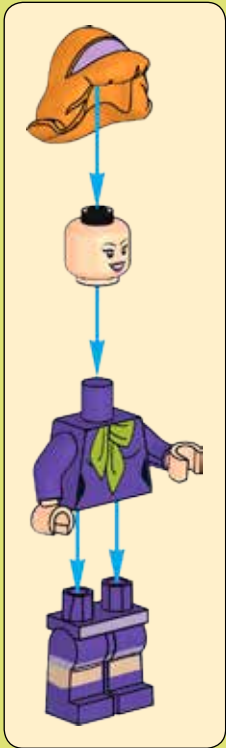
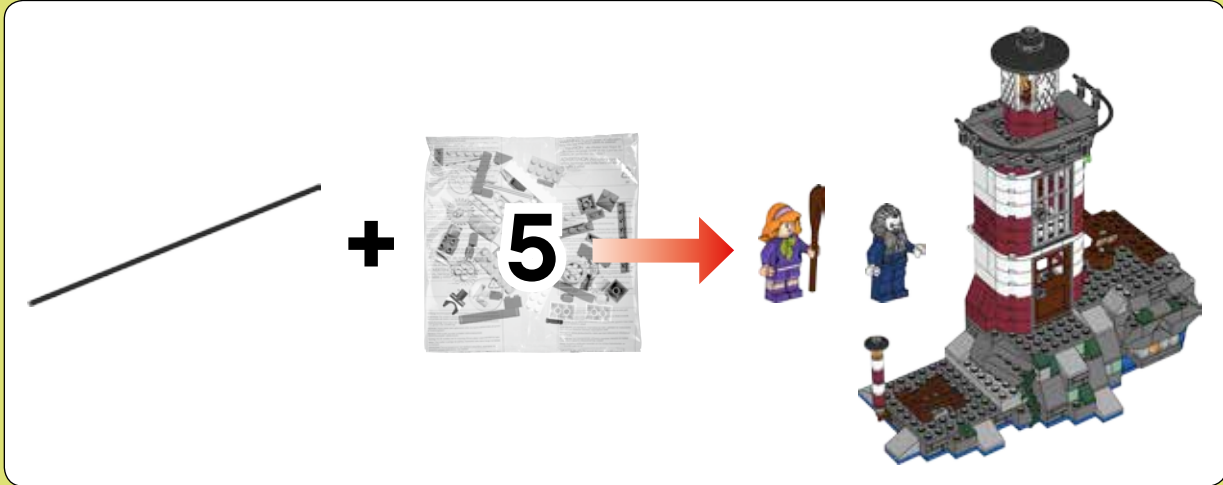



1x

# 53

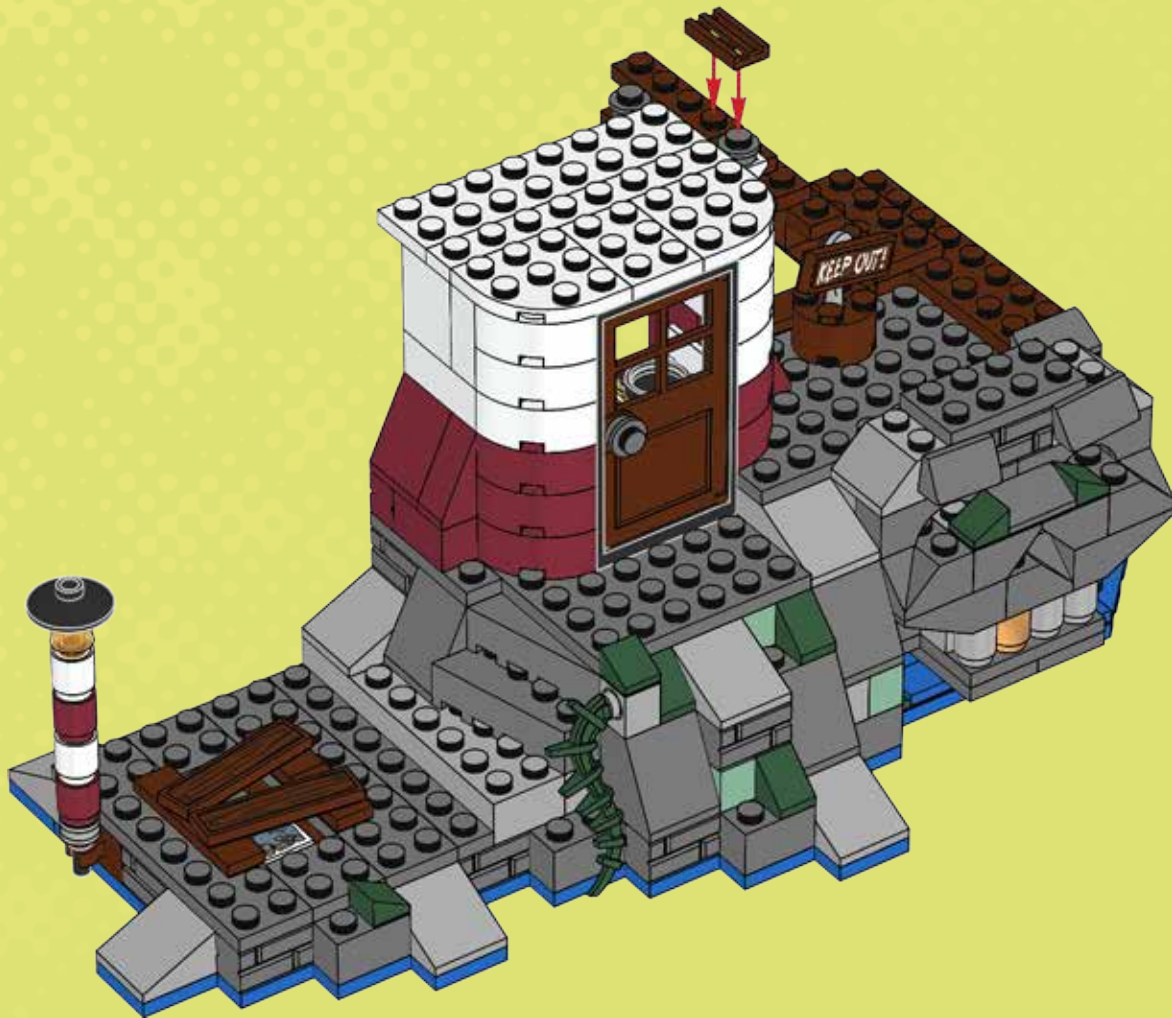



2x



2x



2x

# 54

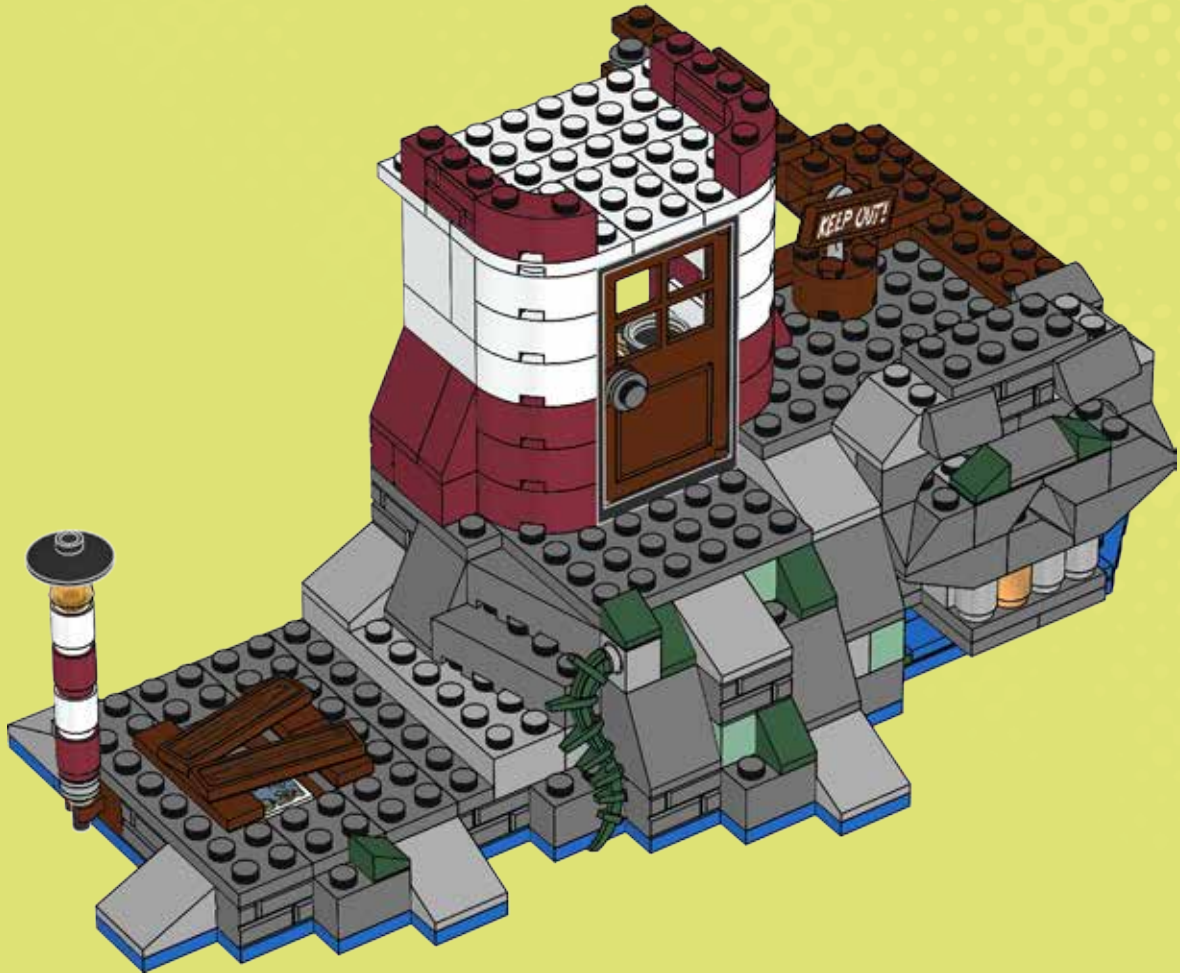



2x



2x



2x

# 55

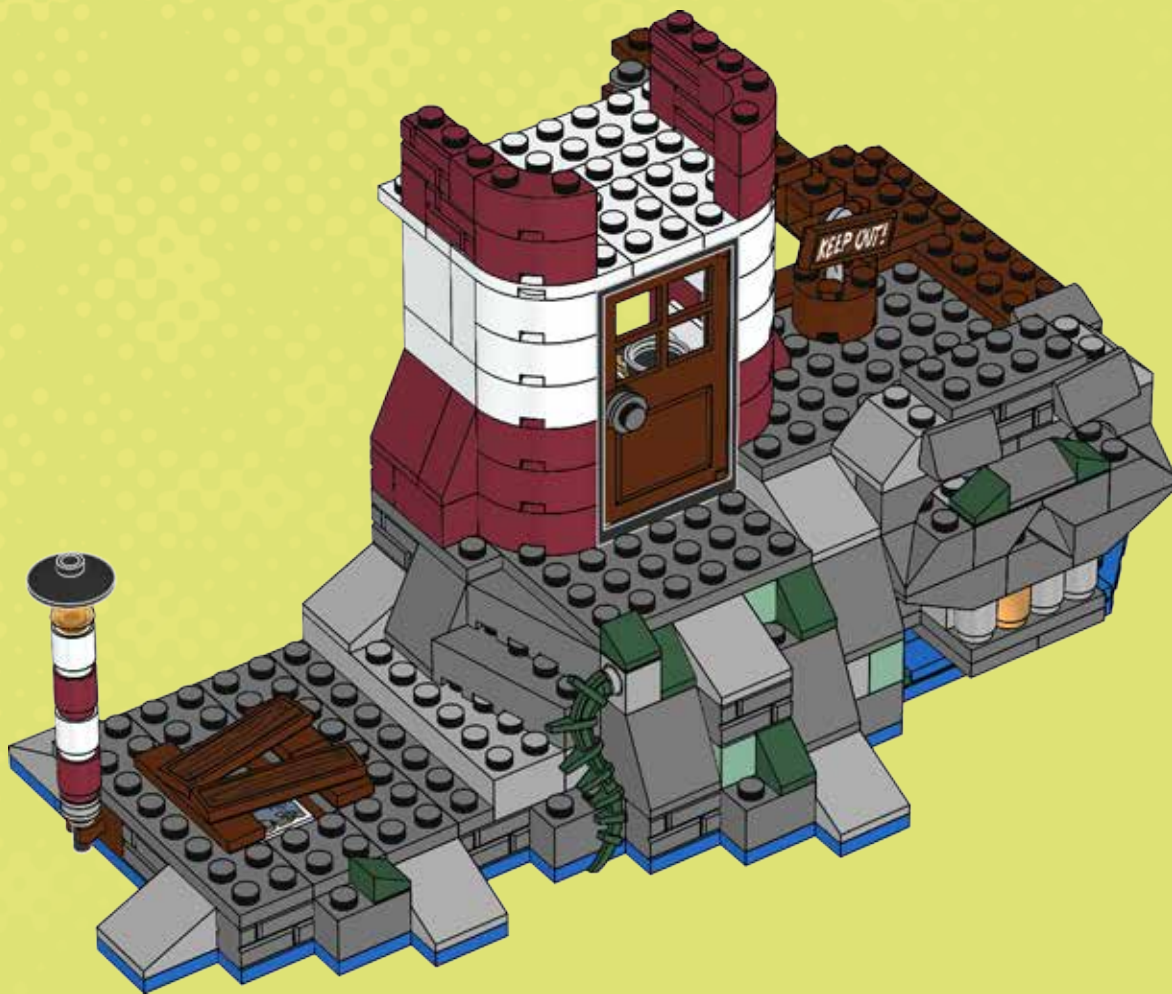



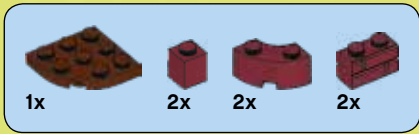

# 56





2x

# 57

1

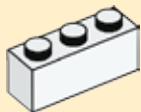

2

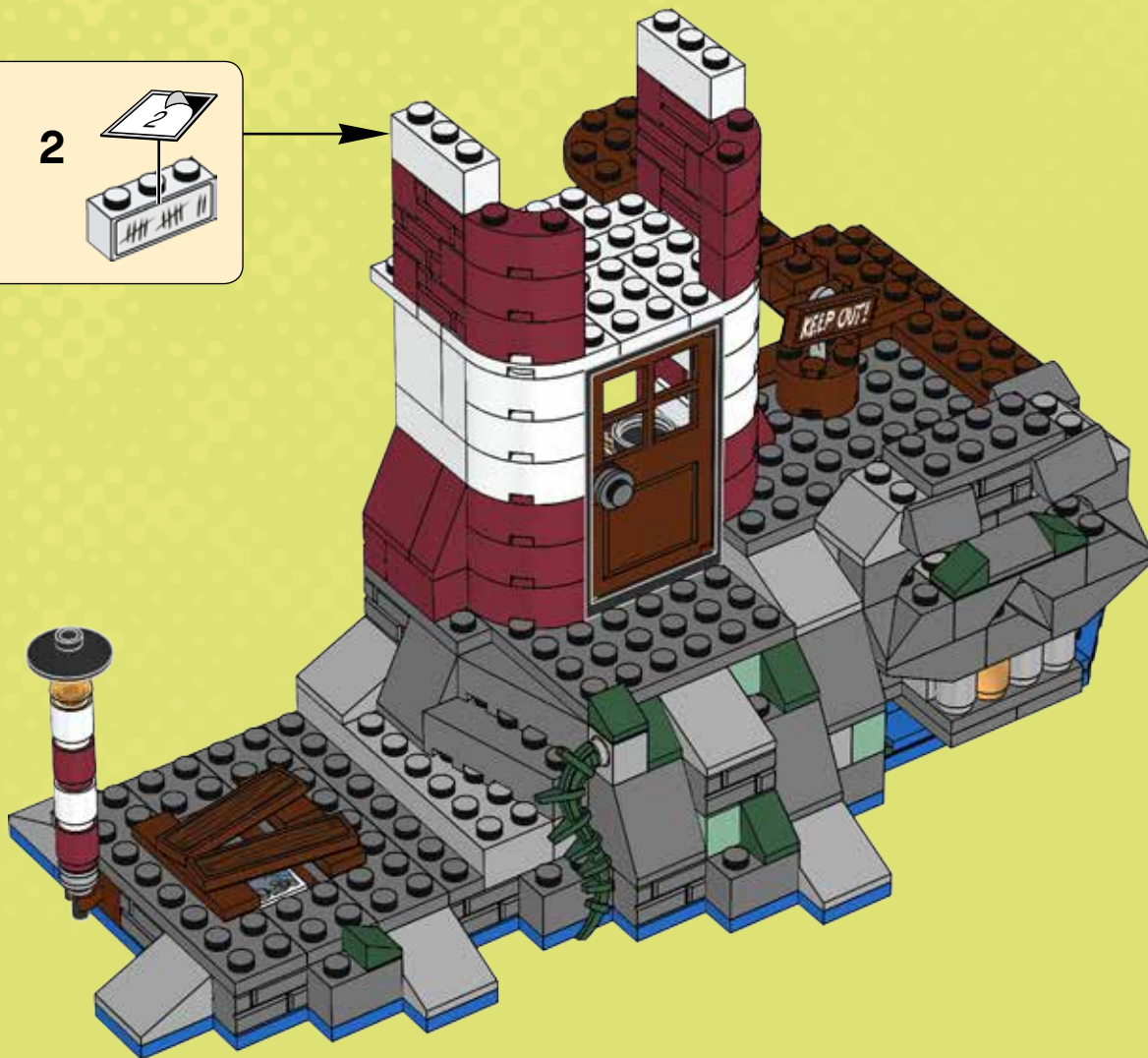
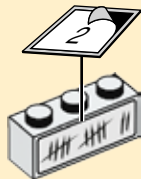

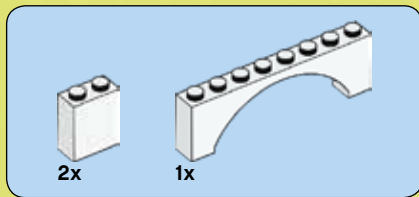

58







6x

# 59

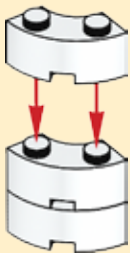

2x





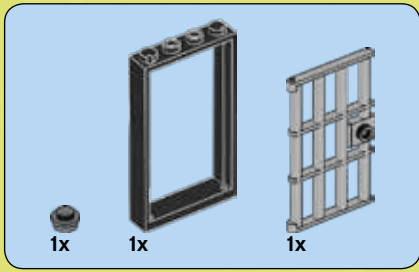

60

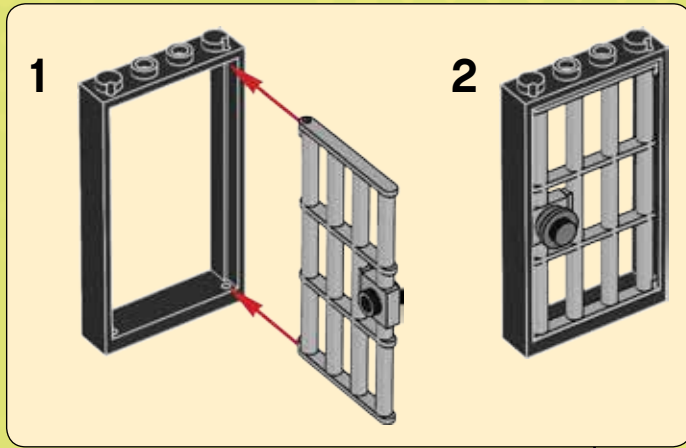



1x

# 61



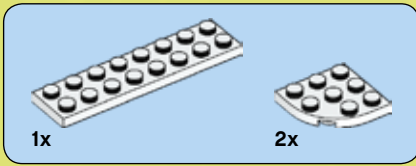

62







2x



2x

# 63





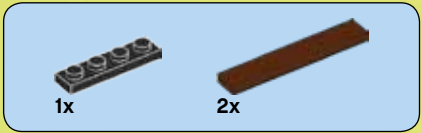

64





2x

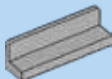

2x

# 65





2x



2x

# 66







2x



1x

# 67





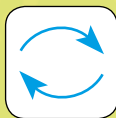
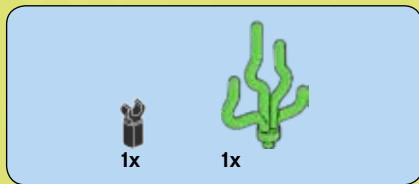

68

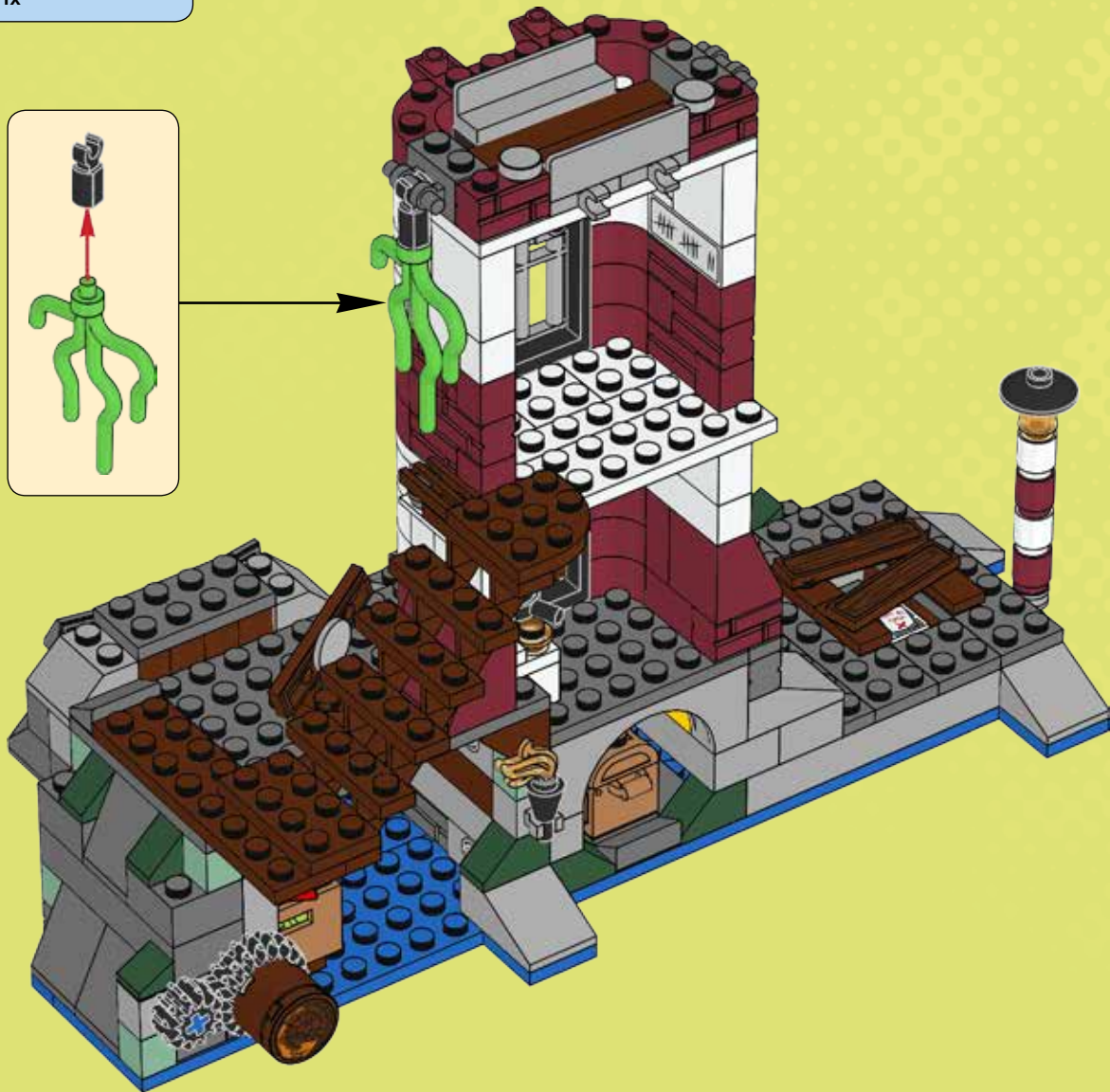
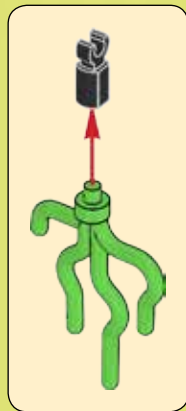

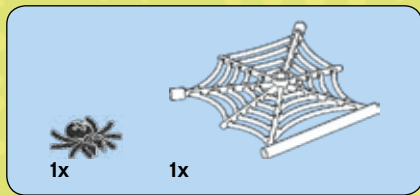

69

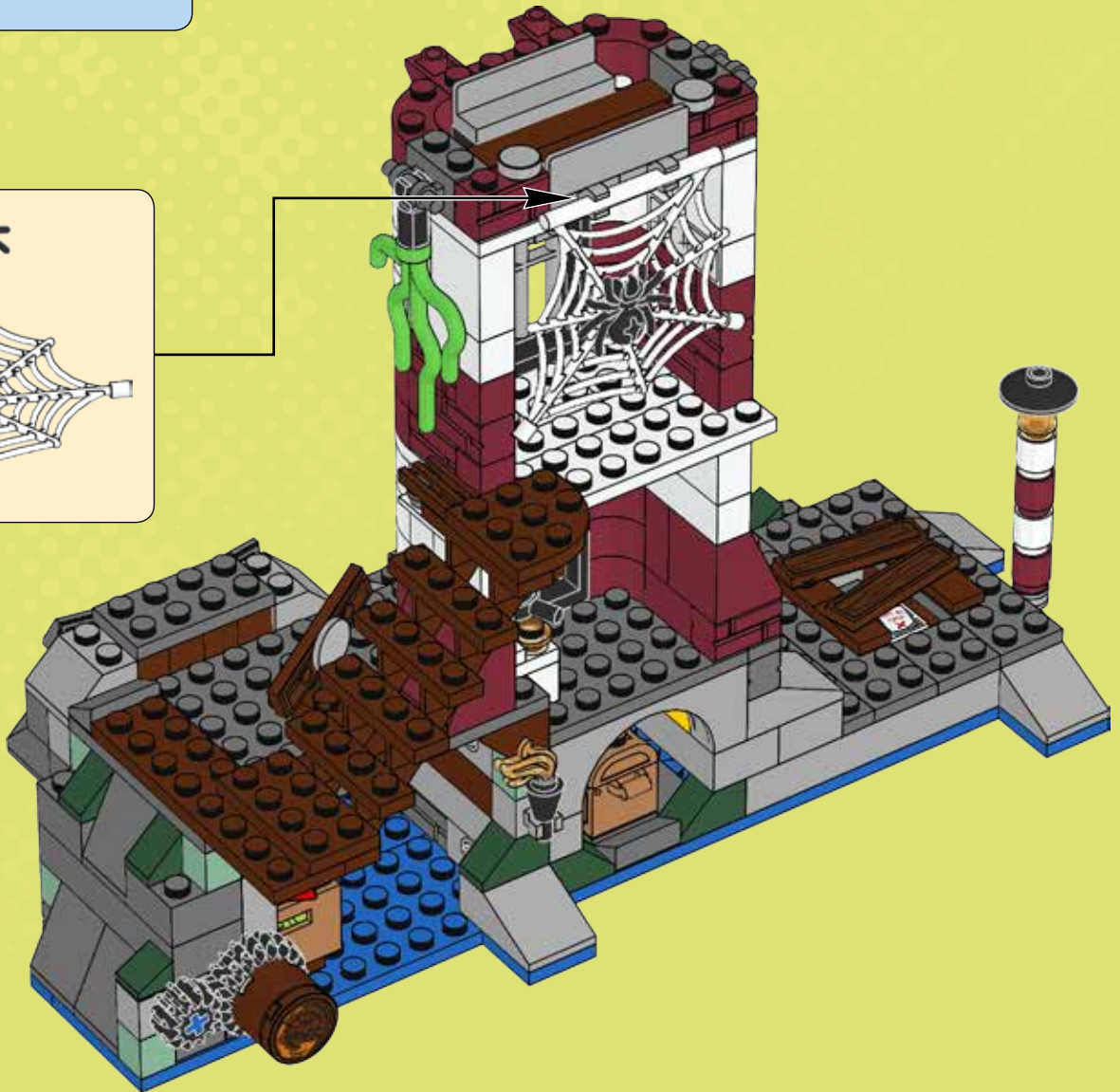
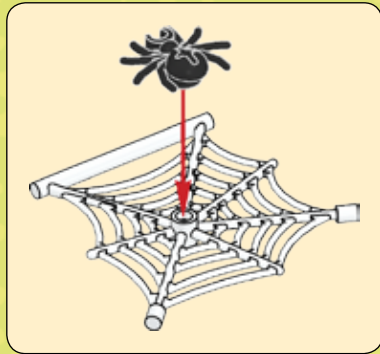

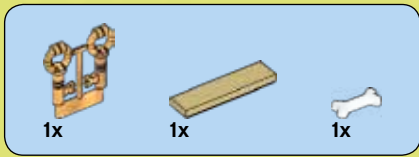

70

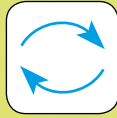



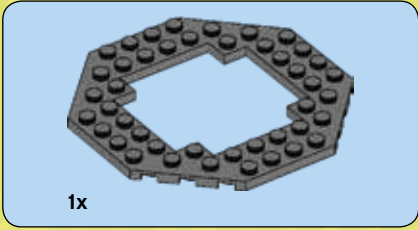
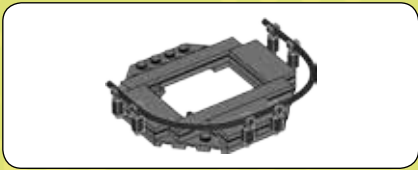

1

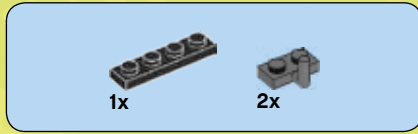
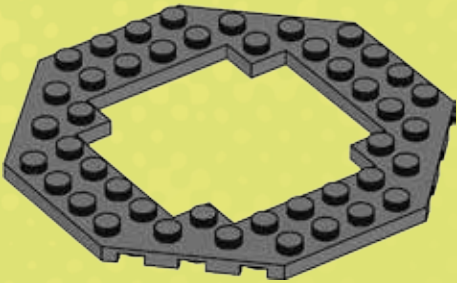

2

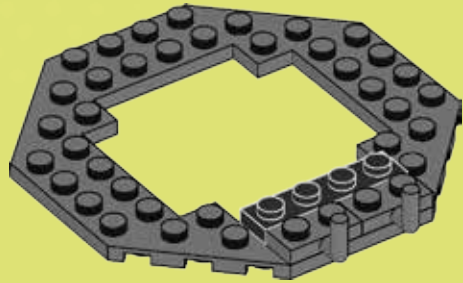



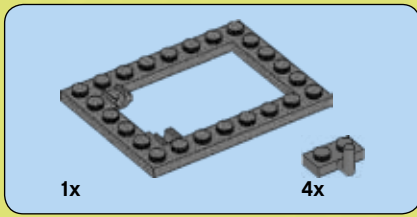

3

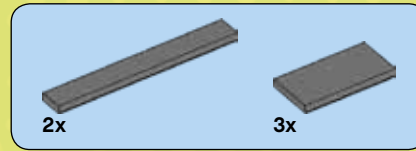
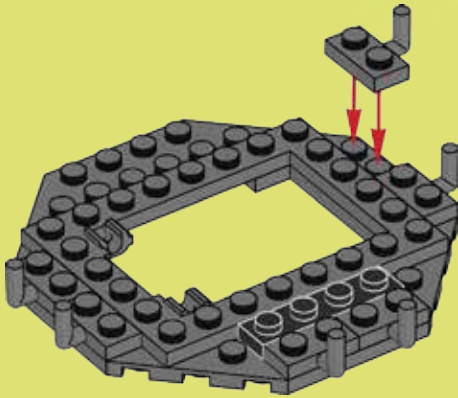

4

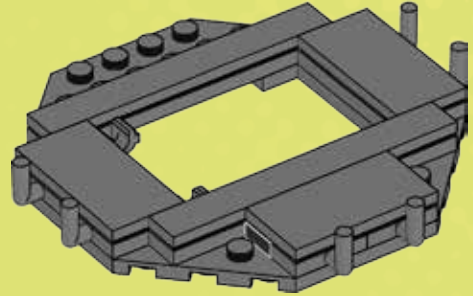



5

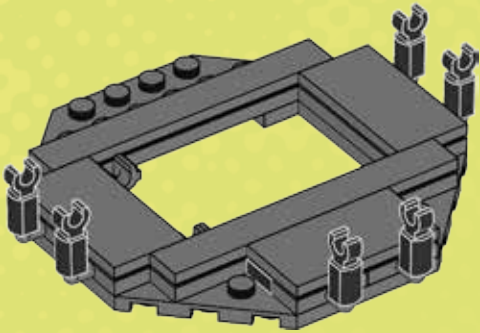

6

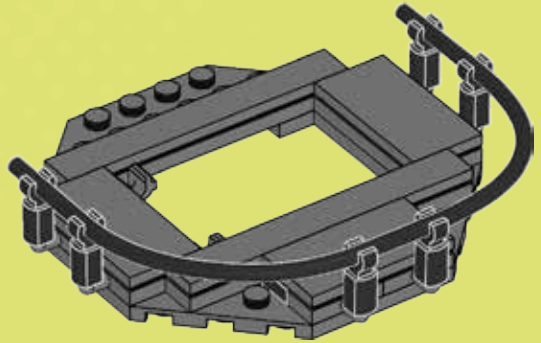

71

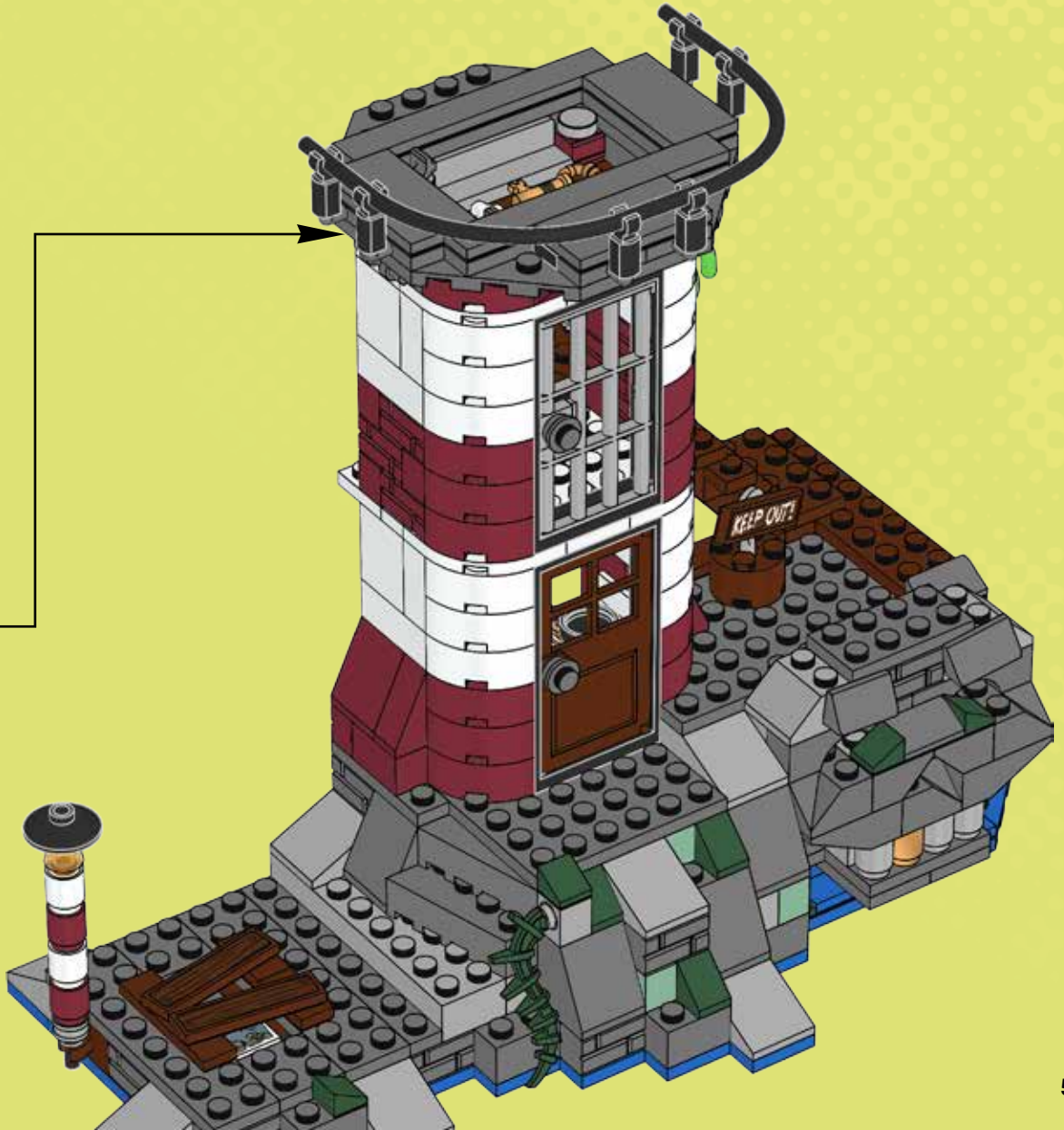



1

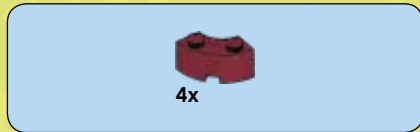

2

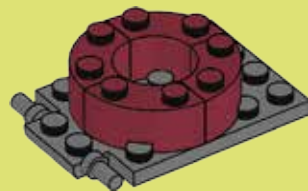





1x

3



4x

4

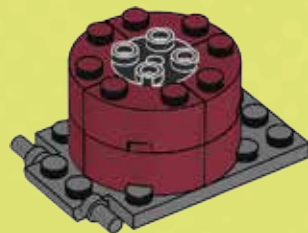



2x

5



2x

6





2x

7

1



2

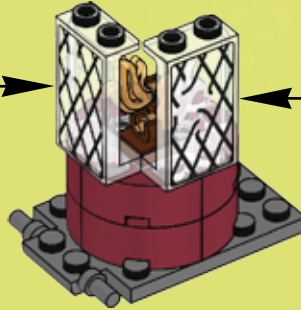
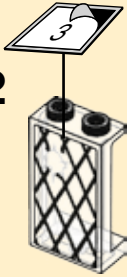

1



2

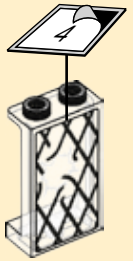

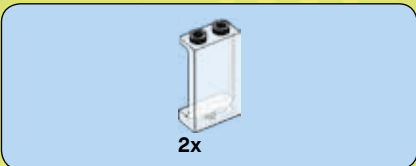

8

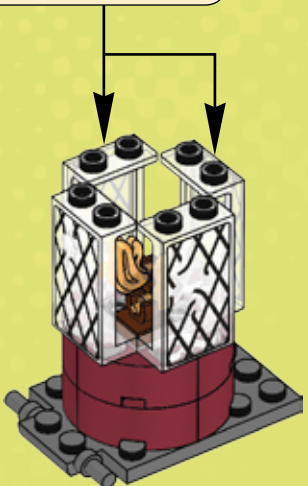
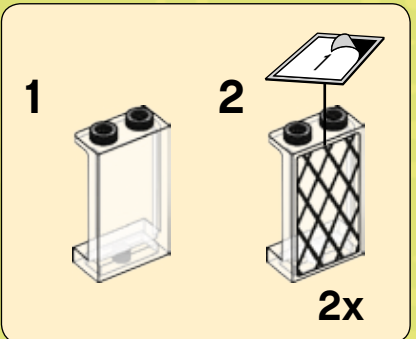

9





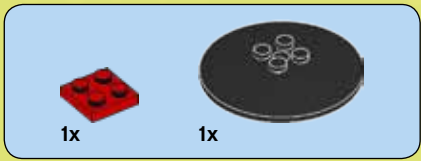

10



11



72









# SCOOBY-DOO!

WE'VE GOT A MYSTERY TO SOLVE  
WIR MÜSSEN EIN GEHEMNIS LÜFTEN  
NOUS AVONS UN MYSTÈRE À RÉSOUDRE

TENEMOS UN MISTERIO QUE RESOLVER  
TEMOS UM MISTÉRIO PARA RESOLVER  
MÁRIS VAN EGY MEGOLDÁSRA VÁRÓ REJTÉLYÜNK

75900



75901



75902



75903



75904



[LEGO.COM/scoobydoo](http://LEGO.COM/scoobydoo)





1x  
4113954

1x  
4113955

4x  
302323

5x  
302223

2x  
4118785

1x  
4206482

1x  
4609342

1x  
379523

1x  
303523

1x  
4528850

1x  
4610354

1x  
452826

1x  
6056234

1x  
4113209

1x  
6106280

7x  
6015891

4x  
4121715

1x  
6055630

2x  
4177431

1x  
6093977

1x  
4653822

2x  
389426

1x  
4587844

2x  
371026

2x  
302026

1x  
474026

1x  
6058341

2x  
4535834

1x  
6081988

1x  
6096955

1x  
373726

1x  
6025396

3x  
4113261

2x  
300401

4x  
362201

1x  
4181142

2x  
306201

12x  
4567449

1x  
366001

2x  
6062279

1x  
6123042

1x  
302201

2x  
302101

1x  
371001

1x  
346001

2x  
303401

4x  
4550745

1x  
486501

1x  
4600294

1x  
6006221

1x  
9551

5x  
4494474

1x  
302221

1x  
614121

1x  
4599453



1x  
6122385



2x  
4164021



3x  
4537936



3x  
4183133



1x  
4539907



1x  
4539908



1x  
6025027



1x  
6116514



1x  
6122140



2x  
6022112



1x  
6116511



1x  
6116504

66



2x  
4211065



2x  
4211008



2x  
4210998



2x  
4210997



1x  
4595710



1x  
4595708



1x  
4210794



1x  
4211114



1x  
4296512



6x  
4211060



1x  
4210875



2x  
4211128



2x  
4287972



4x  
4210935



1x  
4213607



9x  
4567887



2x  
4211096



7x  
4234534



3x  
4210702



2x  
4211064



2x  
4210999



11x  
6000311



2x  
4211094



2x  
4211043



1x  
4211001



5x  
4560184



1x  
4579354



6x  
4611703



4x  
4210633



1x  
4500608



2x  
6092674



2x  
4619655



1x  
6119126



2x  
6102650



1x  
4625032

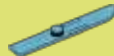

2x  
6088558



5x  
4211181



1x  
4211193



1x  
4215496



2x  
4211166



2x  
6071274



2x  
6092590



1x  
4216581



1x  
6075213



1x  
4283660



1x  
6103769

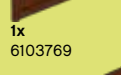

1x  
4609635



1x  
4277751



4x  
4211221



1x  
4224243



2x  
4565394



5x  
4211194



1x  
4211186



2x  
4211204



1x  
4211211



2x  
4558953



1x  
4533772



3x  
4211412



1x  
4211535



7x  
4211440



2x  
4211410



8x  
4211421



2x  
6071299



1x  
6122981



1x  
4211753



1x  
4258308



2x  
4211573



1x  
4211483



1x  
4610149



1x  
4211419



2x  
6106189



2x  
4211385



6x  
4211392

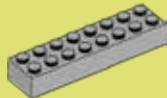

2x  
6037399



2x  
6028812



2x  
4650260



1x  
6102983



1x  
6102984



1x  
6035734



1x  
6119136



1x  
6122127



1x  
6122066



1x  
6122746



1x  
6122736



1x  
6060800



1x  
4595077



1x  
6022033



1x  
6122731



1x  
6122133



1x  
4162916



1x  
6123036



1x  
301024

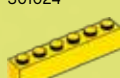

4x  
300924



1x  
614124



1x  
6123033



1x  
6059027



2x  
4125254



2x  
4121741



1x  
6122725



1x  
4654448



6x  
4541376



10x  
6093908



1x  
4539104



2x  
4539099



21x  
4625551



2x  
4645101



2x  
4590811



2x  
4625281



1x  
4541496



10x  
4521948



1x  
4550324



1x  
6115248



1x  
6122533



1x  
4666579



6x  
4504375



10x  
4255624



1x  
4226869



1x  
6122436



1x  
6122359



1x  
4294148



1x  
6107389



1x  
6076604



2x  
4632100



6x  
4278412



4x  
6010737

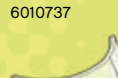

1x  
4523573



1x  
4567338



2x  
4222960



3x  
4649066

Customer Service

Kundenservice

Service Consommateurs

Servicio Al Consumidor

LEGO.com/service or dial



: 00800 5346 5555

: 1-800-422-5346



LEGO and the LEGO logo are trademarks of the LEGO Group.  
©2015 The LEGO Group. 6132705



Download Zapparr App Scan the page Play Activity!

Zapparr App herunteladen  
Seite scannen  
Spiele Spaß erleben!

Télécharge l'application Zapparr  
Scanne la page  
Joue à l'activité !

Descarga la app Zapparr  
Escanea la página  
¡Juega!

Descarrega a app Zapparr  
faz scan da página  
Joga com muita ação!

Töltsd le a Zapparr appot  
Szkenneld be az oldalt,  
Indítsd a játéko!



TM & © Hanna-Barbera.  
WB SHIELD: TM & © Warner Bros. Entertainment Inc.  
(s15)

Apple, the Apple logo, iPad, iPhone and iPod touch are  
trademarks of Apple Inc.  
Google Play is a trademark of Google Inc.