



DC UNIVERSE™

SUPER HEROES



76002



HERO OF STEEL™



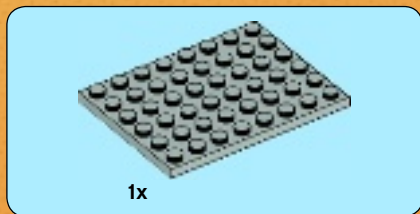
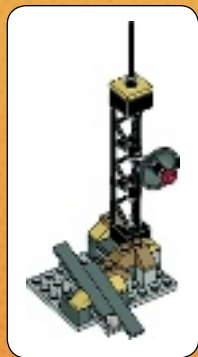

1





2x

2

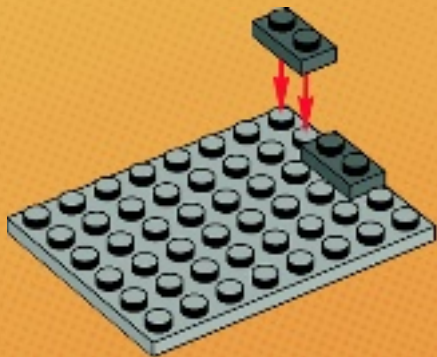

1x

3

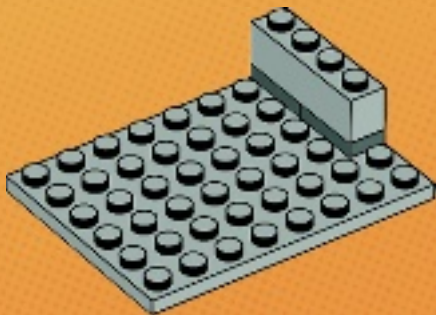



2x



1x



1x

4

1



2

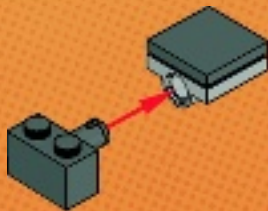

3

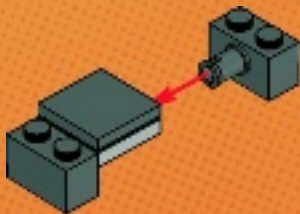

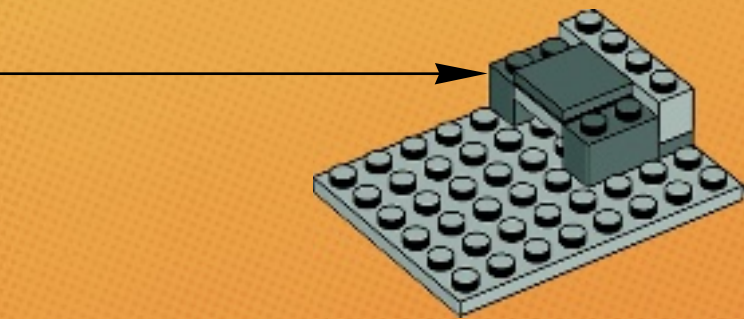



2x



1x



1x

5

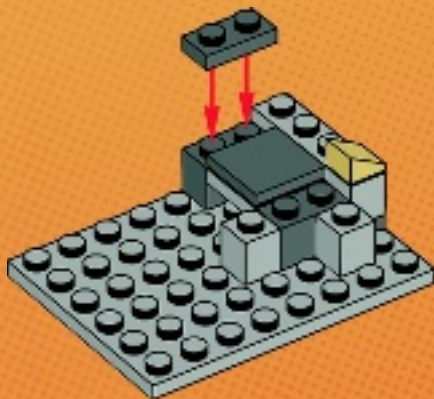

3x



1x

6

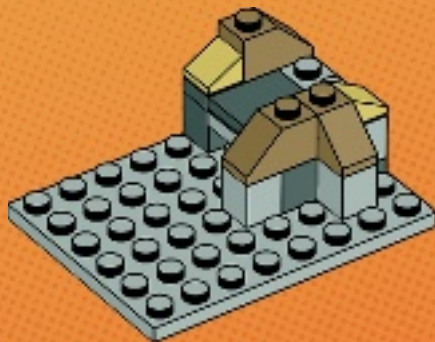



1x



1x

7

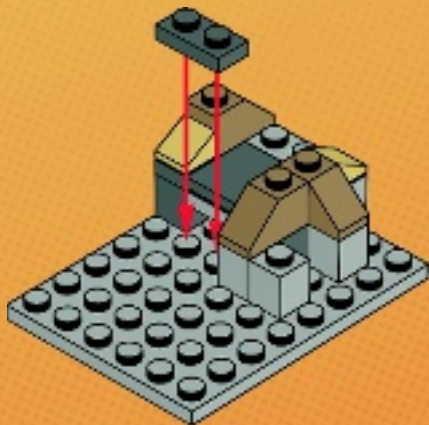

8



2x



1x

8

1

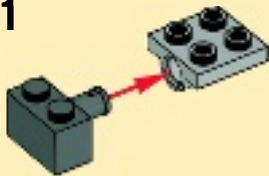

2

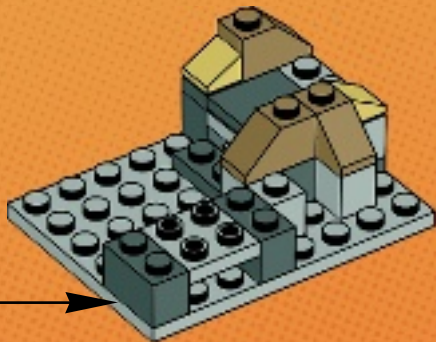
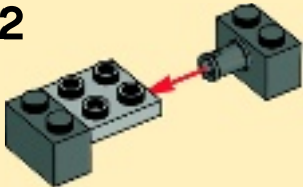



1x



2x

9

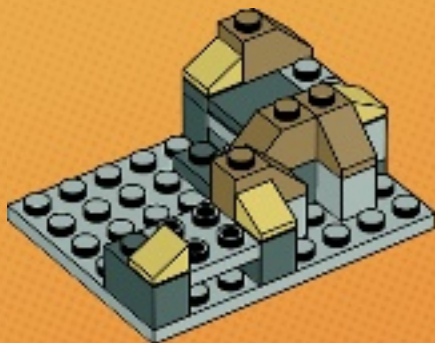

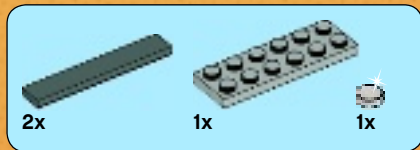

10

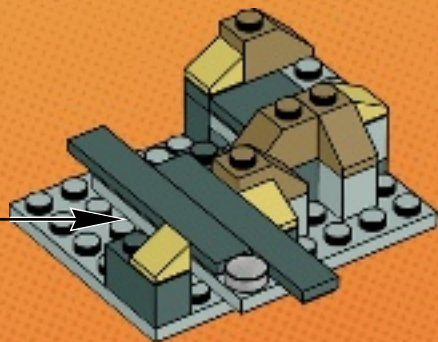
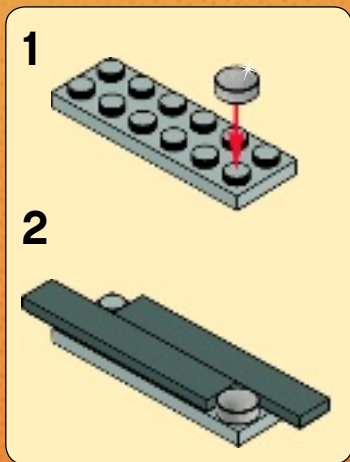

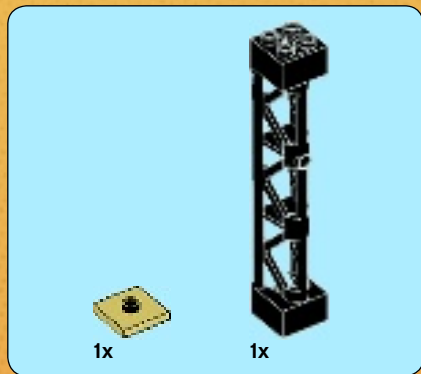

11

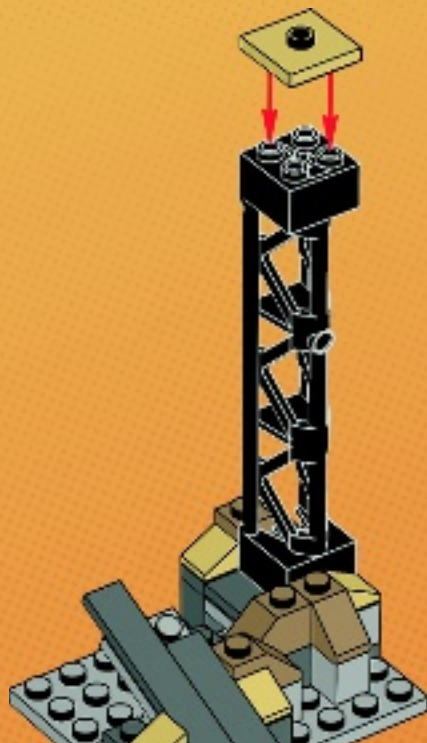

12



1x

12

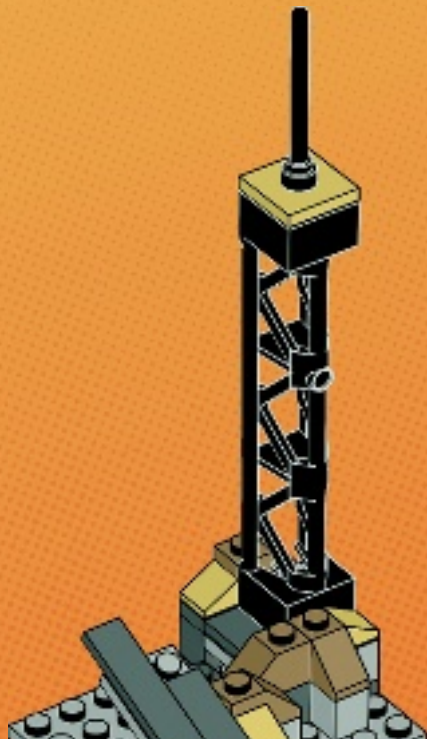



1x



1x



1x



1x

13

1



2



3



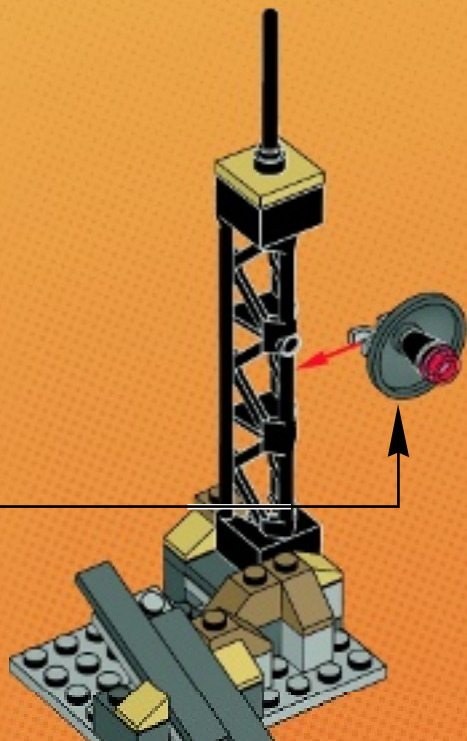

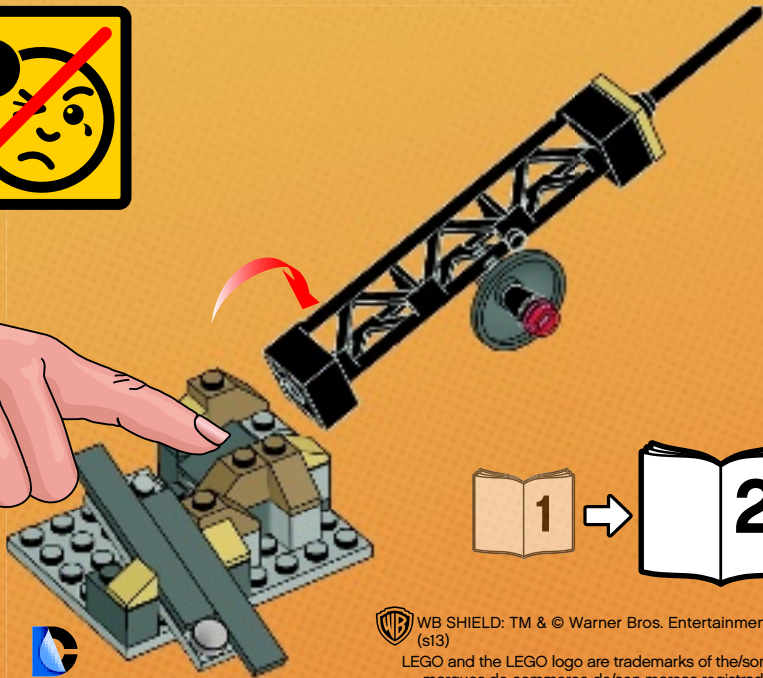

6047342 / 6047344



DC COMICS™ TM & © DC Comics.



WB SHIELD: TM & © Warner Bros. Entertainment Inc. (s13)

LEGO and the LEGO logo are trademarks of the/son des marques de commerce de/son marcas registradas de LEGO Group. ©2013 The LEGO Group.

