



76960





### **Get excited about our new packaging!**

We're switching from plastic to paper-based packaging. That's why you might find a mix of paper and plastic in our boxes!

### **Nos nouveaux emballages vous emballeront !**

Nous passons des emballages en plastique aux emballages à base de papier. C'est pourquoi vous pourriez trouver un mélange de papier et de plastique dans nos boîtes !

### **¡Te presentamos nuestros nuevos empaques!**

Estamos sustituyendo las bolsas de plástico por bolsas con base de papel. ¡Por eso, puedes encontrar una mezcla de papel y de plástico en nuestras cajas!





# BUILDER



Apple and the Apple logo are trademarks of Apple Inc., registered in the U.S. and other countries and regions. App Store is a service mark of Apple Inc. Google Play and the Google Play logo are trademarks of Google LLC. Tencent and the Tencent logo are trademarks of Tencent Inc.

**EN** Ask parents' permission before going online | **DE** Eltern um Erlaubnis bitten, bevor du online gehst | **FR** Demande l'autorisation d'un parent avant d'aller en ligne | **IT** Chiedi il permesso ai tuoi genitori prima di andare online | **ES** Pídeles permiso a tus papás antes de conectarte a Internet | **PT** Peça autorização aos pais antes de acederes online | **ZH** 上网前应先征得父母的同意 | **PL** Poproś rodziców o zgodę, zanim wejdziesz do Internetu | **CS** Než půjdeš na internet, požádej rodiče o svolení | **SK** Skôr než pôjdeš na internet, vypýtaj si povolenie od rodičov | **HU** Kérj szülői engedélyt, mielőtt online csatlakoznál! | **RO** Cere permisiunea părinților înainte de a te conecta online | **BG** Поискайте разрешение от родител, преди да влезете онлайн | **LV** Pirms došanās tiešsaistē palūdz atļauju vecākiem | **ET** Enne Interneti kasutamist küsi vanematelt luba | **LT** Prieš prisijungdami prie interneto, atsilkauskite tėvų

Q [LEGO.com/devicecheck](https://www.lego.com/devicecheck)

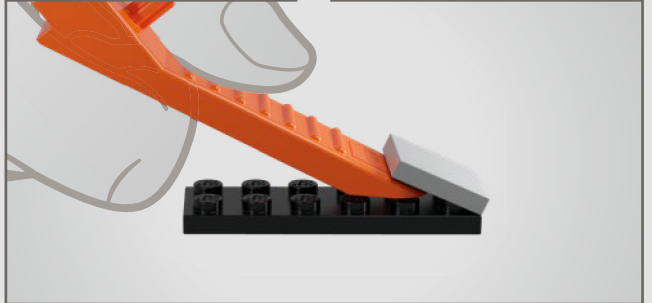
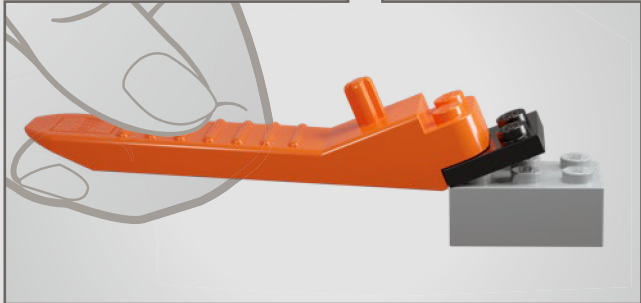
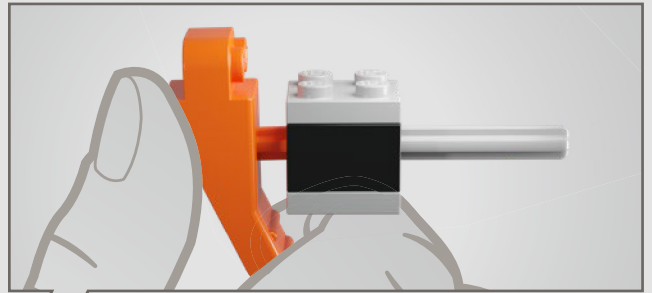
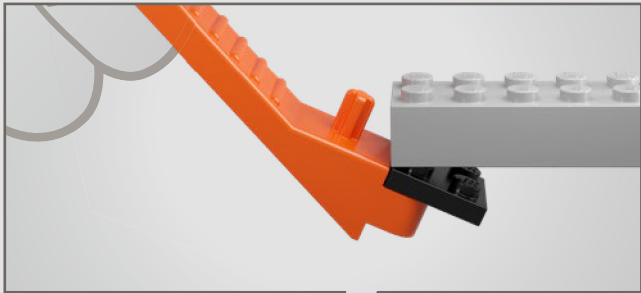



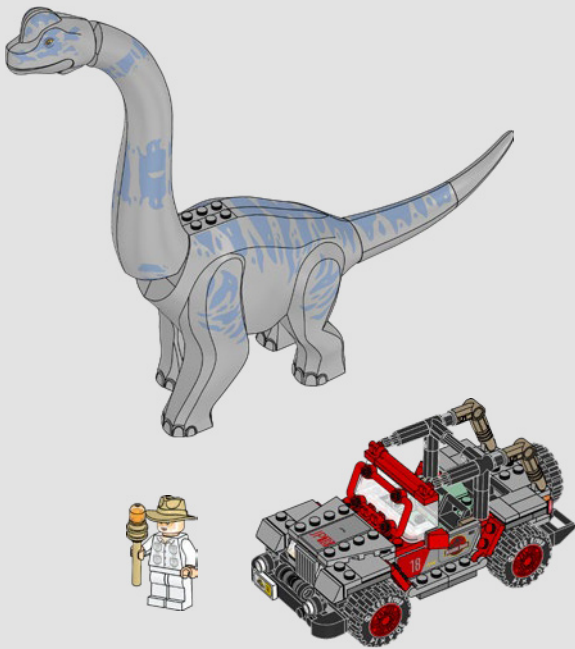

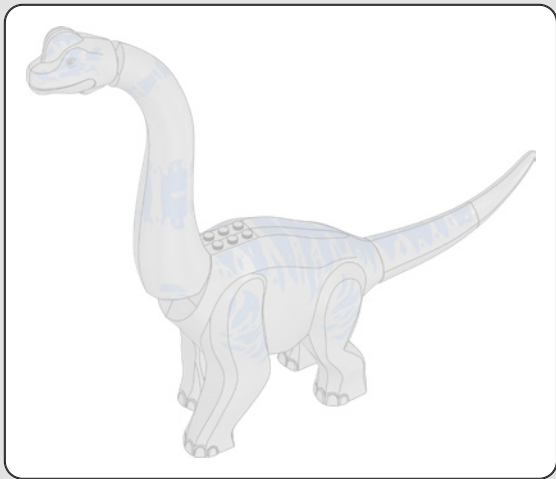
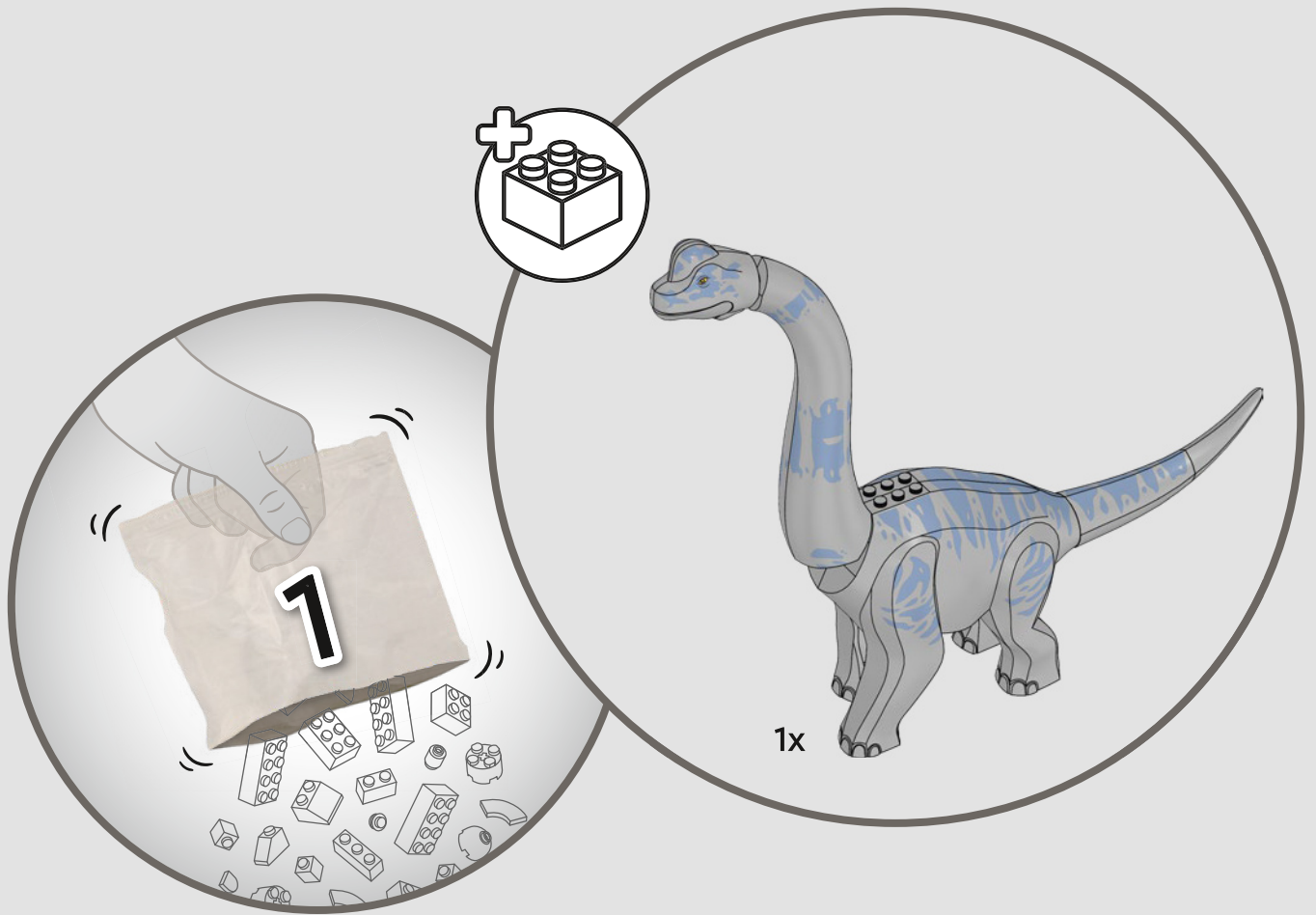



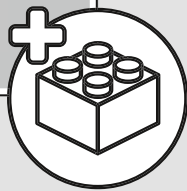
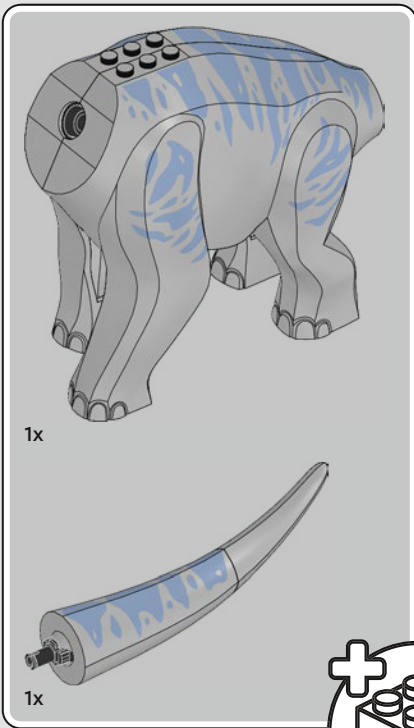

1

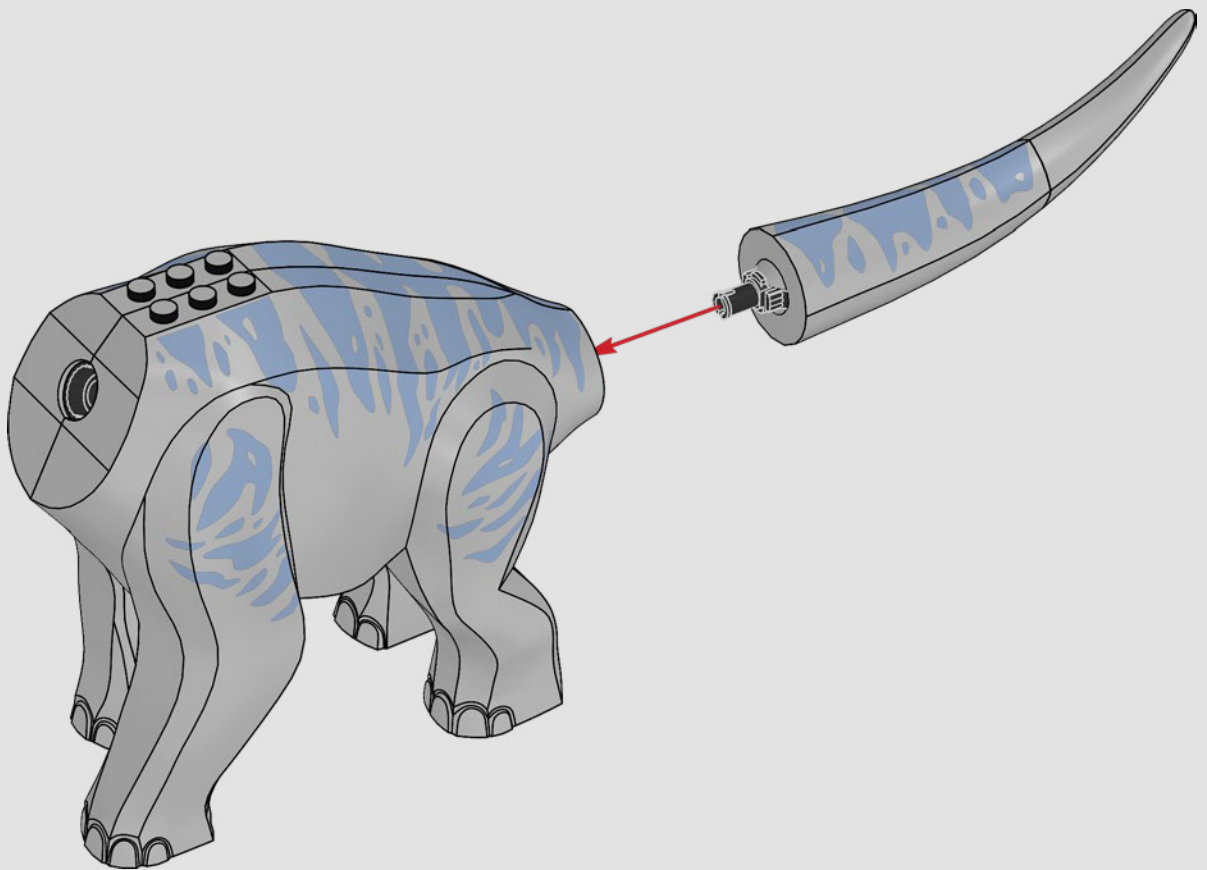

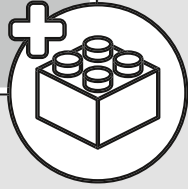
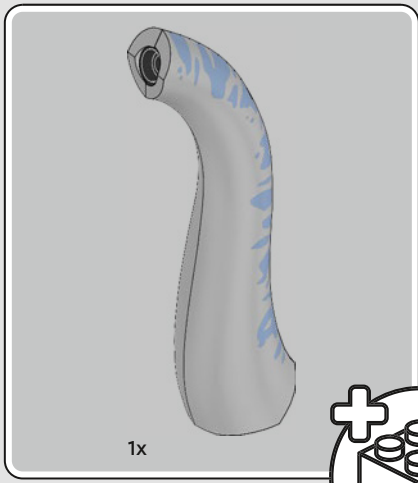

2

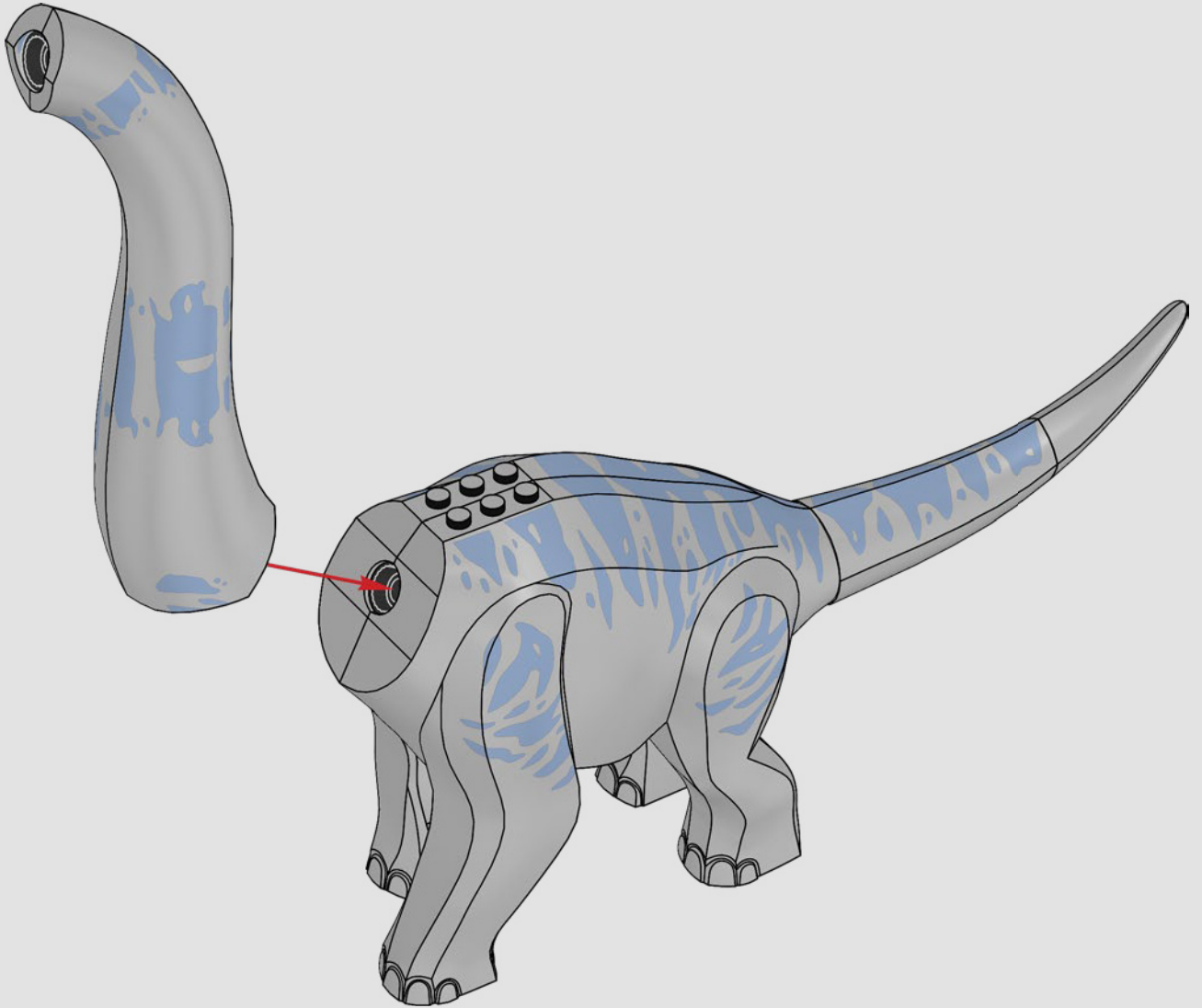



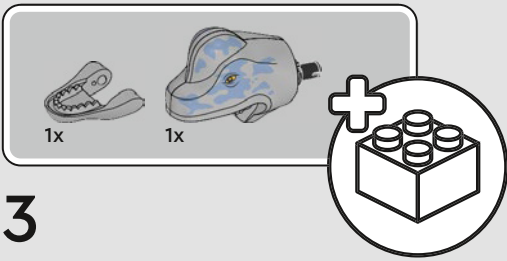

3

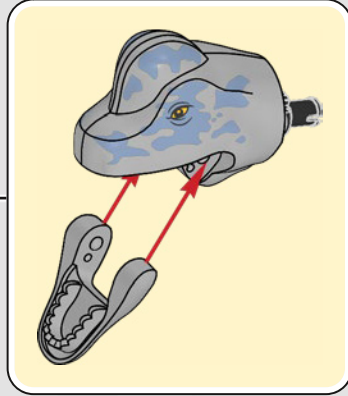

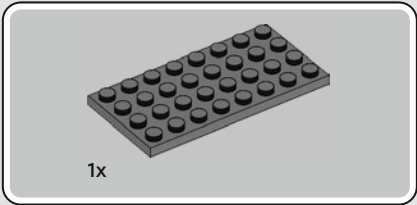
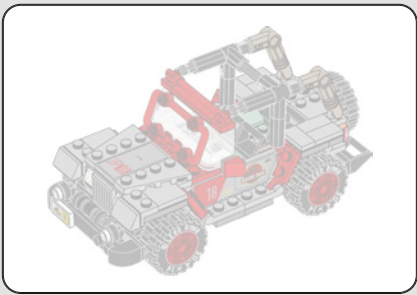

1

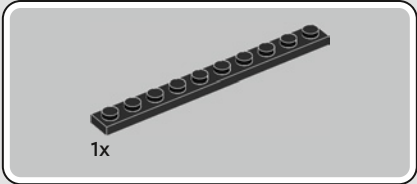
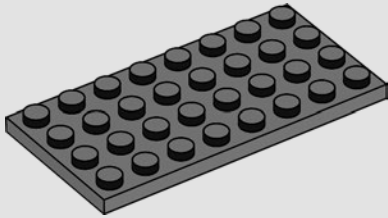

2

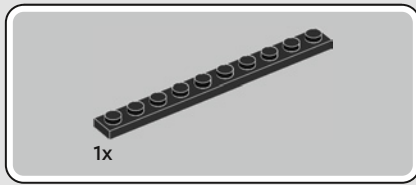
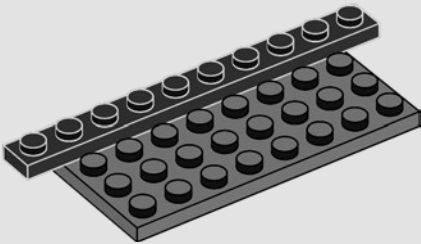

3

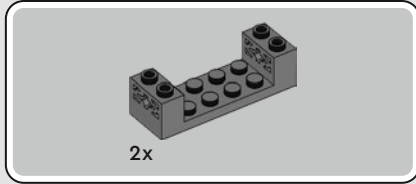
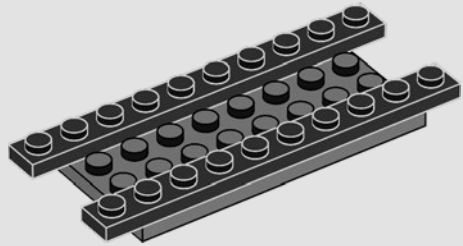

4

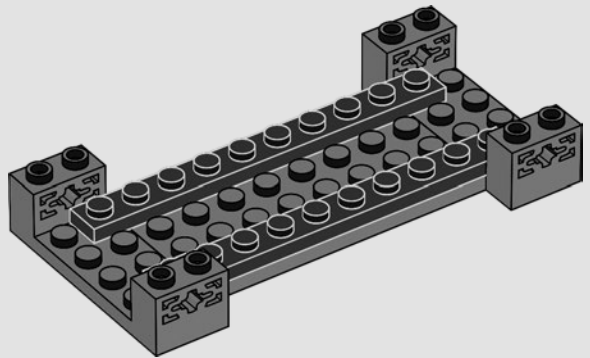



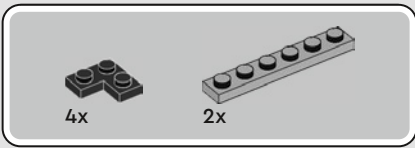

5

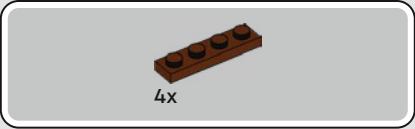
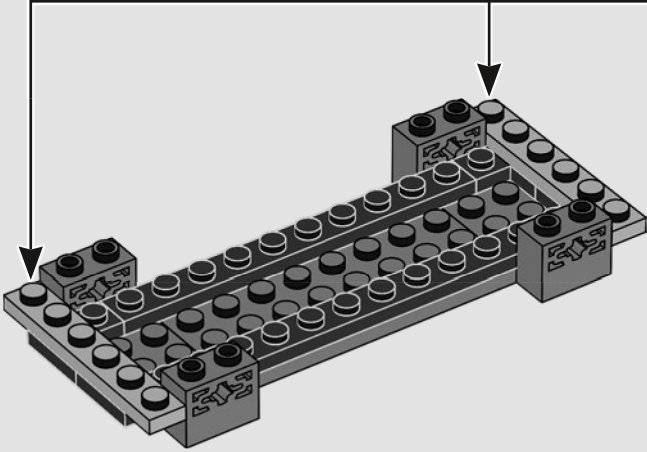
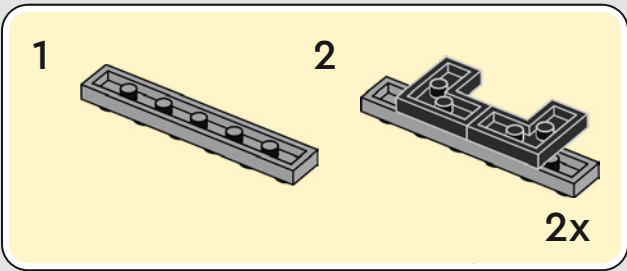

6

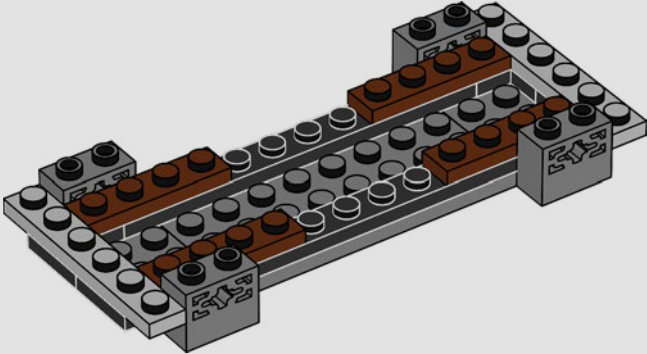

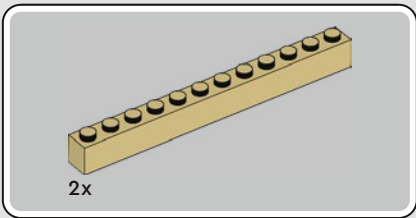

7

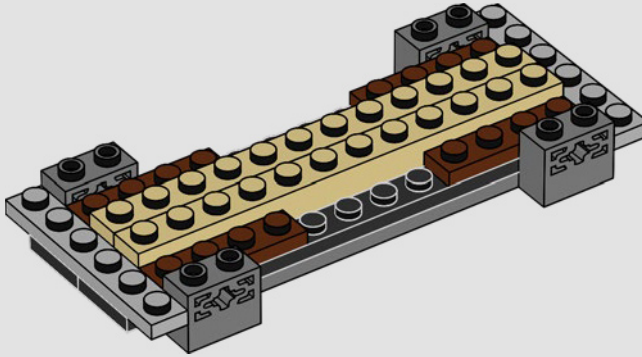

8

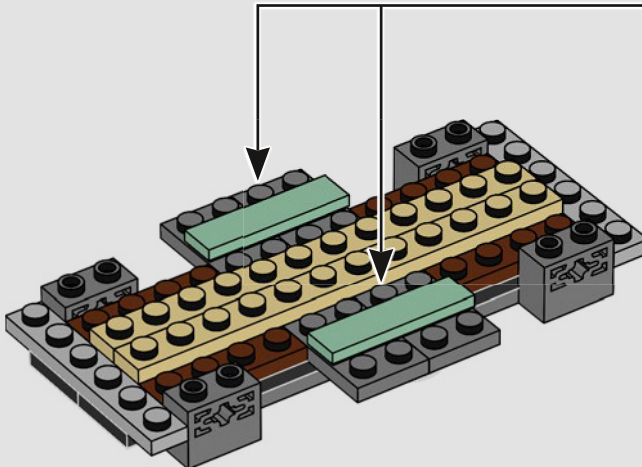
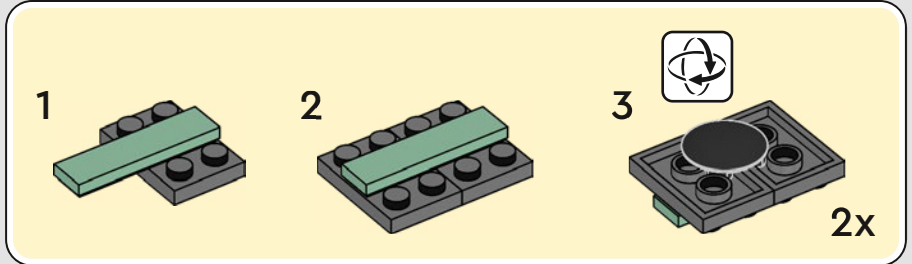

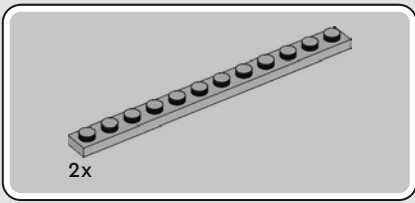

9

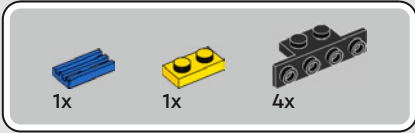
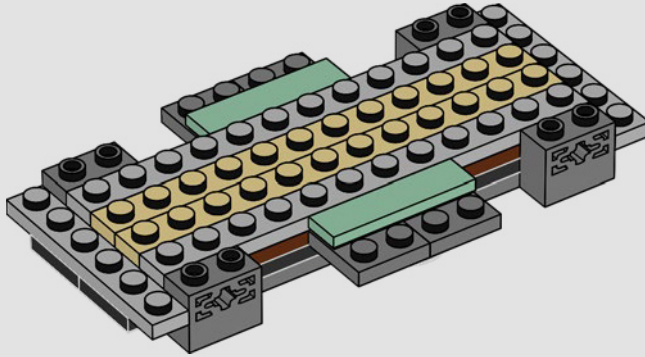

10

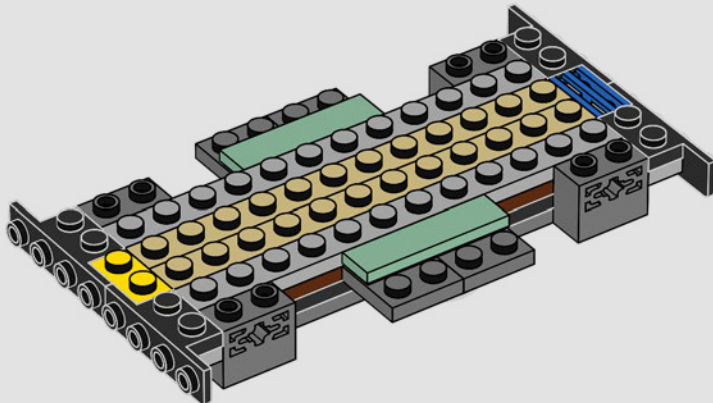

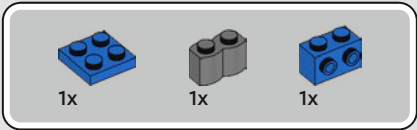

11

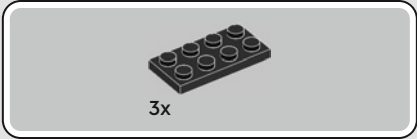
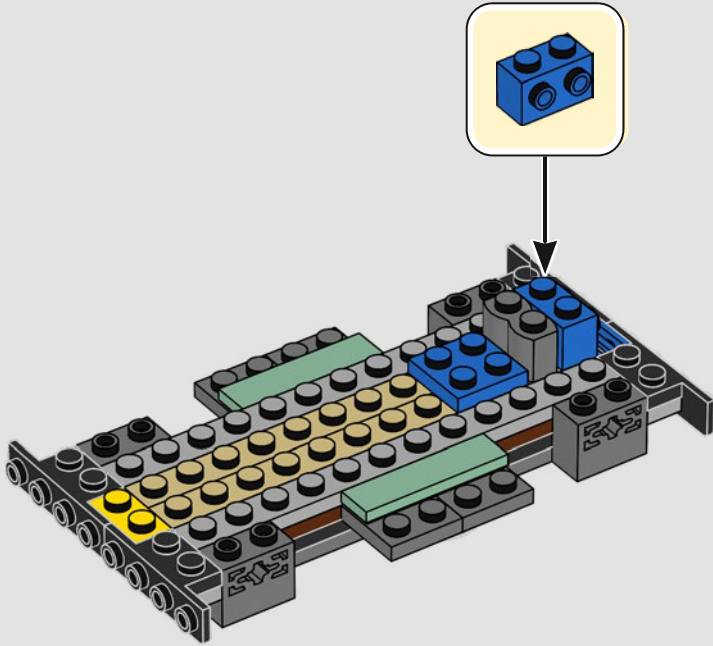

12

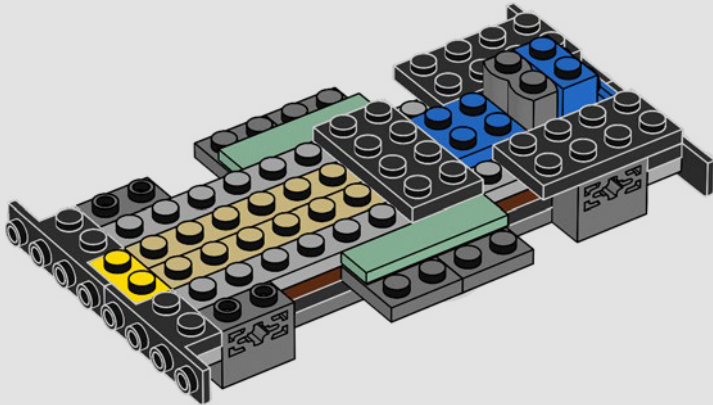



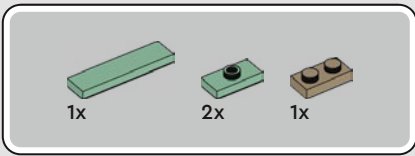

13

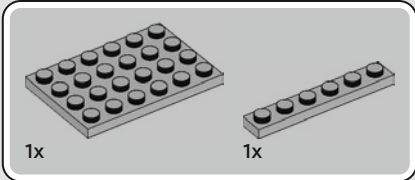
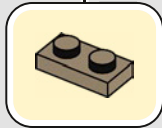
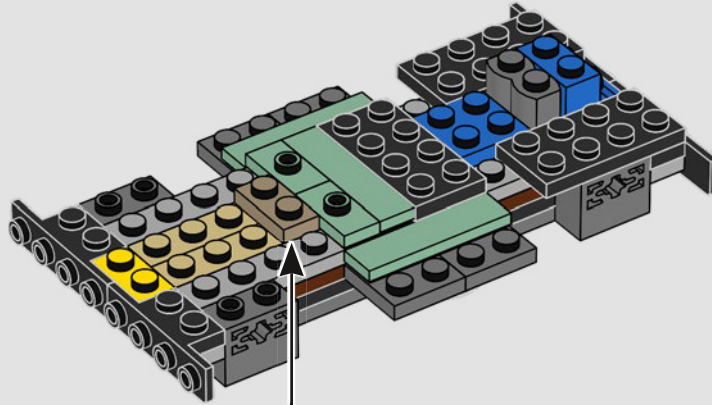

14

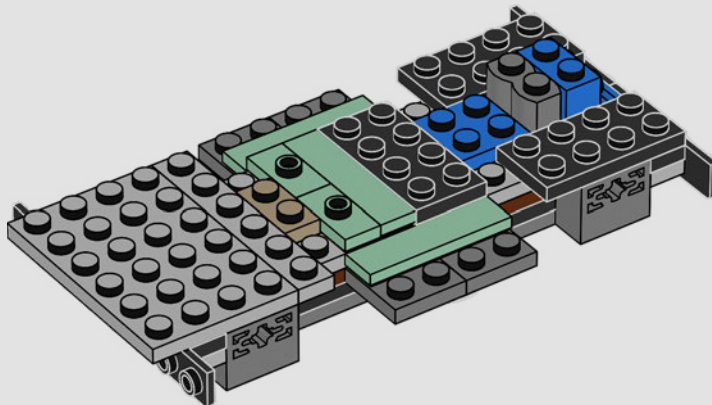

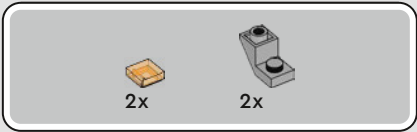

15

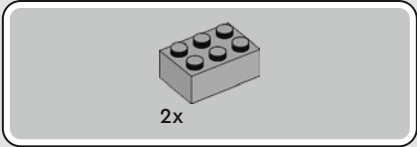
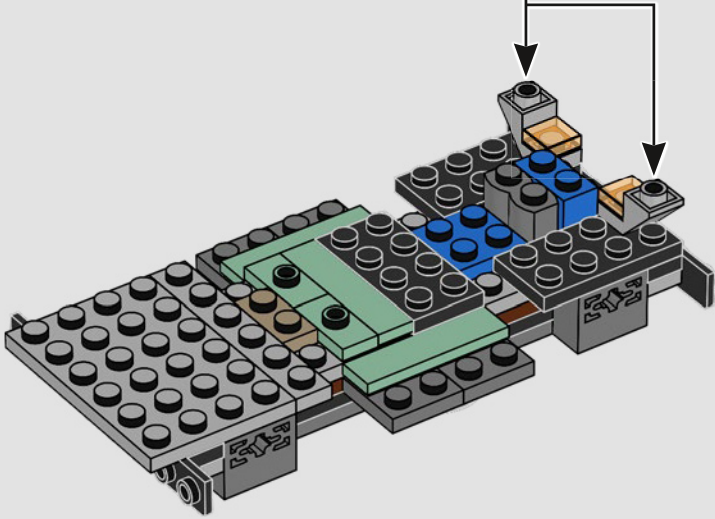
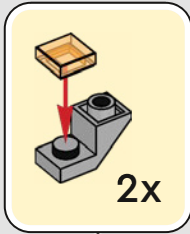

16

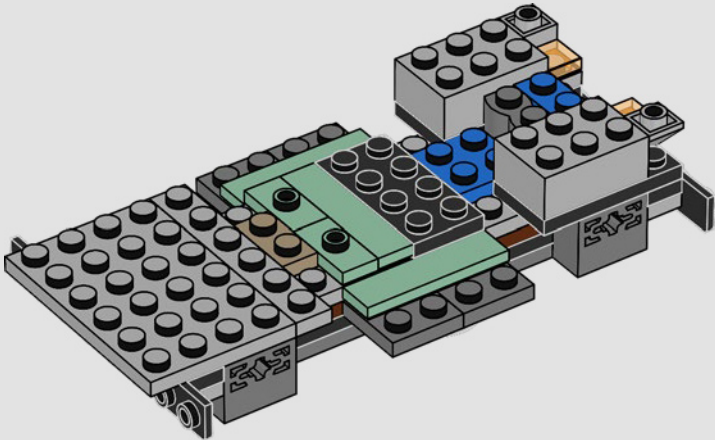



17

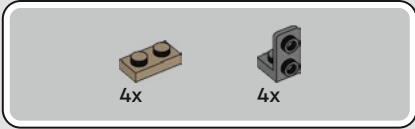
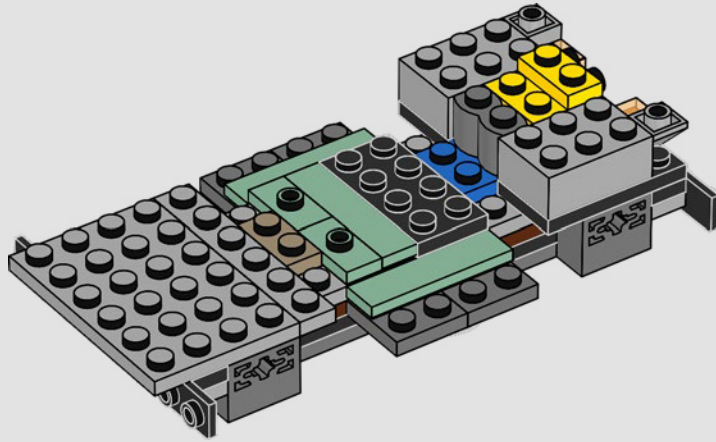

18

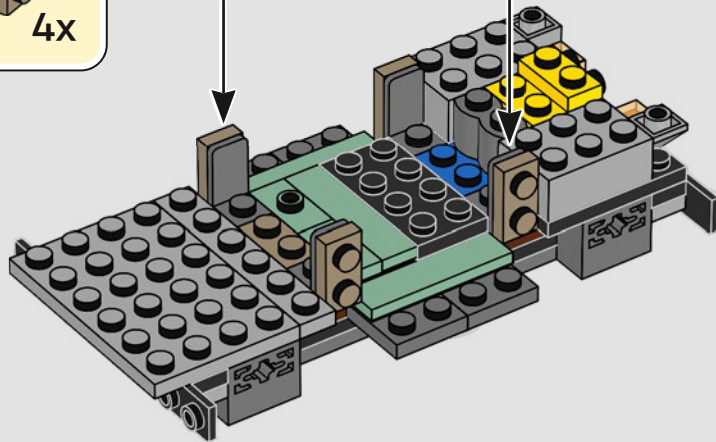
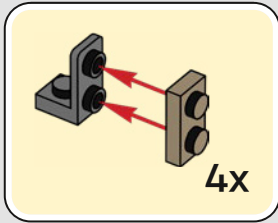





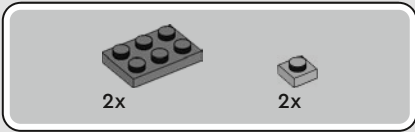

21

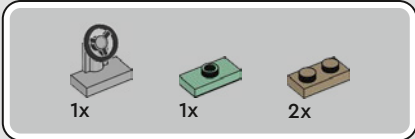
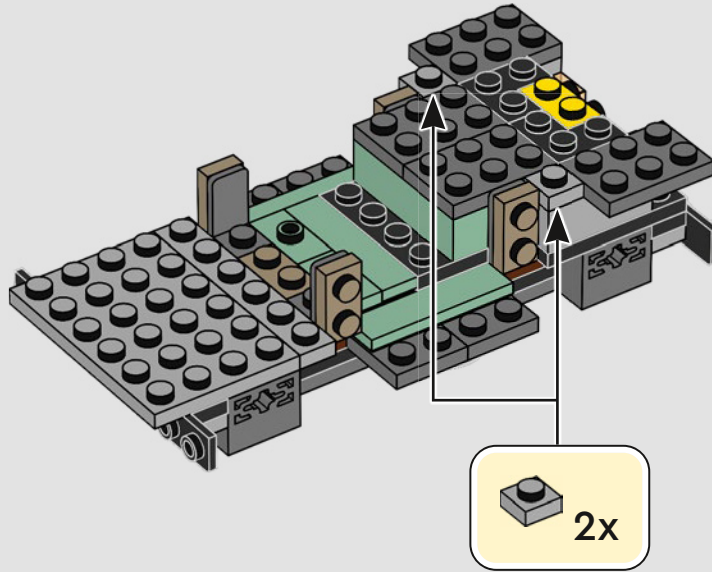

22

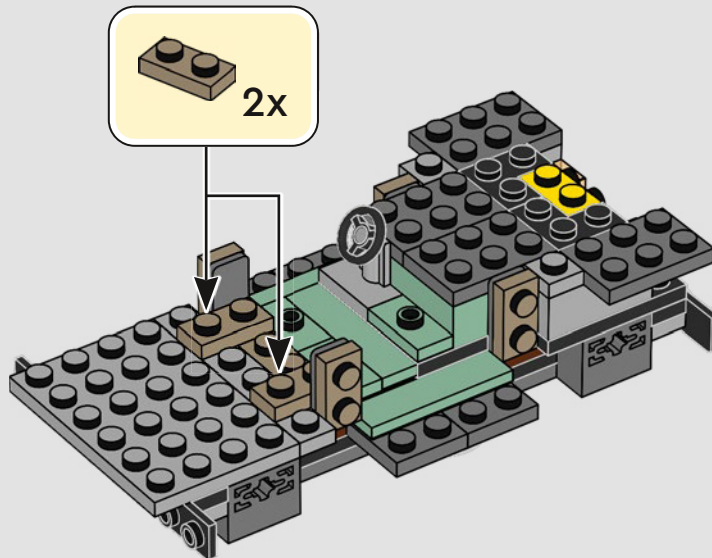

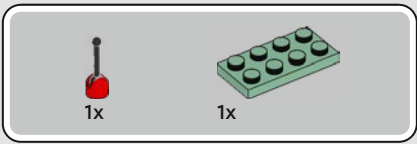

23

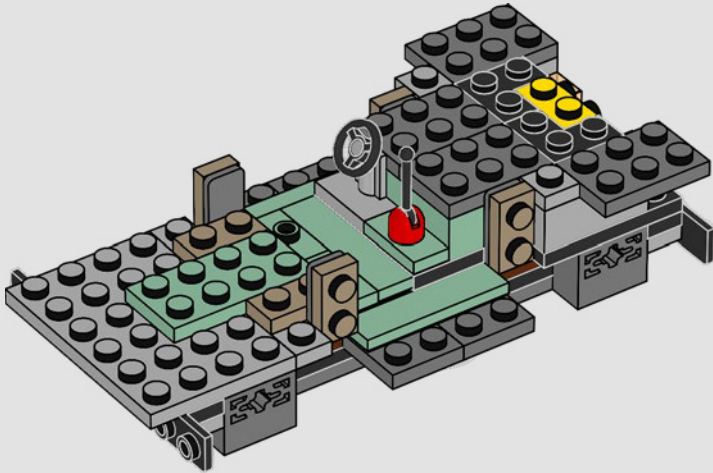

24

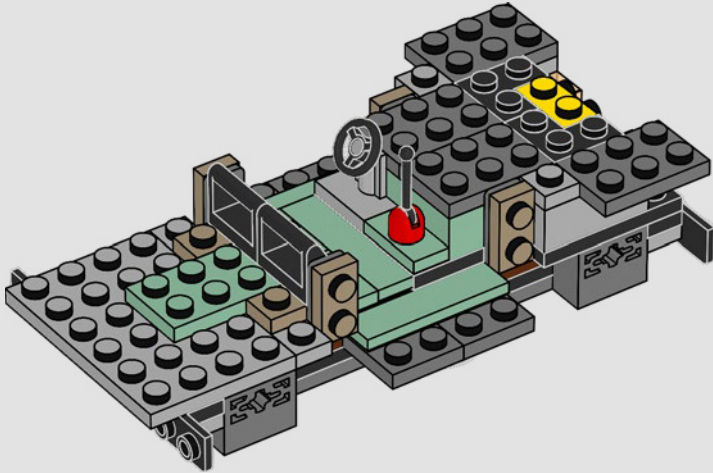

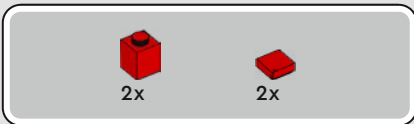

25

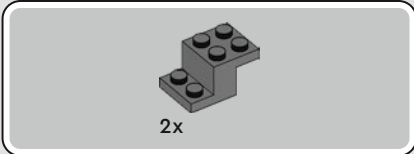
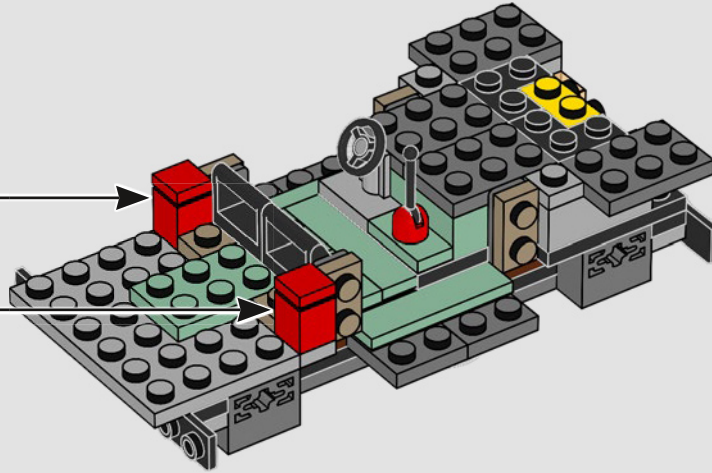
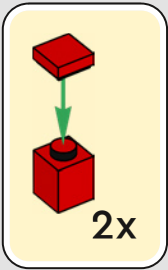

26

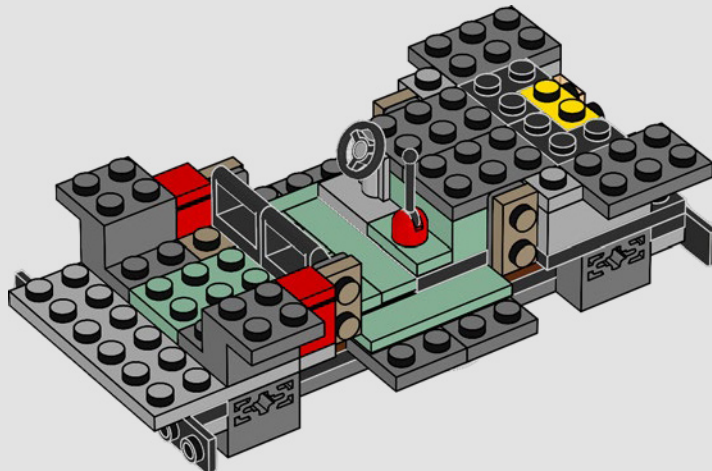

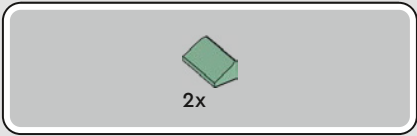

27

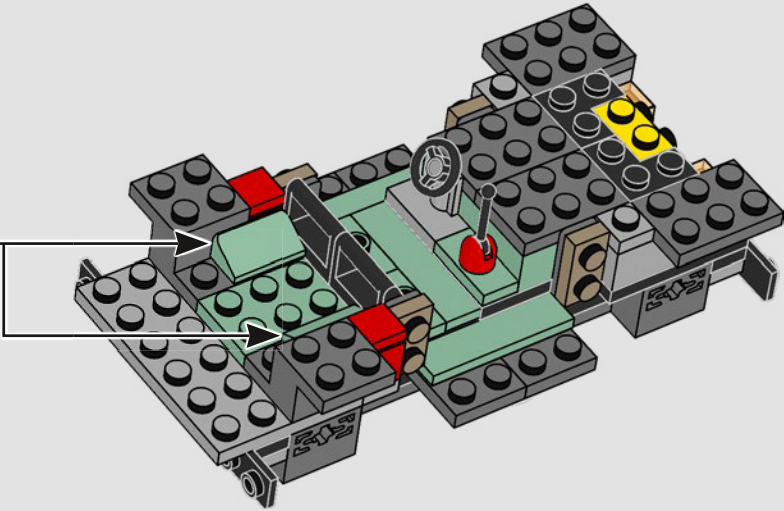
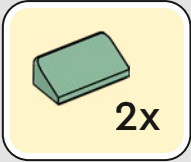

28

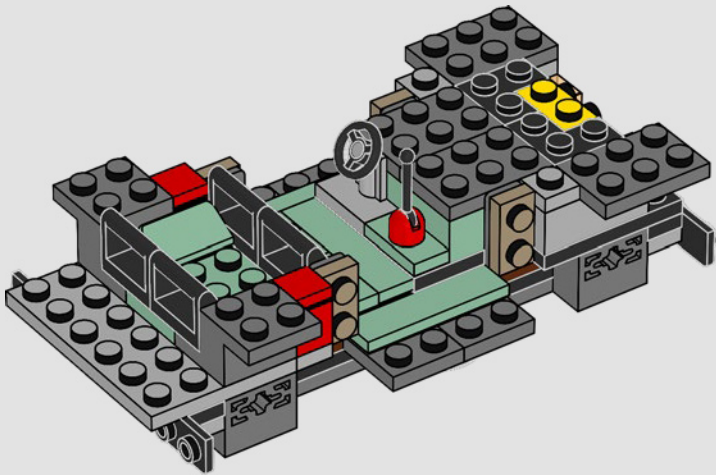



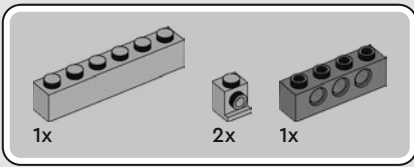

29

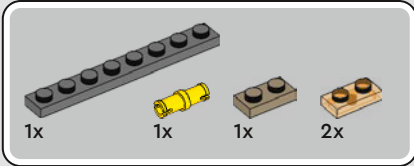
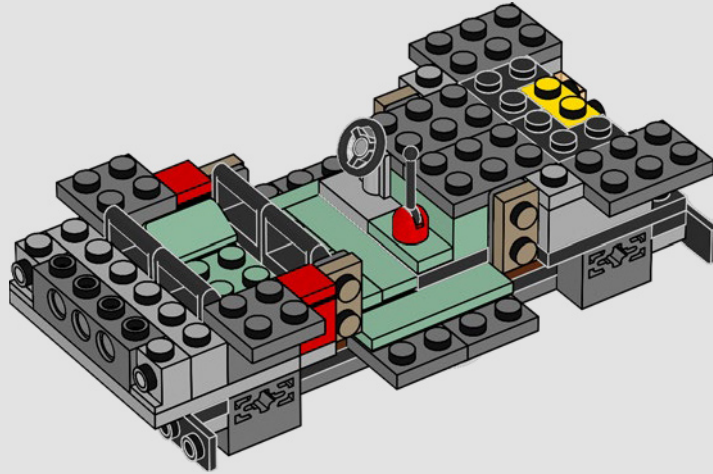

30

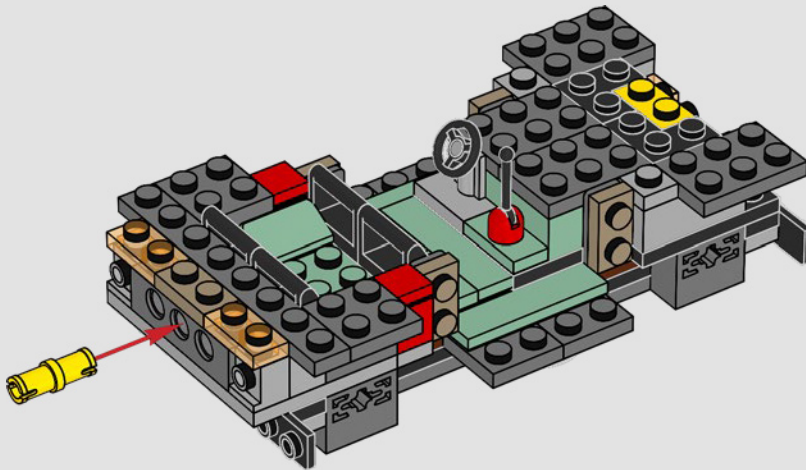

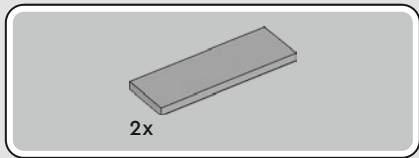

31

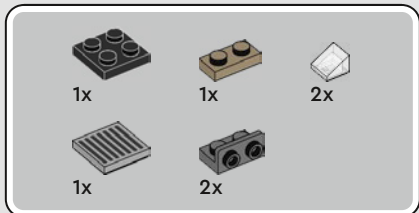
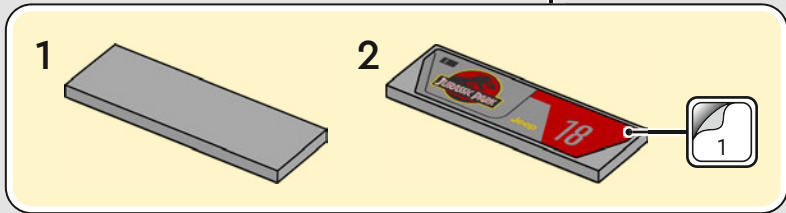
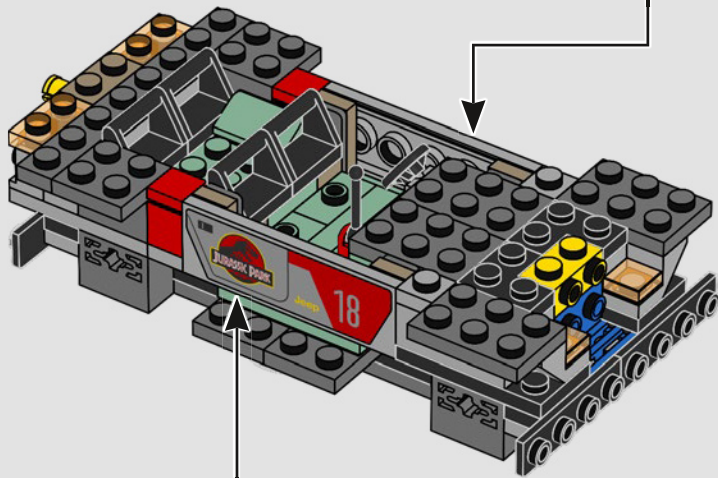
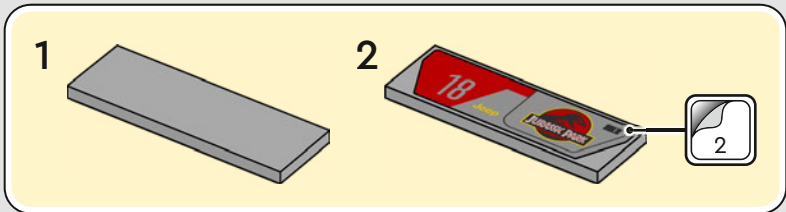

32

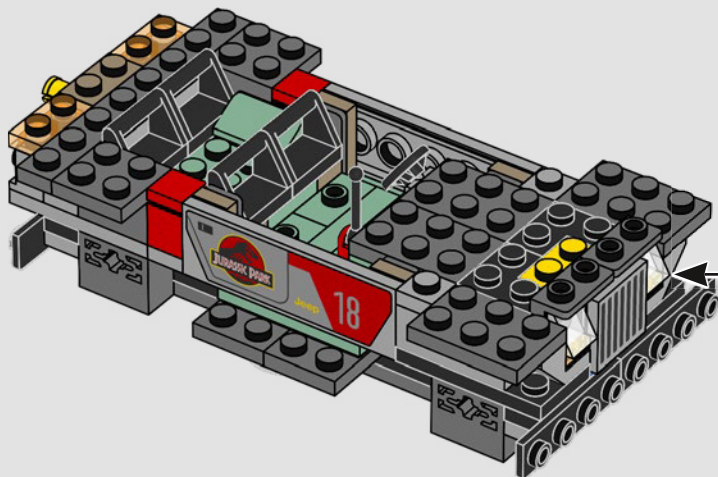
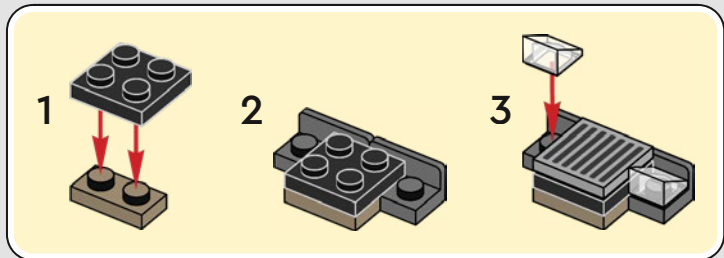

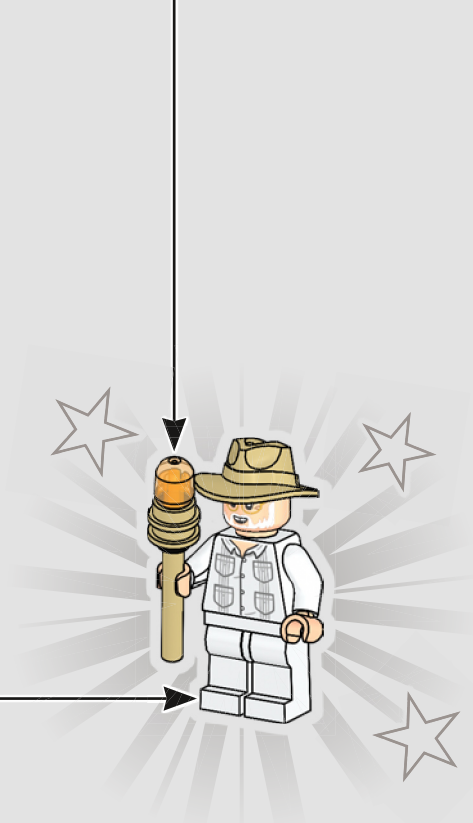
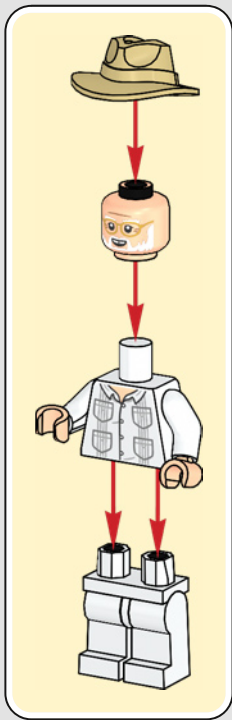
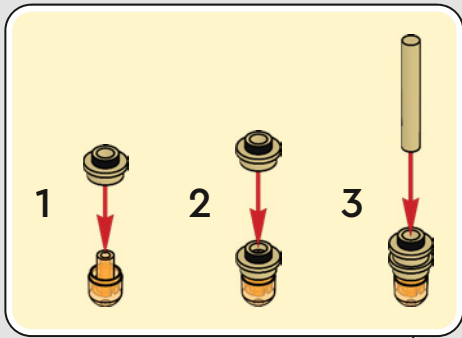

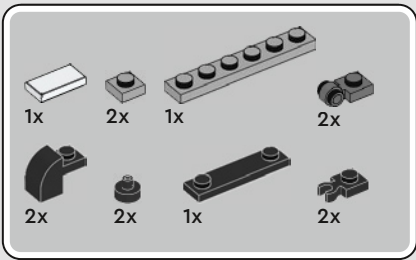

# 33

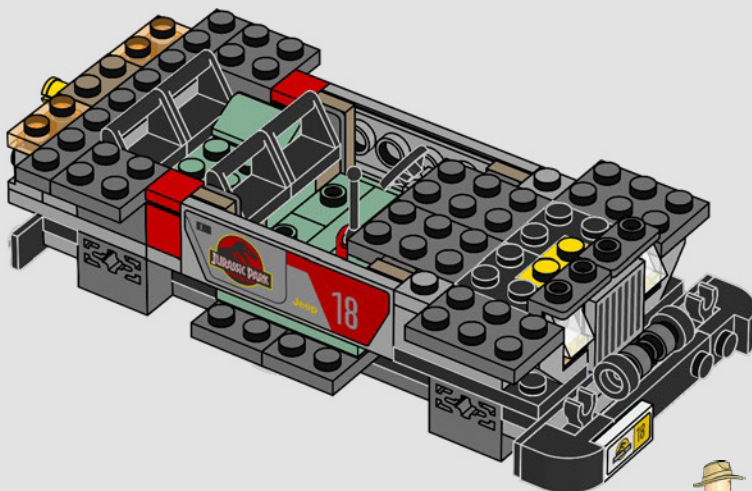
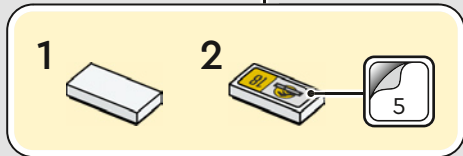
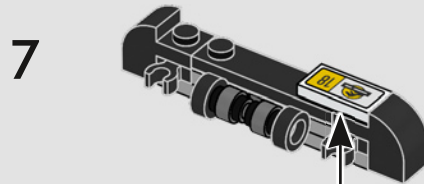
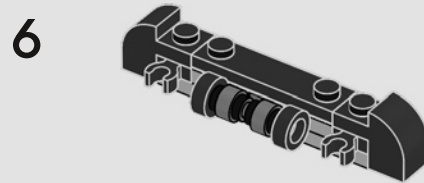
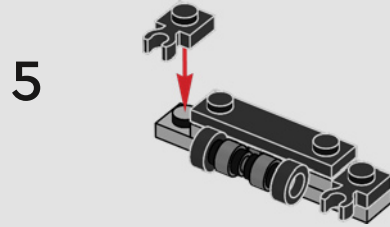
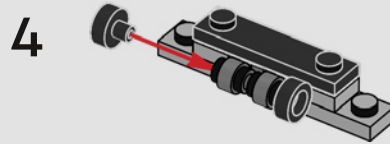
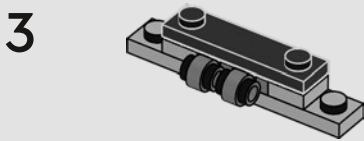
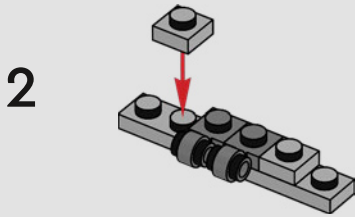
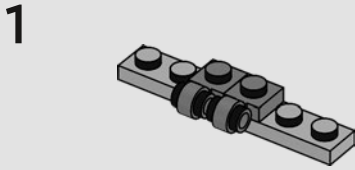



2x

2x

# 34

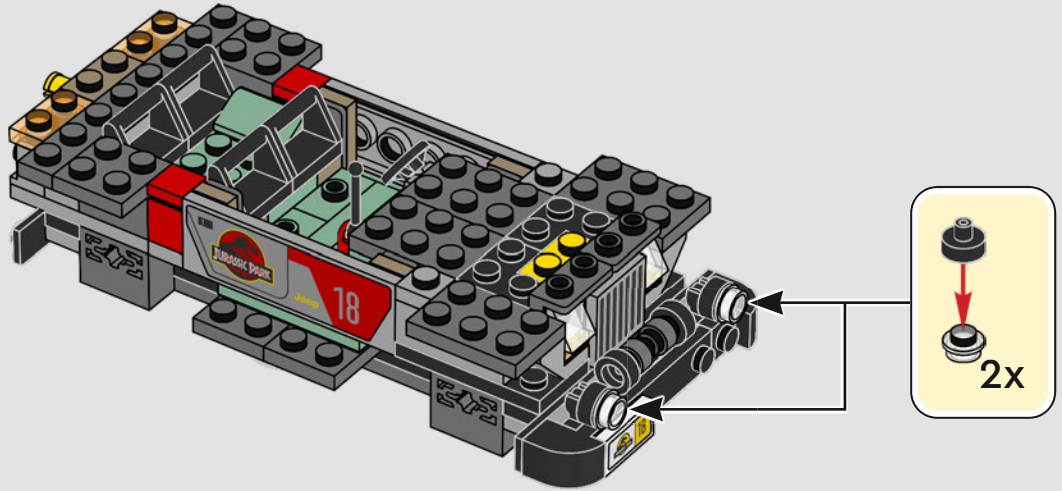

1x

2x

# 35

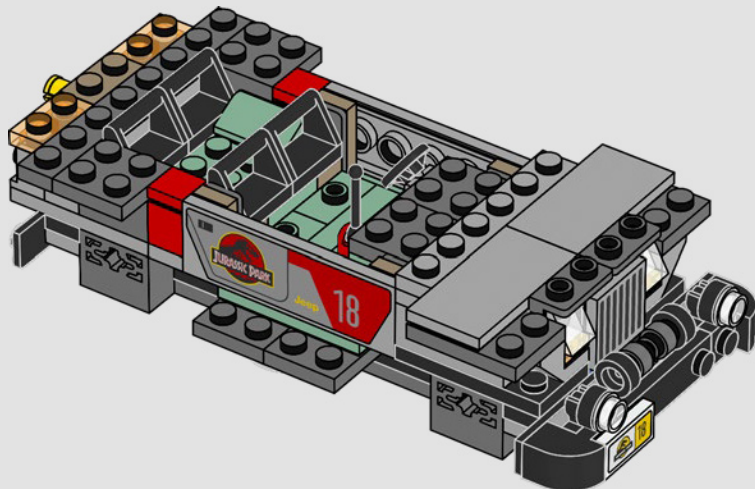

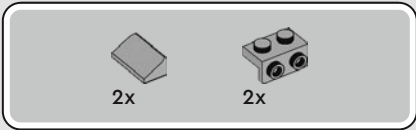

36

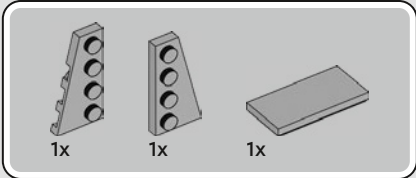
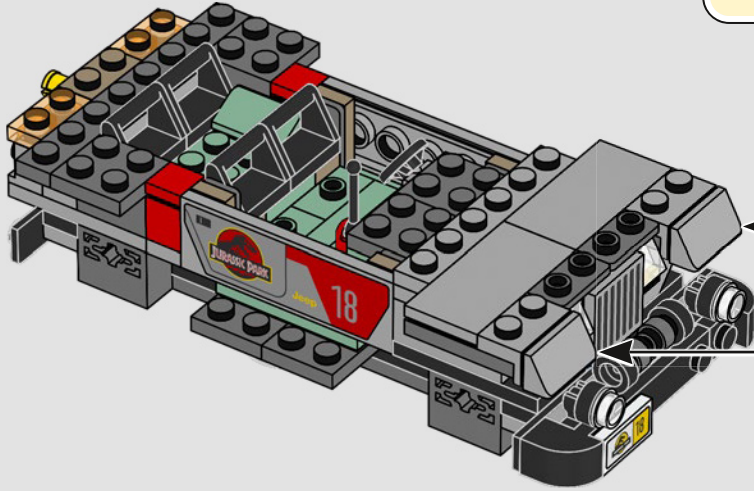
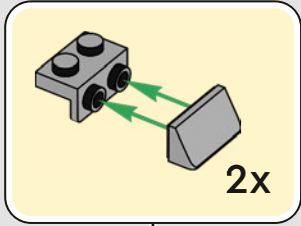

37

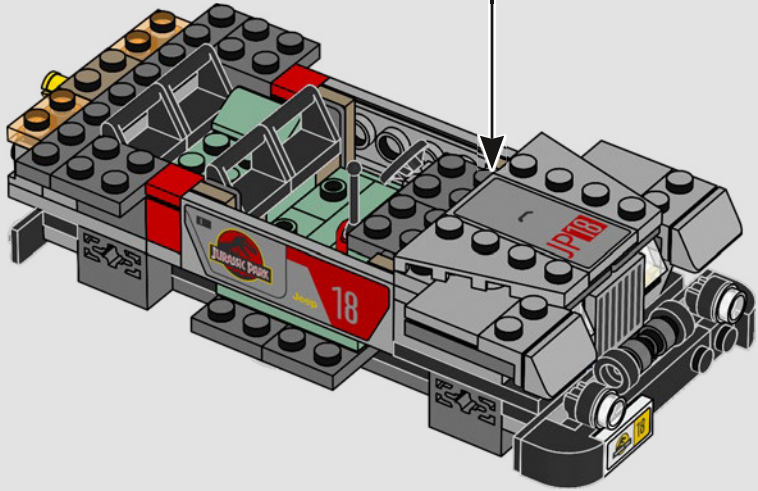
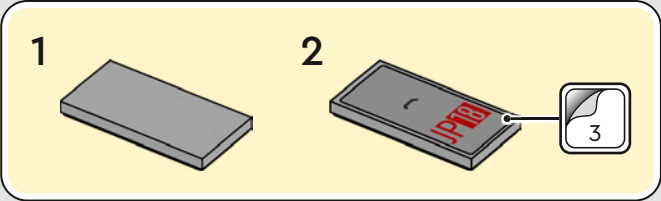

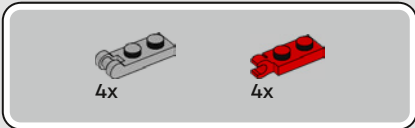

38

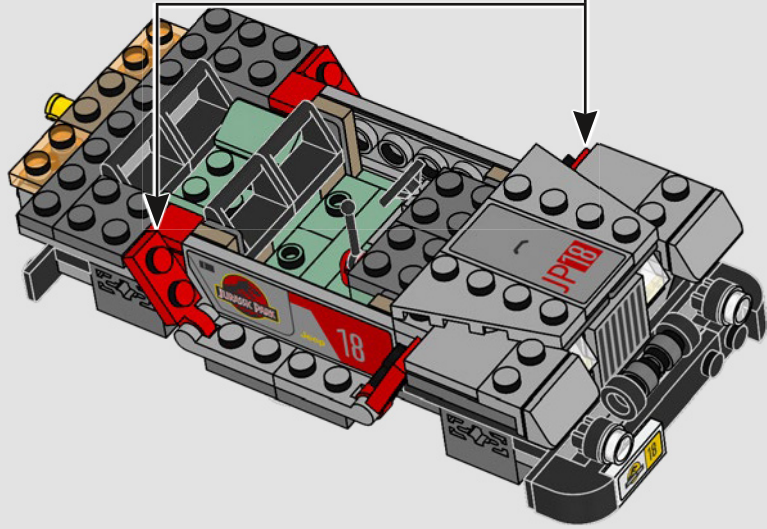
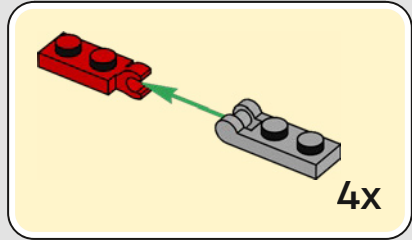

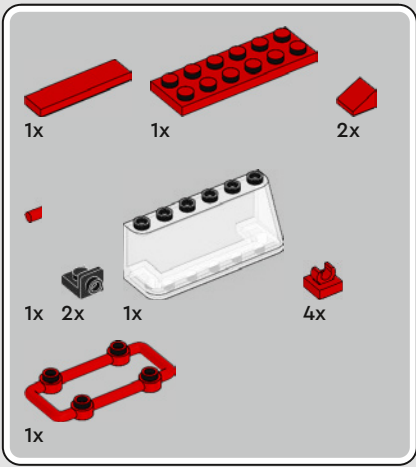

39

1

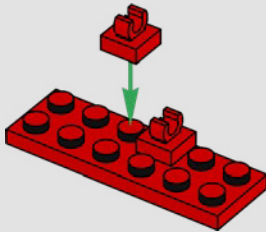

2

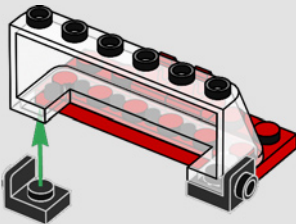

3

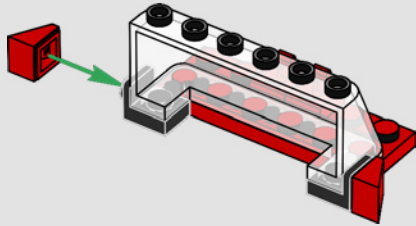

4

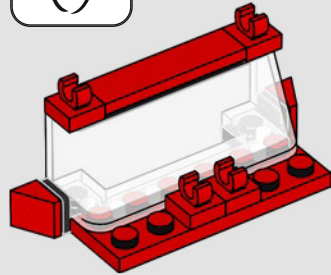

5

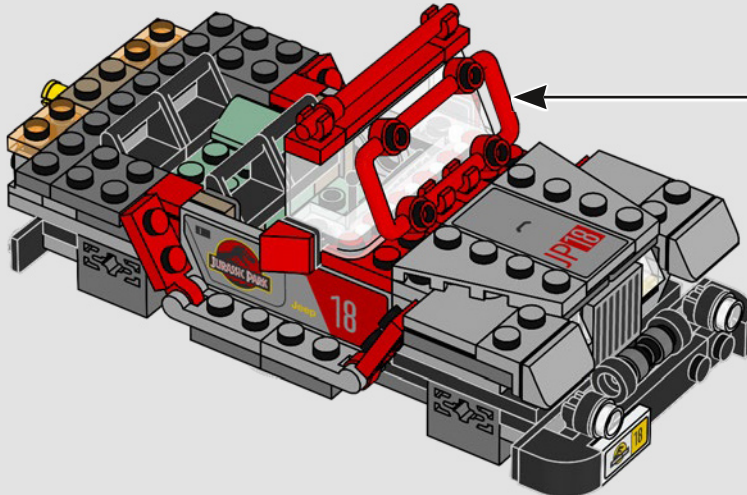
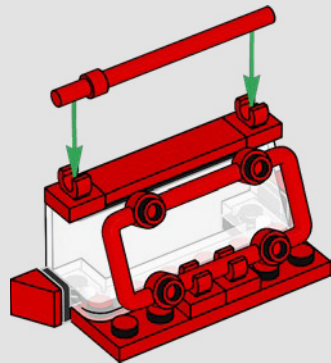



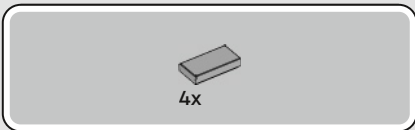

40

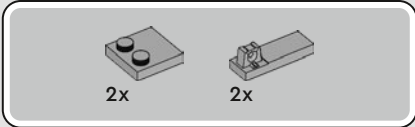
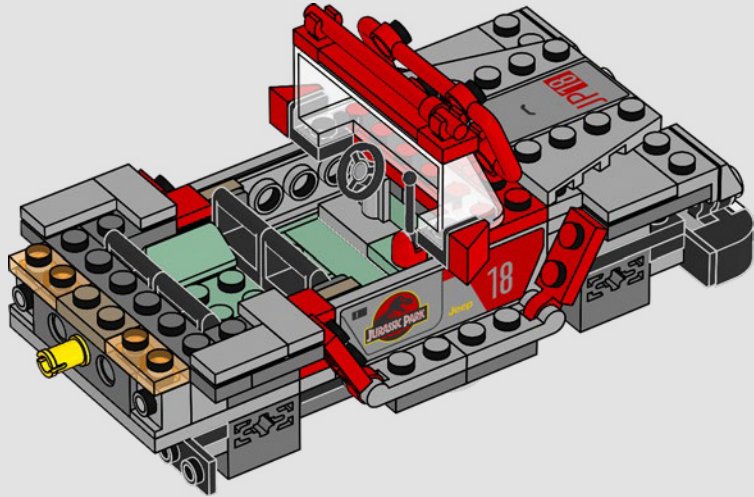

41

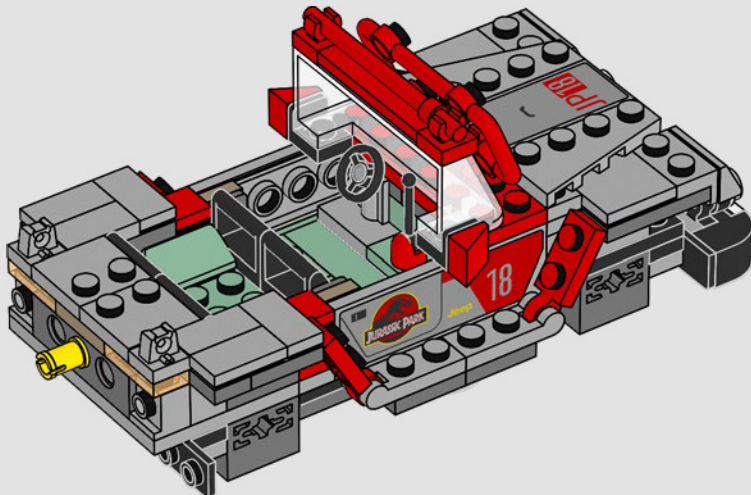



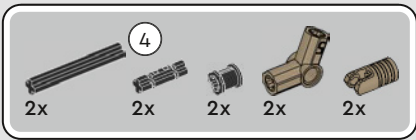

42

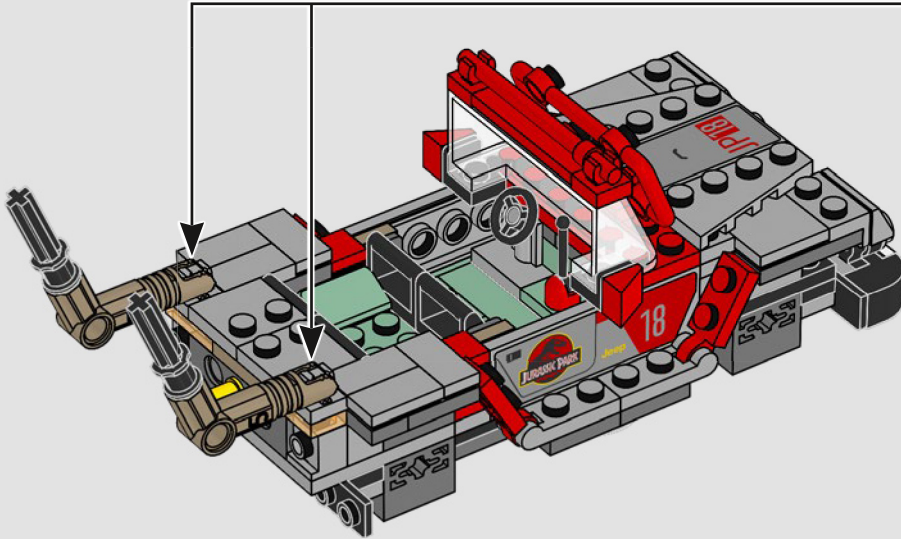
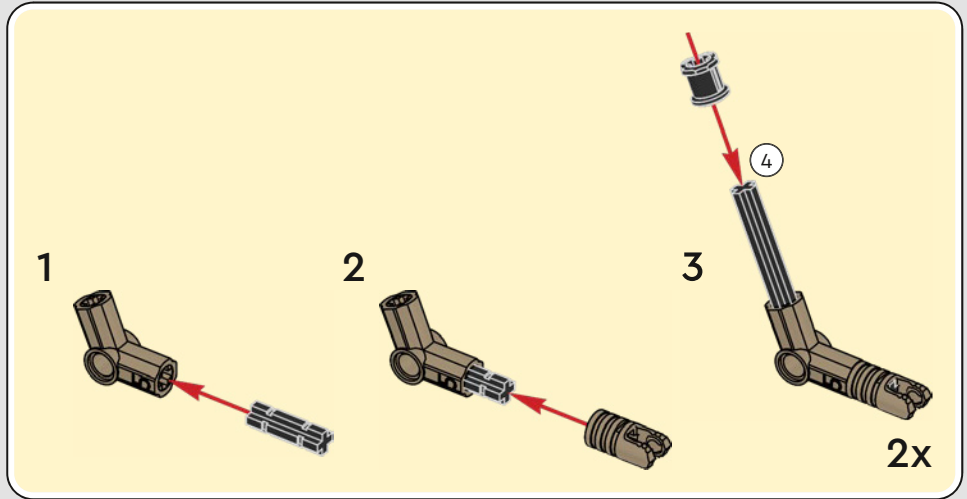

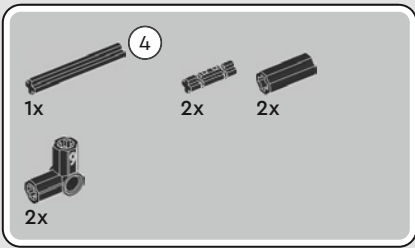

# 43

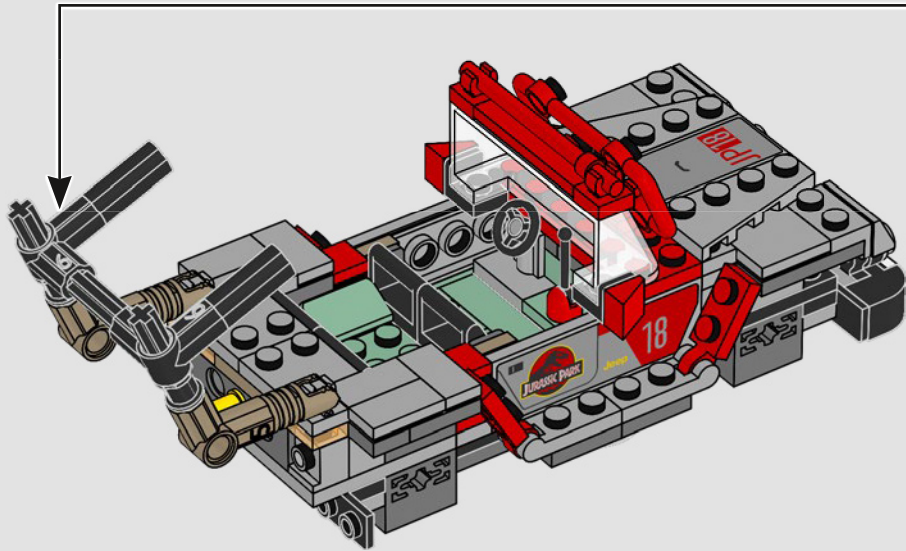
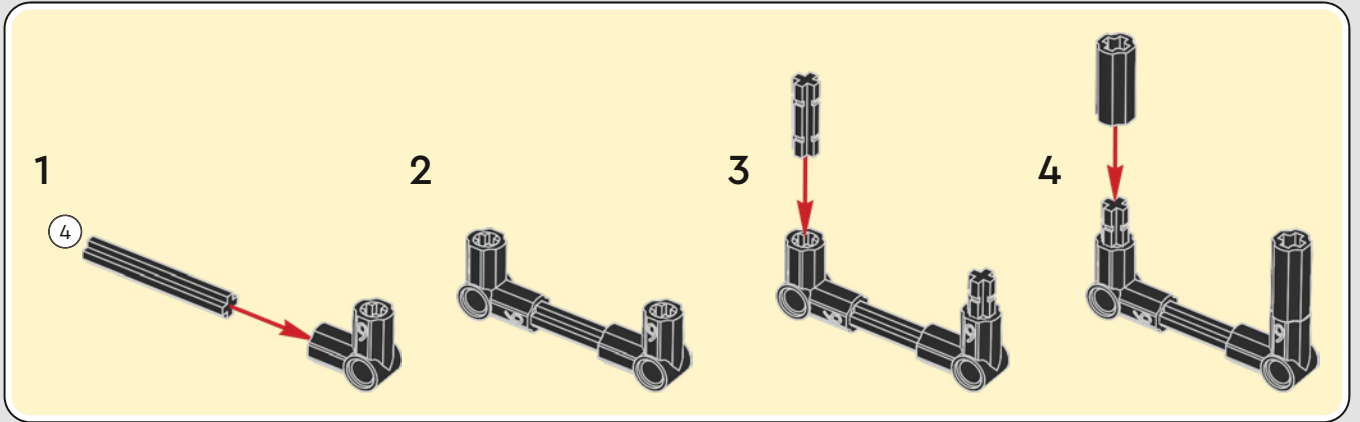

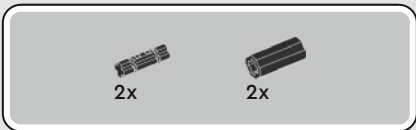

44

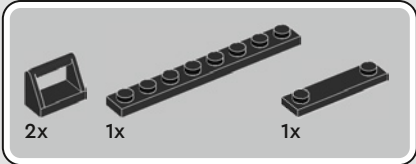
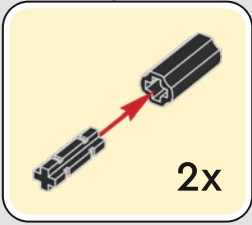
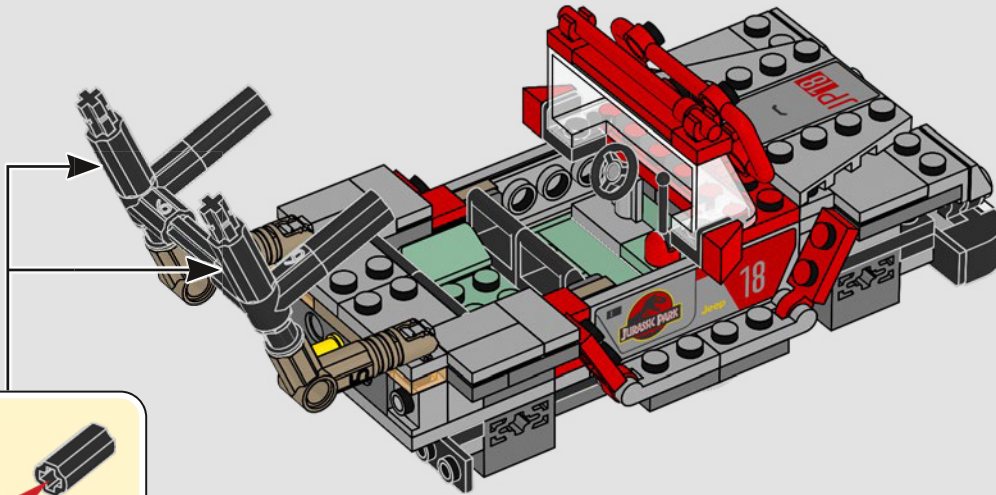

45

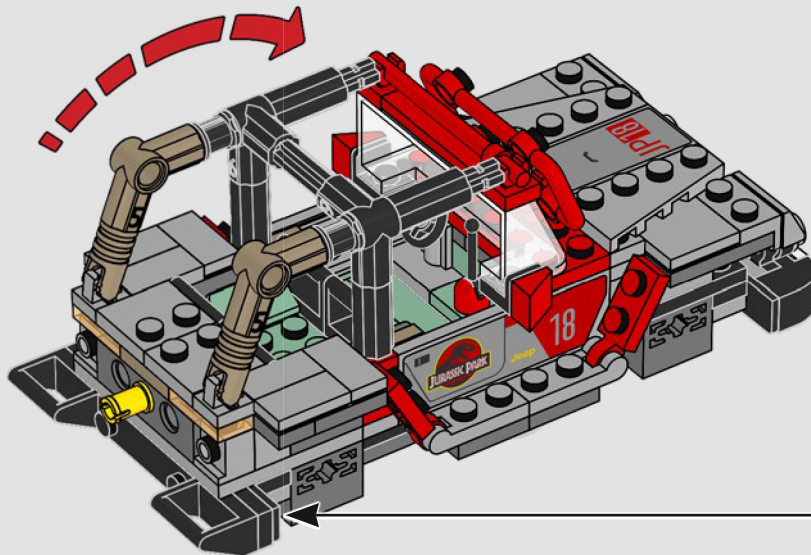
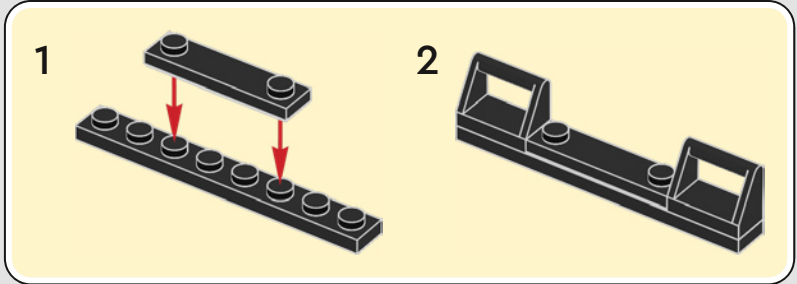

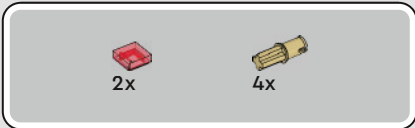

46

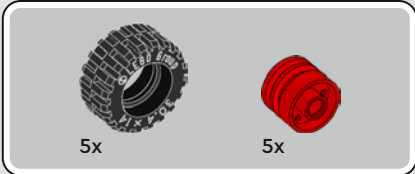
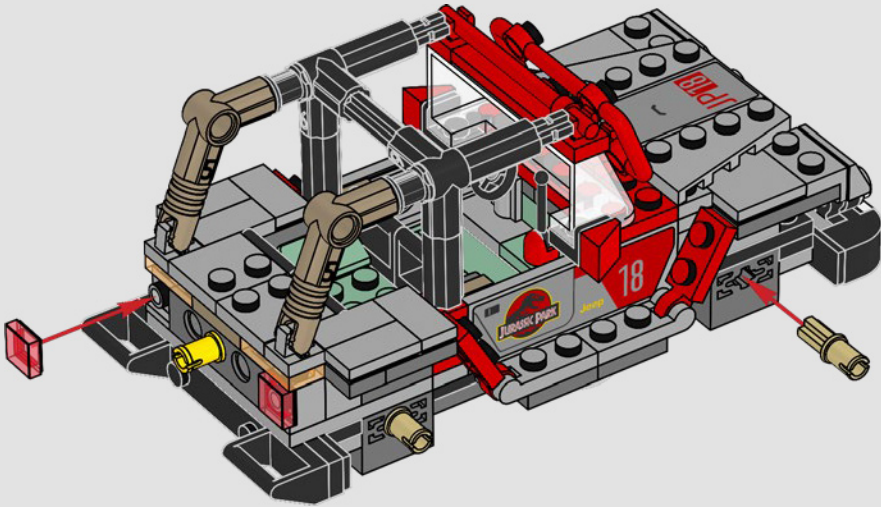

47

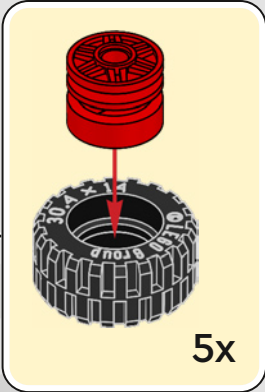
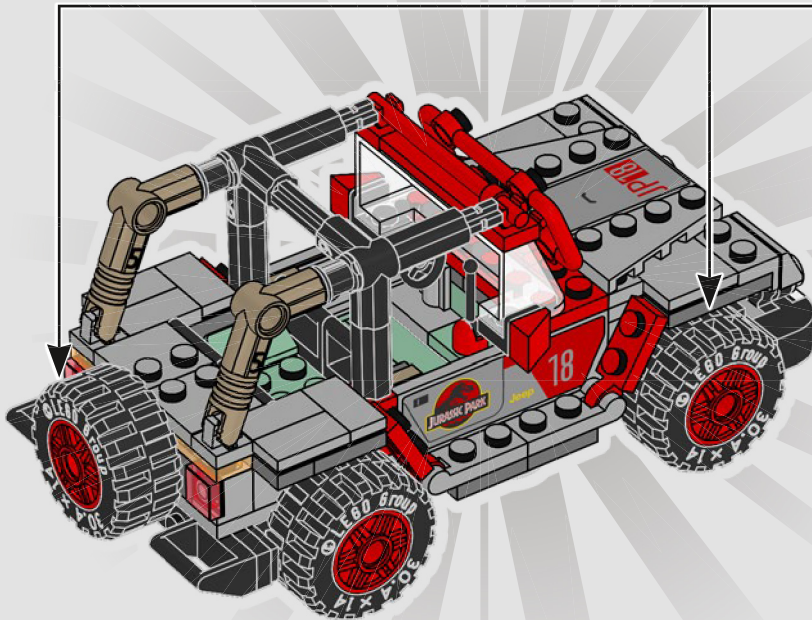



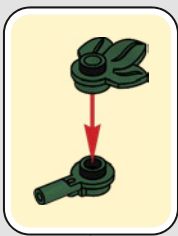
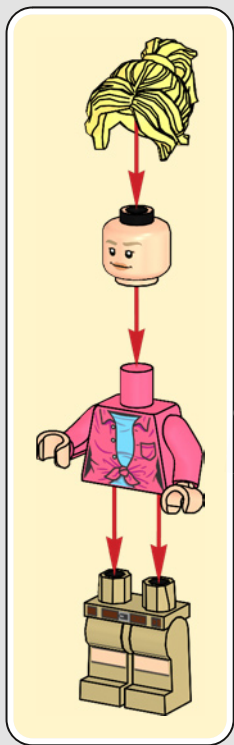



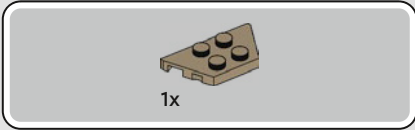

1

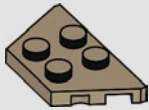

2

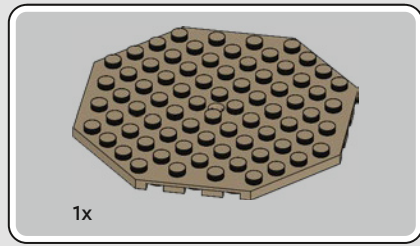

3

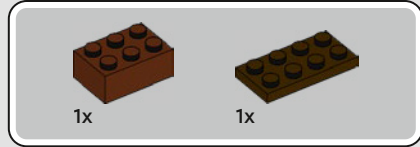
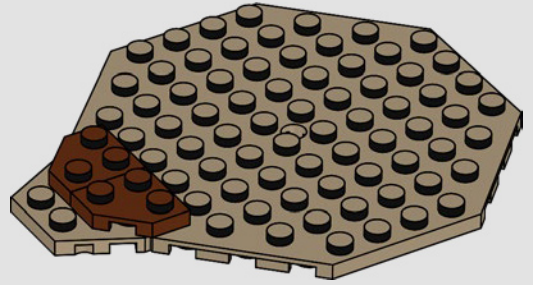

4

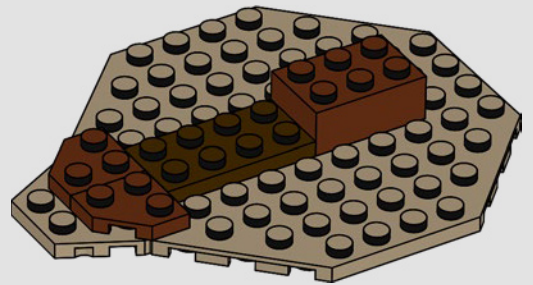

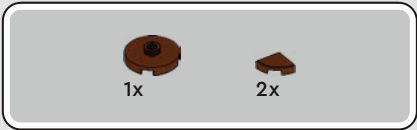

5

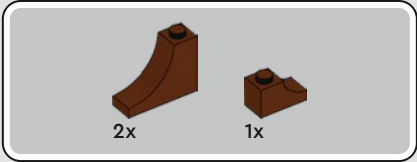
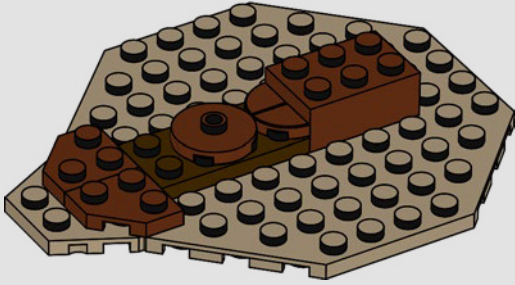

6

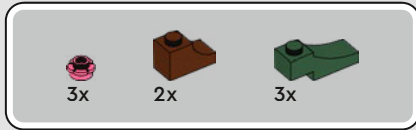
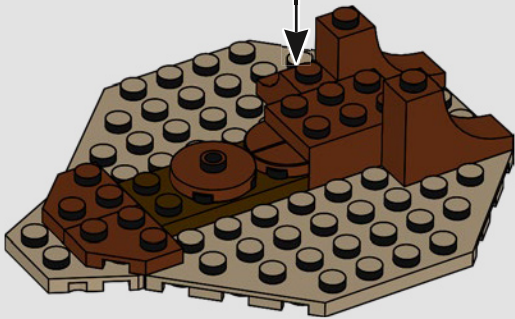

7

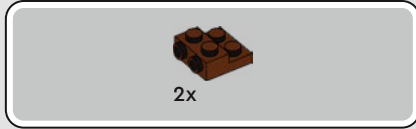
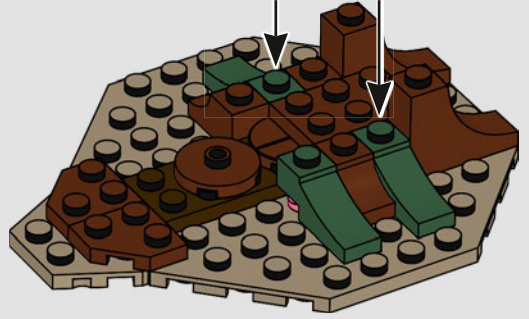
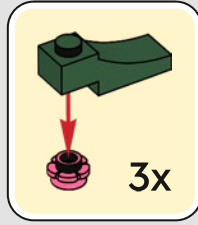

8

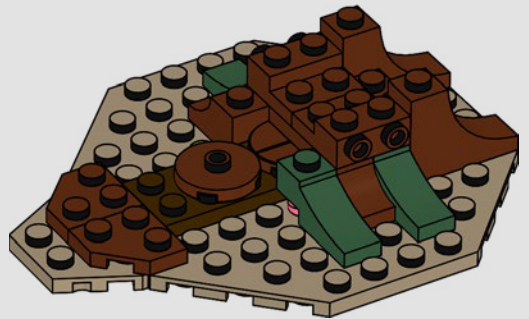

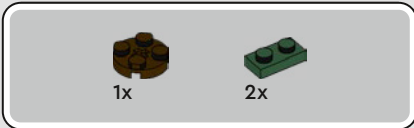

9

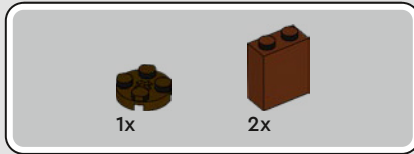
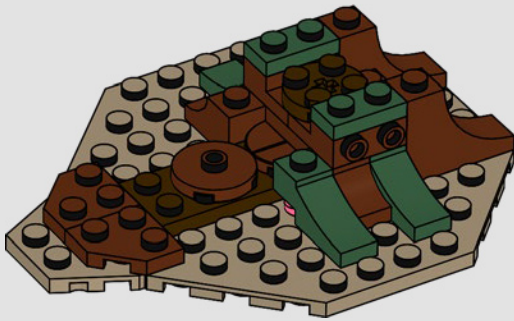

11

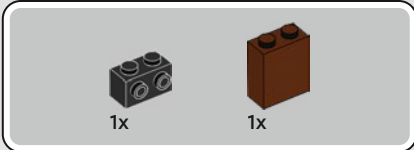
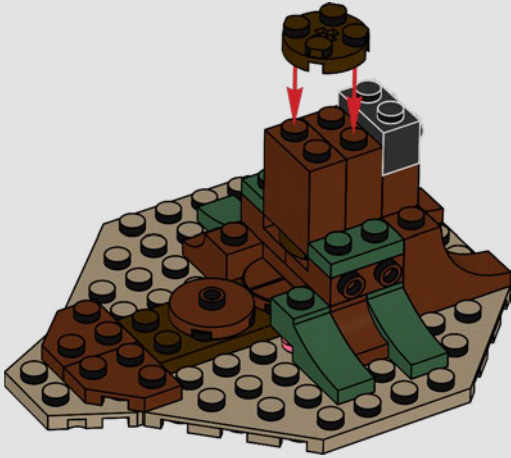

10

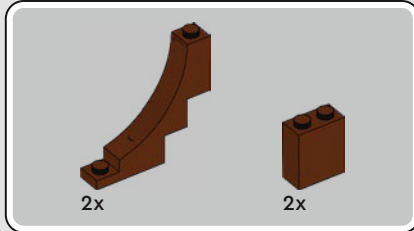
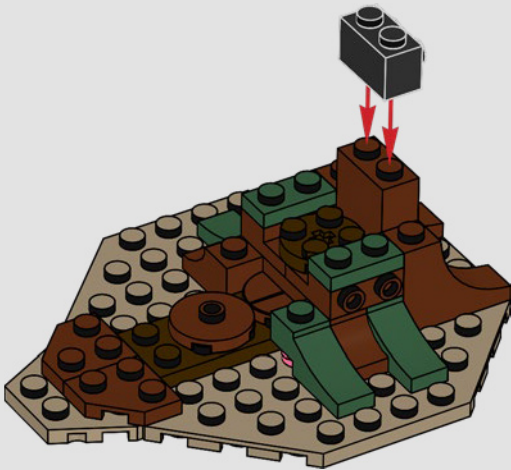

12

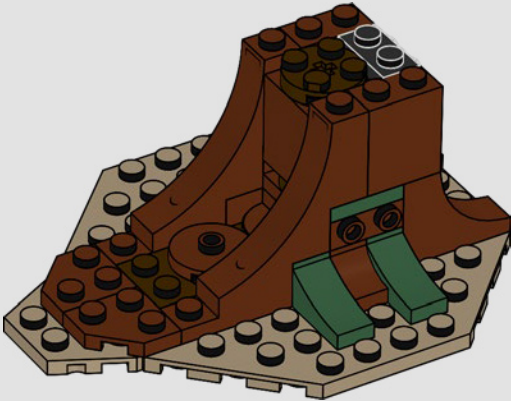



13

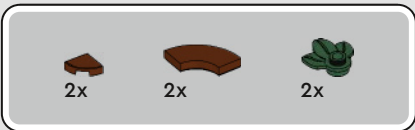
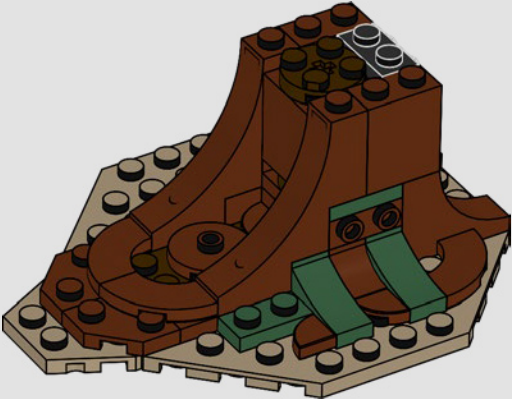

15

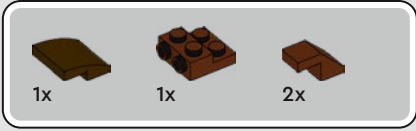
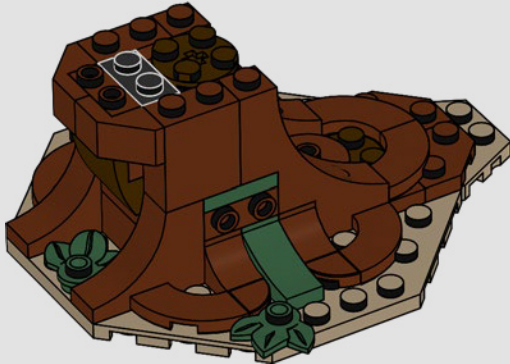

14

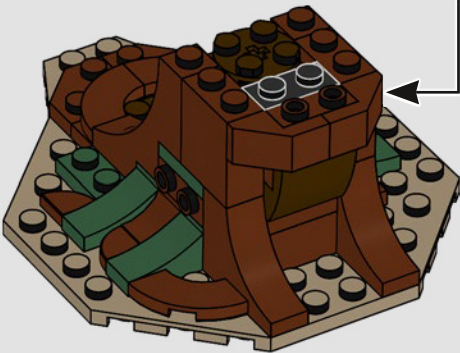
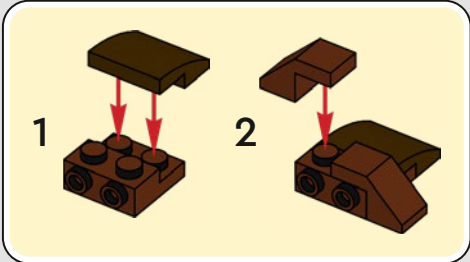

16

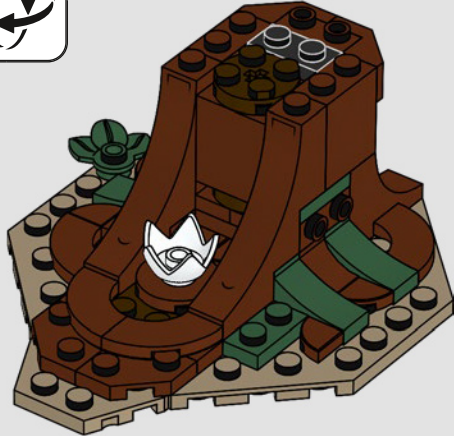



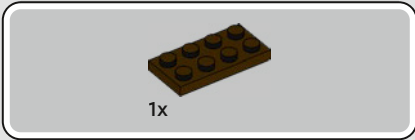
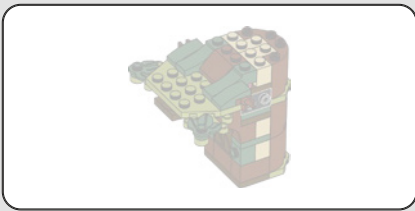

1x

17

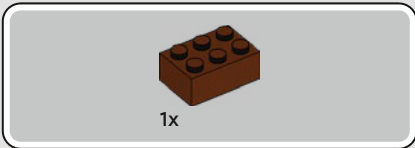
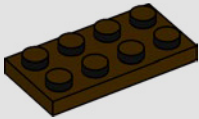

1x

18

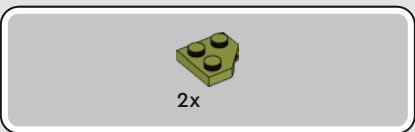
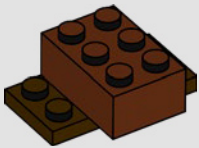

2x

19

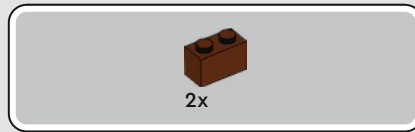
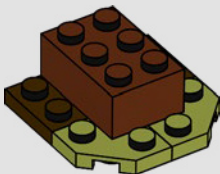

2x

20

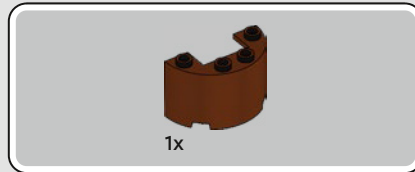
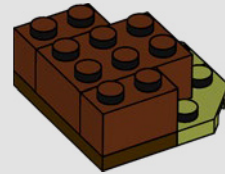

1x

21

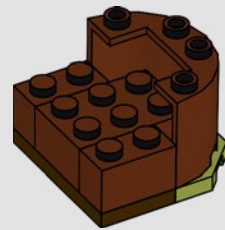

2x

2x

22

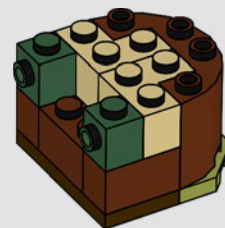



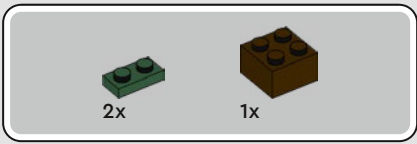

23

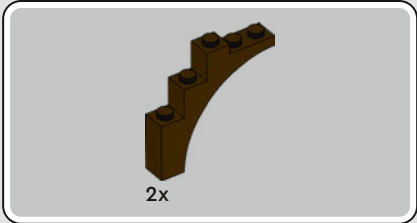
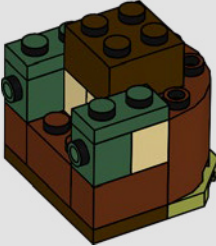

24

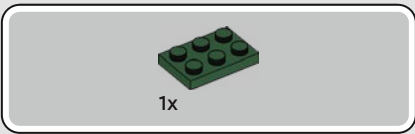
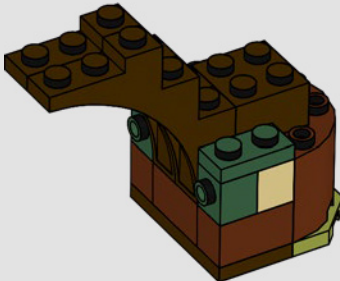

25

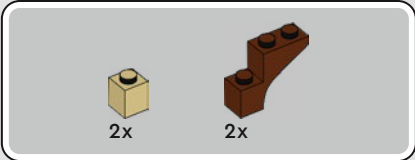
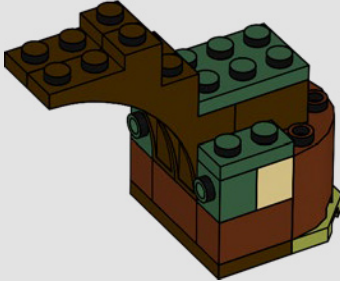

26

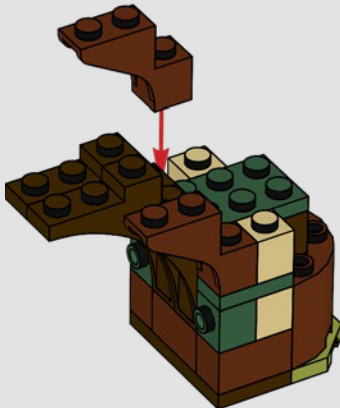

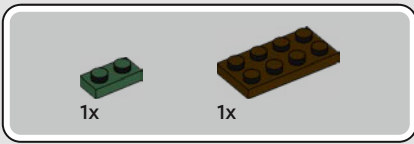

27

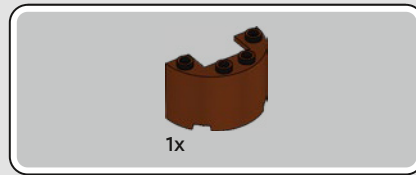
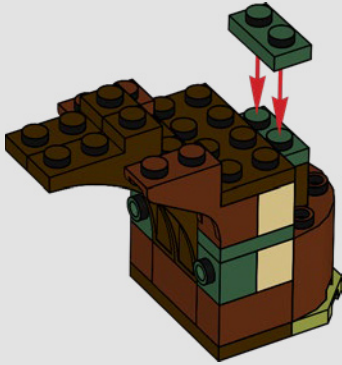

29

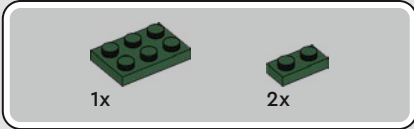
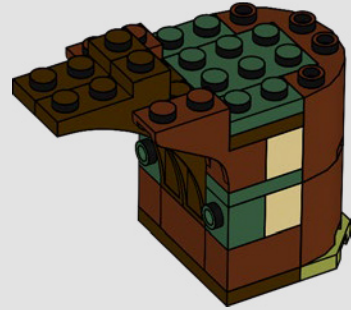

28

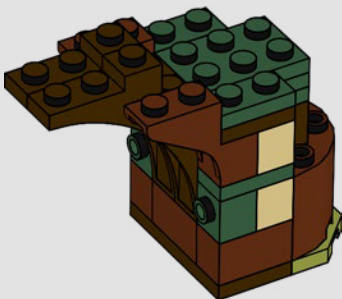

30

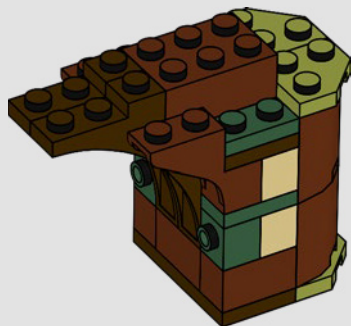

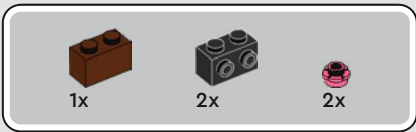

31

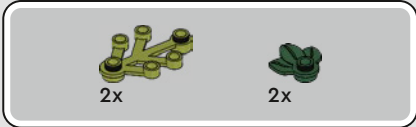

32

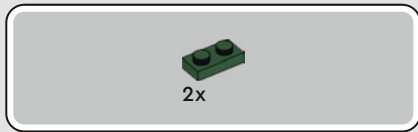
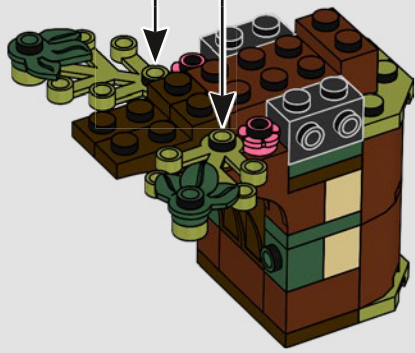
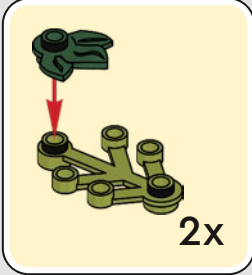

33

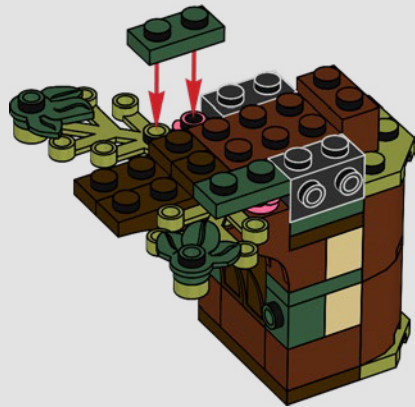

34

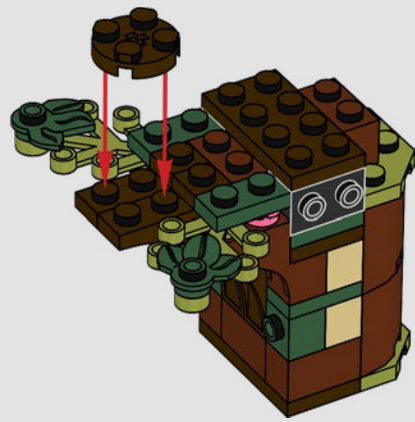

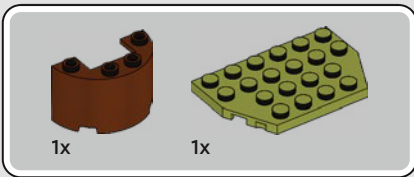

35

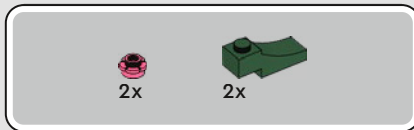
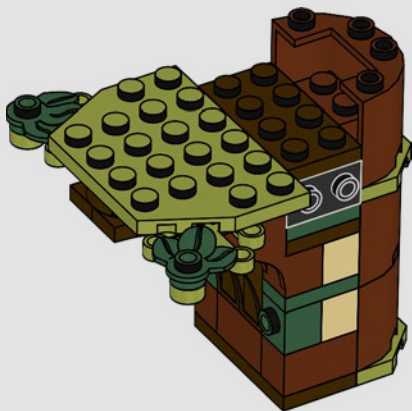

37

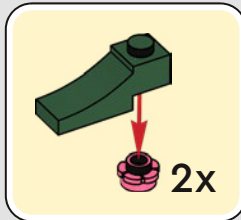

2x

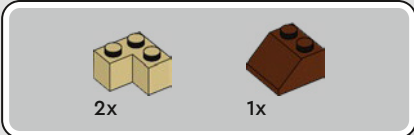
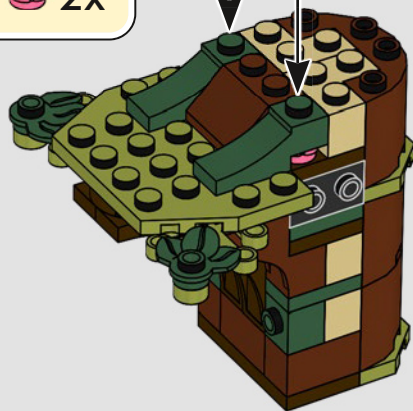

36

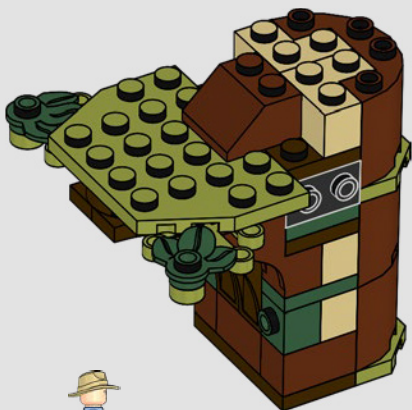

38

2x

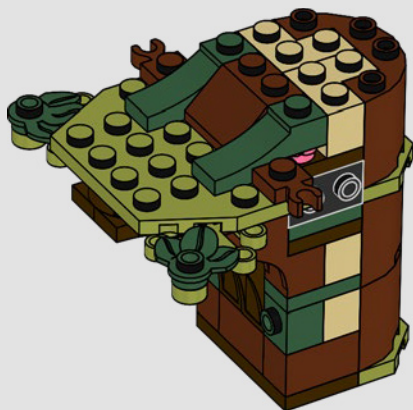





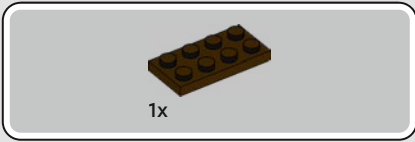
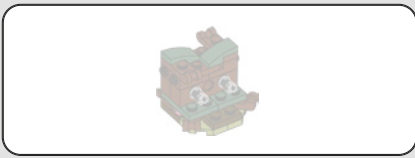

41

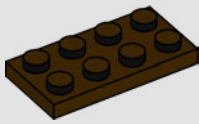

42

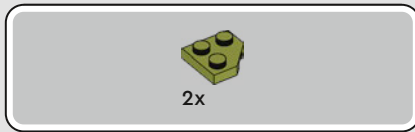
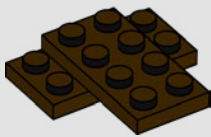

43

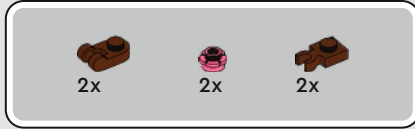
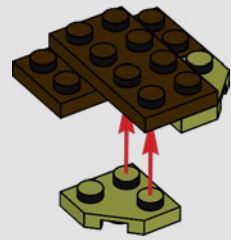

44



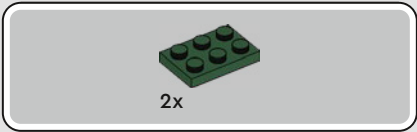

45

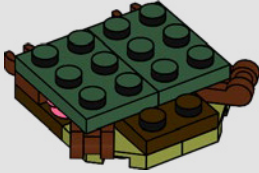

46

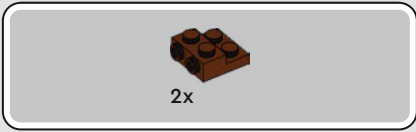
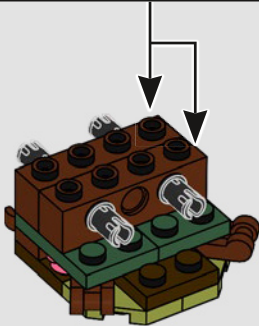
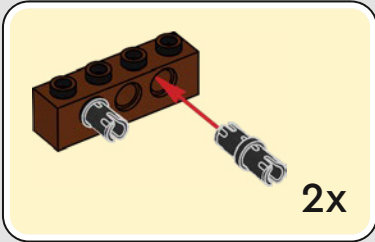

47

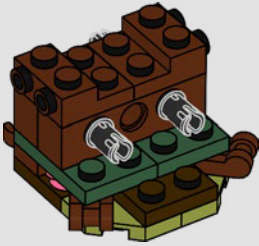

48

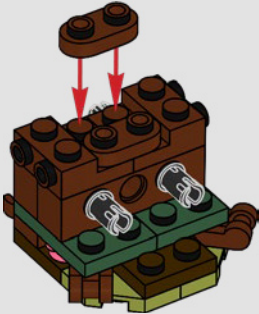



49

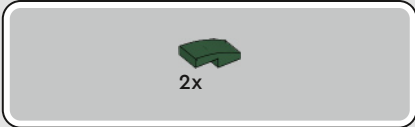
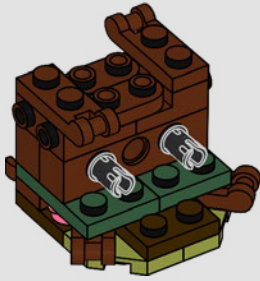

50

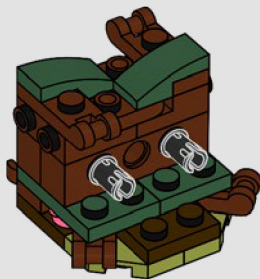

51

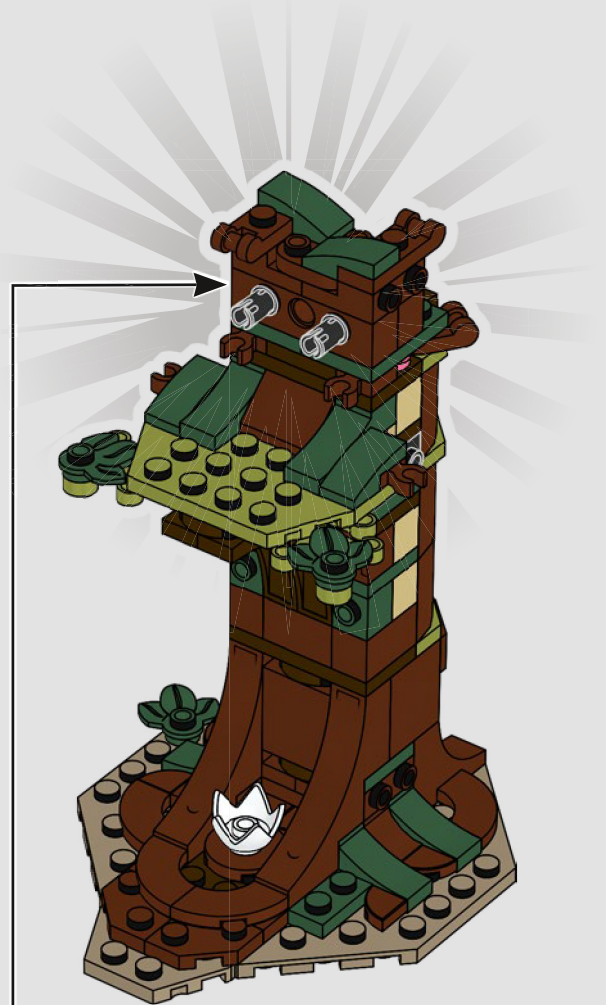

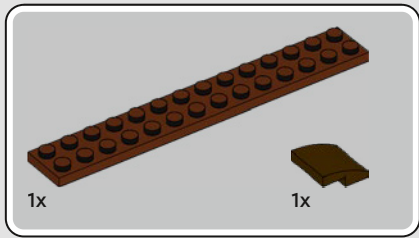

52

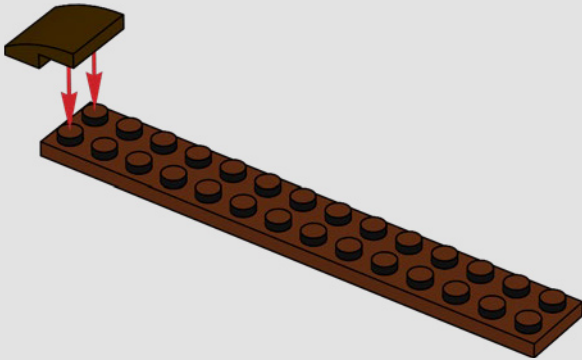

53

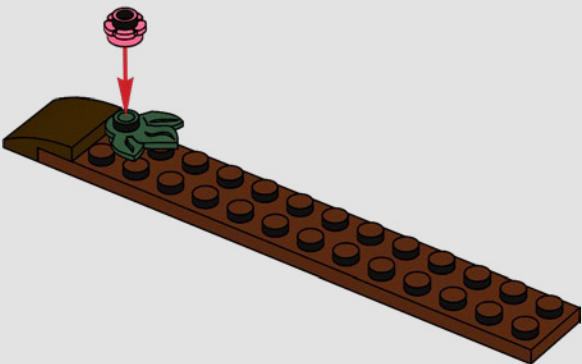

54

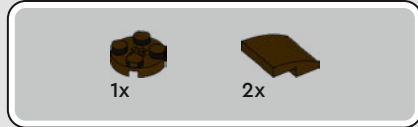
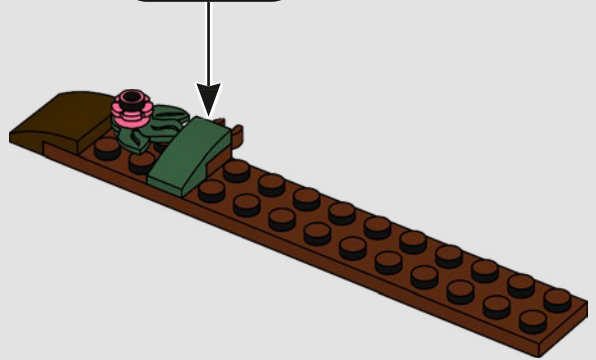
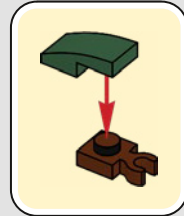

55

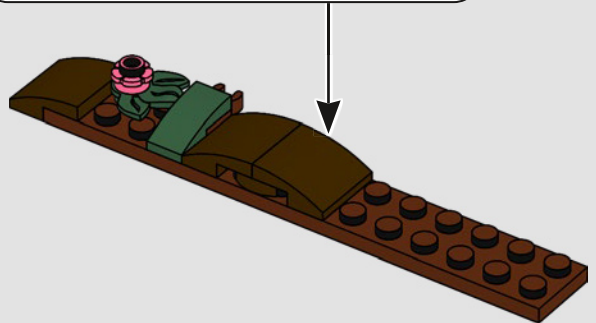
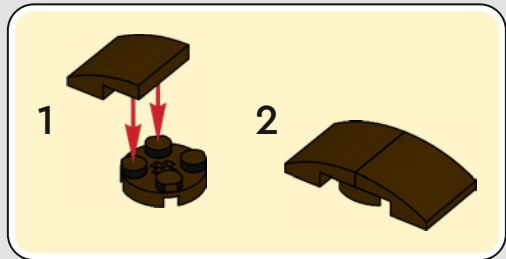



56

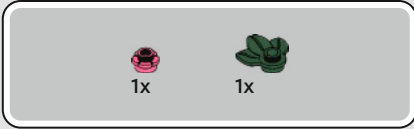
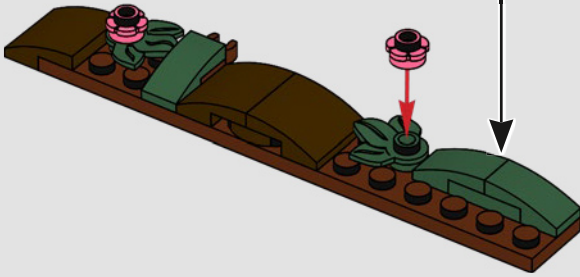
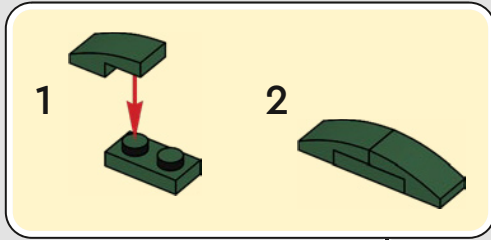

57

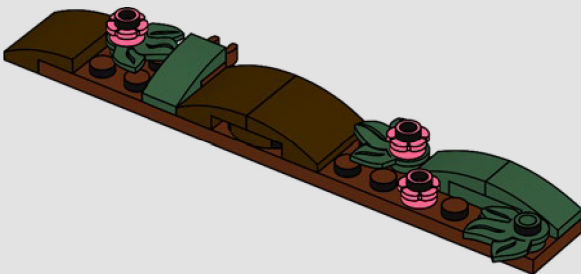

58





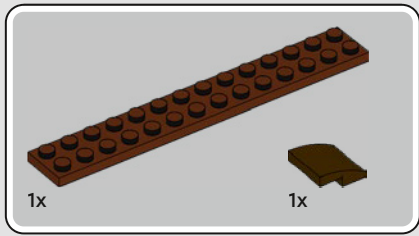

59

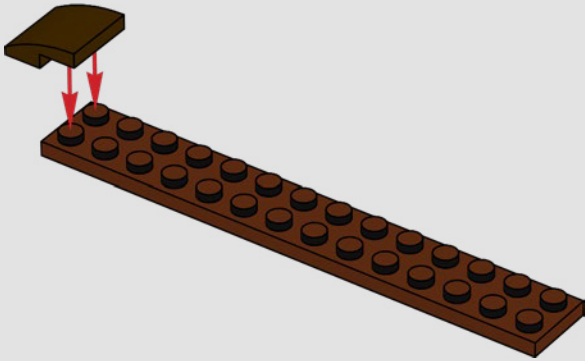

60

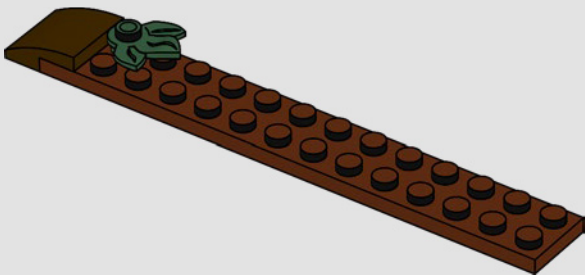

61

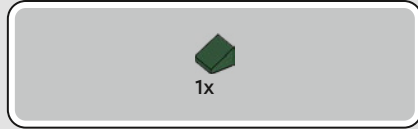
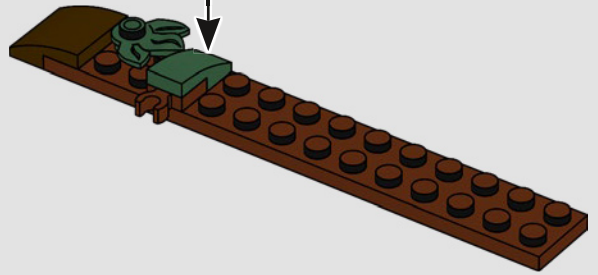
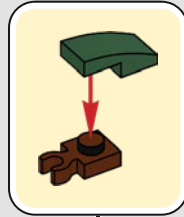

62

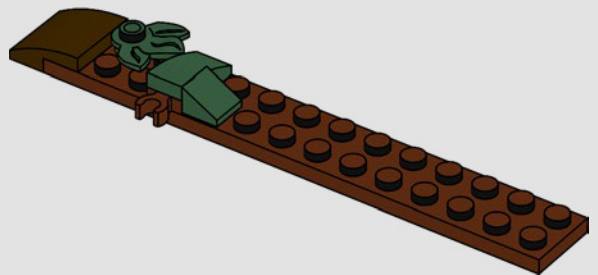

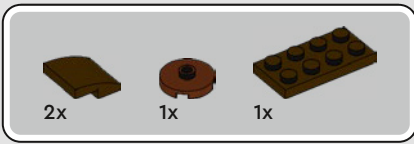

63

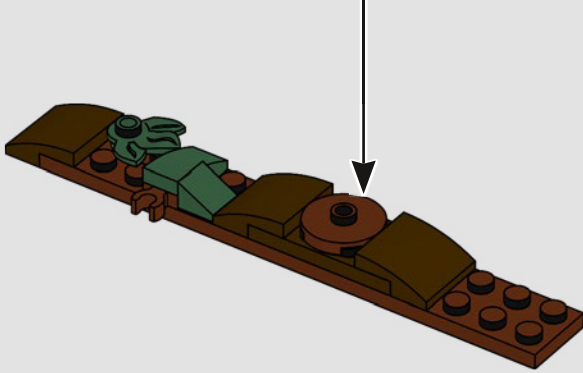
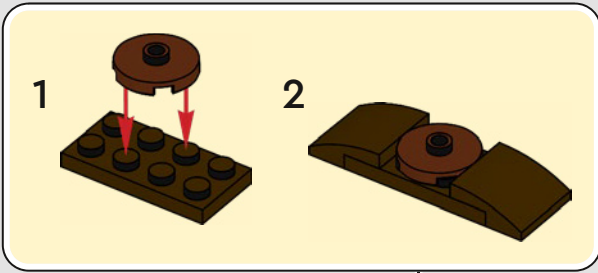

64

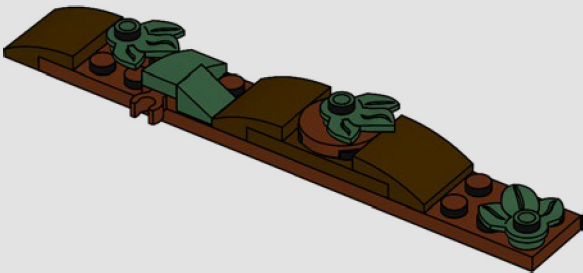

65



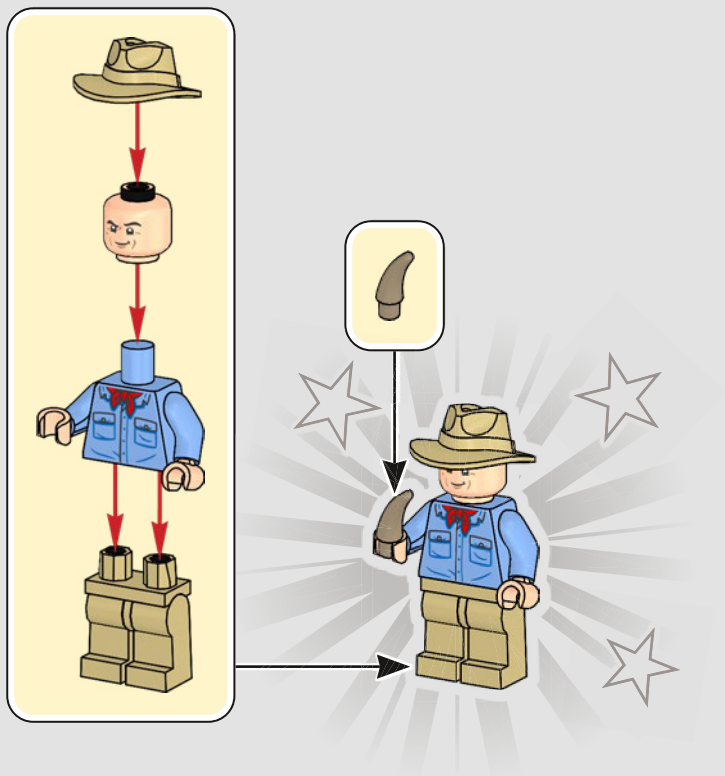

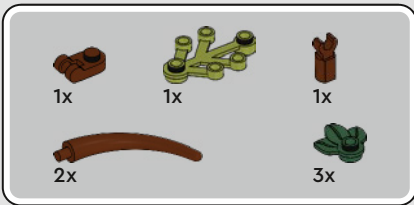

# 66

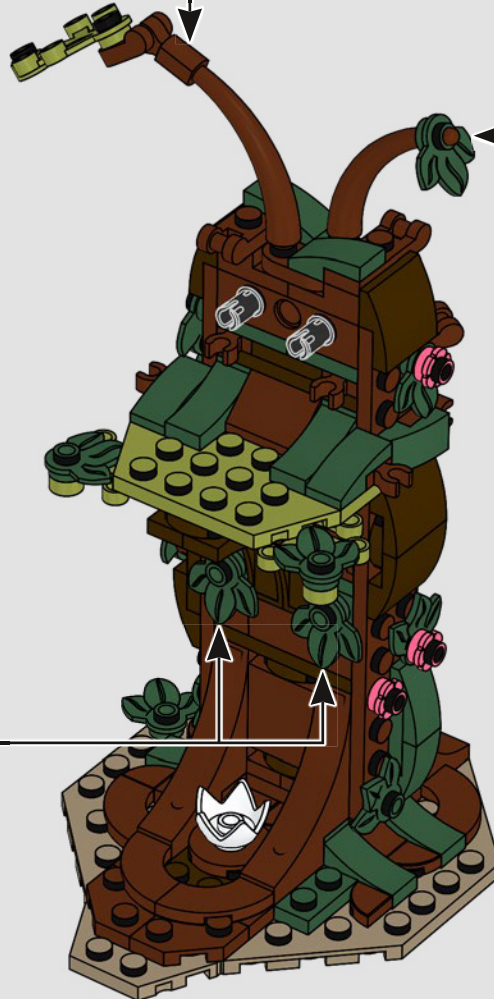
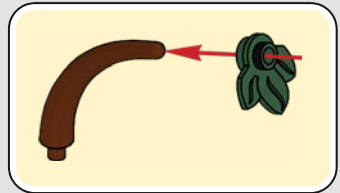
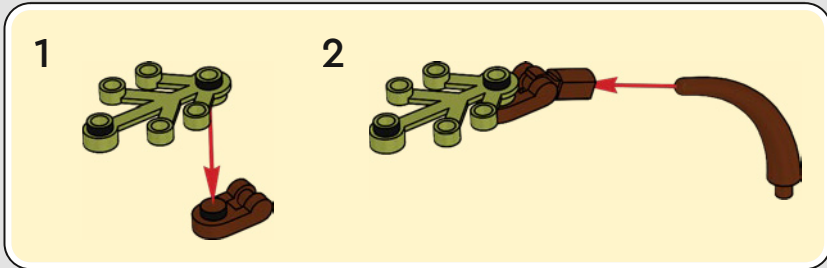

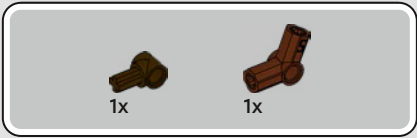

67

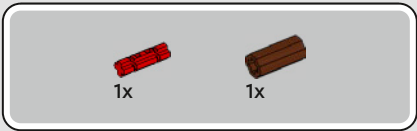
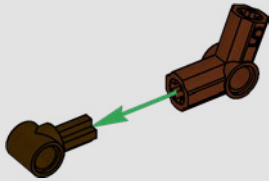

68

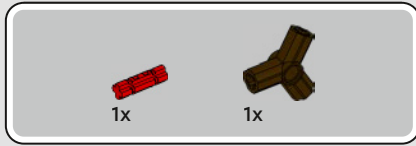
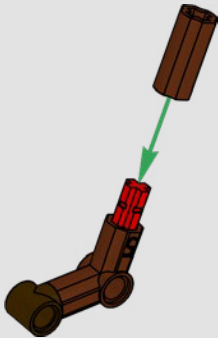

69

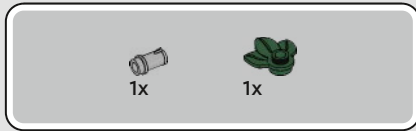
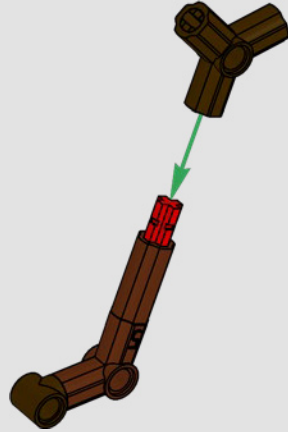

70

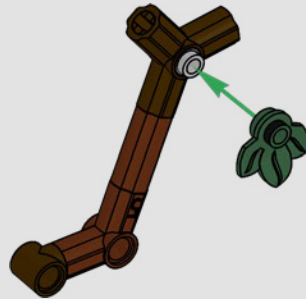



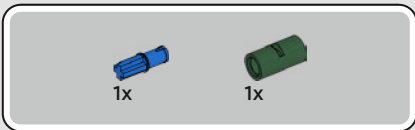

71

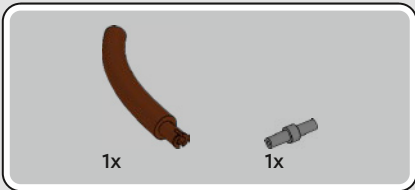

72

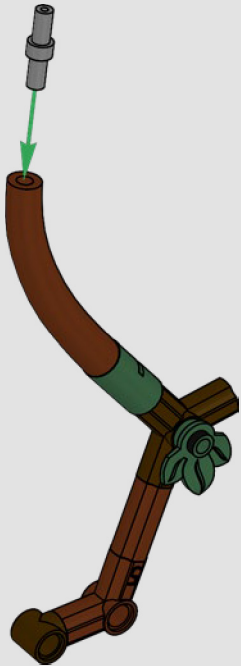

73

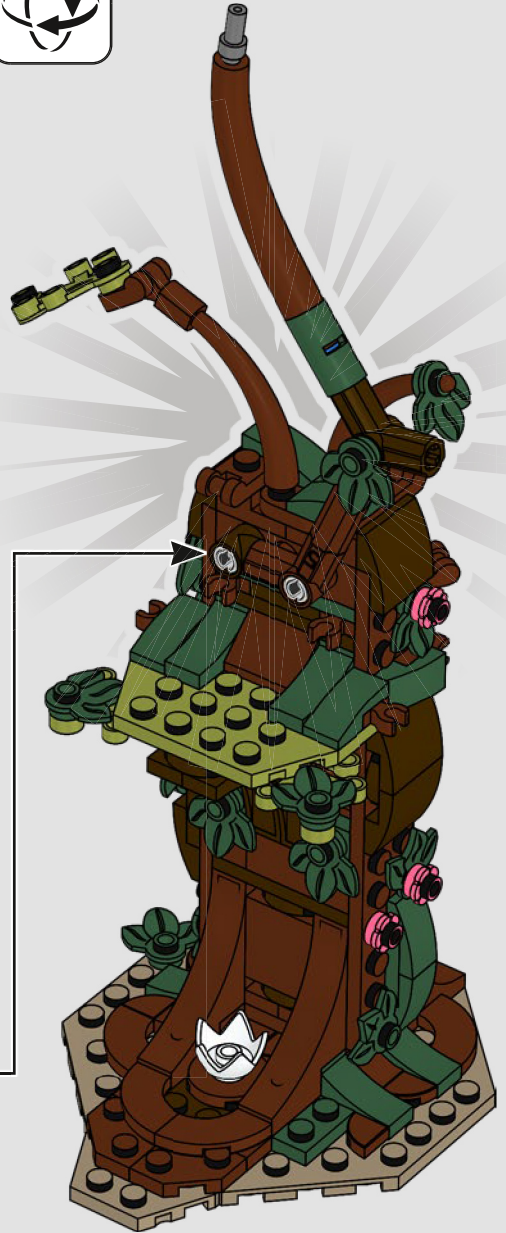

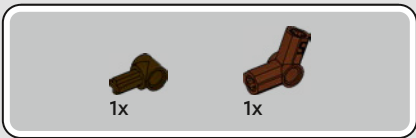

74

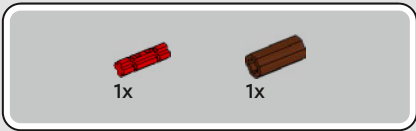
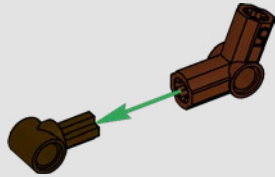

75

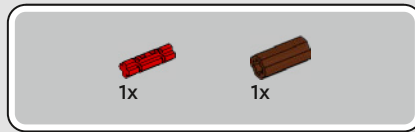
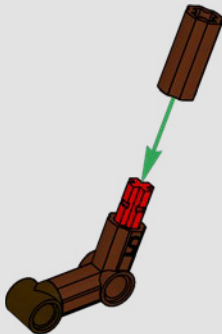

76

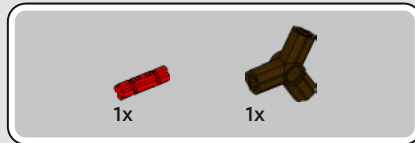
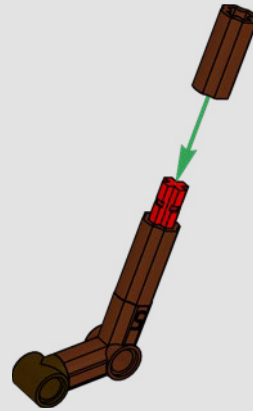

77

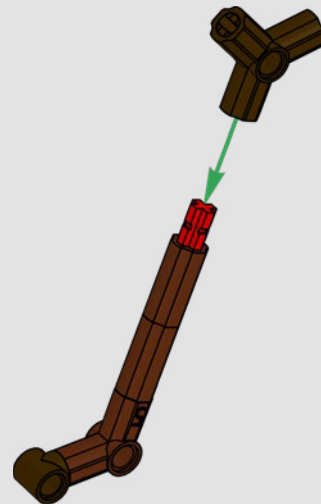

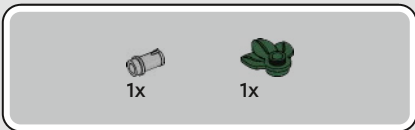

78

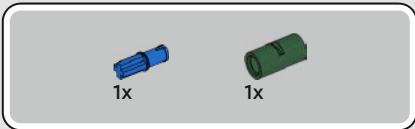
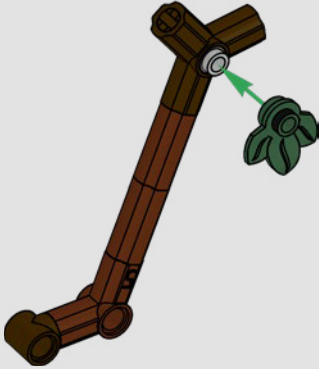

79

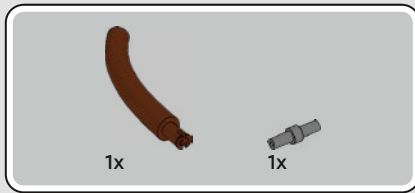

80





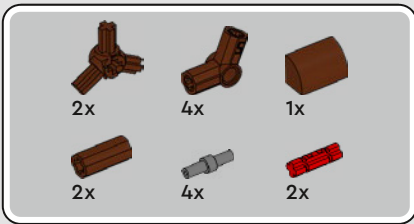

82

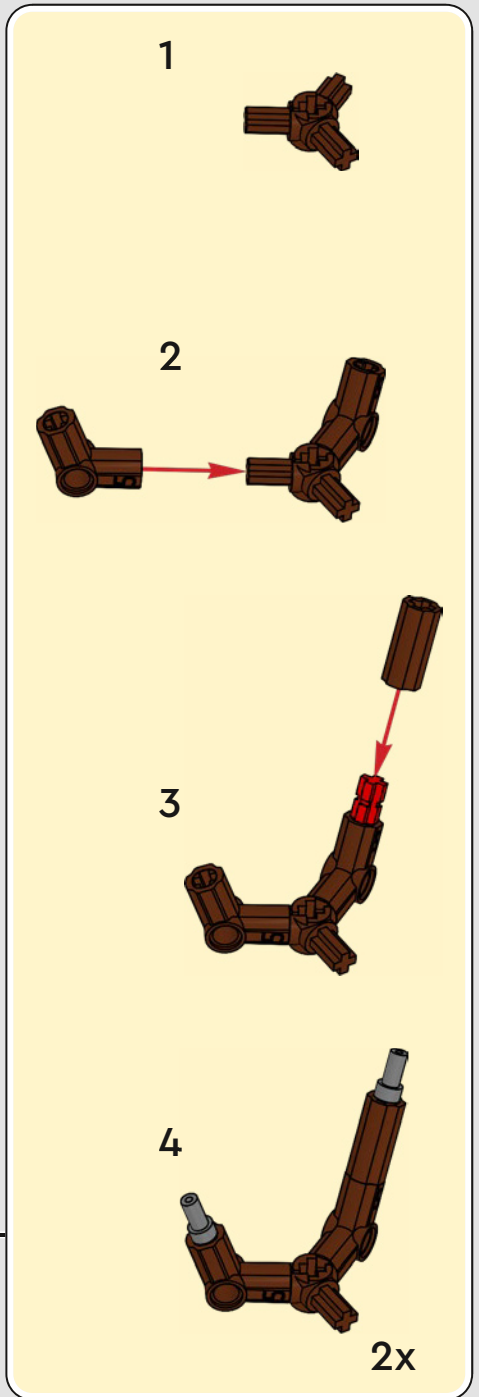
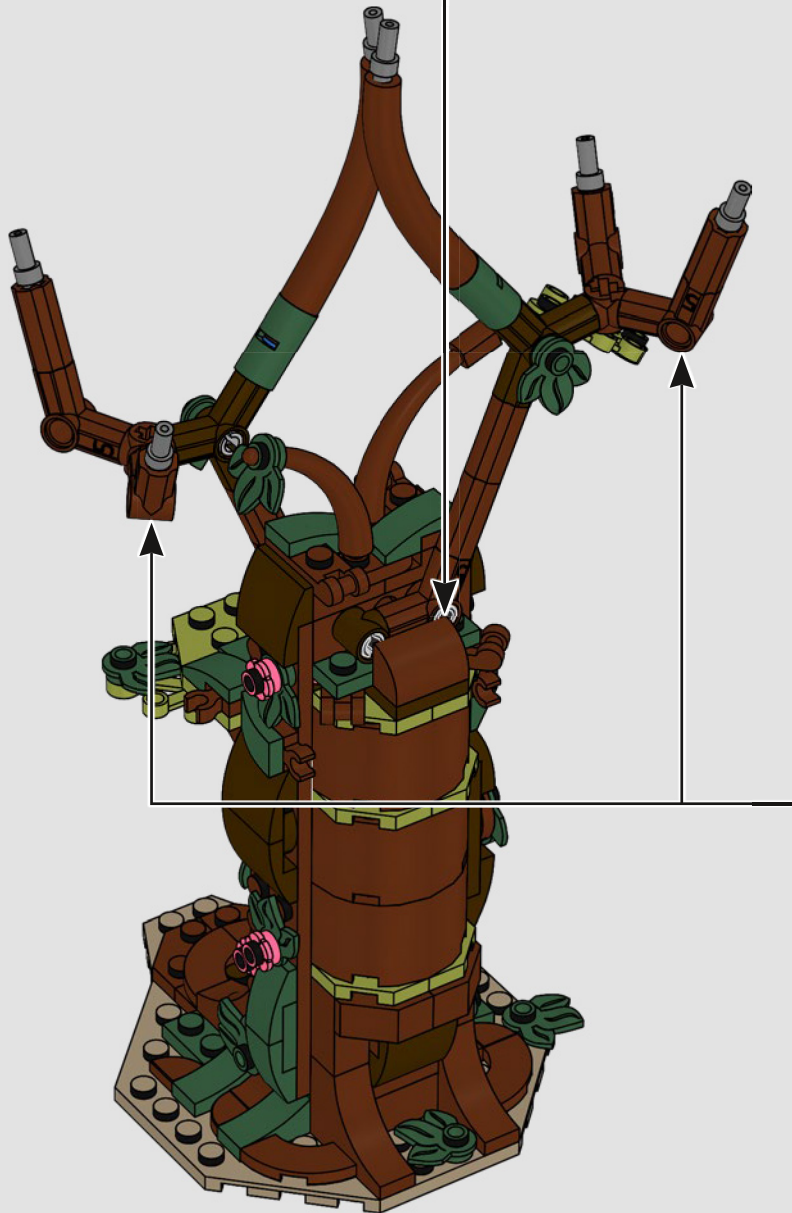





83

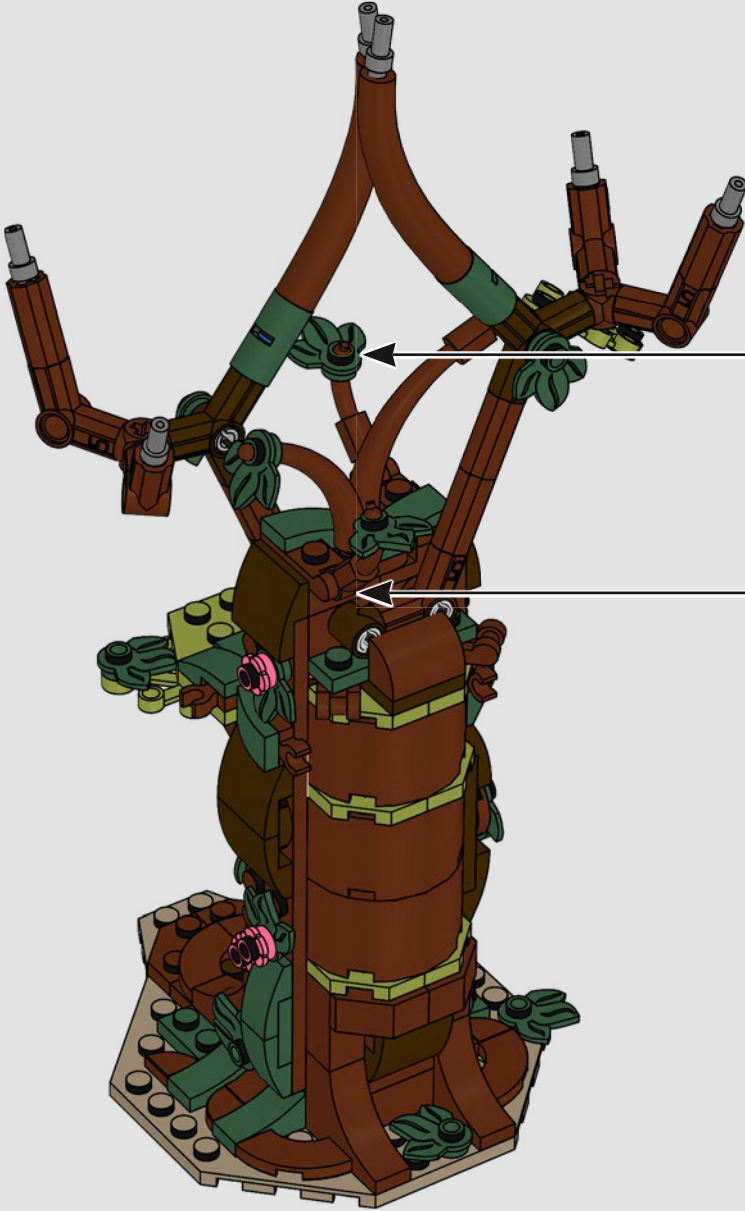
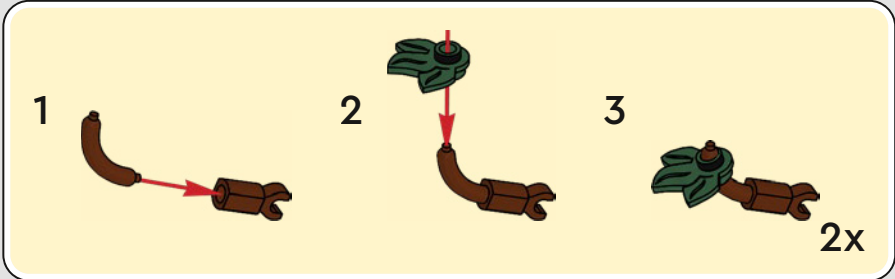

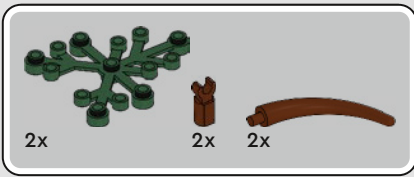

# 84

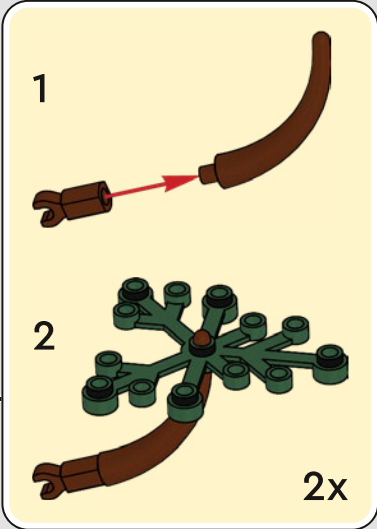
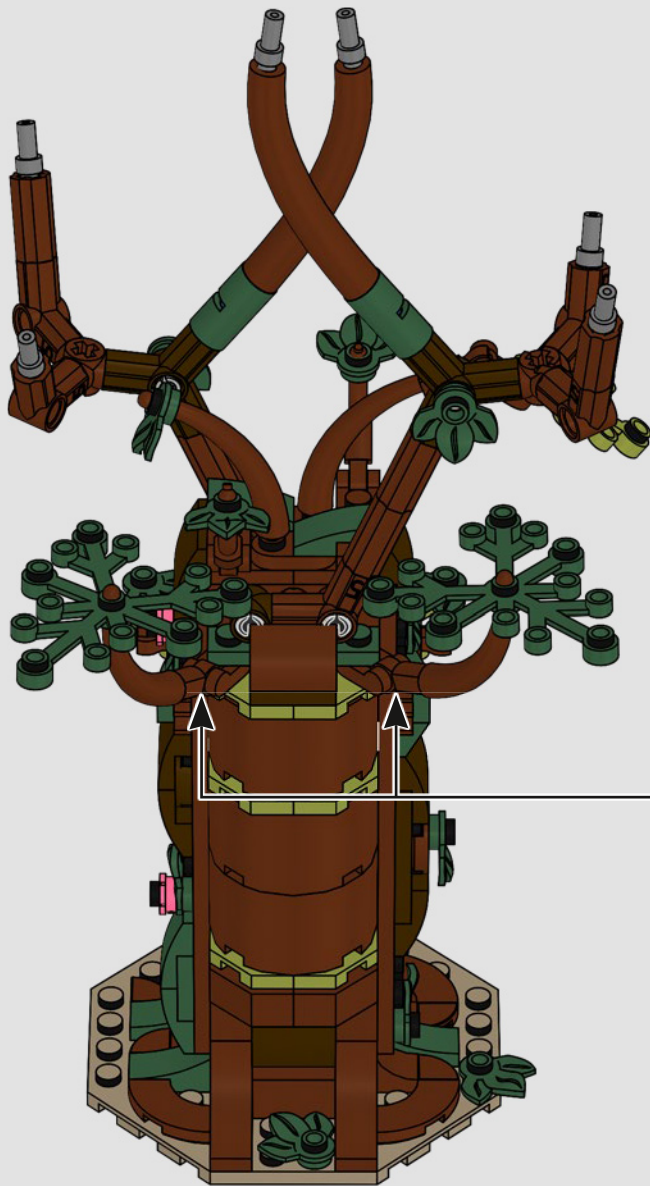

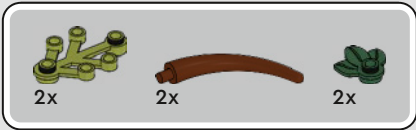

# 85

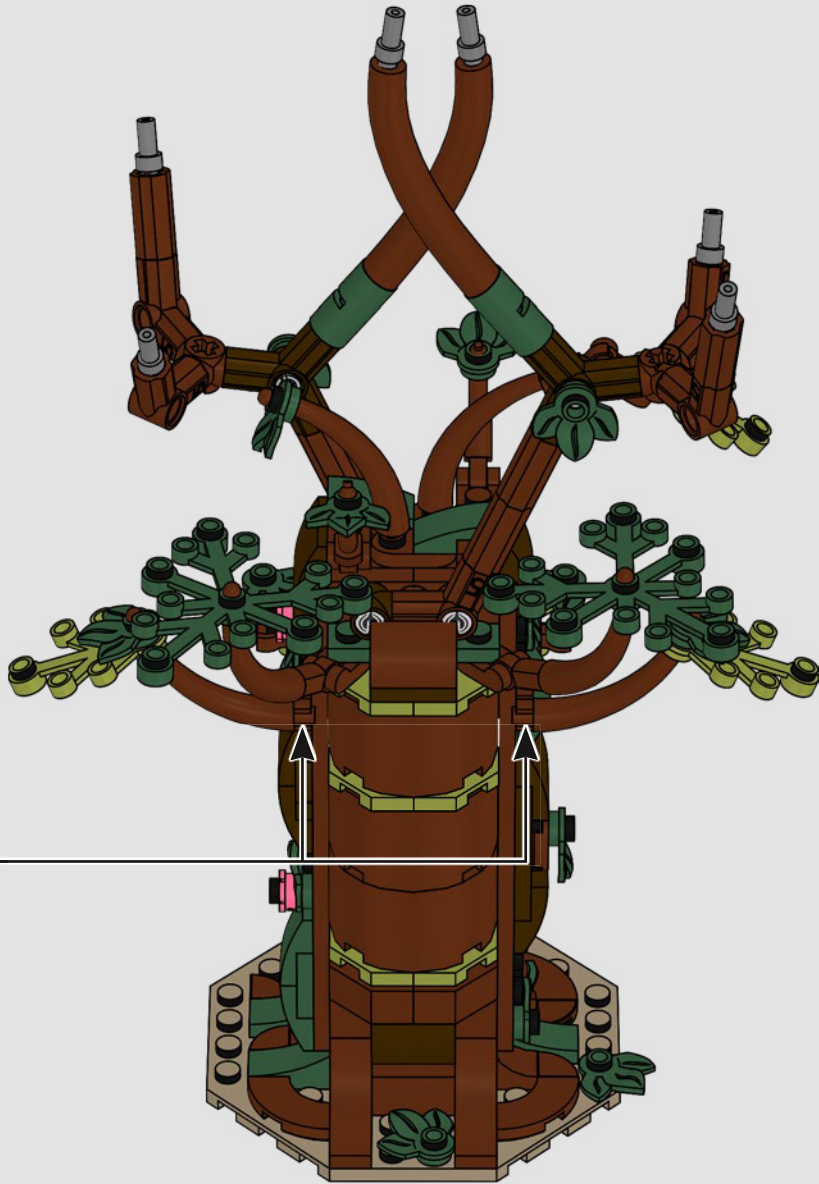
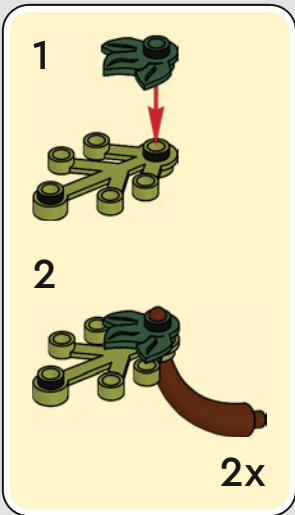



86

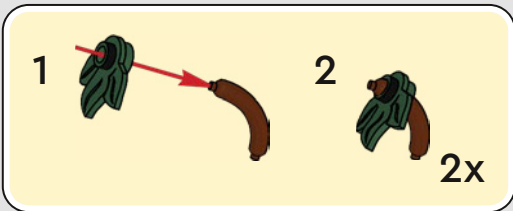
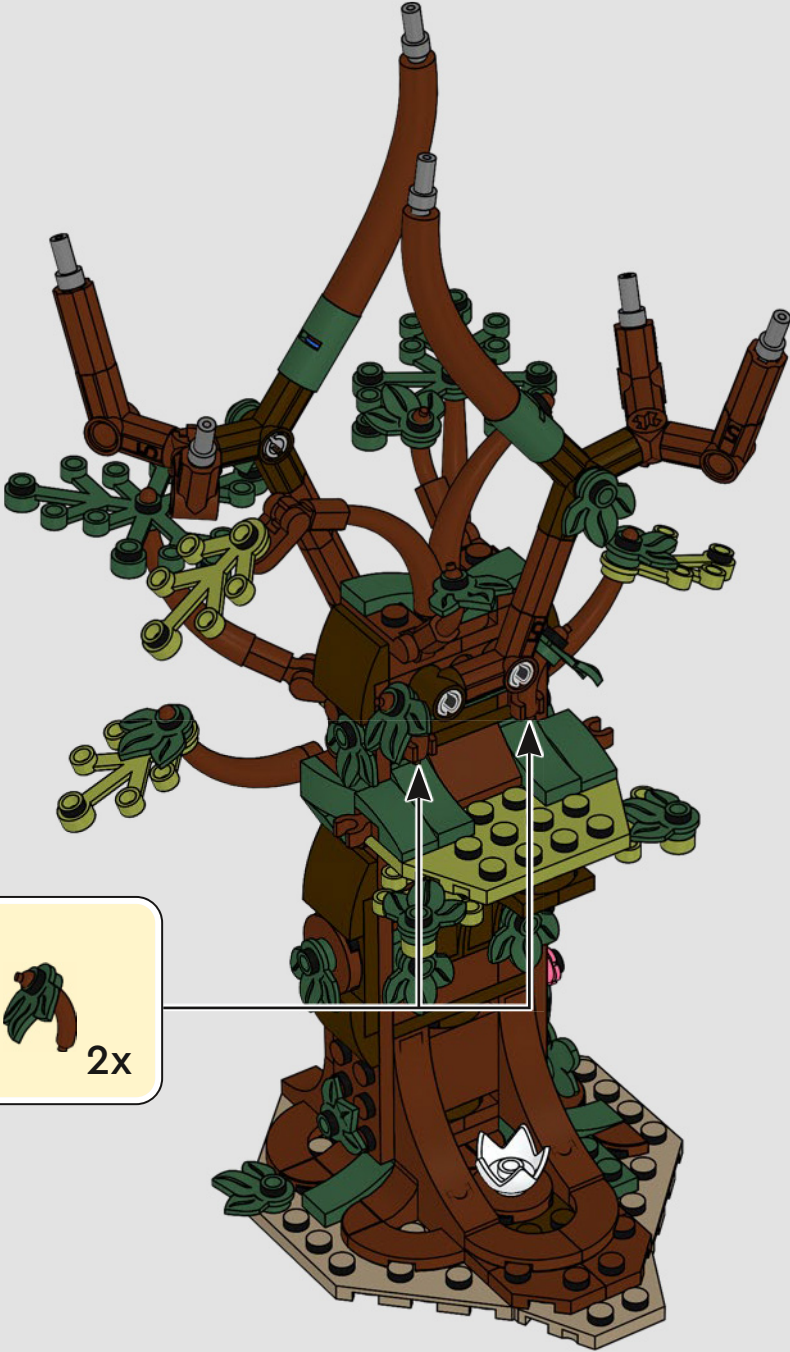

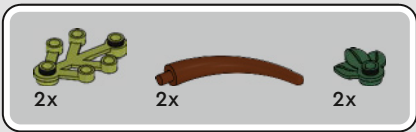

87

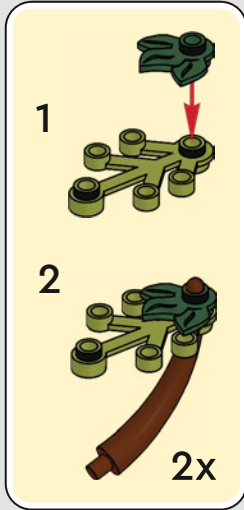



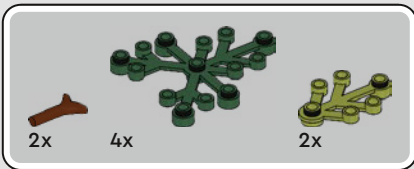

88

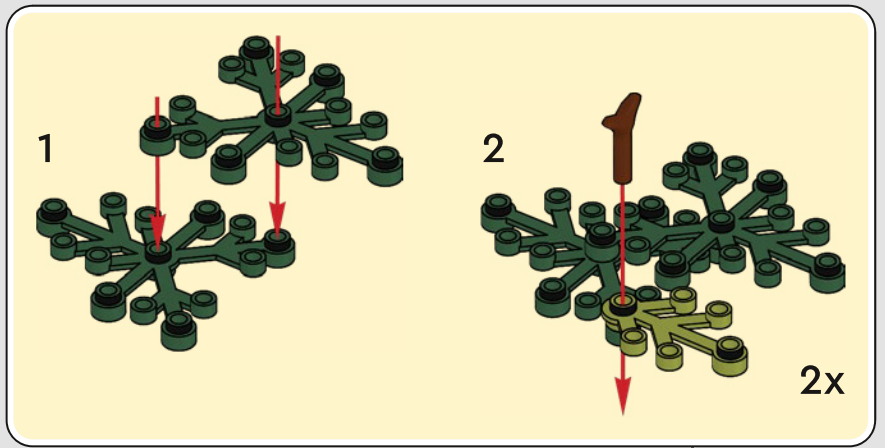

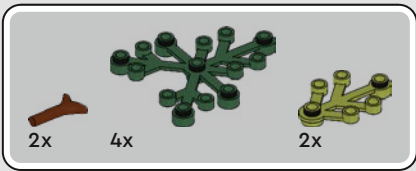

89

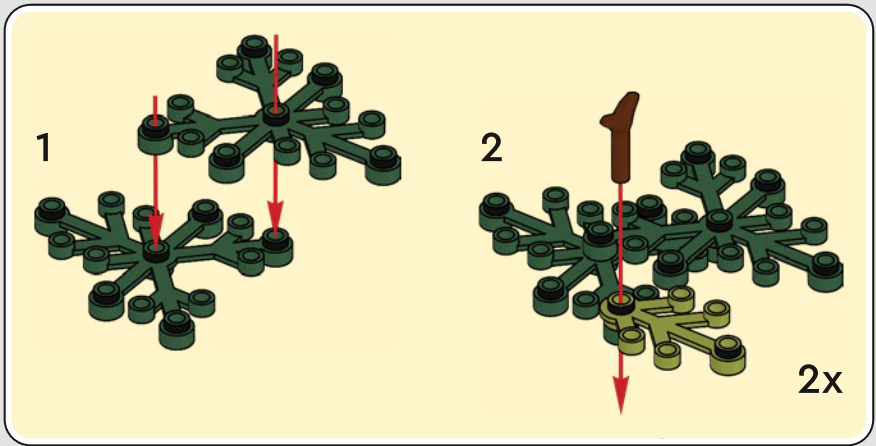



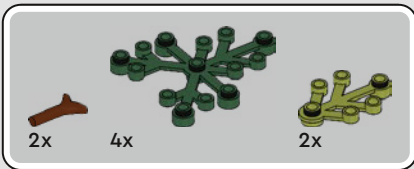

90

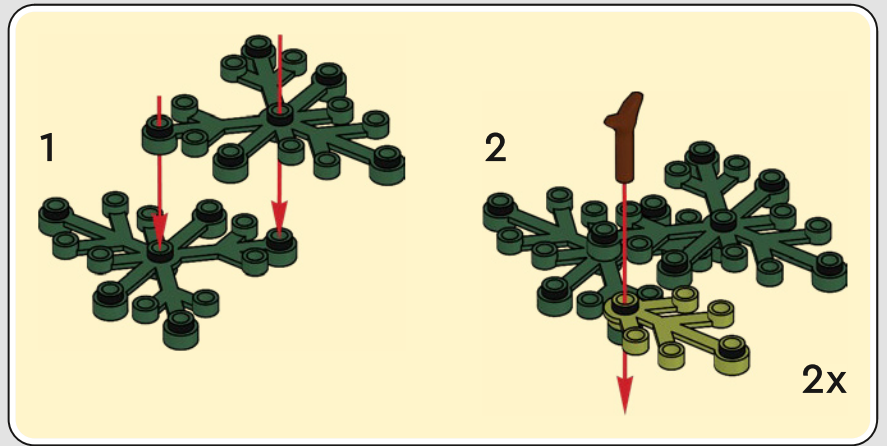

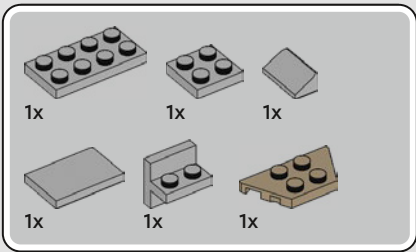

91

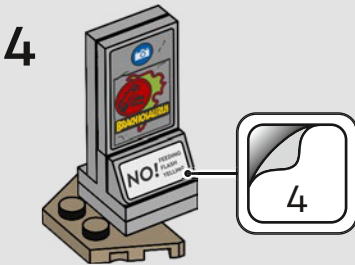
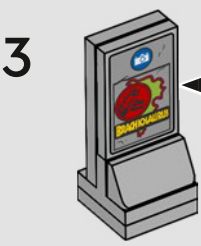
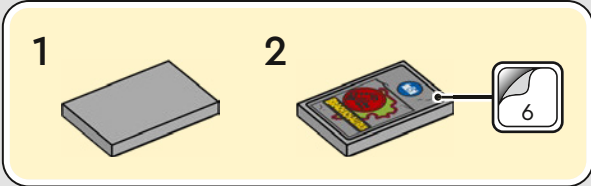
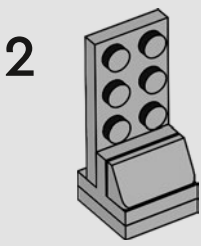
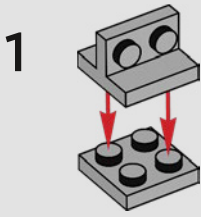



2x

3x

92





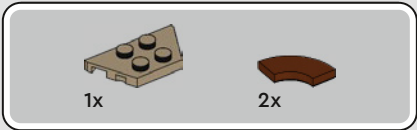

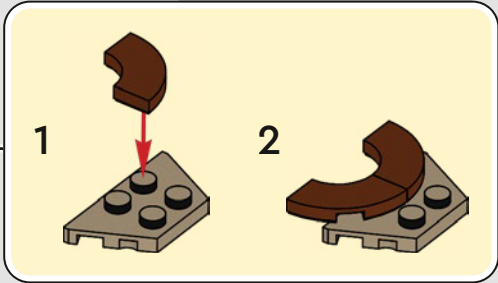

93



		
3x	1x	3x

94

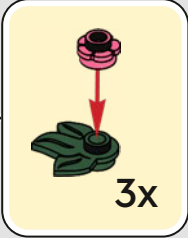





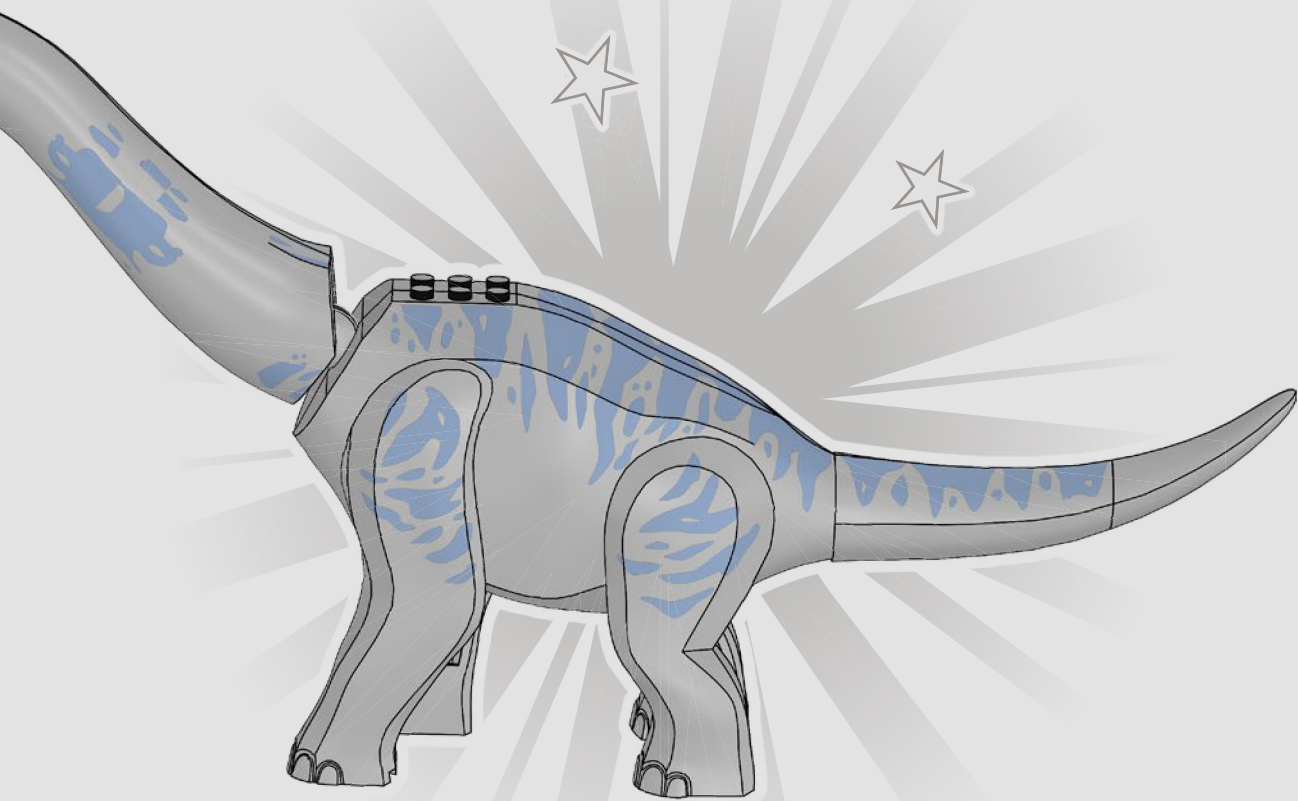















2x  
6102975



6x  
6149677



2x  
6248944



2x  
6102360



2x  
6218366



7x  
6342958



3x  
6430292



4x  
6380047



6x  
6078605



2x  
6326087



8x  
6372430



5x  
6341968



5x  
4531751



6x  
6271351



2x  
6441316



2x  
4211386



1x  
4211393



2x  
4211476



3x  
4568637



2x  
6407767



4x  
4211399



4x  
4211414



2x  
6212077



1x  
4211397



1x  
6444487



1x  
6171894



3x  
4560183



1x  
4211395



5x  
4211438



2x  
6318584



1x  
4211404



2x  
4514846



2x  
4654582



1x  
6258820



4x  
4515369



2x  
6265710



1x  
4211732



1x  
4211735



1x  
6432147

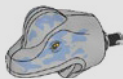

1x  
6436331



1x  
6436330

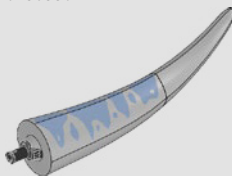

1x  
6436332

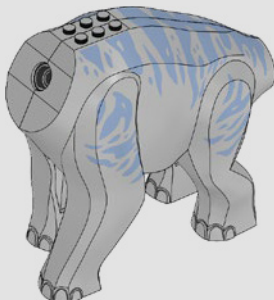

1x  
6436329



1x  
4226995



2x  
4211483



2x  
4211095



2x  
6395363



1x  
4213607



8x  
4211043



1x  
4210998



1x  
4211061



4x  
6336390



2x  
6281996



2x  
6000606



6x  
6350724



2x  
6454959



1x  
6390255



1x  
6436301



1x  
6338826



1x  
6436324



1x  
6092677



7x  
6047037



2x  
6209722



7x  
6226792



4x  
4623298



2x  
6134197



2x  
6273219



6x  
6278087



1x  
6439695



13x  
6268815



17x  
6295242



1x  
6441256



1x  
6399743



[LEGO.com/service](https://www.lego.com/service)

**YOU COULD WIN**

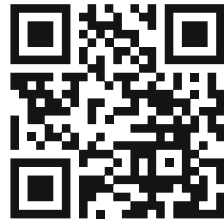

Scan this QR code or go to **LEGO.COM/PRODUCTFEEDBACK** and give us your short feedback about this LEGO® set for a chance to win a cool LEGO prize.

Terms and Conditions apply\*

**EN: YOU COULD WIN.** Terms and Conditions apply\* **DE: Du könntest GEWINNEN.** Es gelten die Teilnahmebedingungen\* **FR: Tu pourrais GAGNER.** Des conditions s'appliquent\* **IT: Potresti VINCERE tu.** Termini e condizioni sono applicabili\* **ES: Puedes GANAR.** Aplican términos y condiciones\* **PT: Poderá GANHAR.** Aplicam-se termos e condições\* **ZH: 轻松获奖. 条款和条件适用\*** **PL: Szansa na WYGRANĄ.** Obowiązują warunki korzystania\* **CS: Máte šanci VYHRÁT.** Platí všeobecné smluvní podmínky\* **SK: Máte šancu VYHRAŤ.** Platia všeobecné zmluvné podmienky\* **HU: TE IS NYERHETSZ.** Felhasználási feltételek érvényesek\* **RO: Ai putea CÂȘTIGA.** Se aplică termenii și condiții\* **BG: Можете да СПЕЧЕЛИТЕ.** Има определени правила и условия\* **LV: Tu vari LAIMĒT.** Ir spēkā noteikumi un nosacījumi.\* **ET: Sul on võimalus VÕITA.** Kehtivad tingimused\* **LT: Jūs galite LAIMĖTI.** Taikomos sąlygos\*

\*[LEGO.com/productfeedback-terms](https://www.lego.com/productfeedback-terms)

LEGO and the LEGO logo are trademarks of the/son des marques de commerce du/son marcas registradas de LEGO Group. ©2023 The LEGO Group.

© Universal City Studios LLC and Amblin Entertainment, Inc. All Rights Reserved.

Jeep, the Jeep grille and related logos, vehicle model names and trade dress are trademarks of FCA US LLC and used under license by the LEGO Group. ©2023 FCA US LLC.