

32

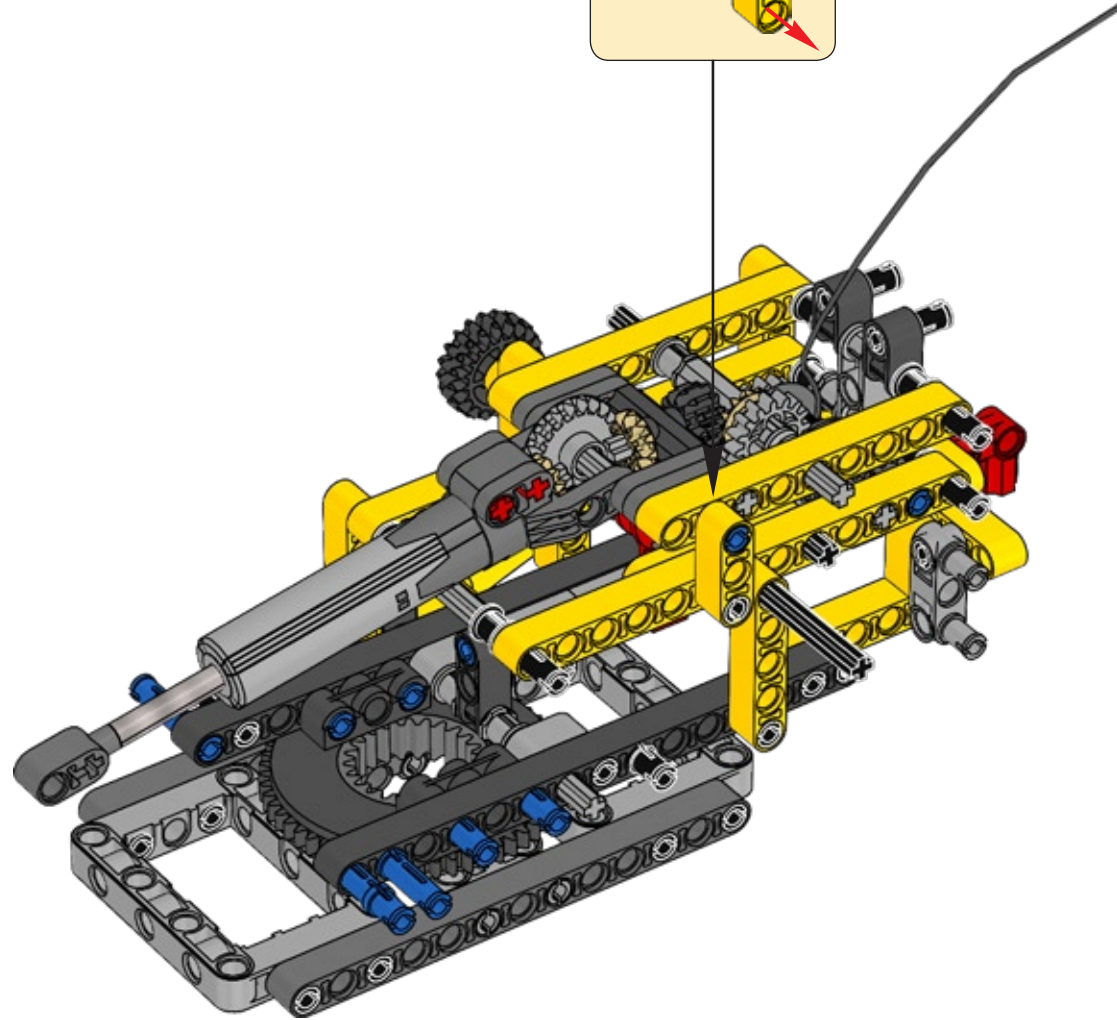

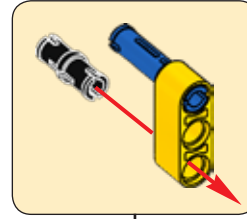

33

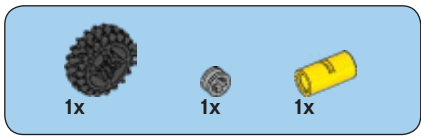
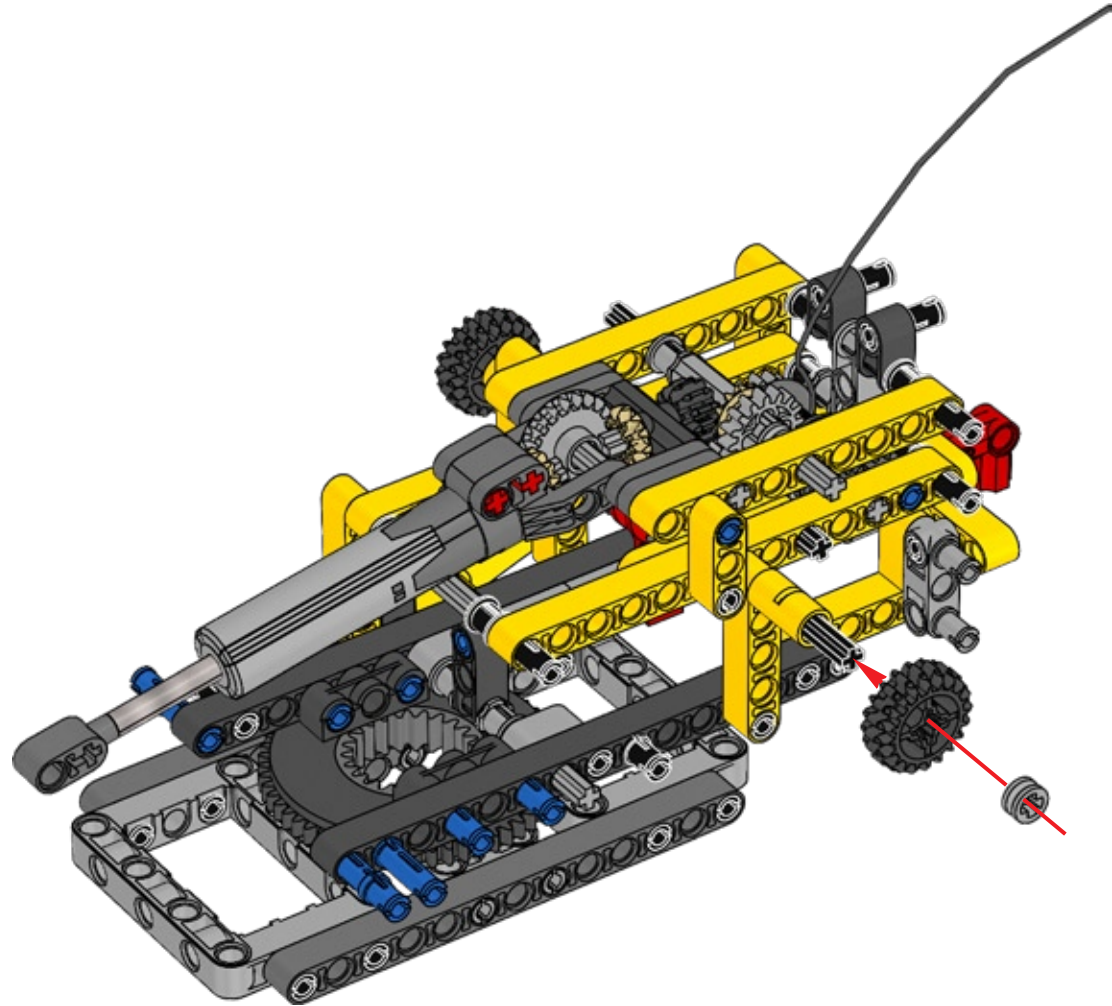

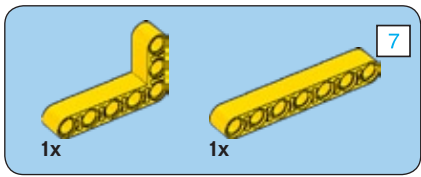

34

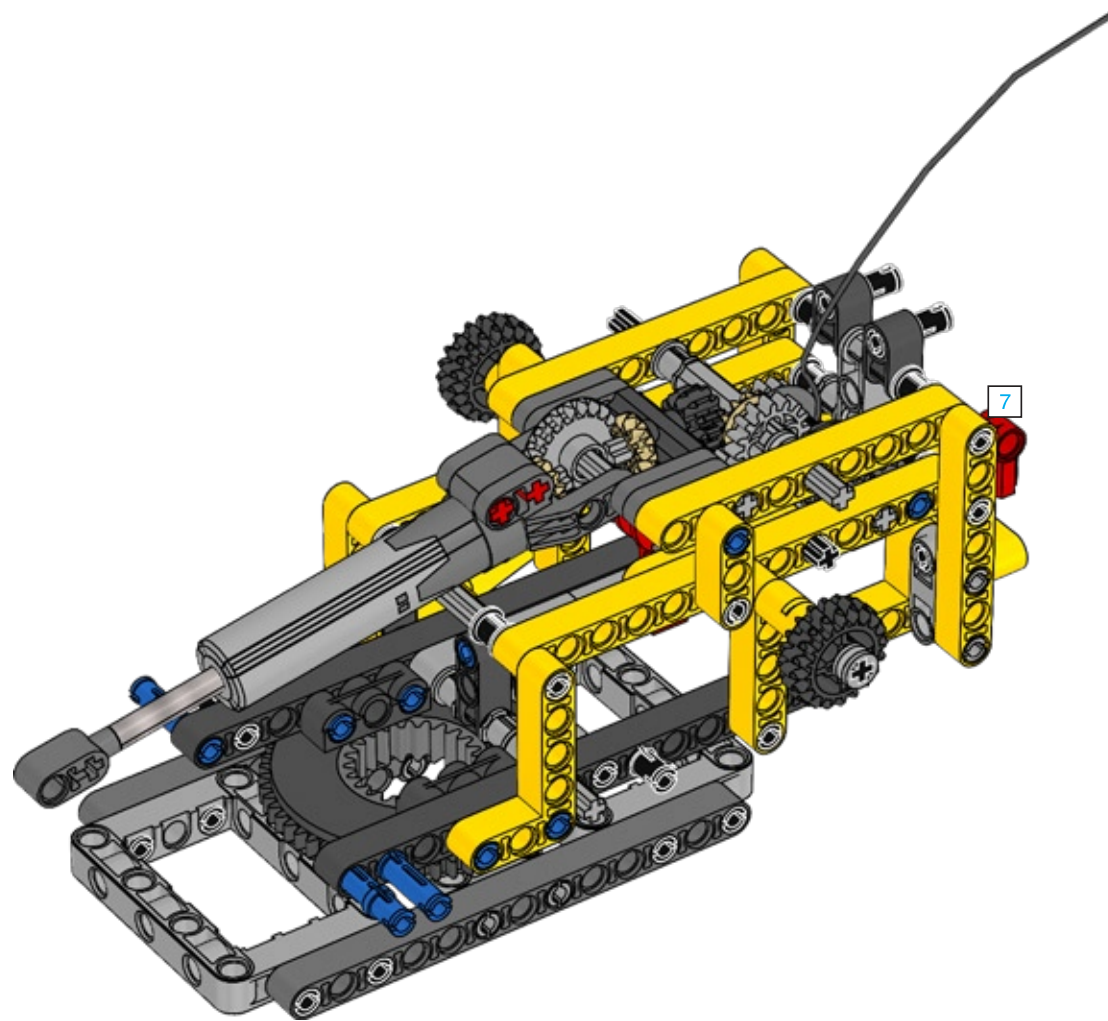

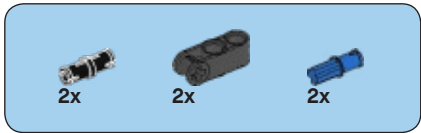

35

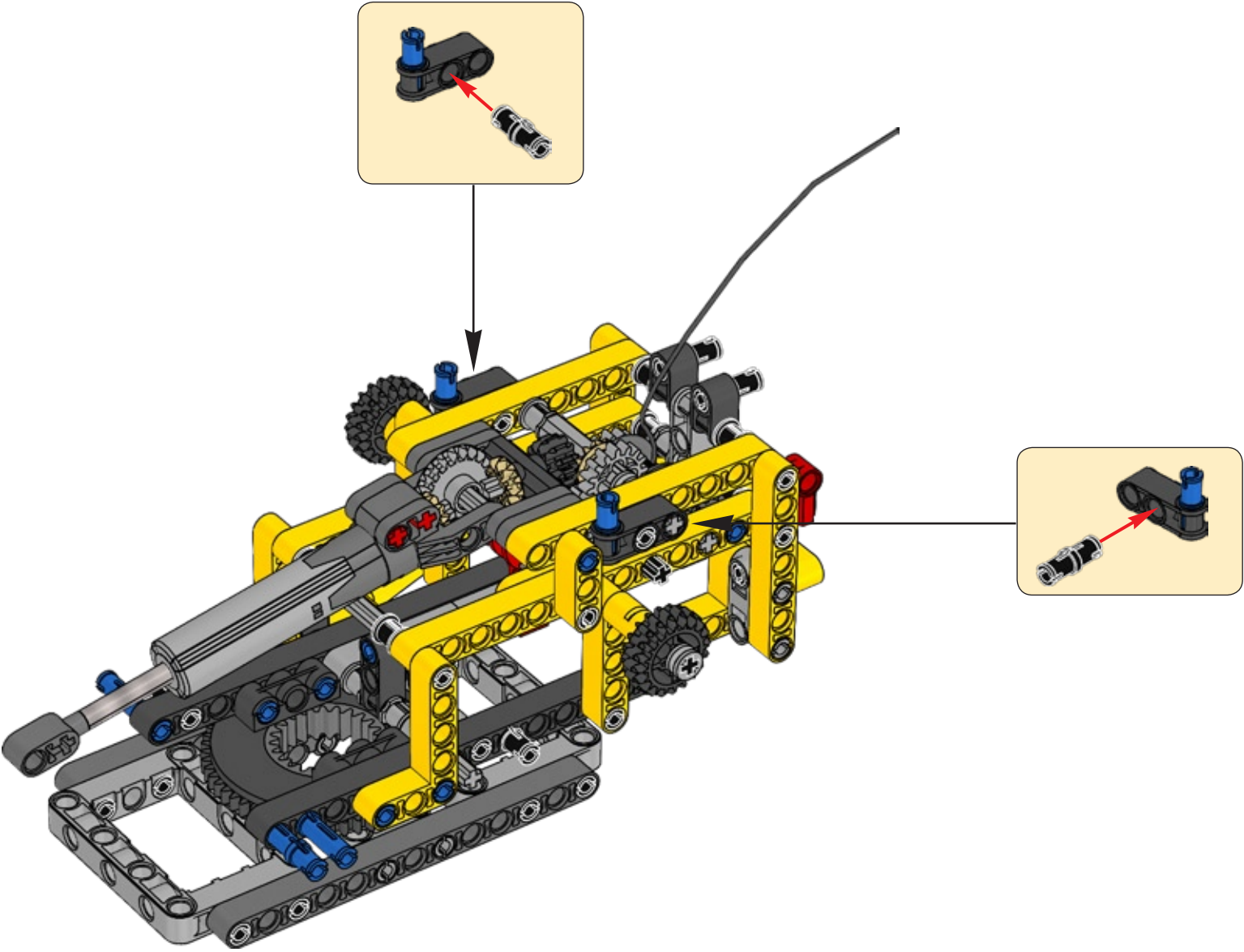

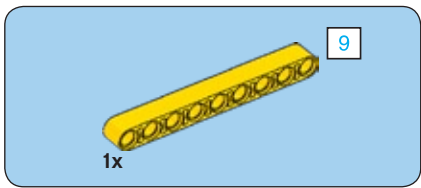

36

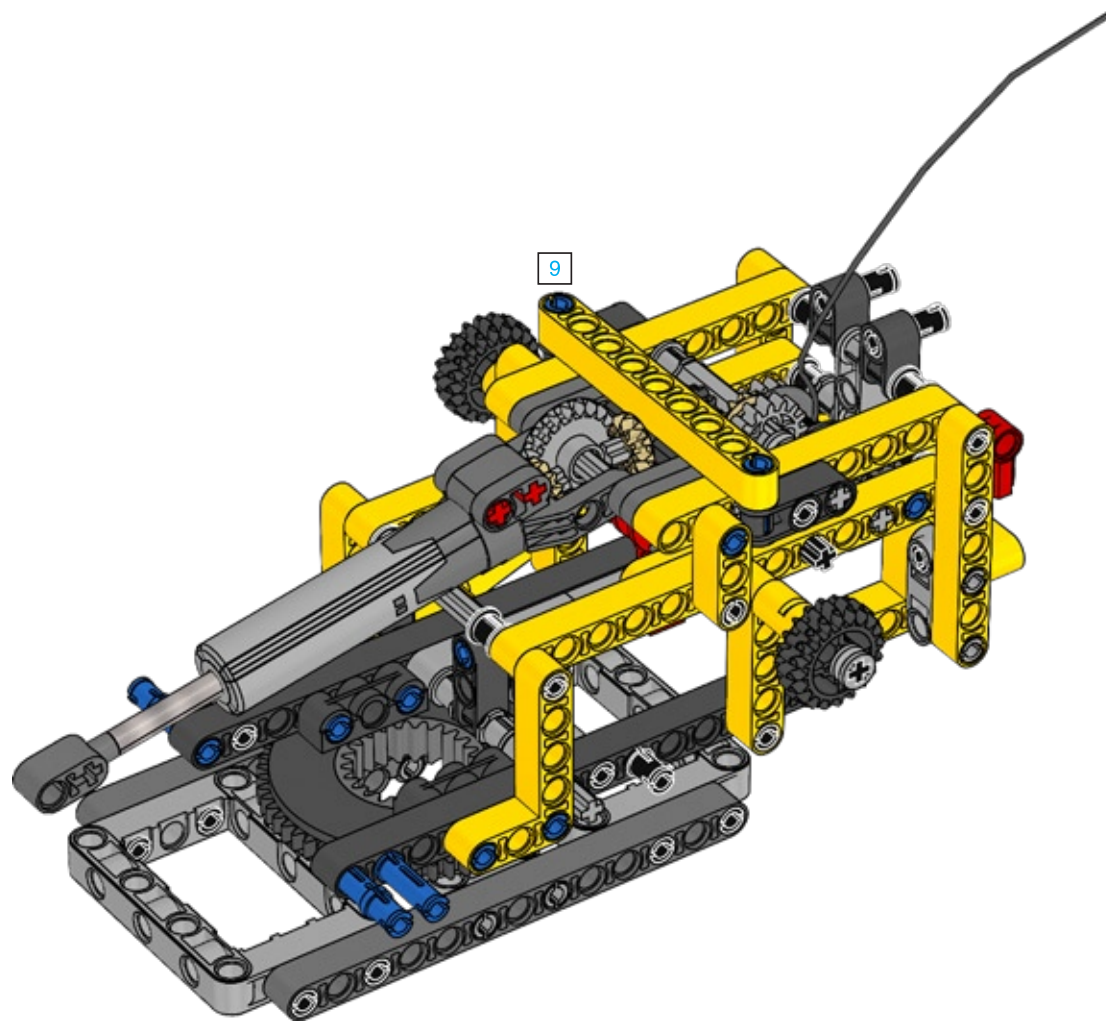

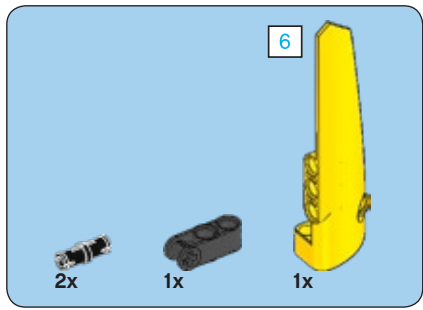

37

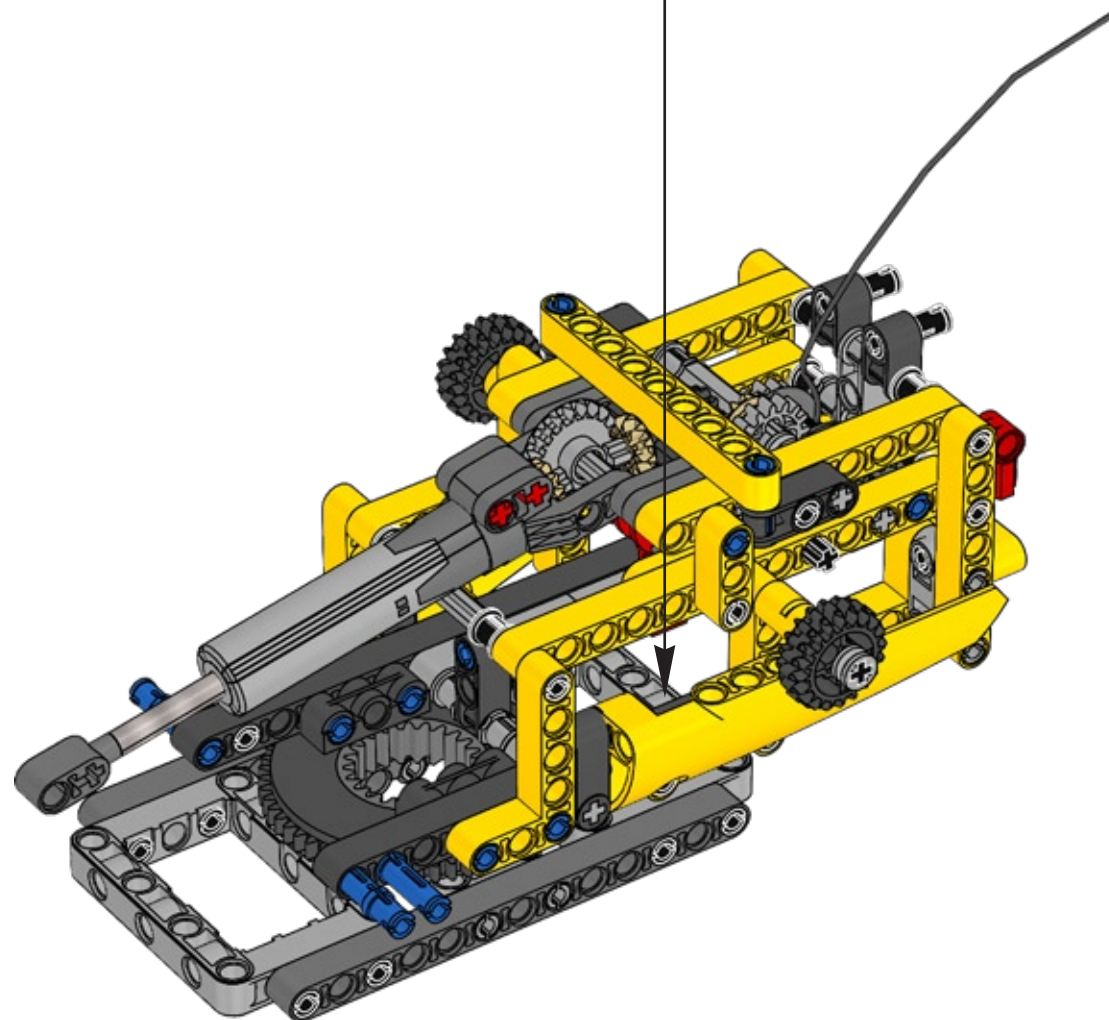
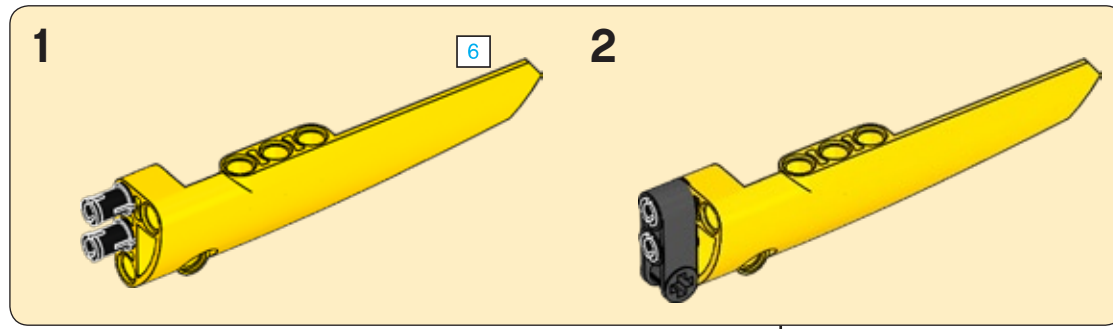

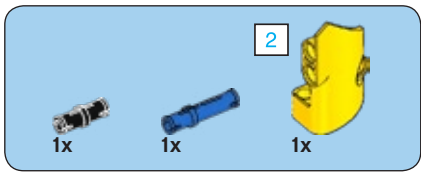

1

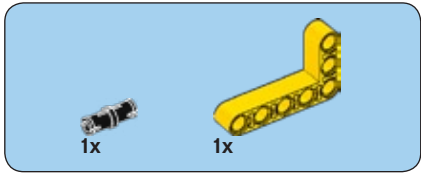
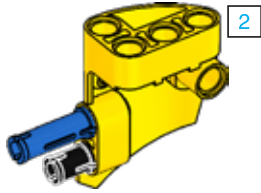

2

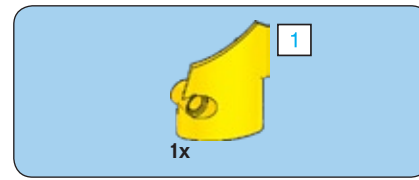
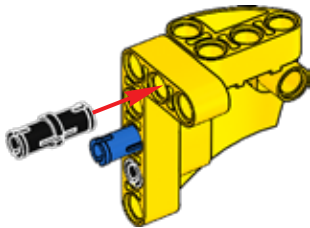

3

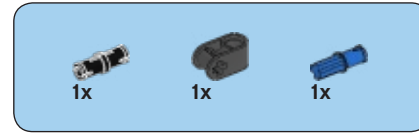
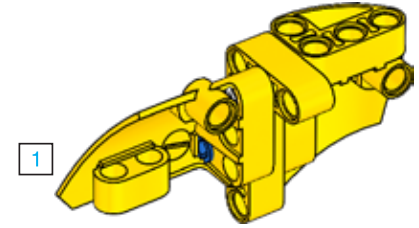

4

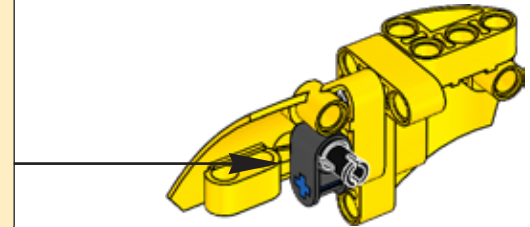
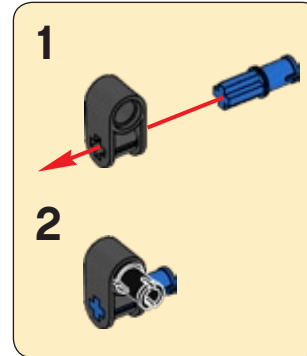

38

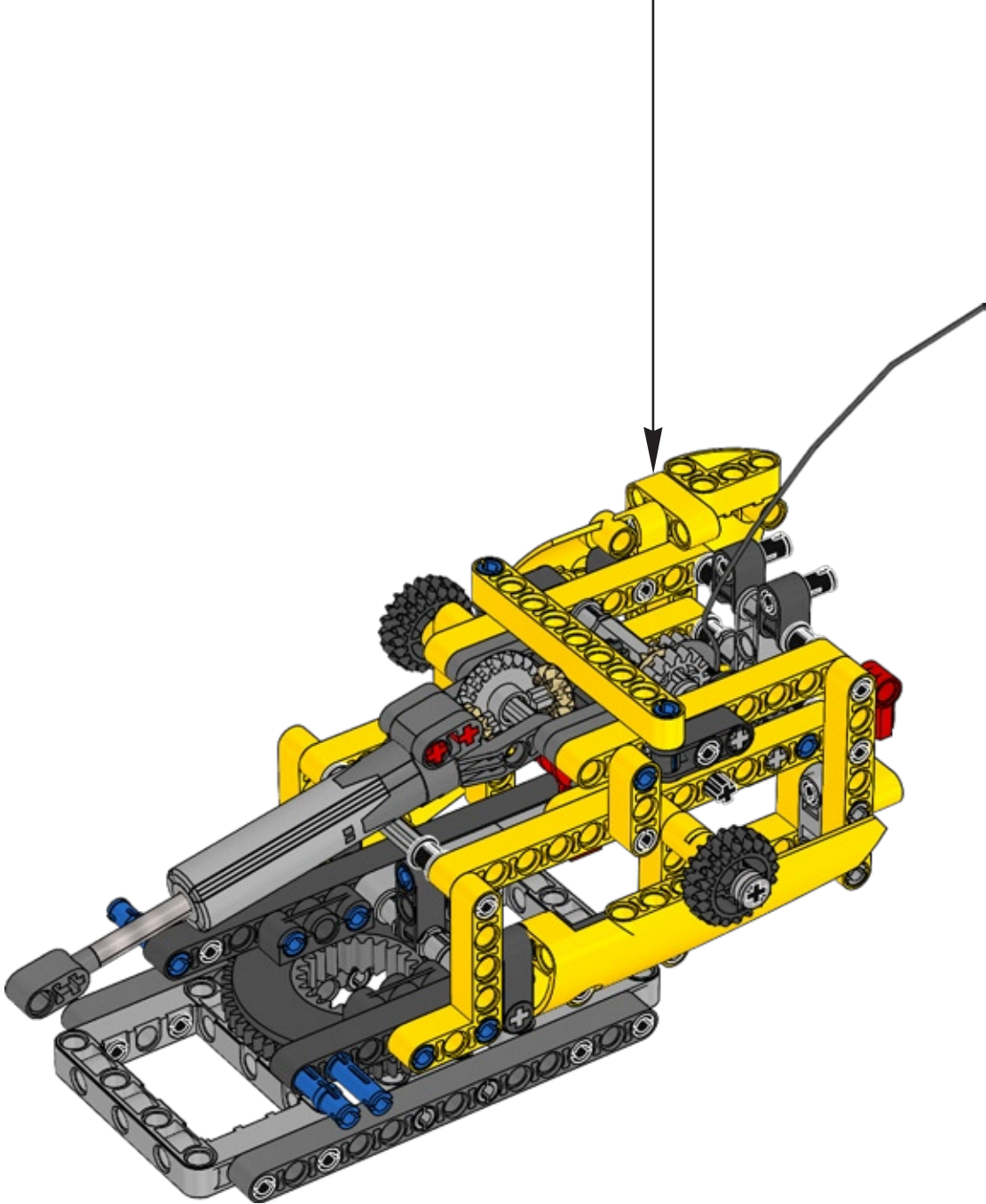



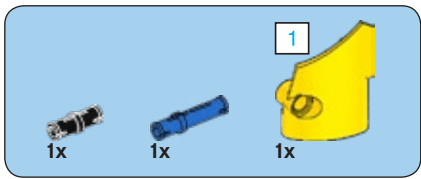

1

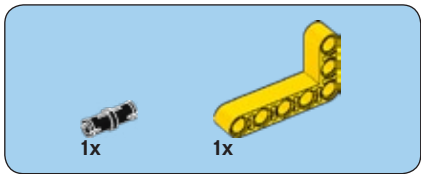
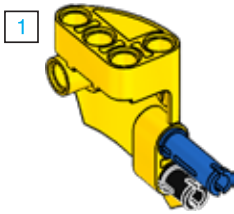

2

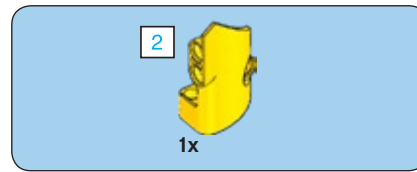
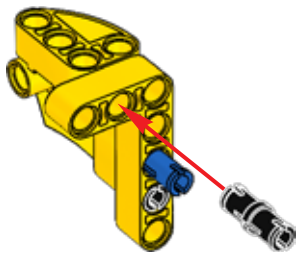

3

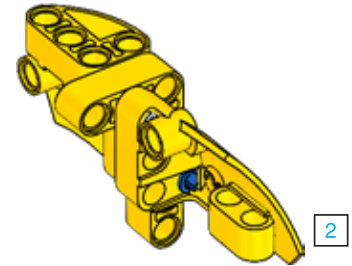

4

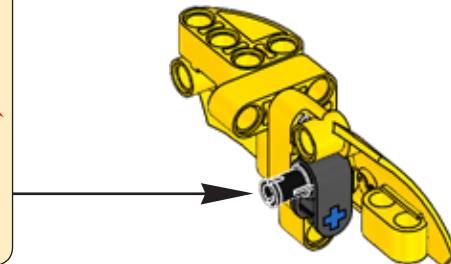
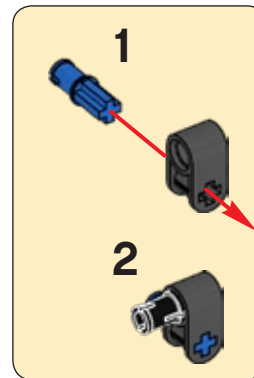

39

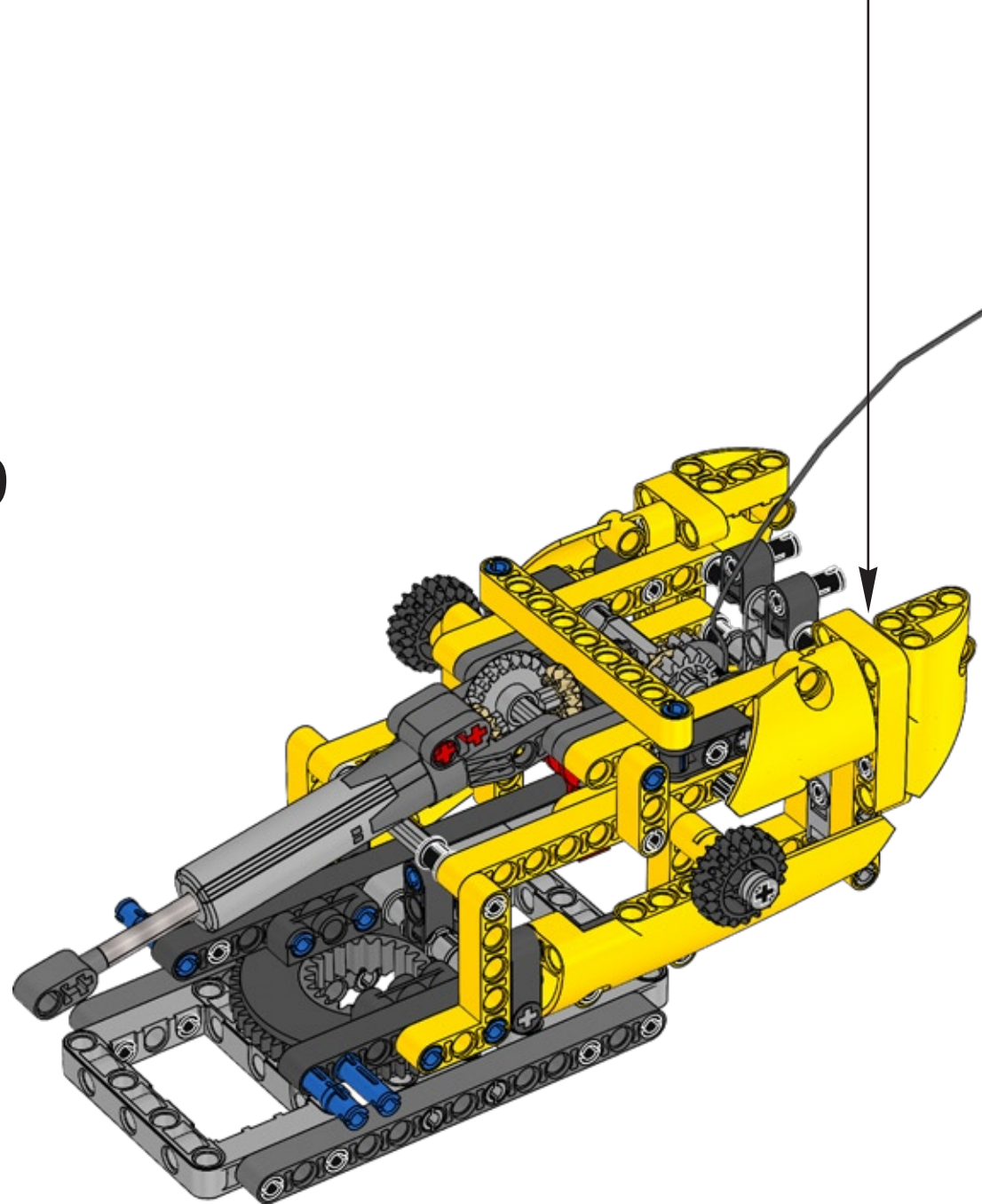

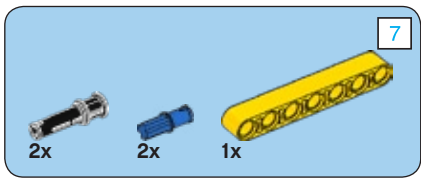

40

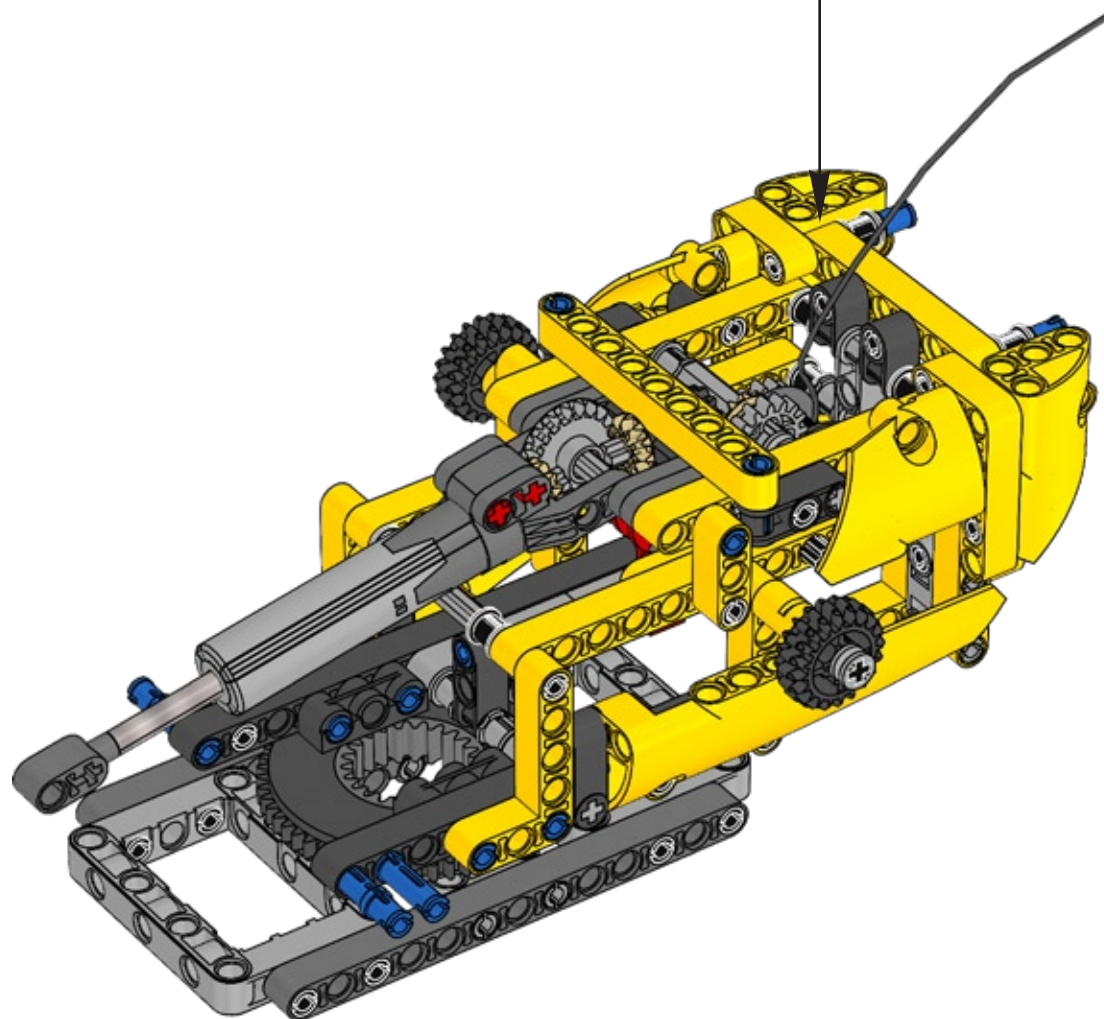
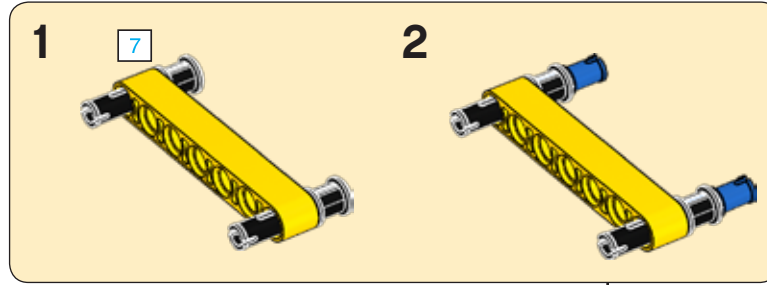

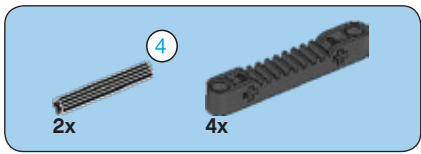

41

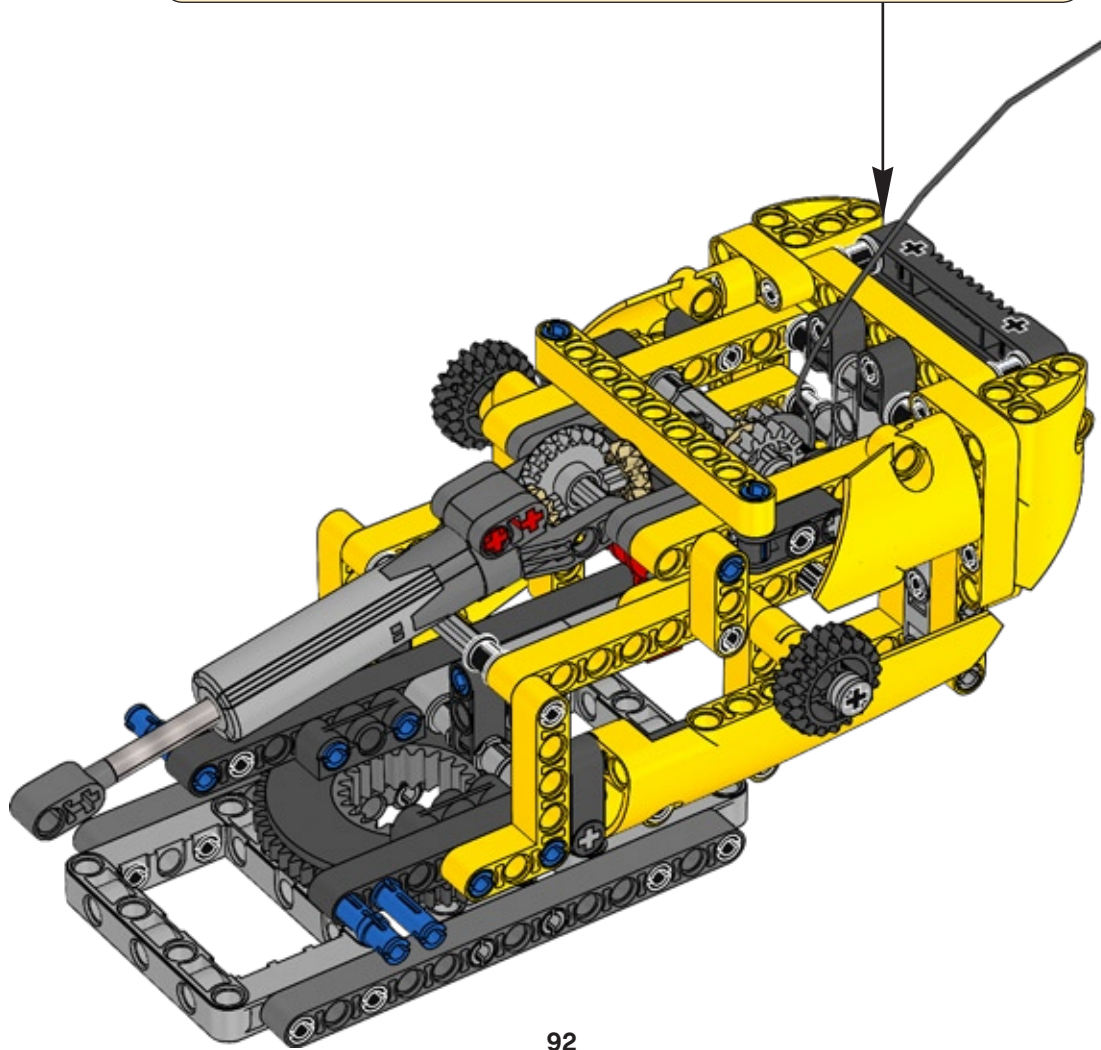
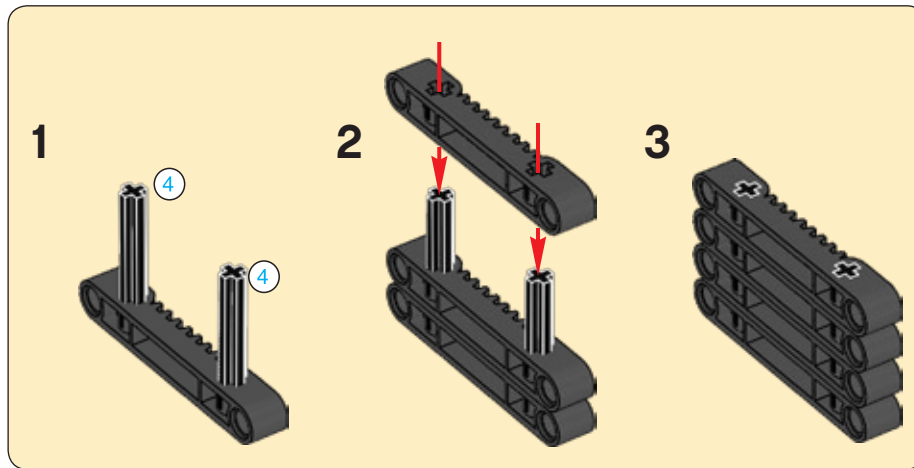

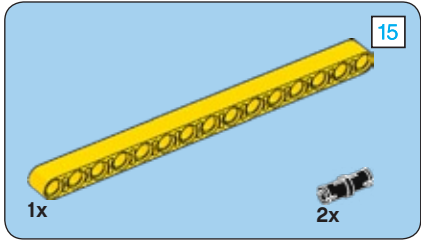
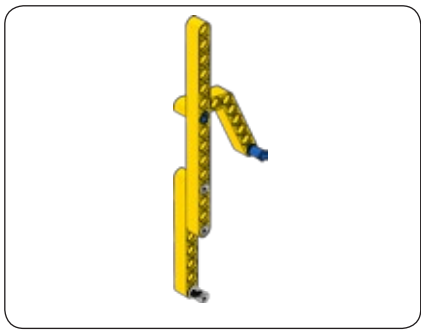

1

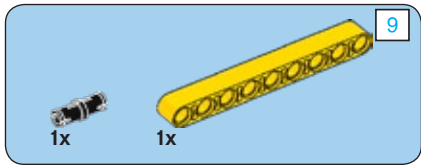

2

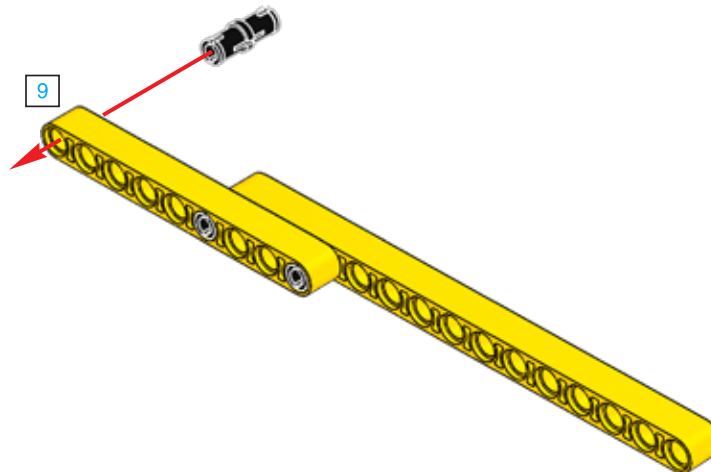
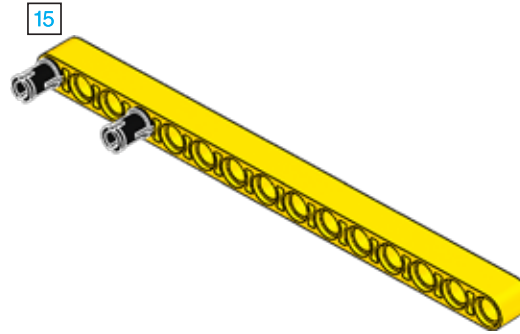

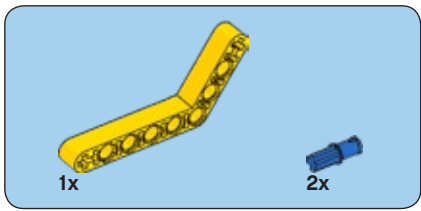

3

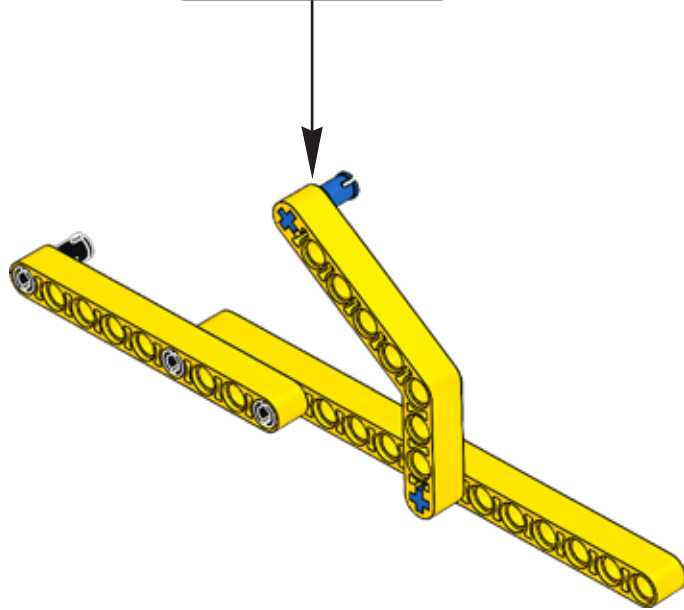
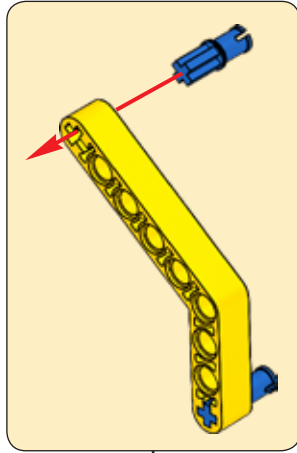

4

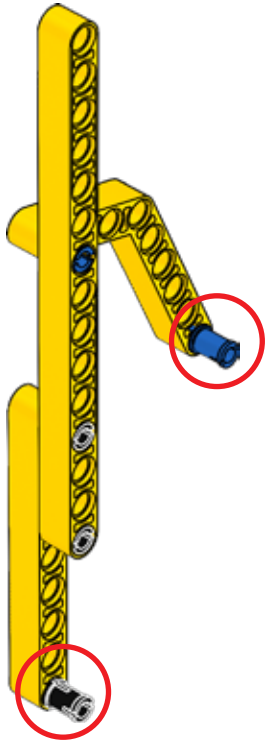

42

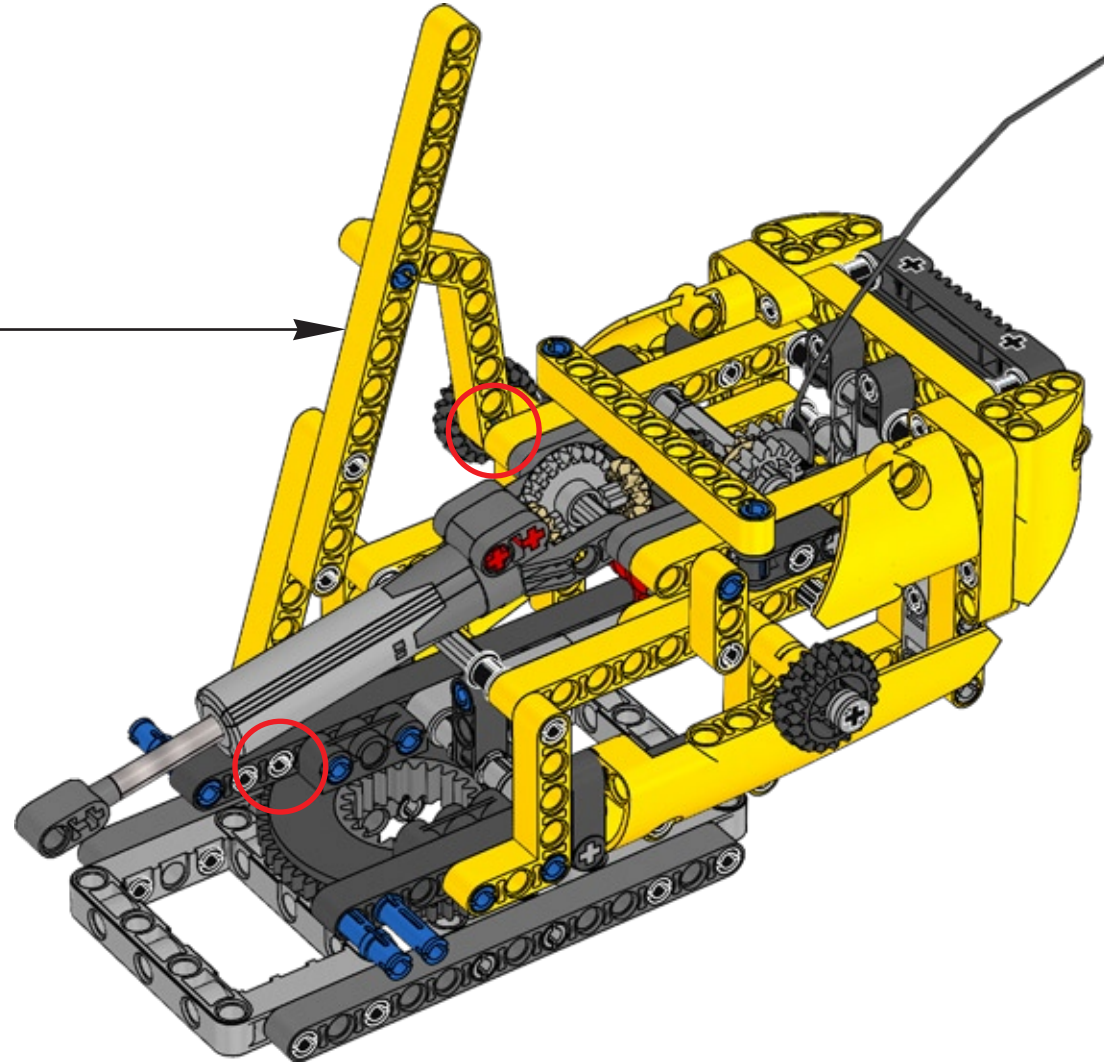

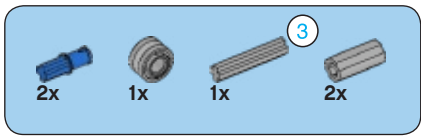

43

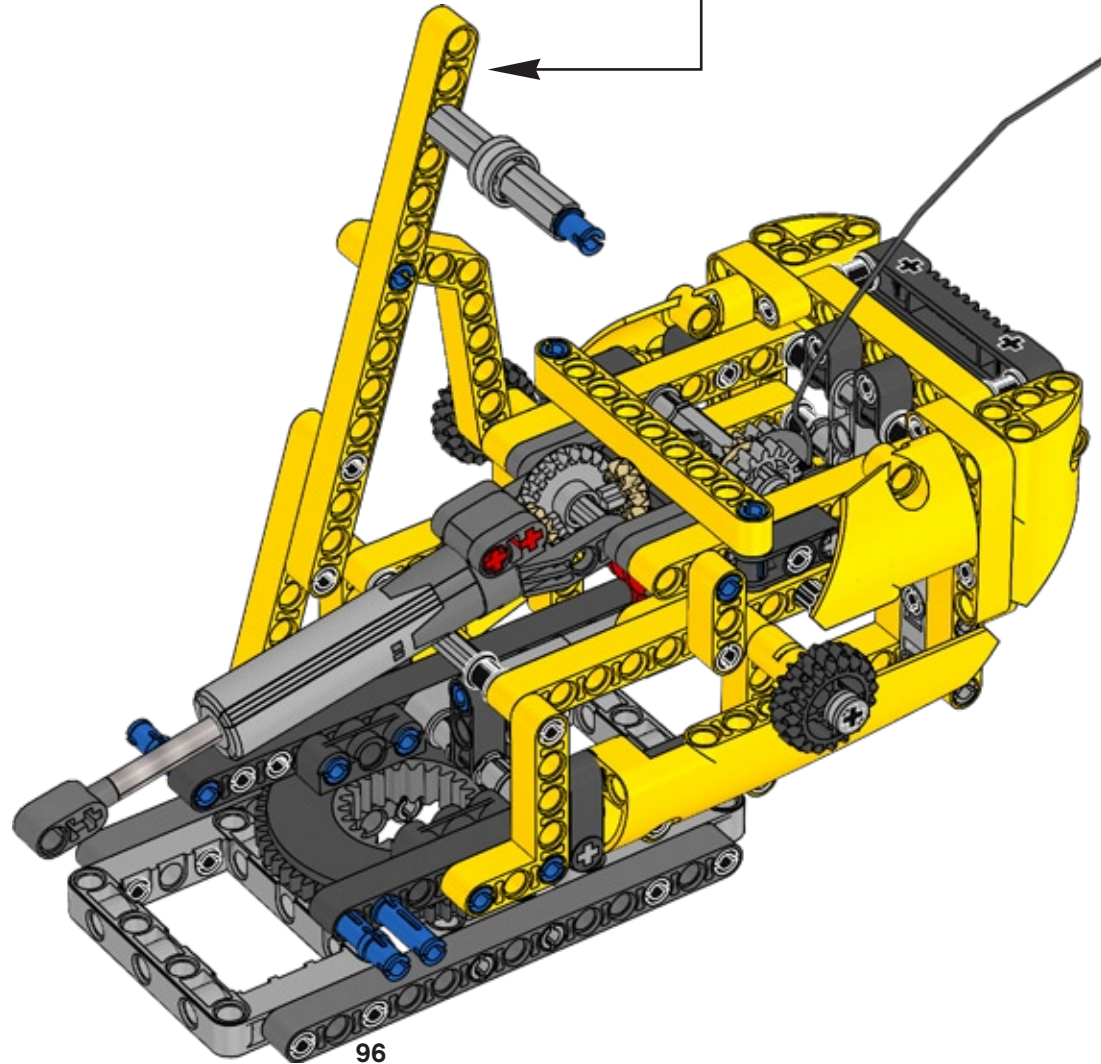
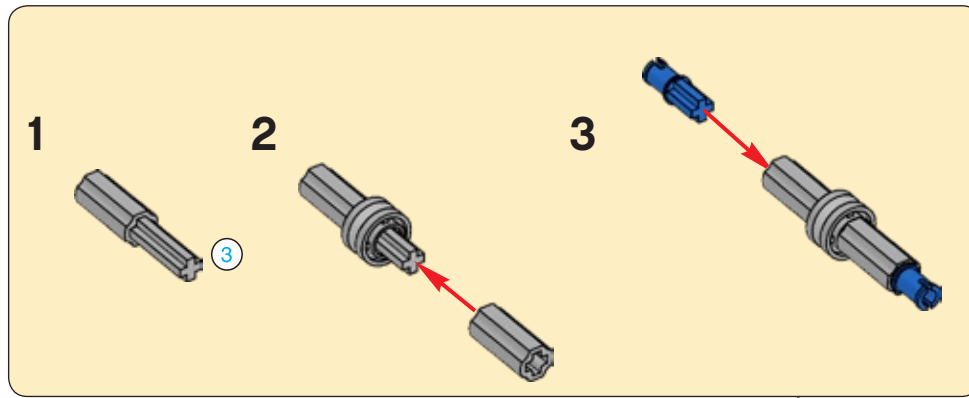



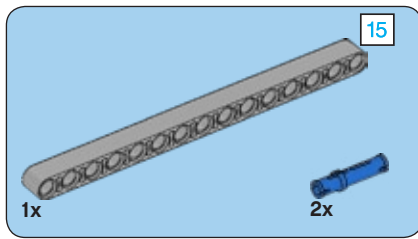
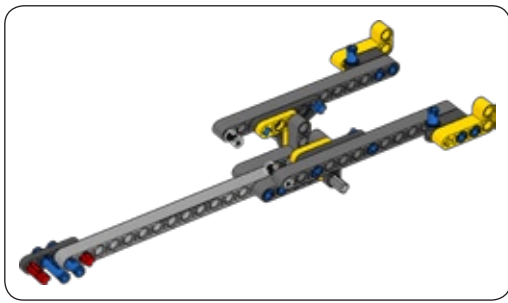

1

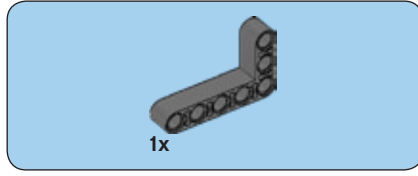
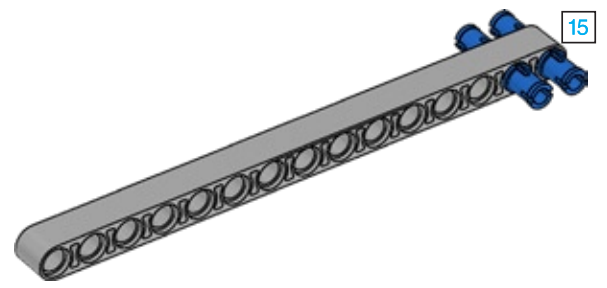

2

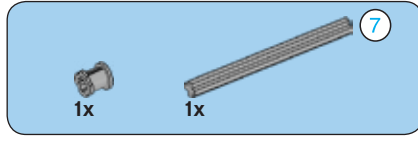
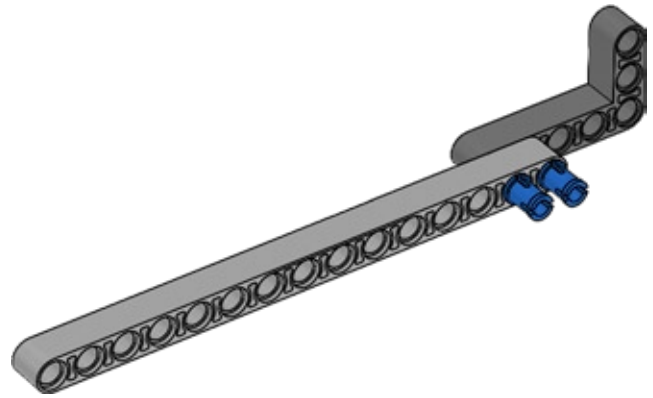

3

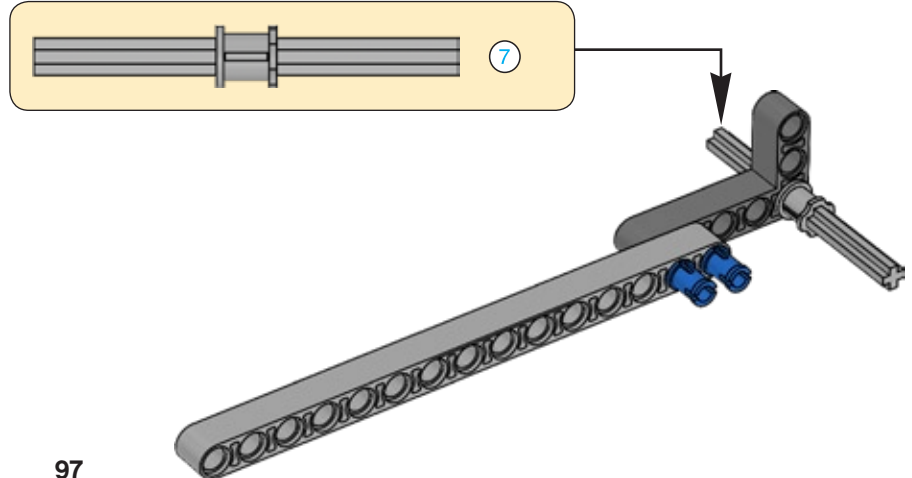

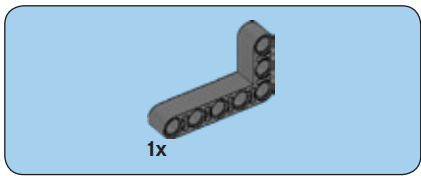

4

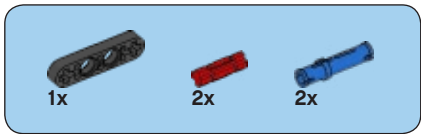
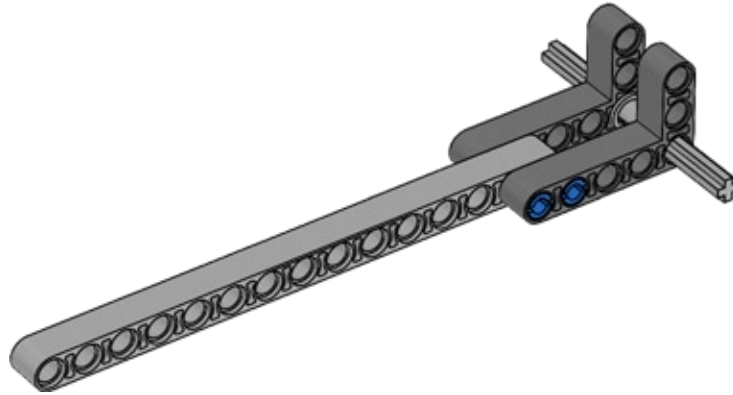

5

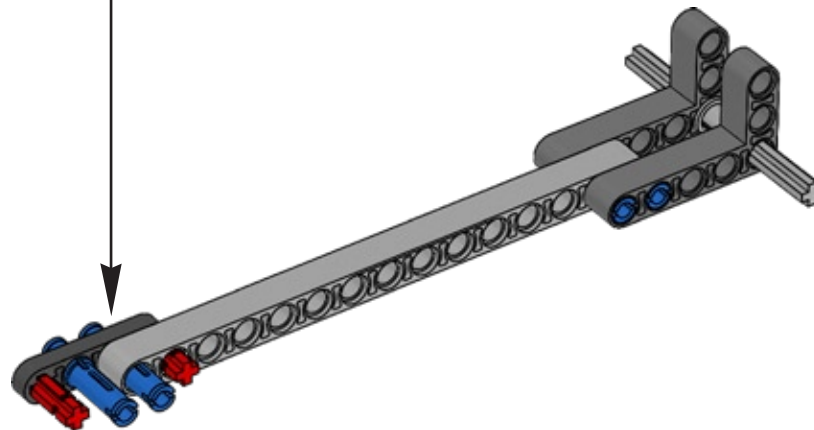
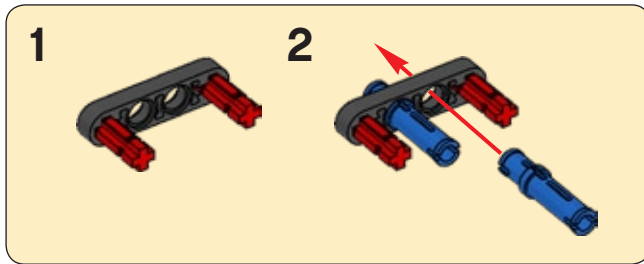

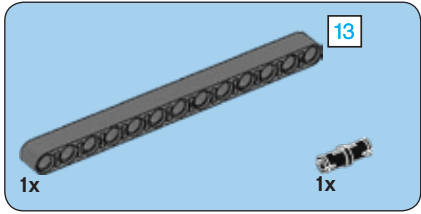
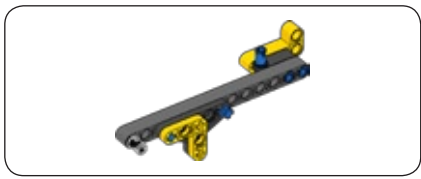

1

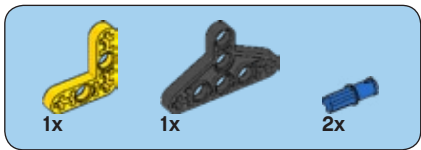
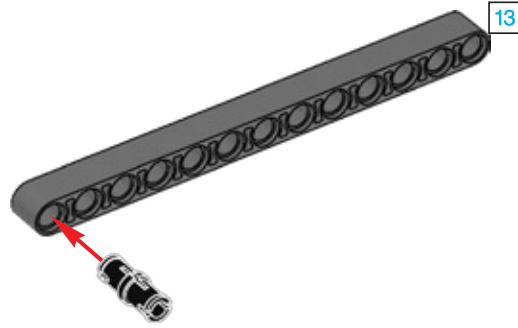

2

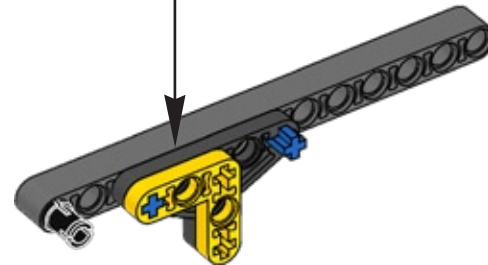
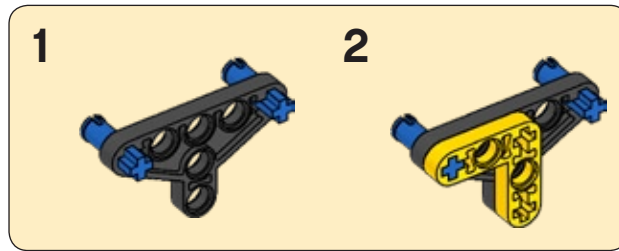

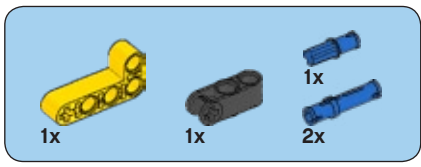

3

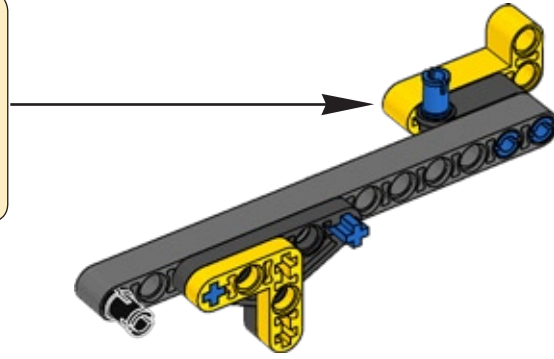
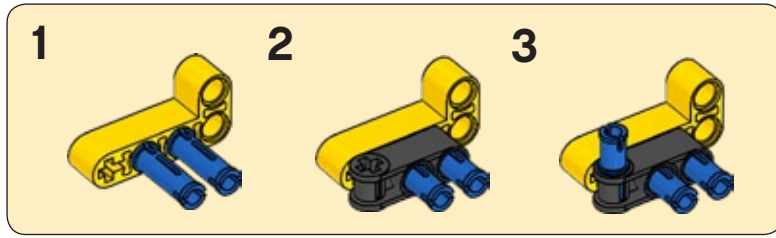

6

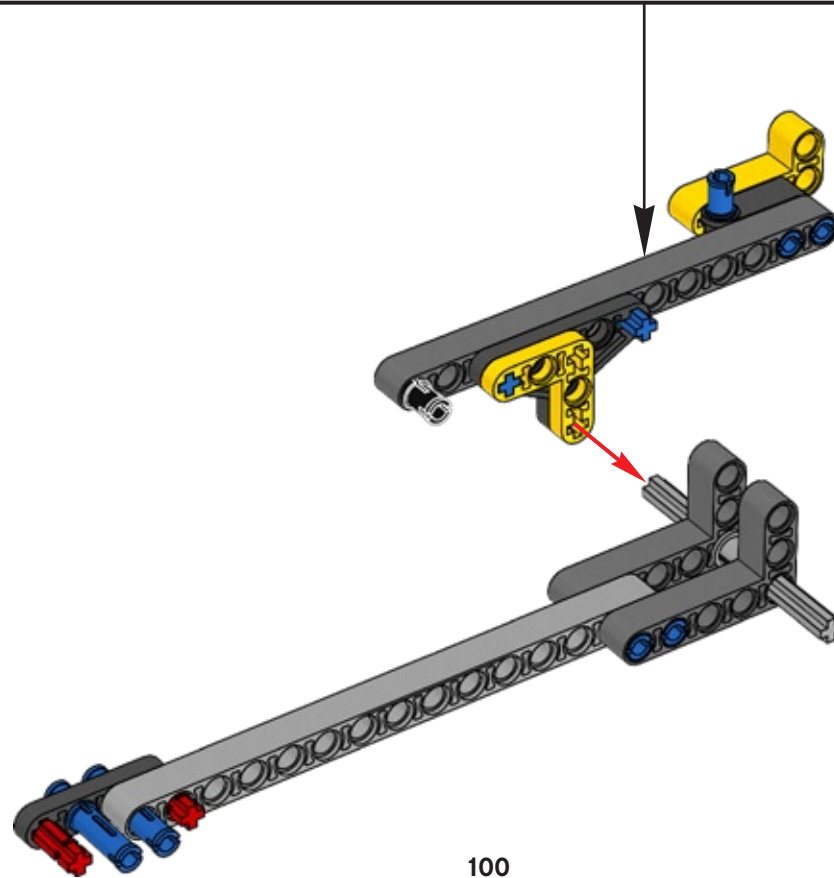

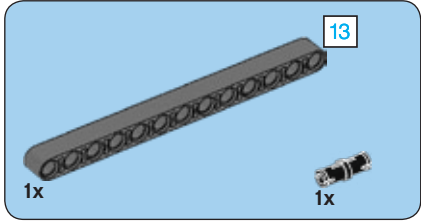
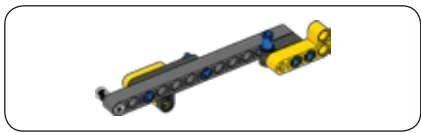

1

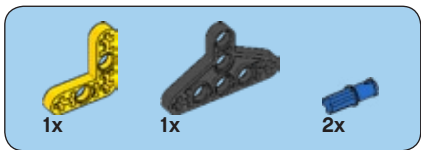
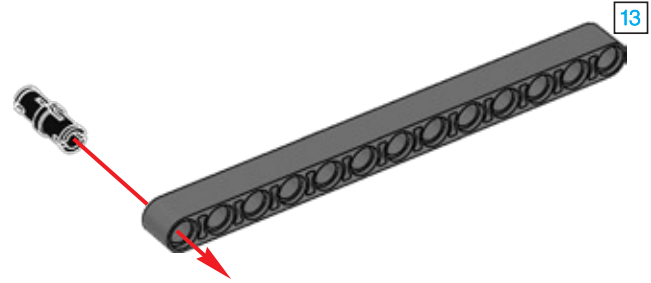

2

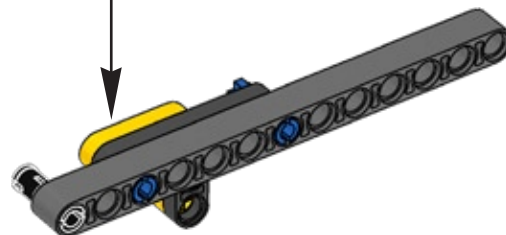
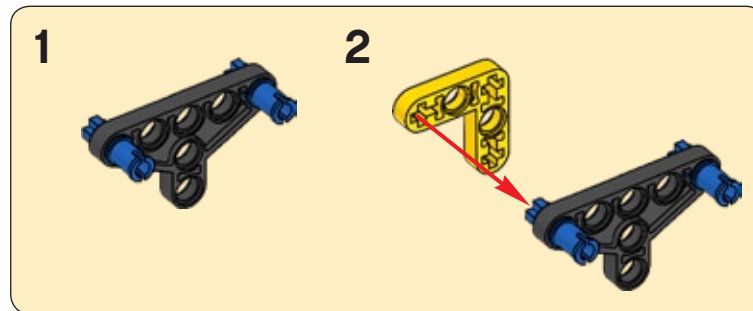

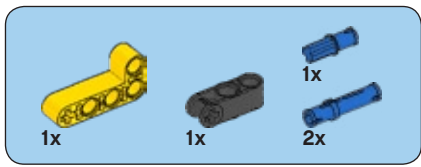

3

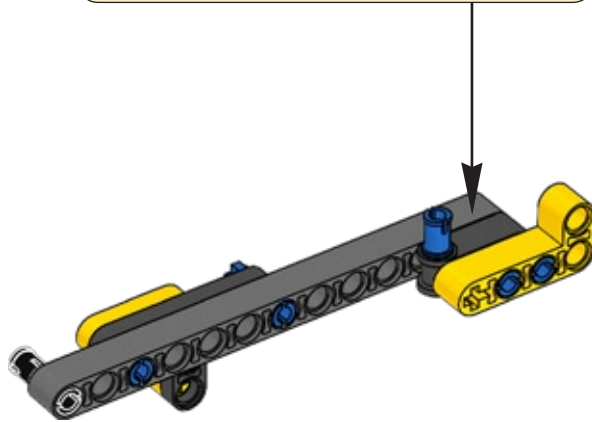

7

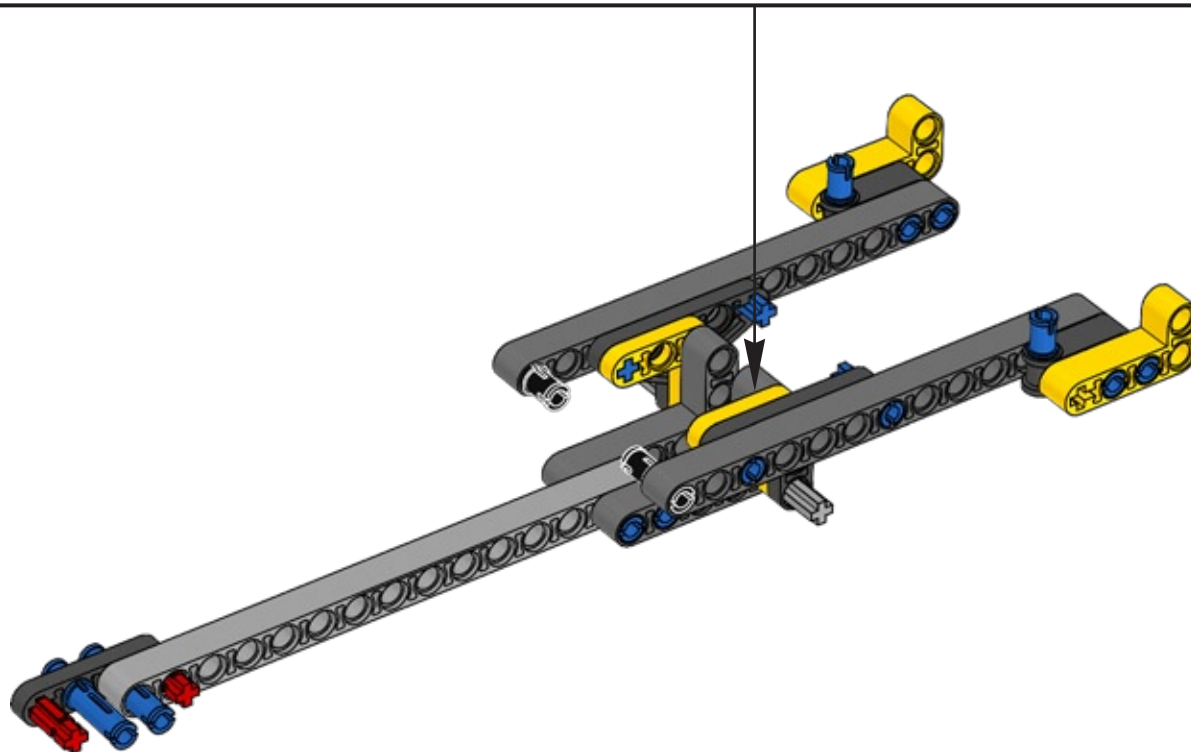

44

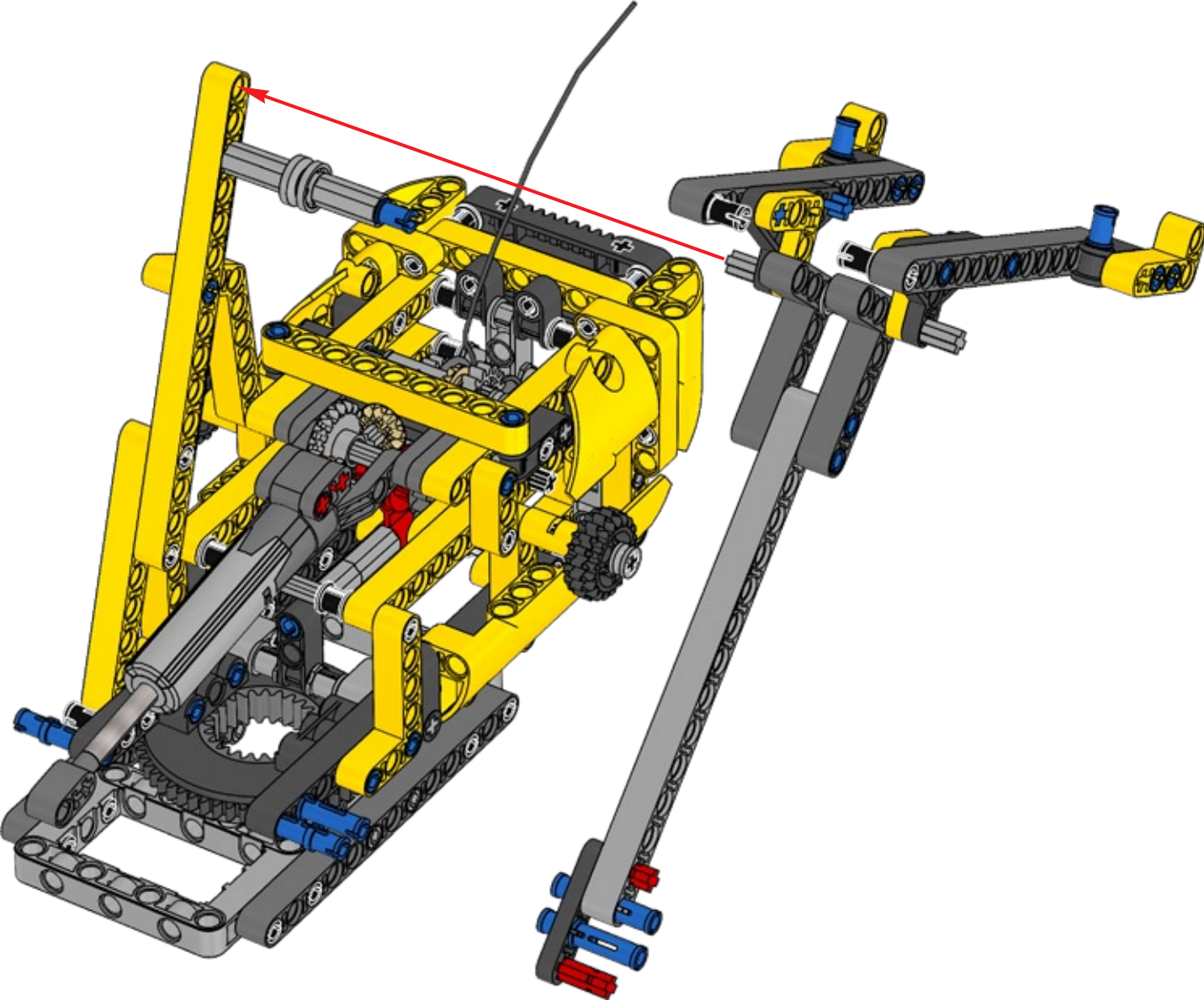

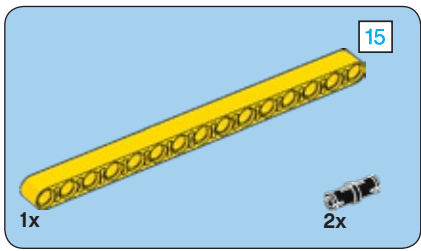

1

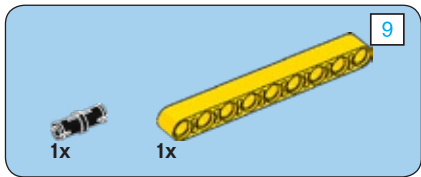
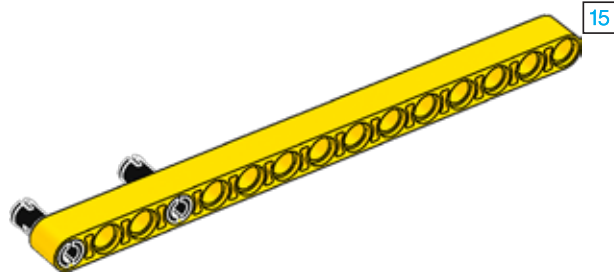

2

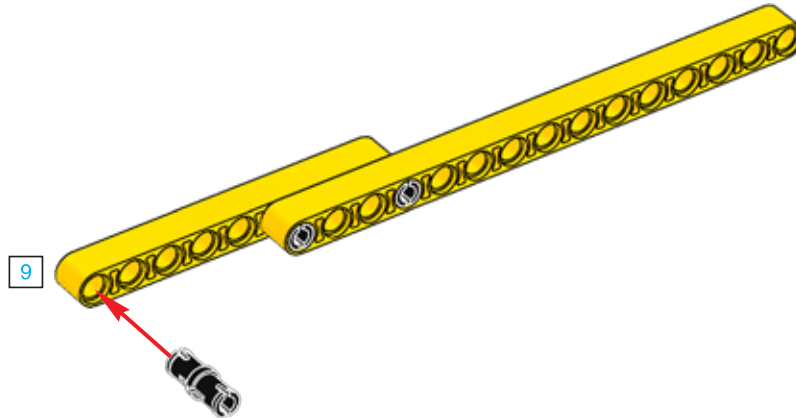



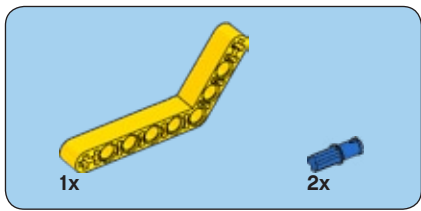

3

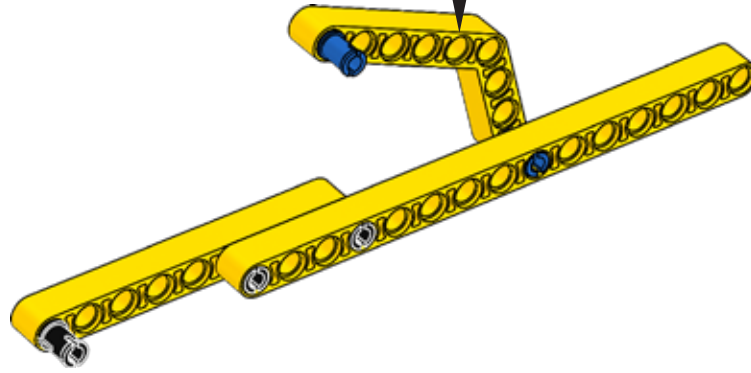
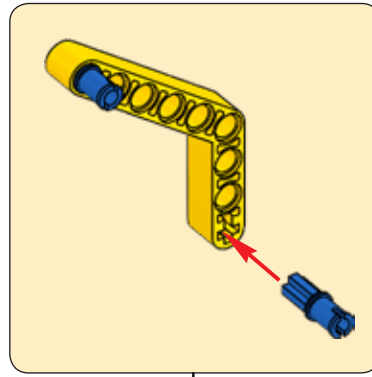

3

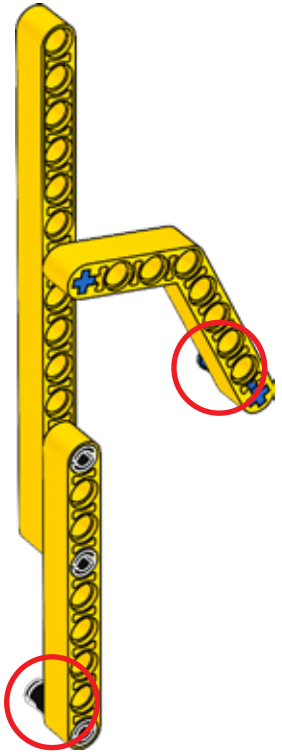

45

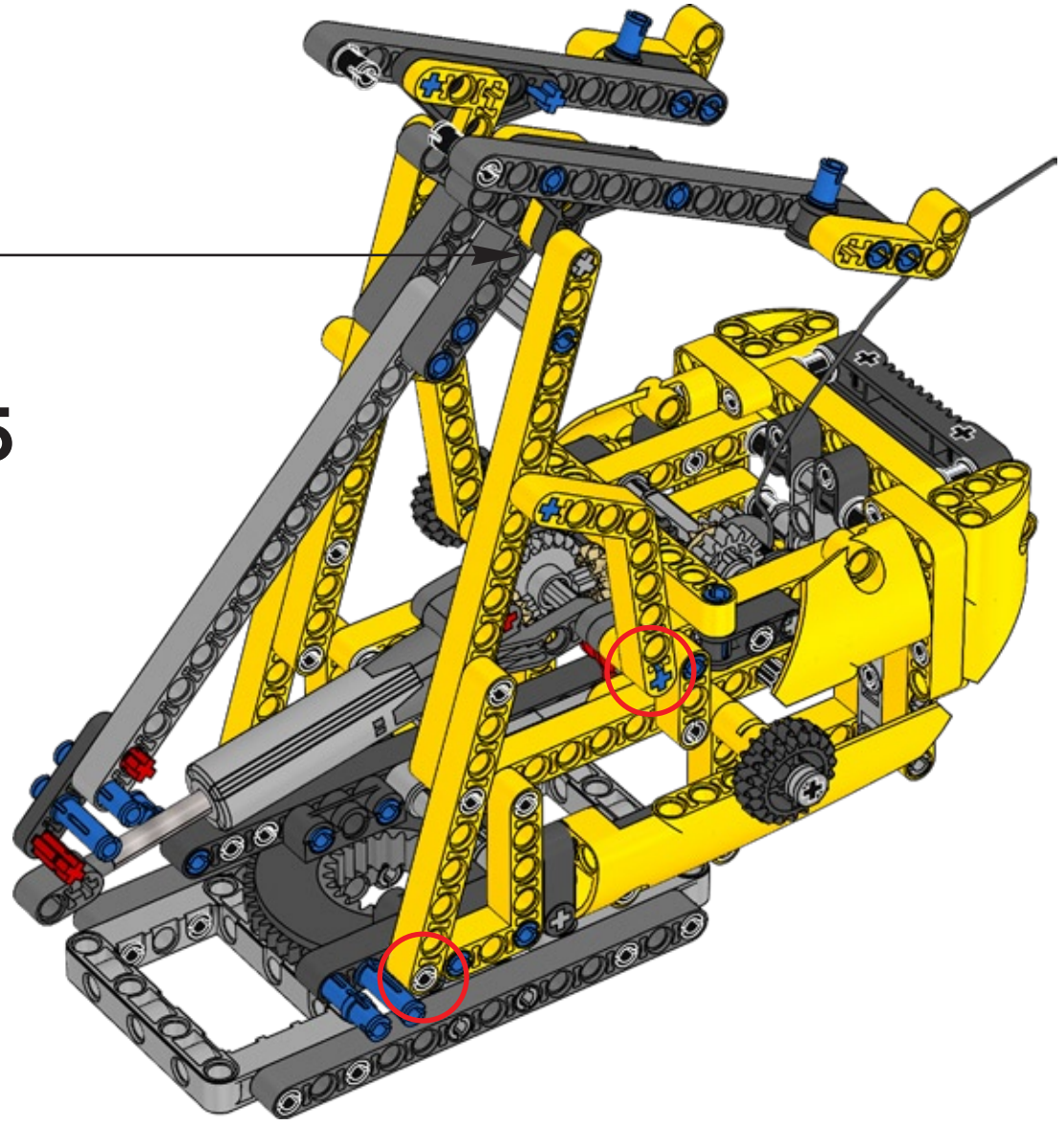

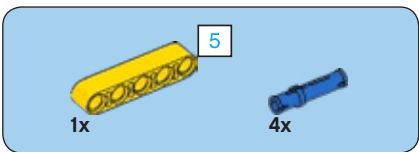
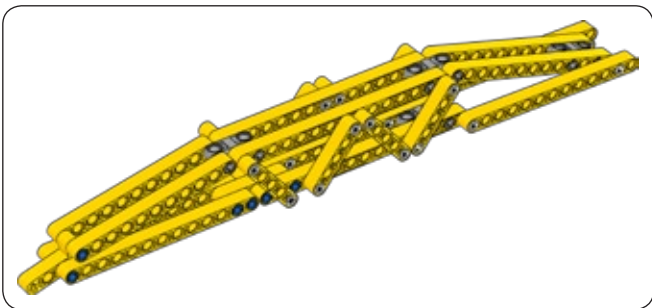

1

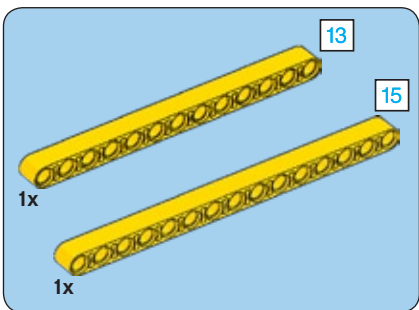
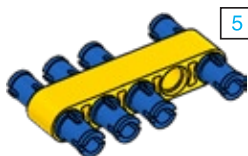

2

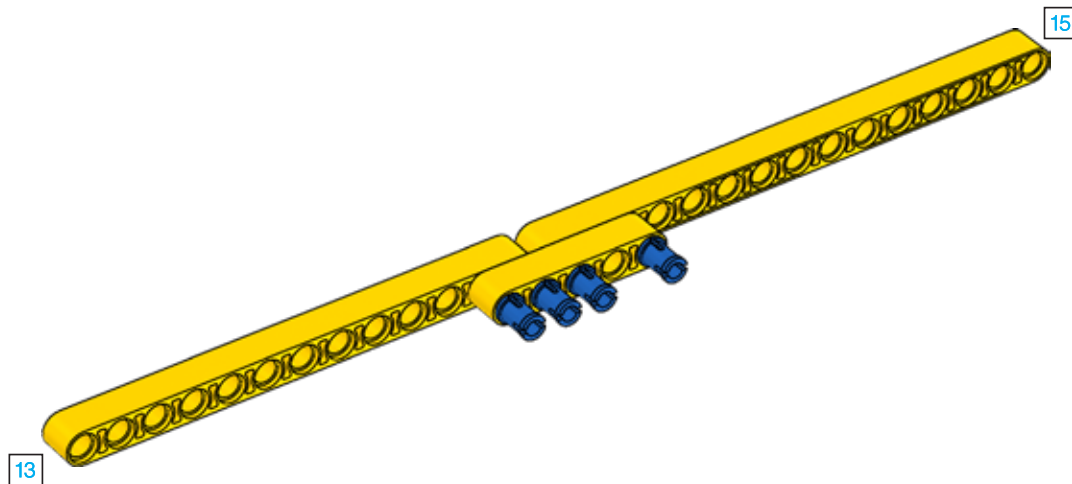

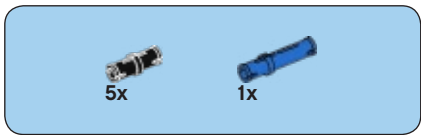

3

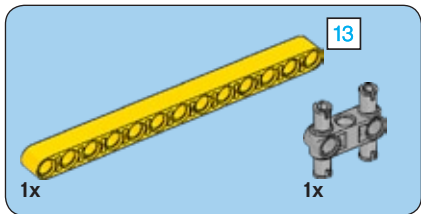
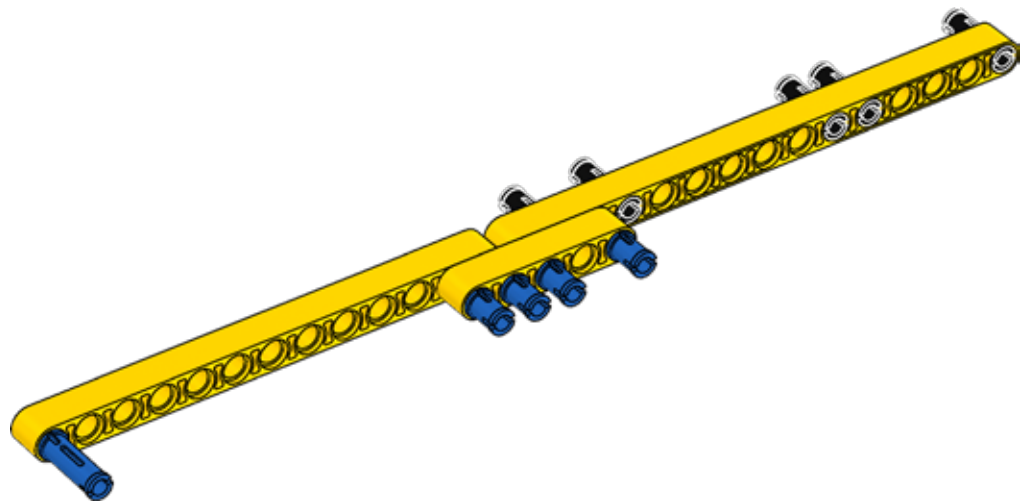

4

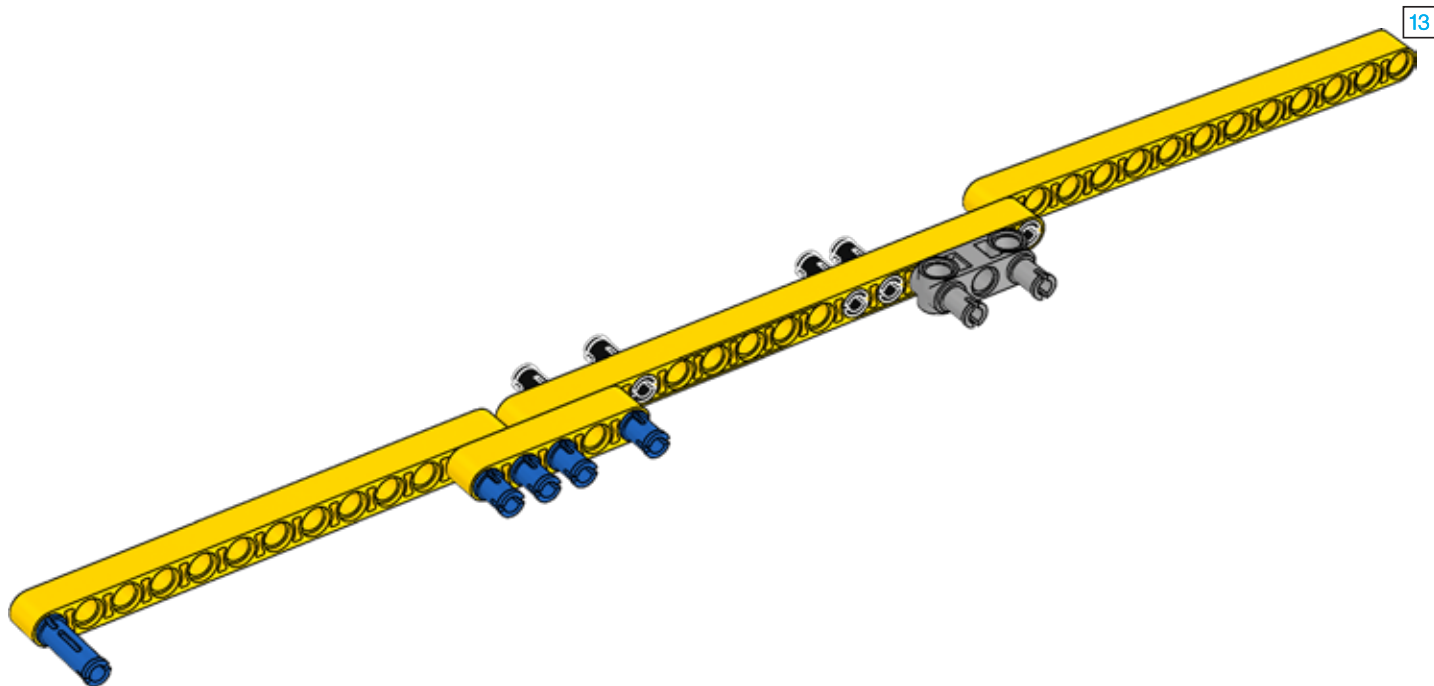

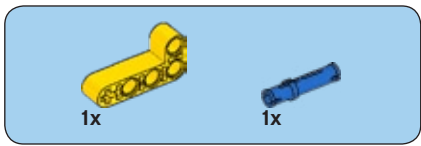

5

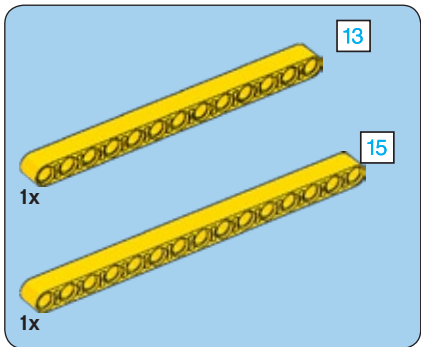
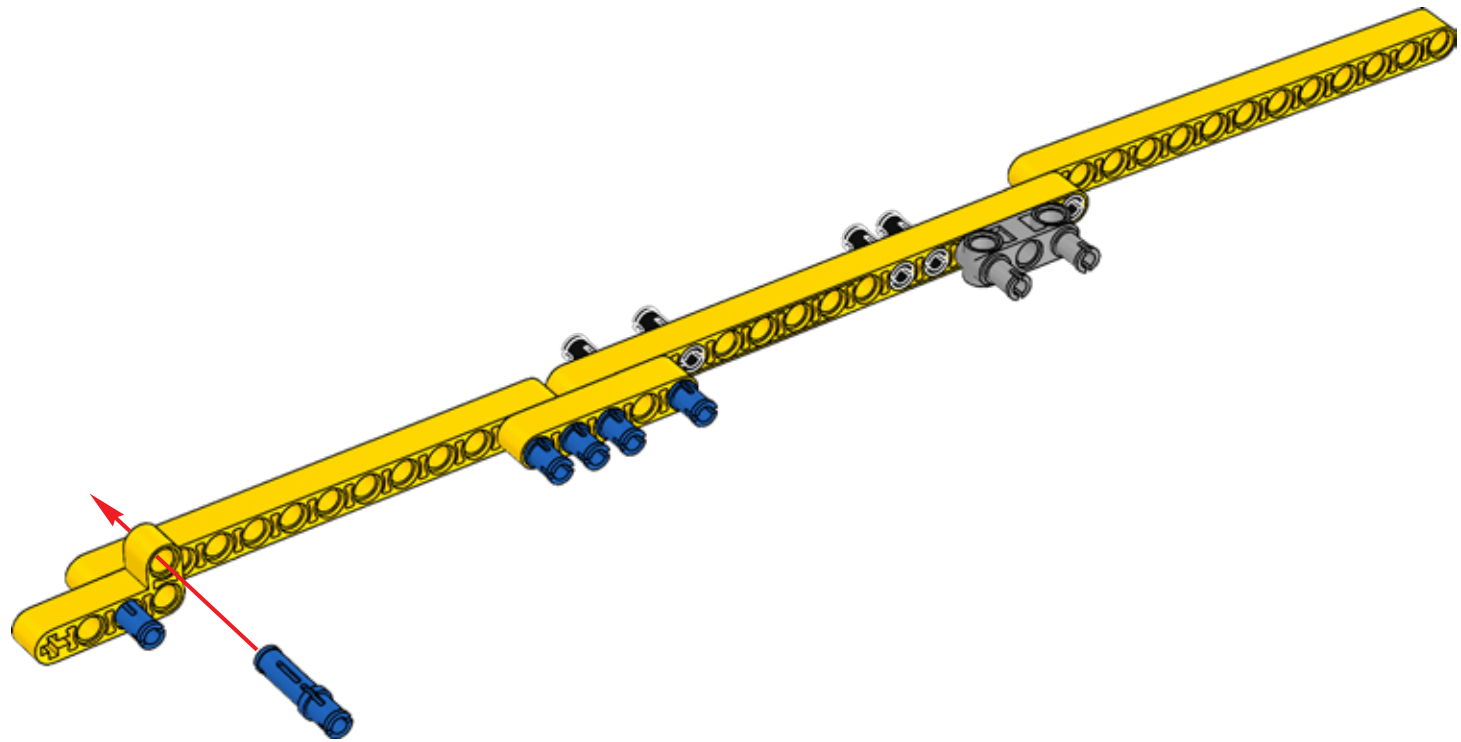

6

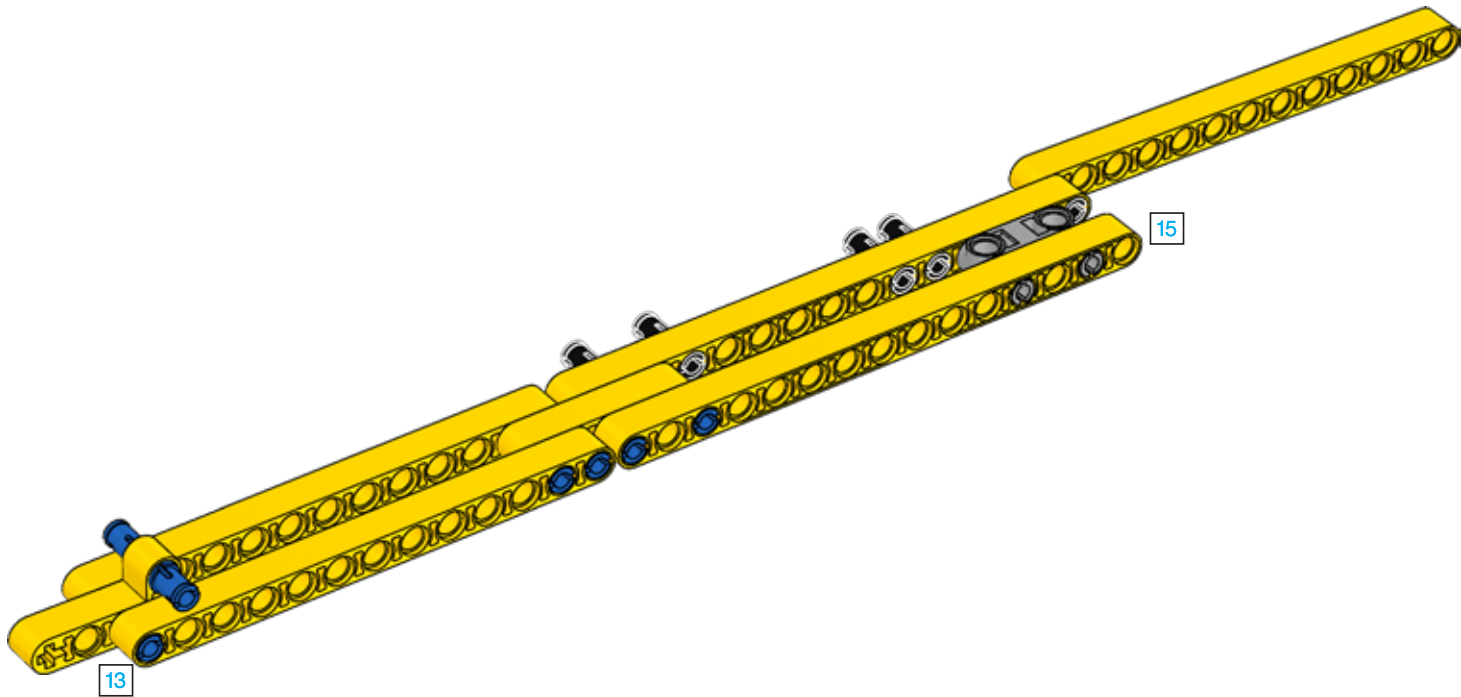



7

