

8444

# TECHNIC

LEGO

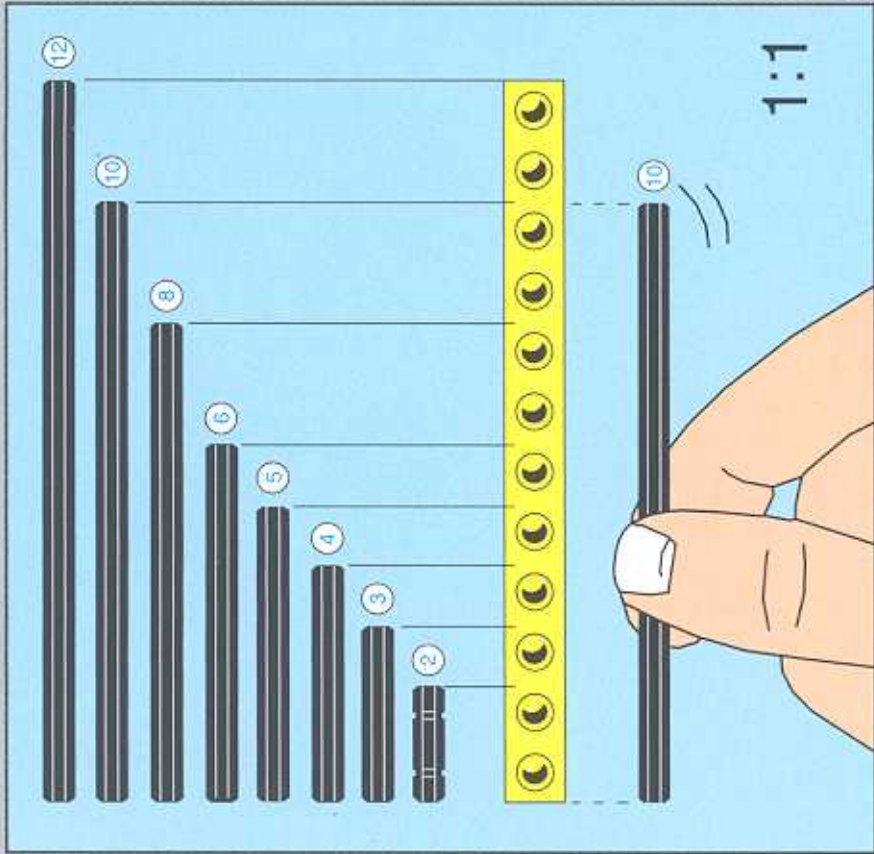

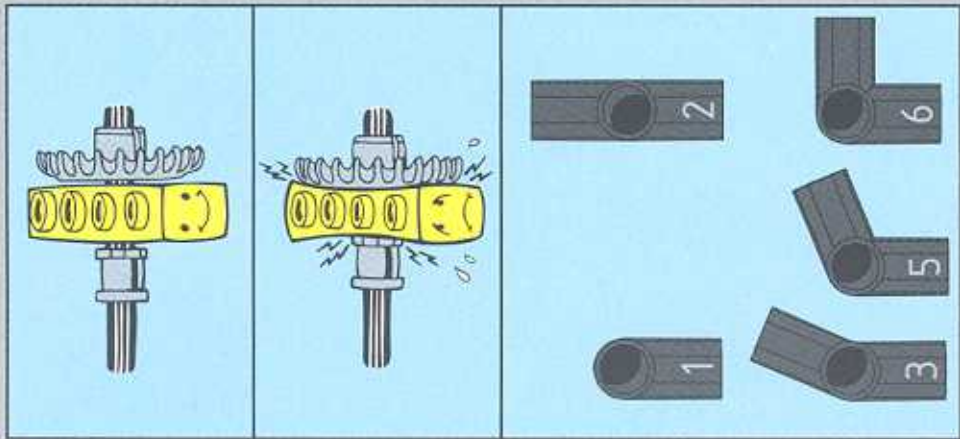

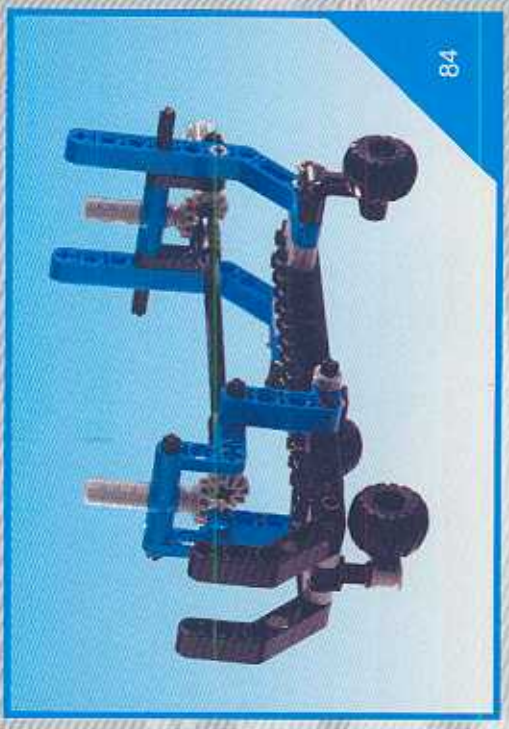

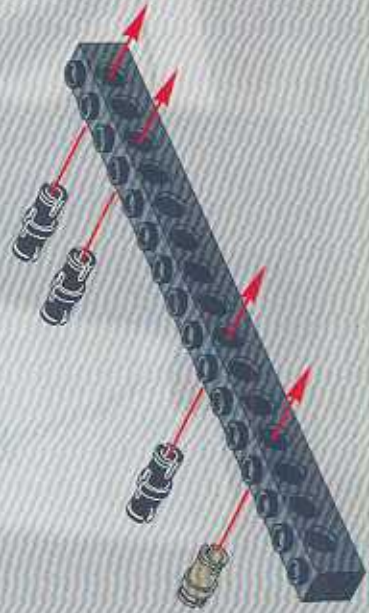
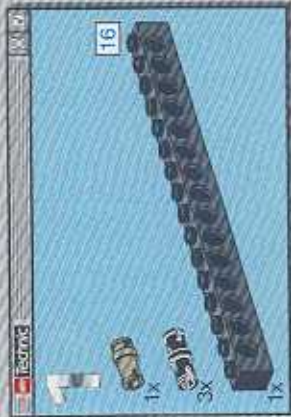
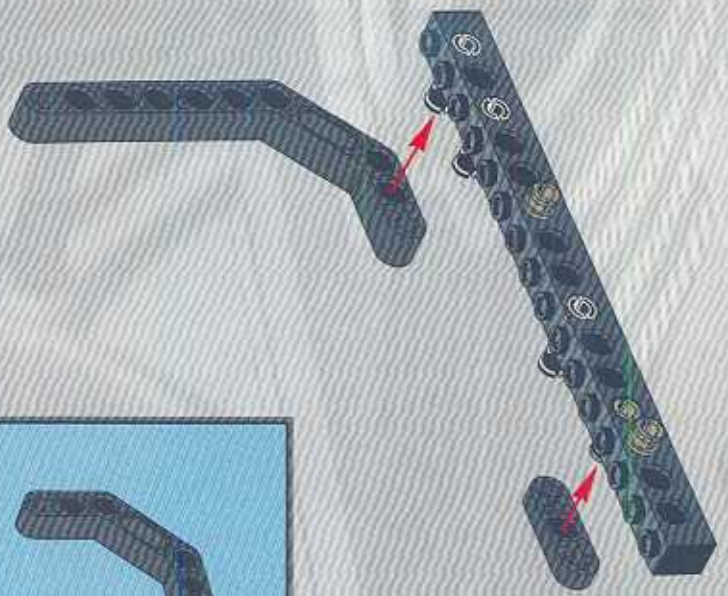
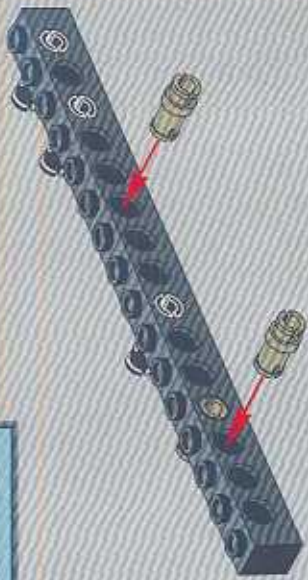

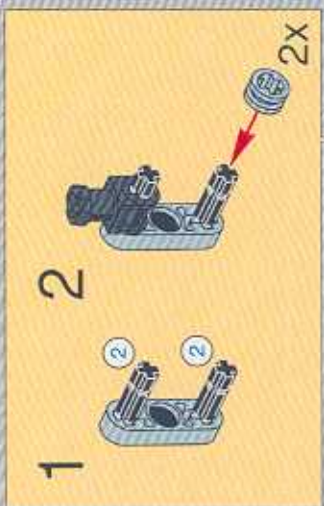
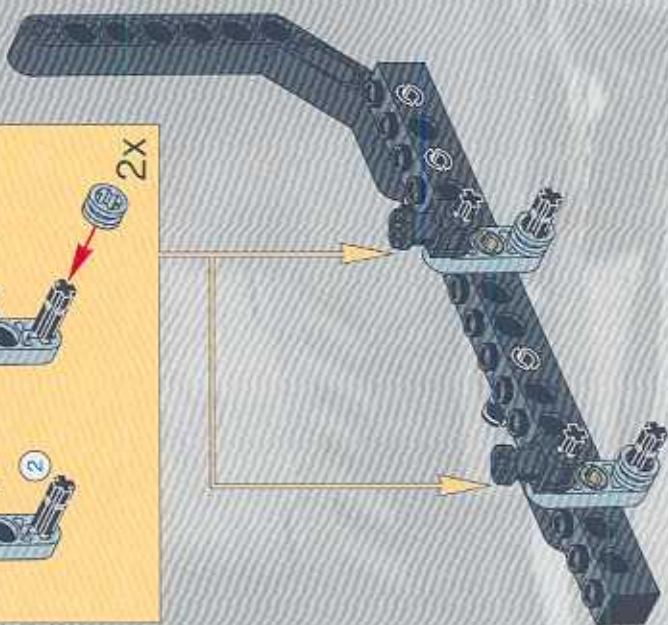
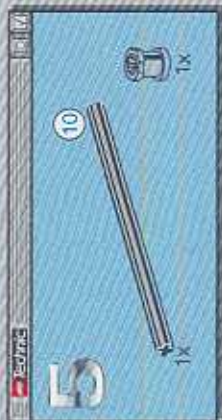
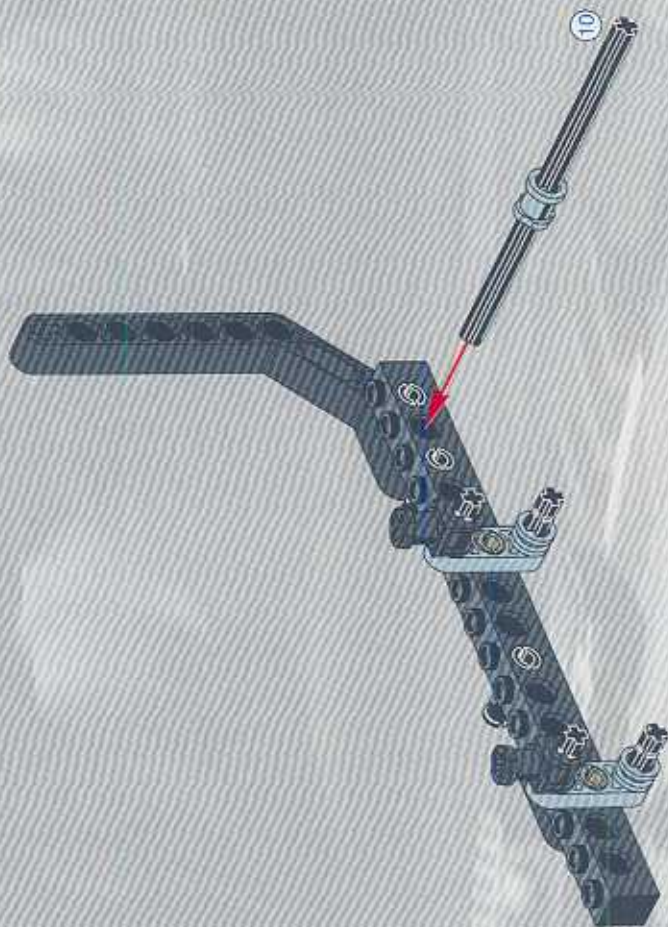

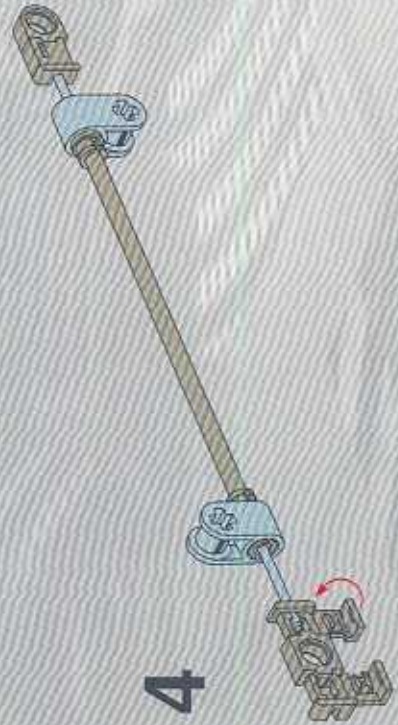
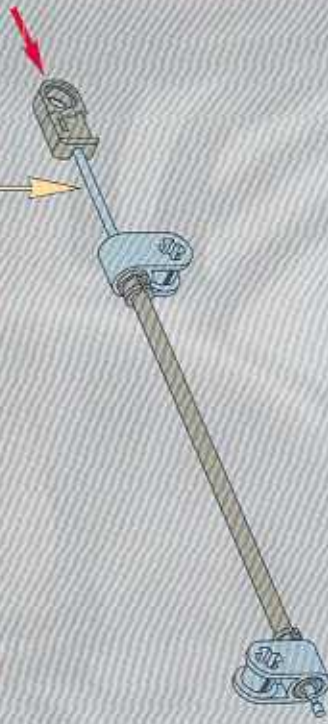
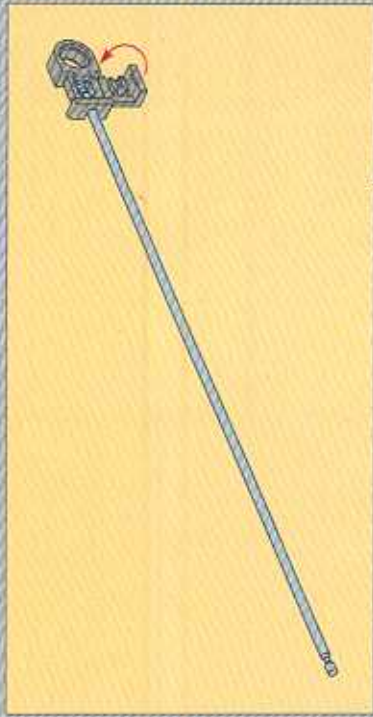
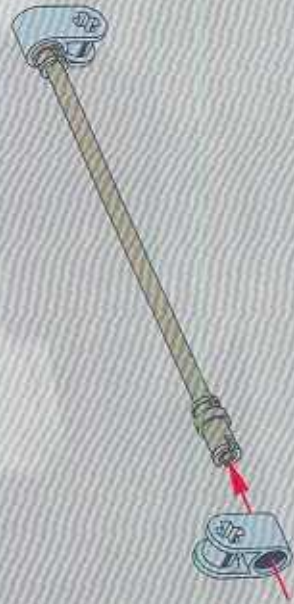
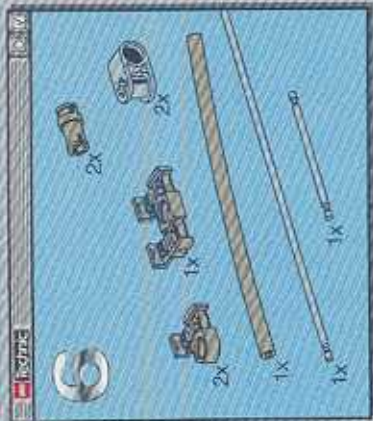

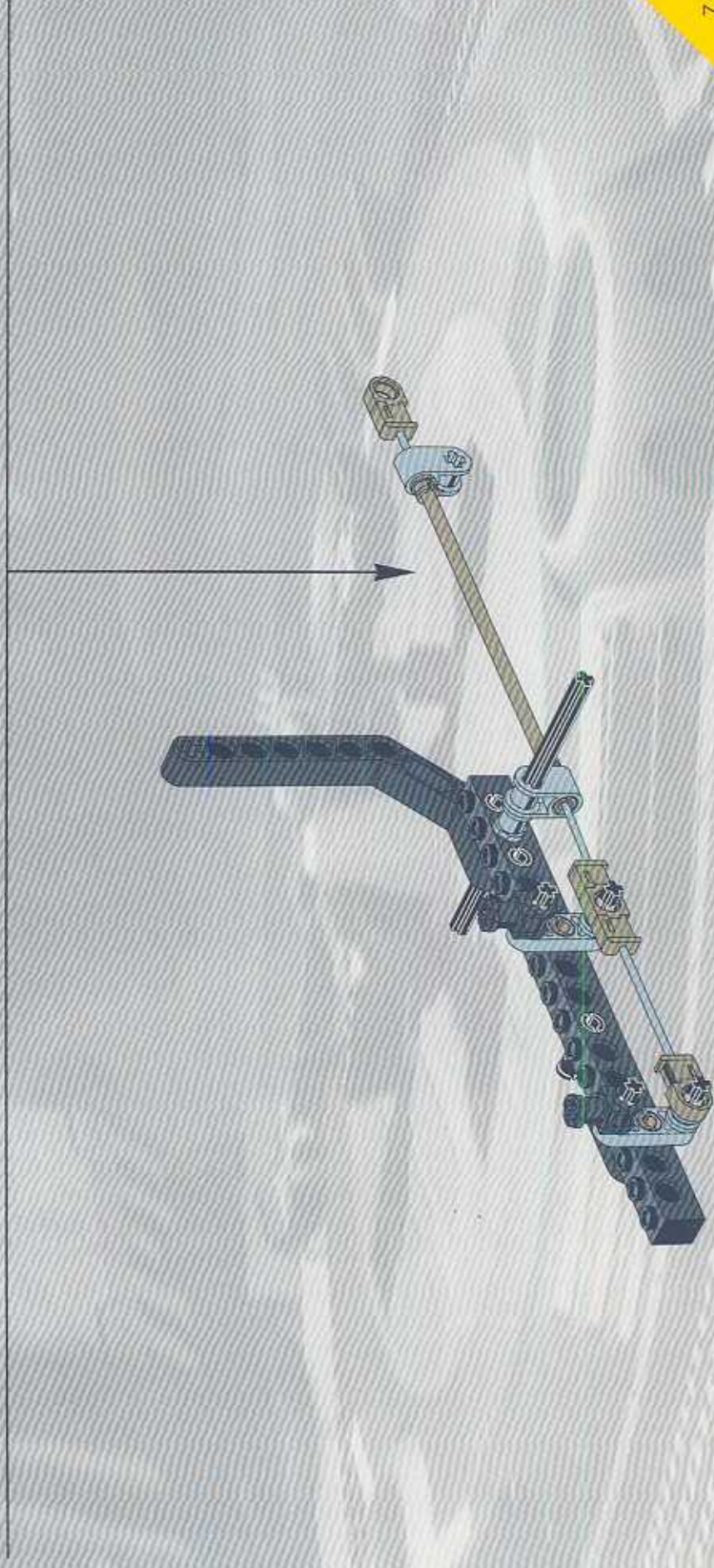
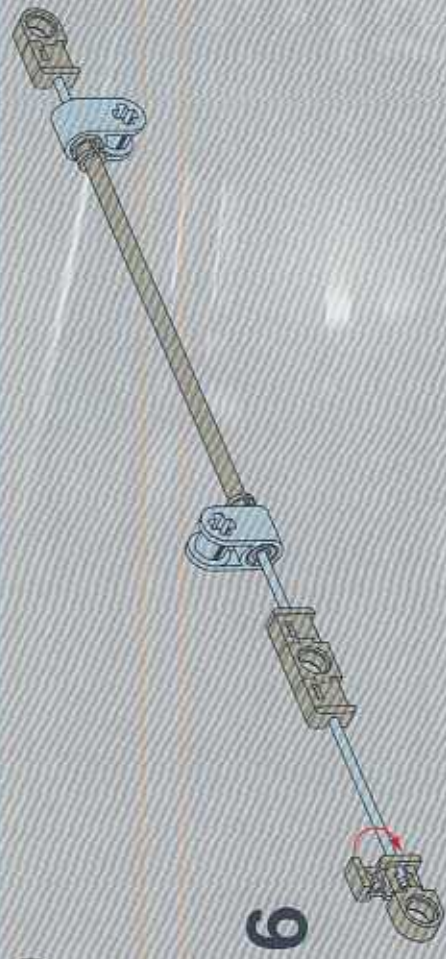
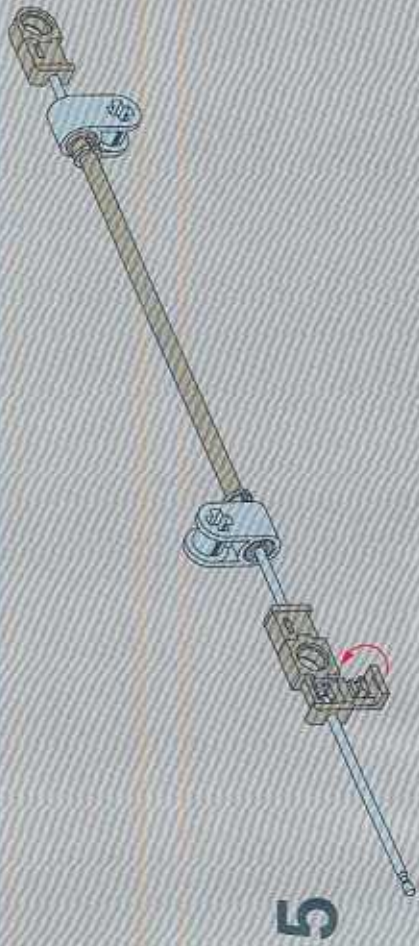





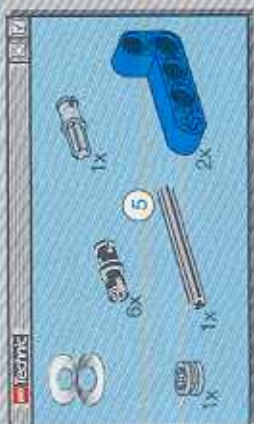
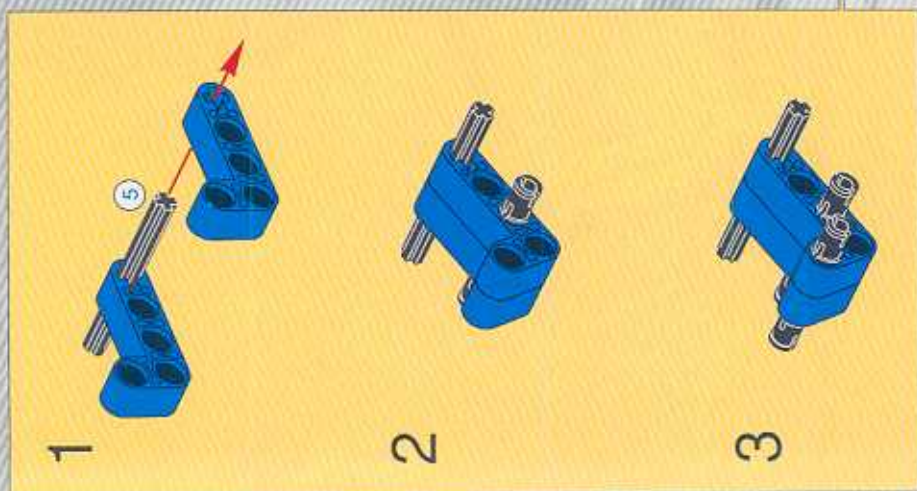
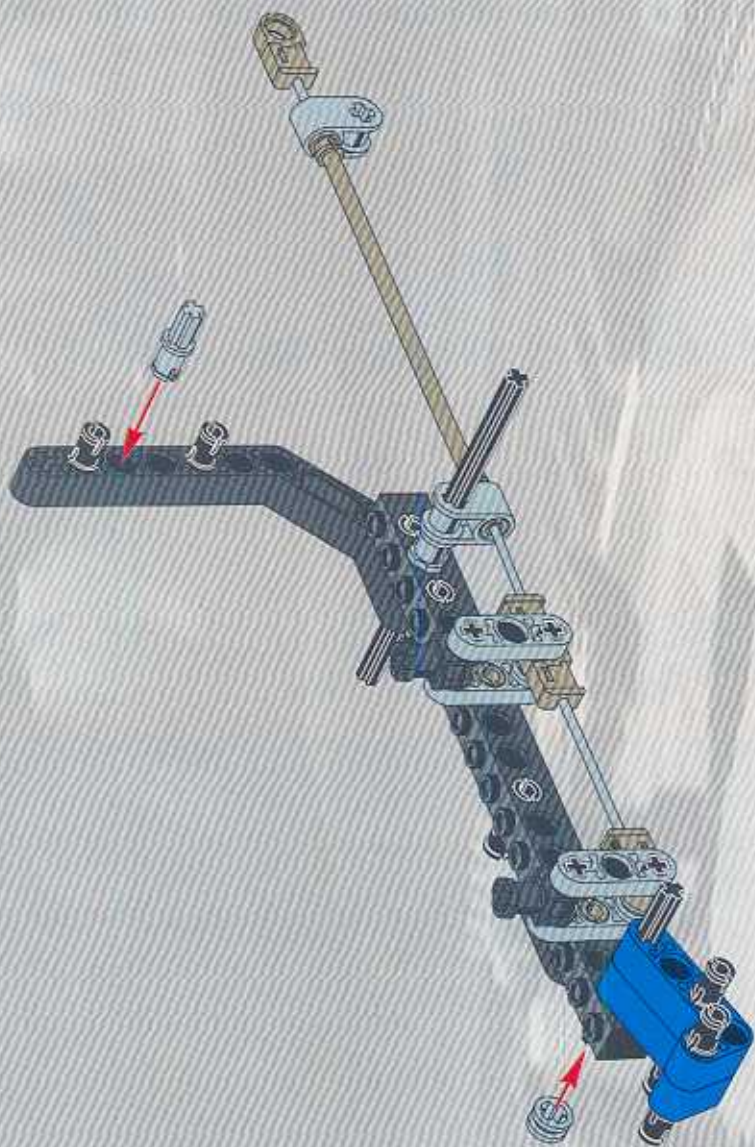

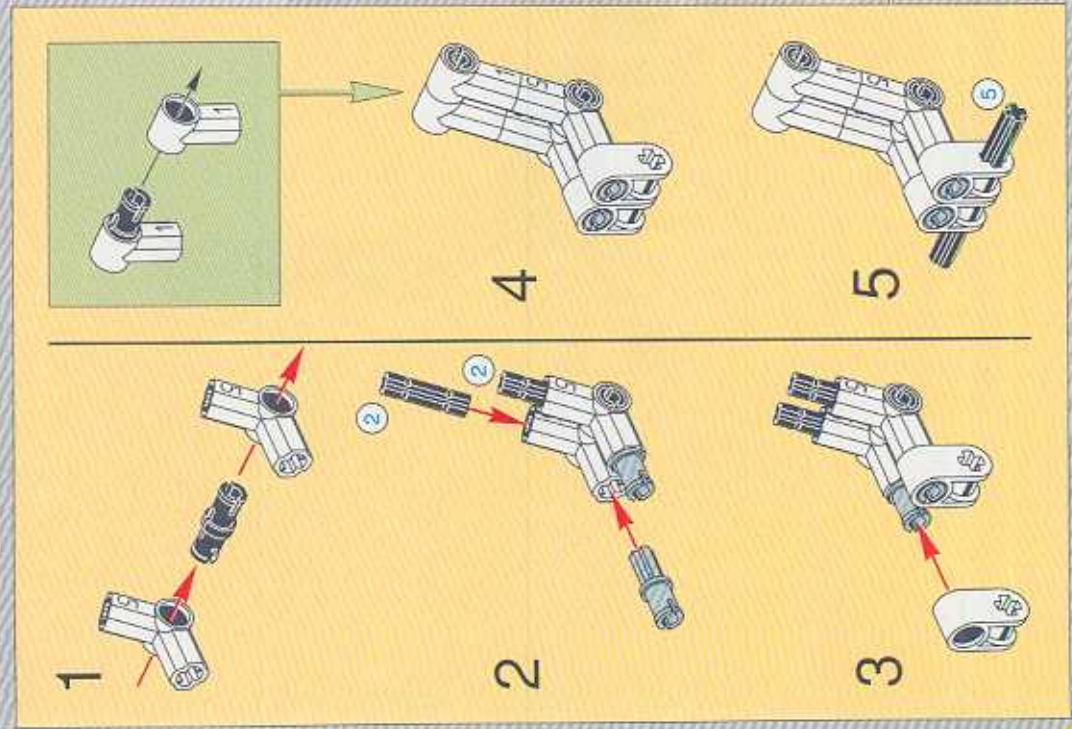
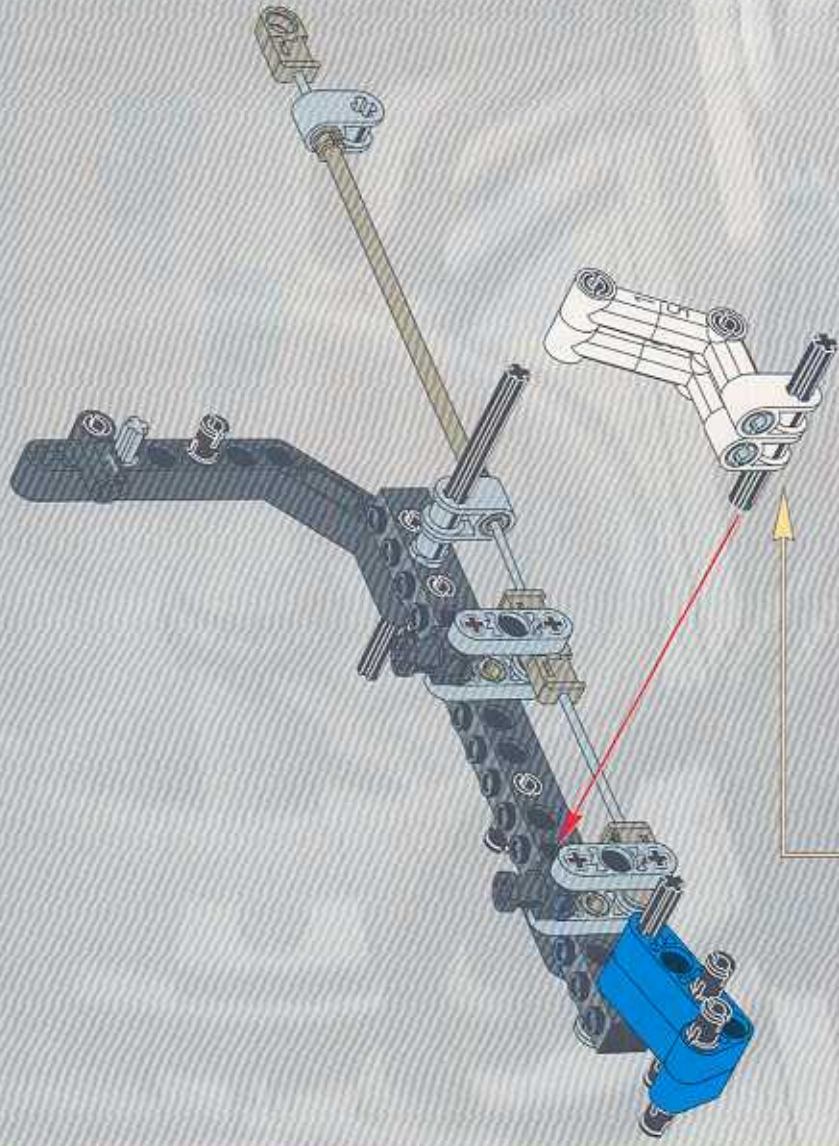

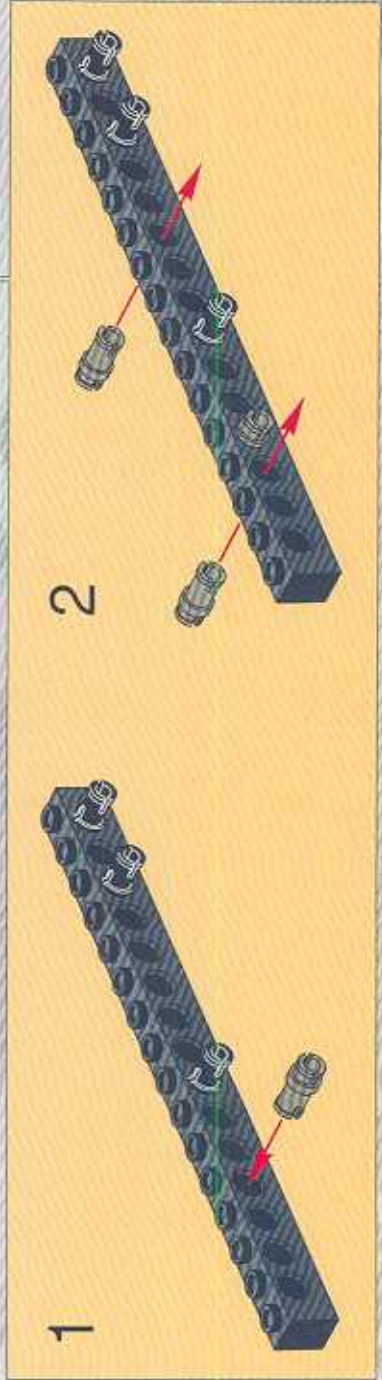
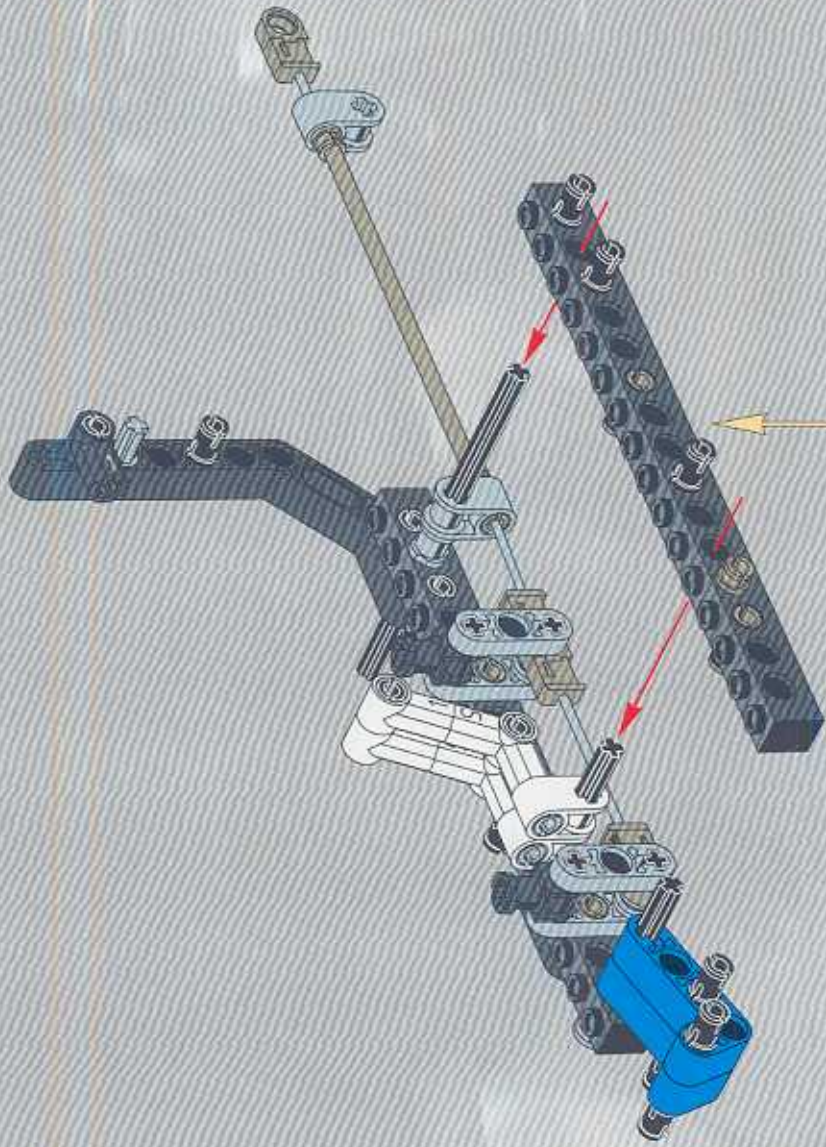

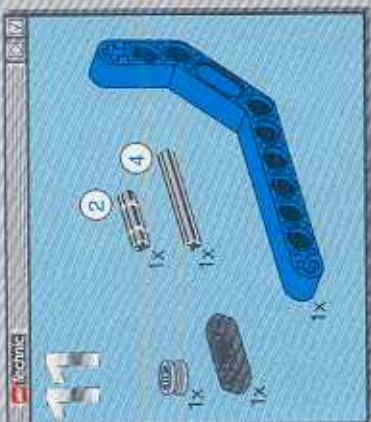
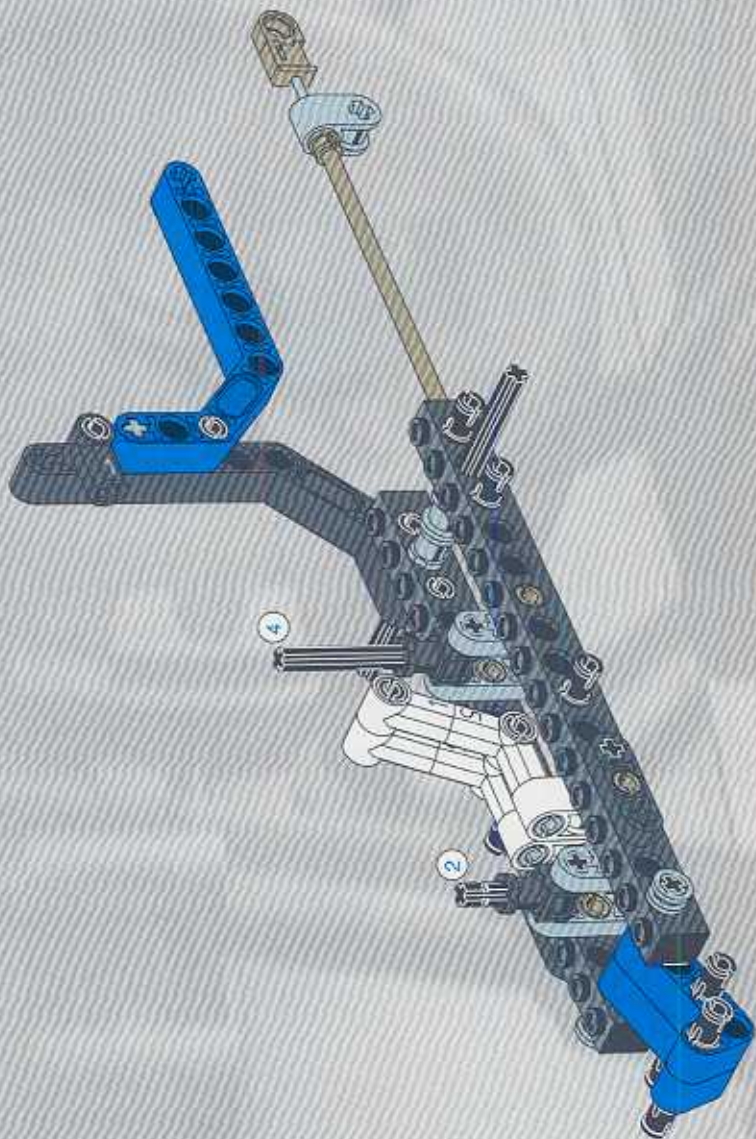

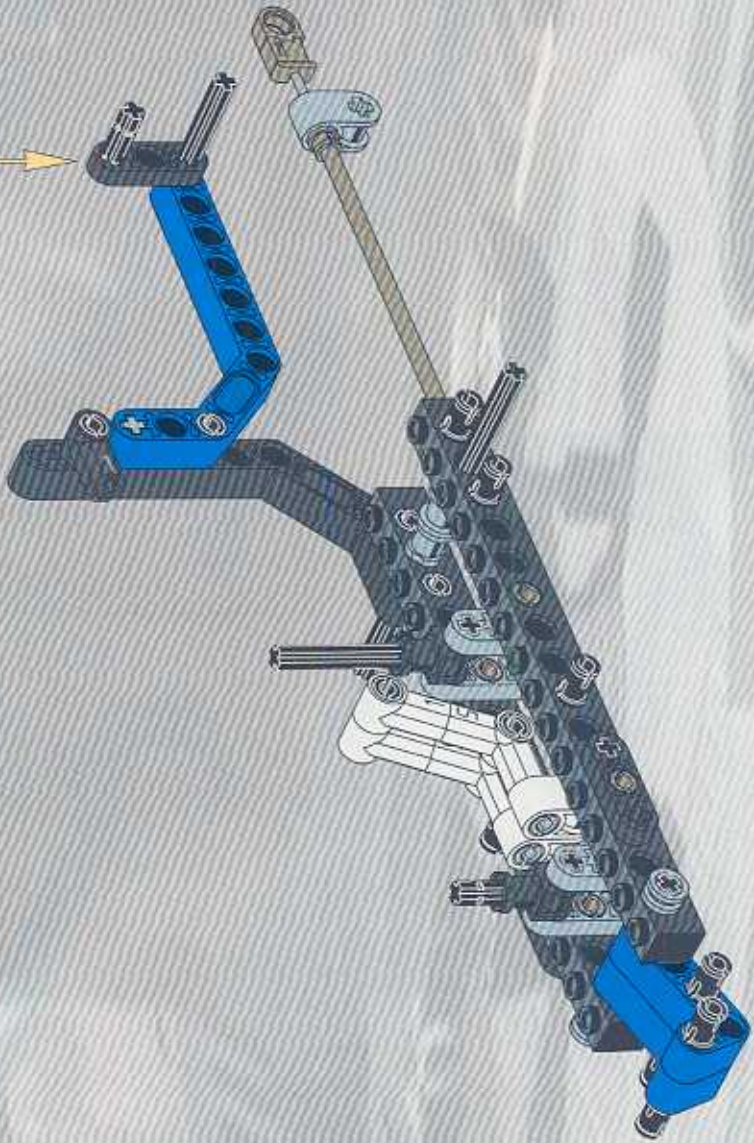

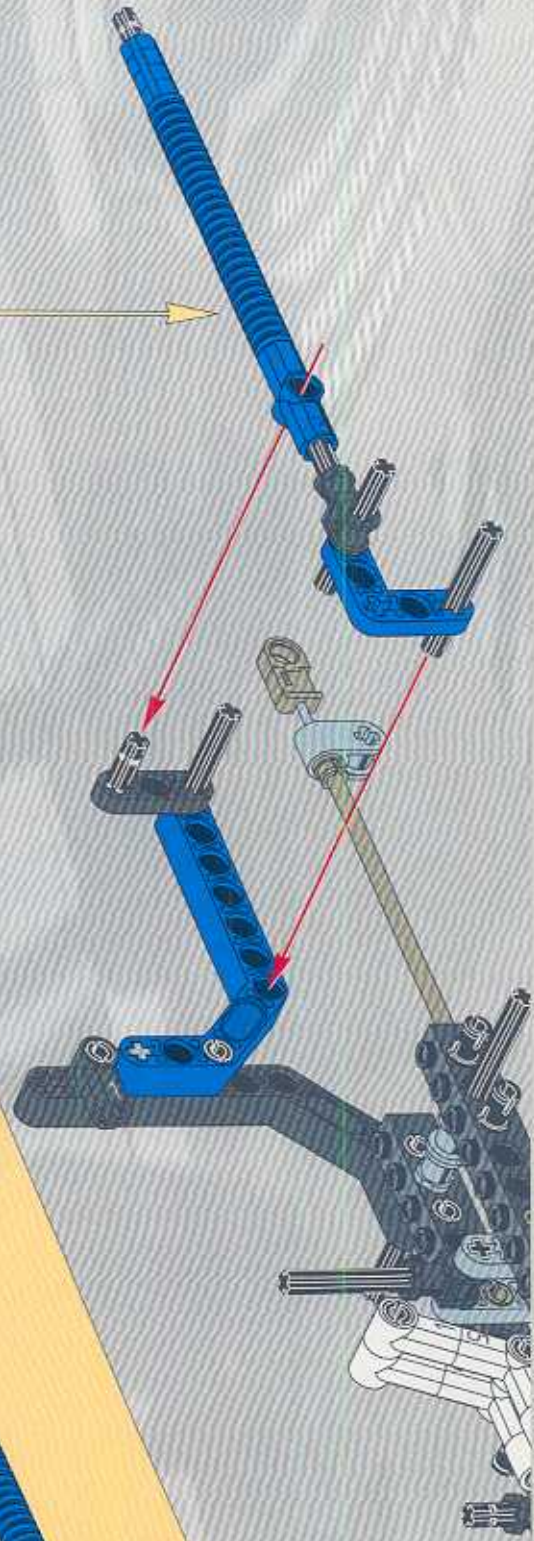
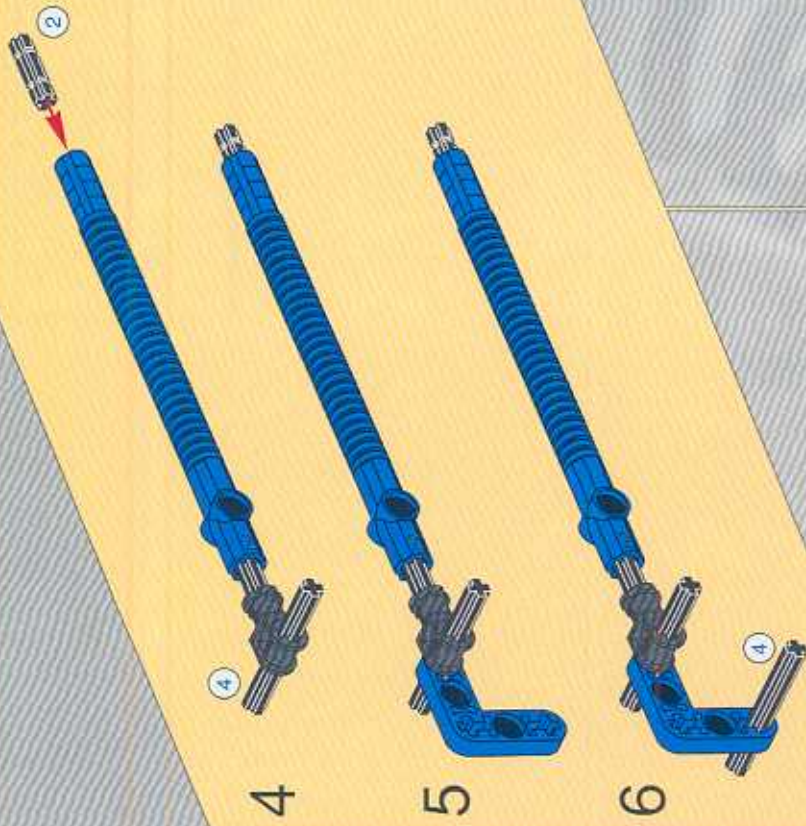
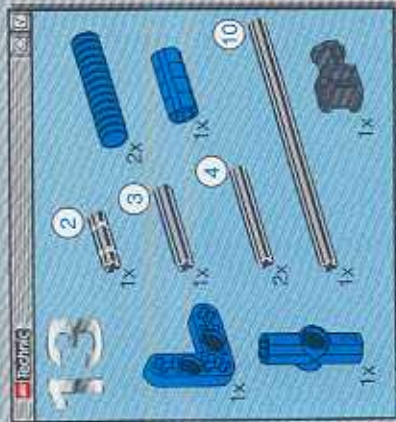

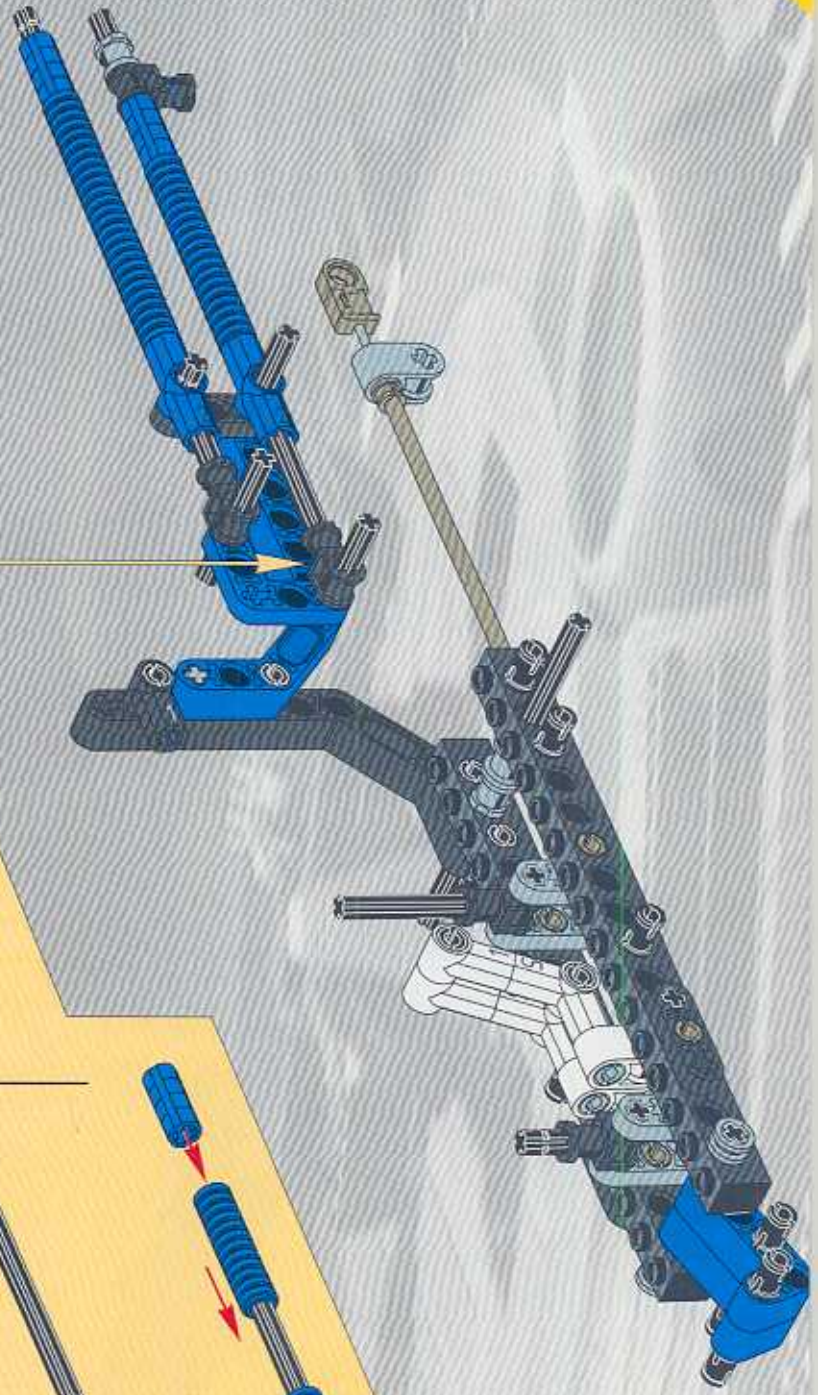
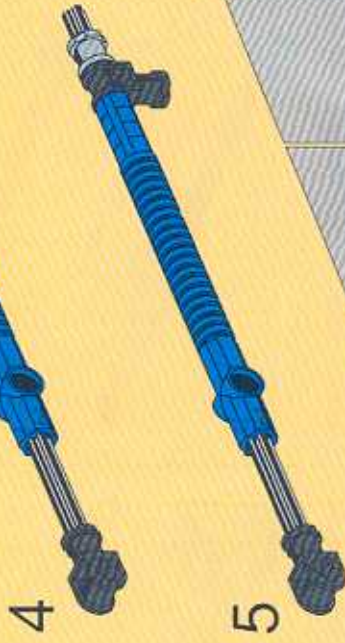
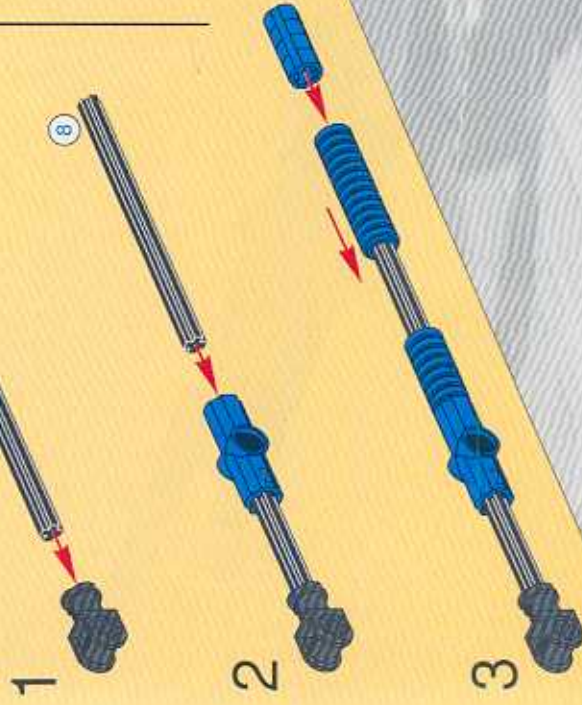
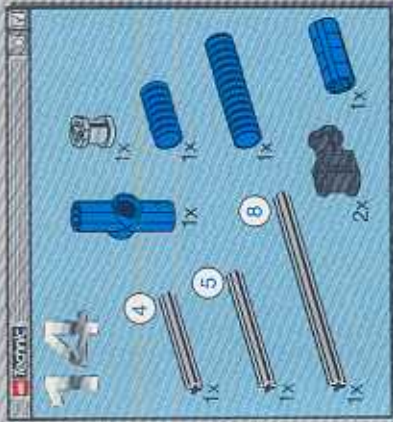

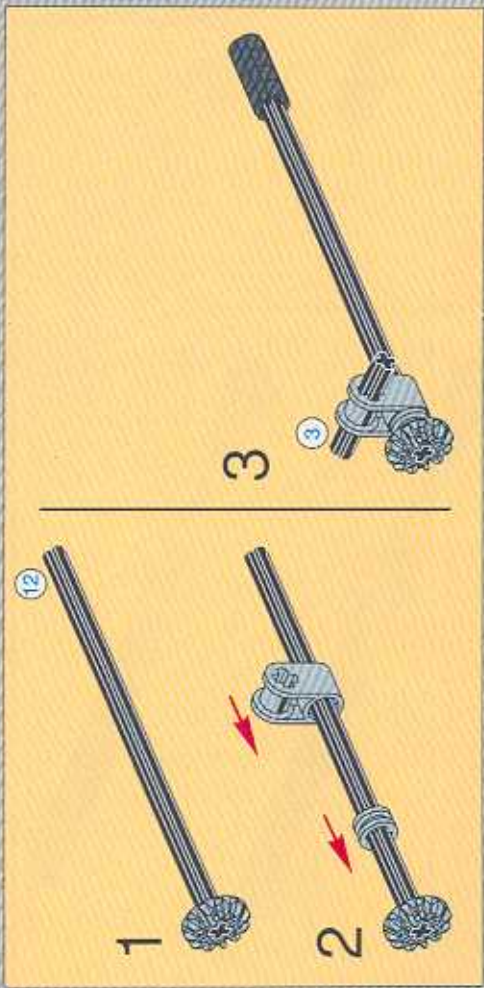



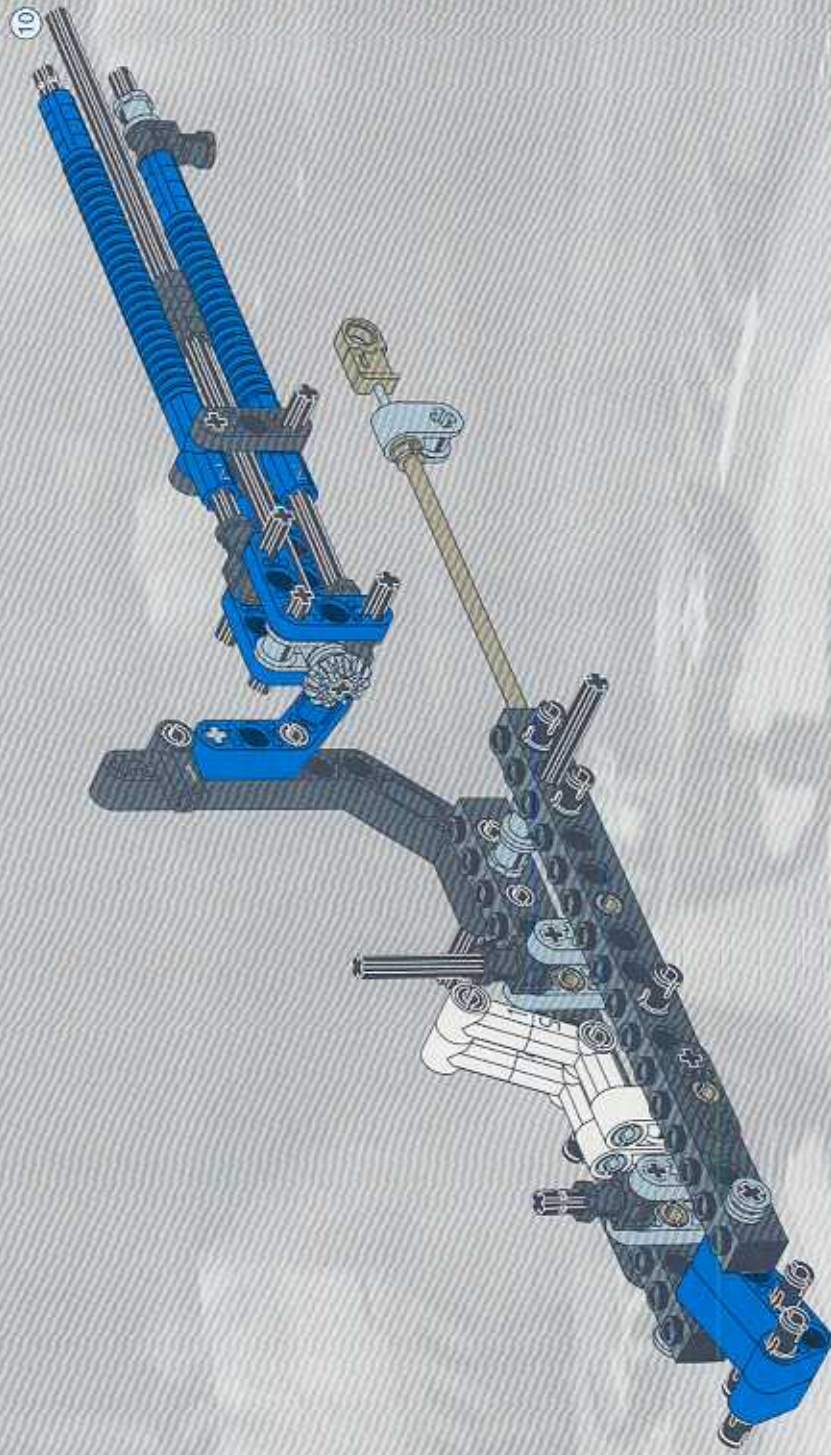
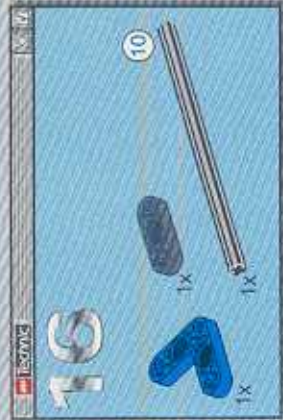

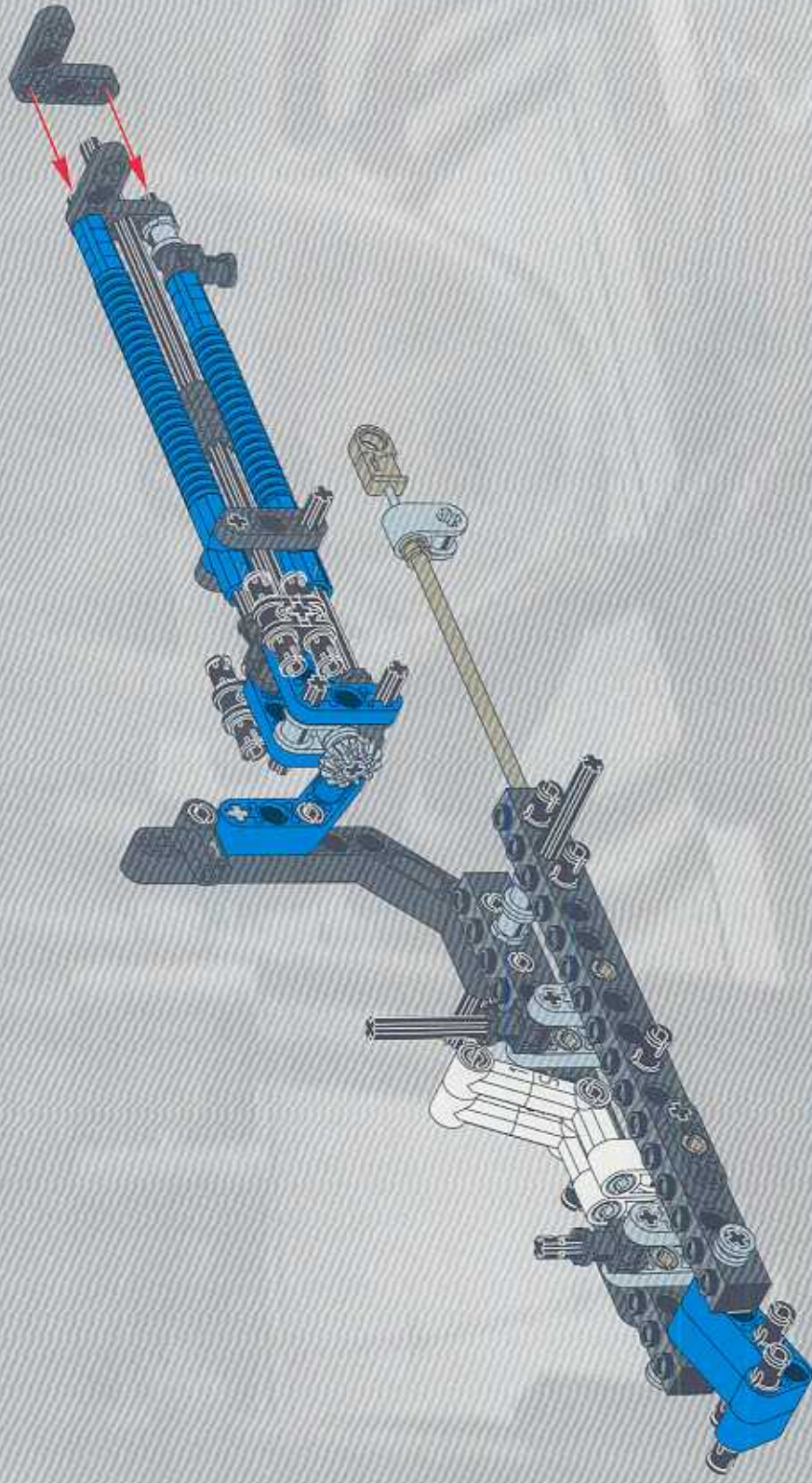

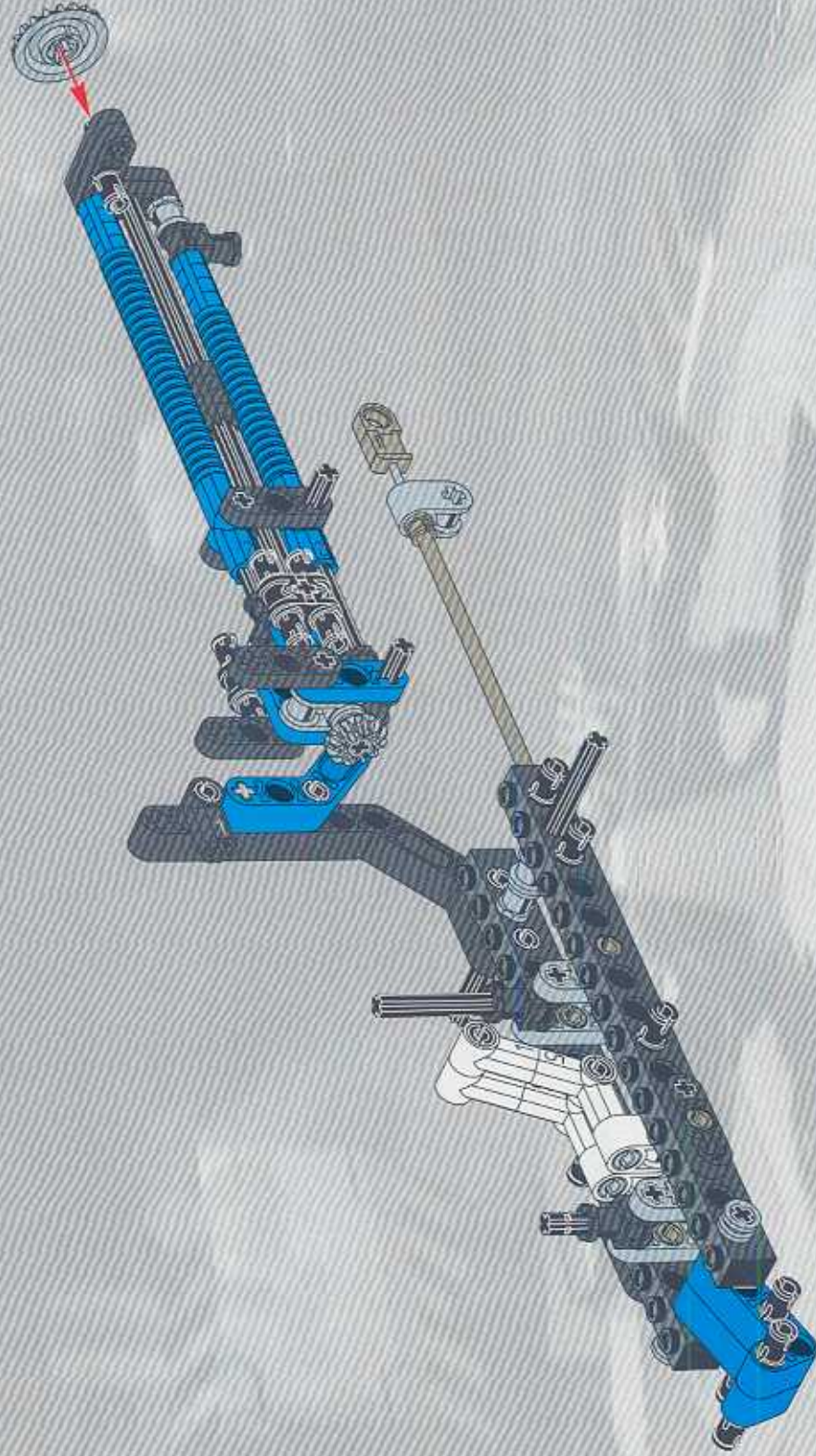

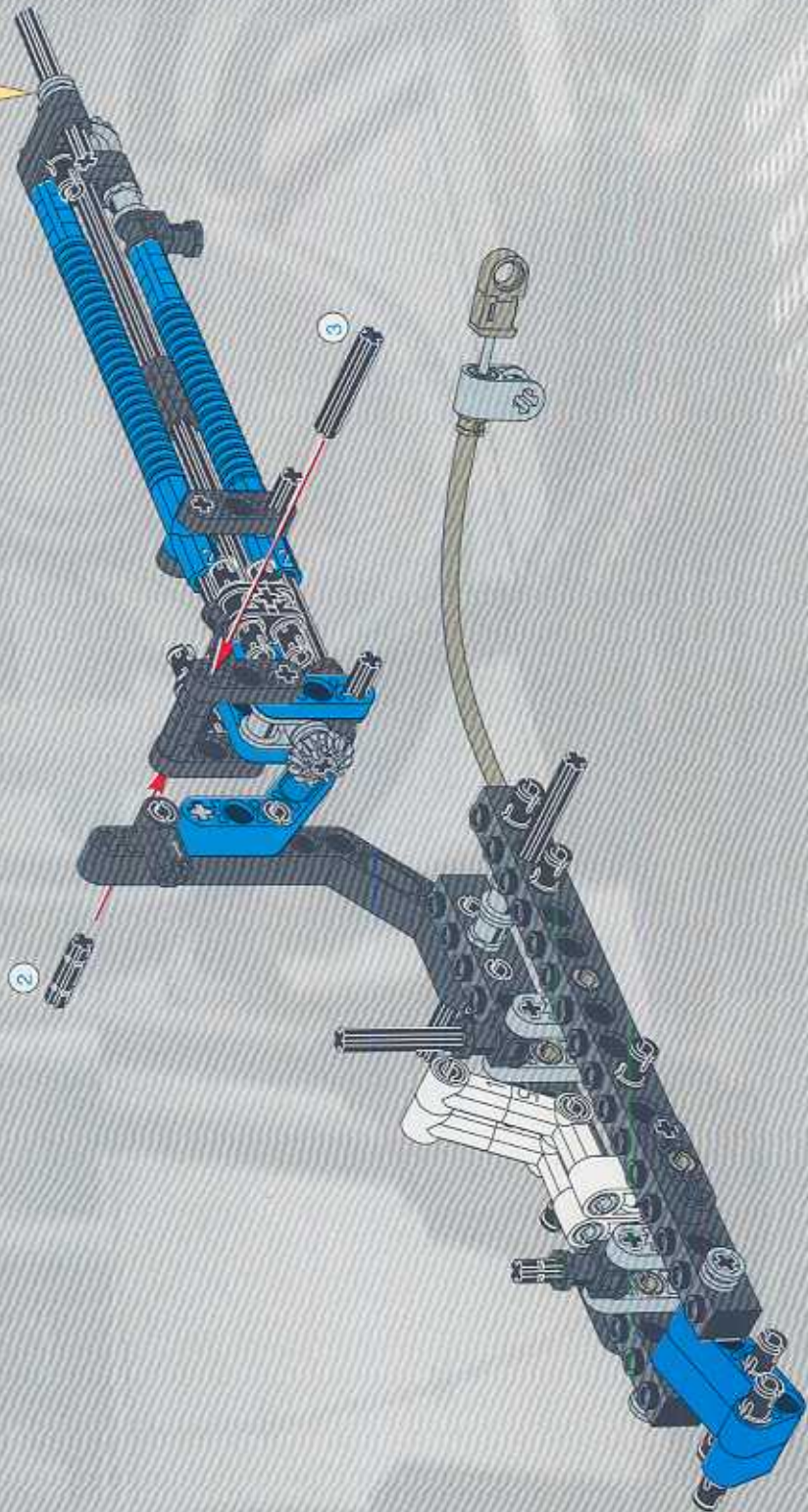
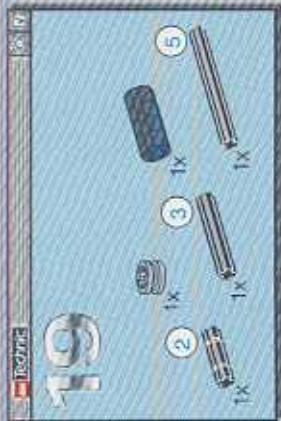

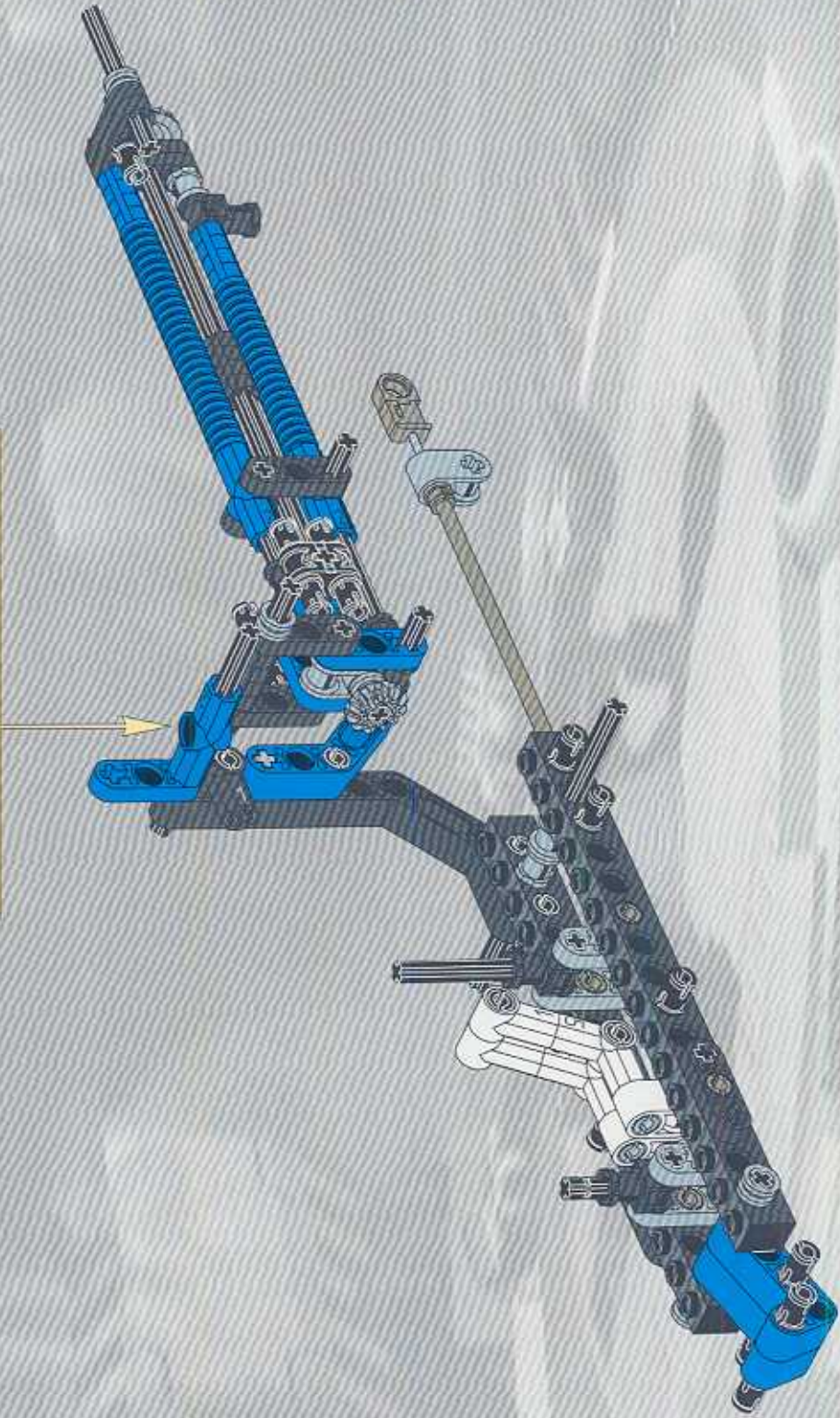
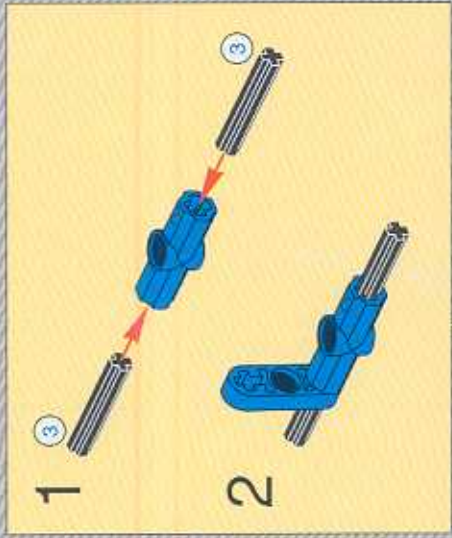

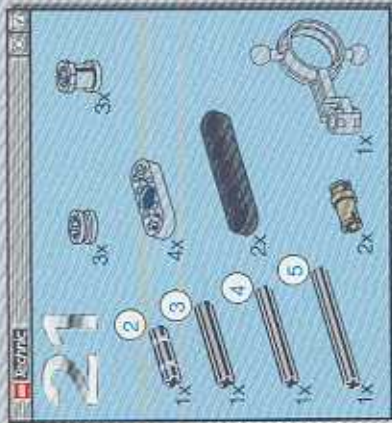

**1**



**2**



**3**



**4**

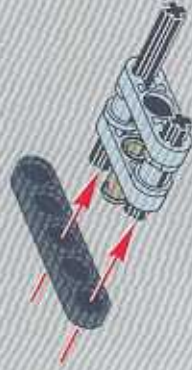

**5**

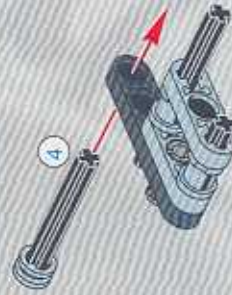

**6**



7



8



9



10



11



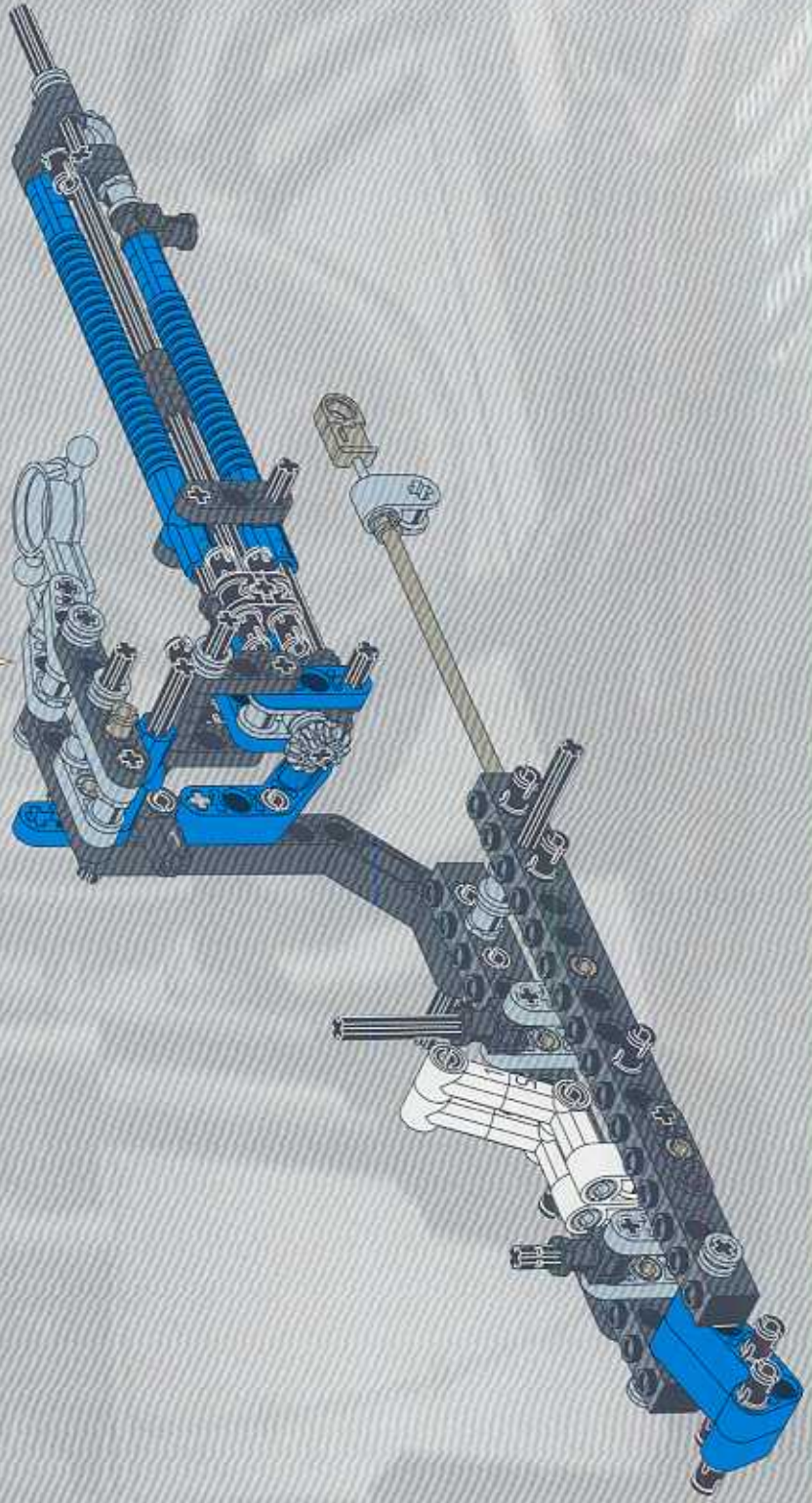



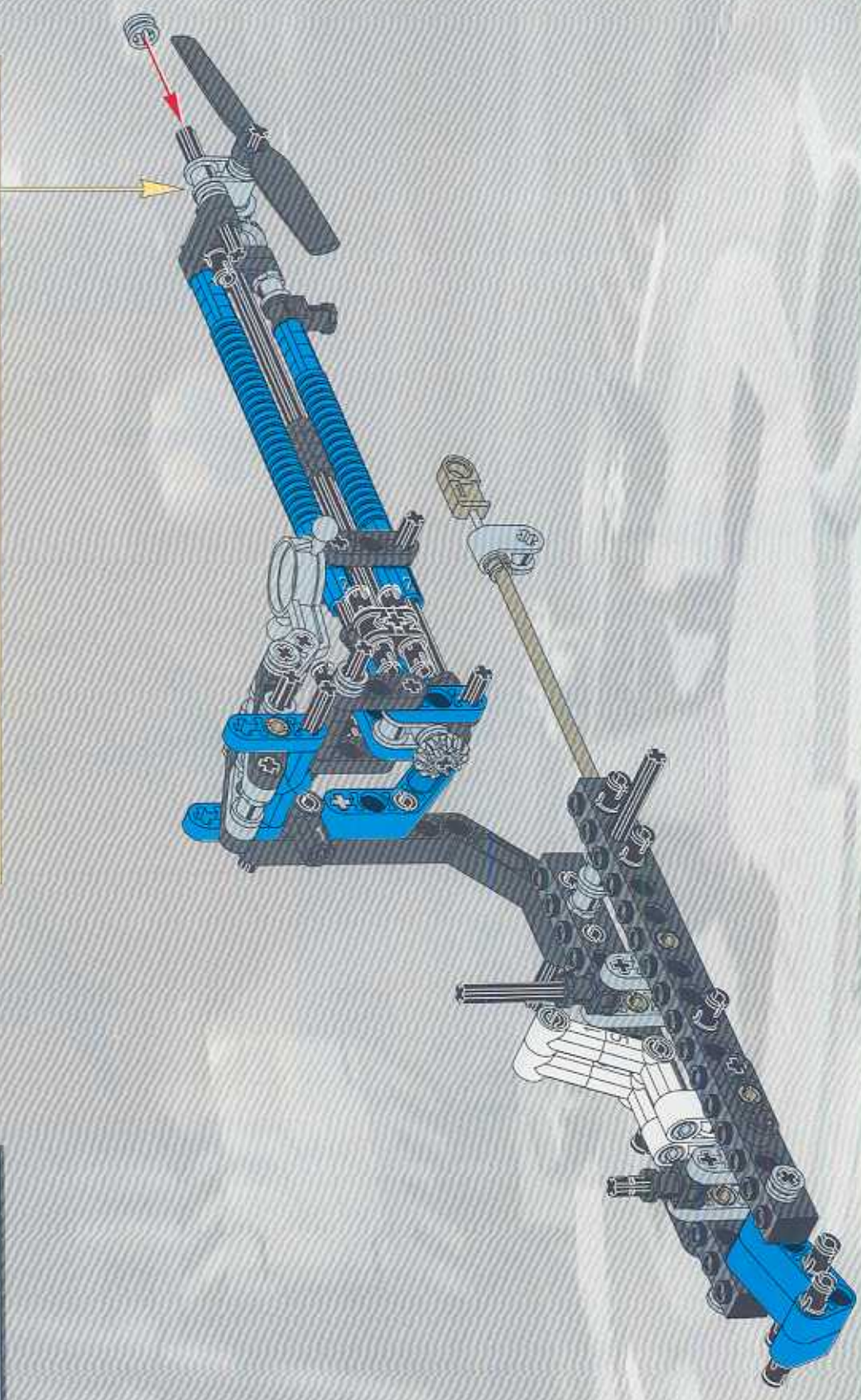
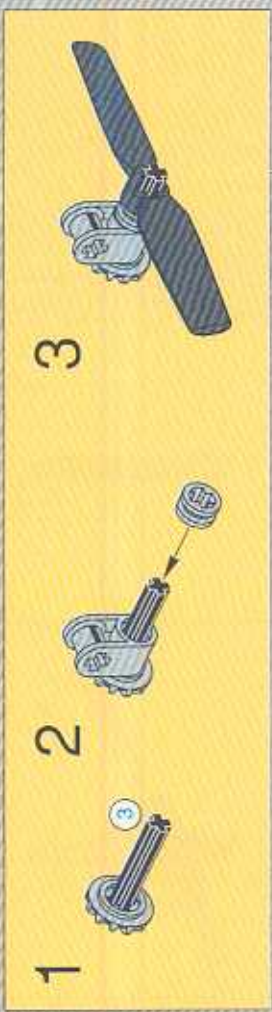

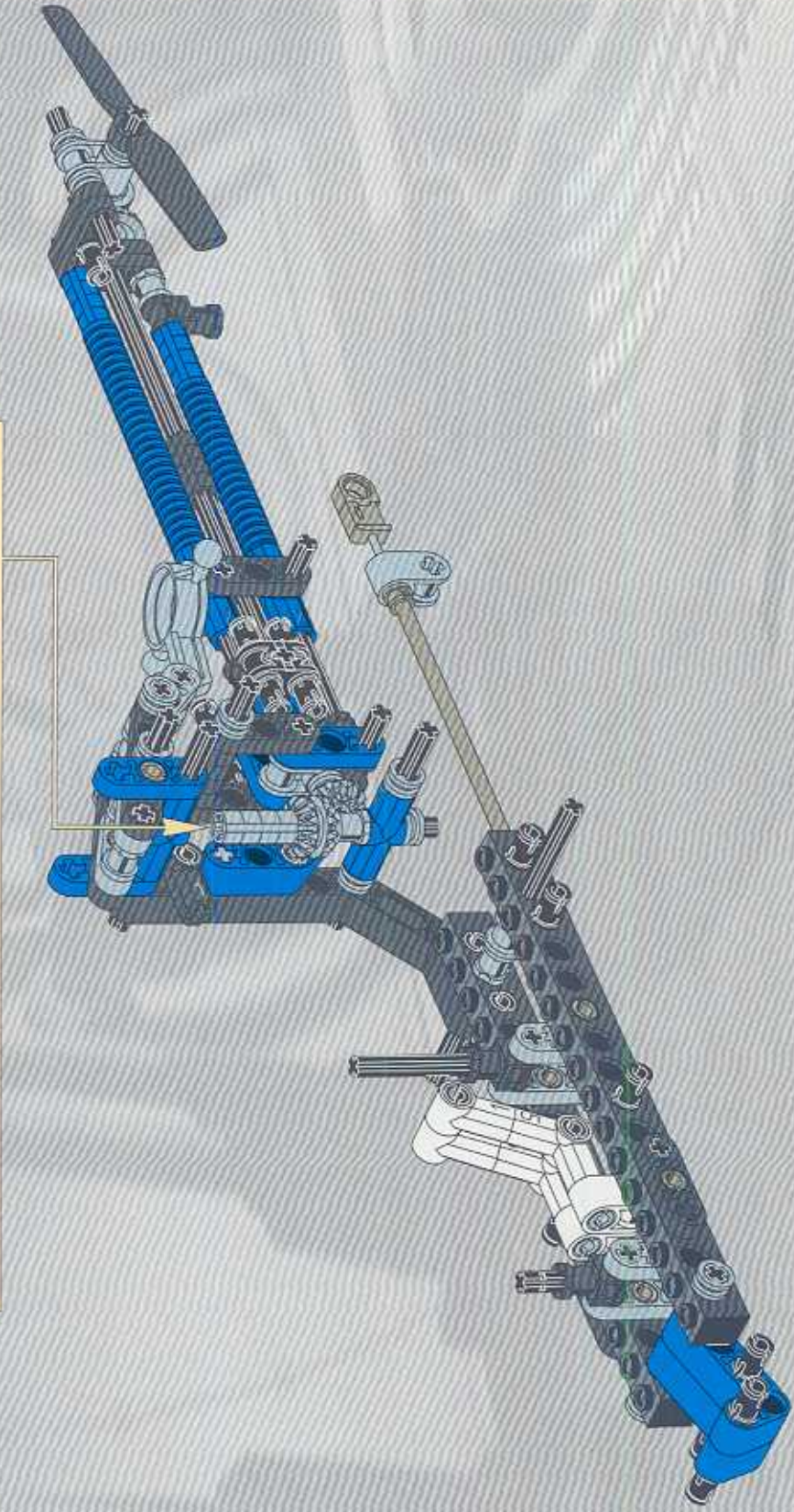
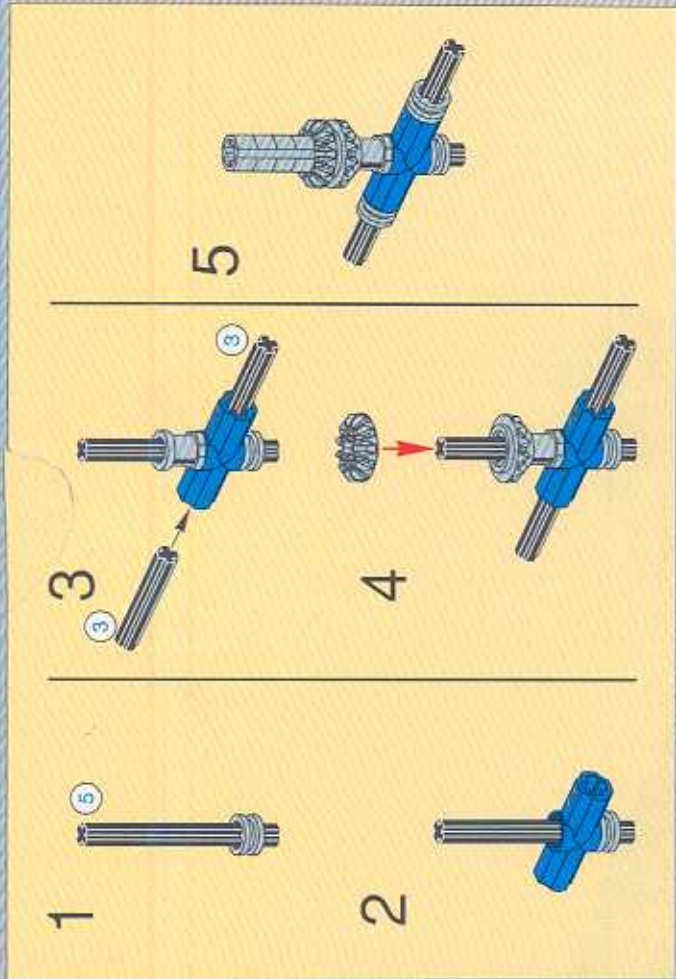

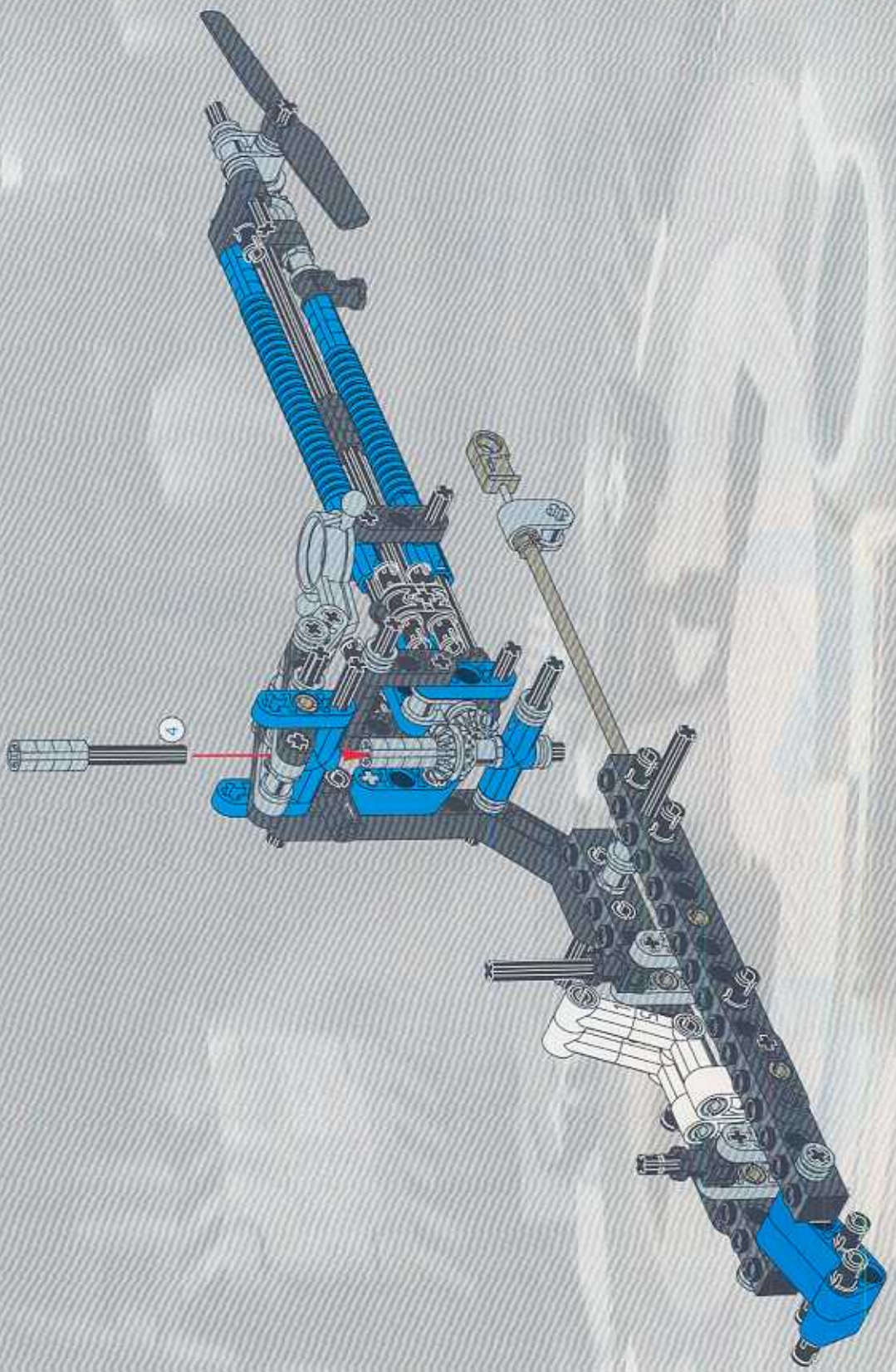

LEGO  
24

1x

1x

1x

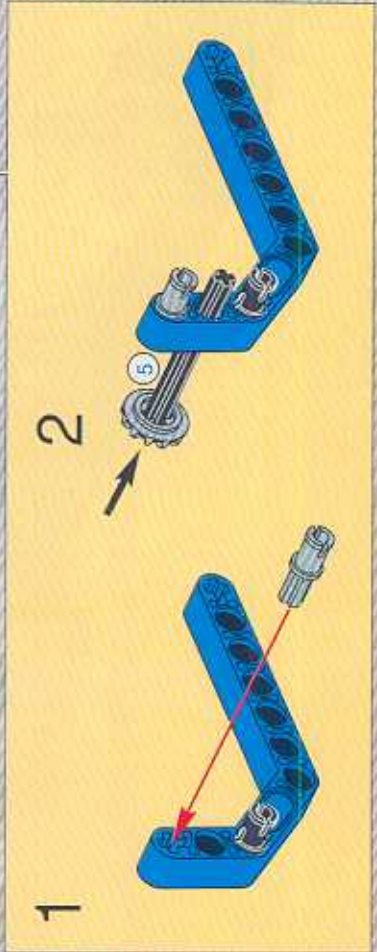
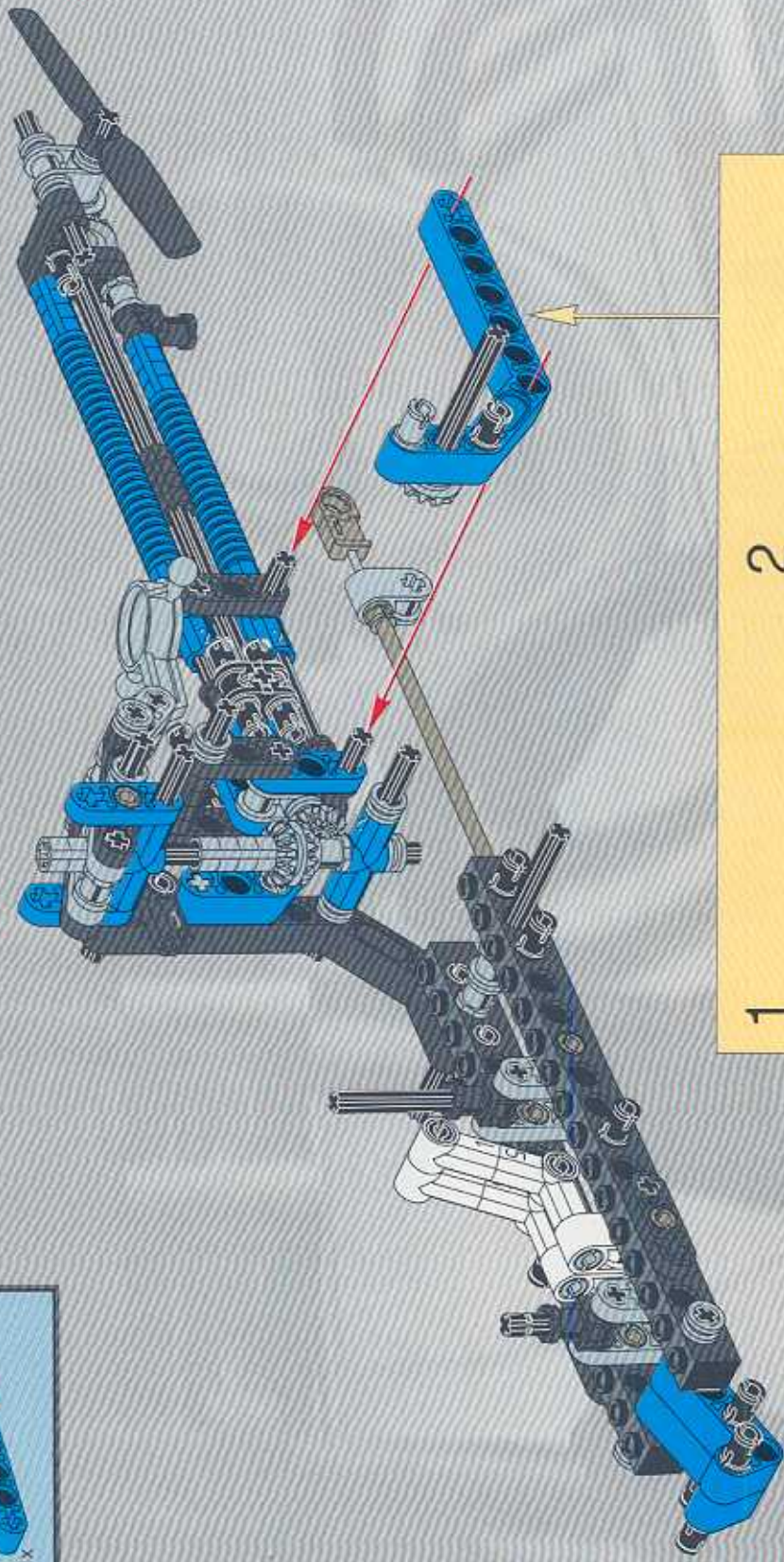

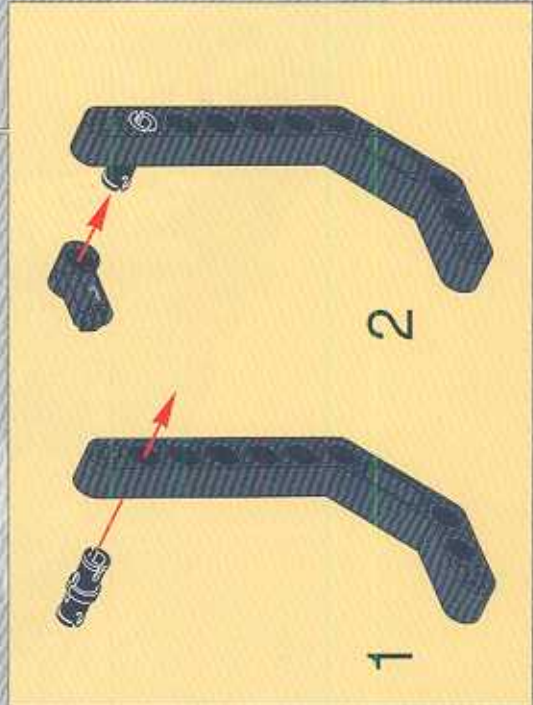
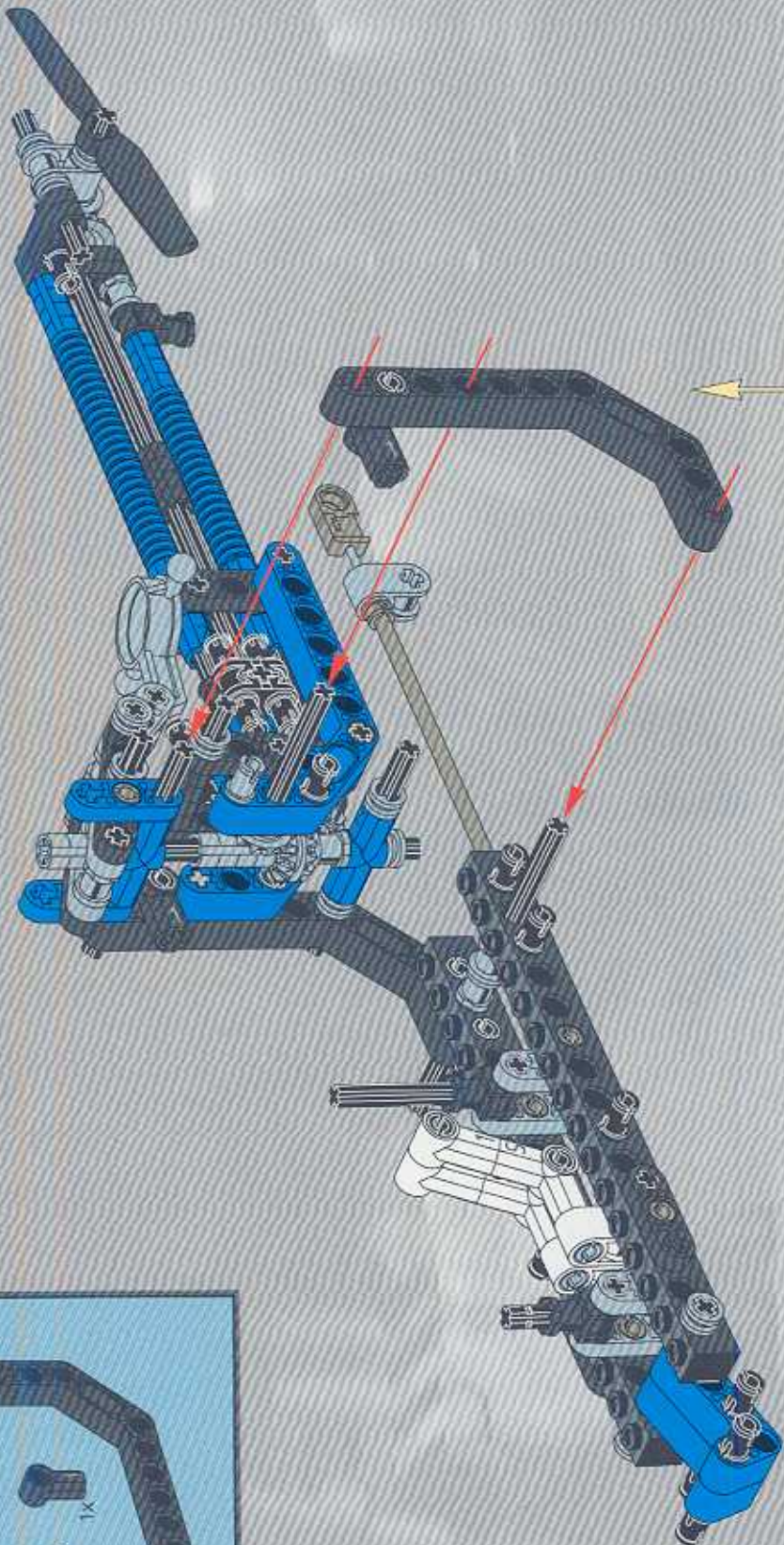

LEGO  
**27**  
 4x  
 2x  
 2x

2x

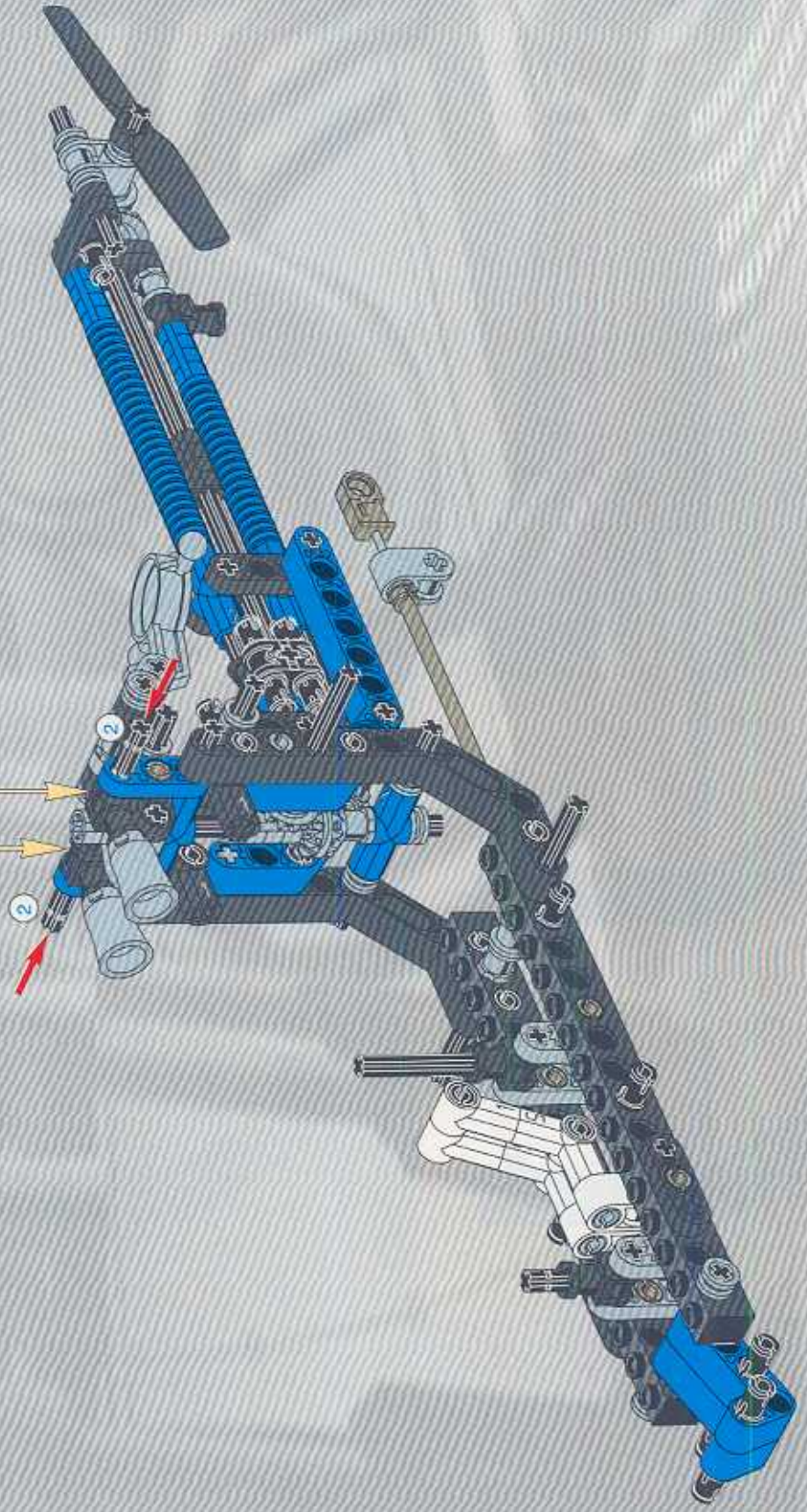

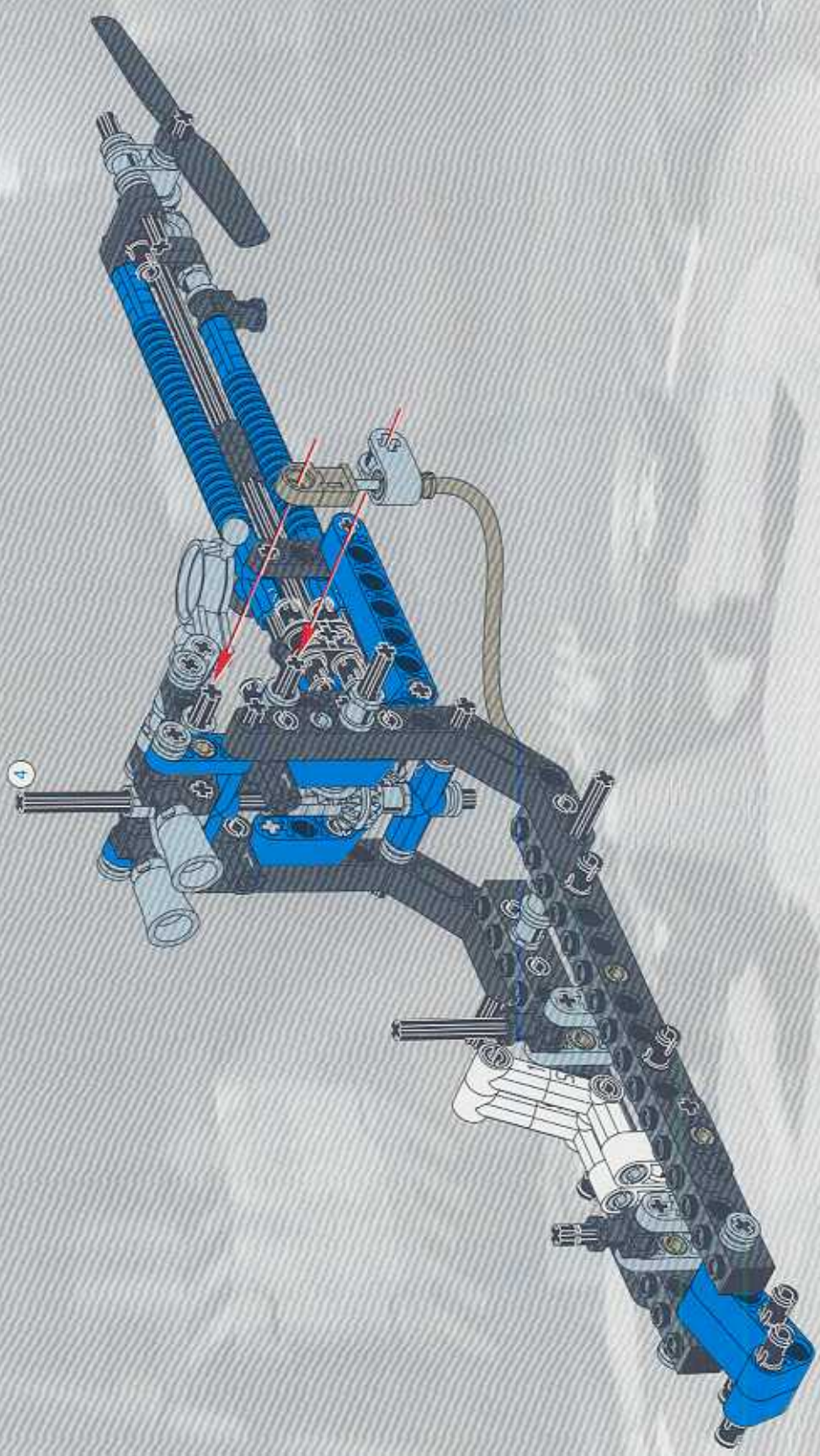

LEGO Technic

28

2x  1x  1x 

4

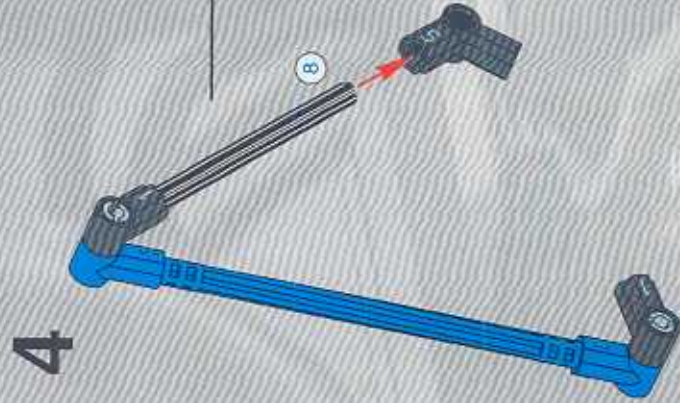
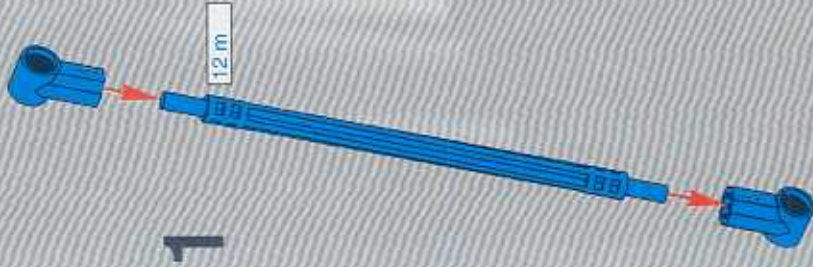
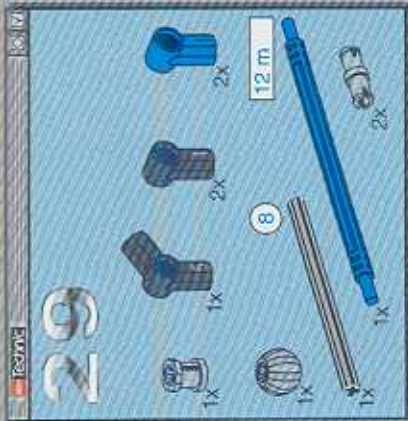



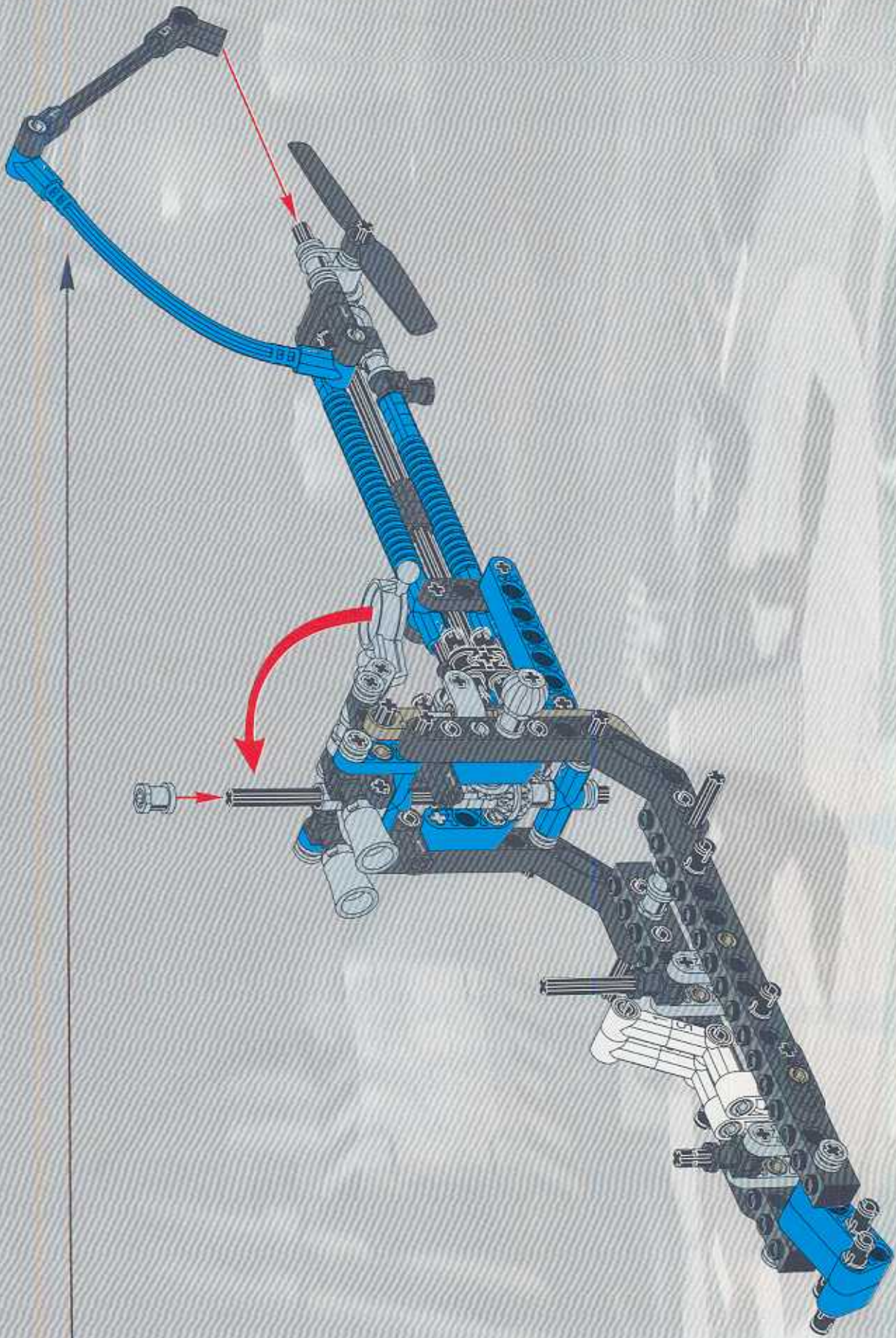

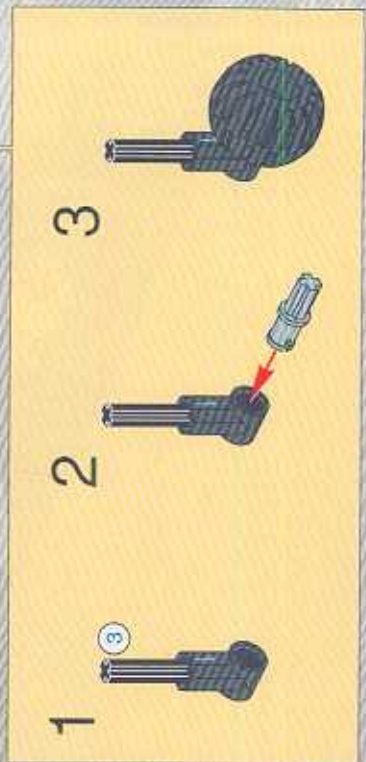
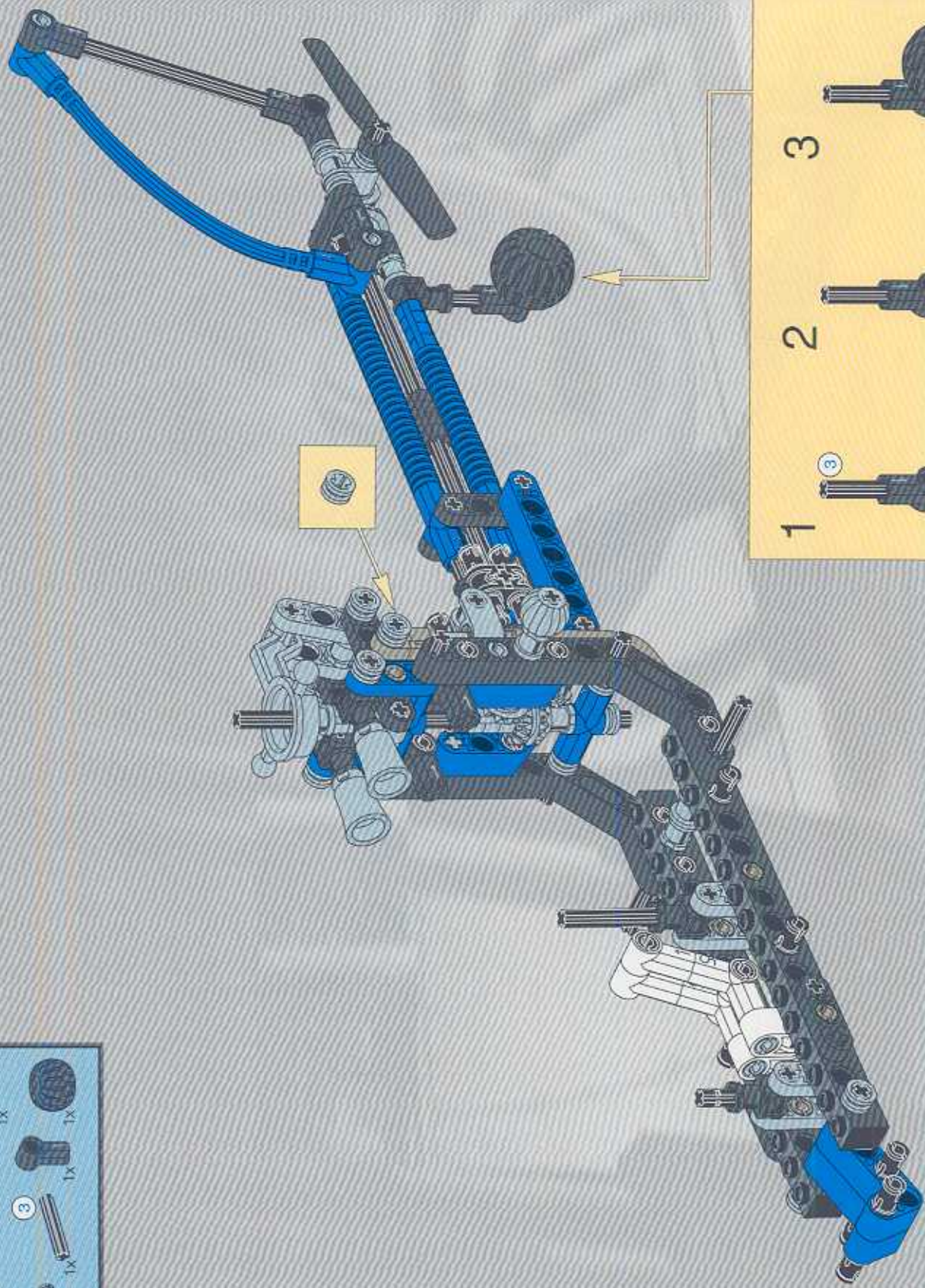
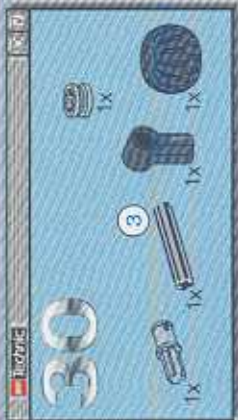

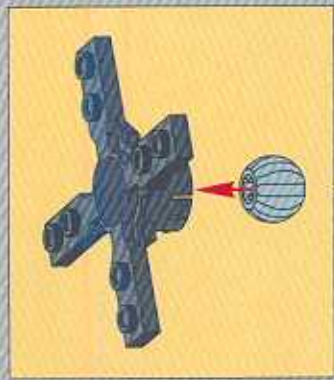
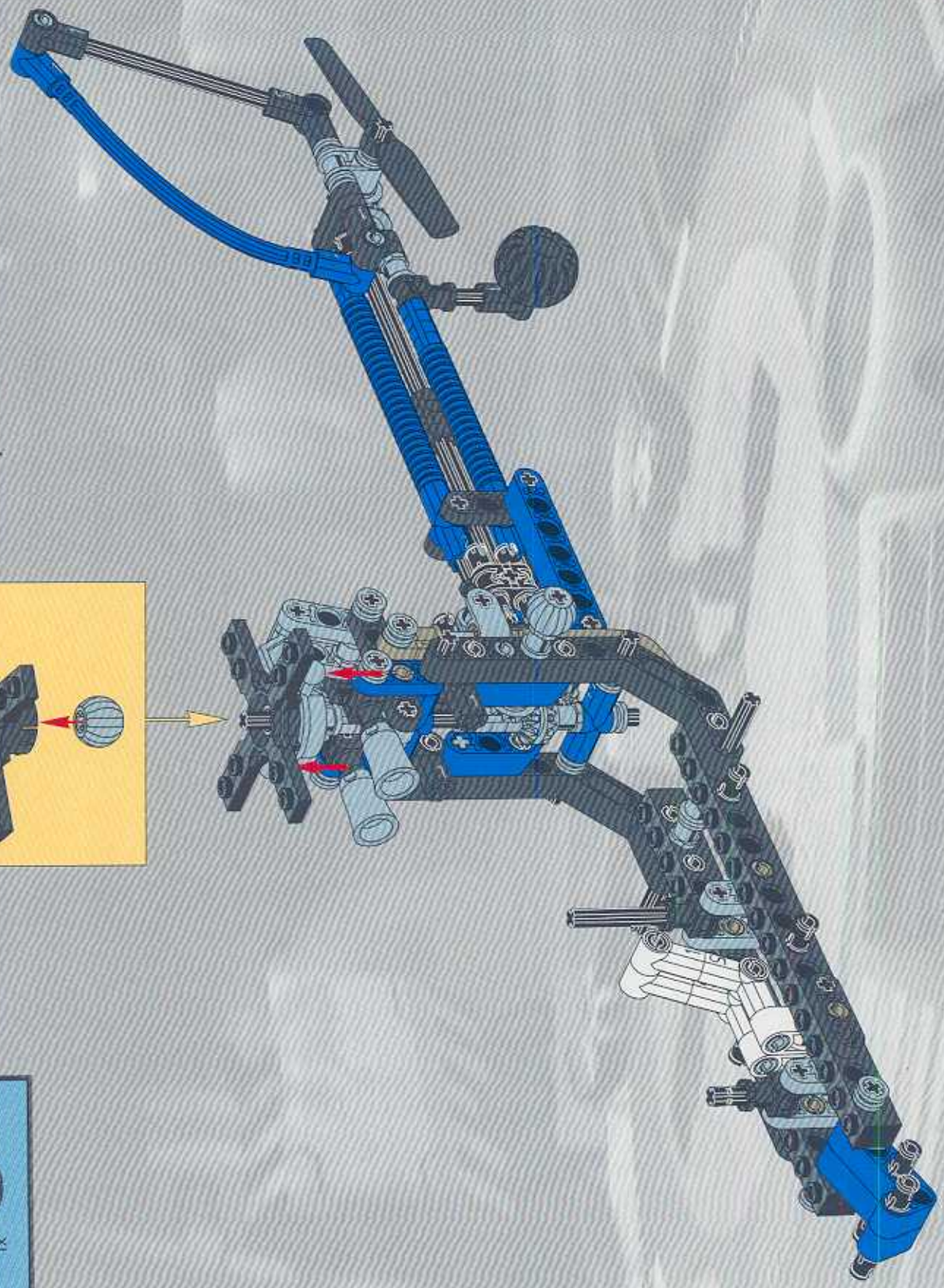

LEGO Technic

31

1x

1x

1x

A blue rectangular box containing the parts list for step 31. It features the LEGO Technic logo at the top left, the step number '31' in large white font, and two items: a grey Technic ball joint and a black Technic axle, each with a '1x' quantity. The background of the box is blue with a subtle pattern.

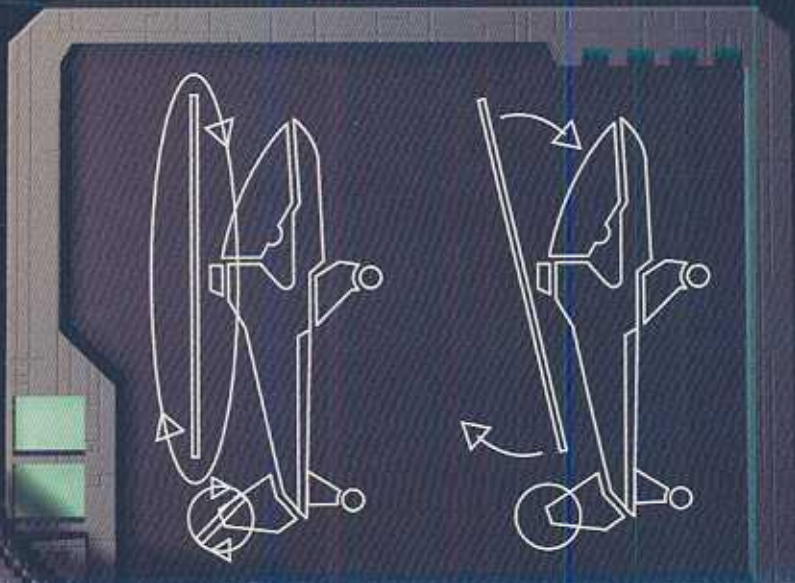



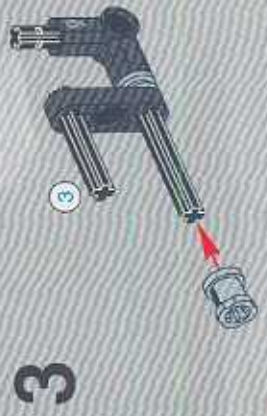
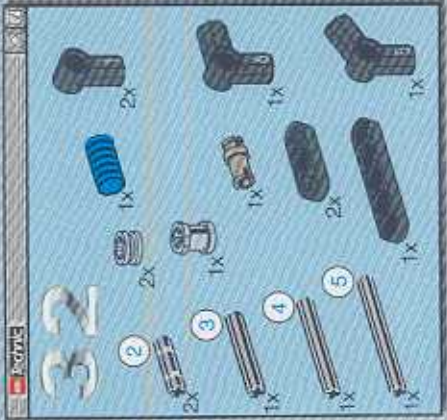
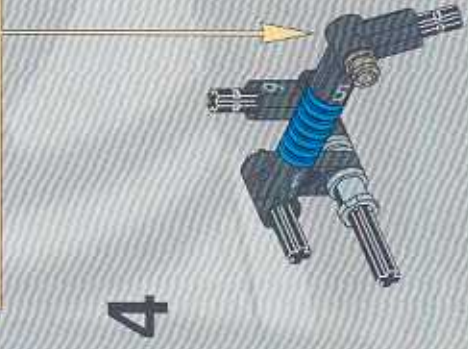
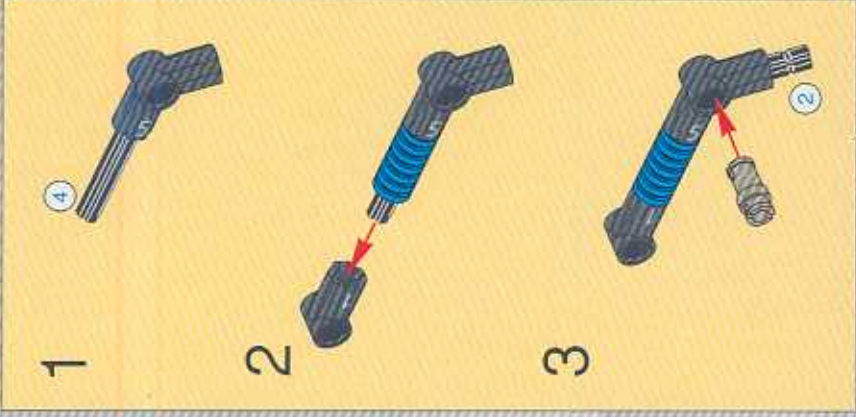
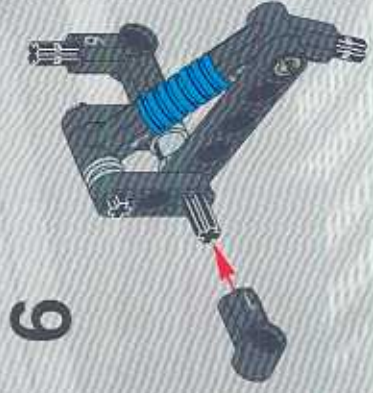

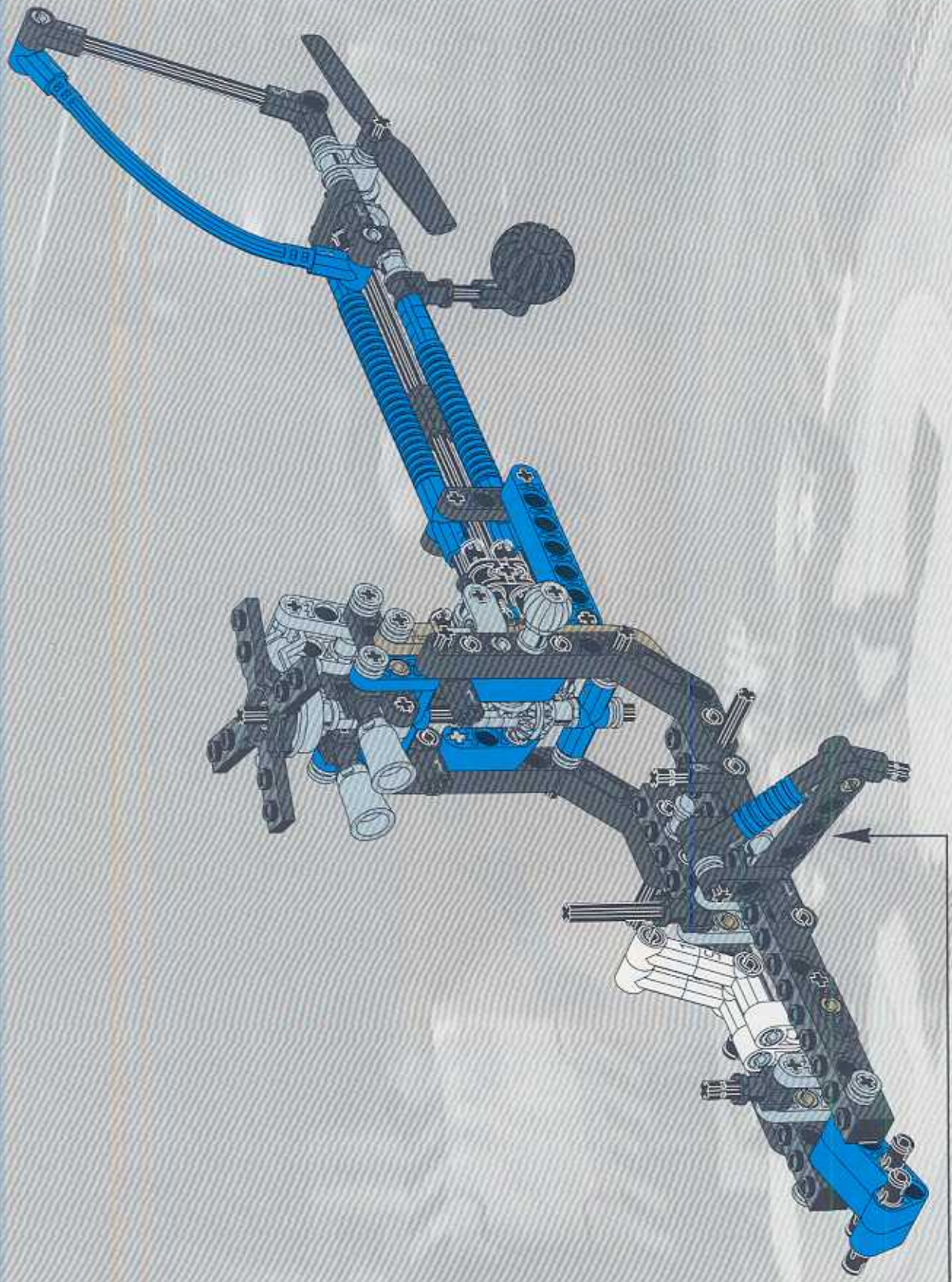

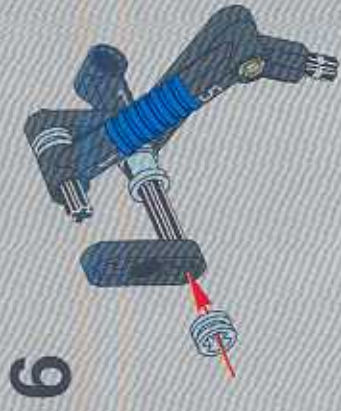
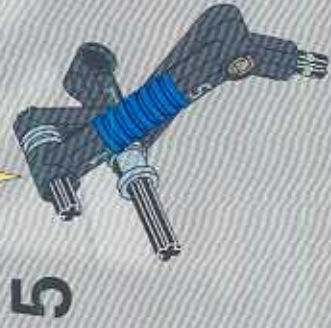
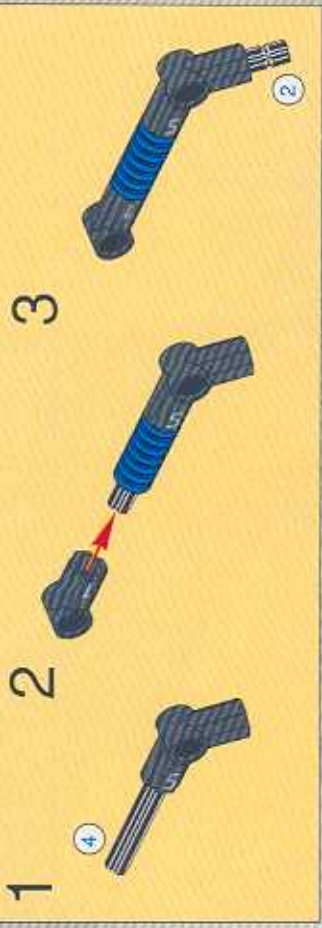
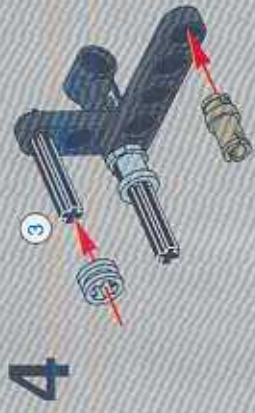
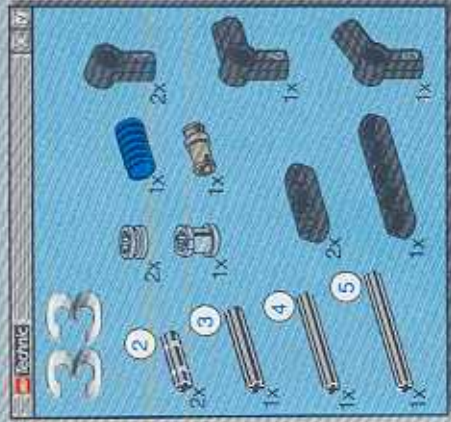



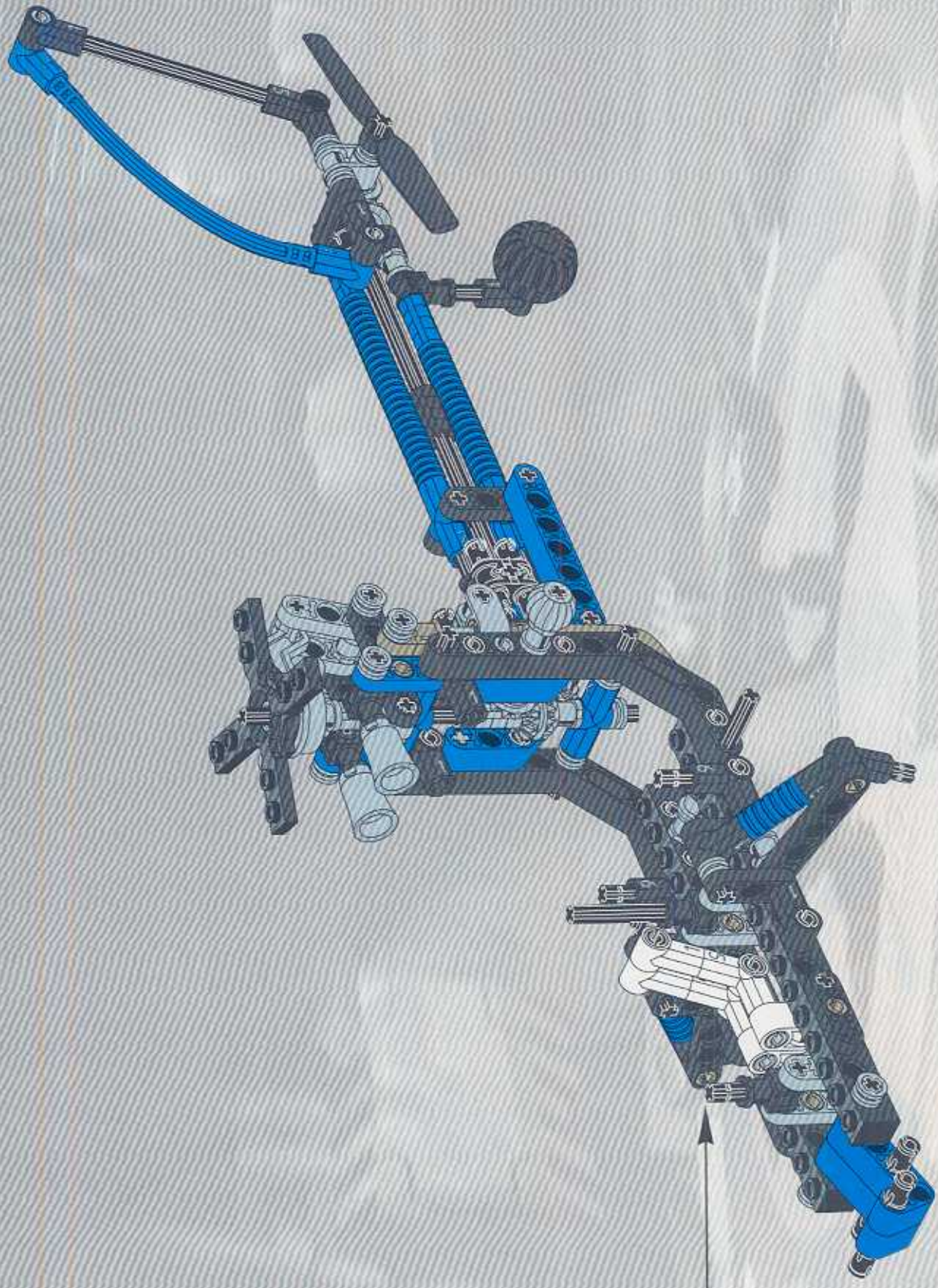

LEGO Technic

34

2x  2x  2x 

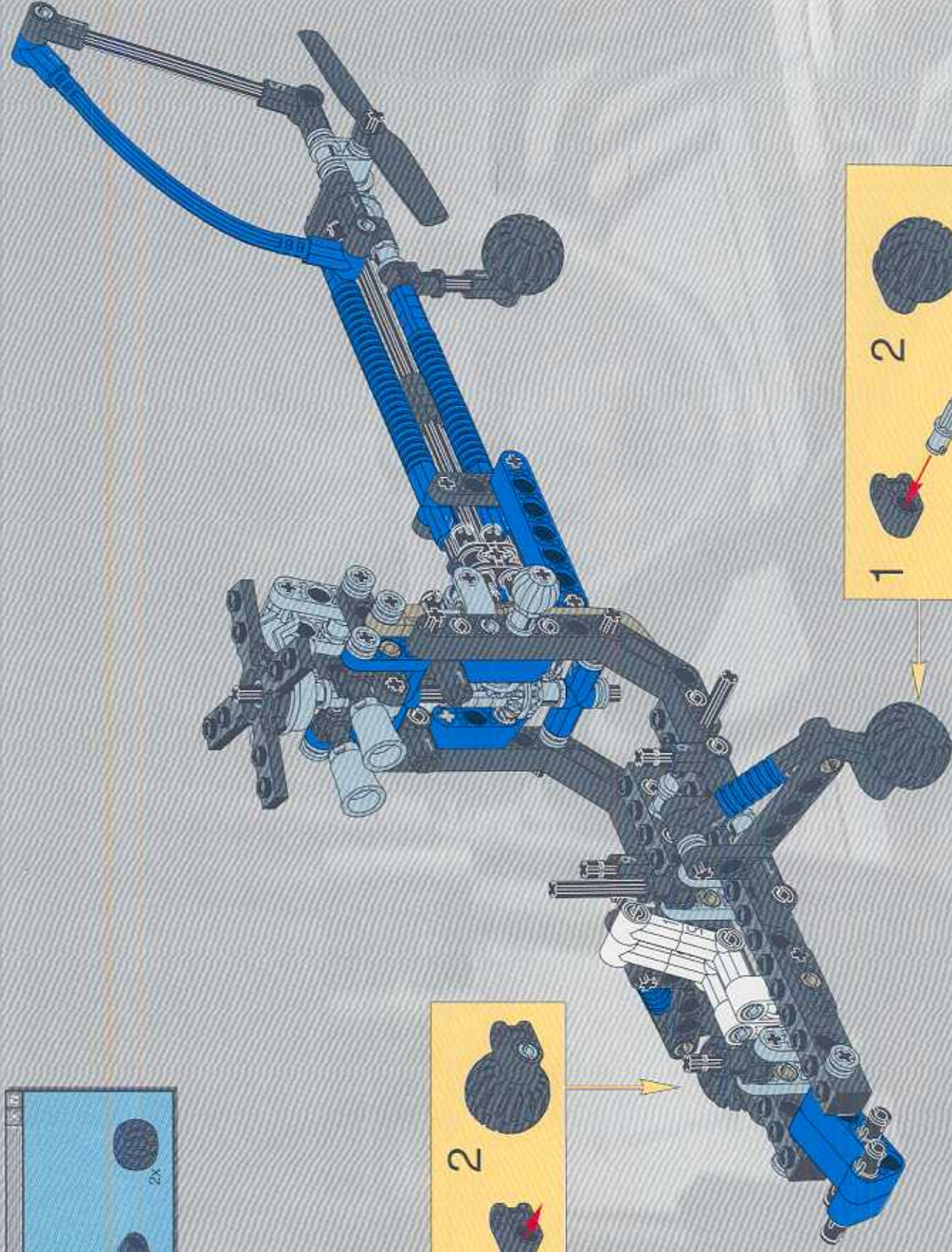

1  2 

→

1   2 

→

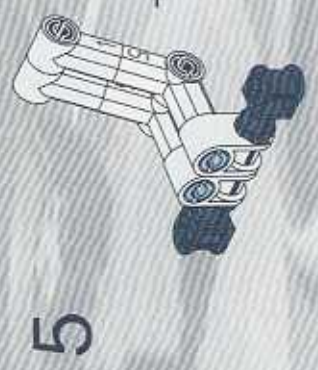
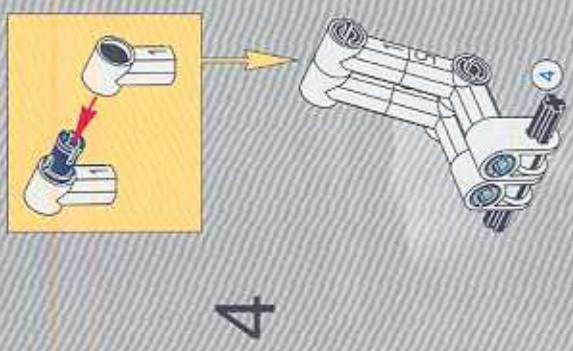
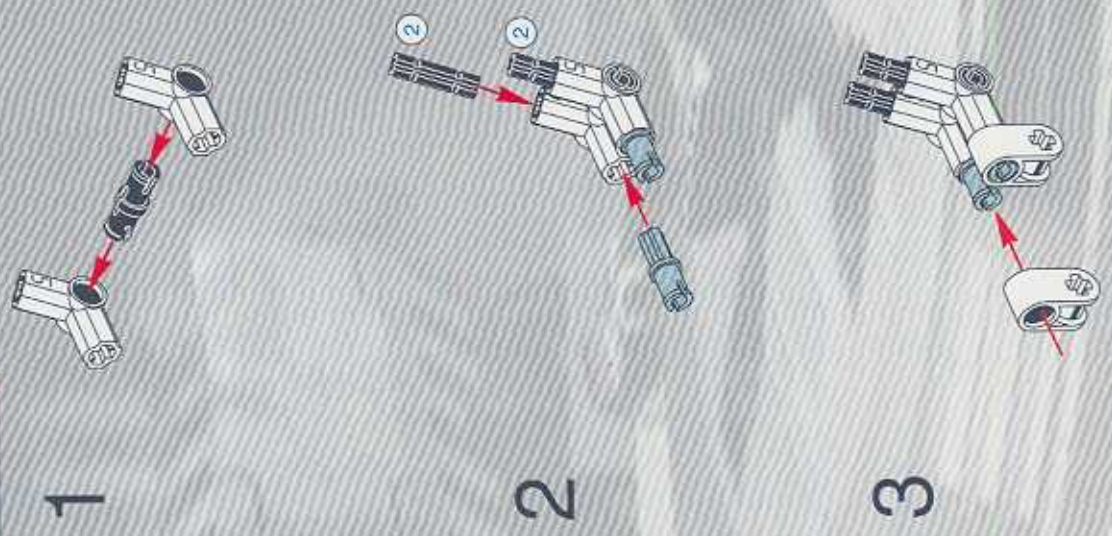
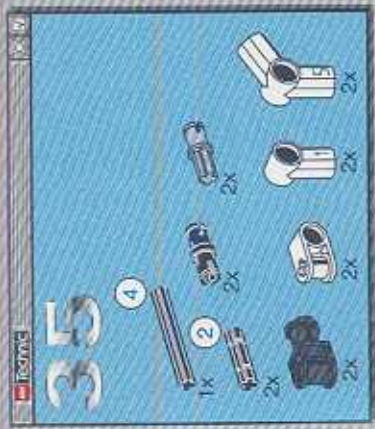

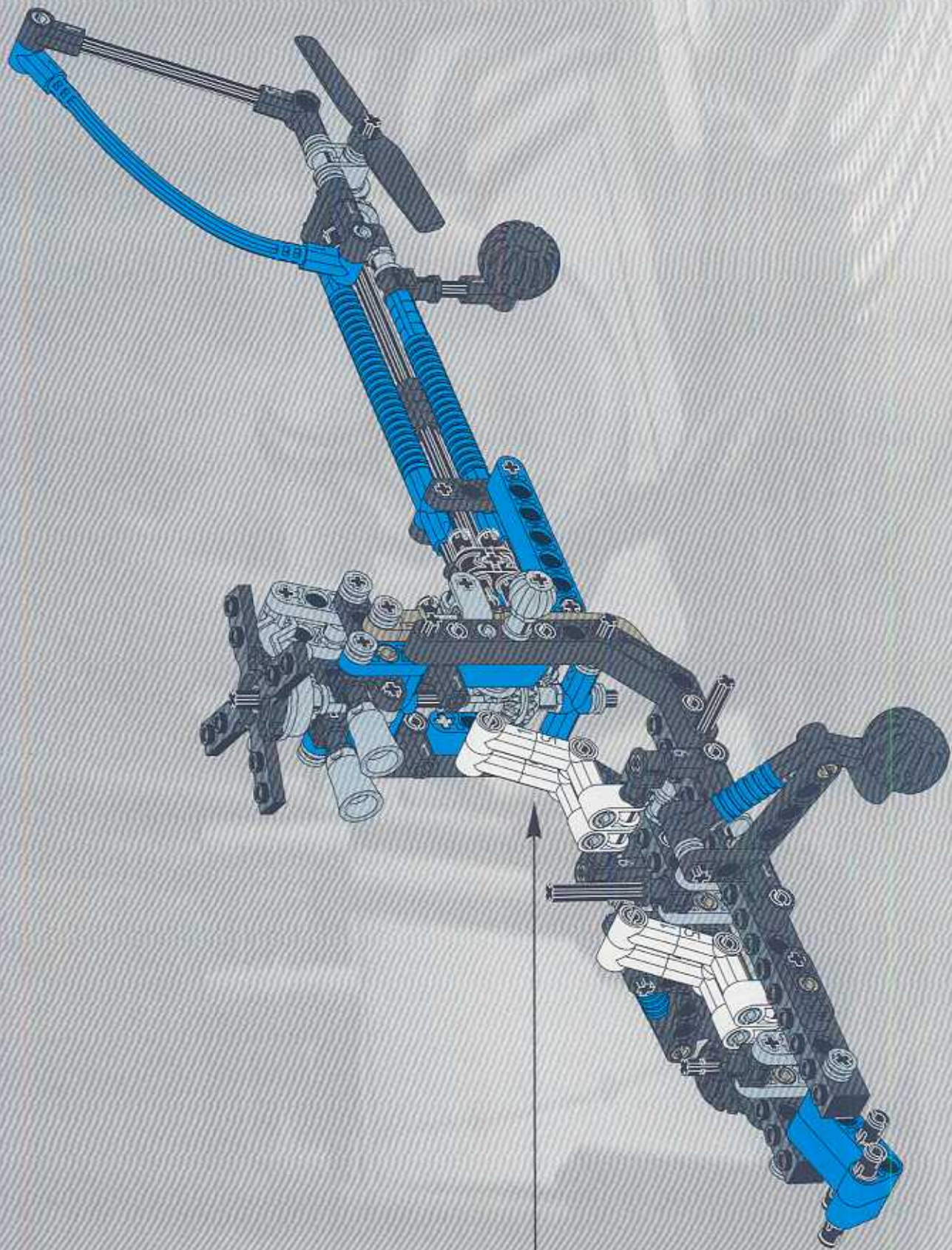

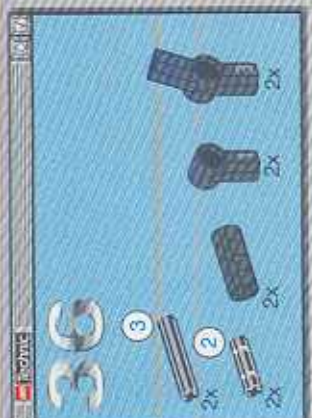
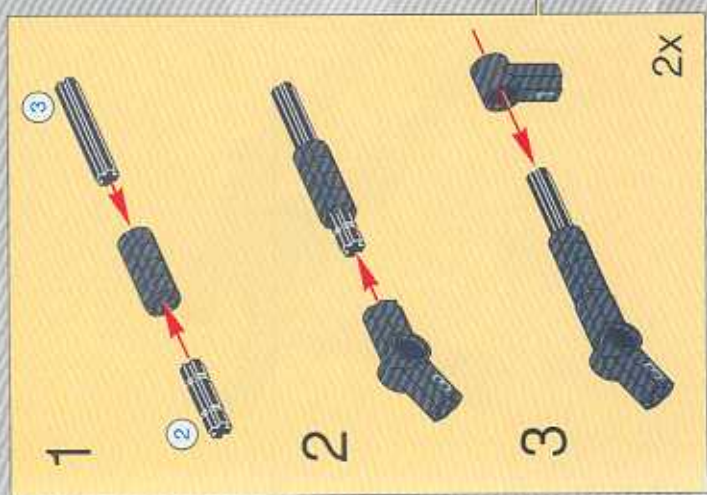
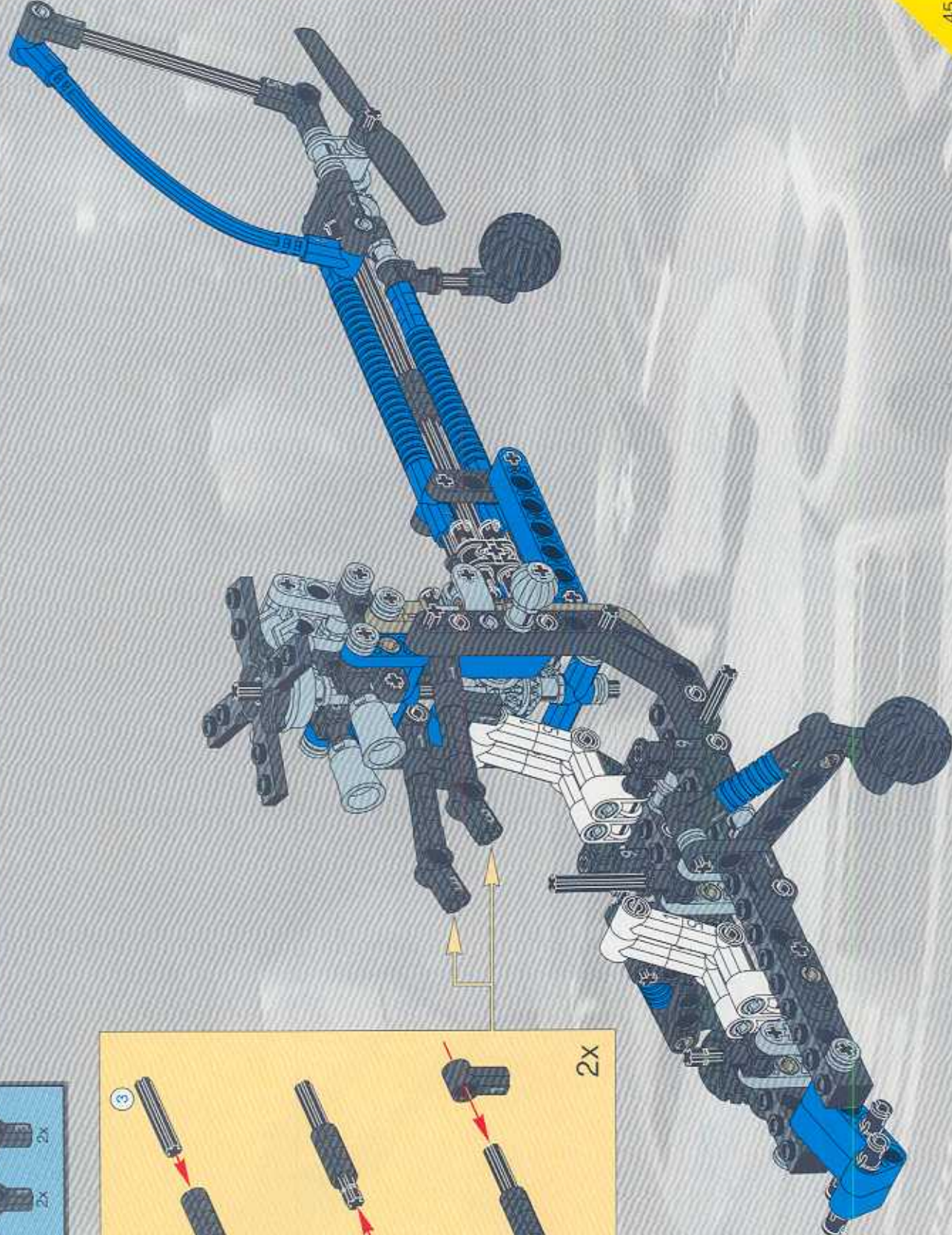

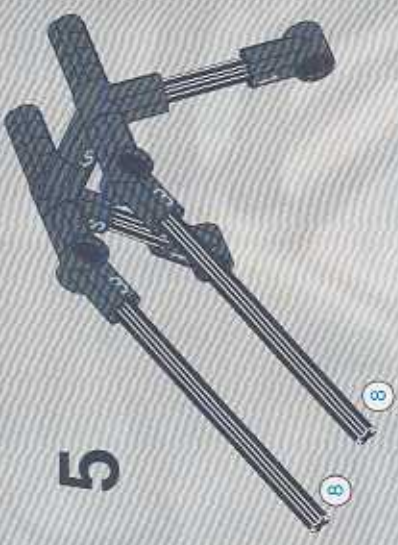
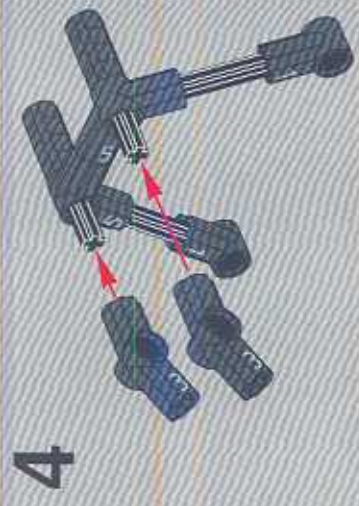
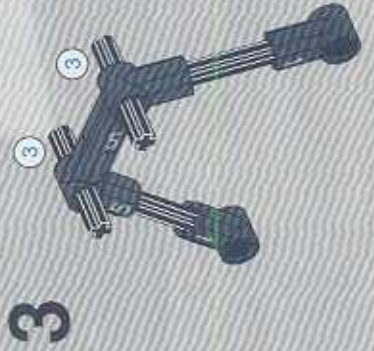
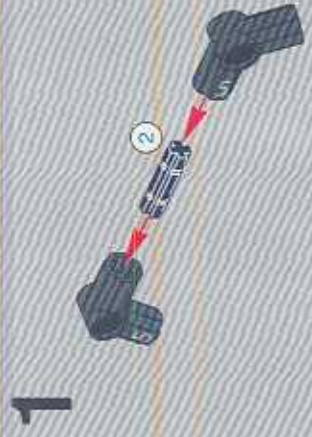
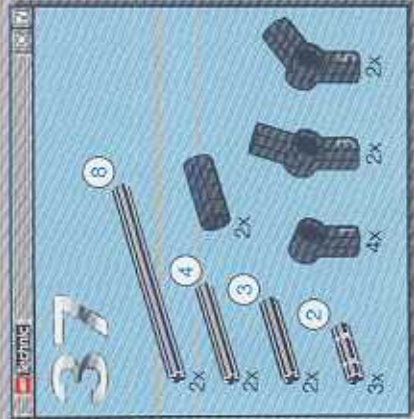

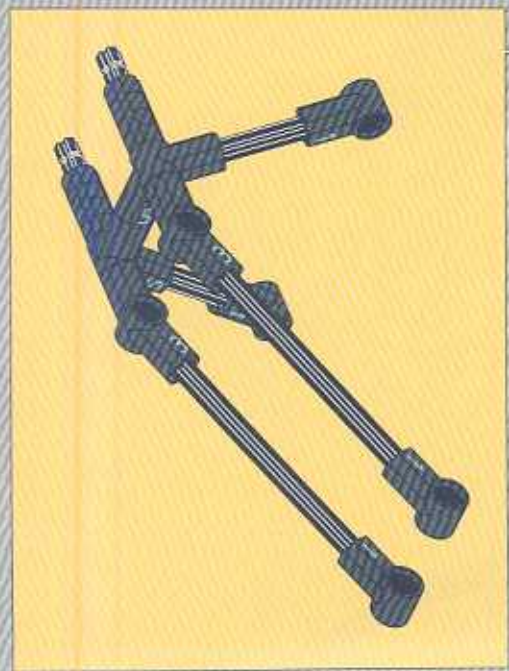
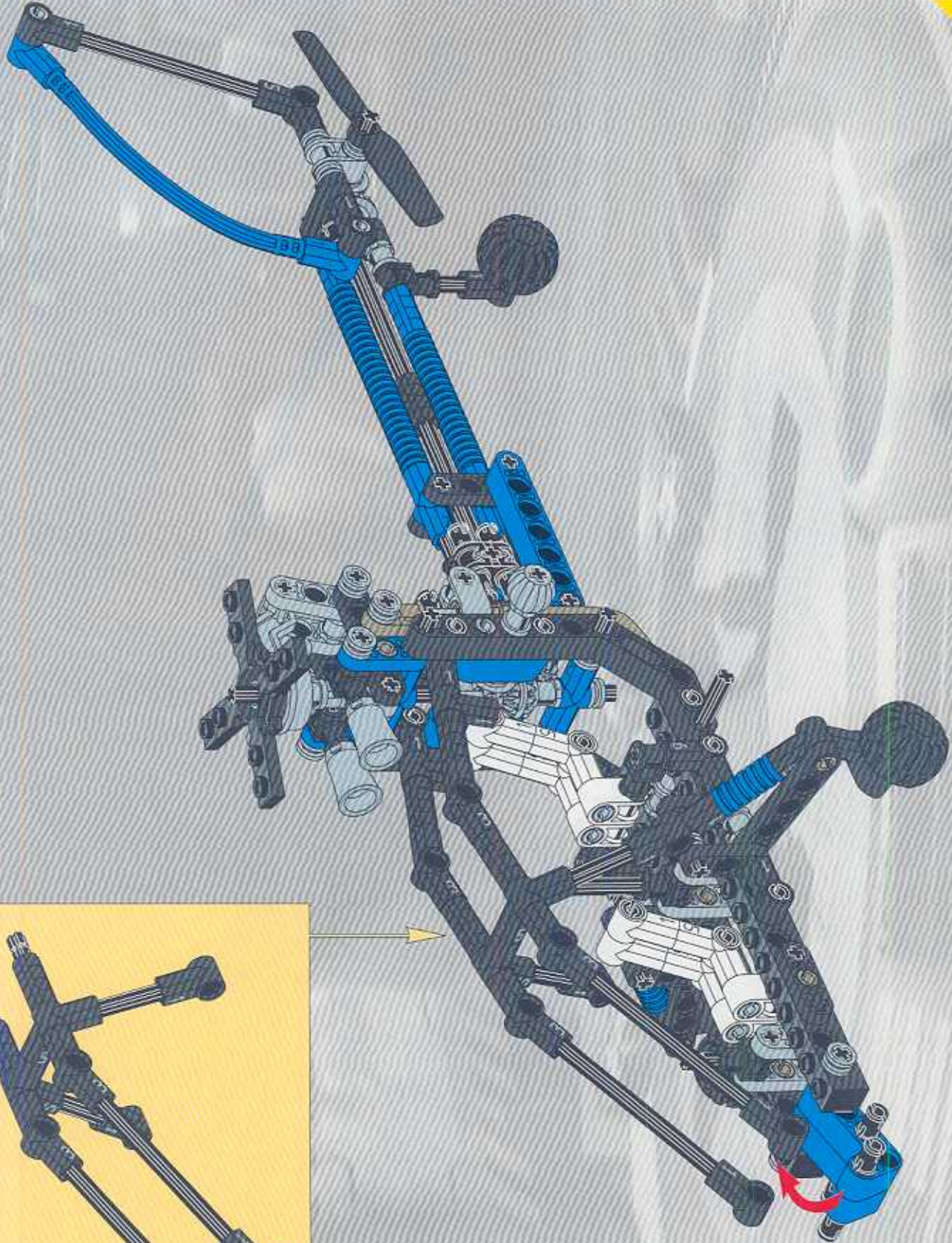

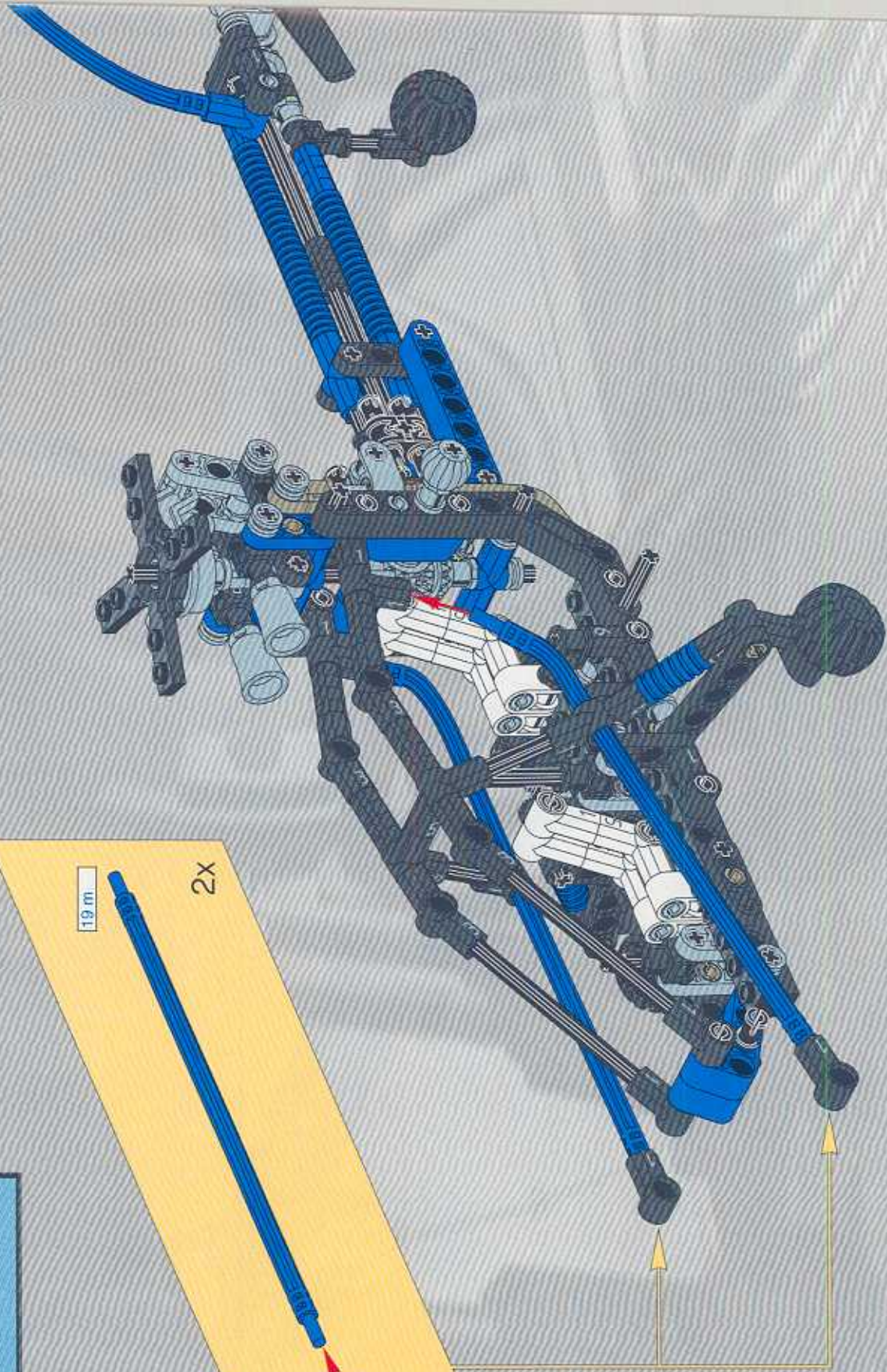
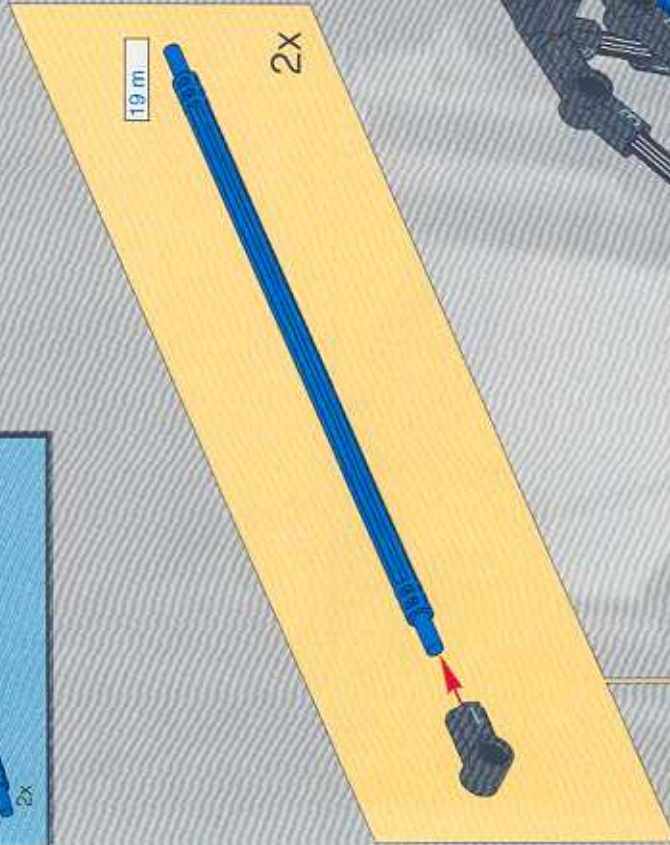
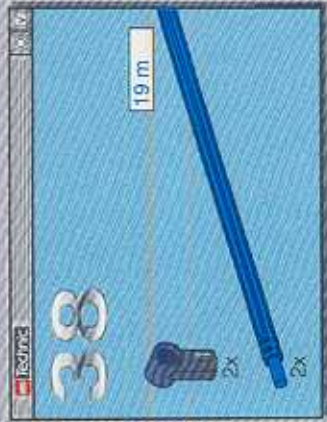



1

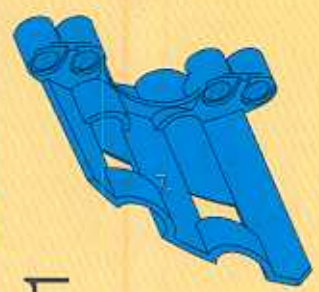

2

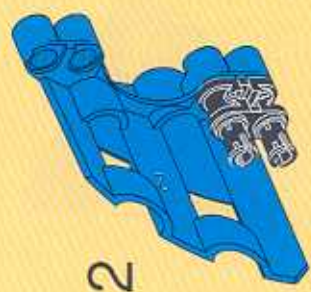

3

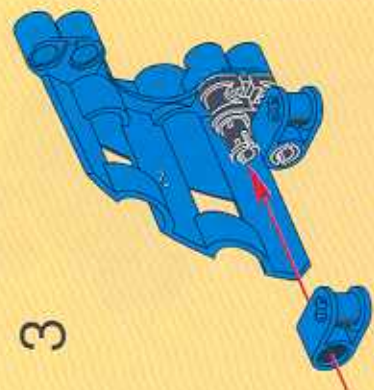

4

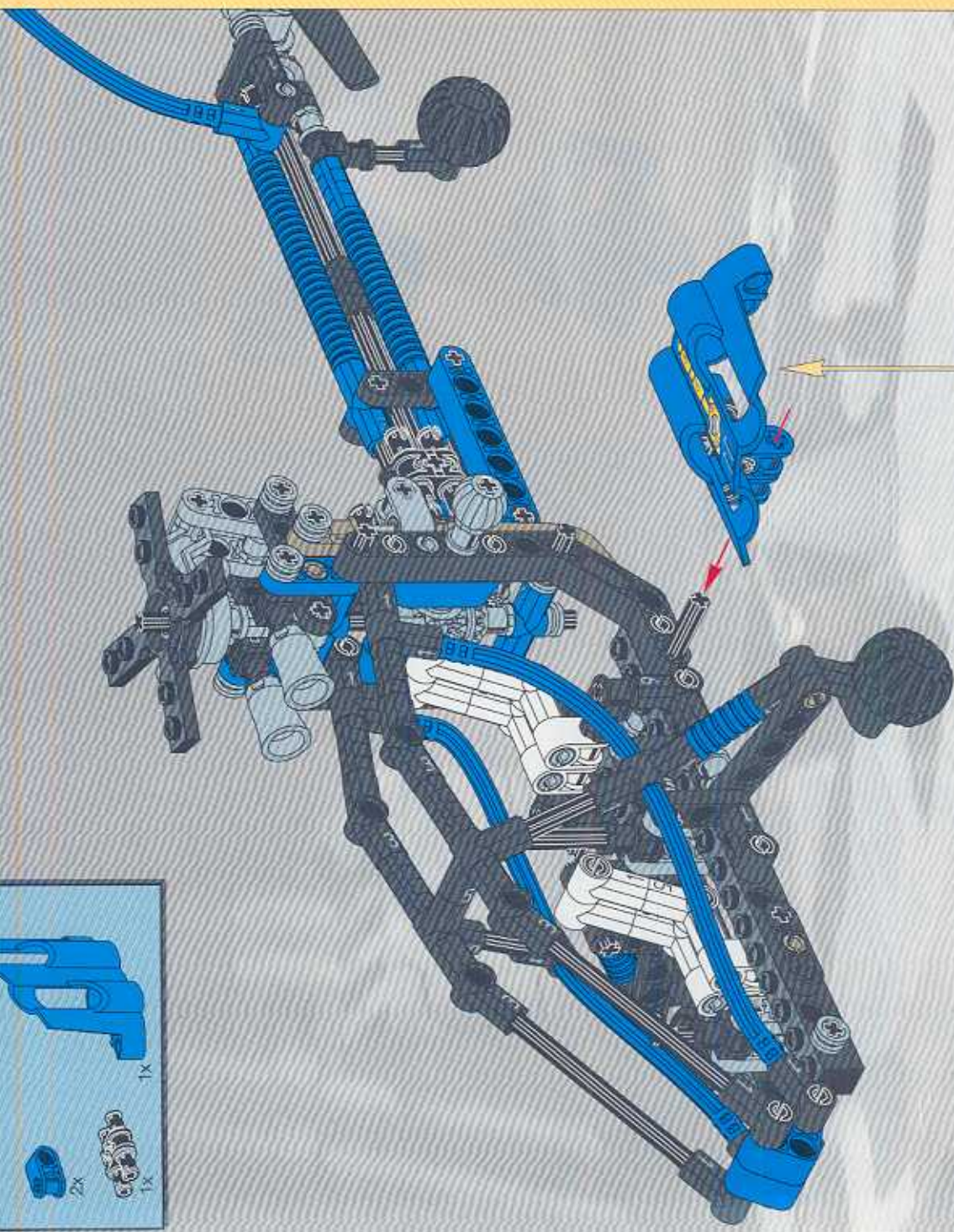

39

1x

2x

1x

2

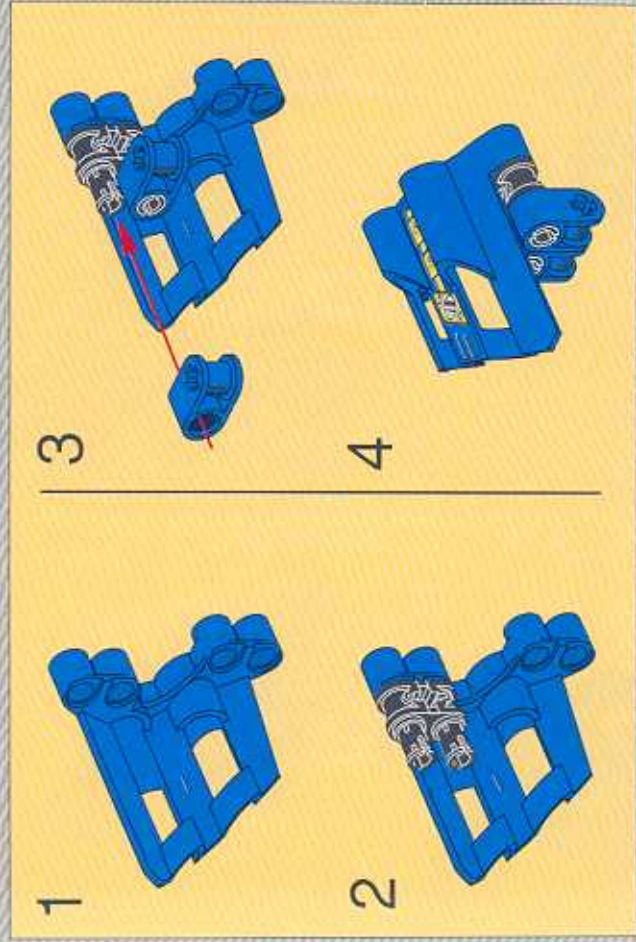
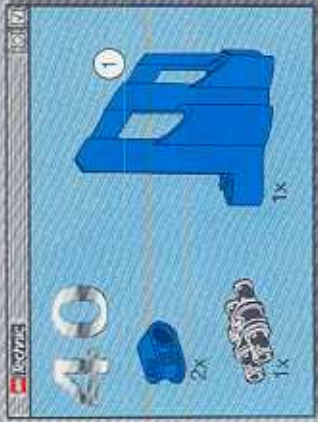

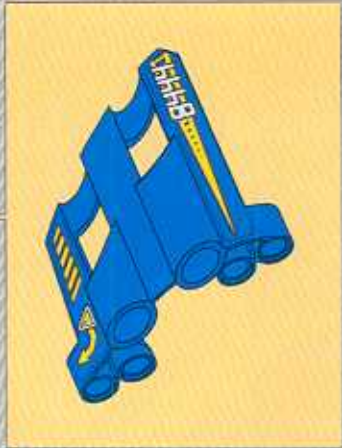
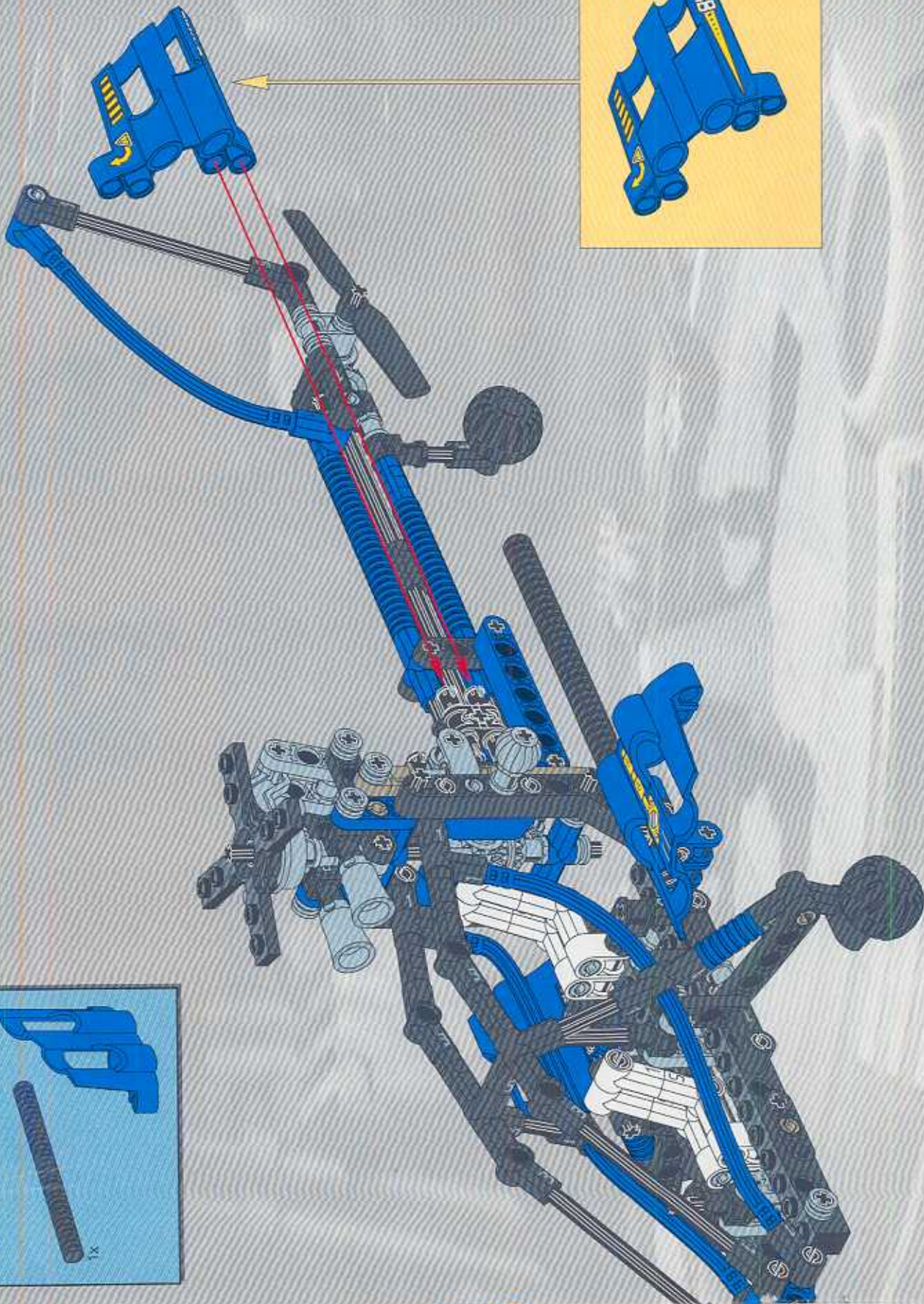

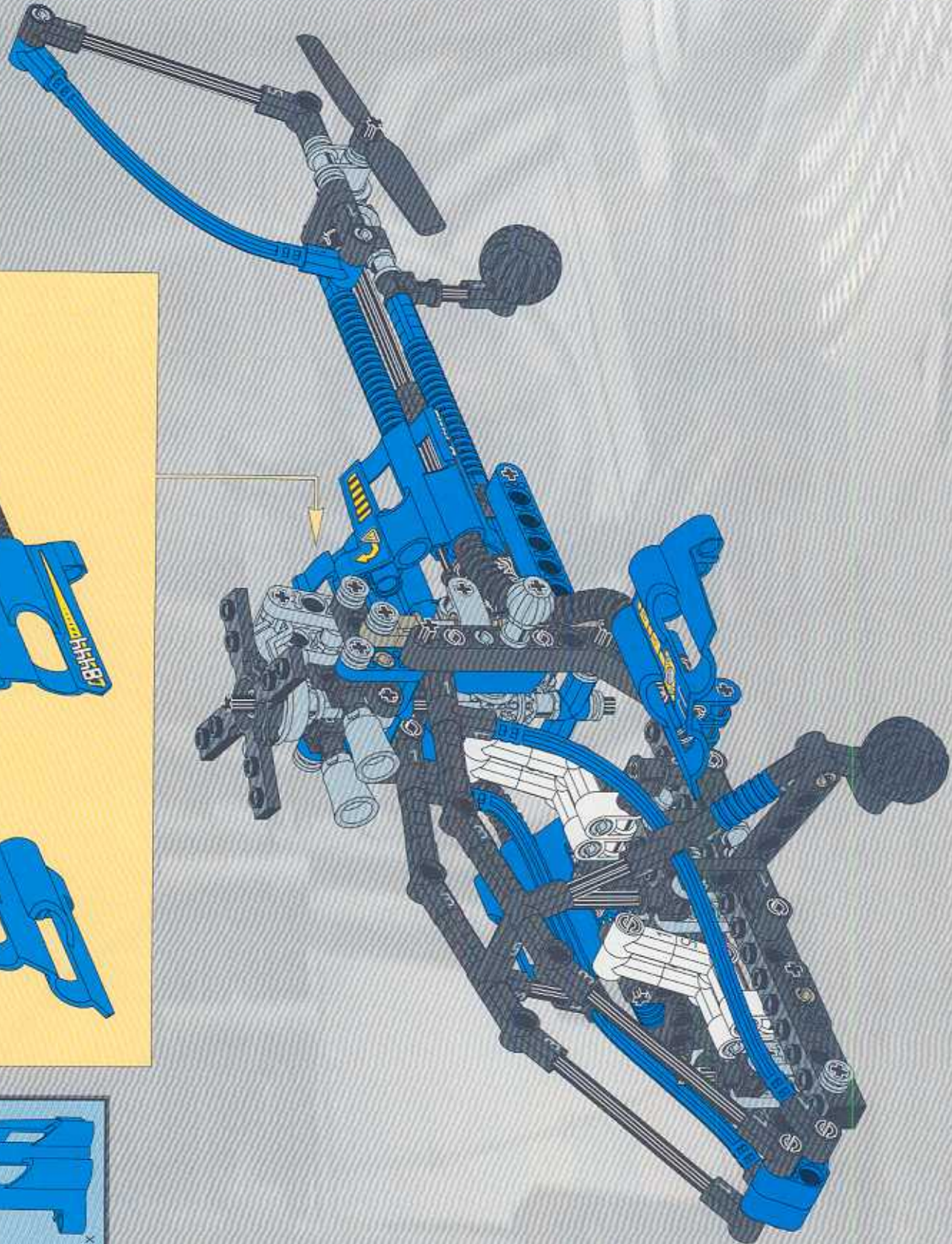
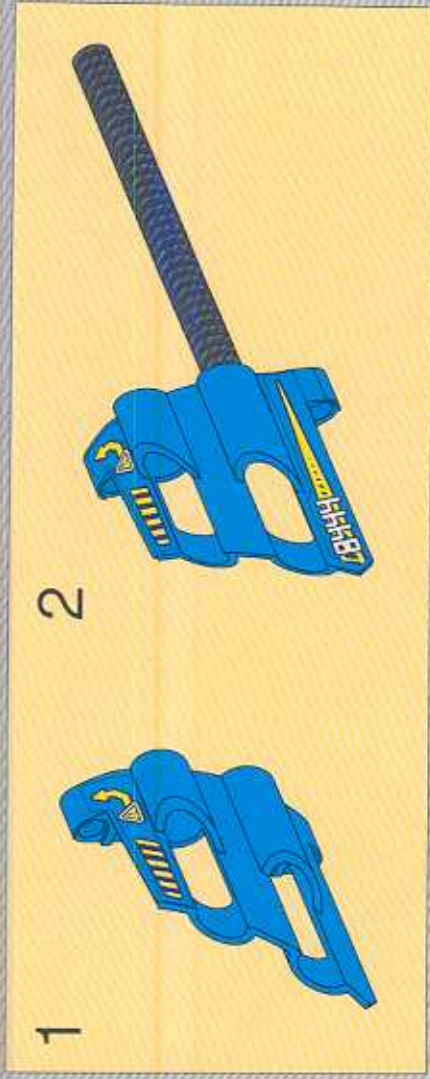

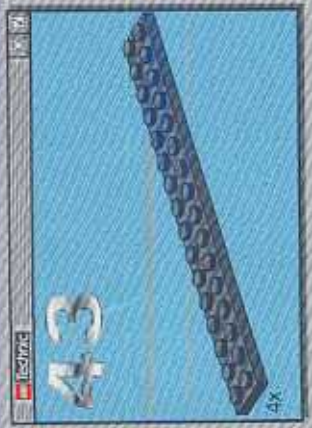
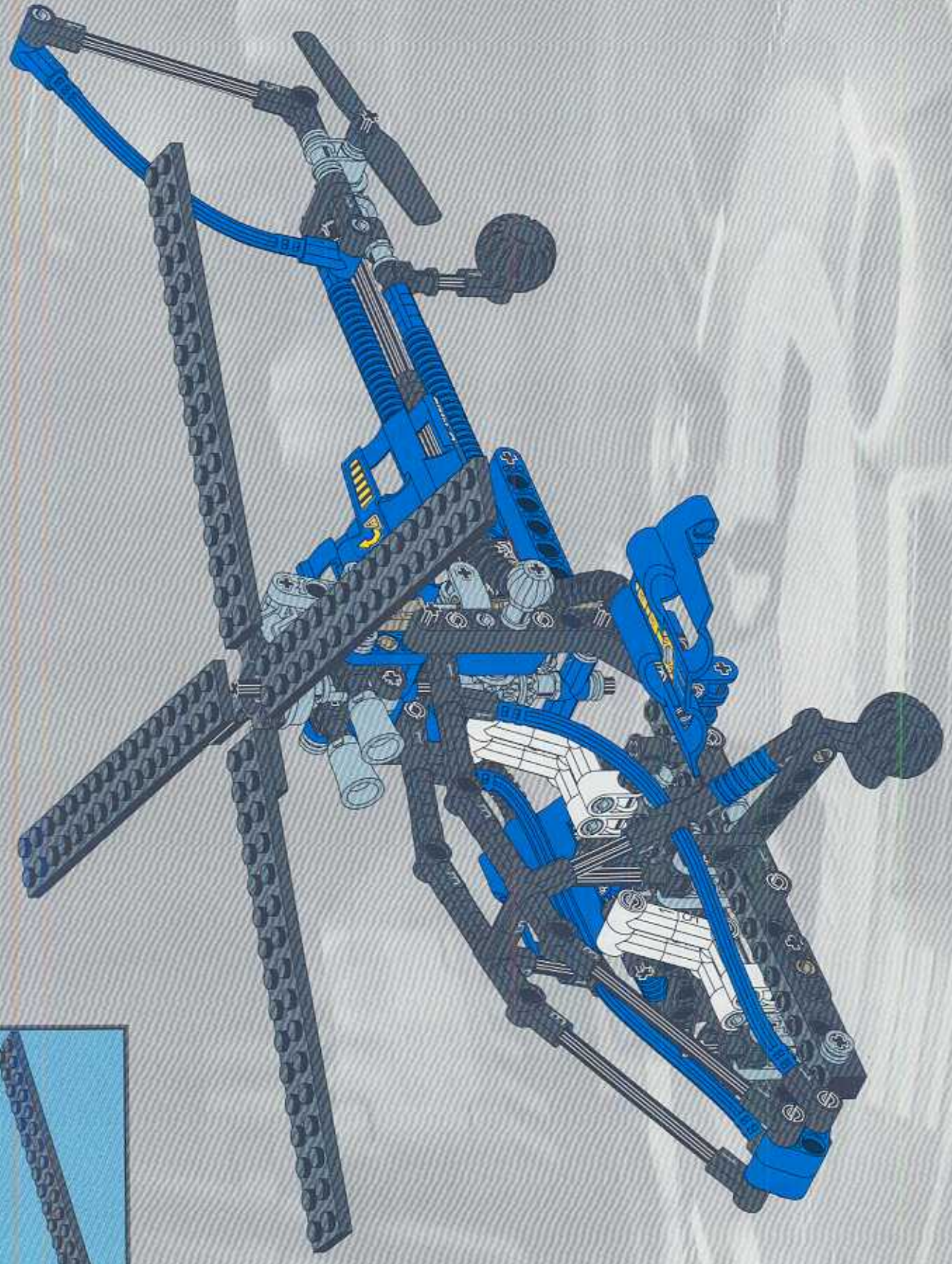

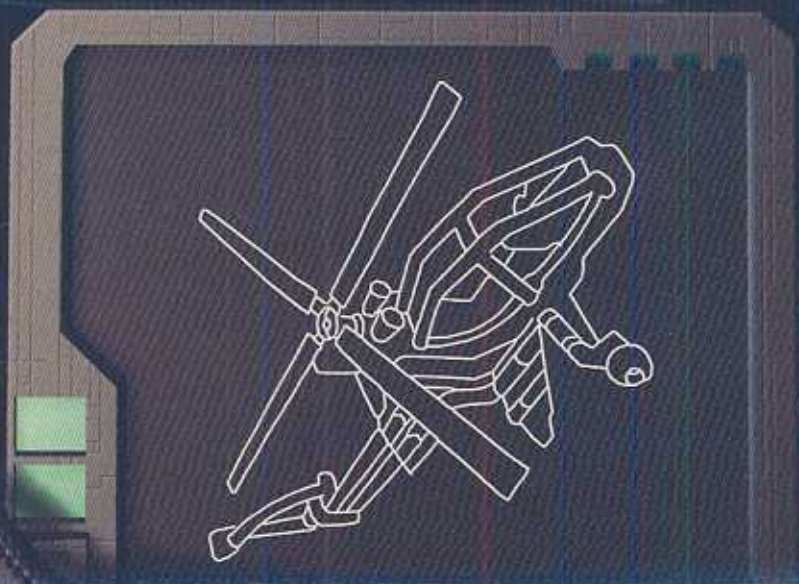
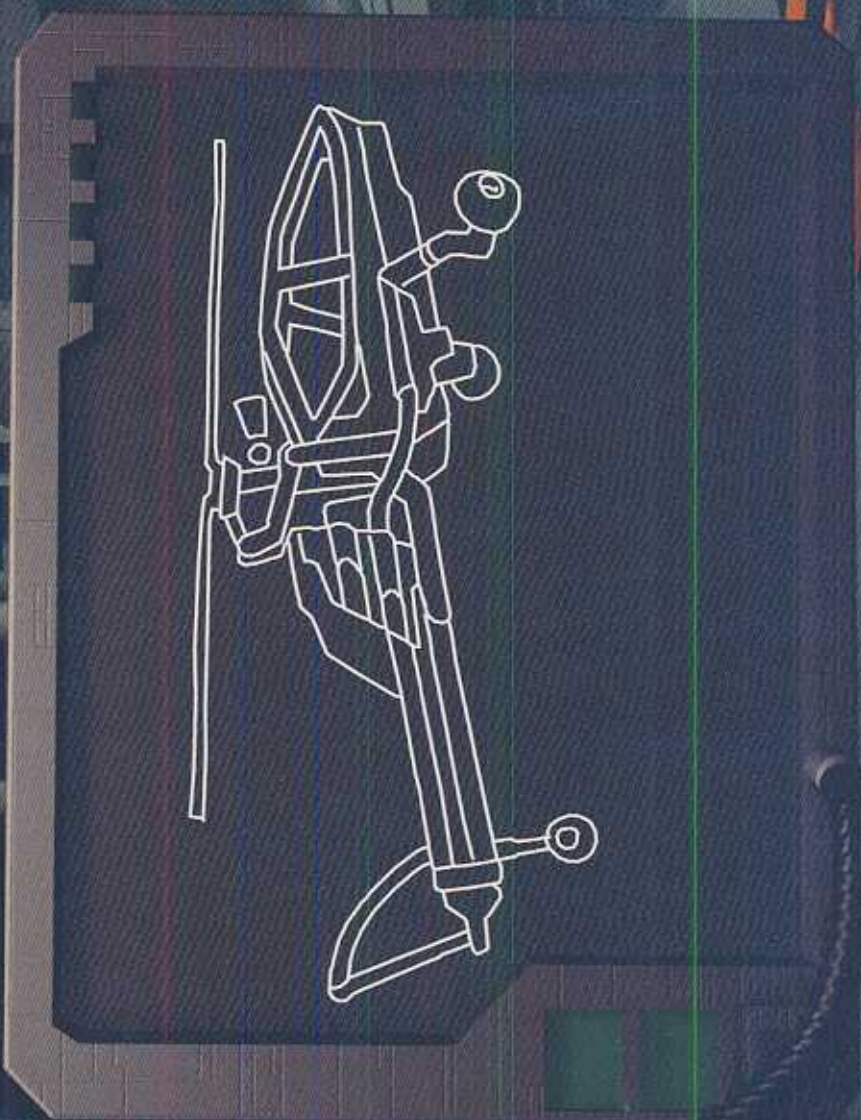

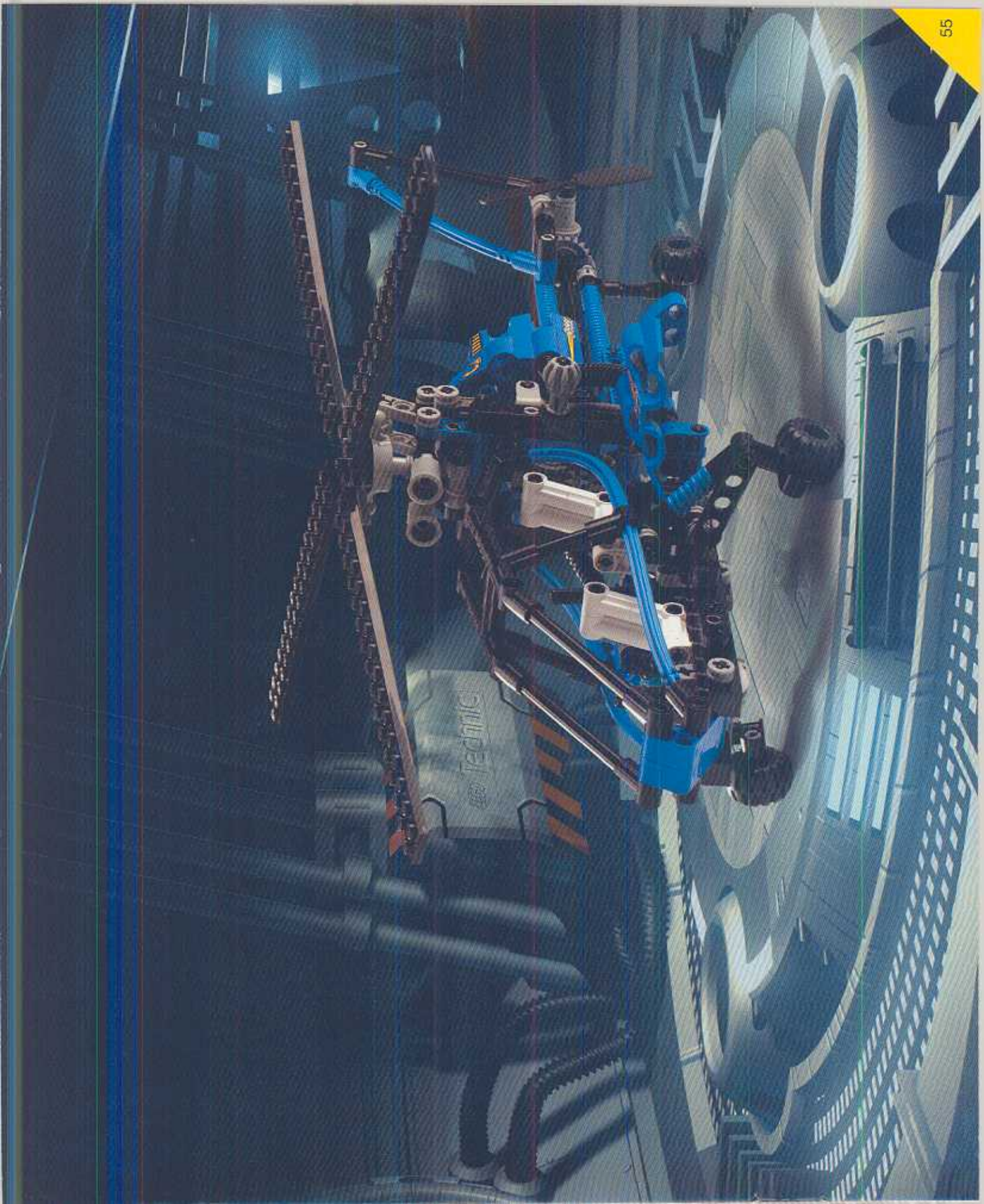

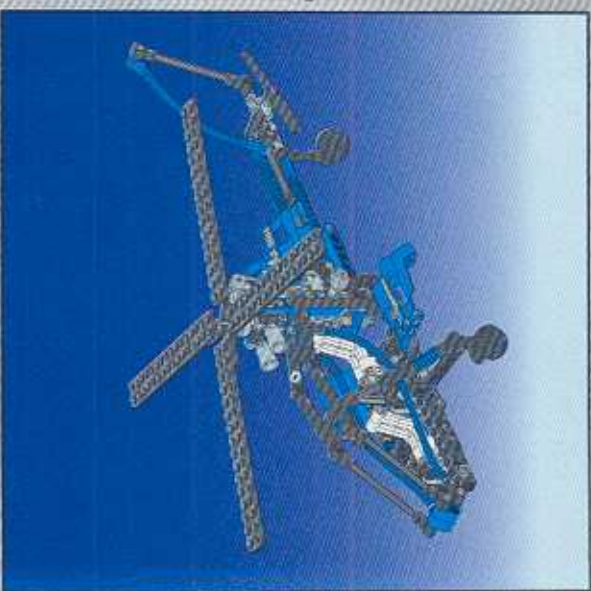

+

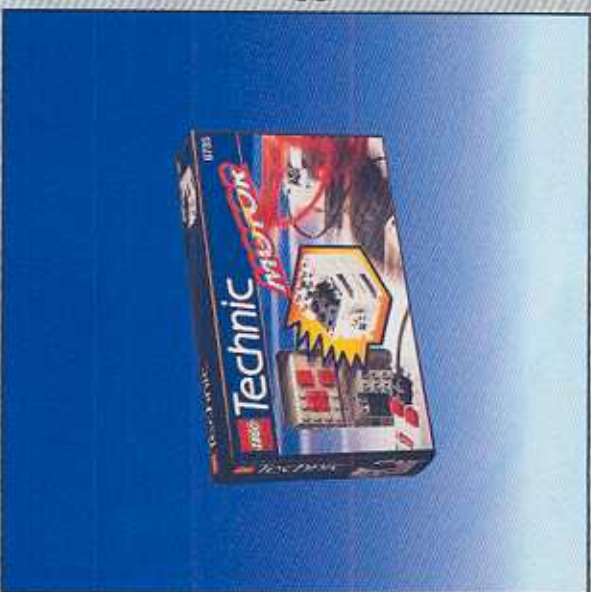

=

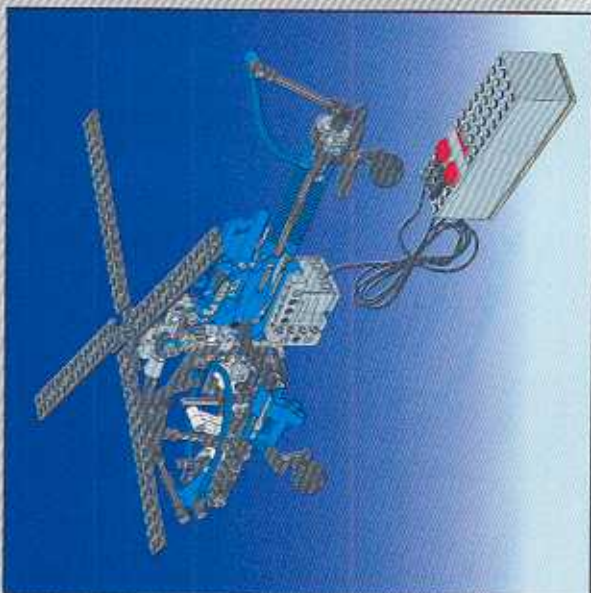



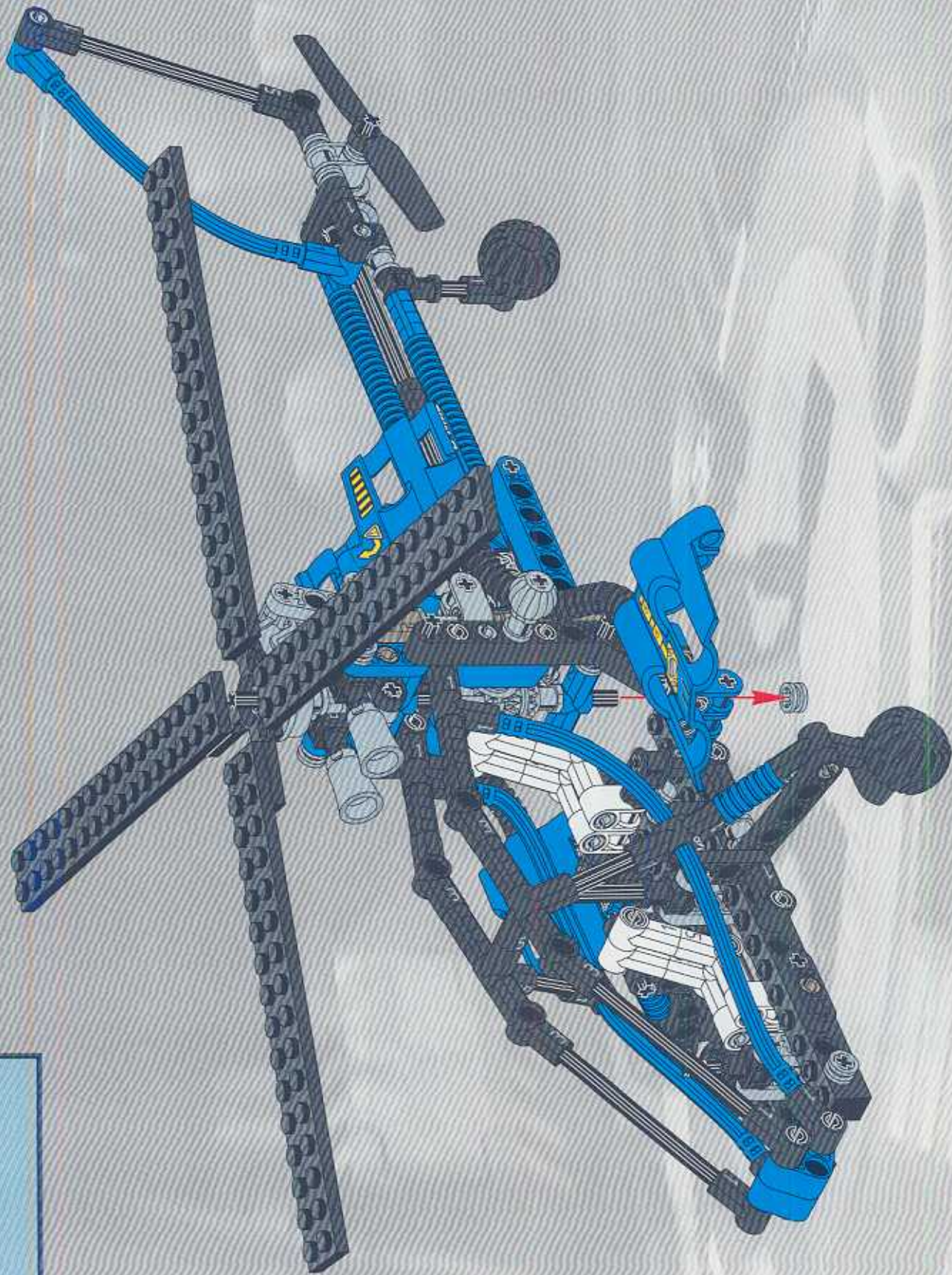

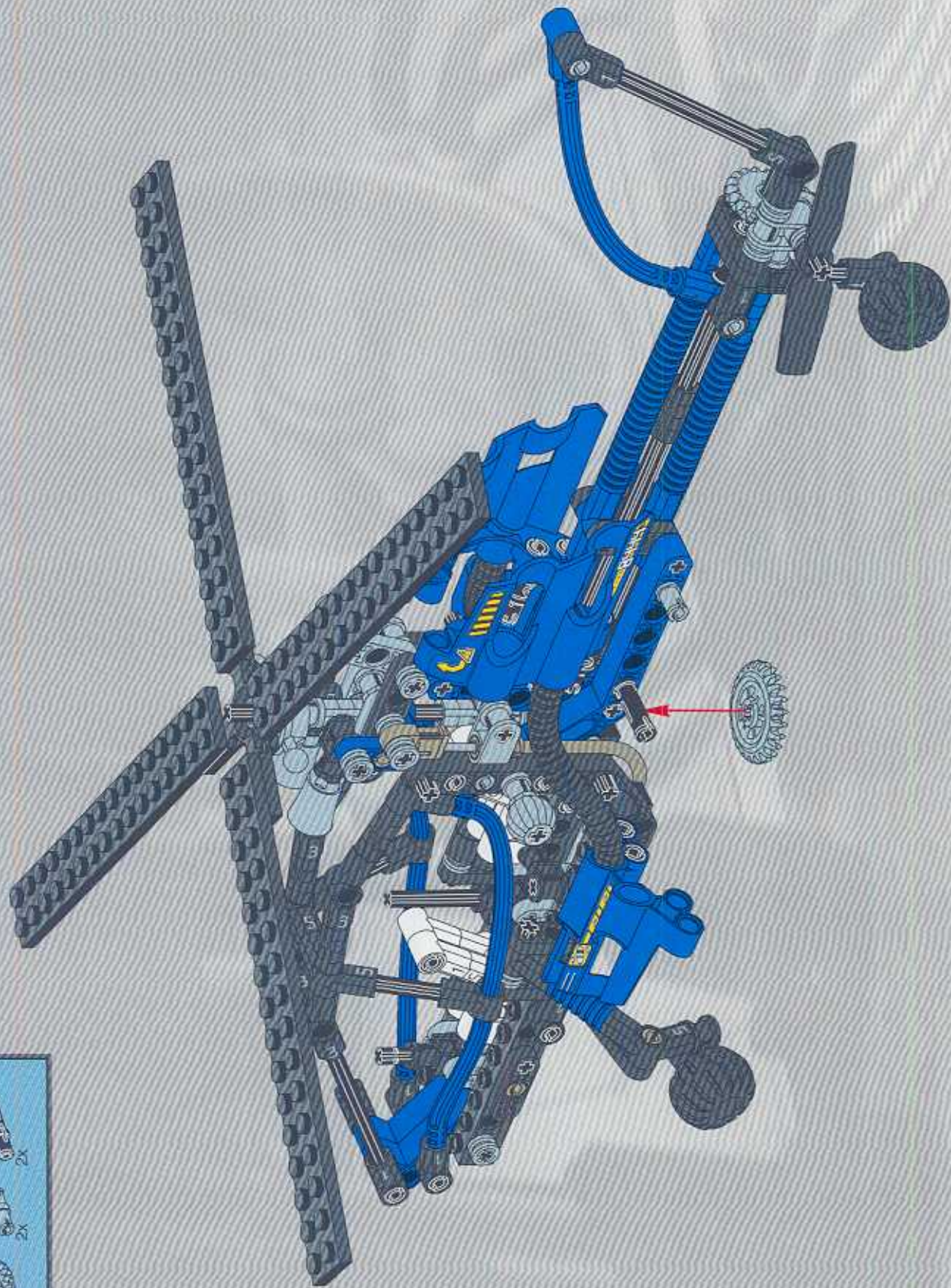

2x



2x



1x

LEGO INSTRUCTIONS

2

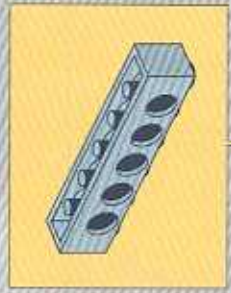
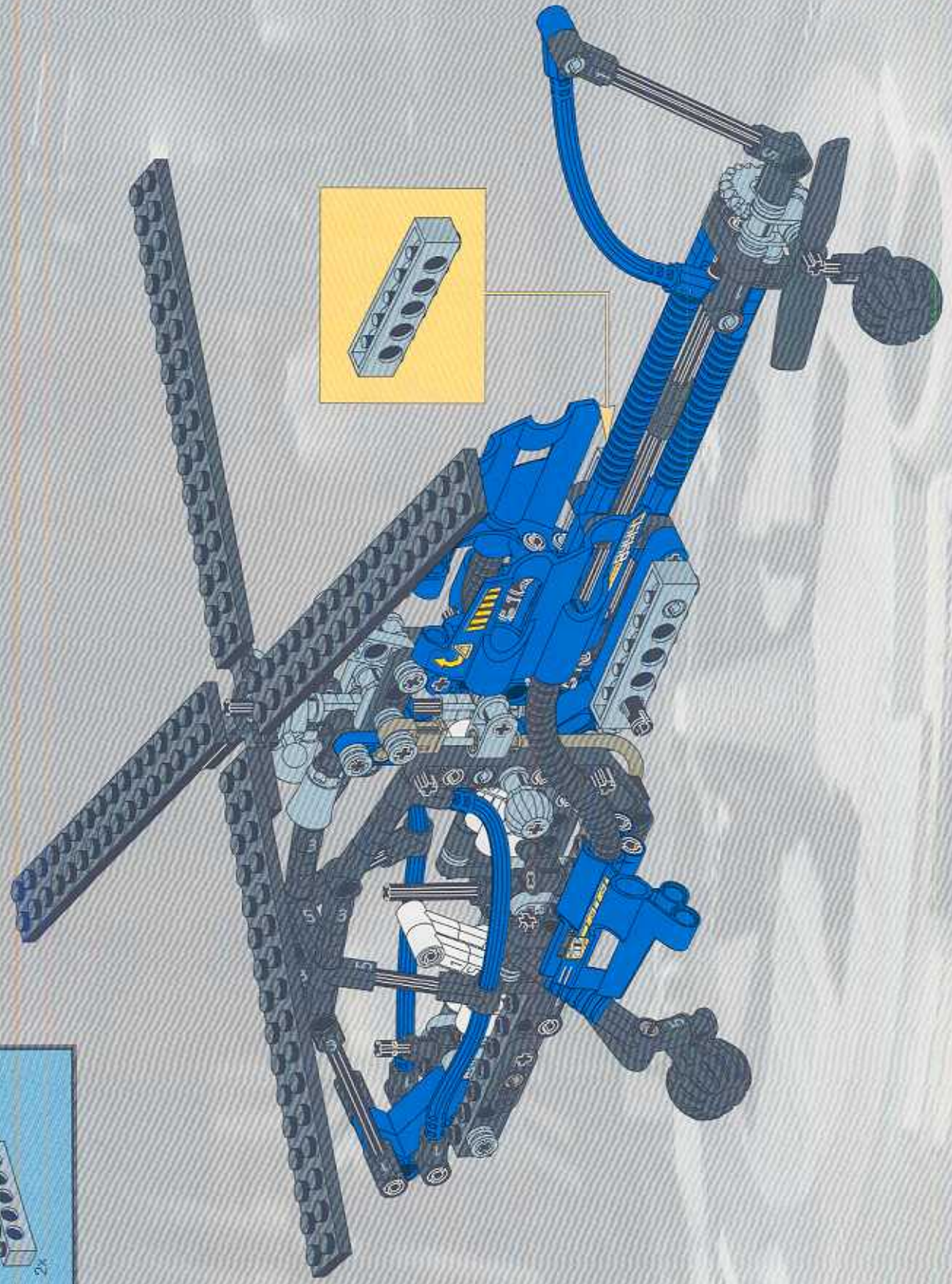

LEGO Technic

3

2x



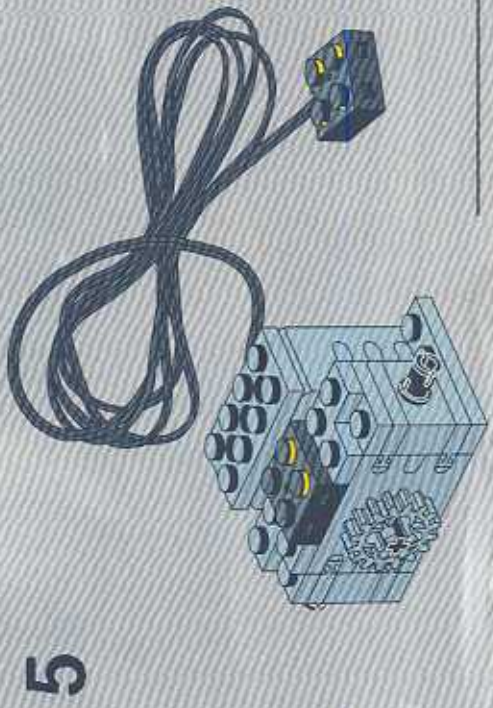
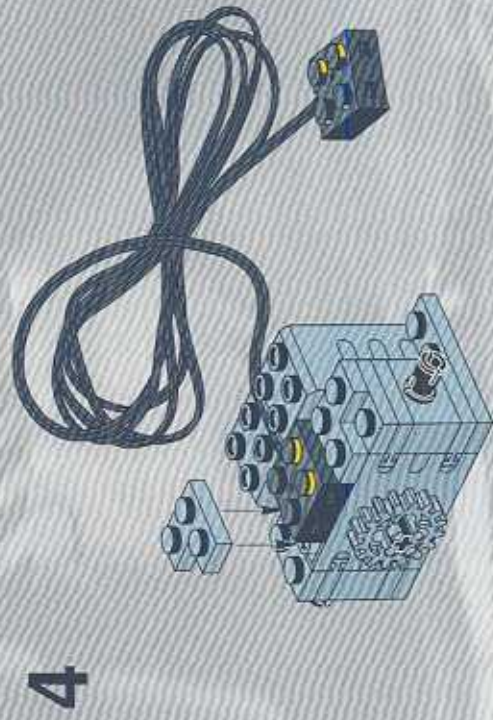

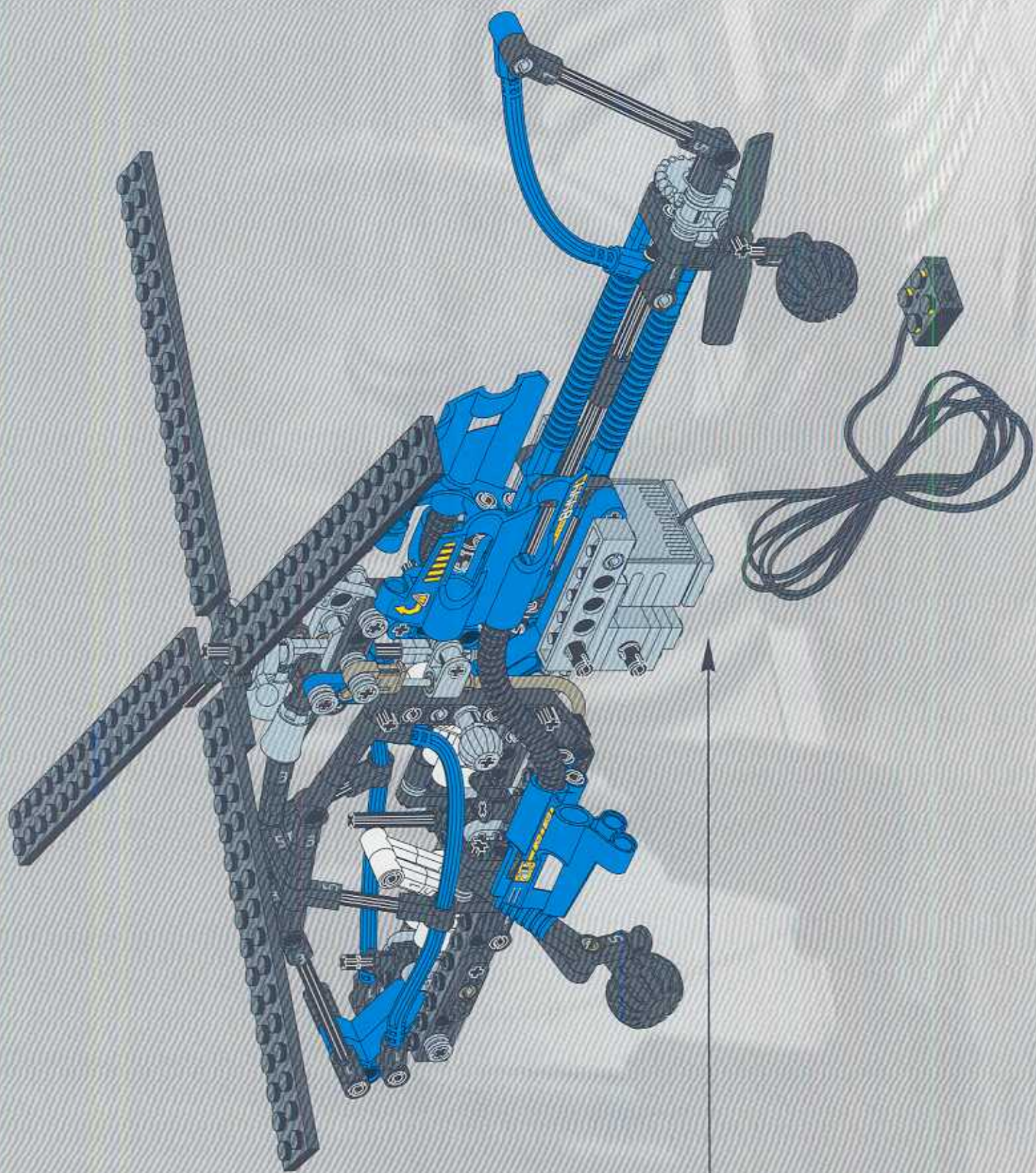

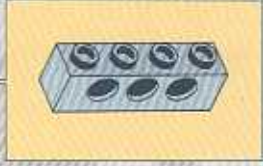
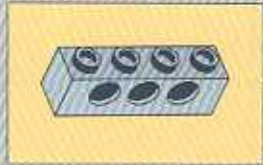
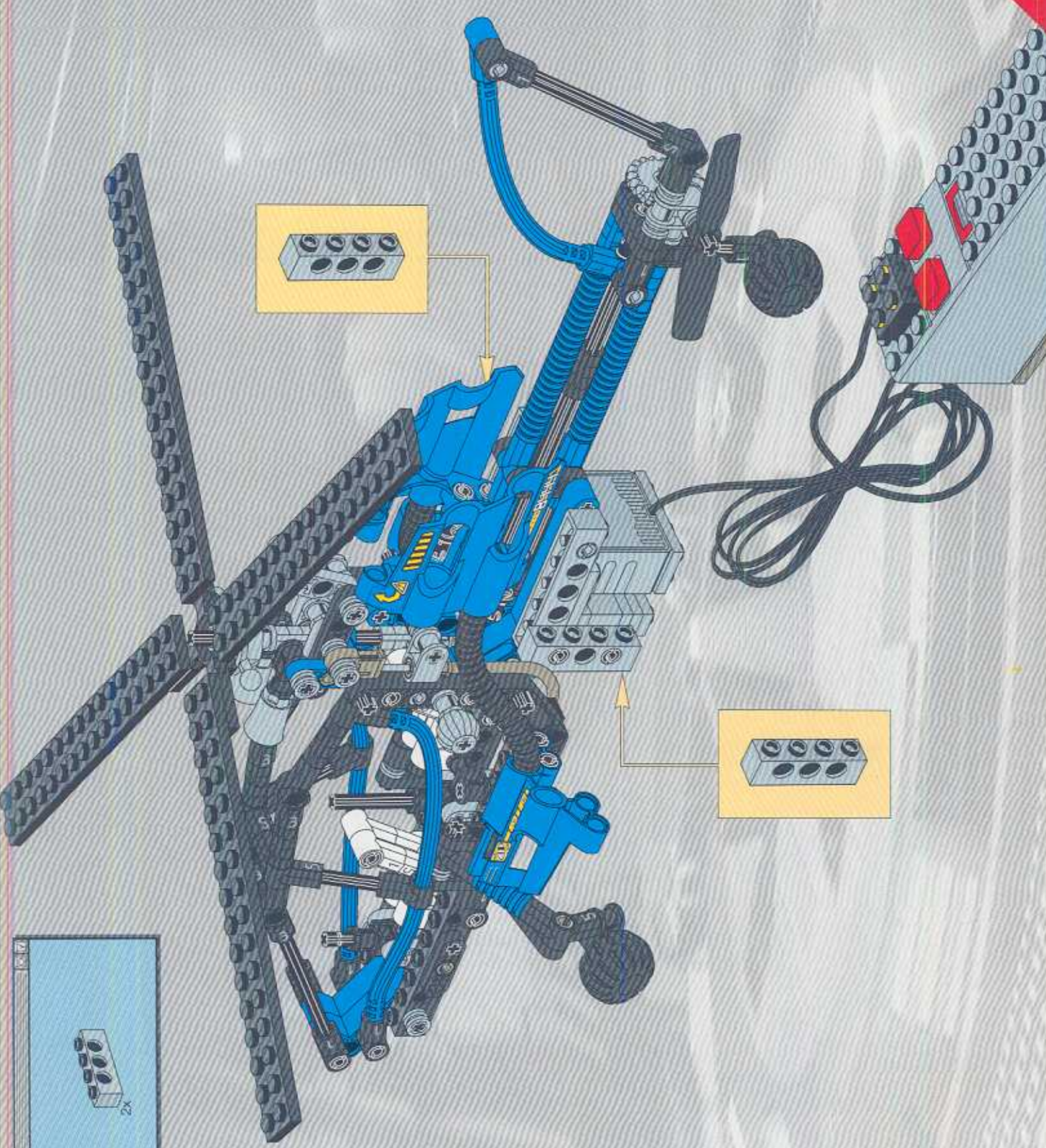

LEGO

5

2x

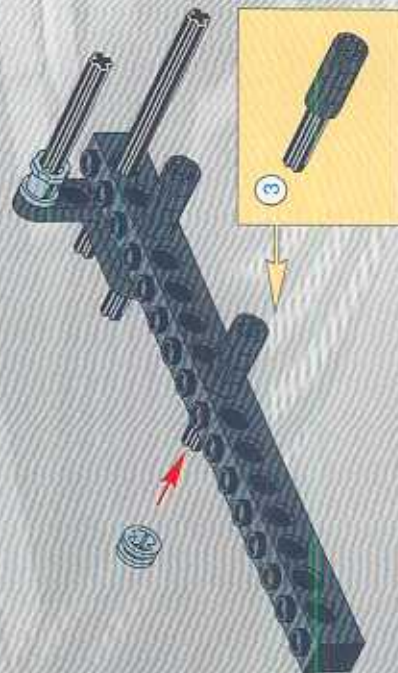
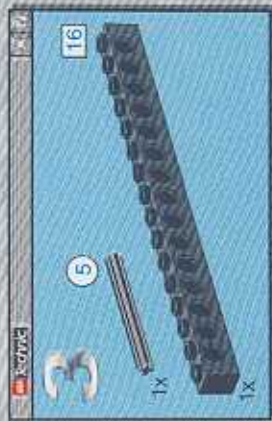
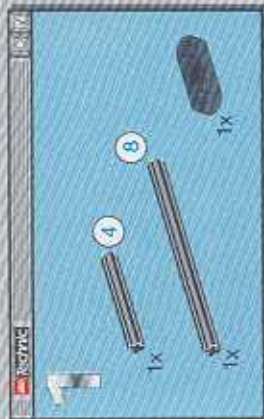



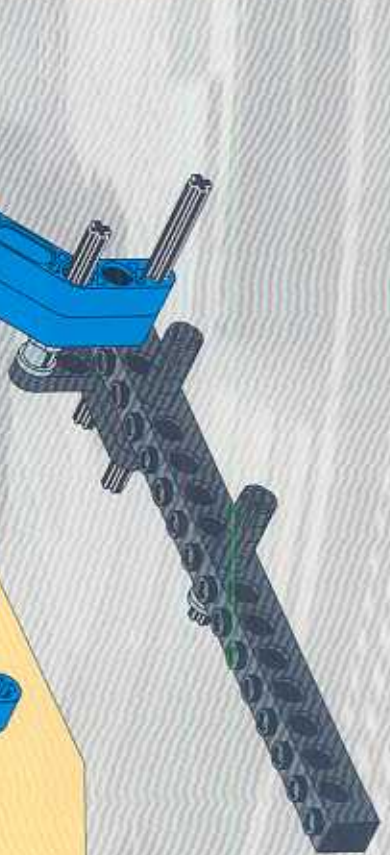
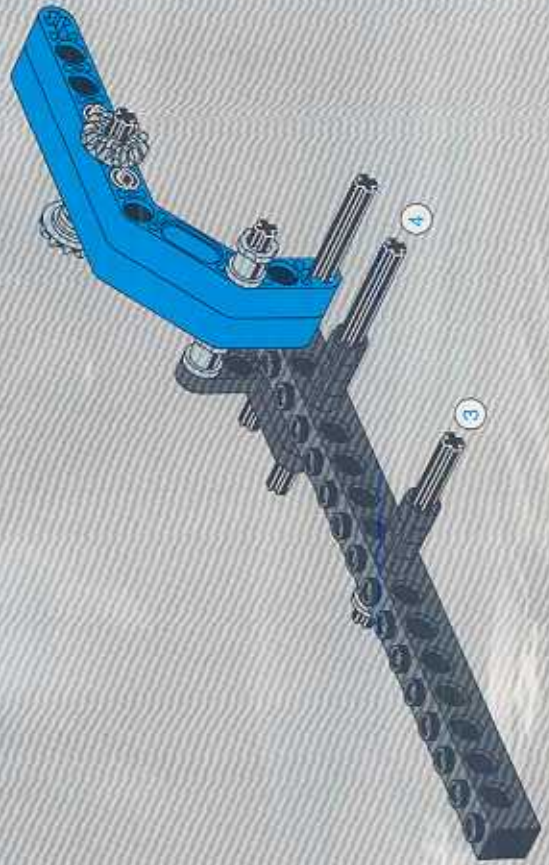
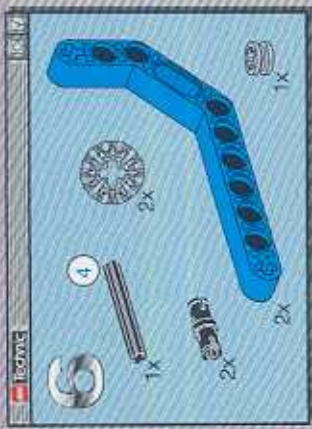
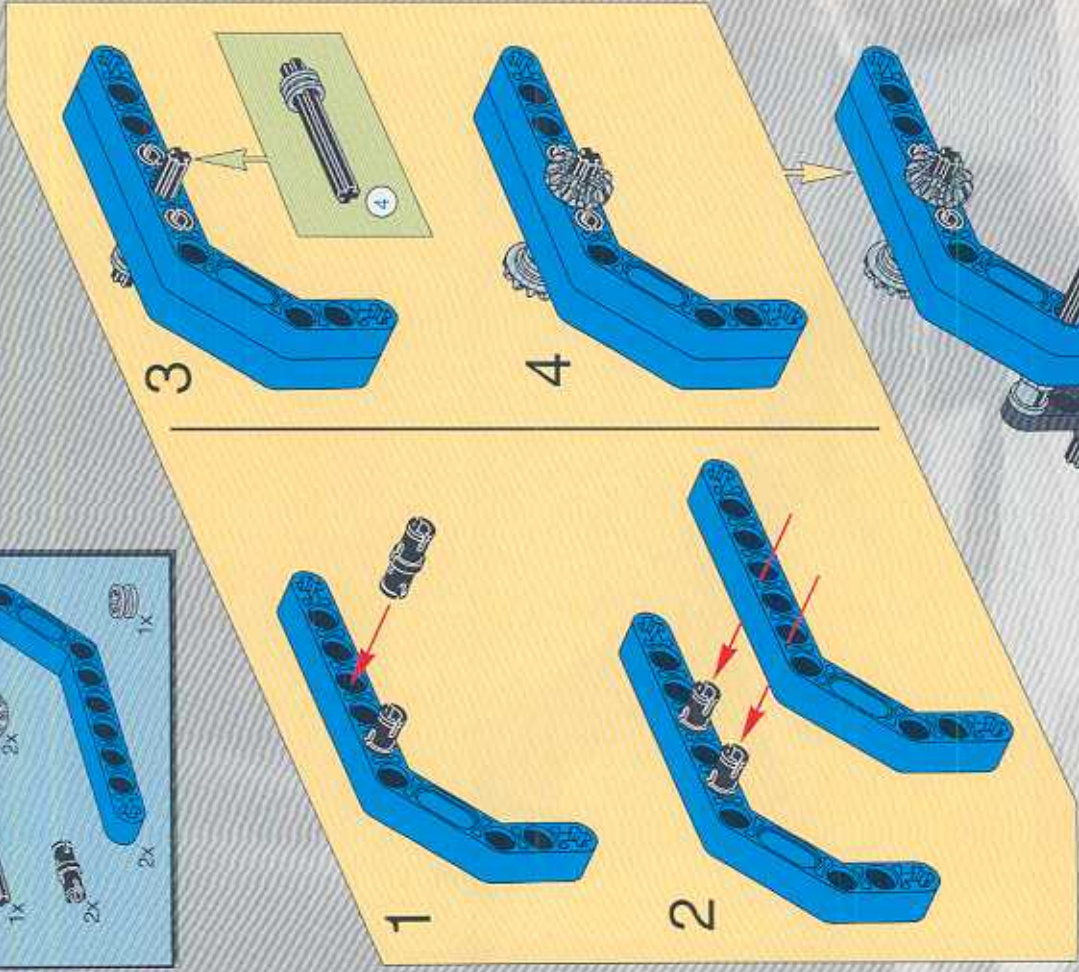
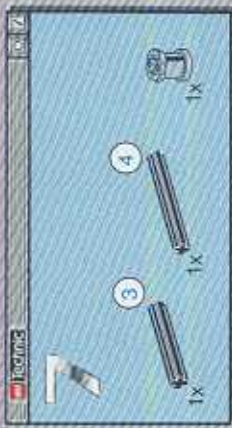

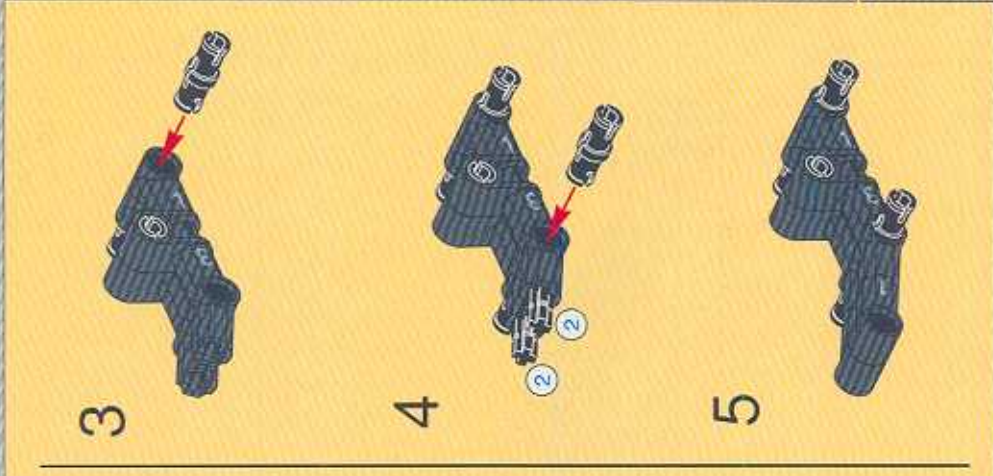
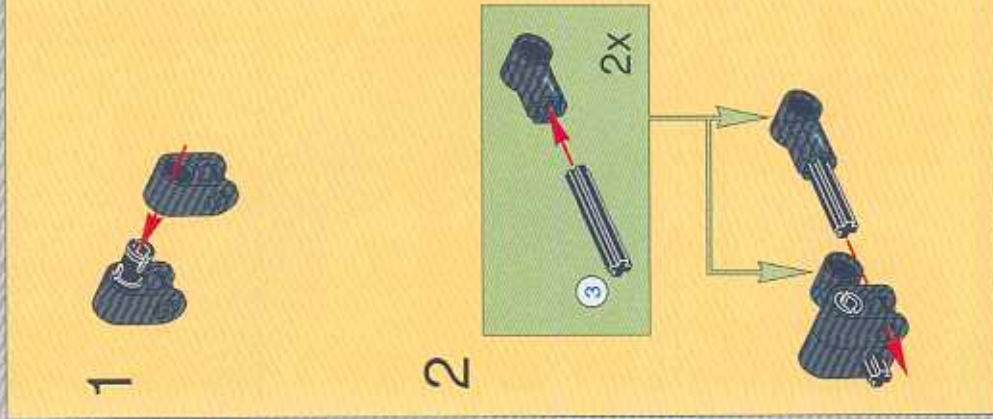
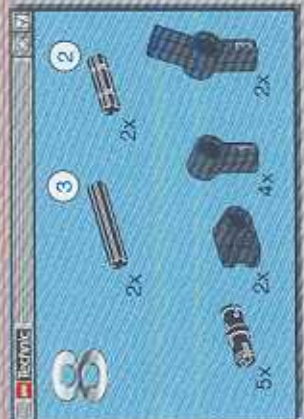

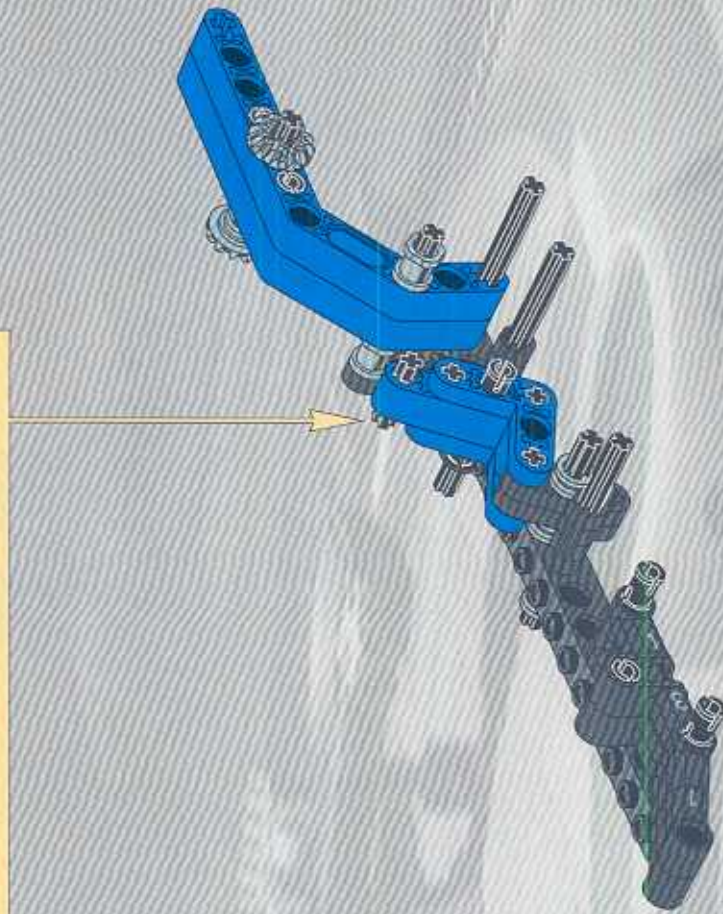
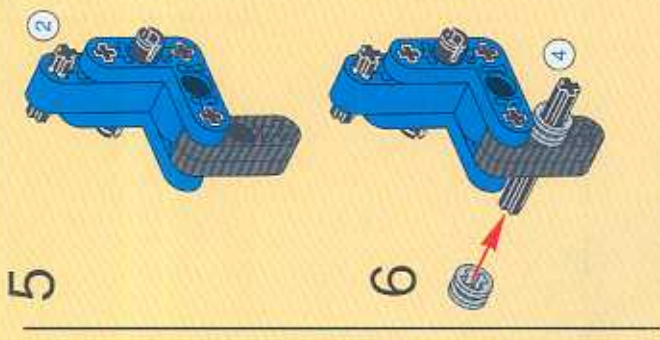
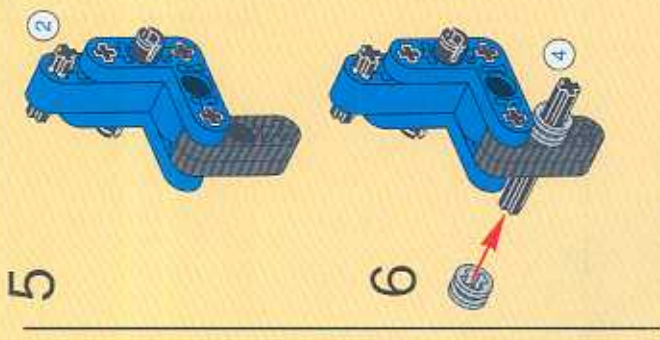
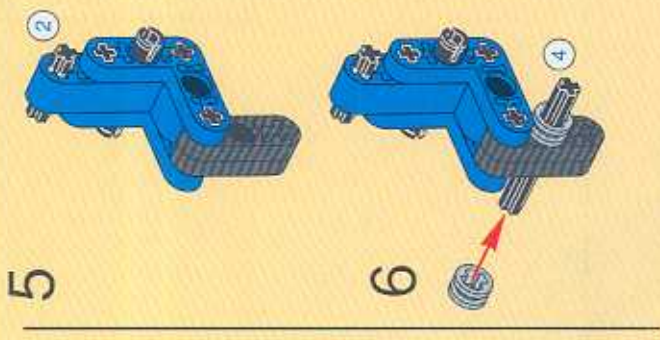
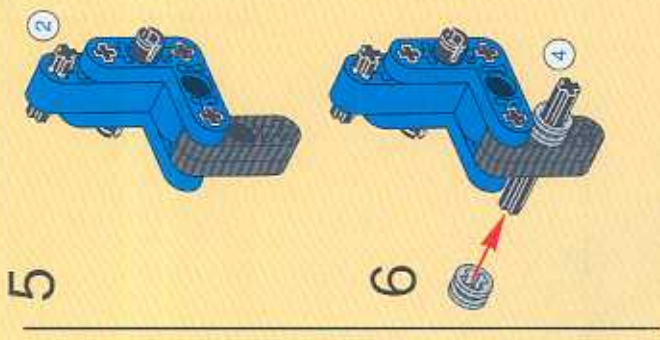
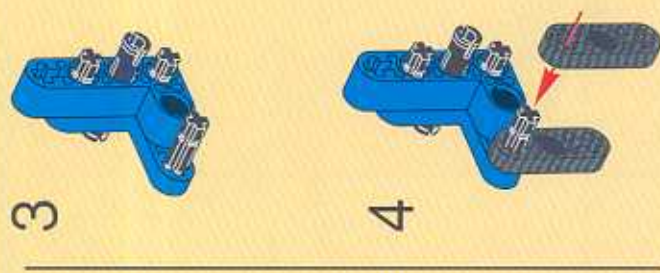
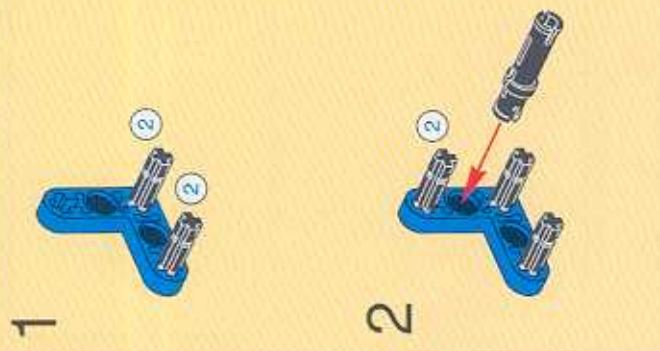

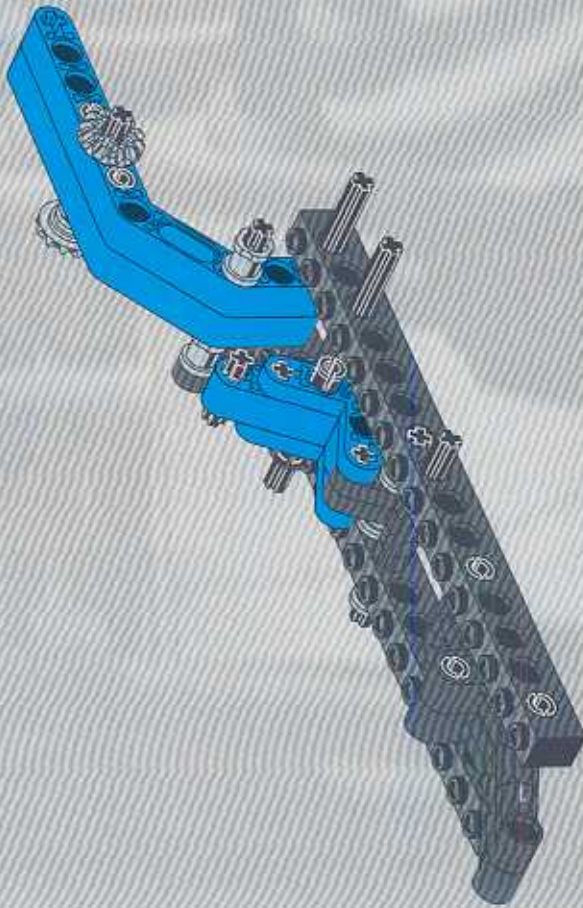
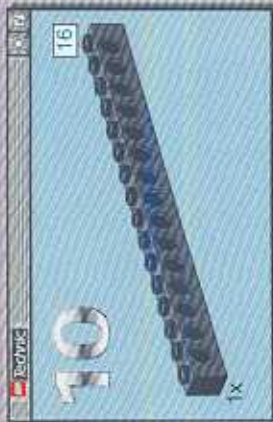

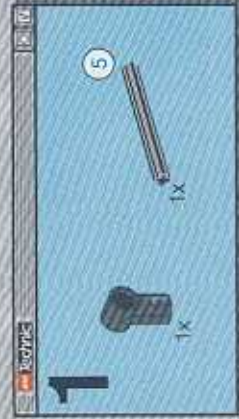
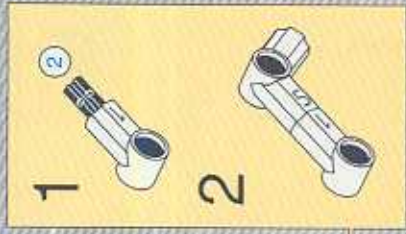
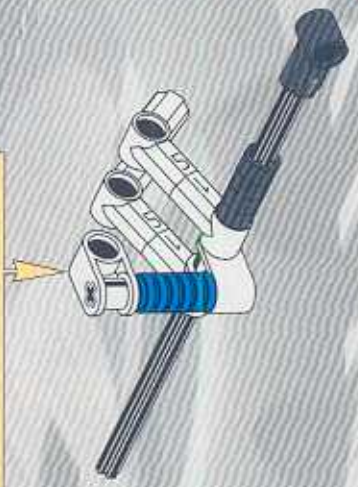
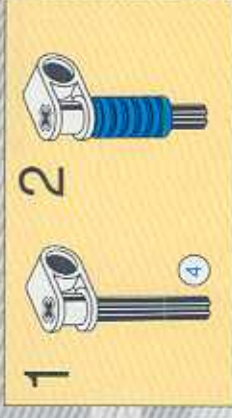
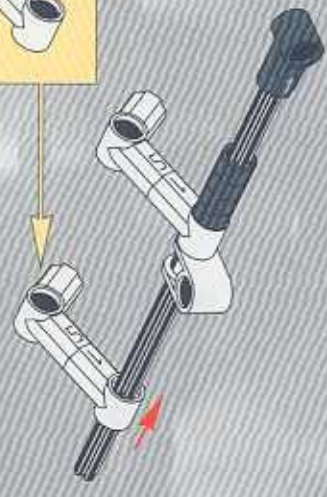
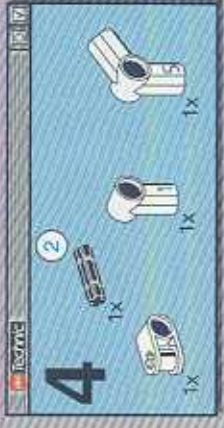
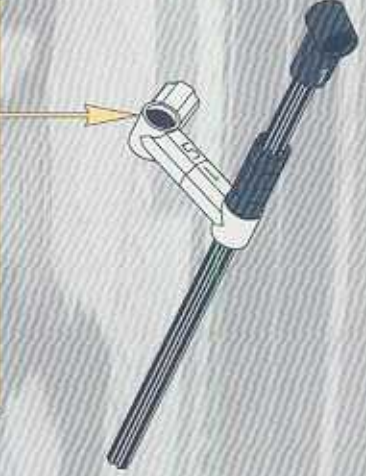
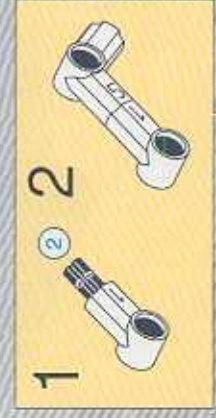
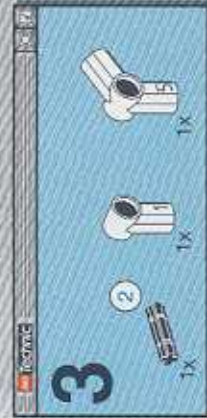
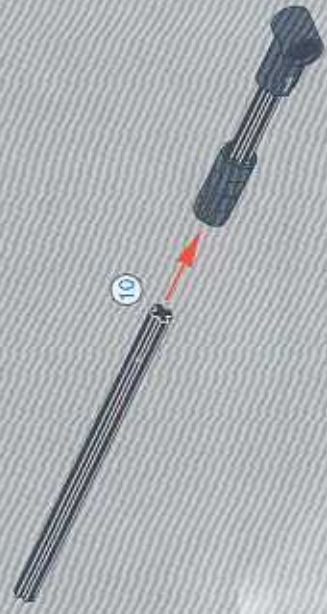
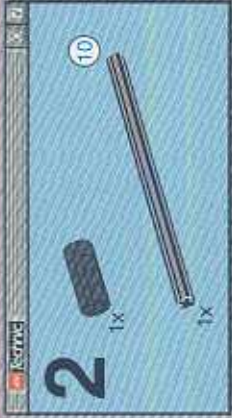
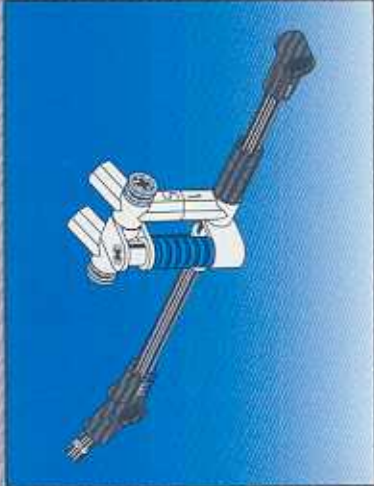

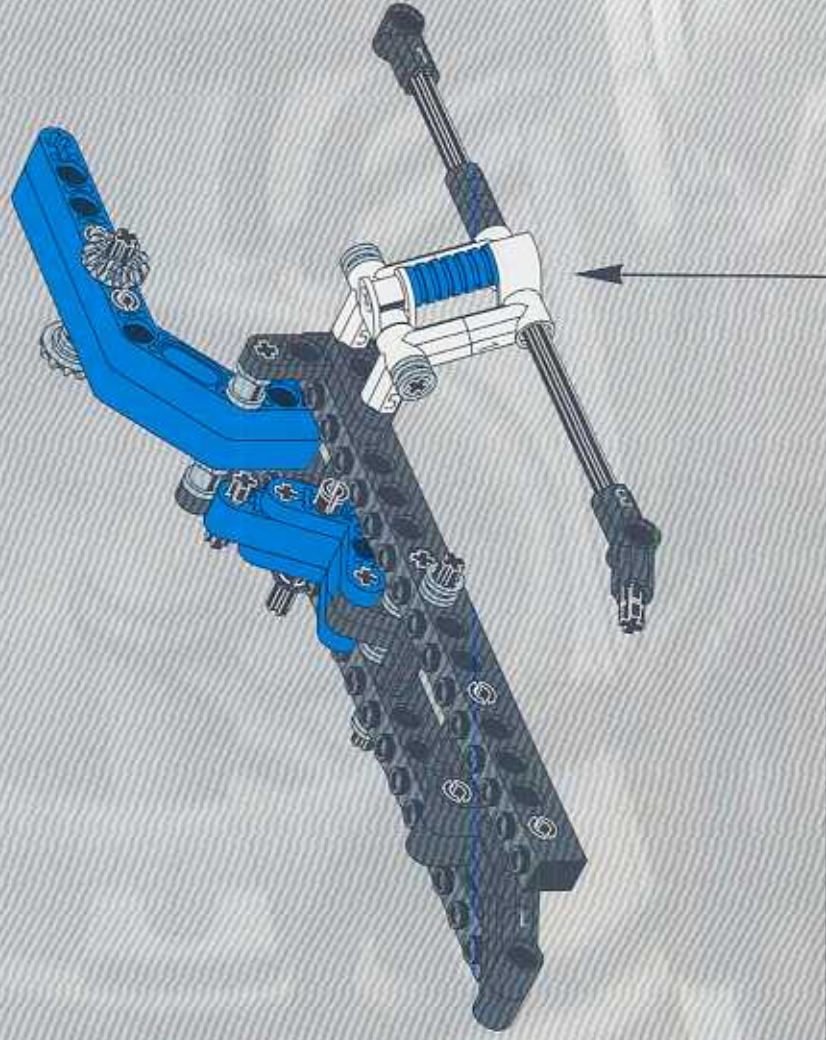
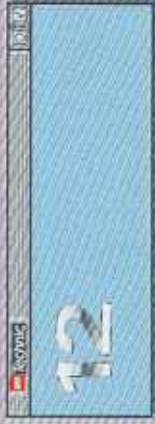
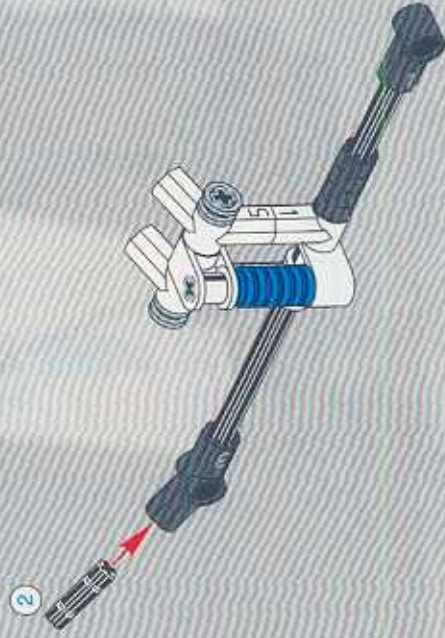
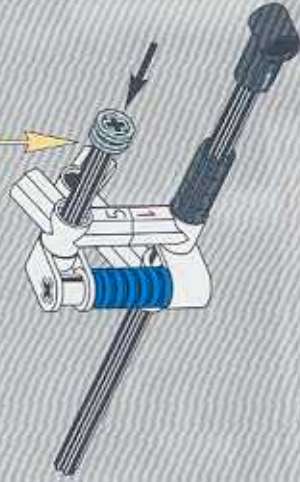

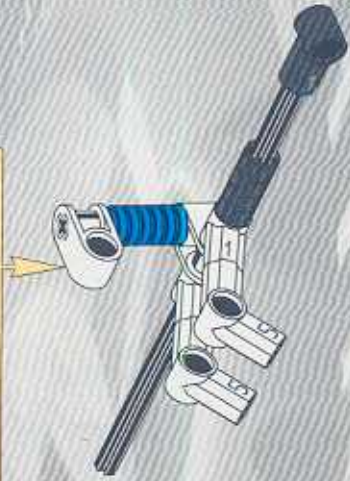
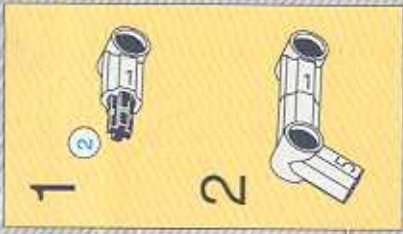
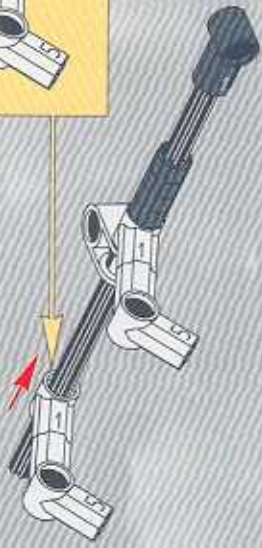
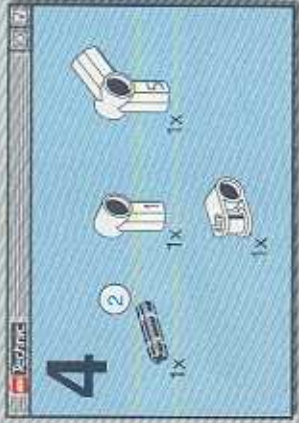
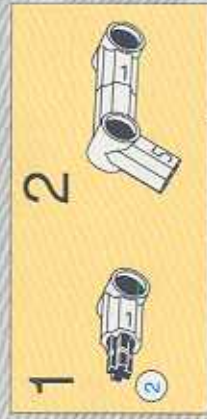
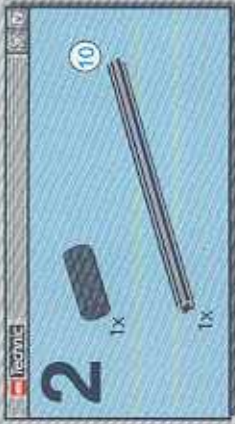
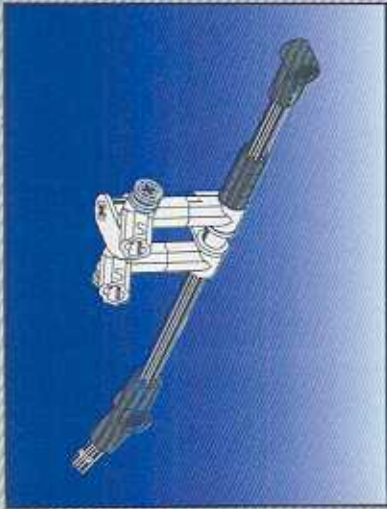

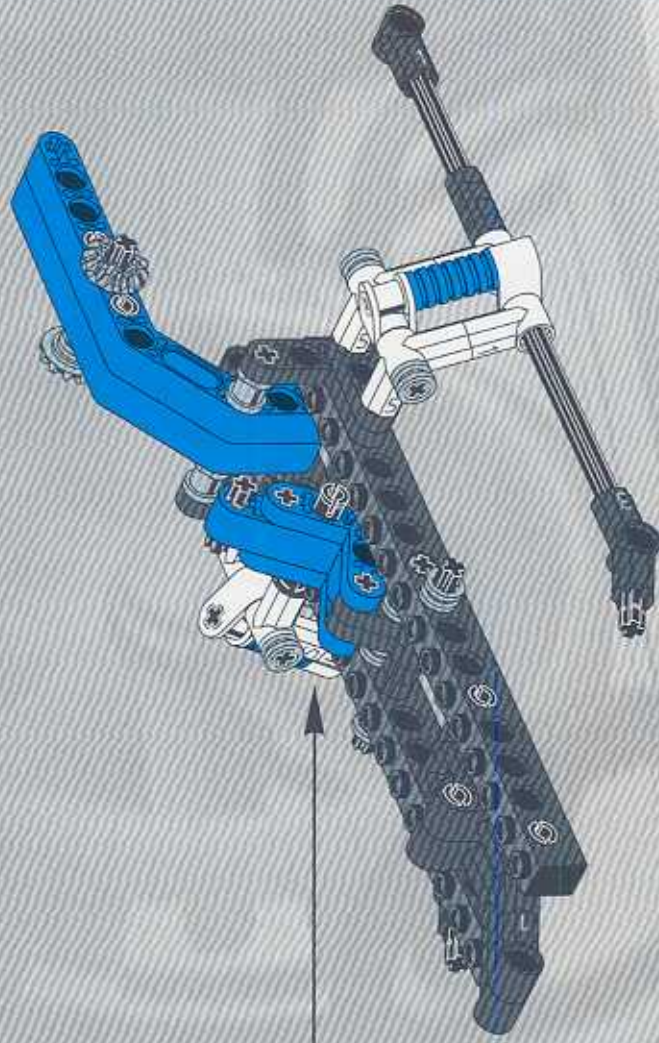
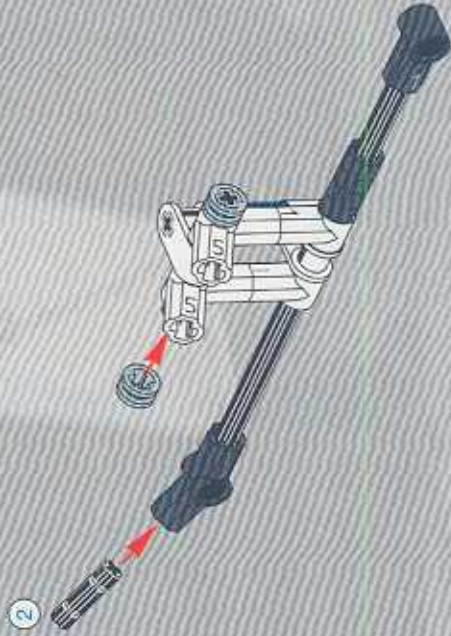
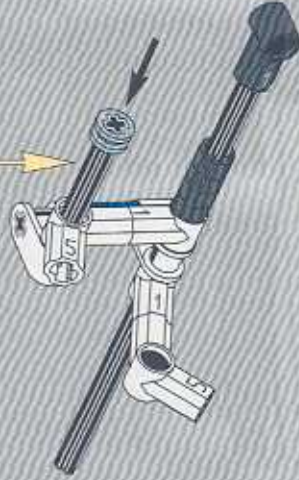



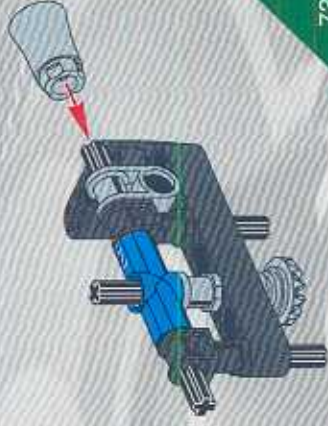
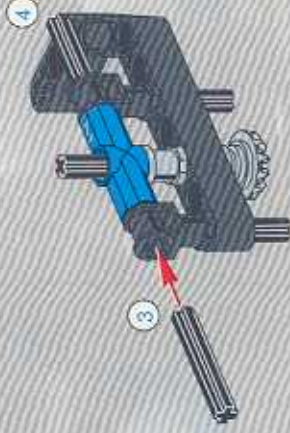
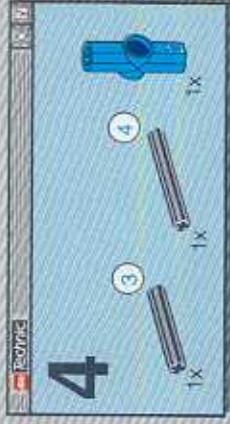
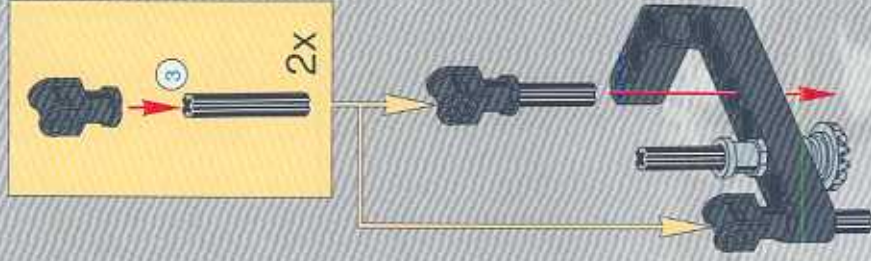
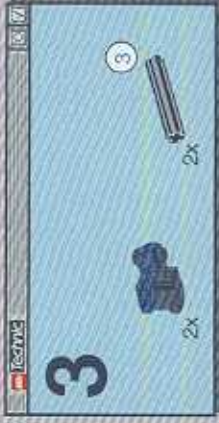
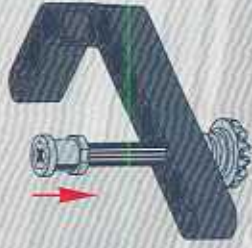



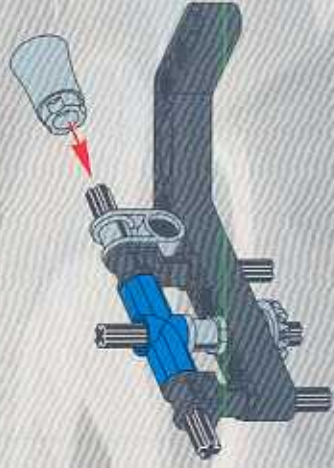
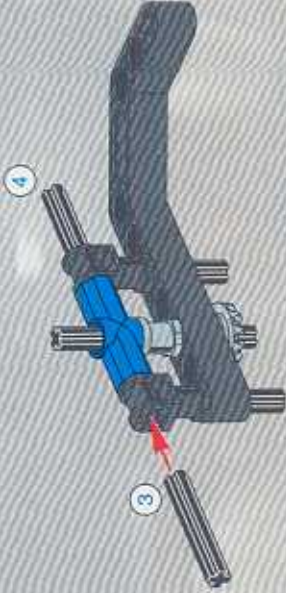
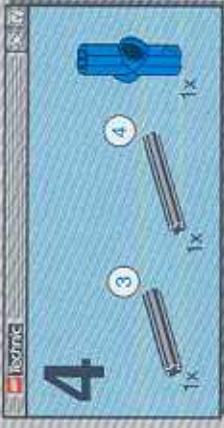
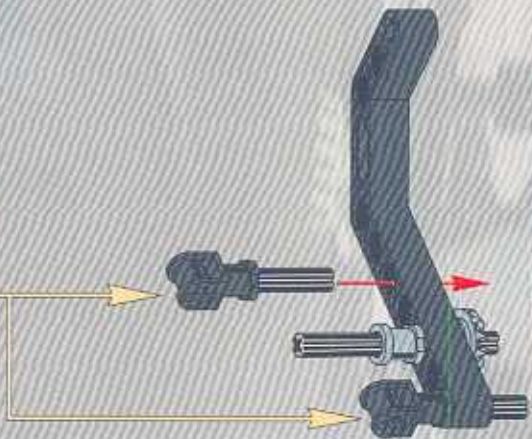
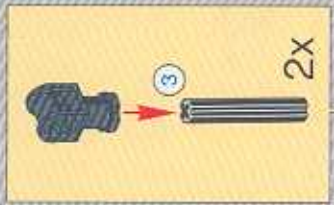
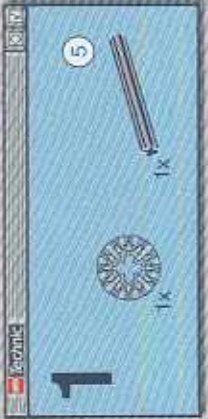

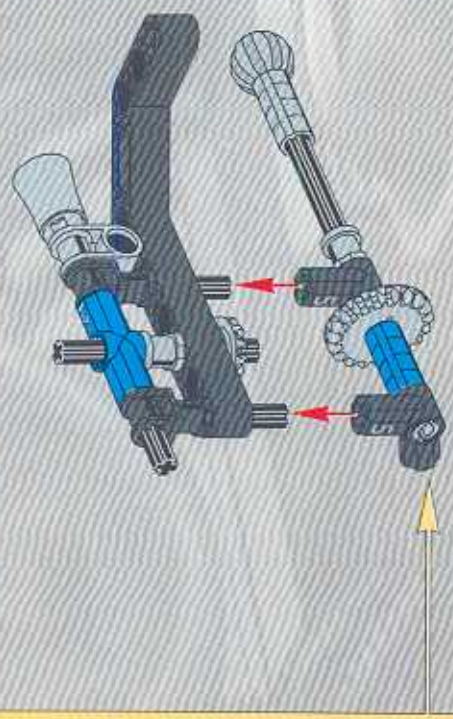
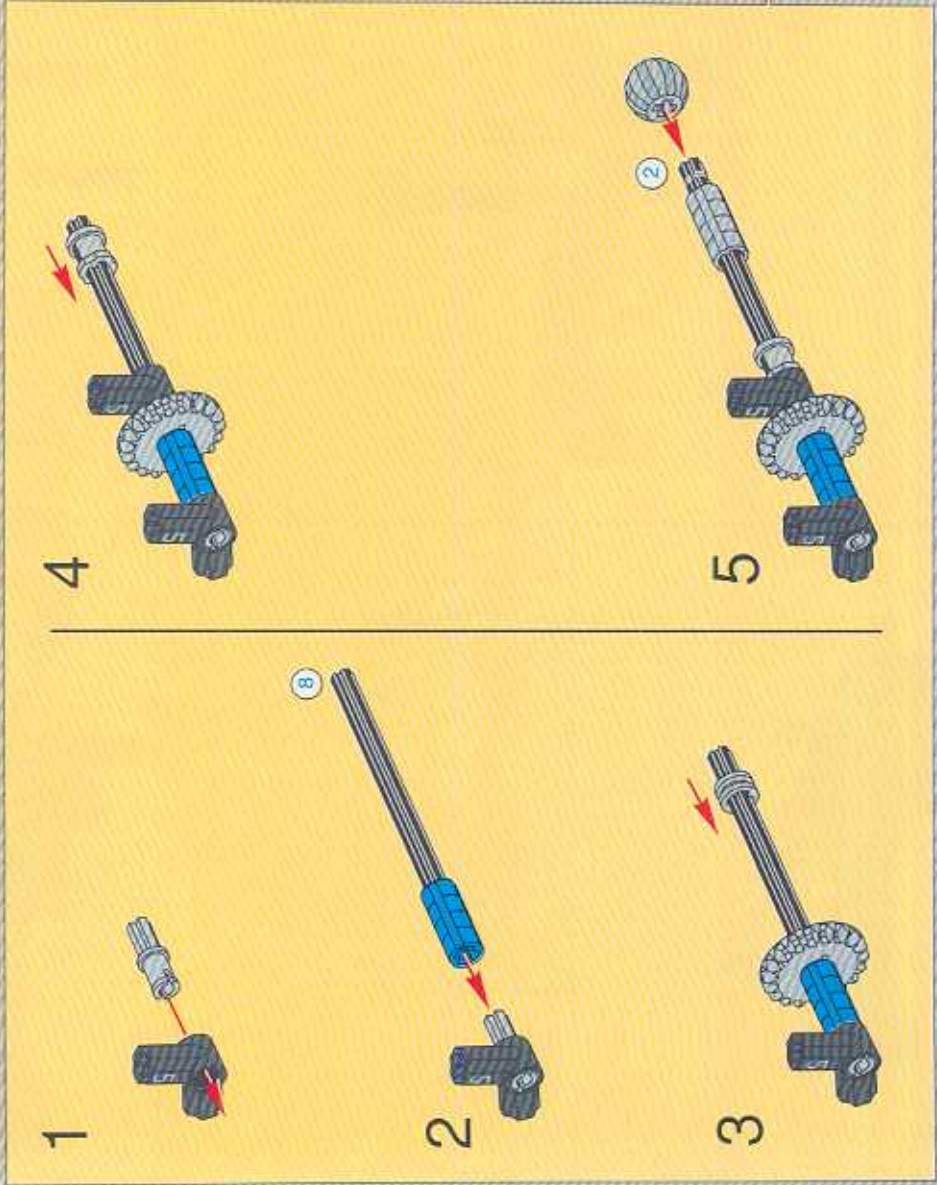
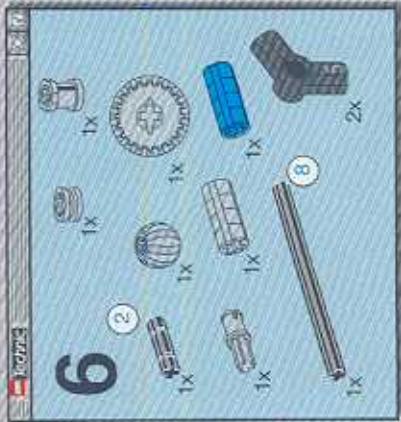

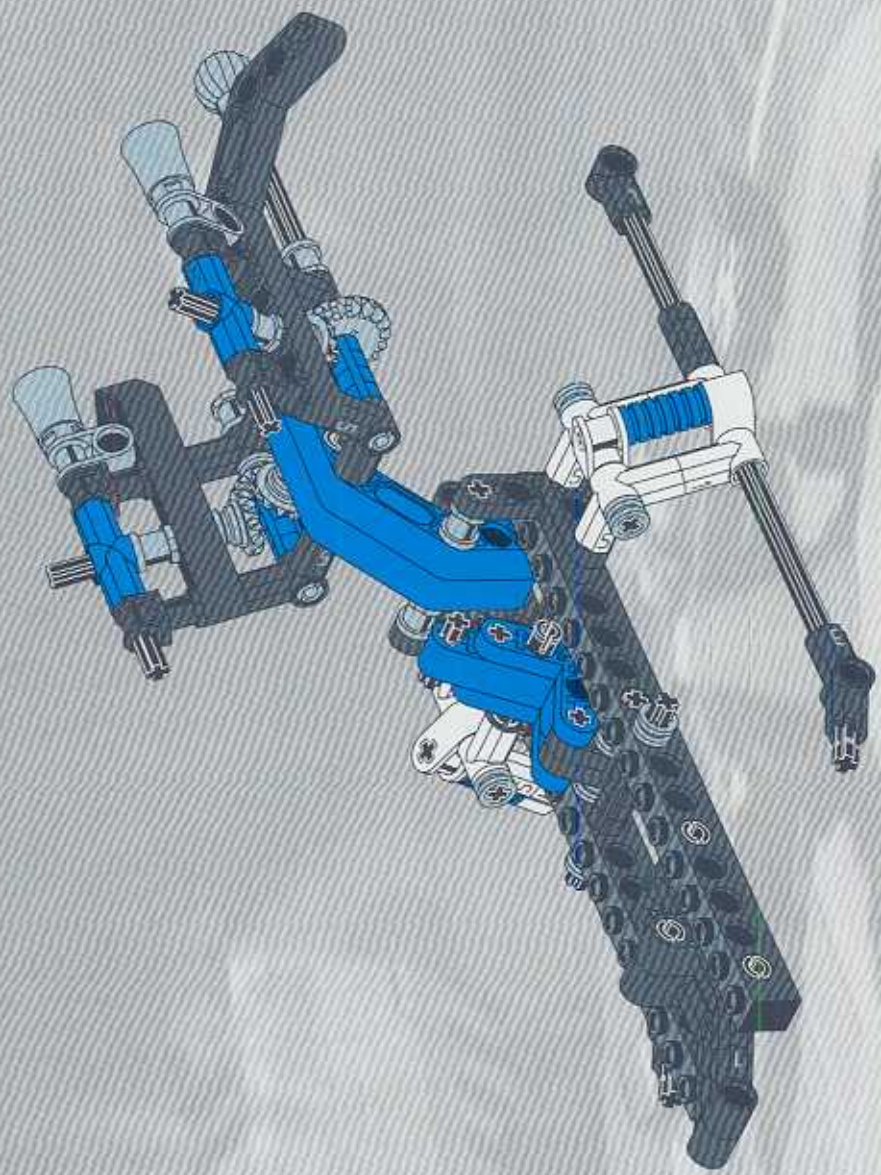

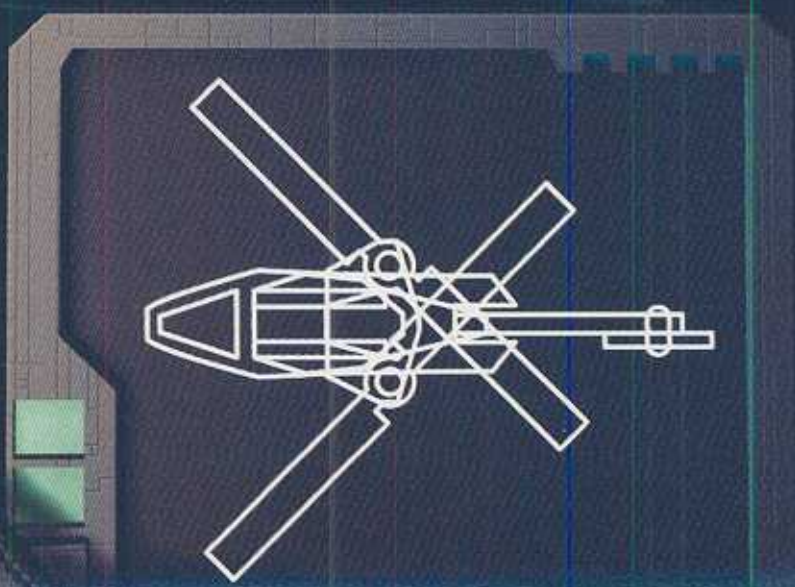
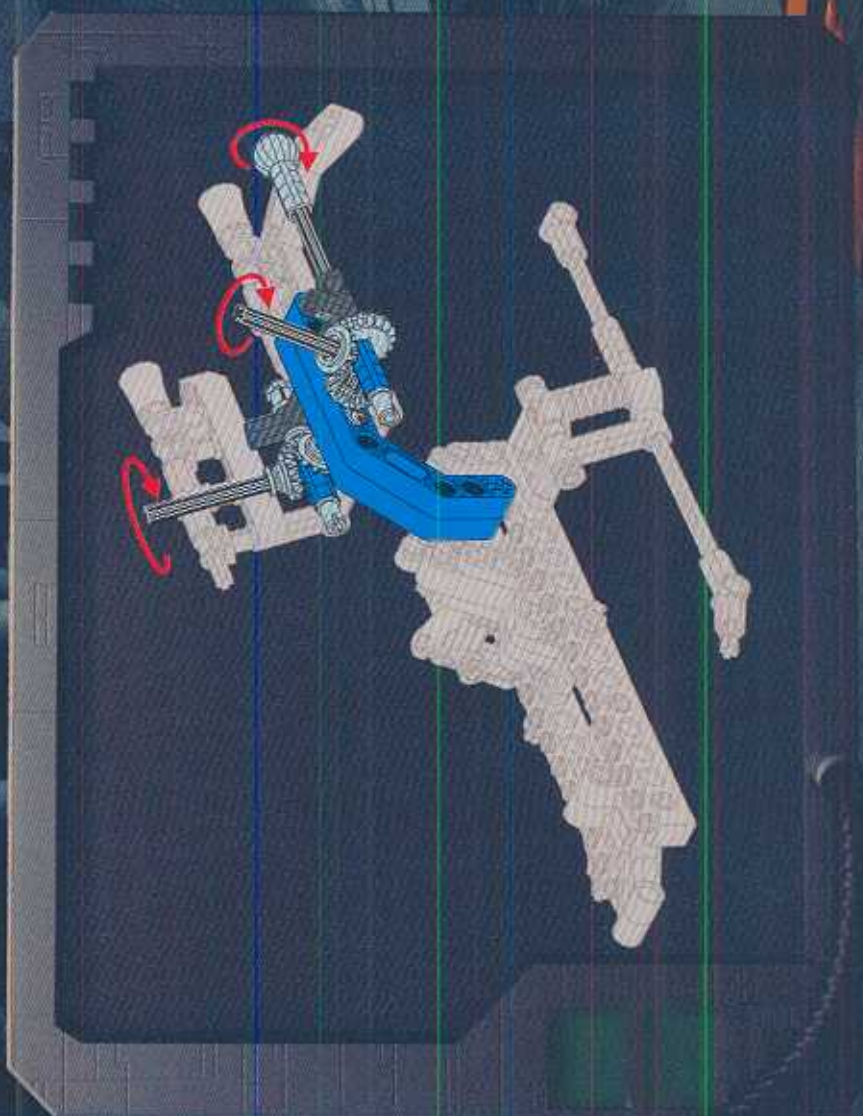







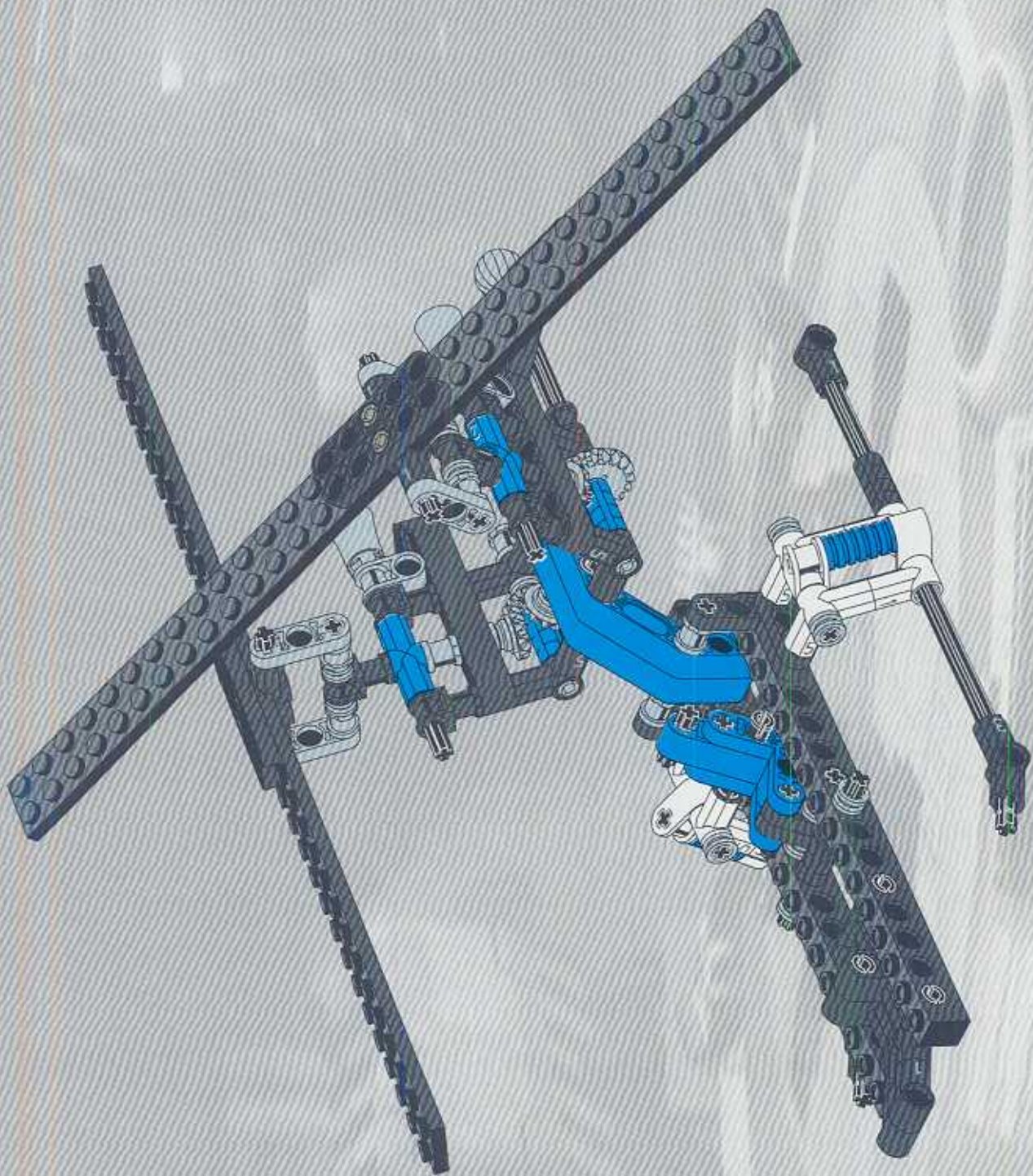





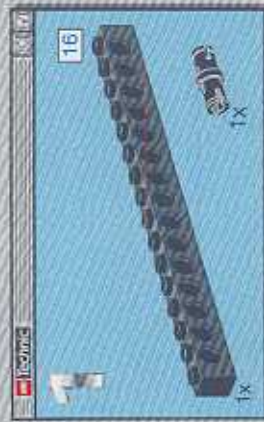
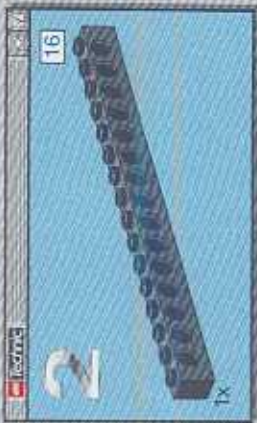
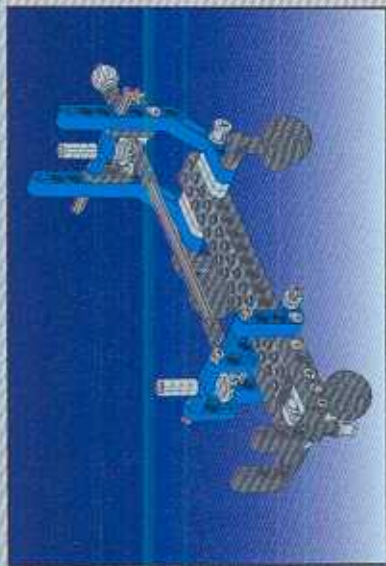

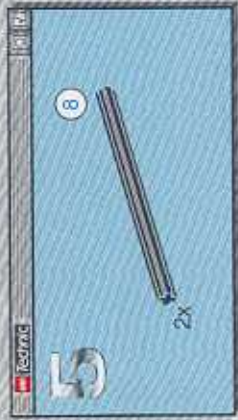
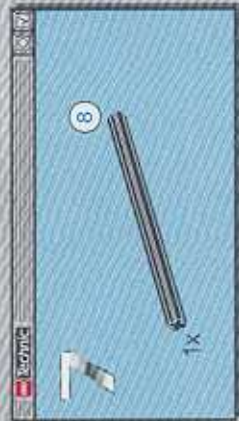
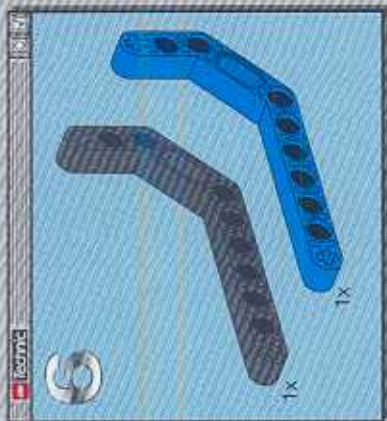



1



2



3



4



5

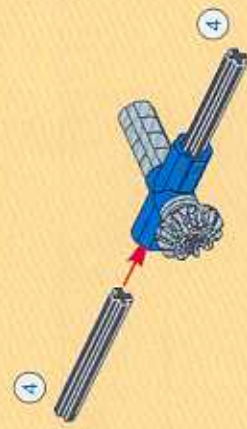

9

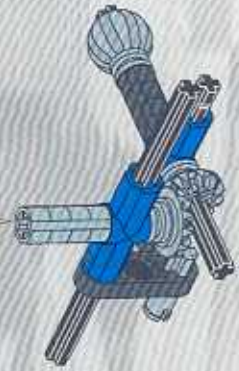

10

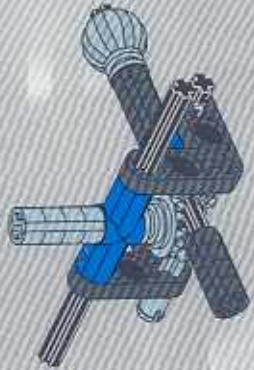

11

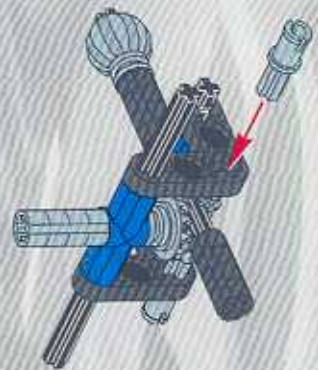

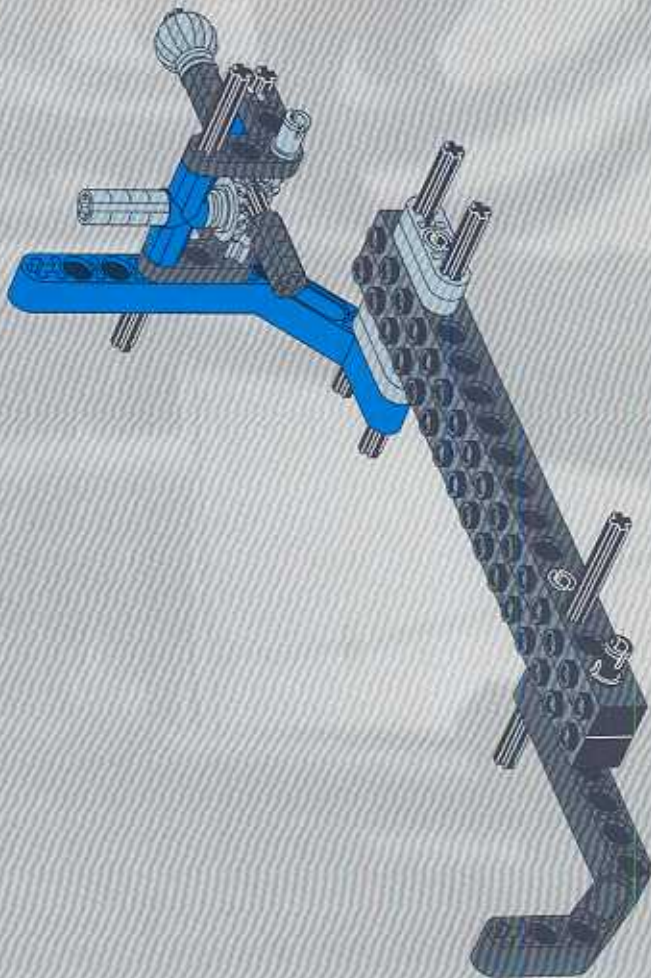



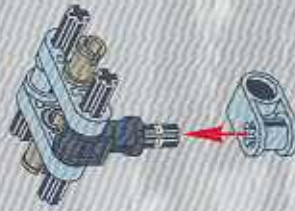
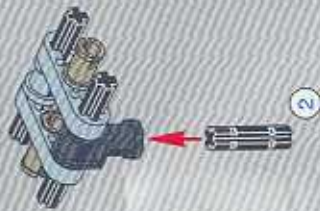
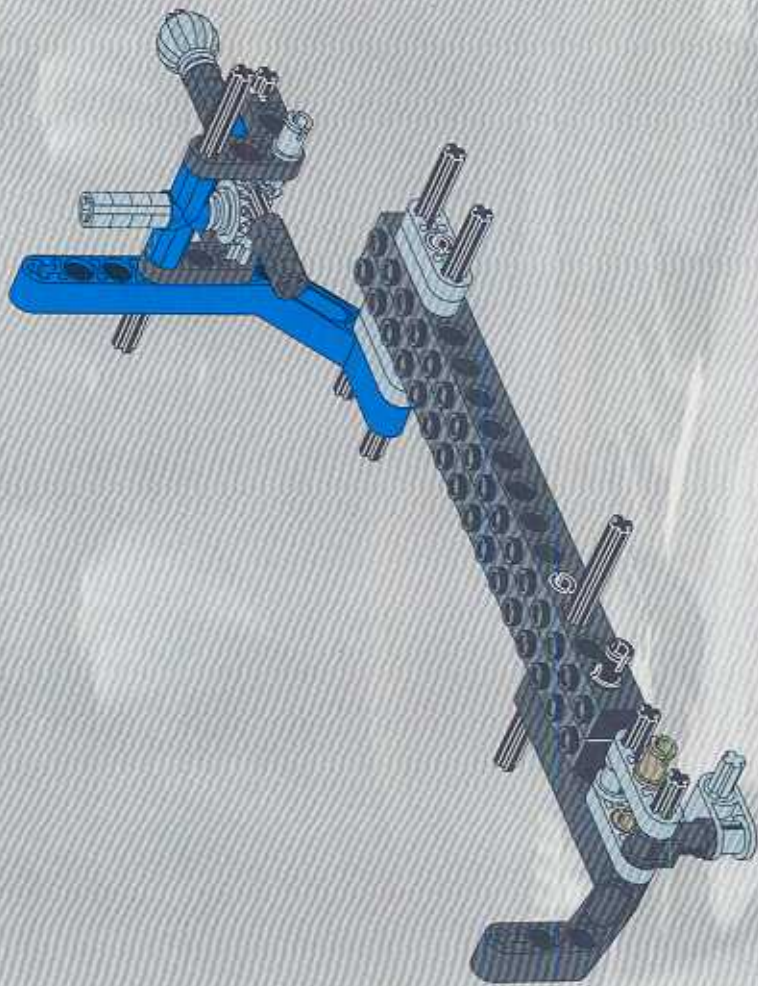

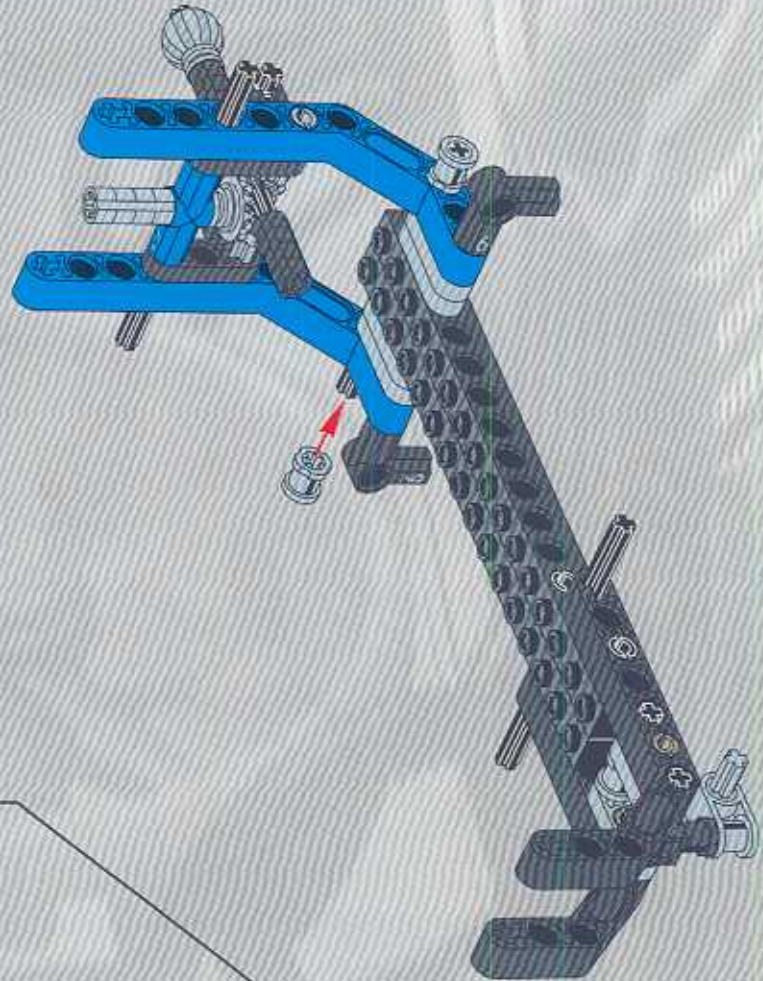
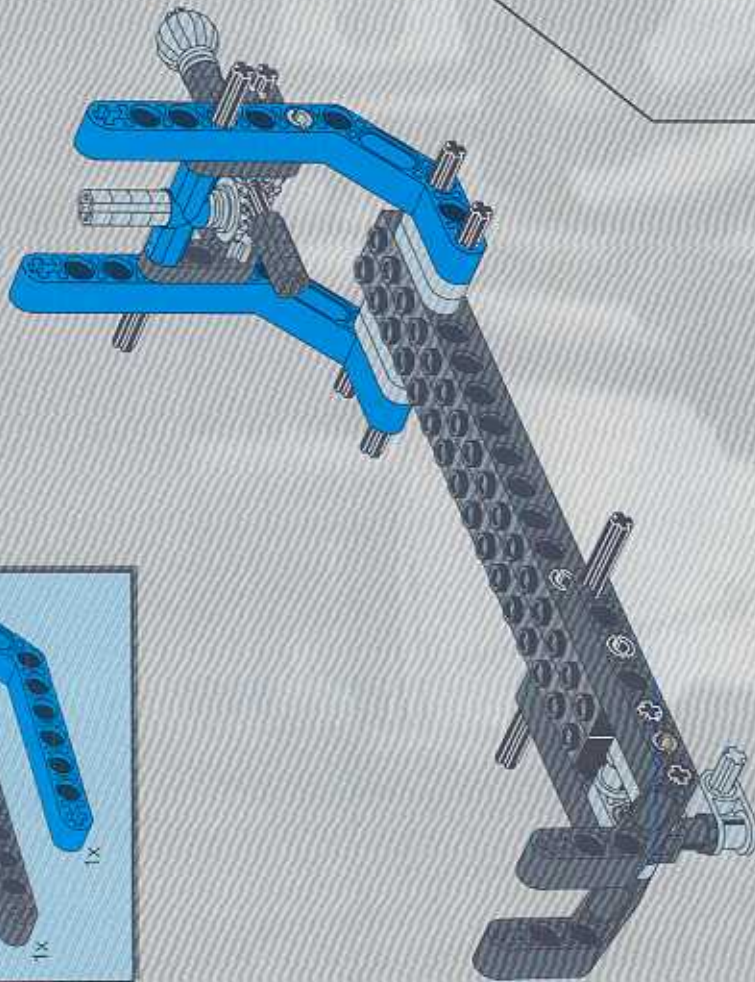

**13** 2x

2x

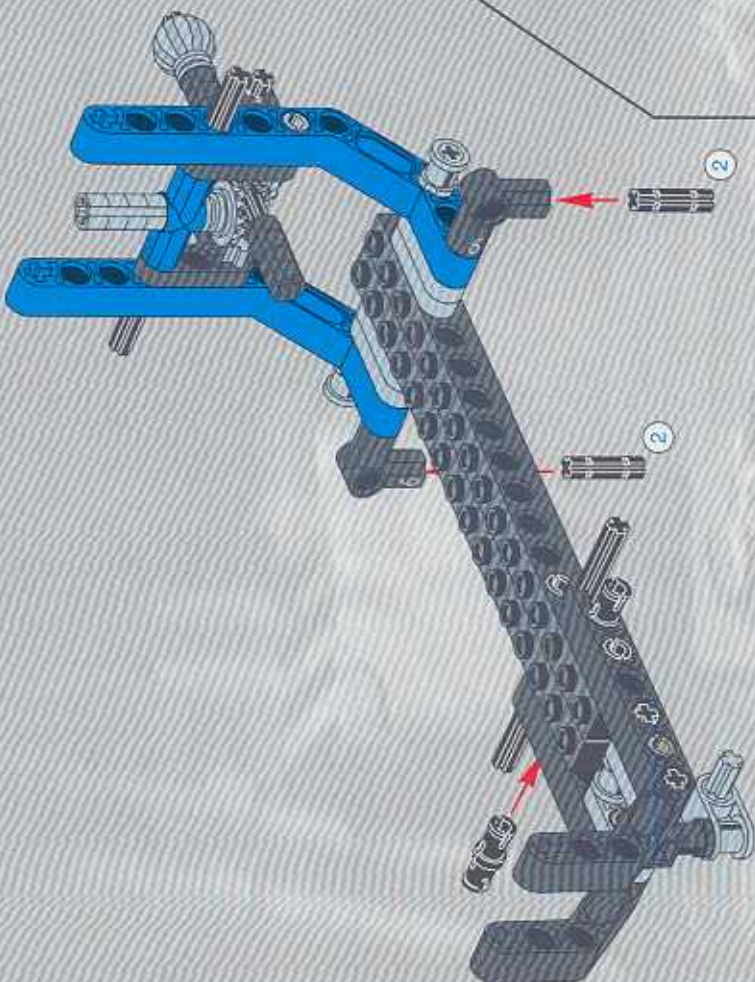

**12** 2x

2x

**2x**

2x

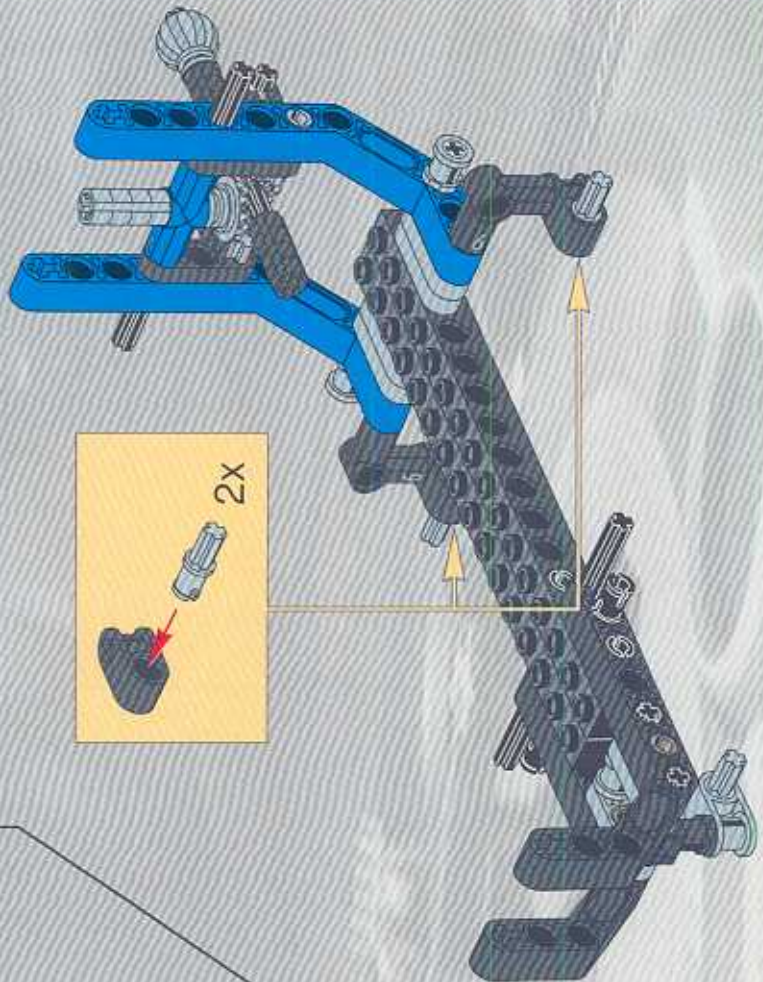

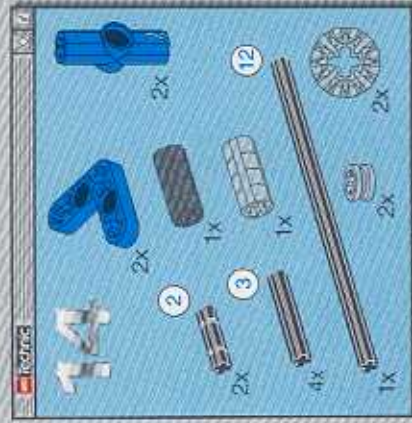
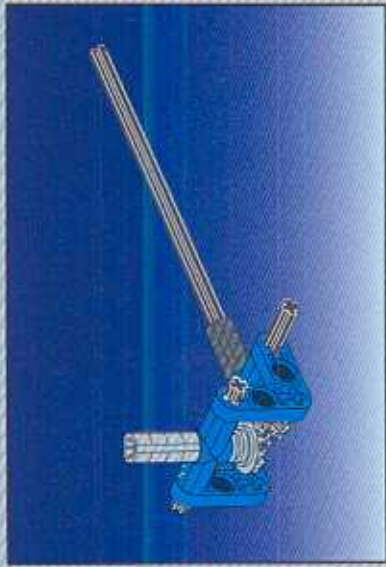

1



2

3



4



5



6



1

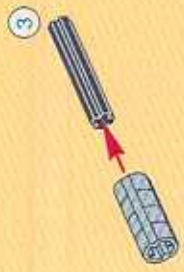

2



3



4



5



7



8

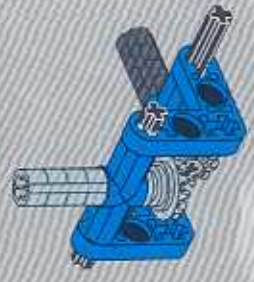

9



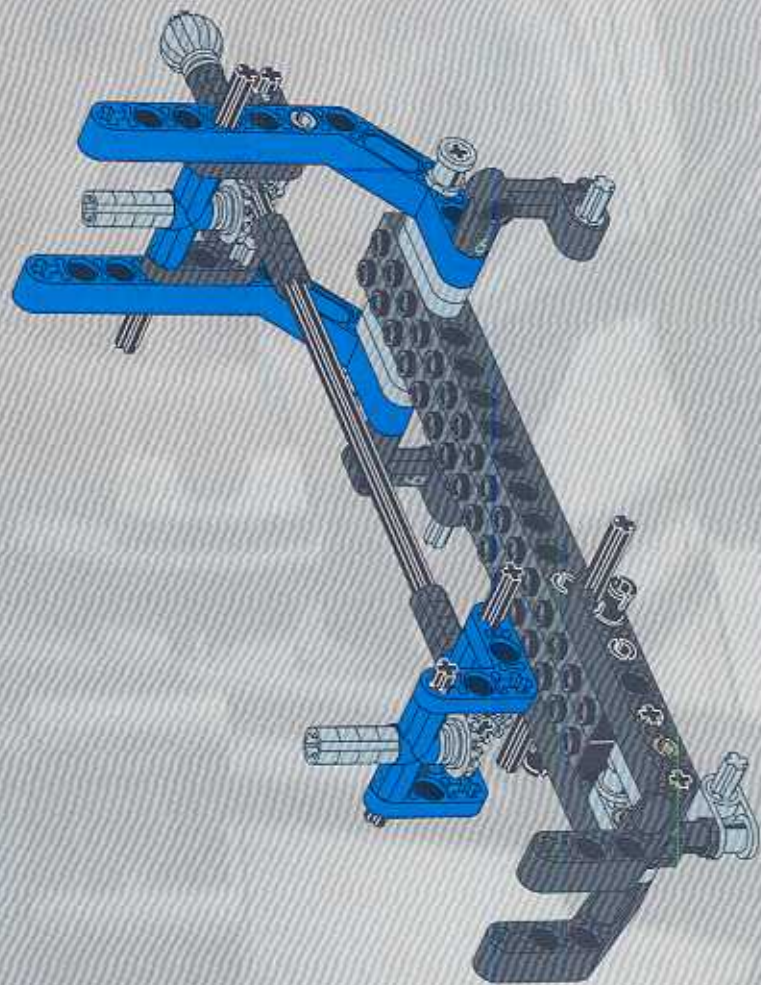



2x

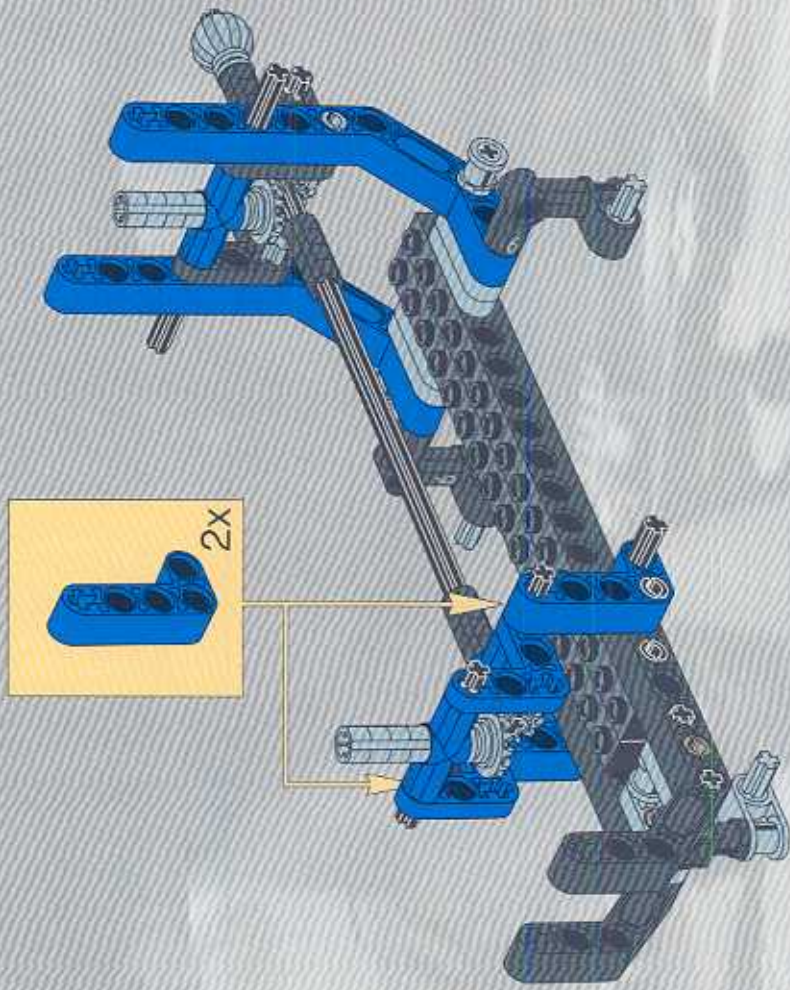

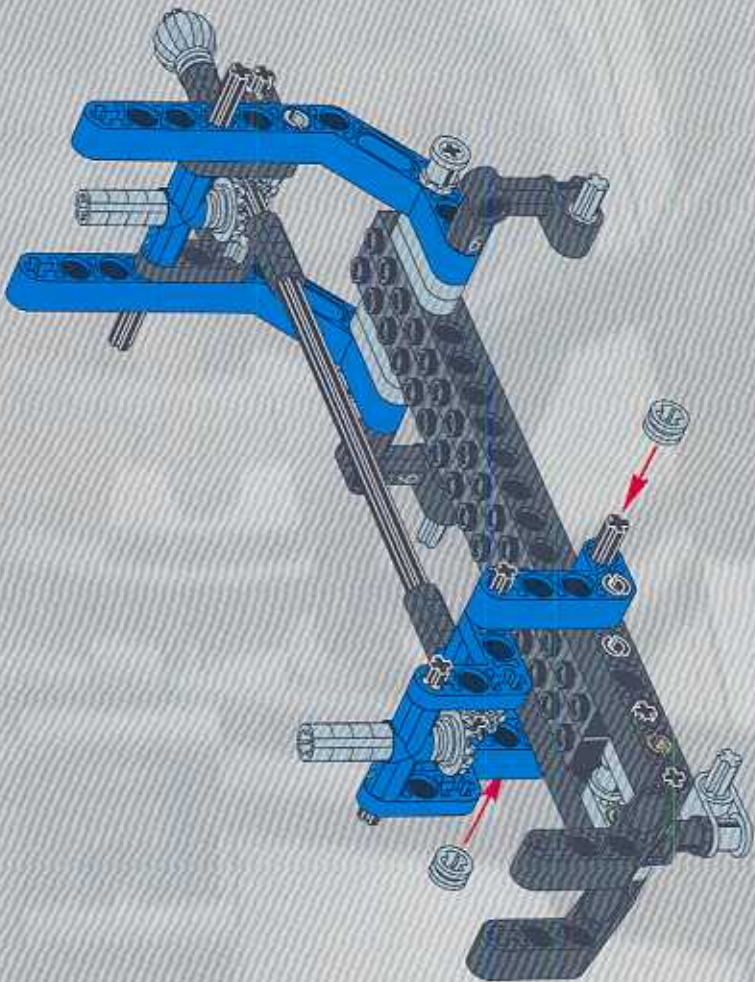

16

2x





