

8446

# TECHNIC

LEGO





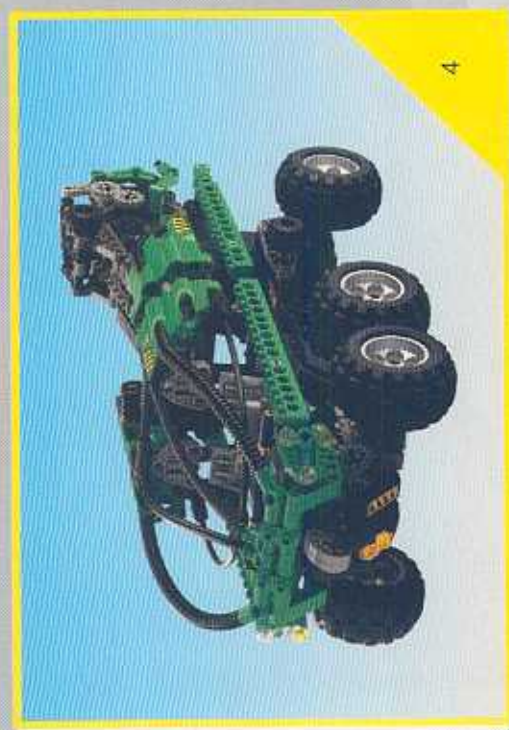

4



90



126



150



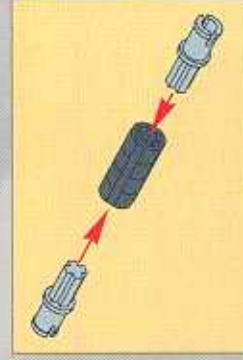
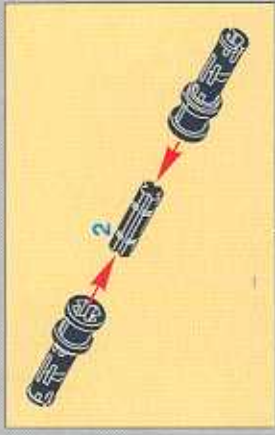



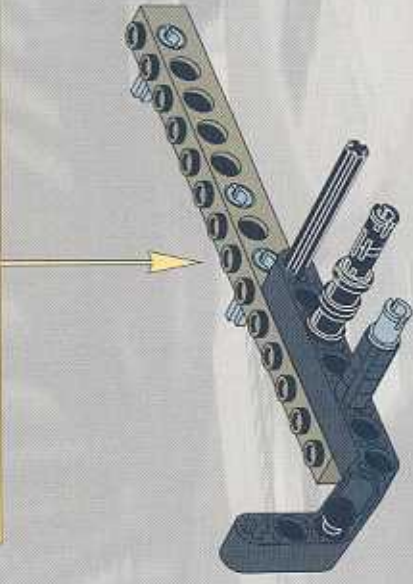
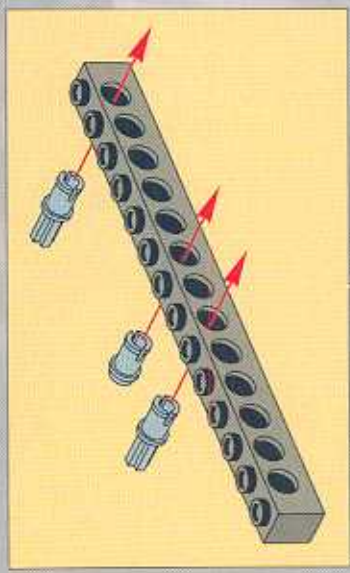
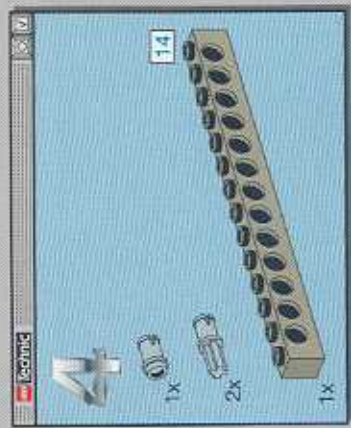
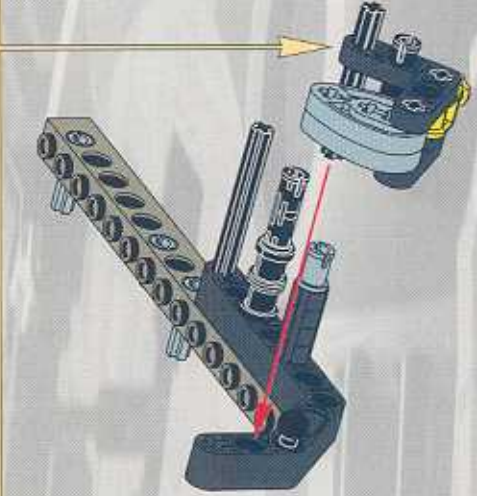
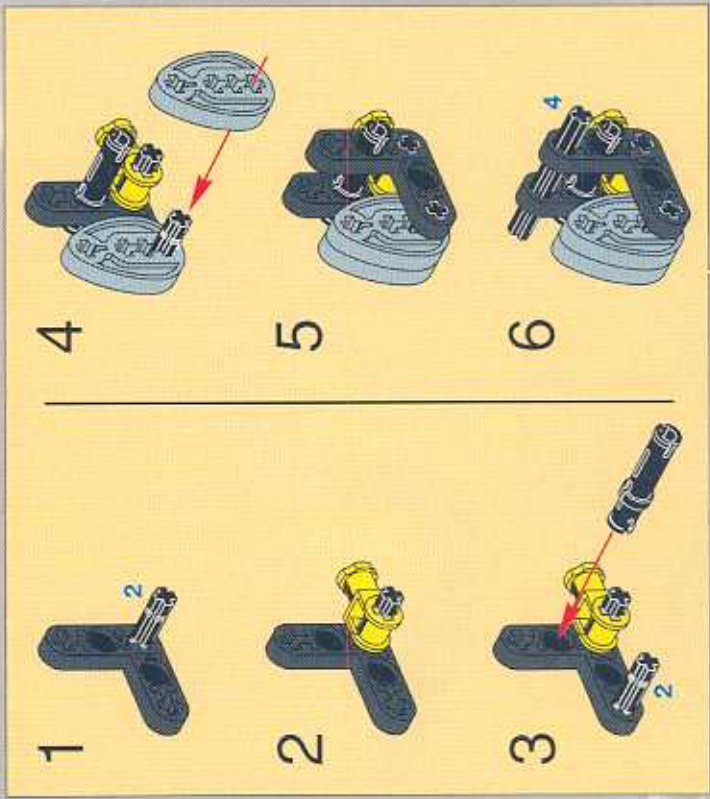



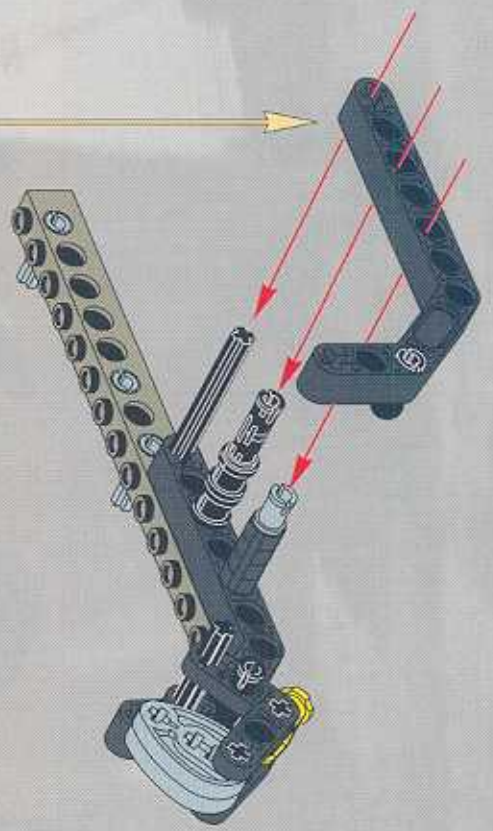
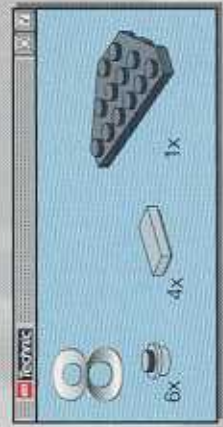
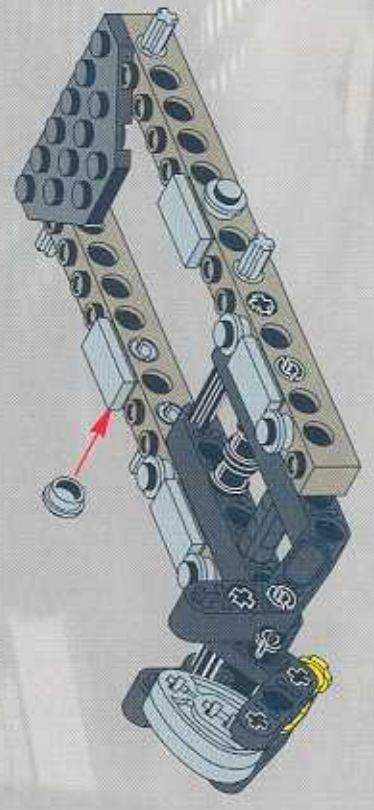
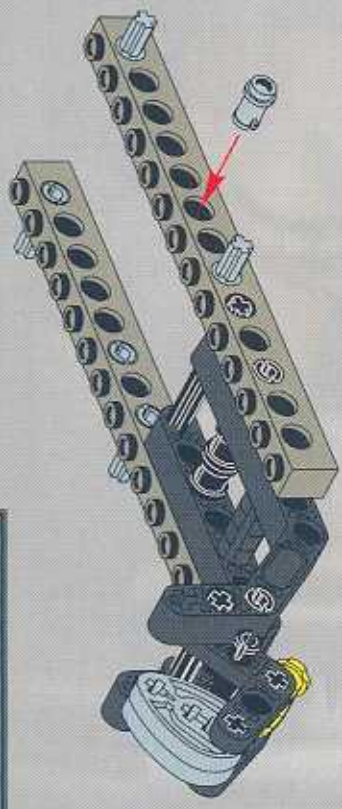



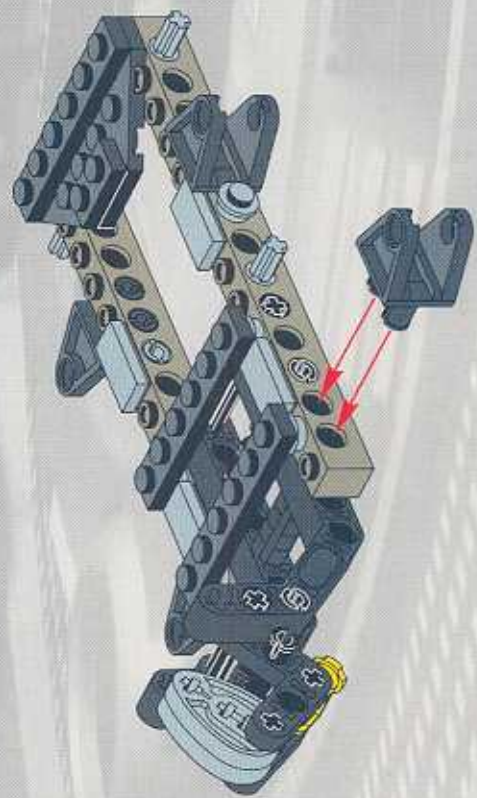
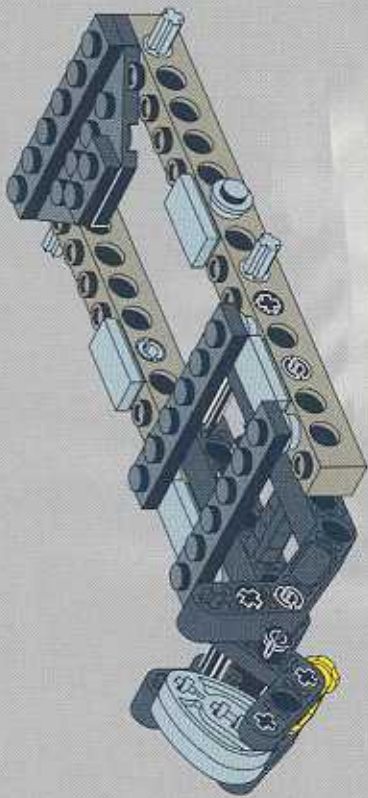
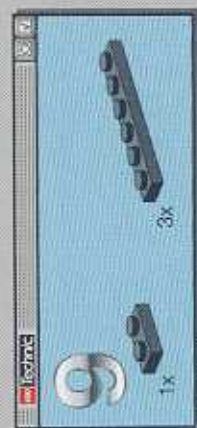
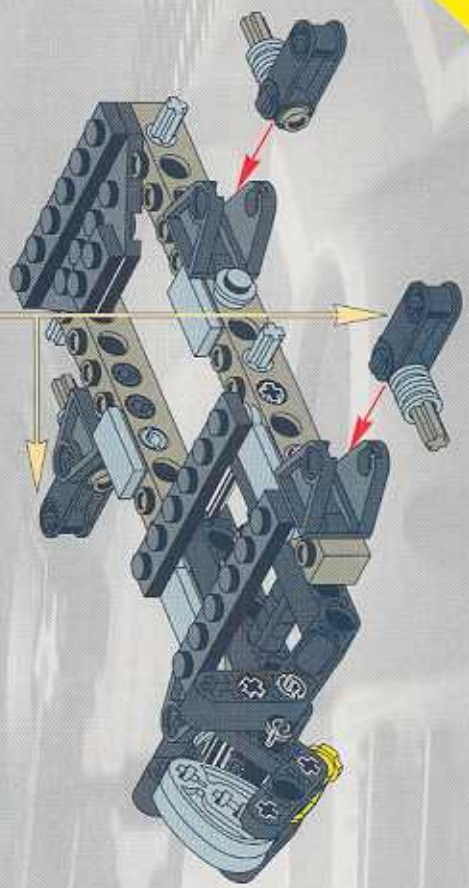
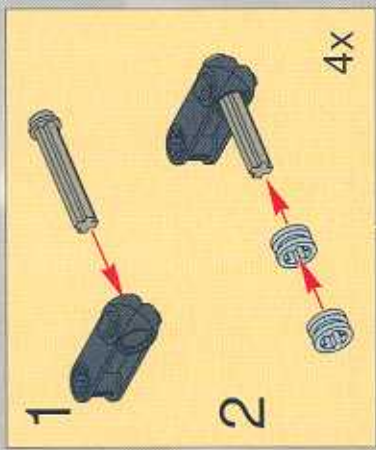



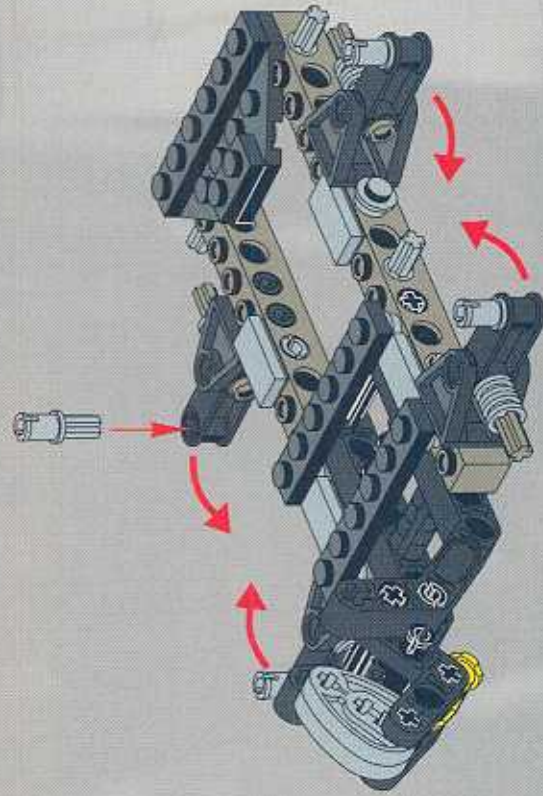
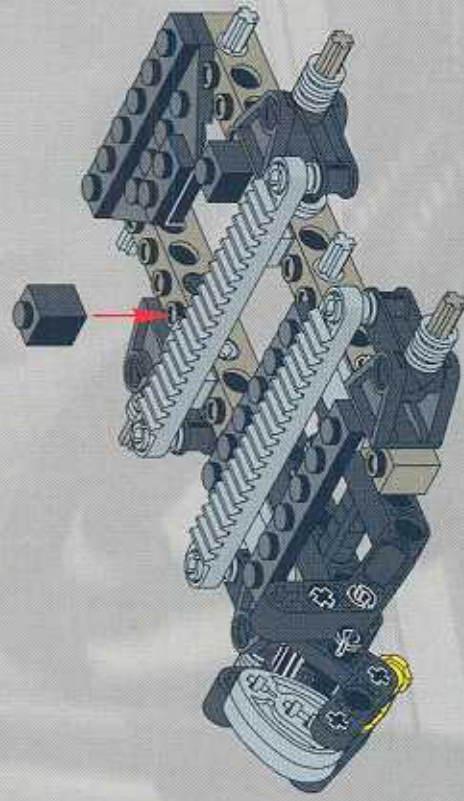







# 15

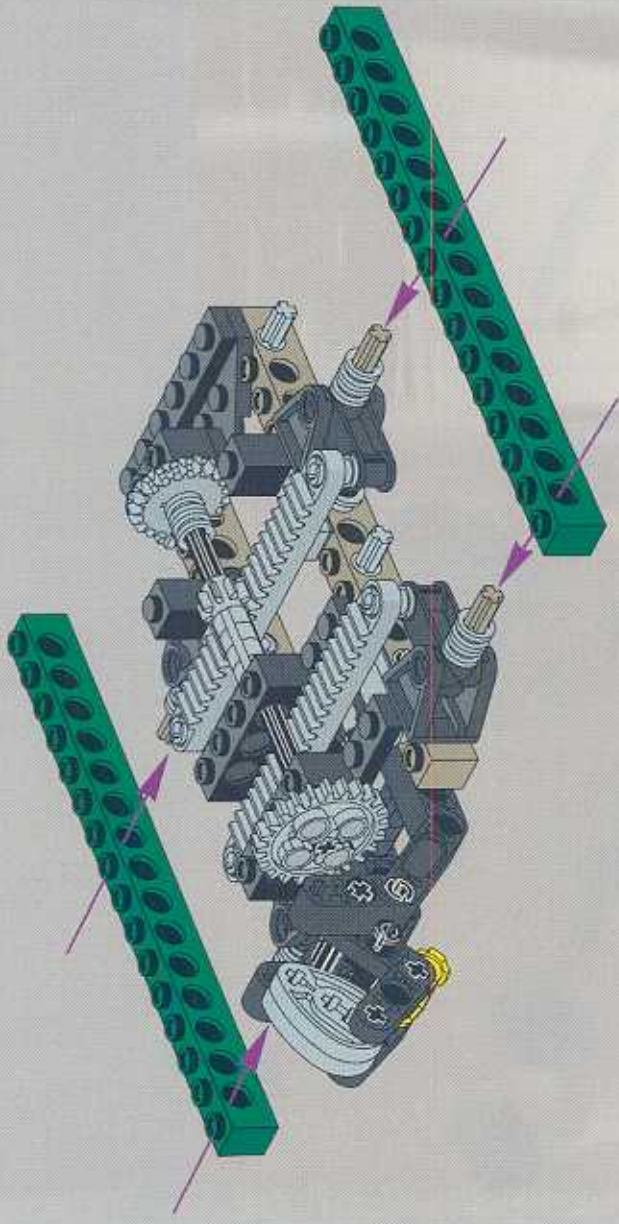

- 16**
- 2x
  - 1x
  - 2x

- 
- 
- 
- 

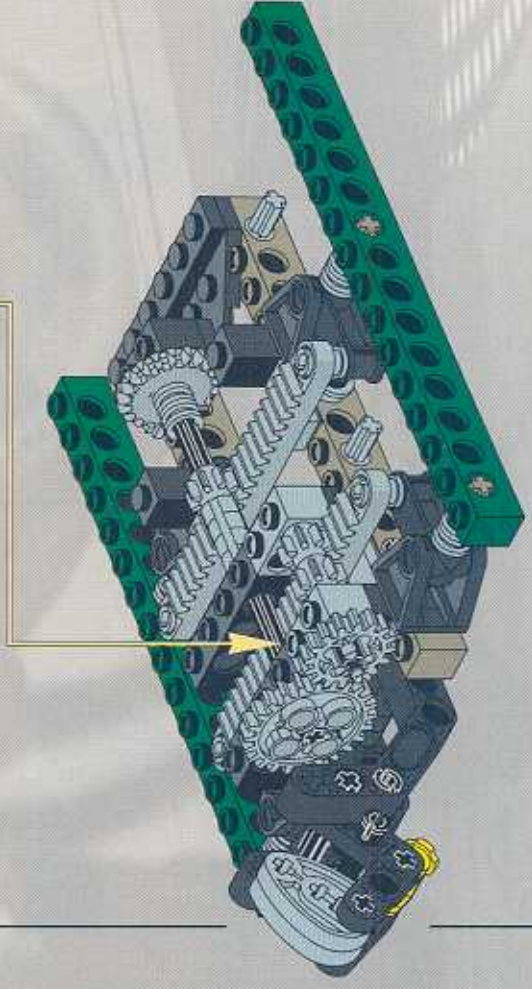







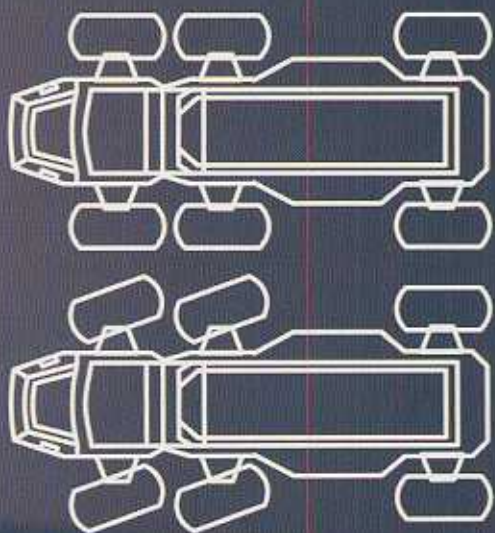
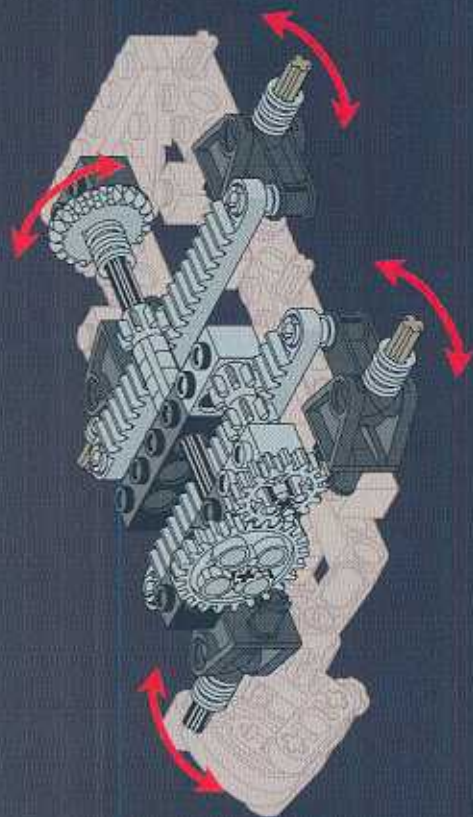



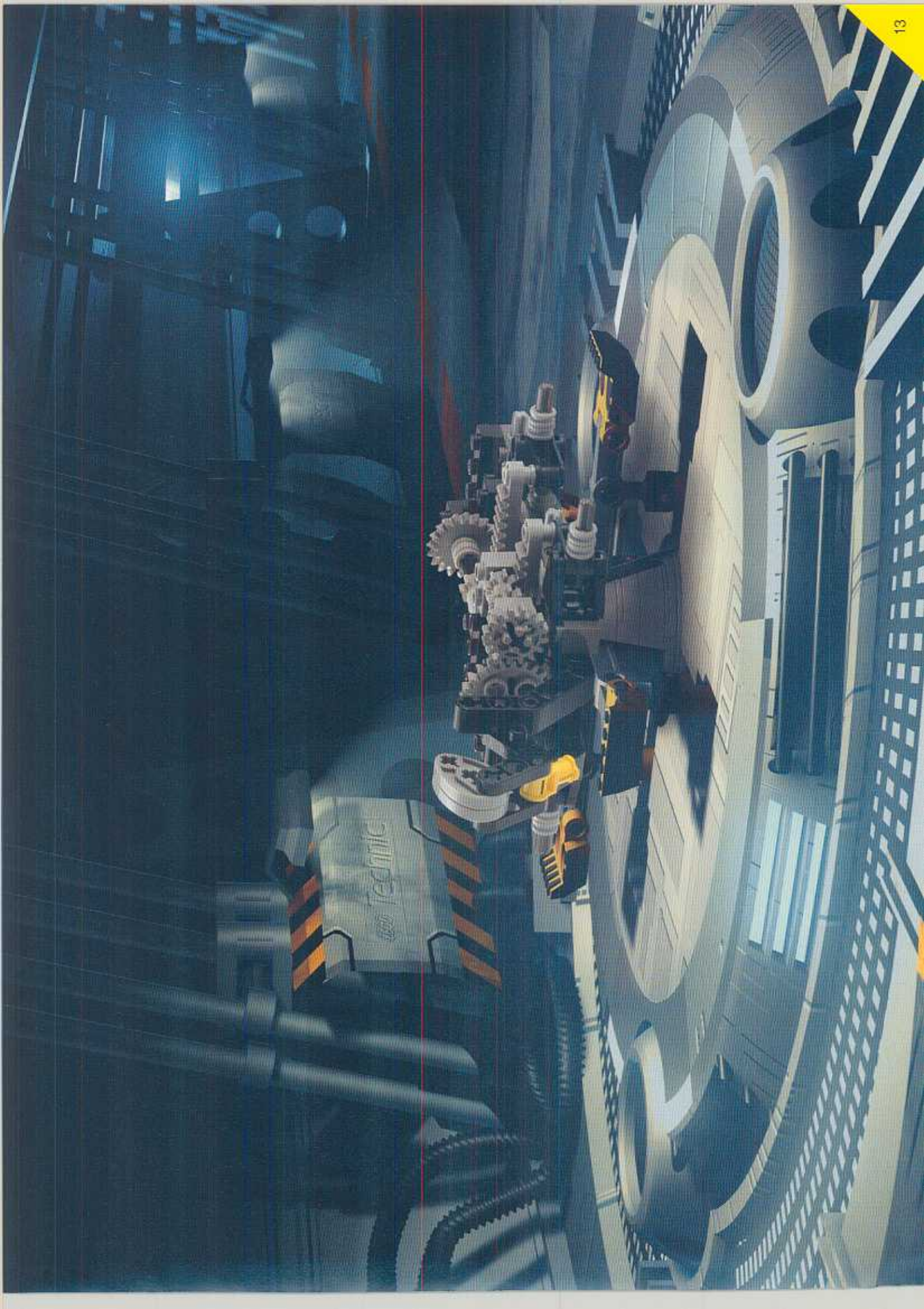



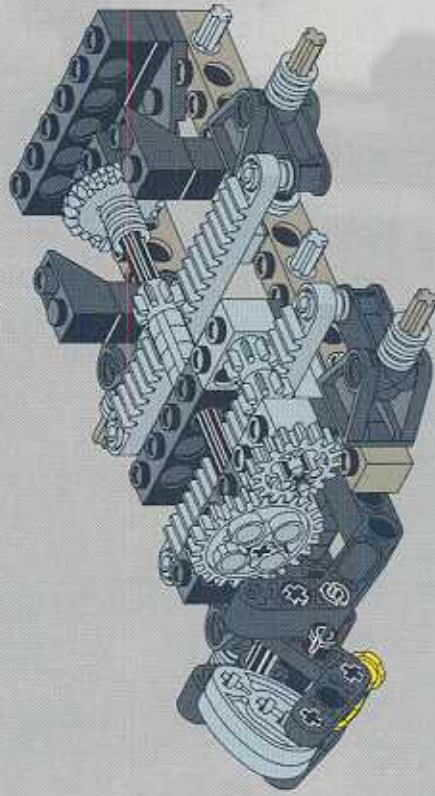
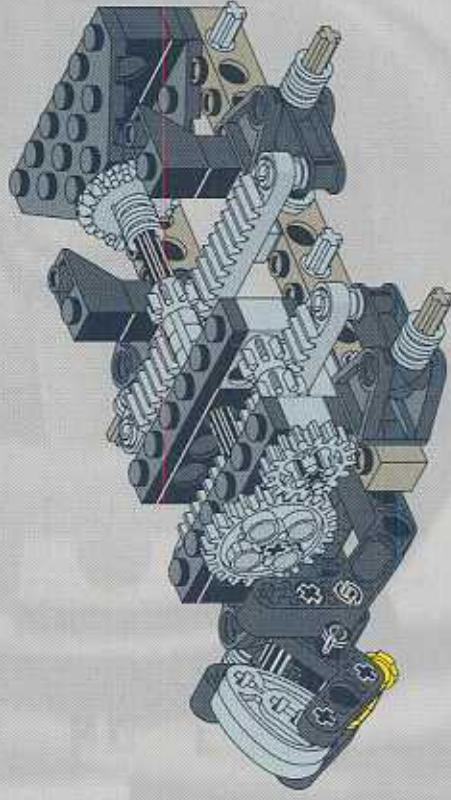



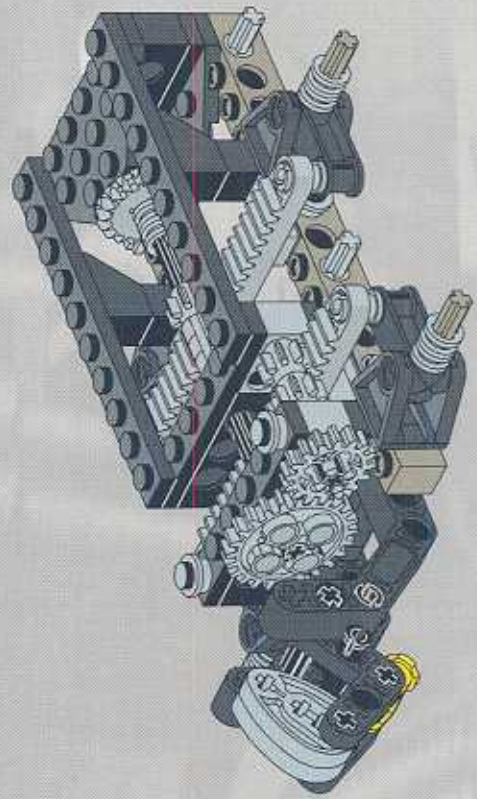
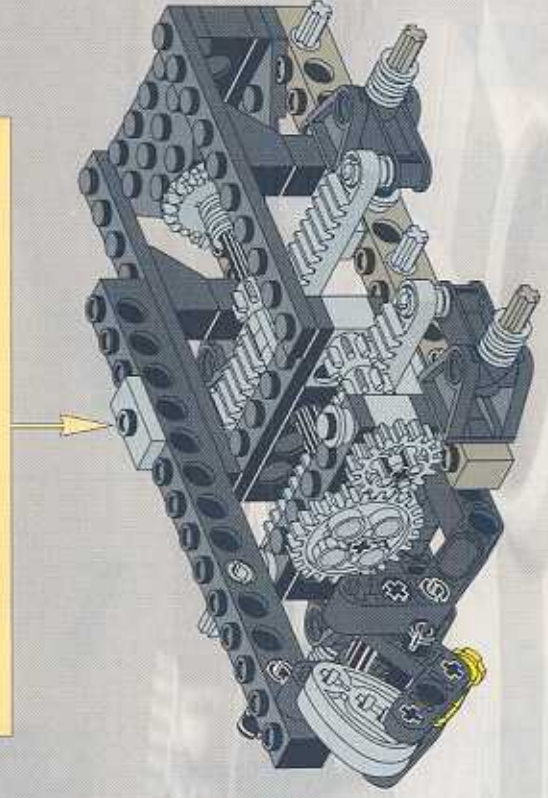
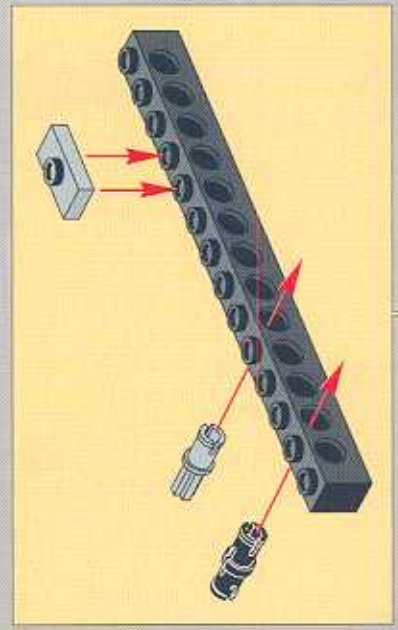
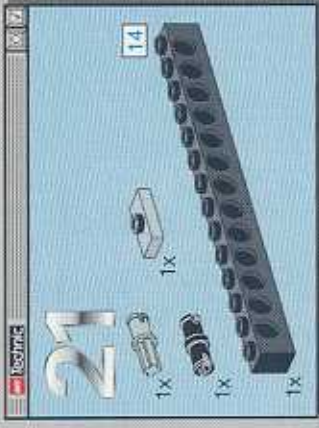



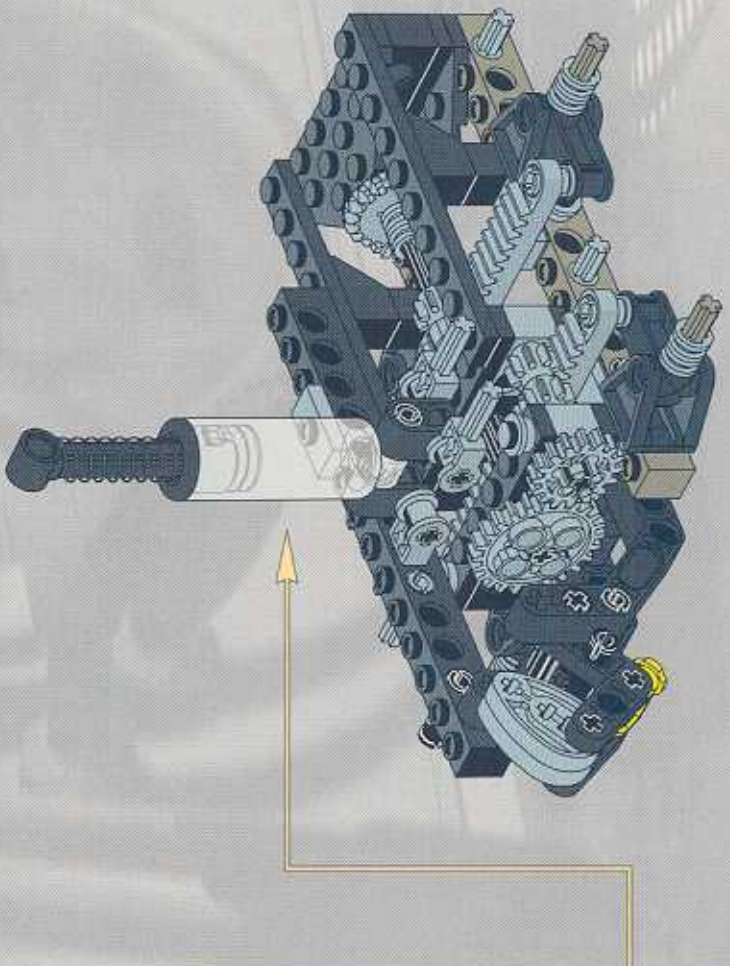
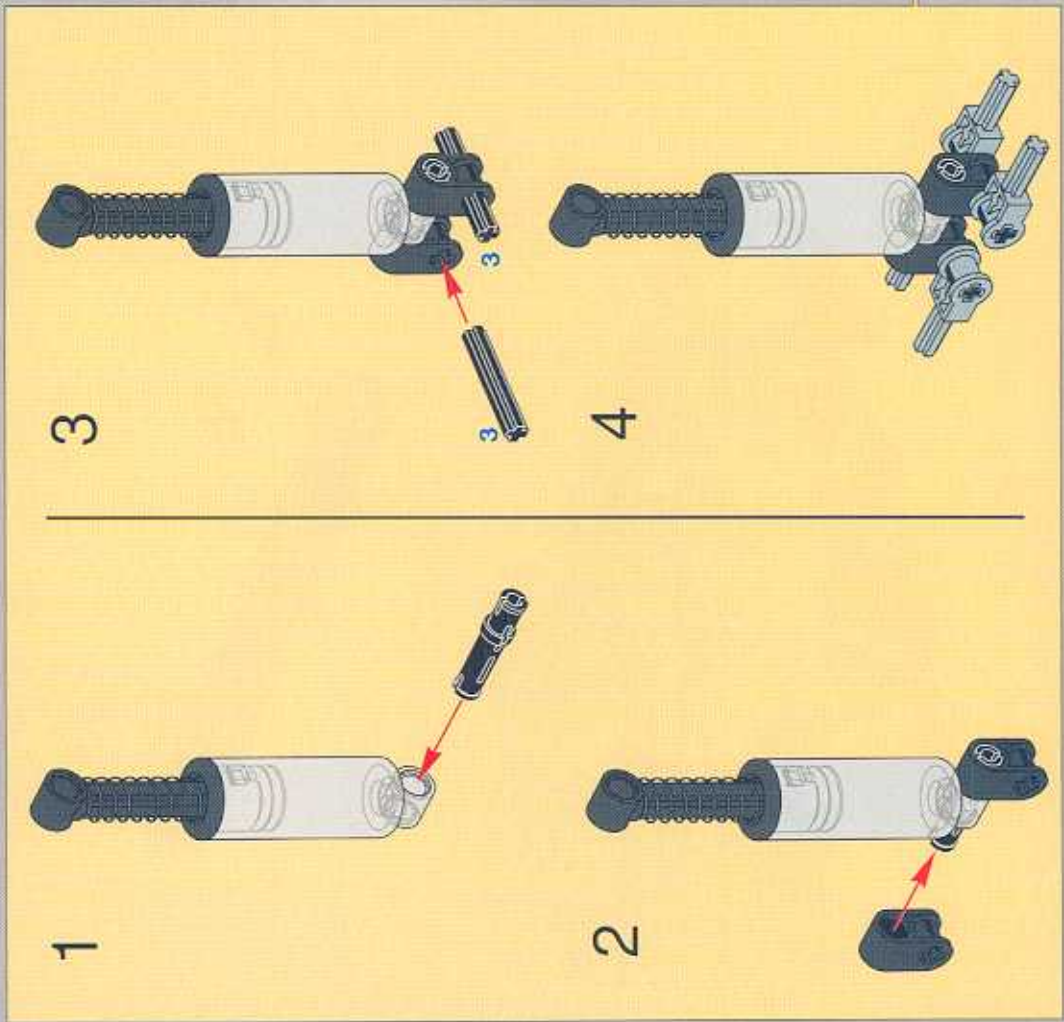



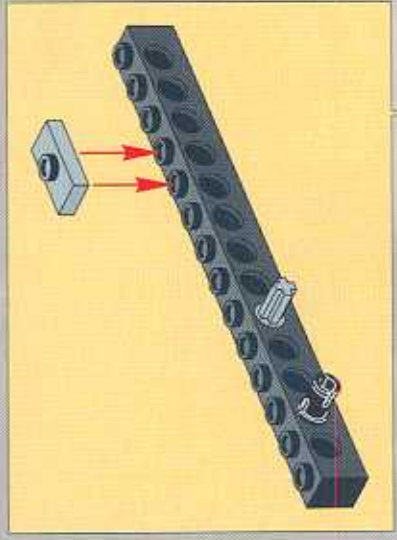
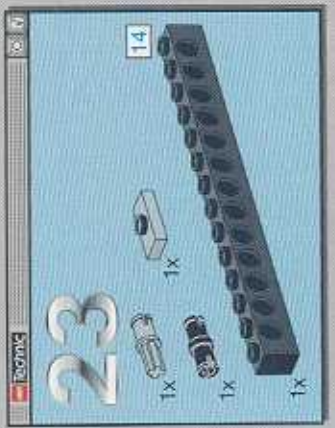
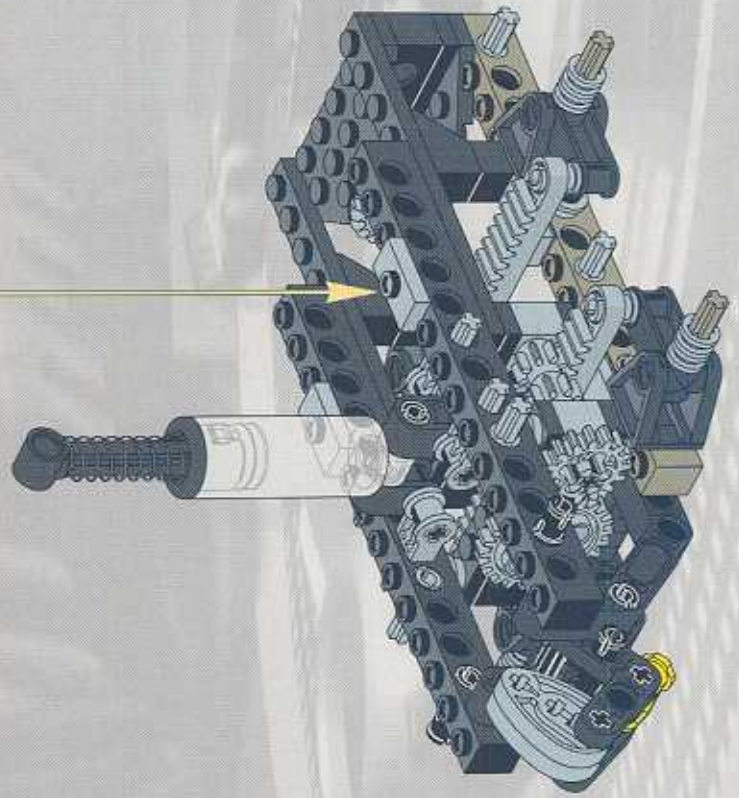
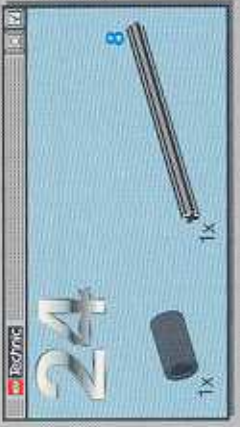
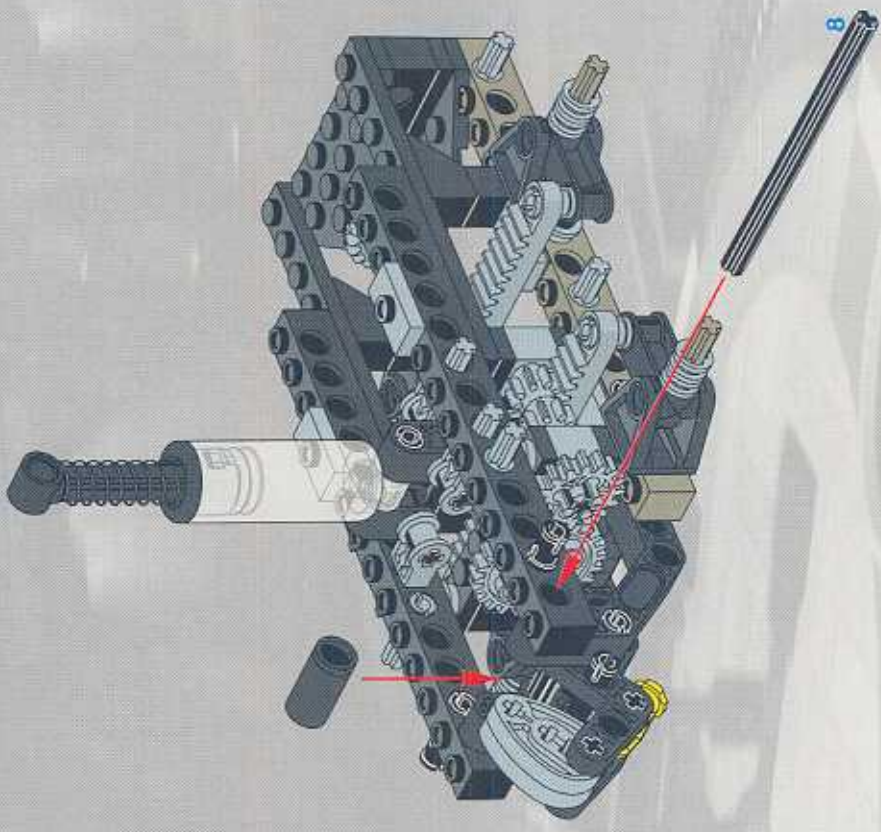



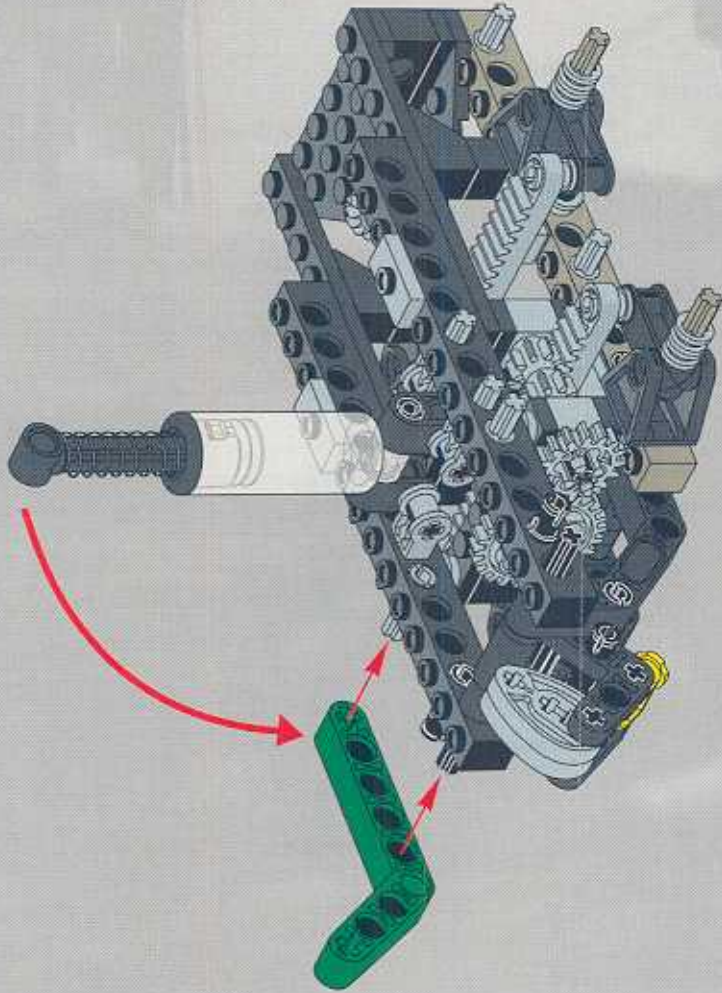
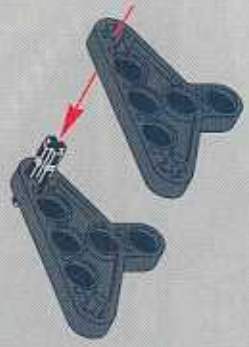



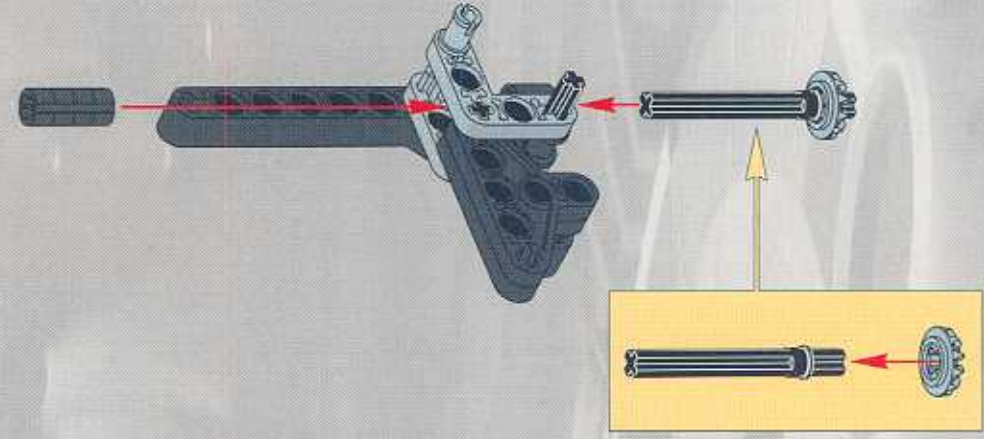
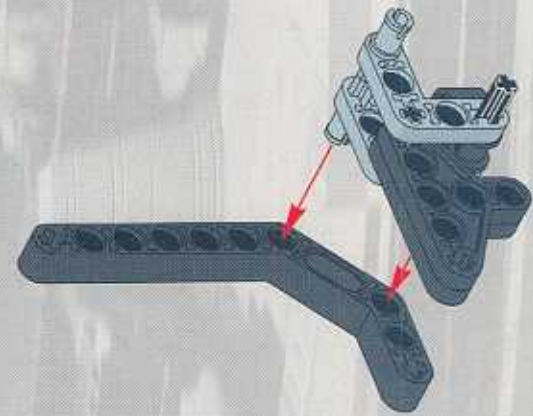
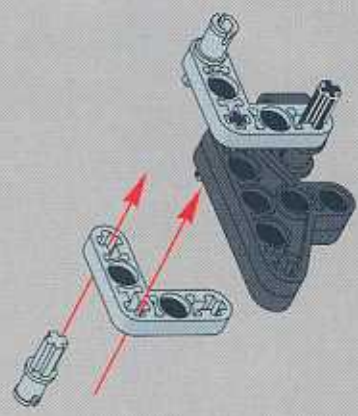
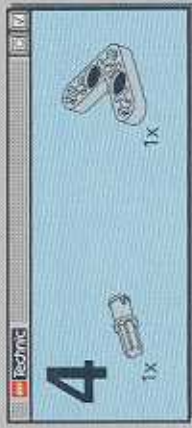
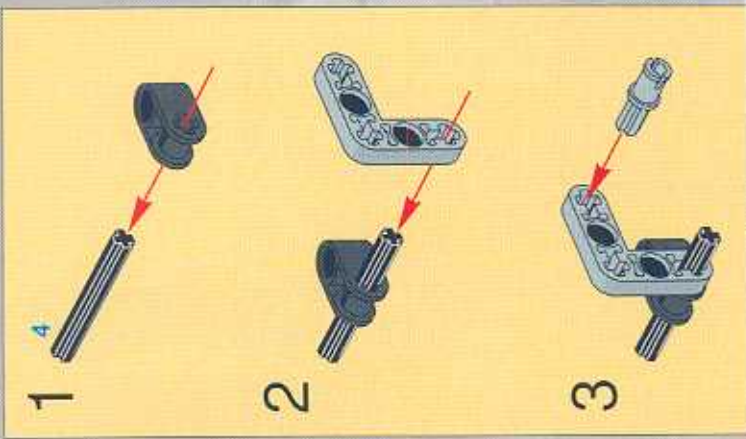



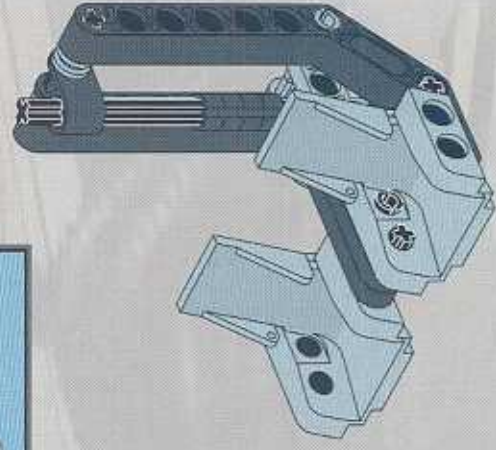
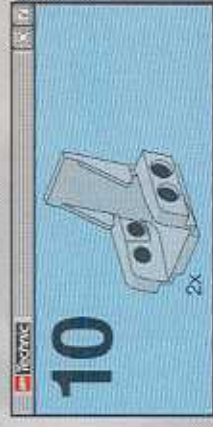
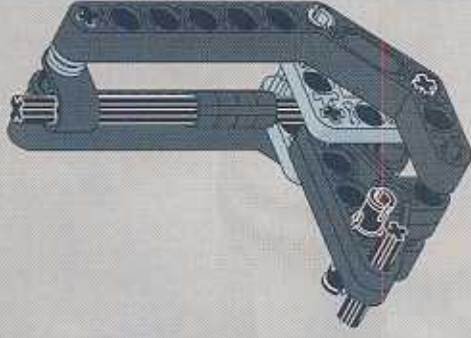
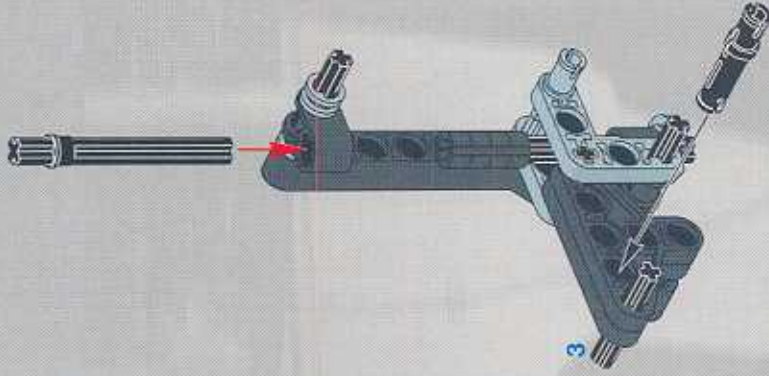
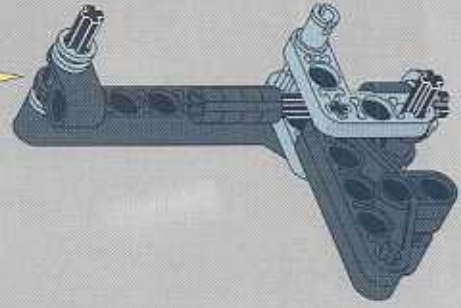
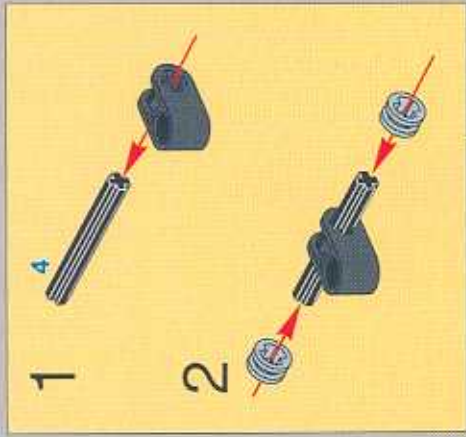



LEGO Technic

26

LEGO Technic

11 <sup>1x</sup>

LEGO Technic

27

2x

1x

6

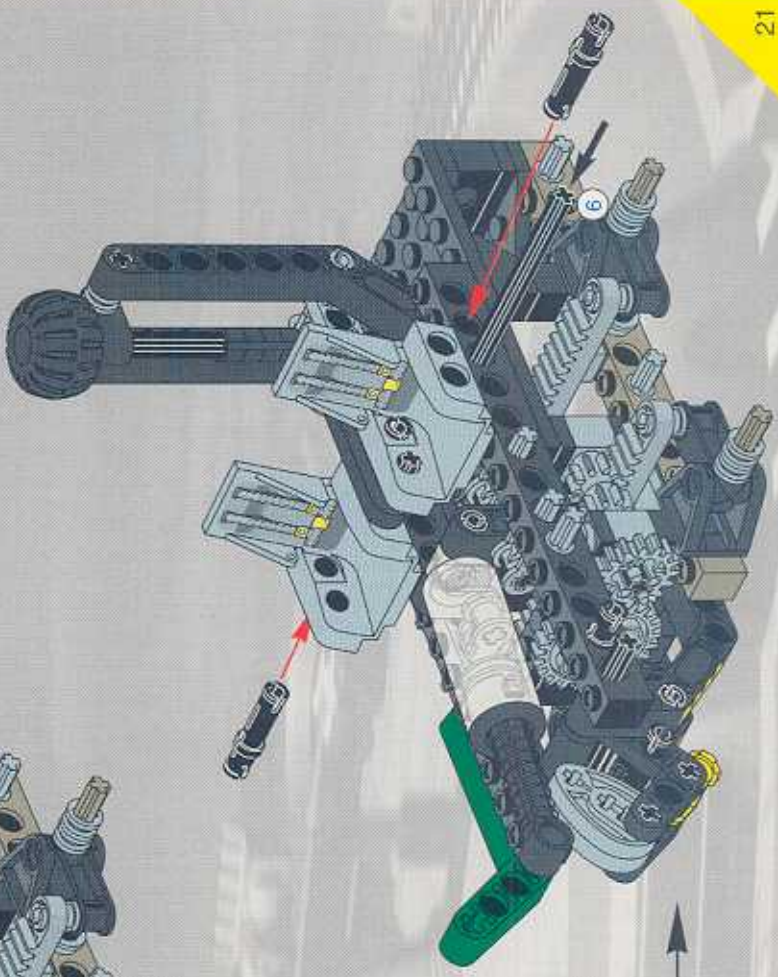
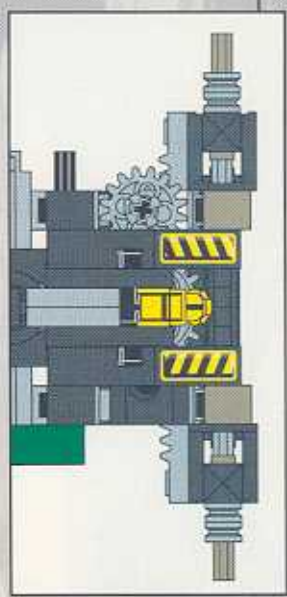
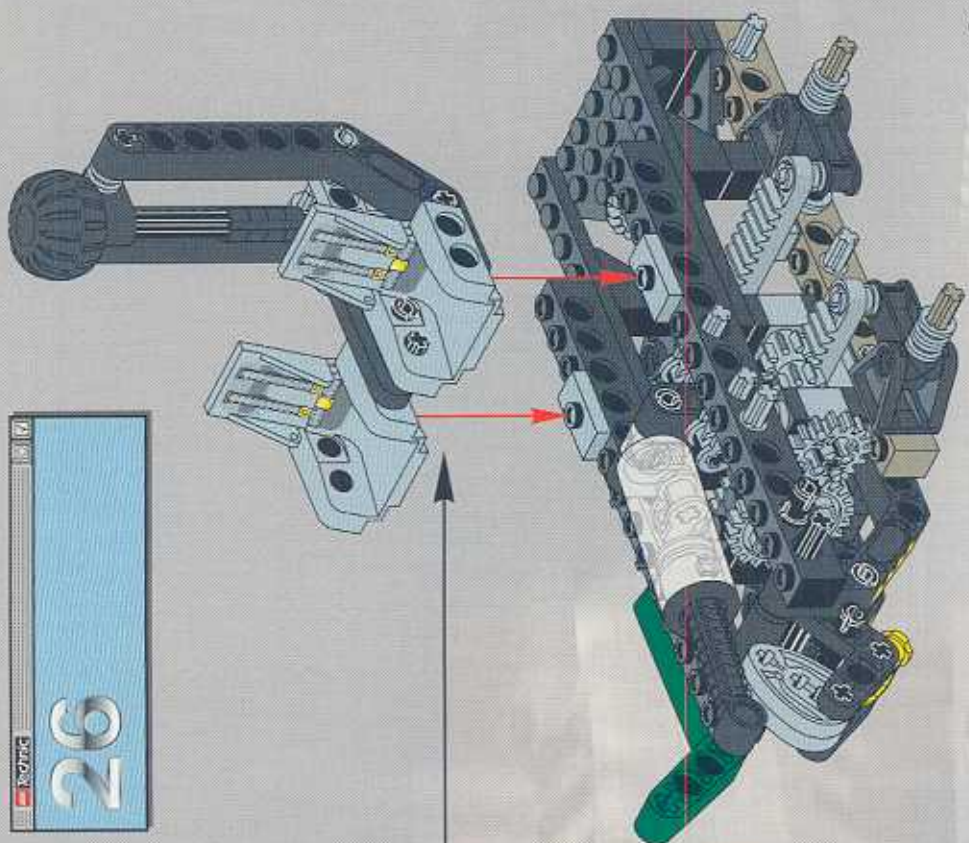



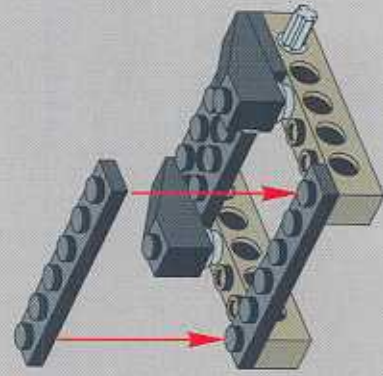
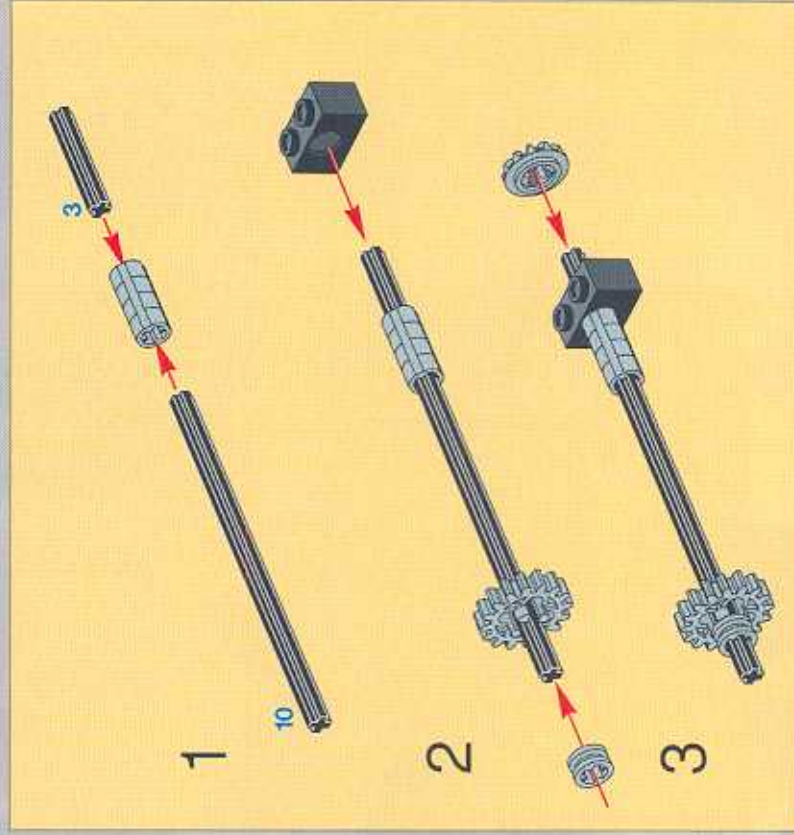
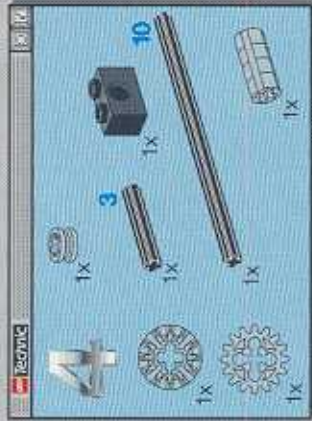
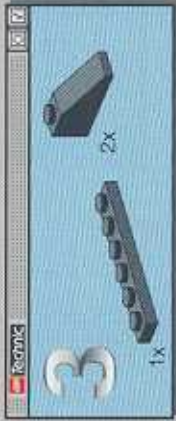
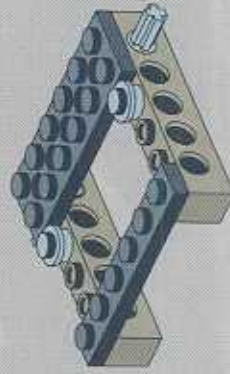
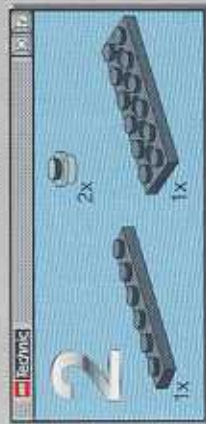
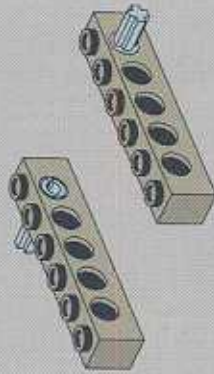
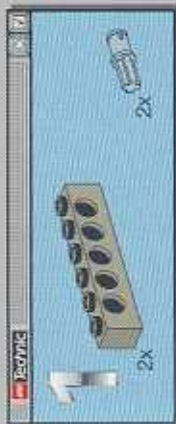



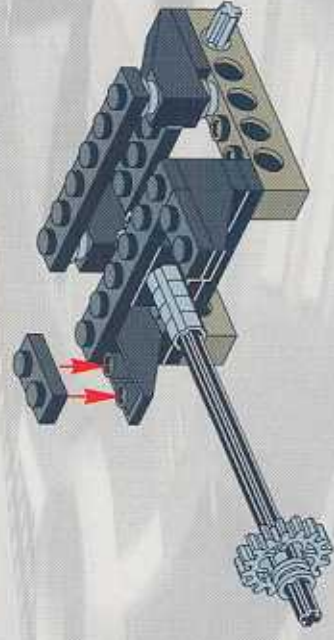
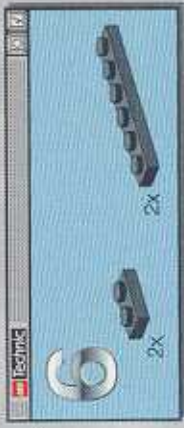
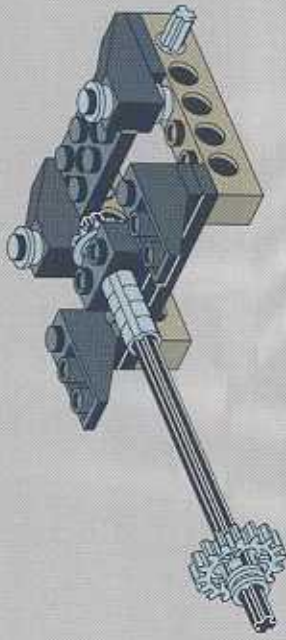
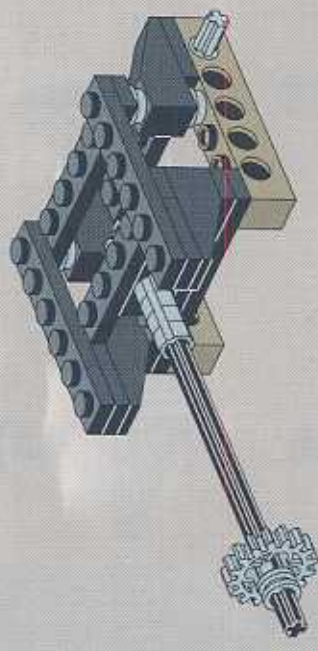
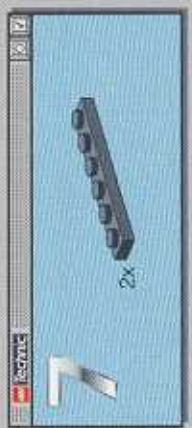







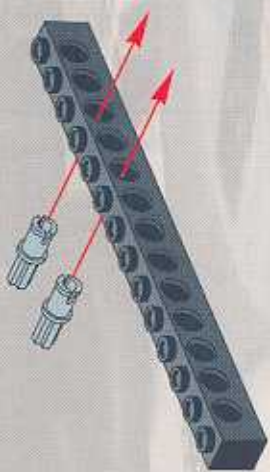
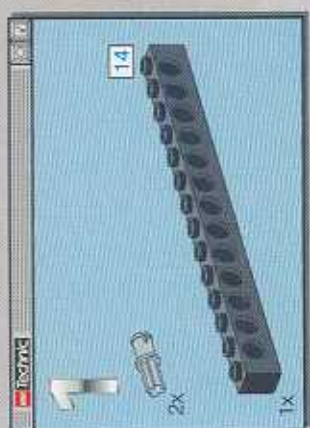
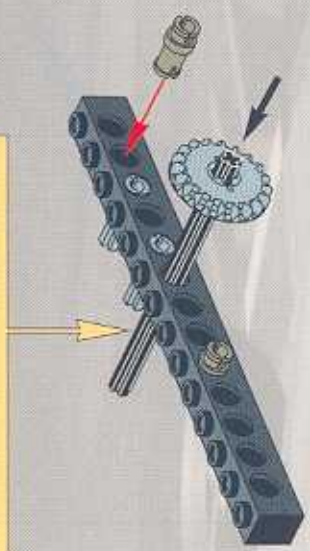
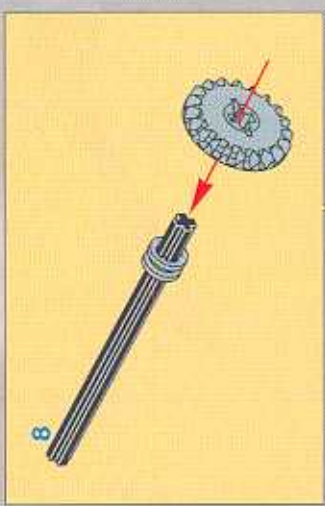
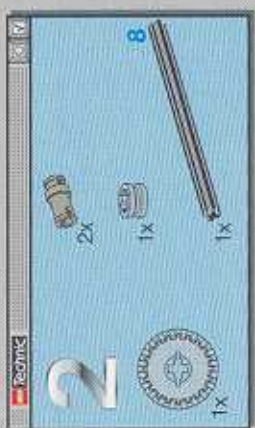











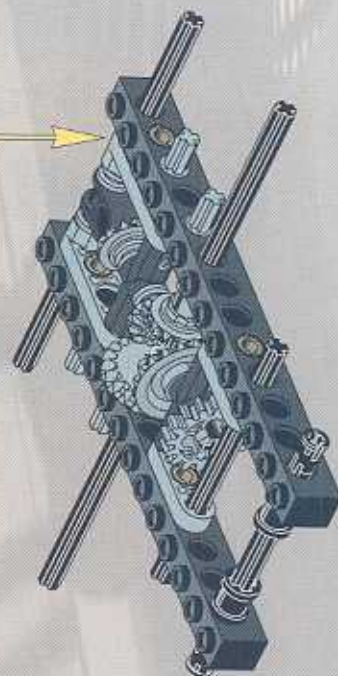
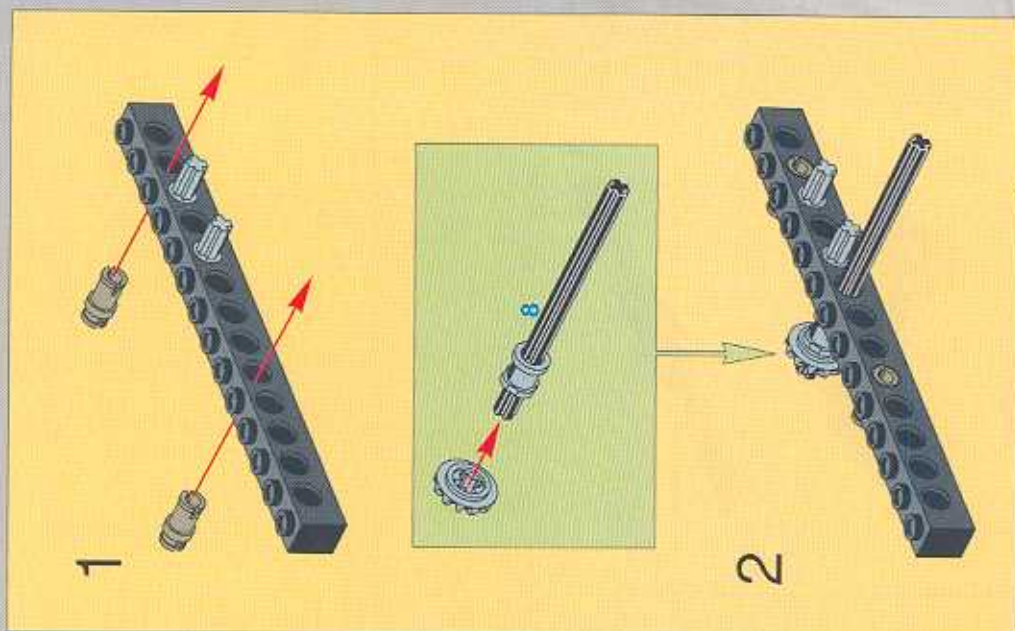
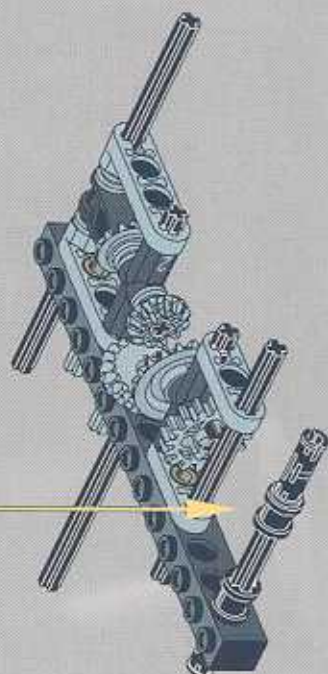
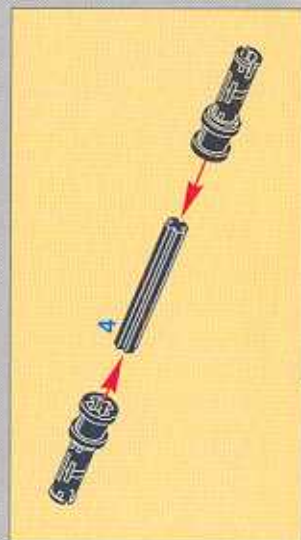
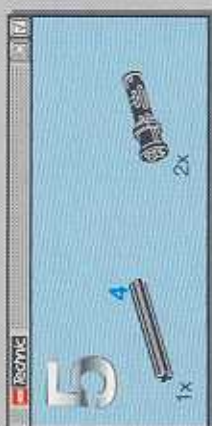
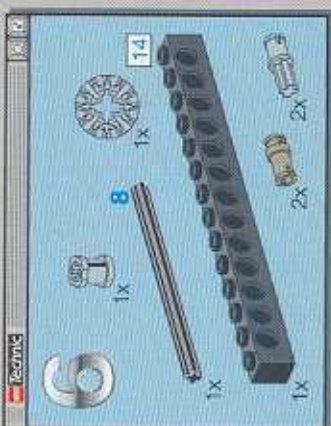



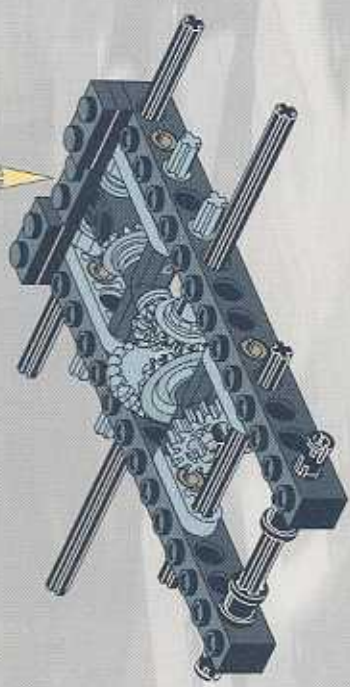
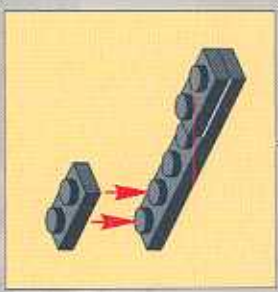
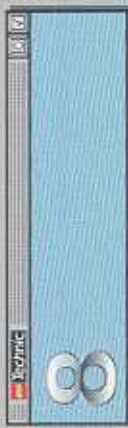
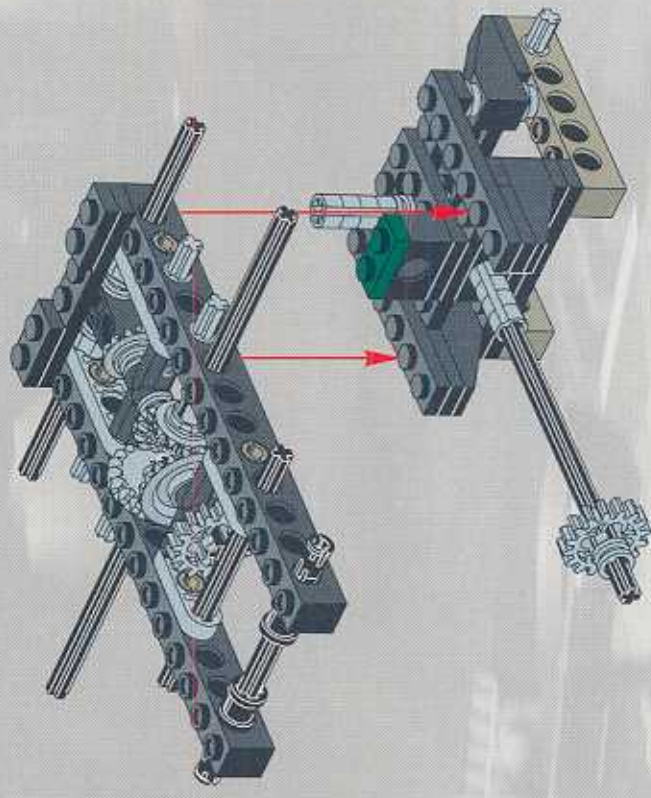



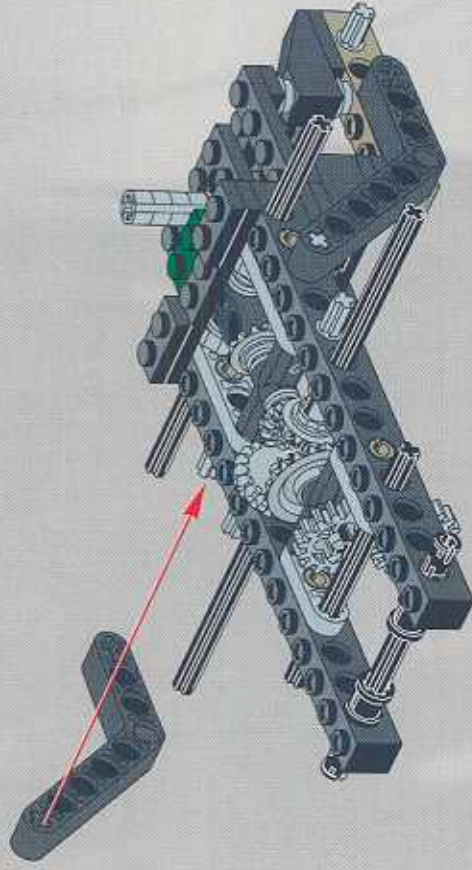
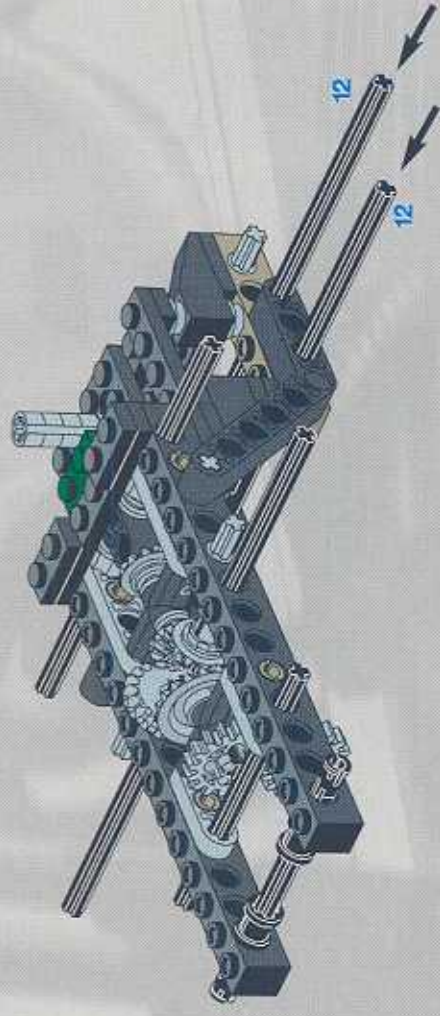



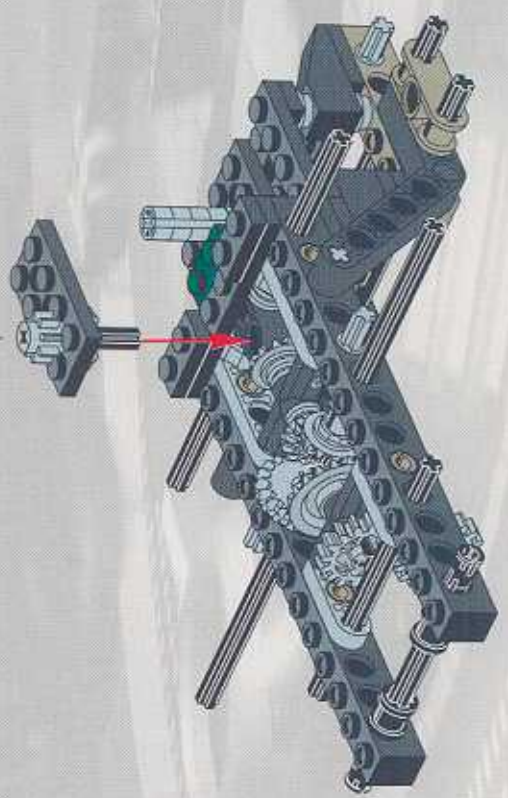
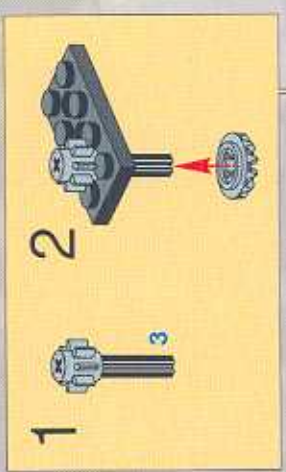
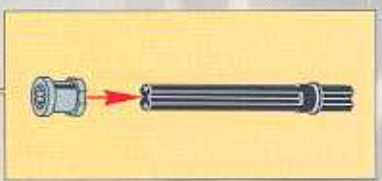
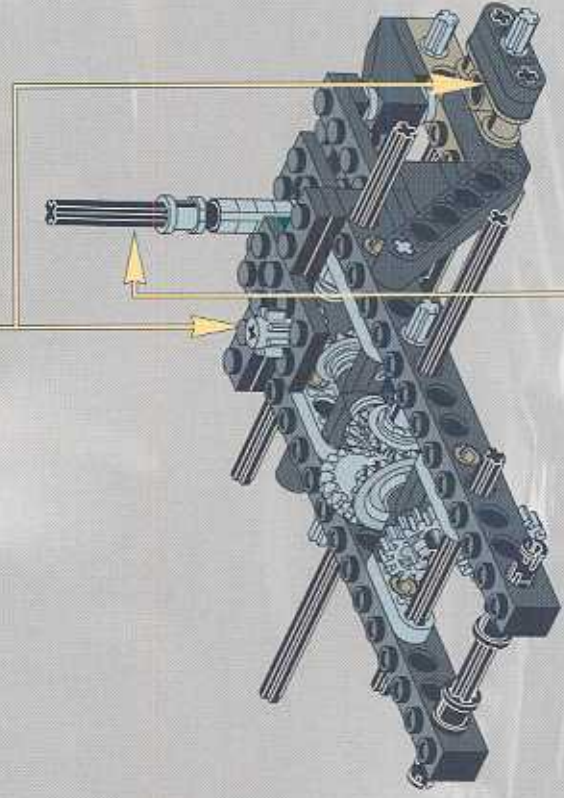
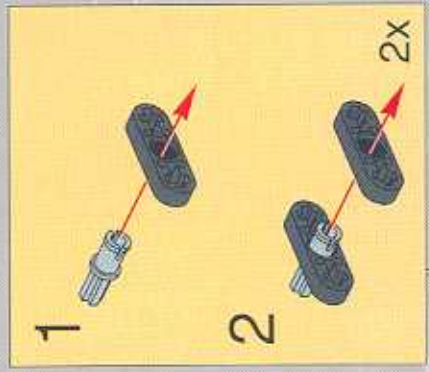
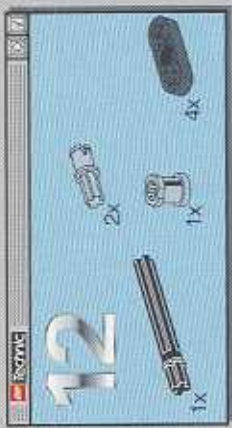





LEGO Technic

13

2x 

1x 

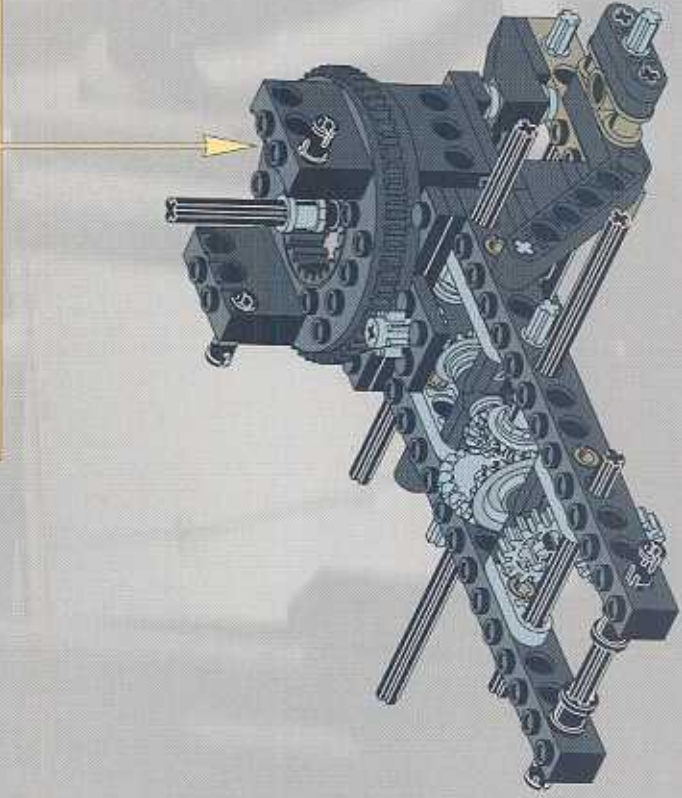
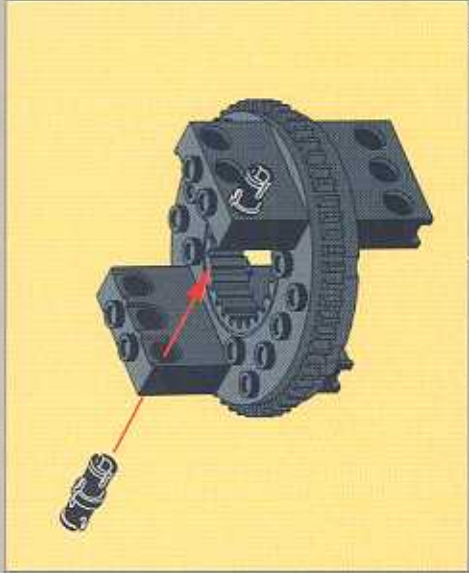



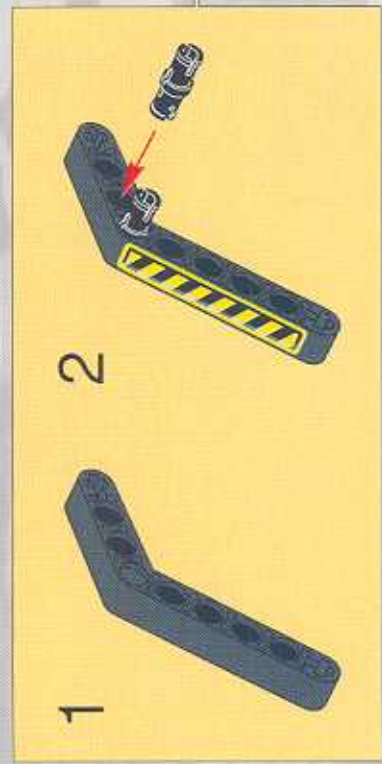
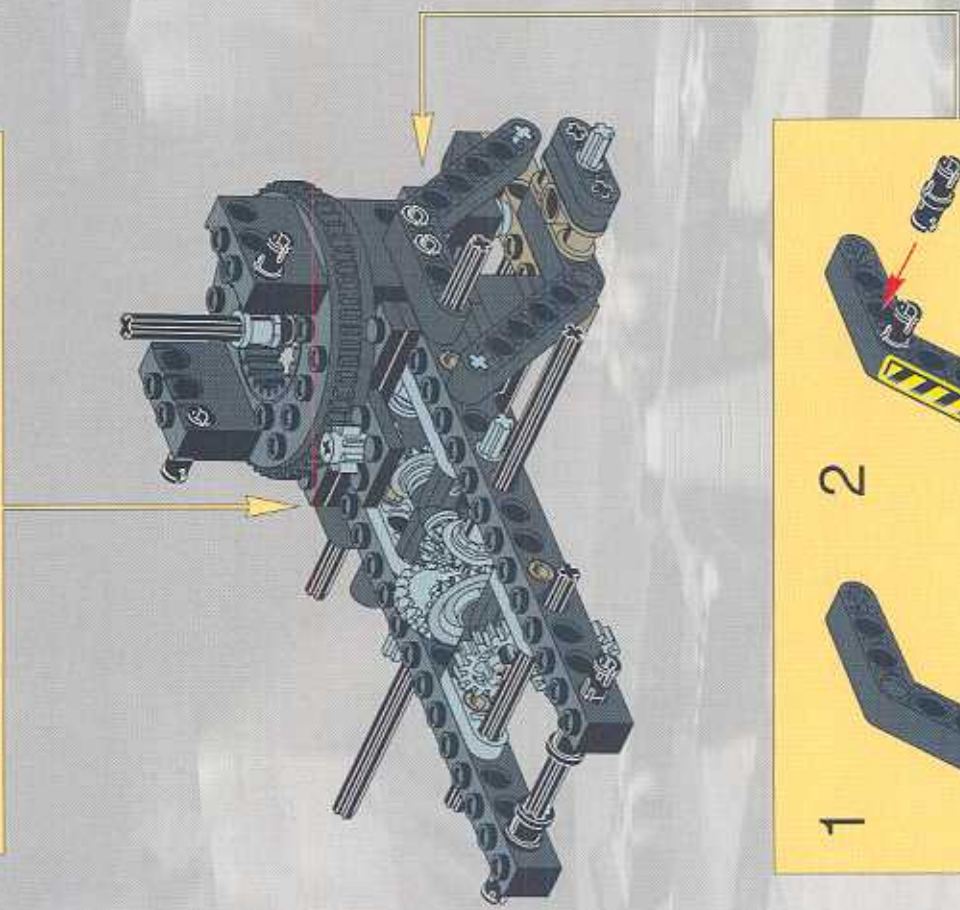
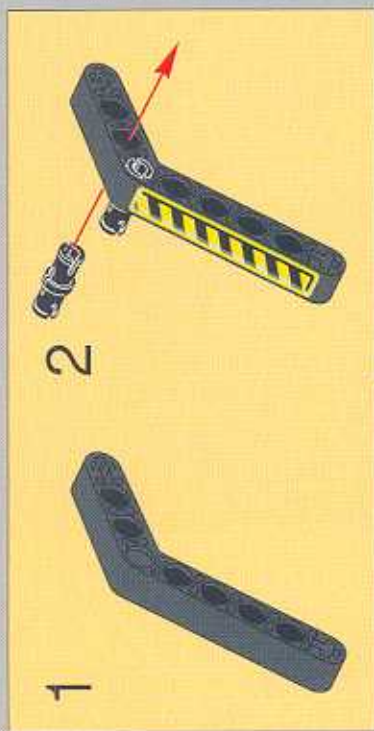



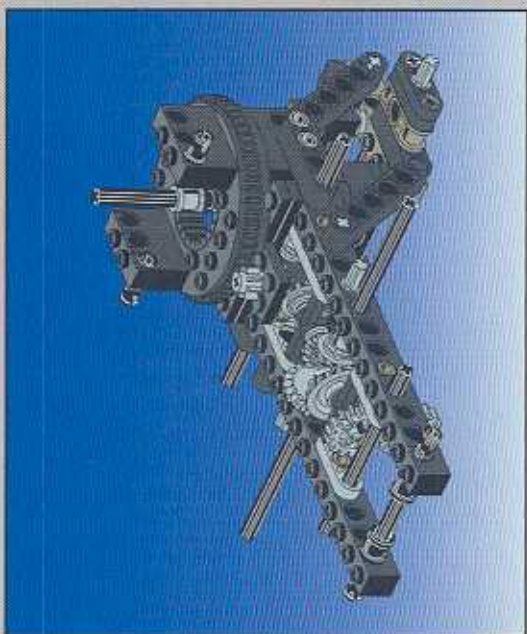

+

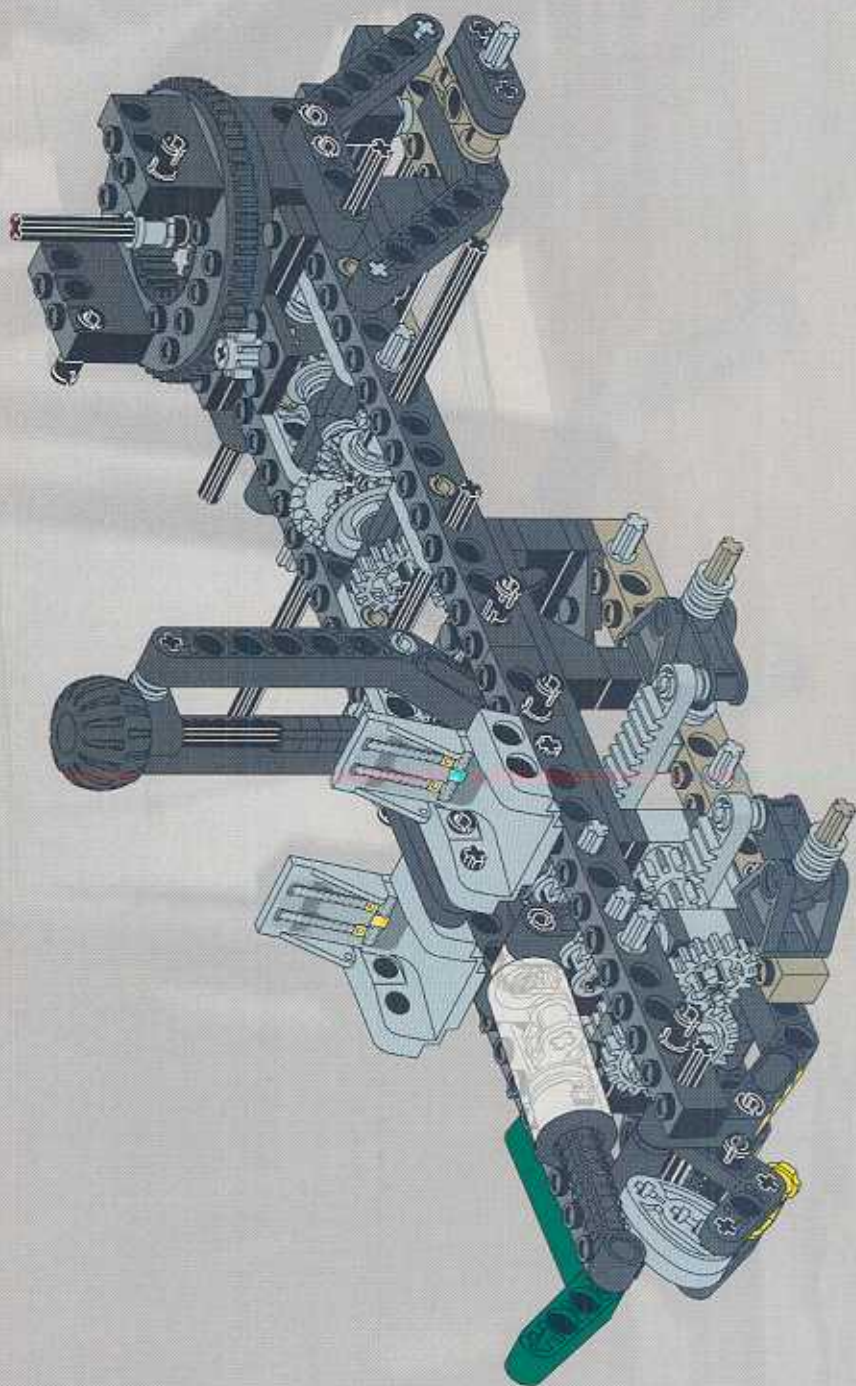
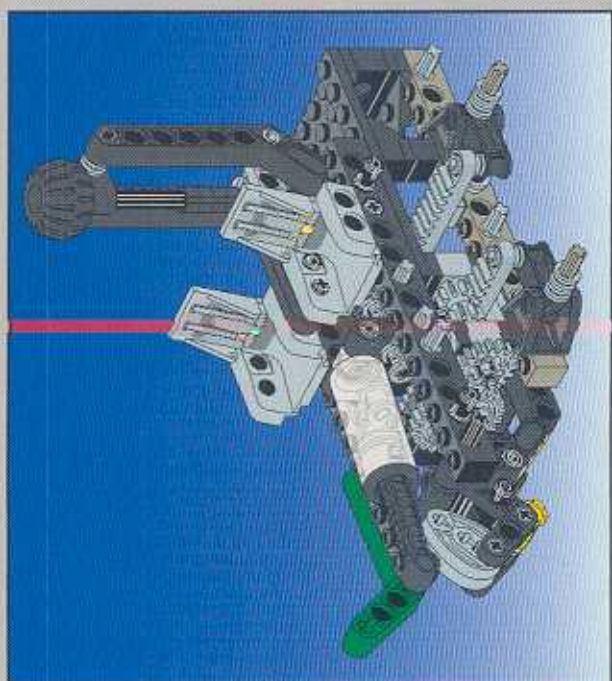



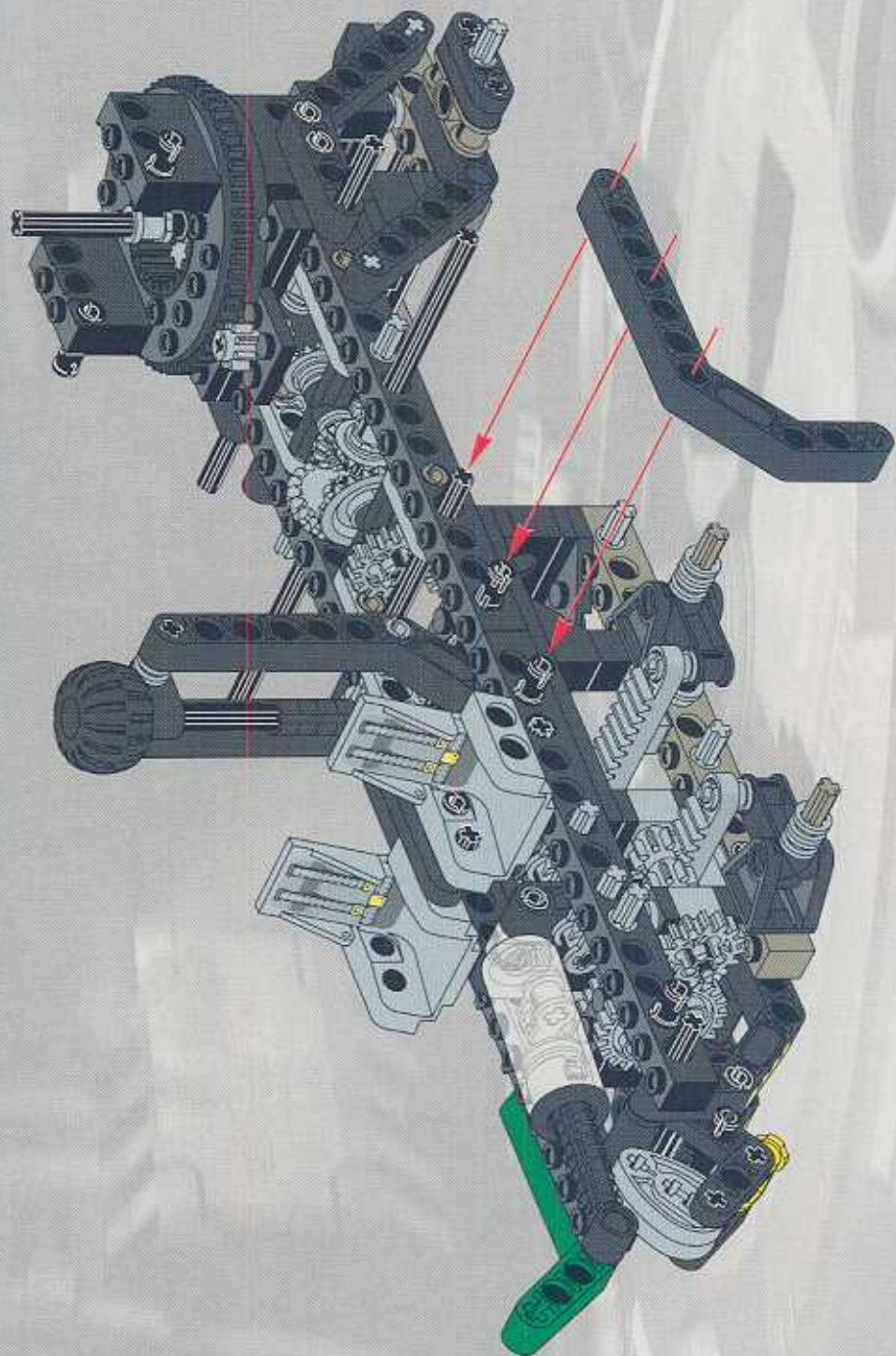



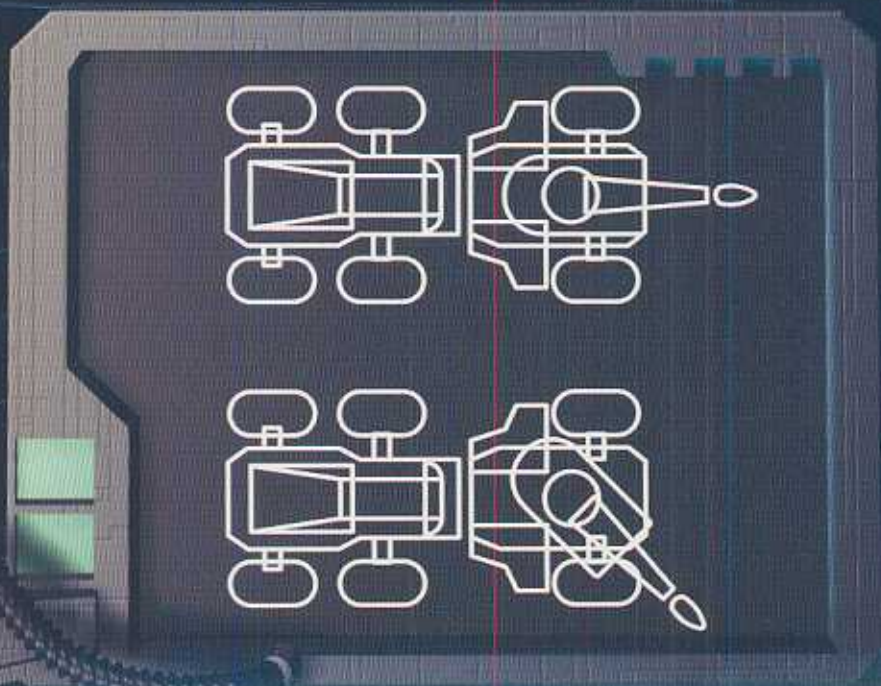
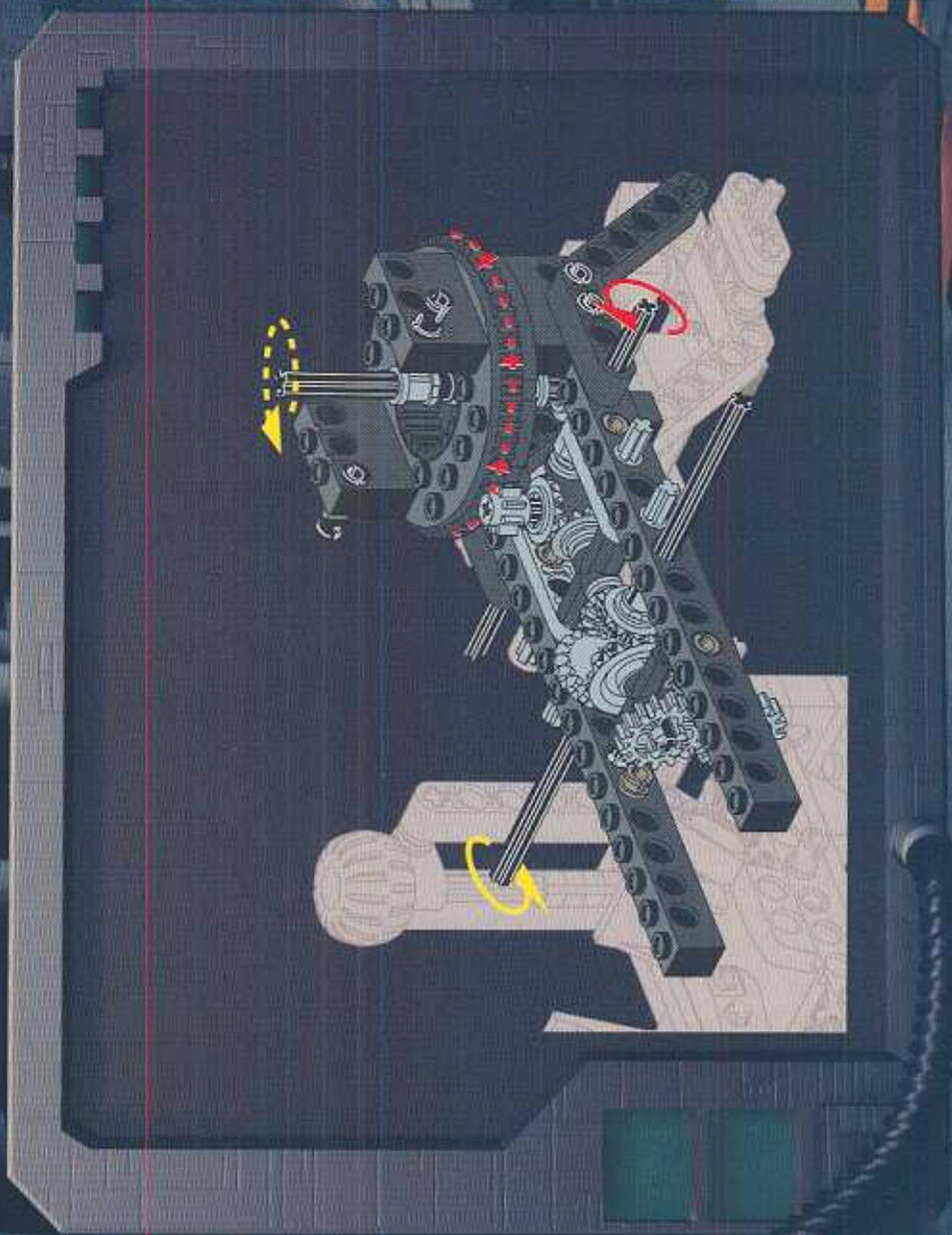



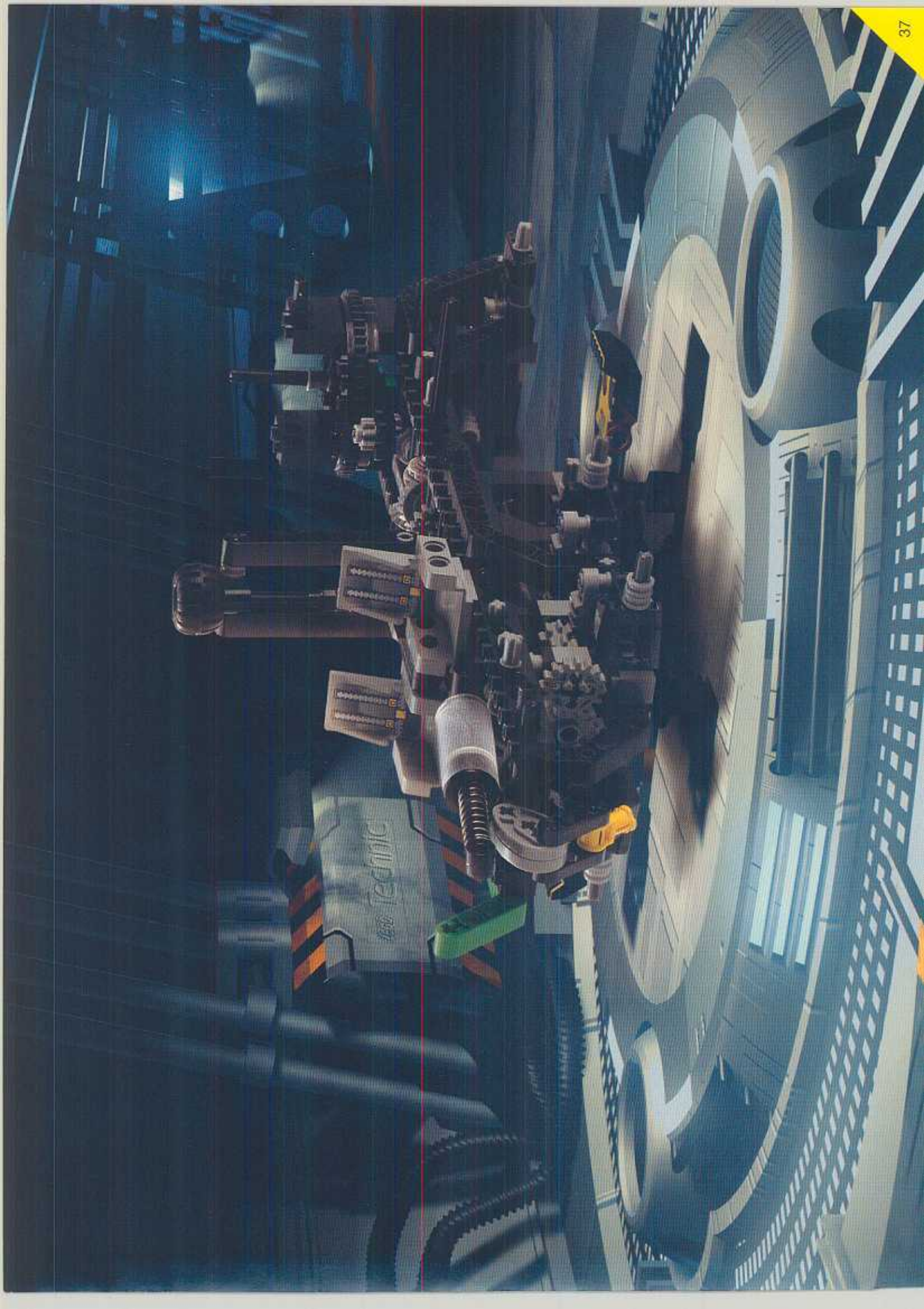



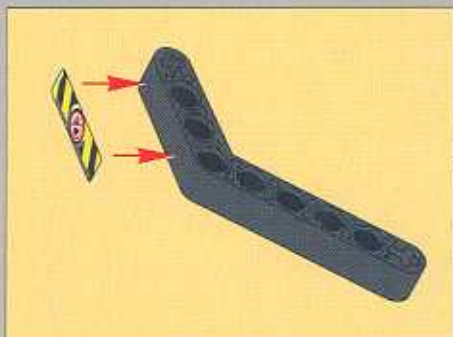
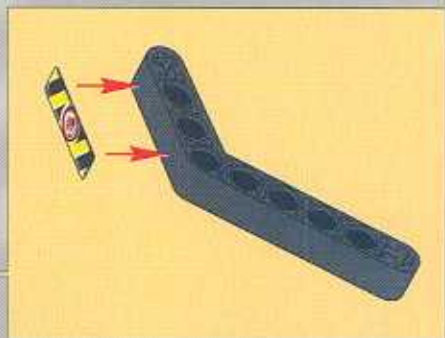
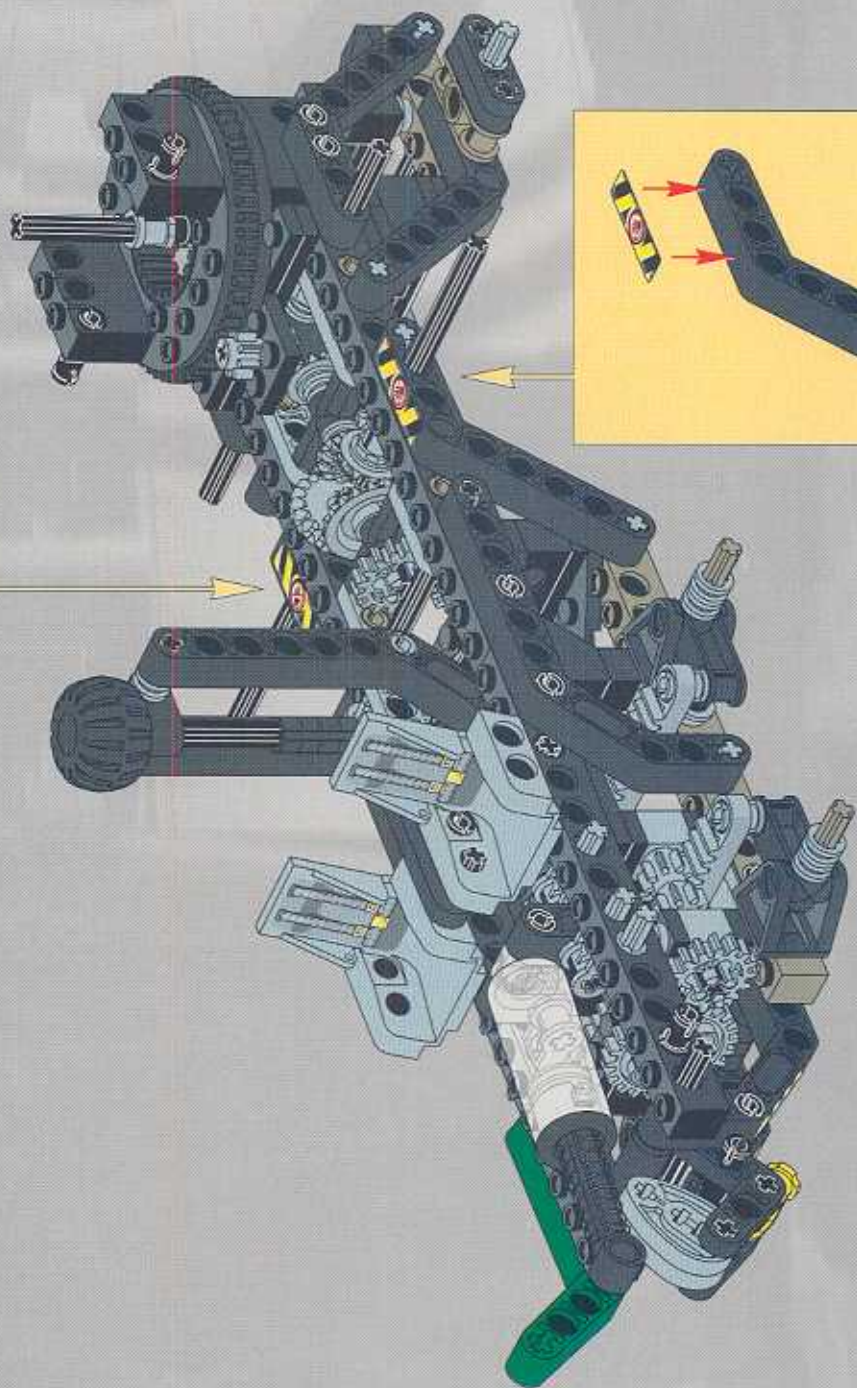



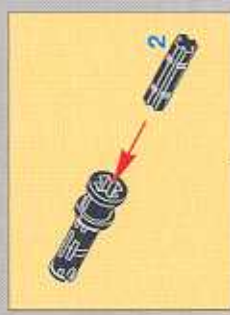
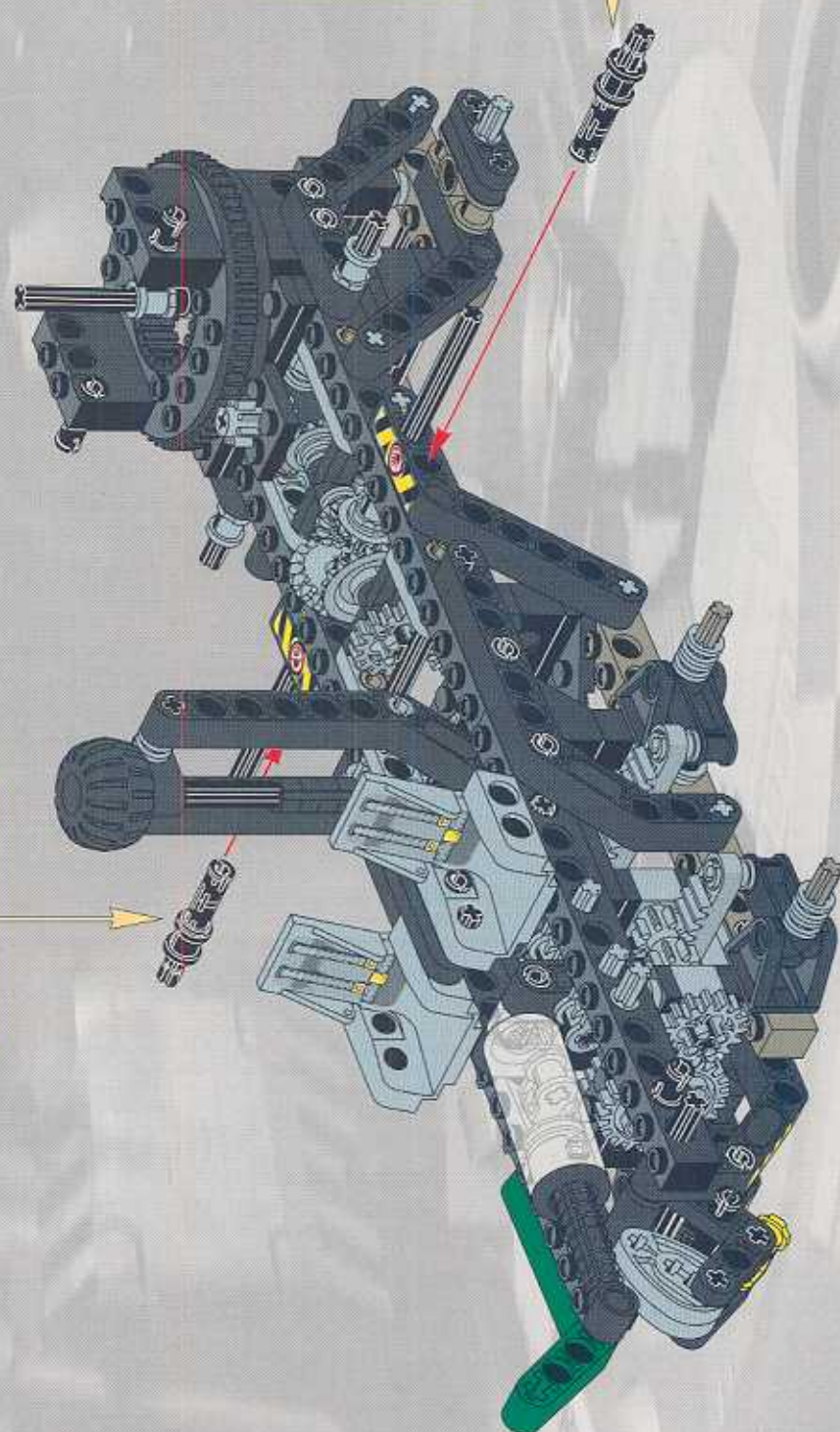

Technic

**31**

2x

2x

2x

2x



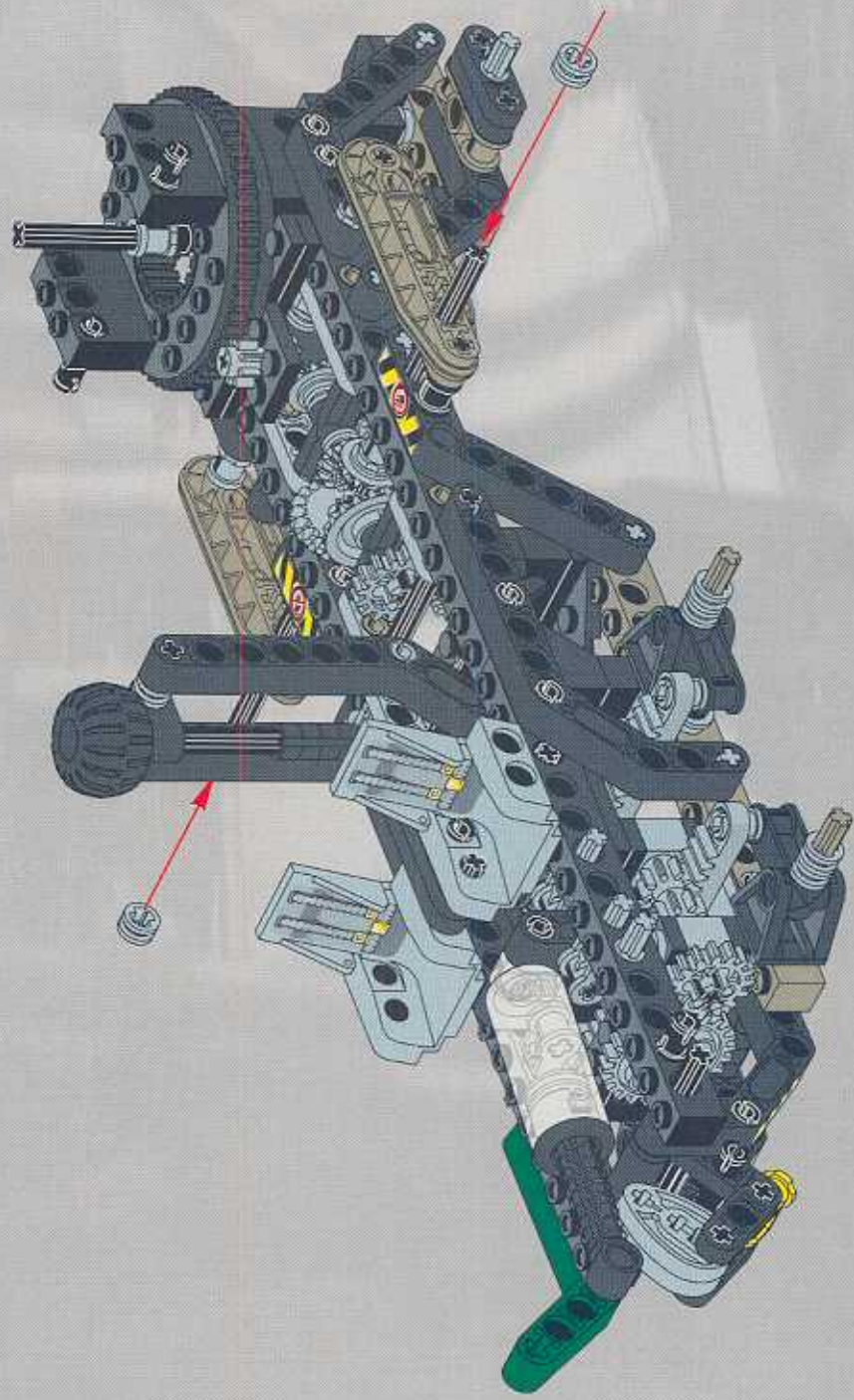

LEGO  
**32**  
2x



2x





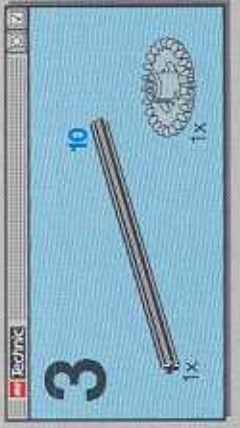



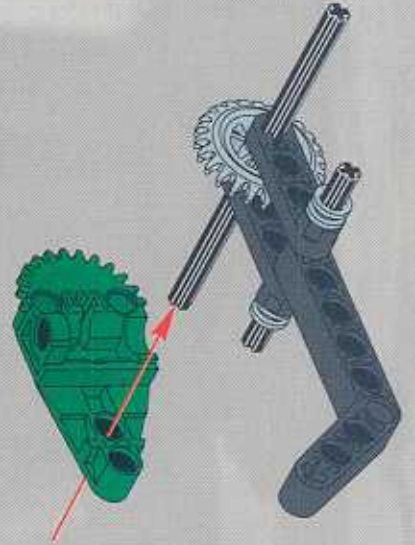
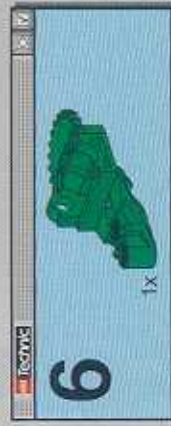



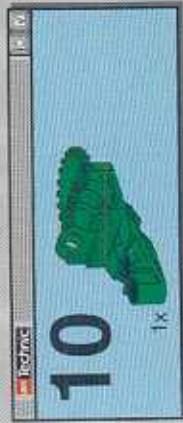







**Schritt 16**

3 2x  
3 2x

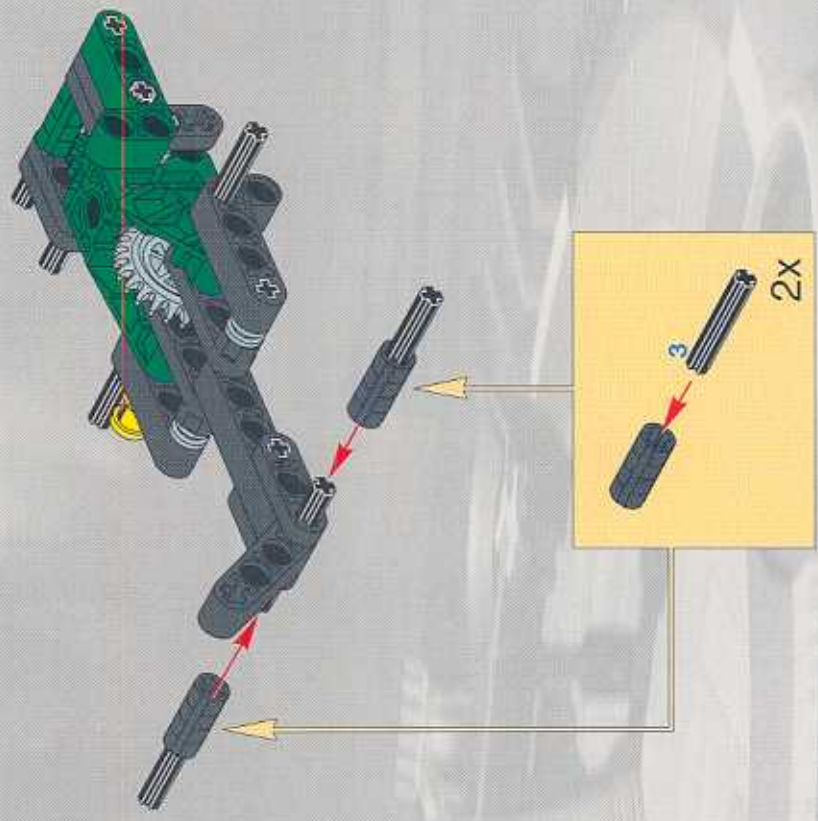

**Schritt 15**

2 1x  
4 1x  
1 1x  
1 1x  
2 1x  
1x

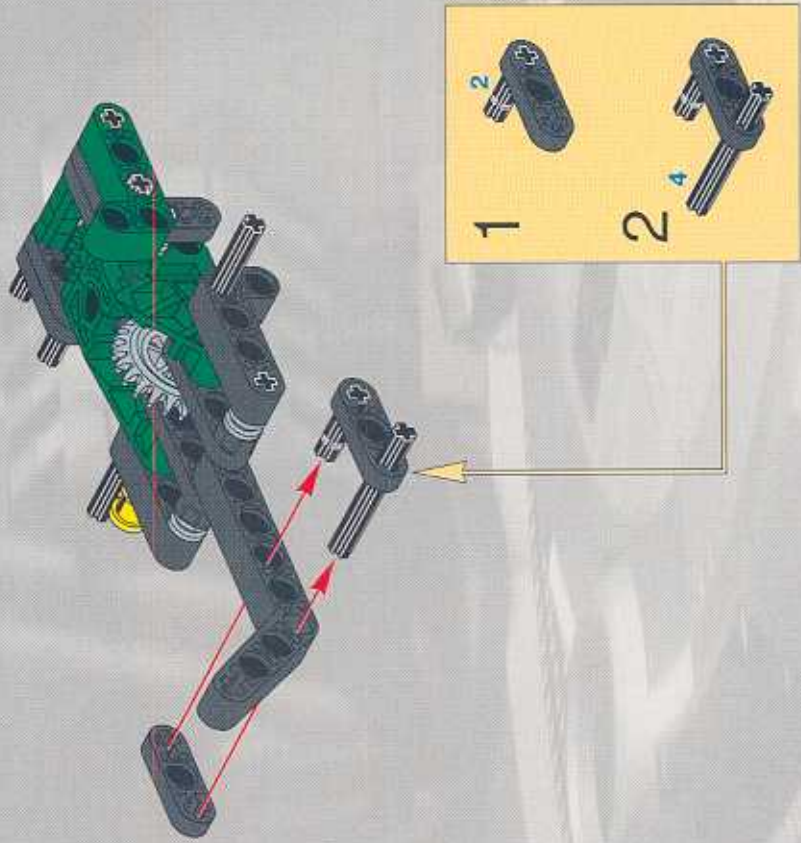



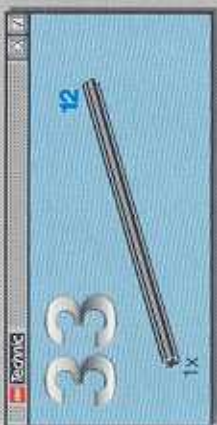
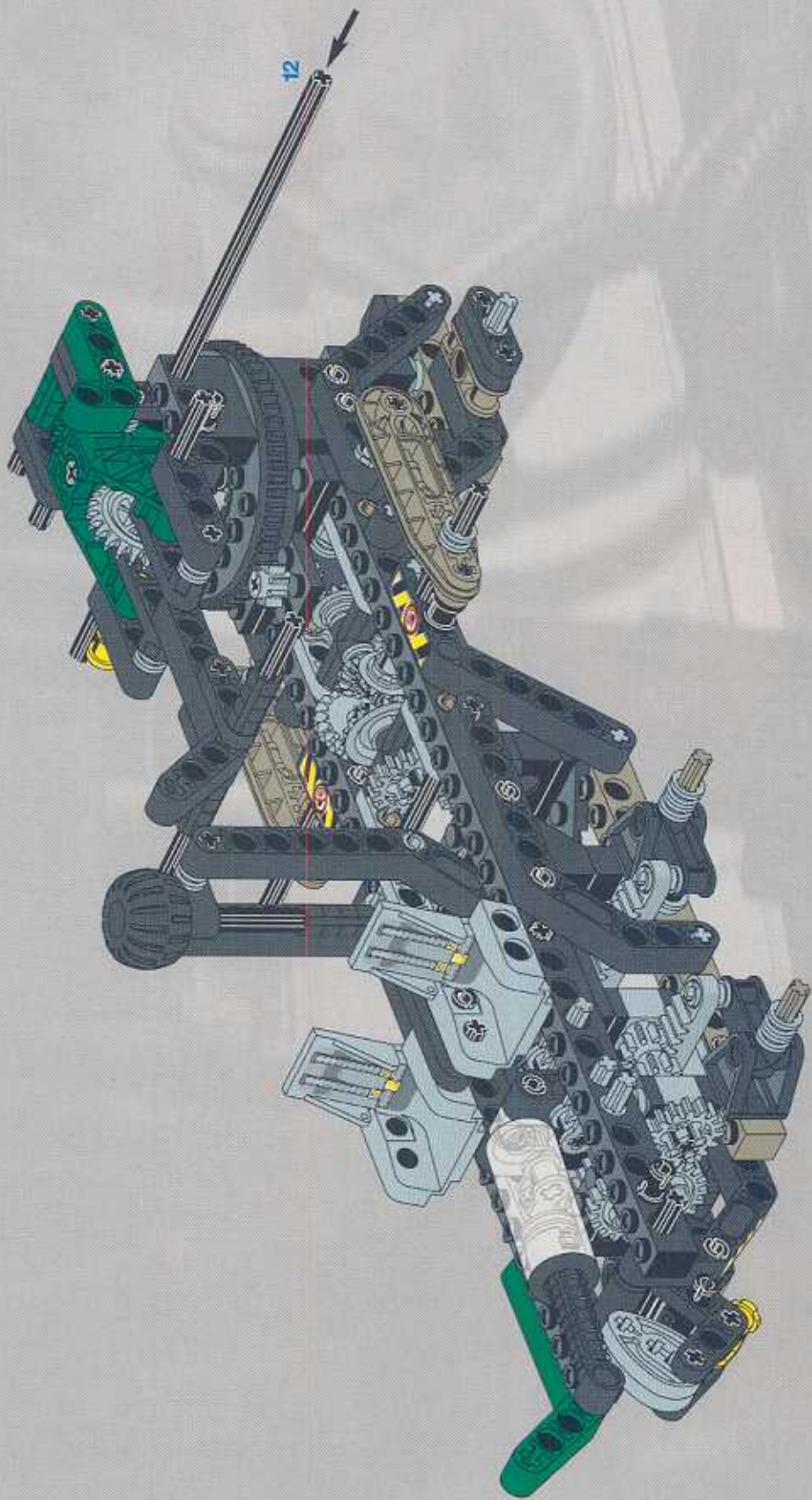



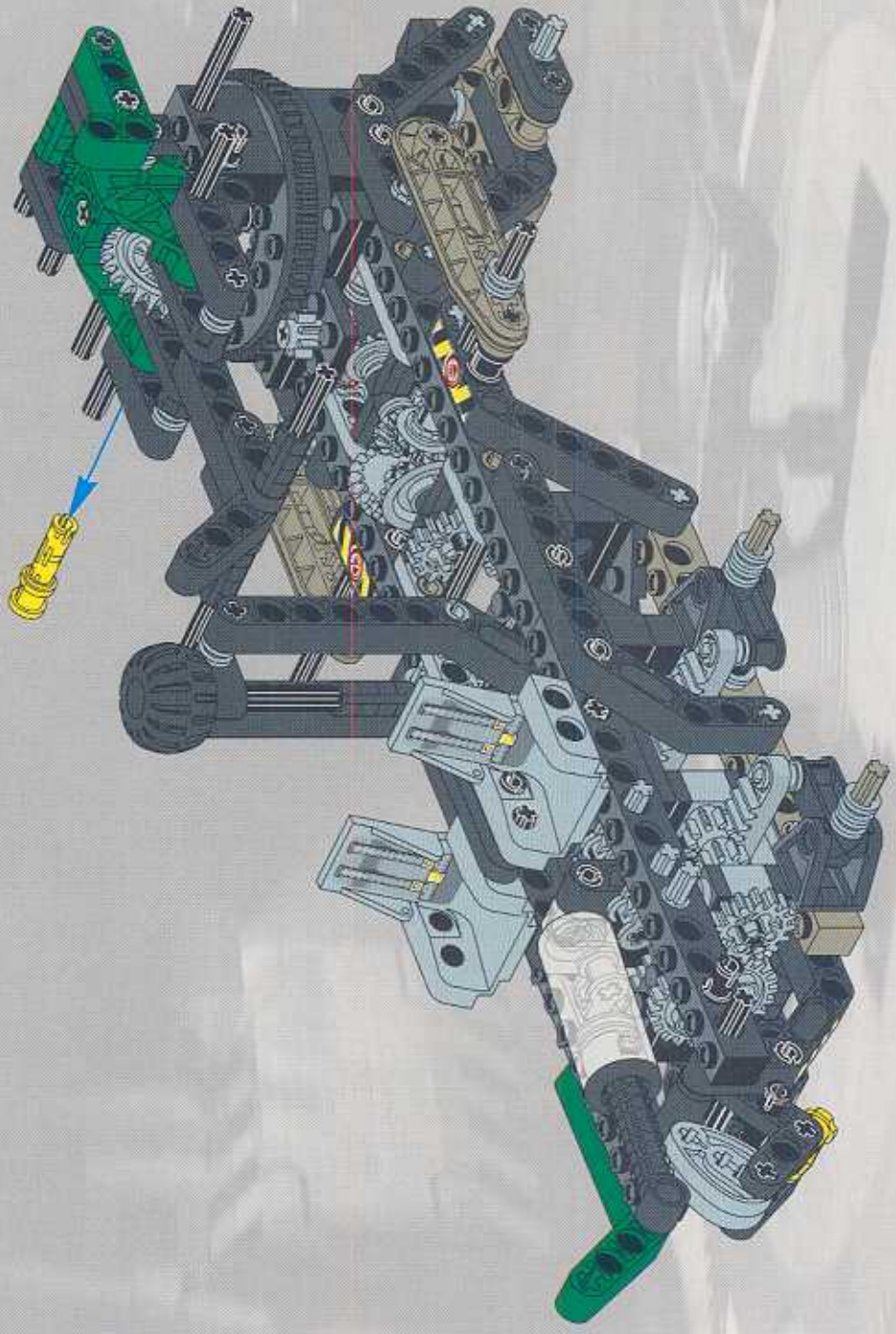



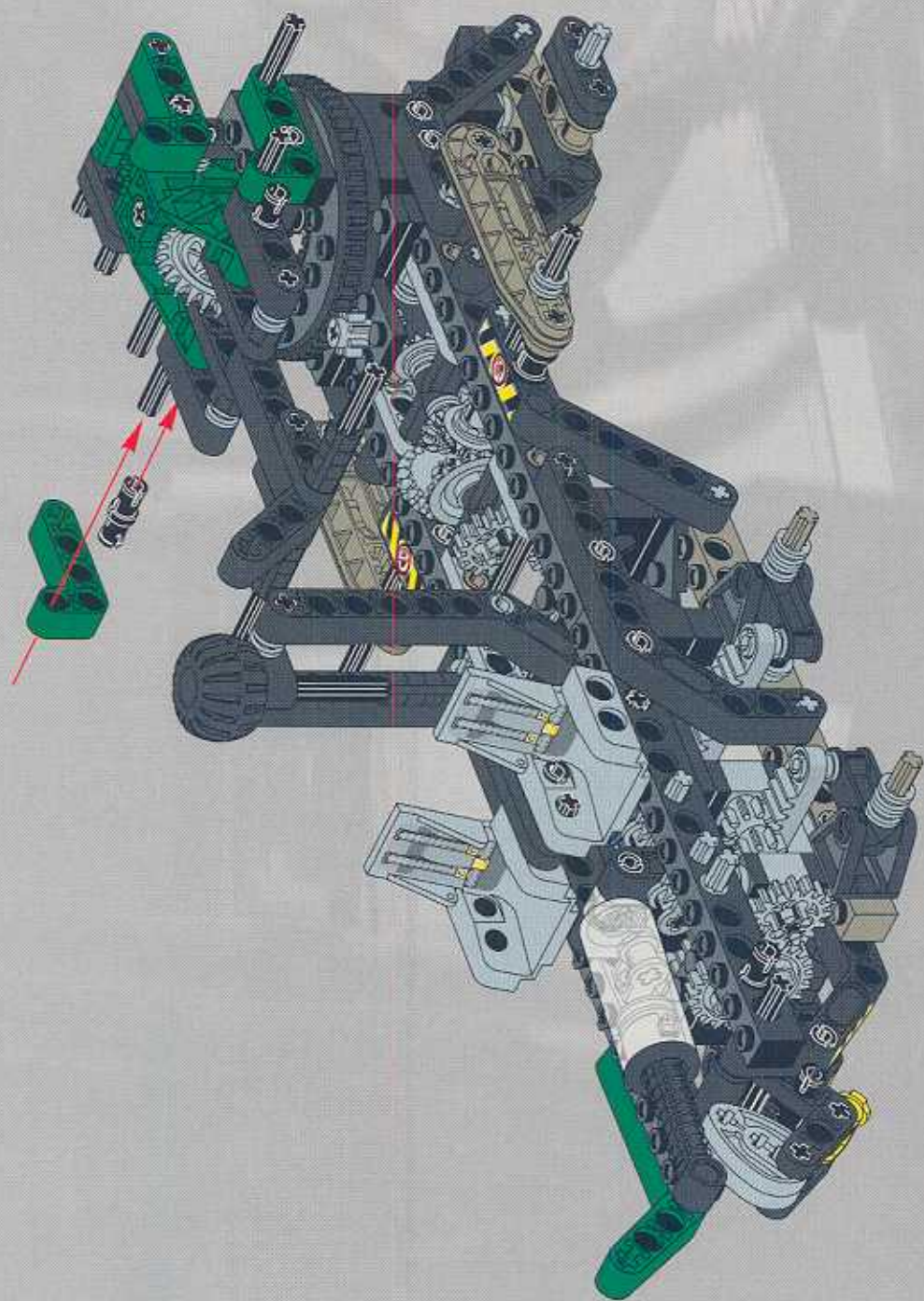



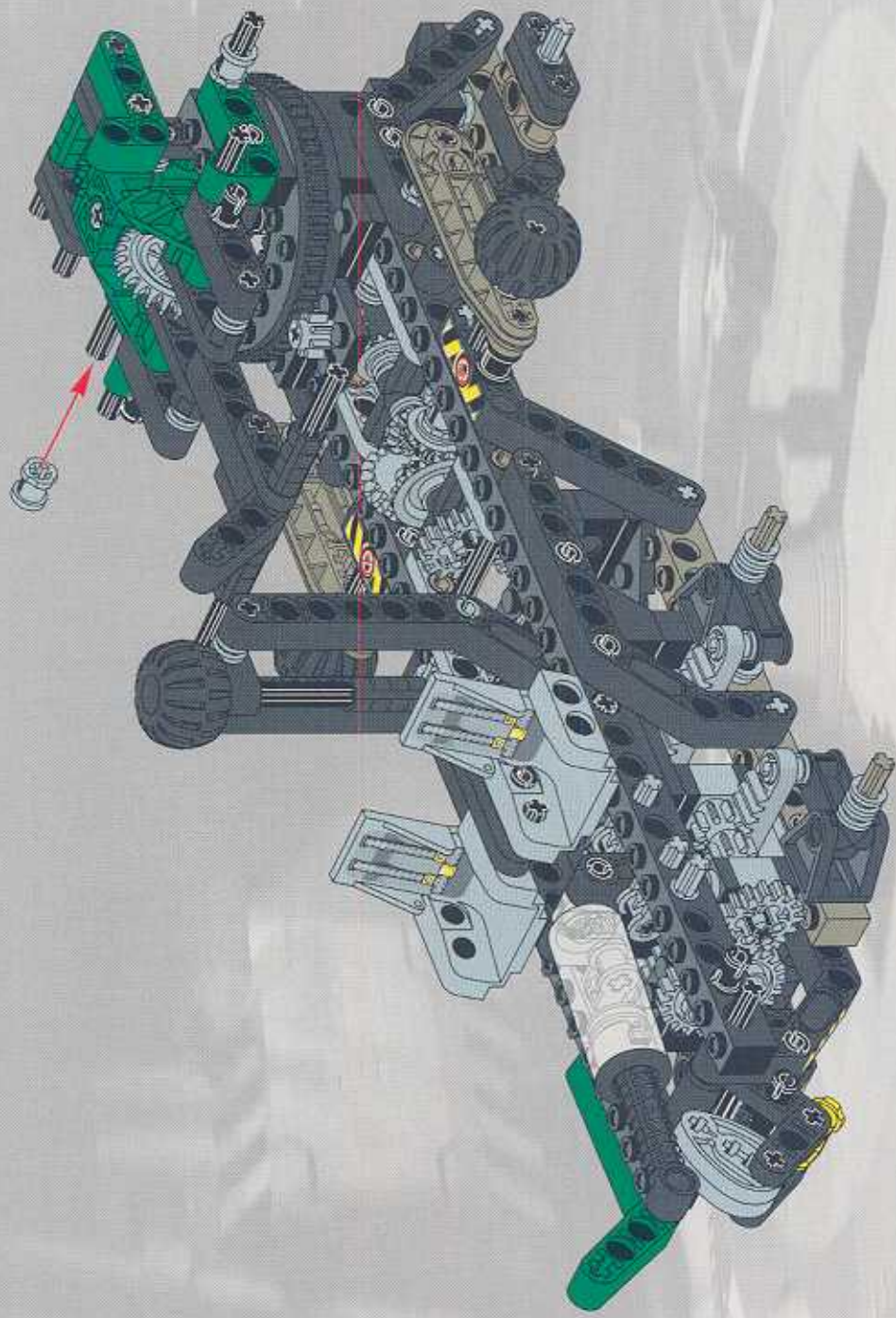

LEGO 36

	2x
	2x



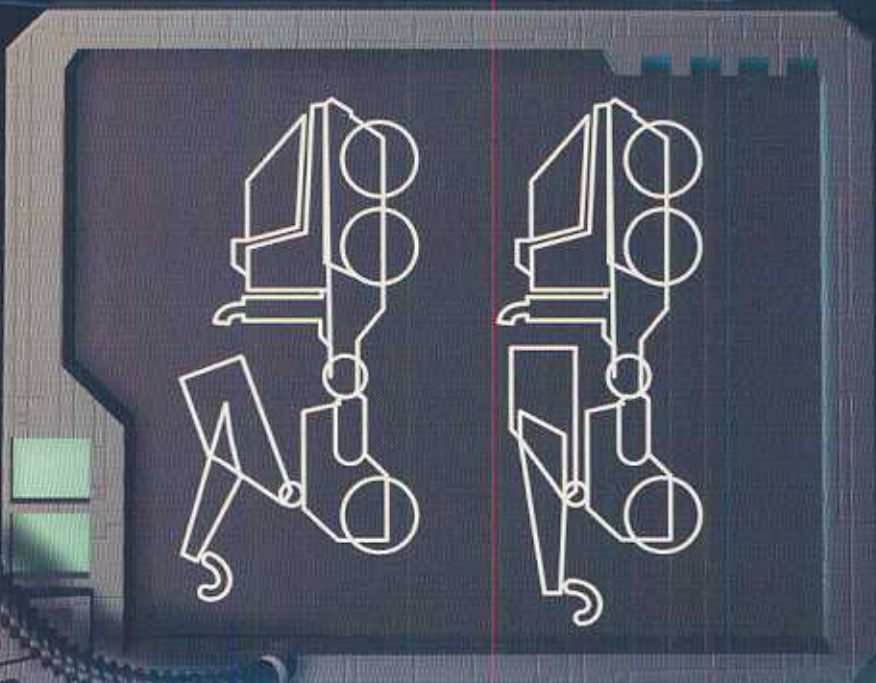
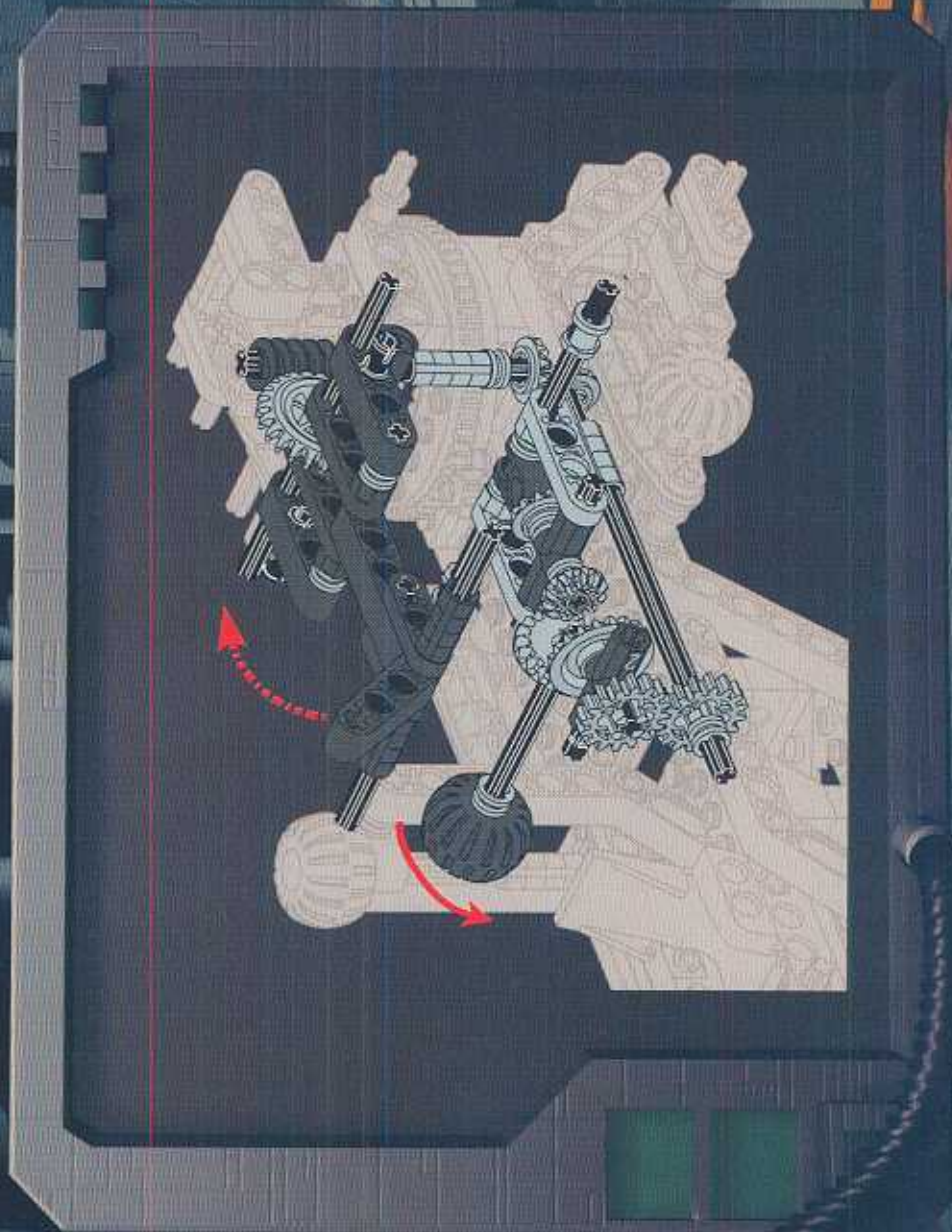



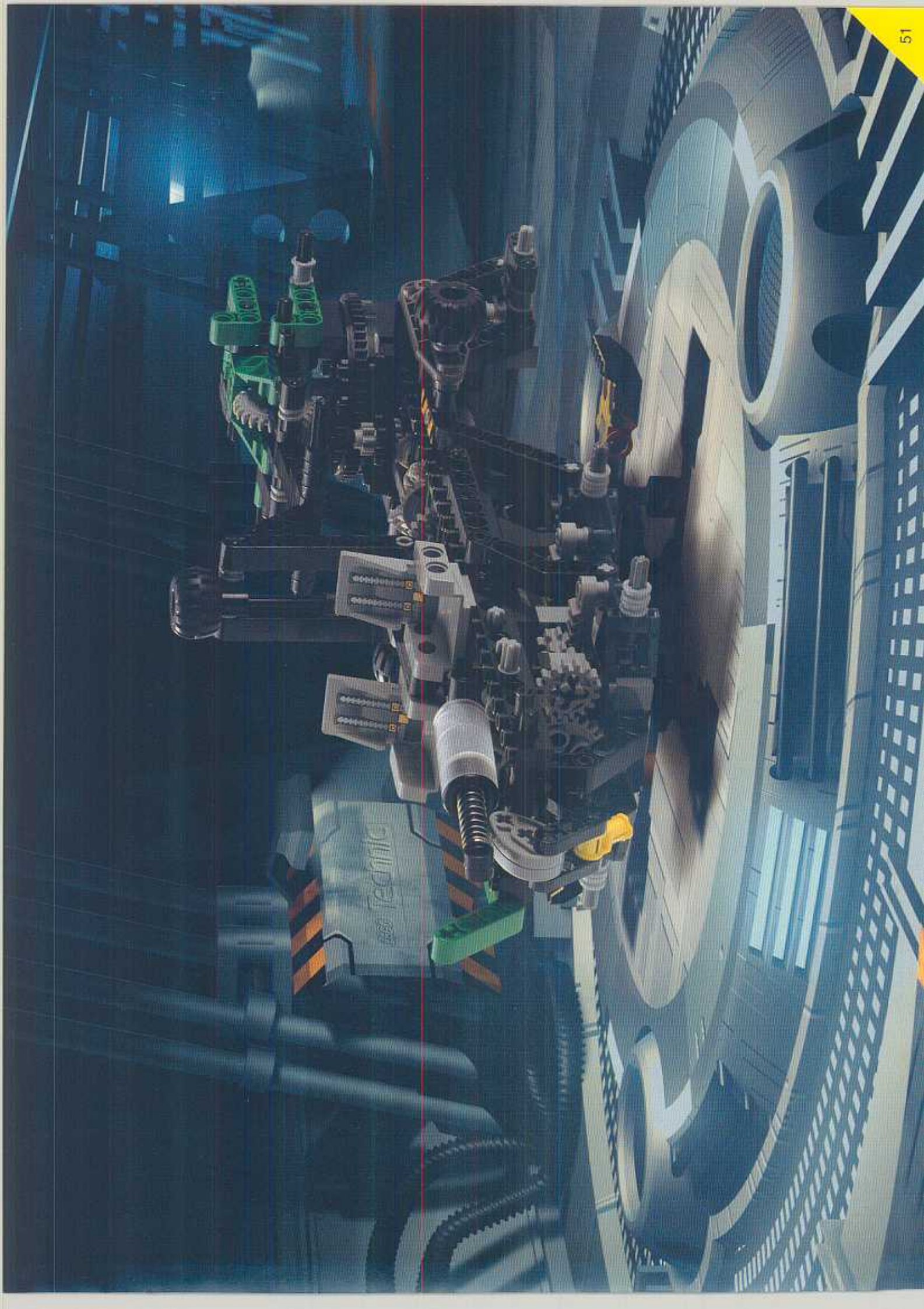





**37**

 2x  
 2x

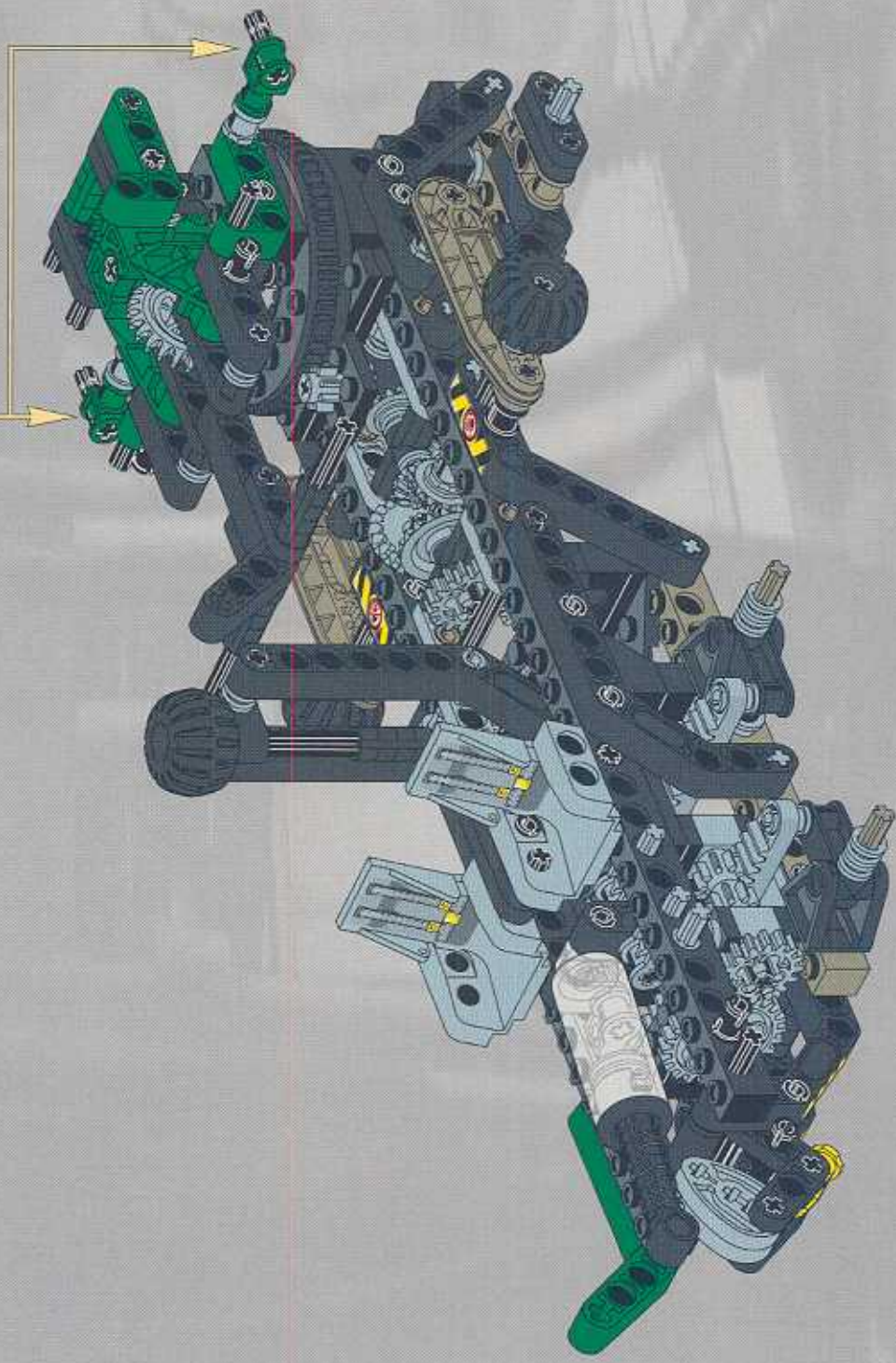
 2x  
 2x



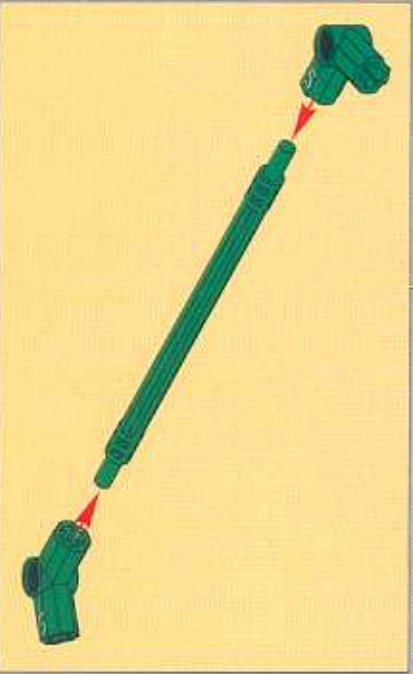
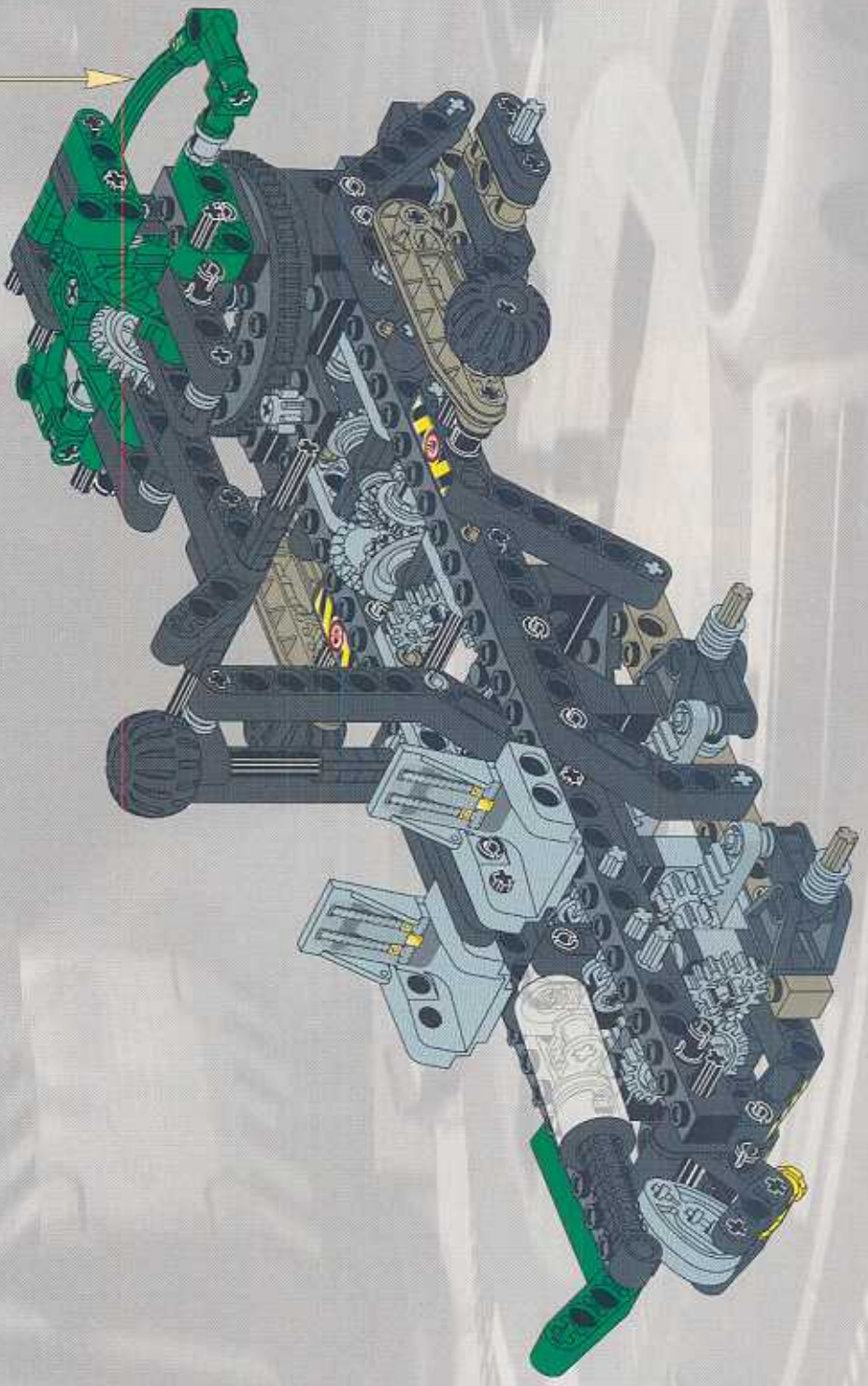



LEGO Technic

38

1x

2x

The parts list for step 38 is located in a blue box. It includes the number '38' in a large font, the text 'LEGO Technic' in a small font, and two items: a green Technic arm (1x) and two red pins (2x).



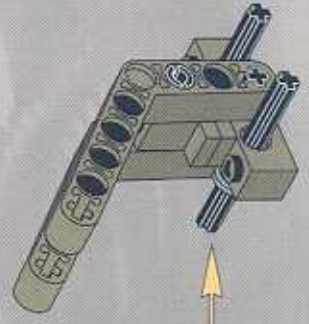
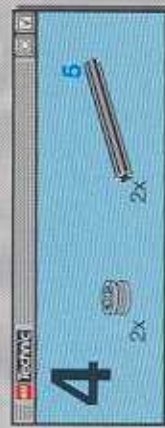
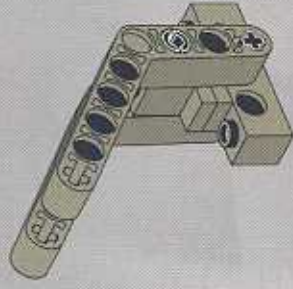
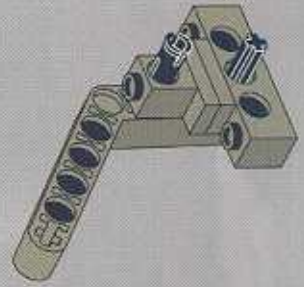
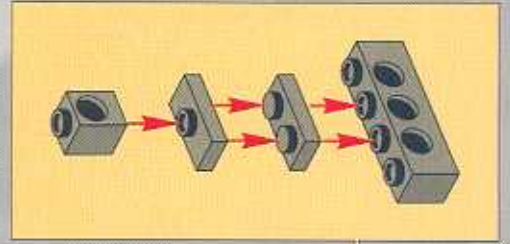
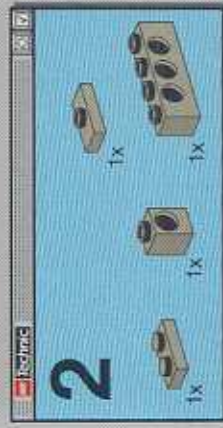
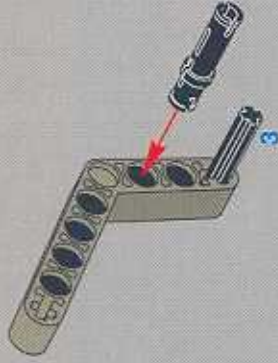



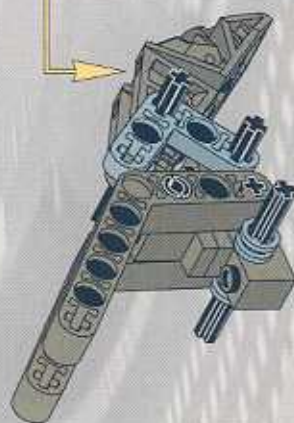
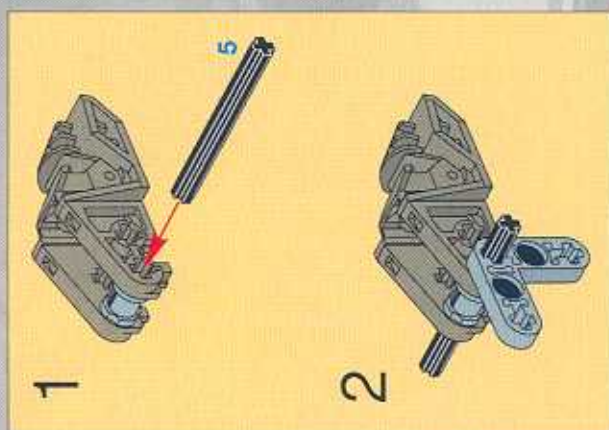
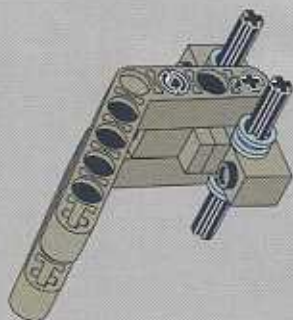
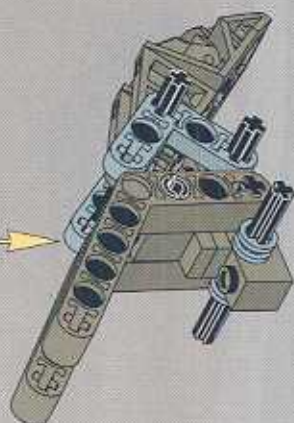



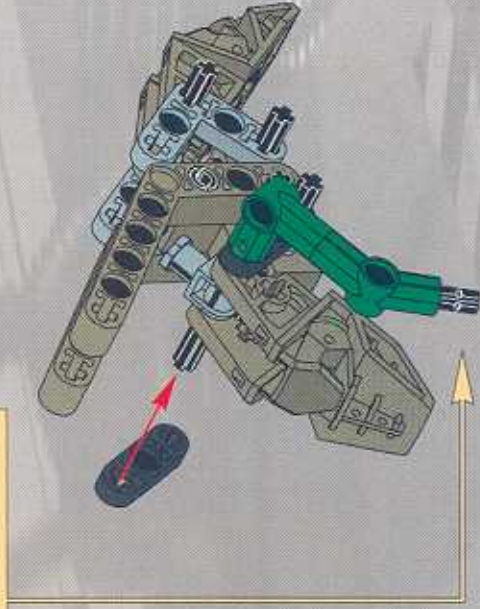
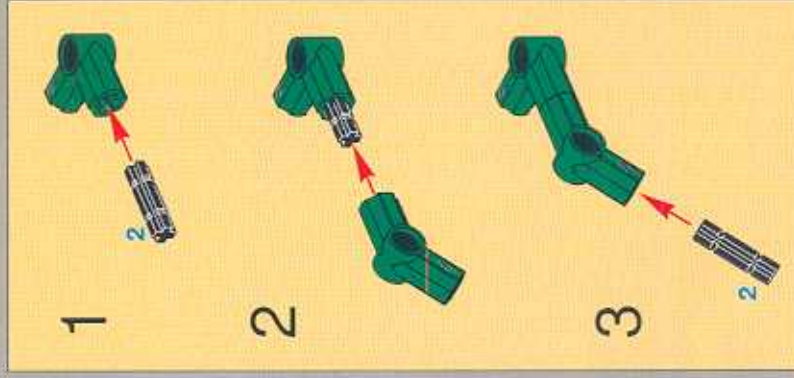
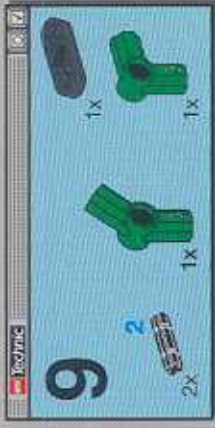
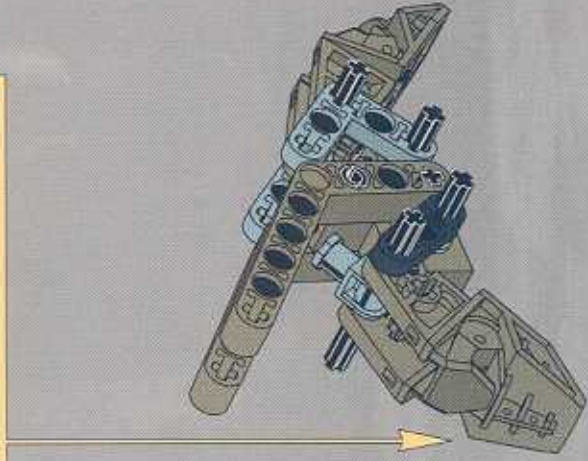
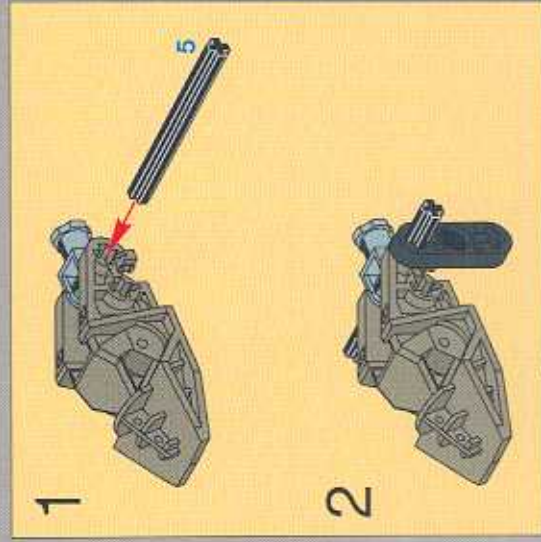







**11**  2x

**10**  2x  1x  1x

1 2 3

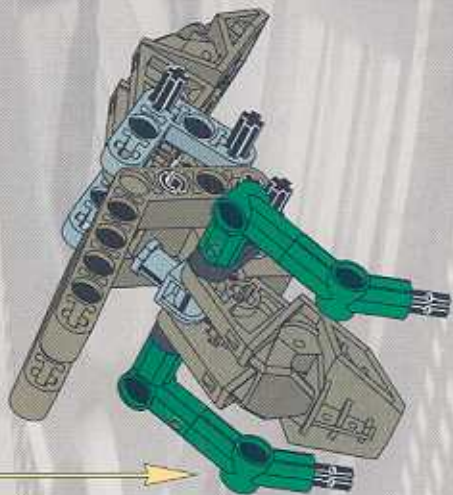
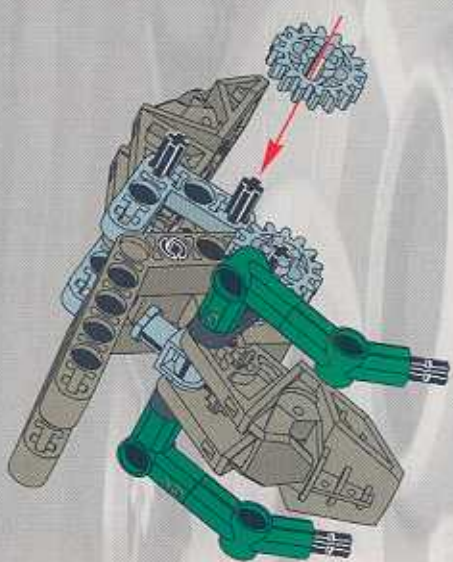



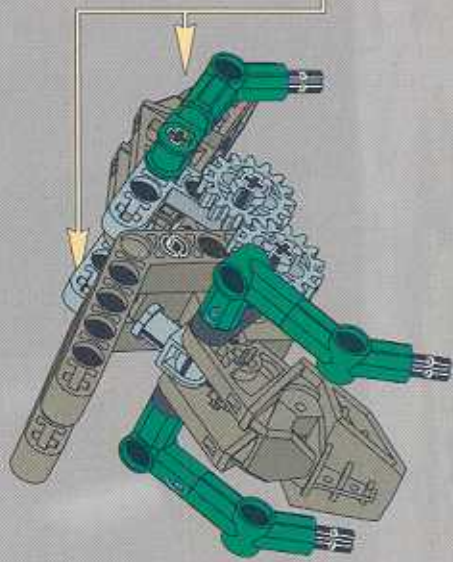
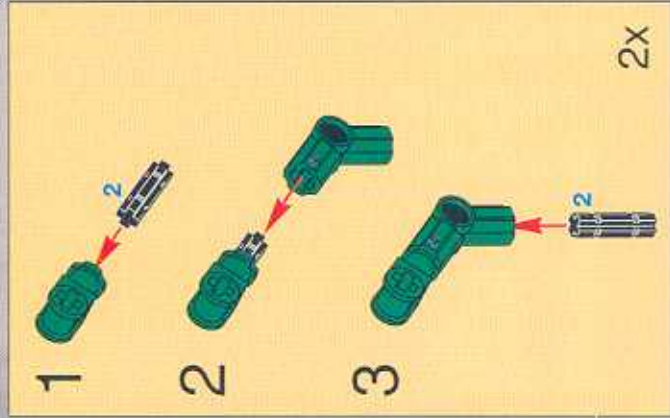
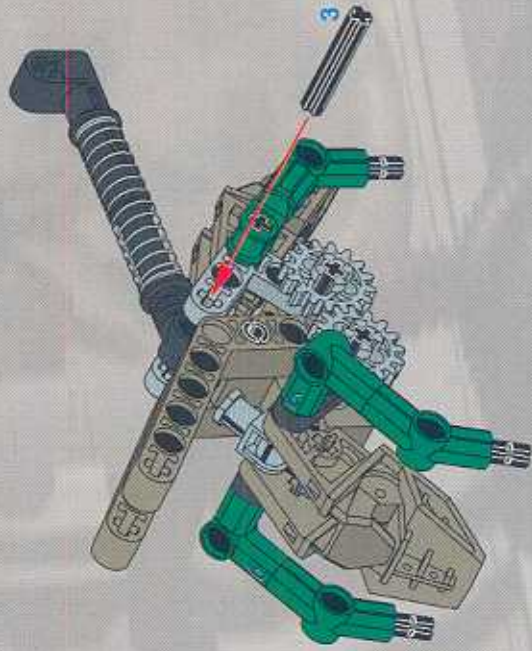
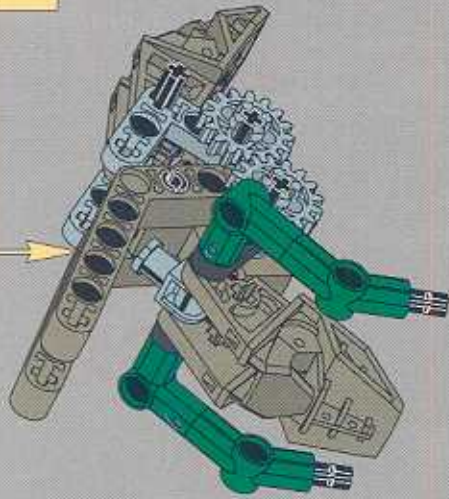



**16**



1x

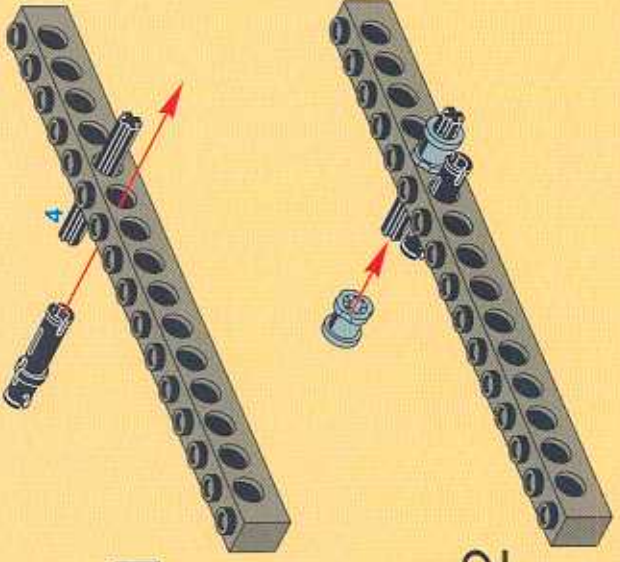

1

2

**15**



3x

1x

2x

16

1x

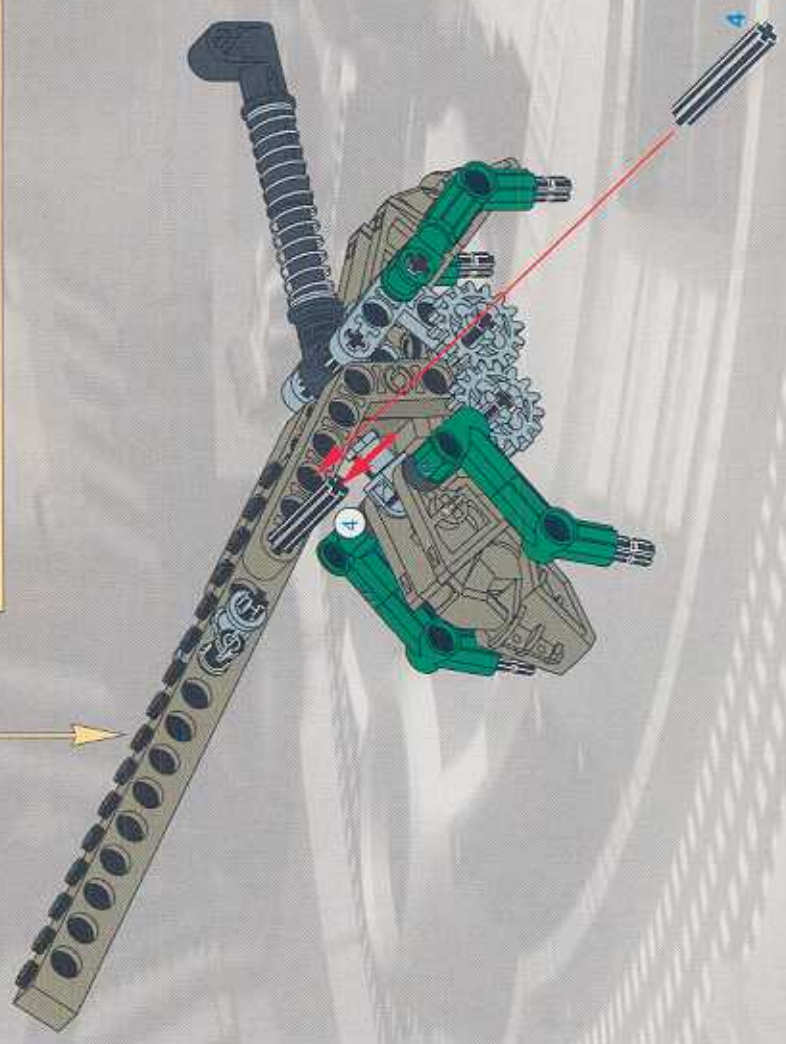
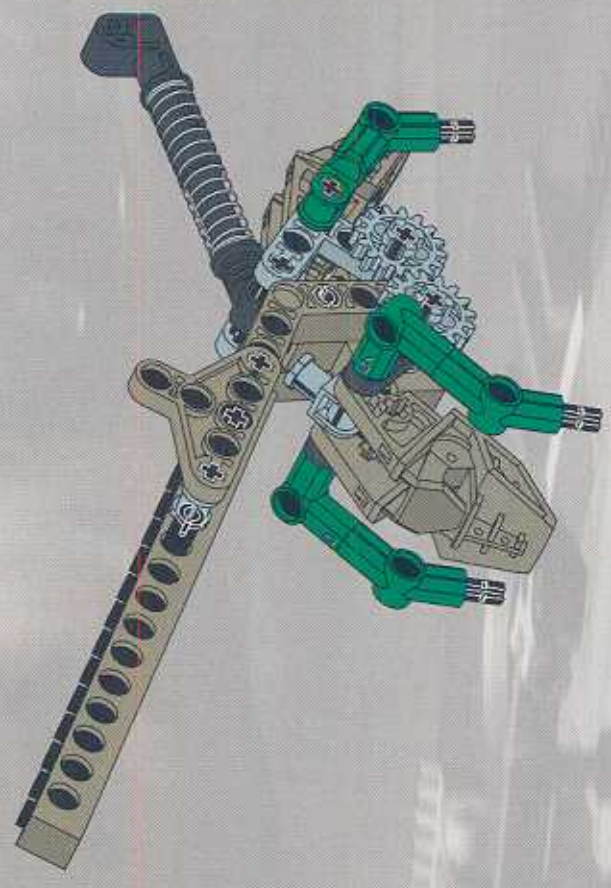



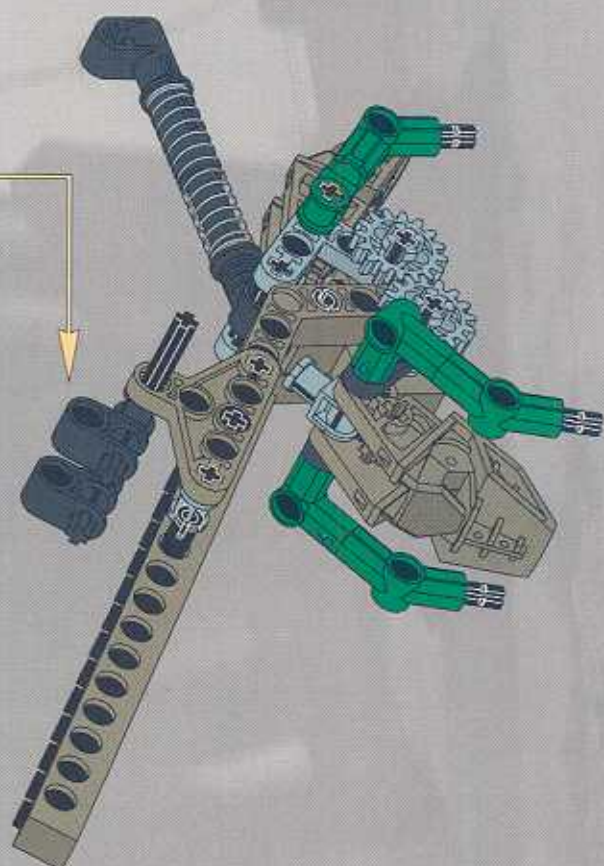
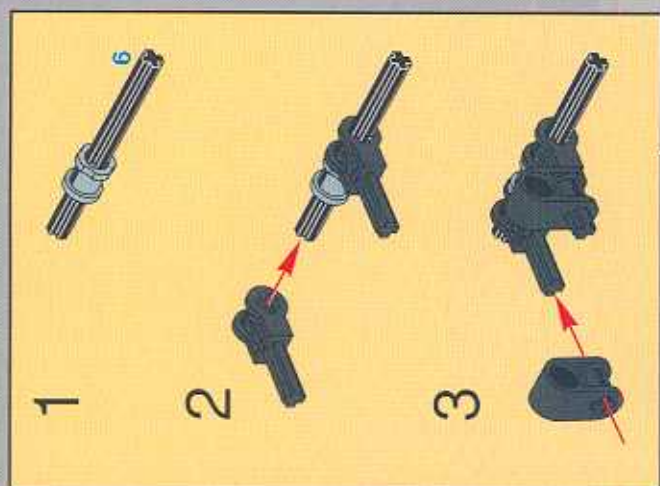
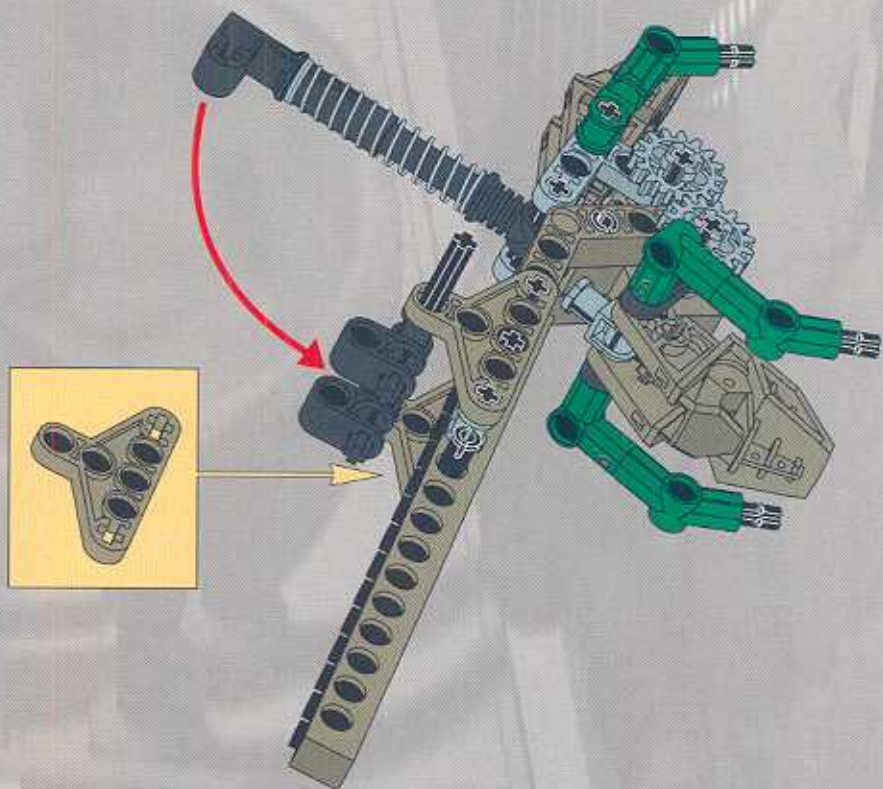
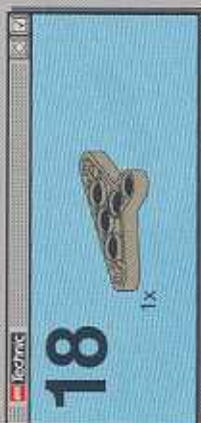



**19**

1x

3



**20**

2x

1x

3

1x

**1**

**2**

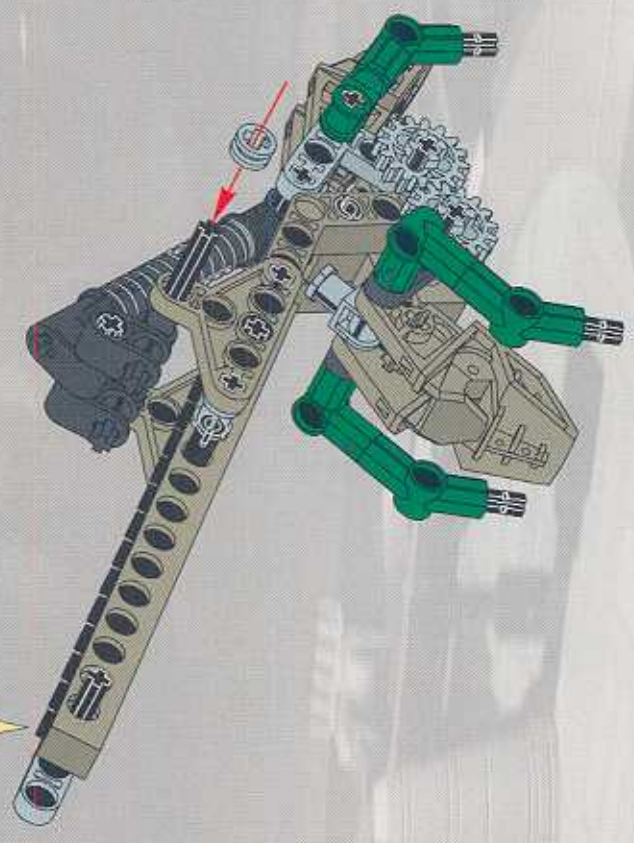



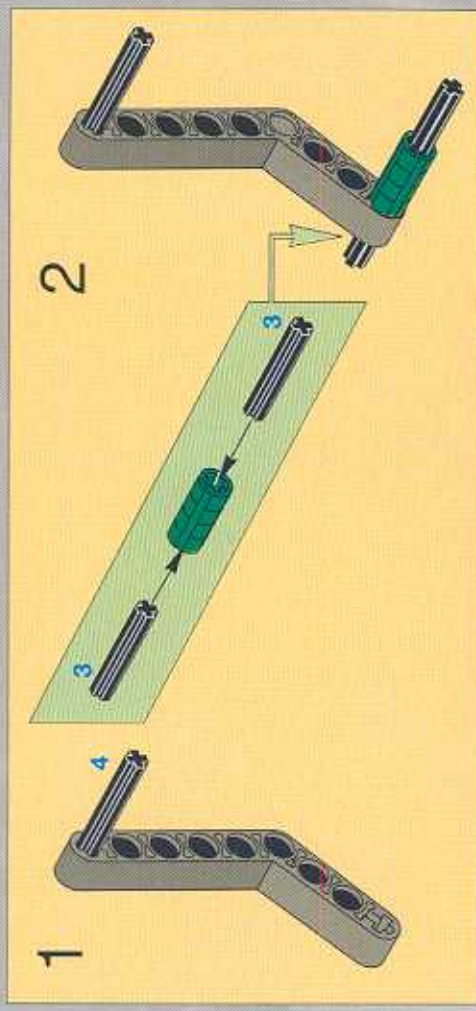
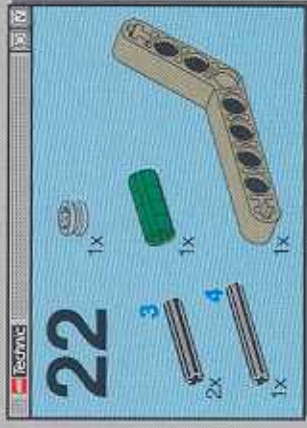
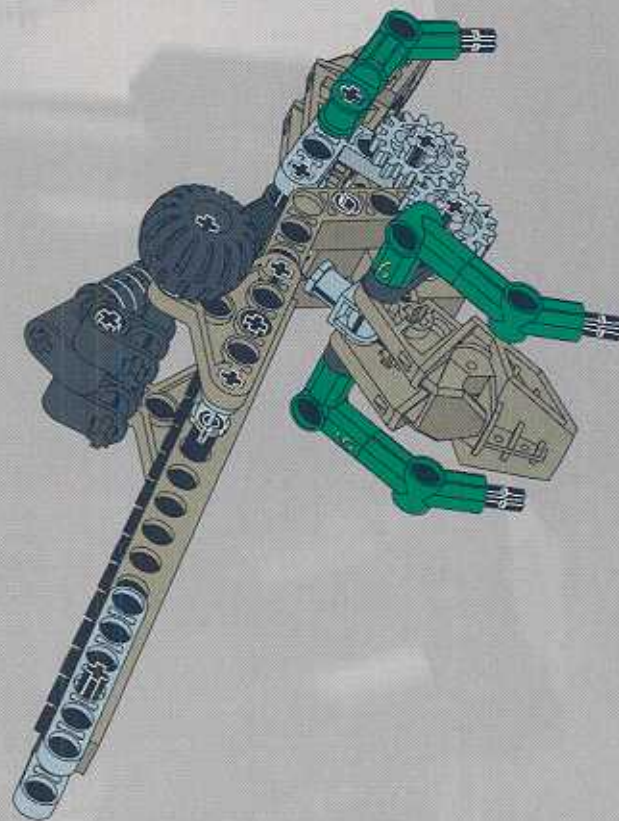



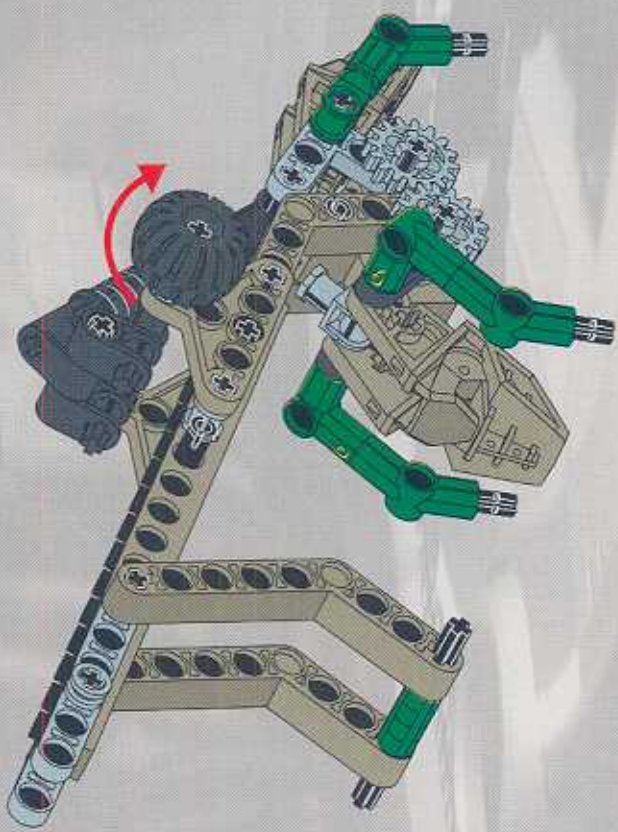
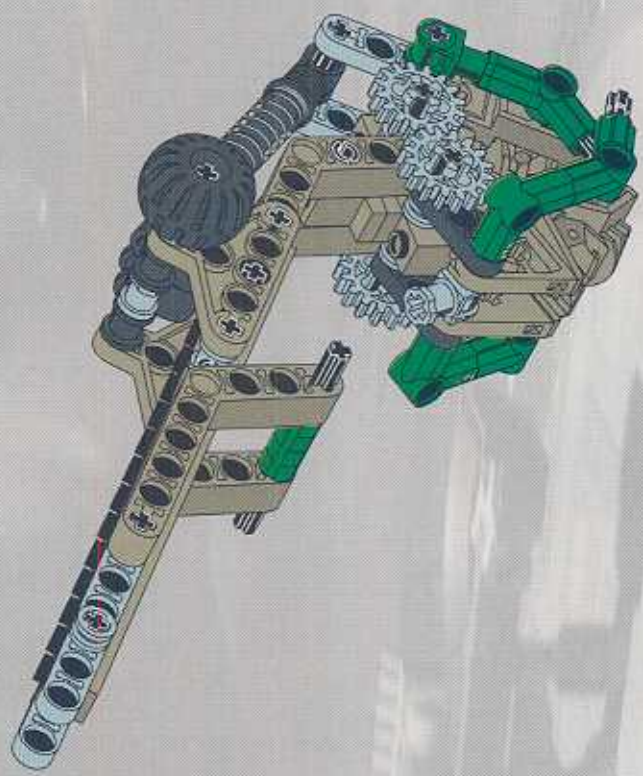

24



 **23**  
1x  



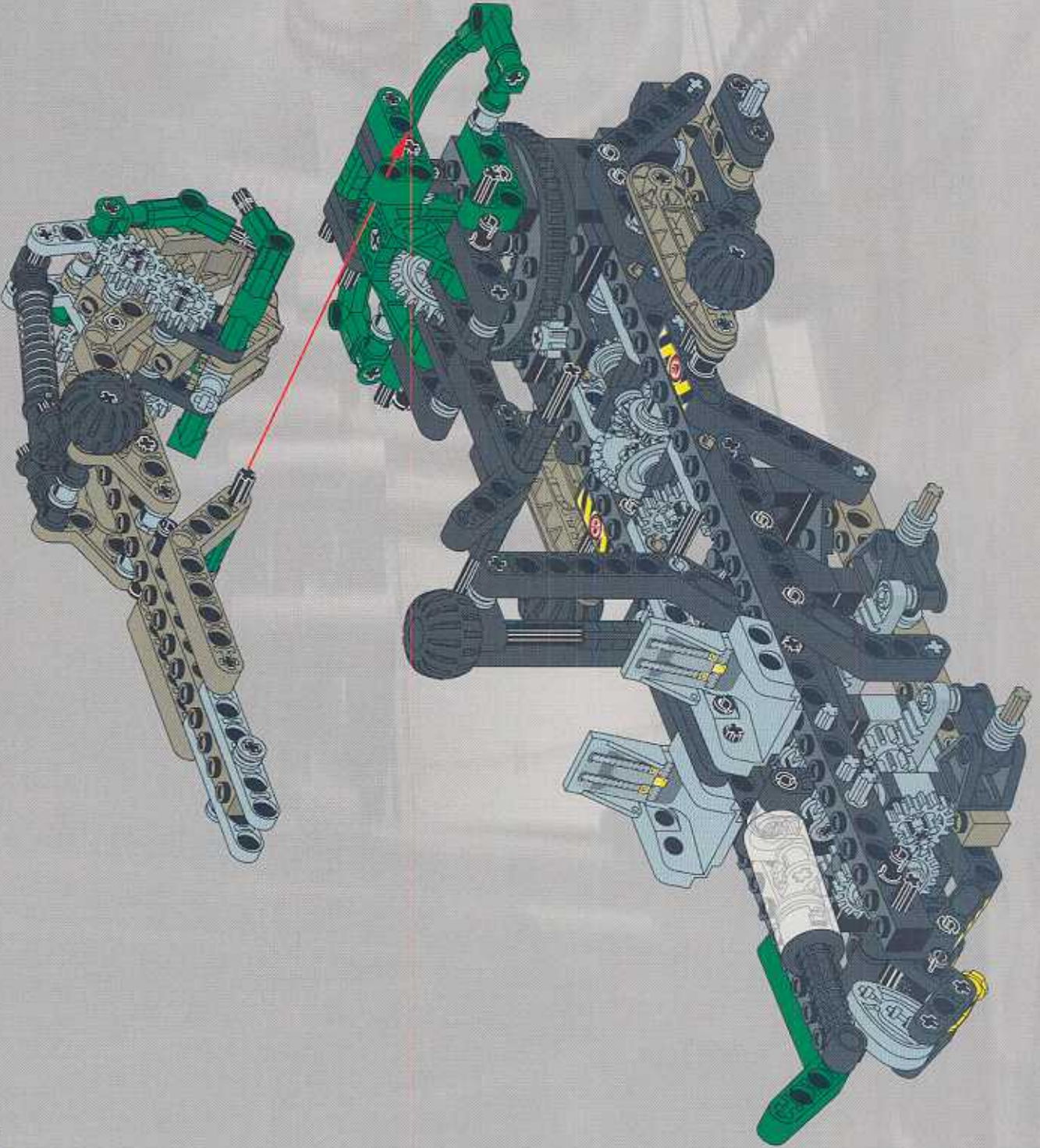



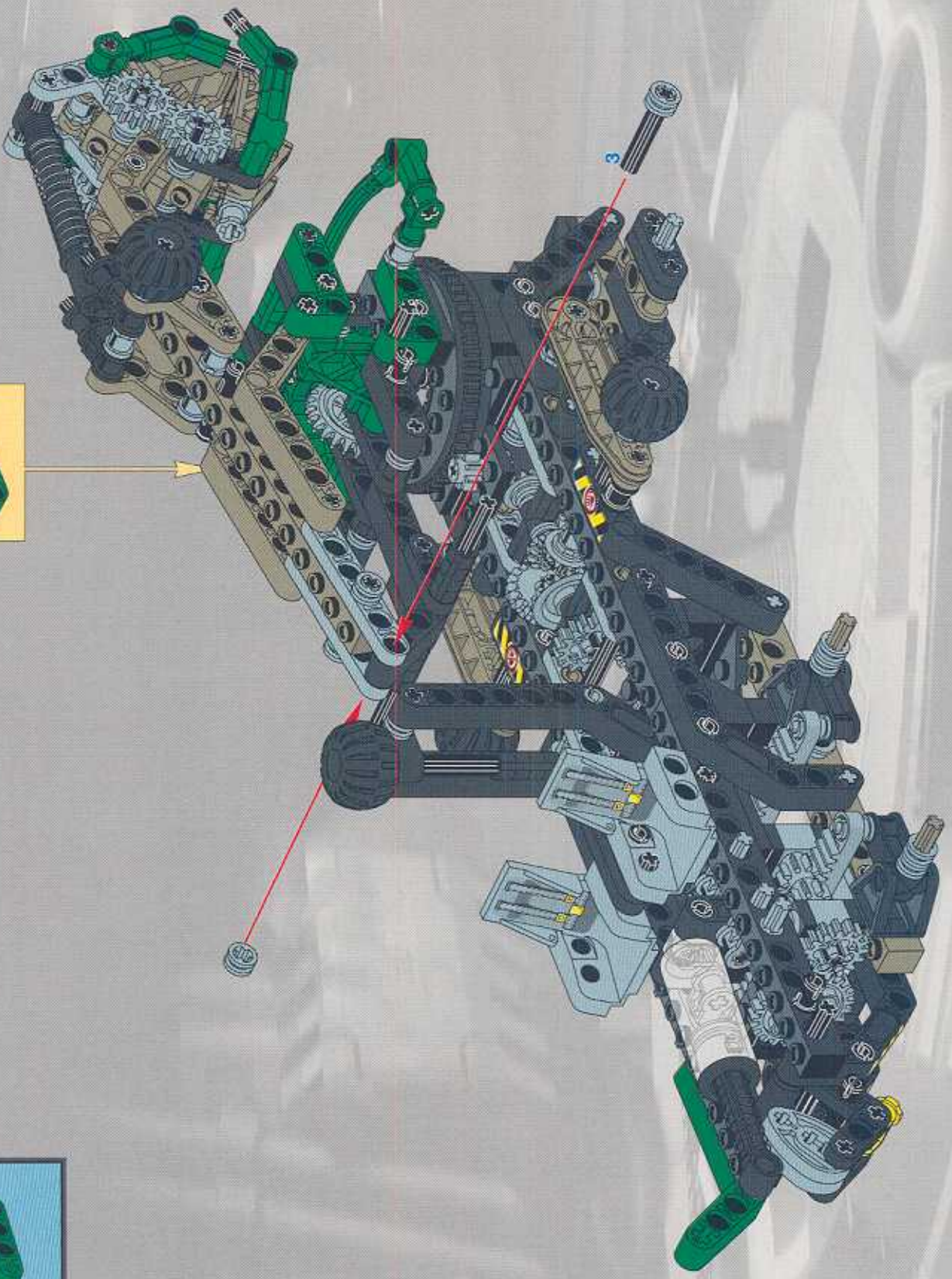

**40**

2x 1x

3

1x

1x



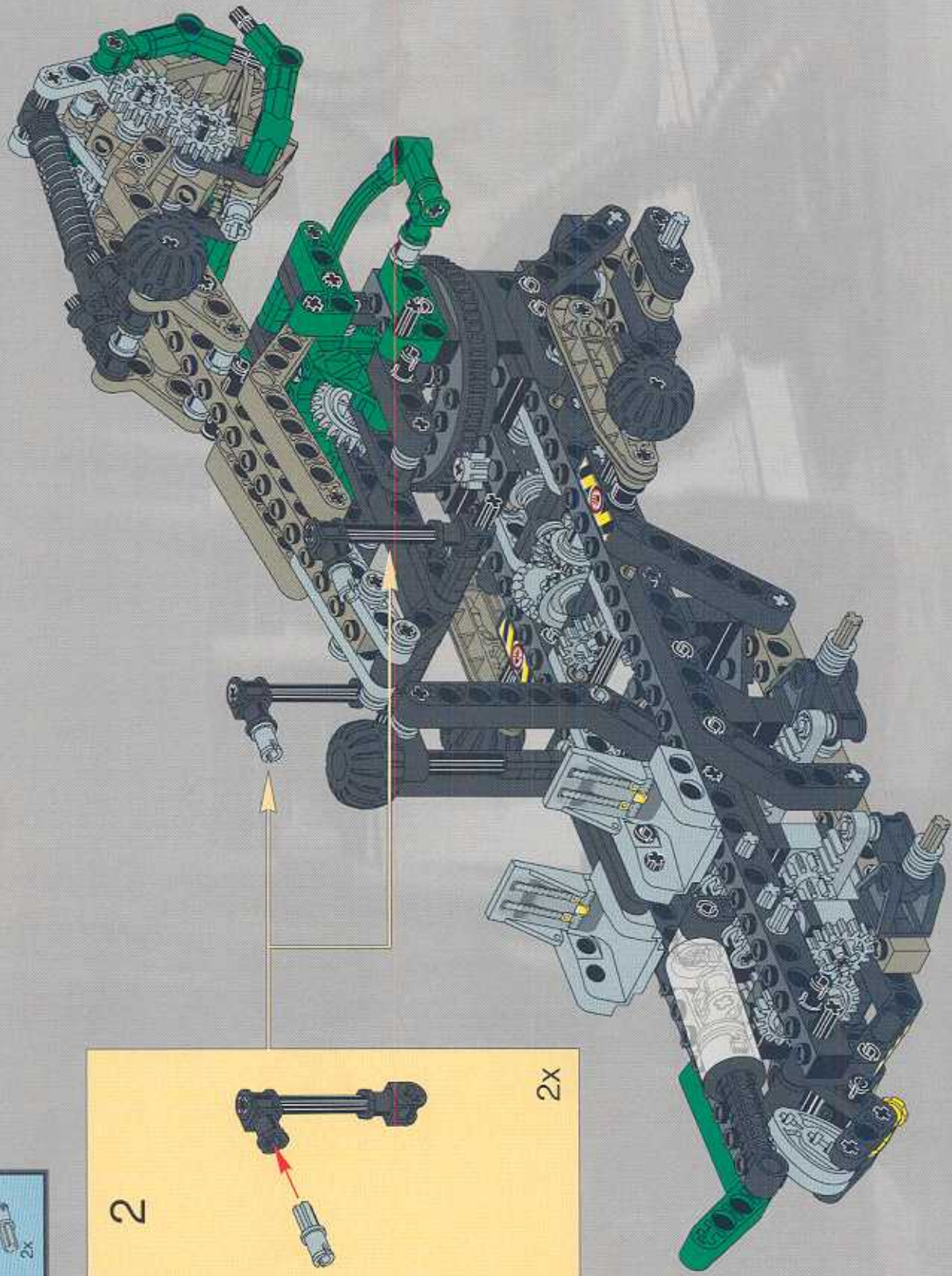
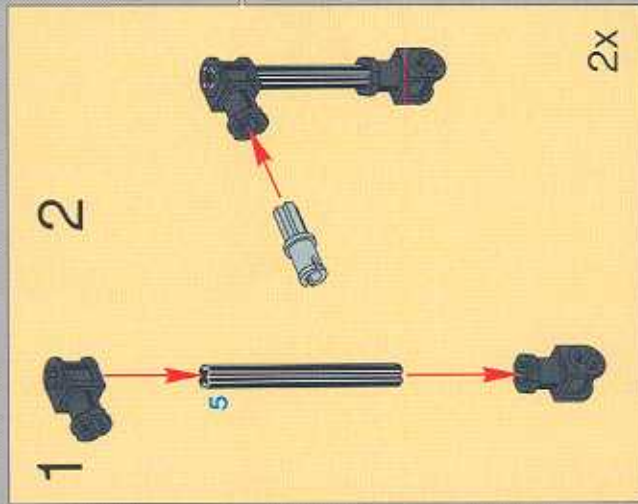







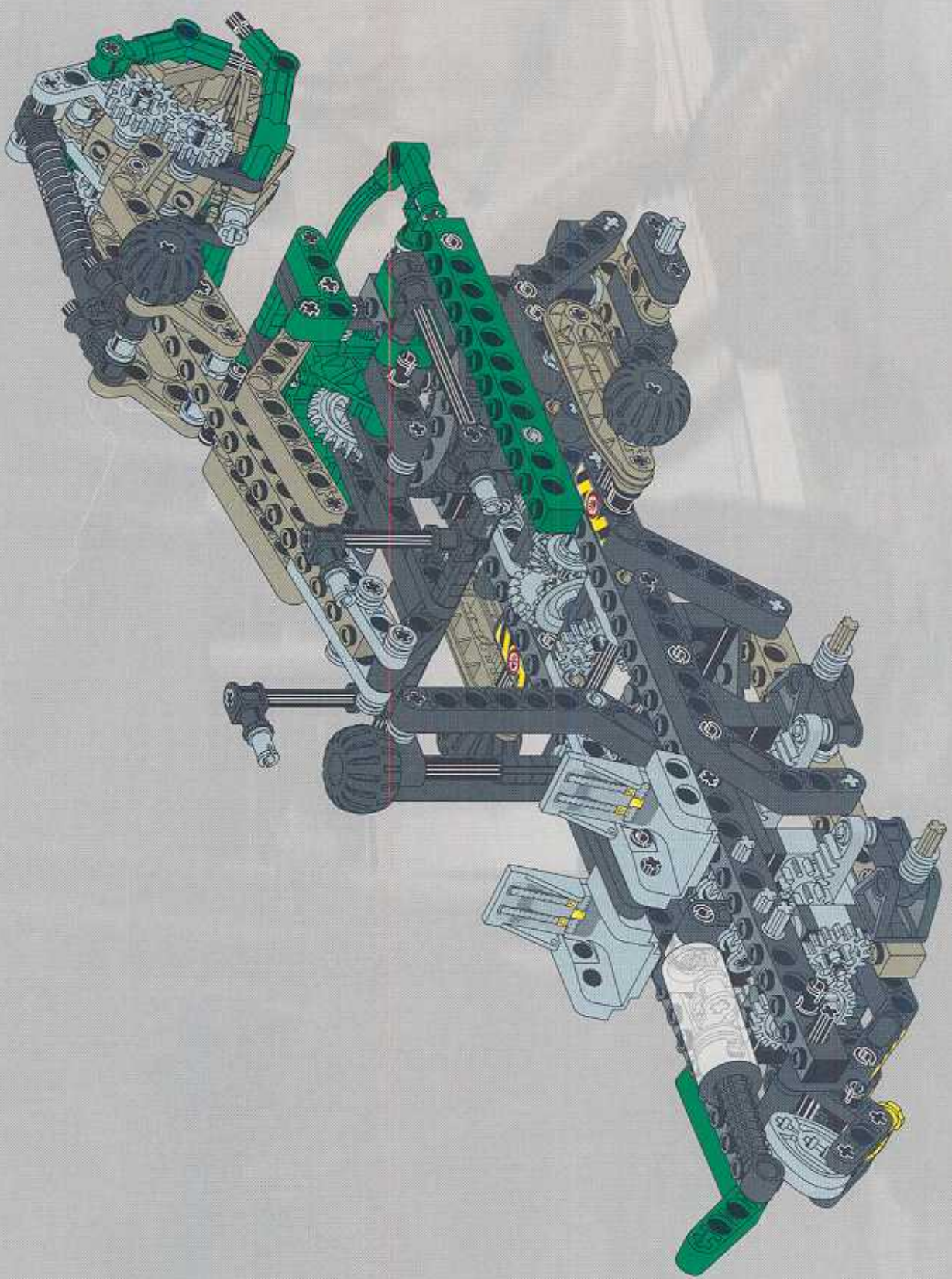







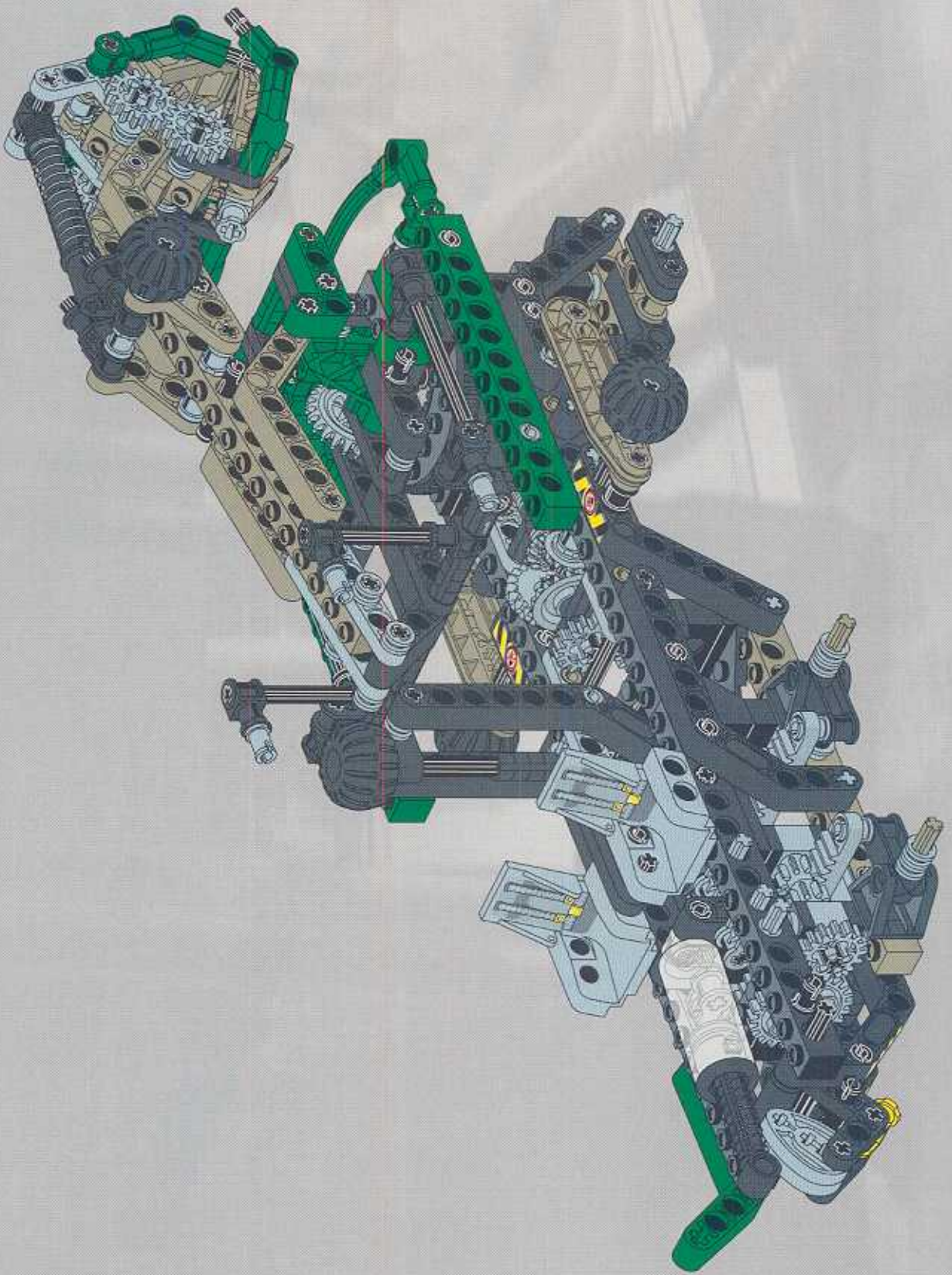



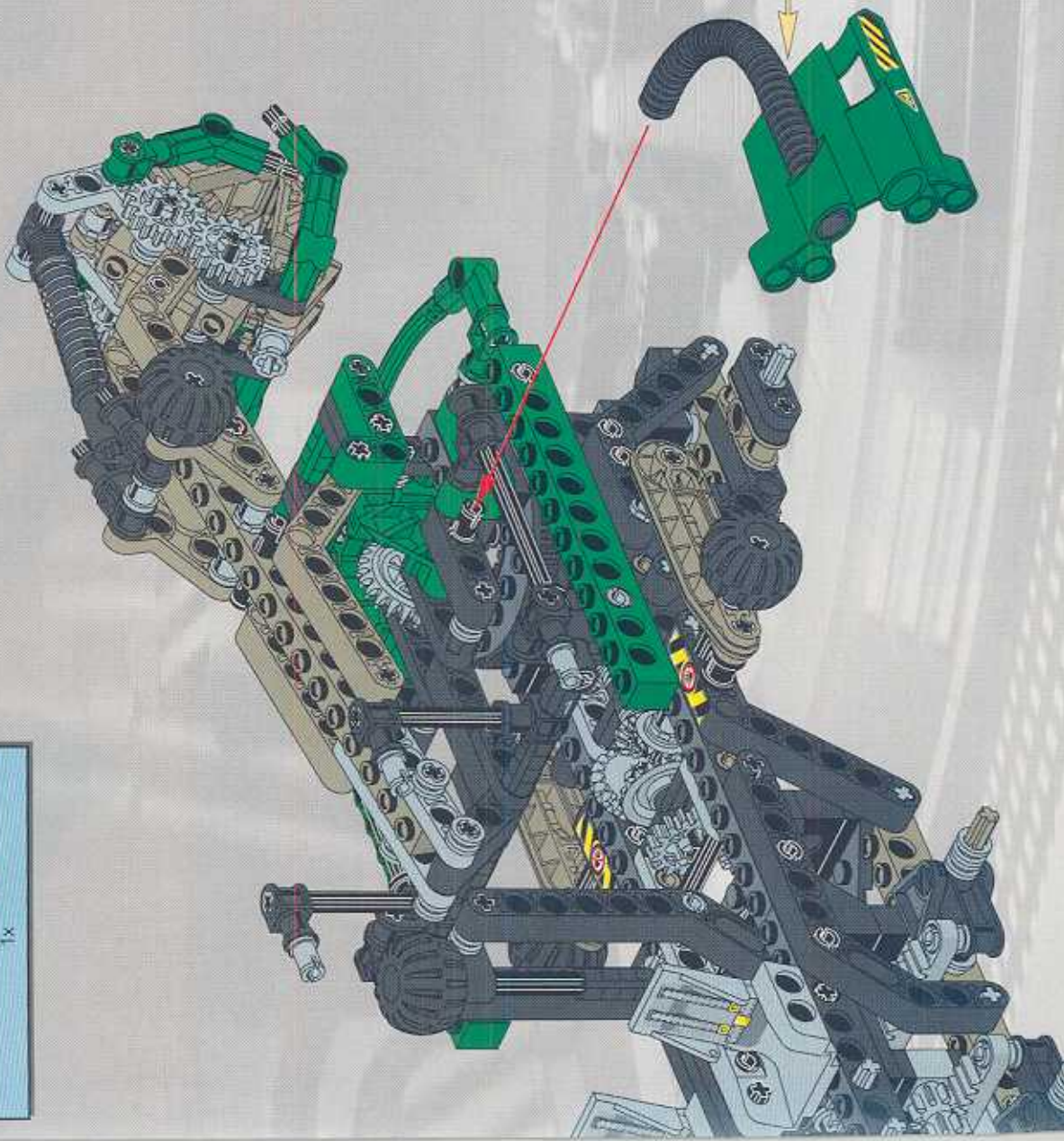
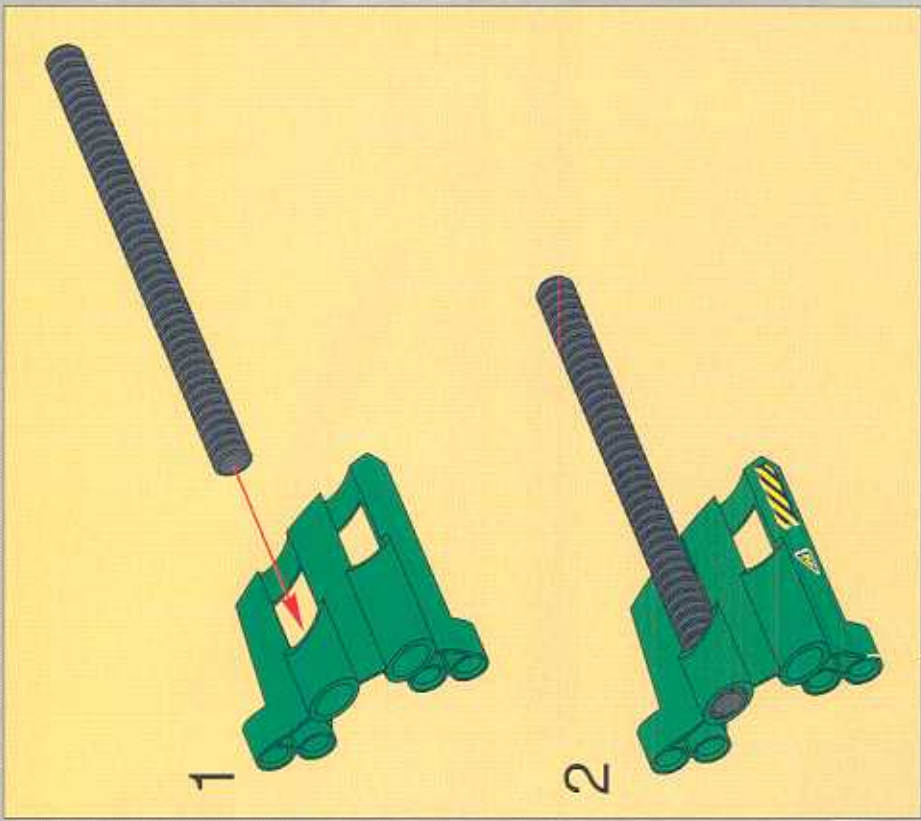
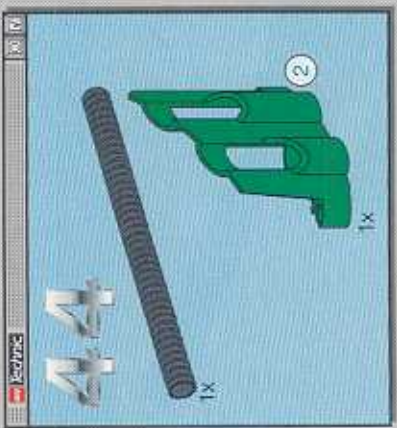



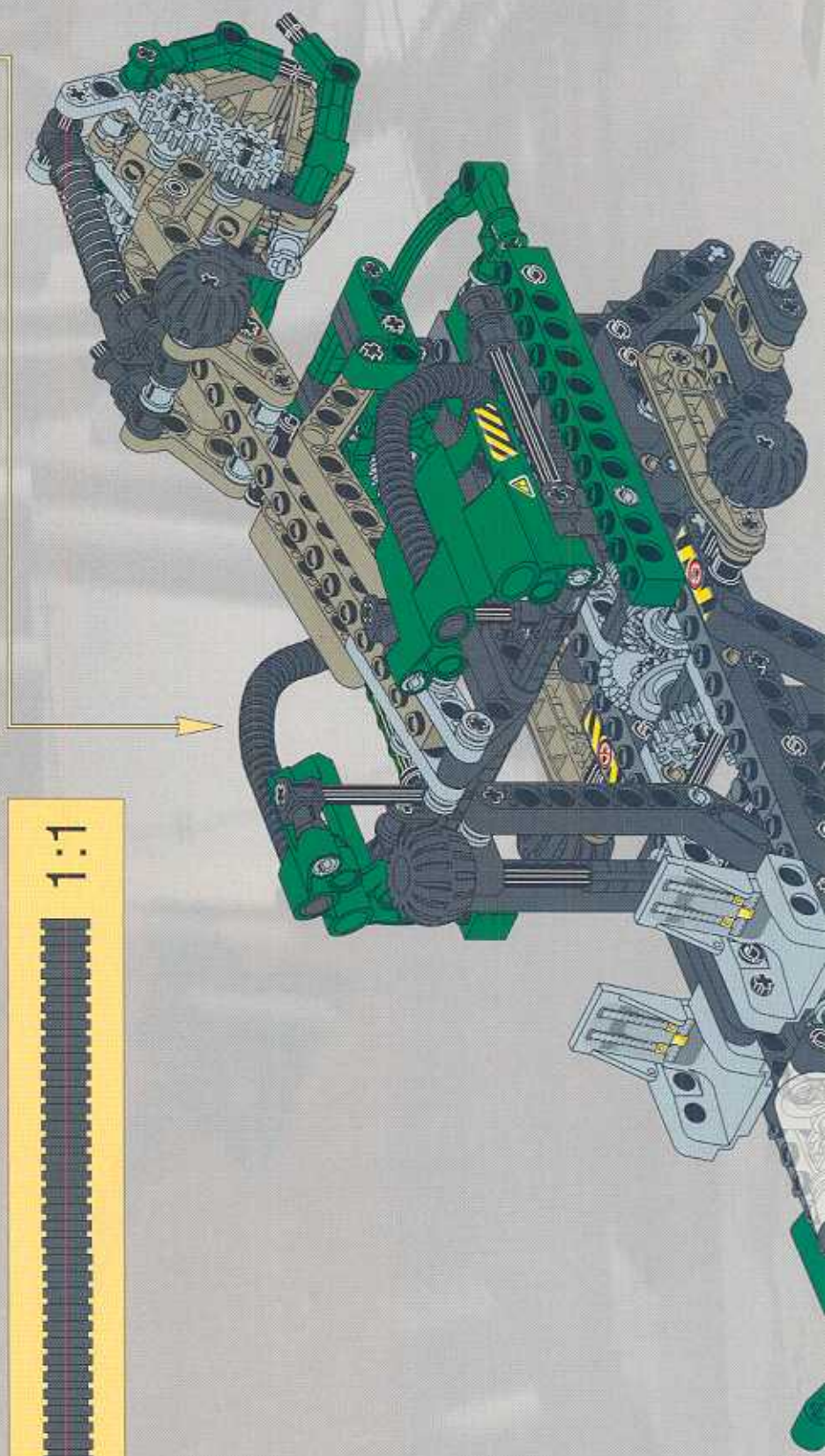
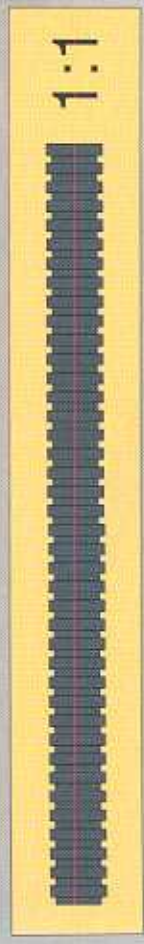
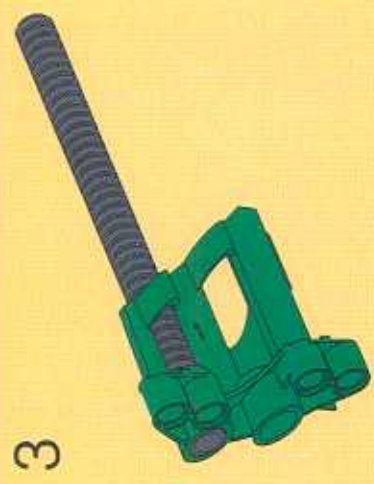
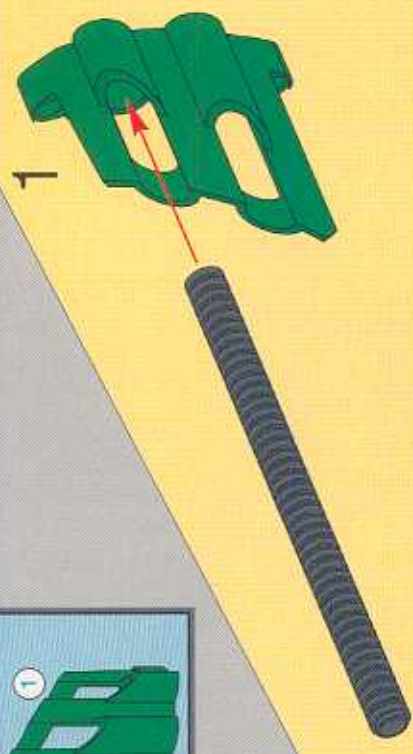



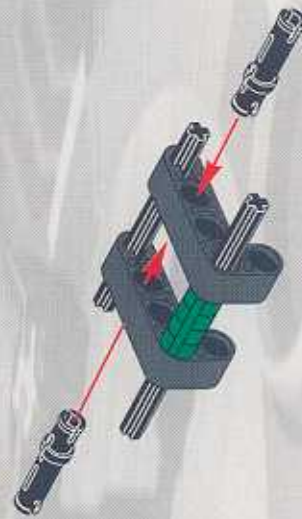
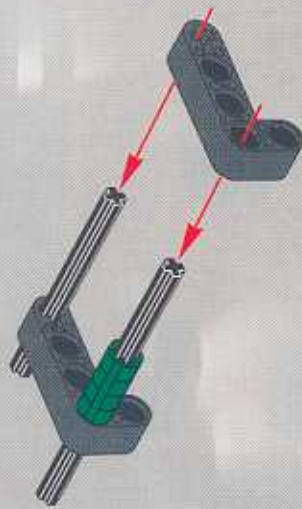
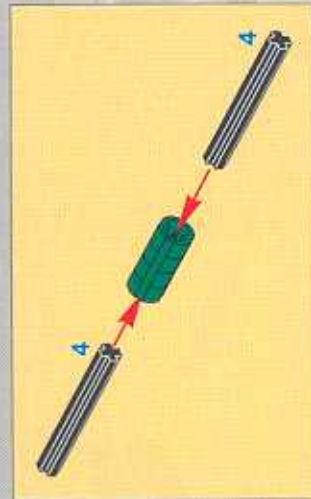



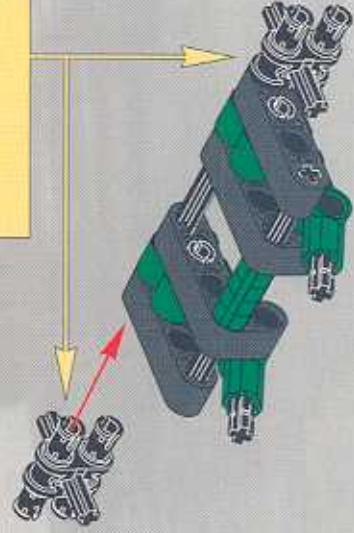
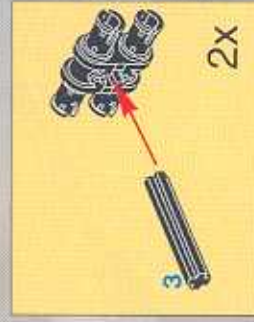
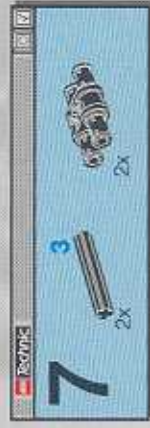
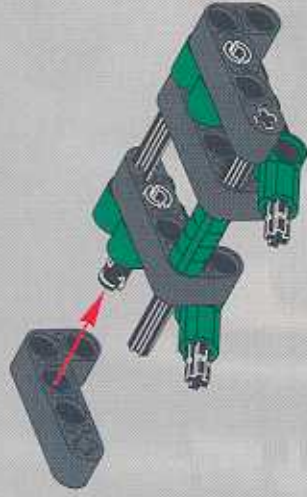
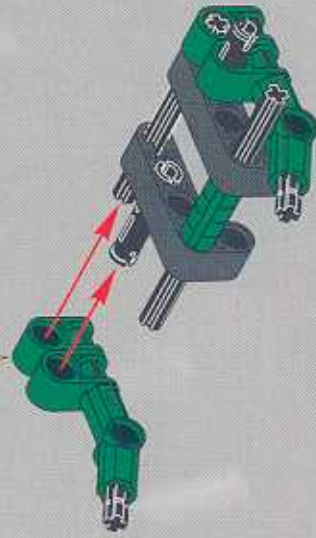
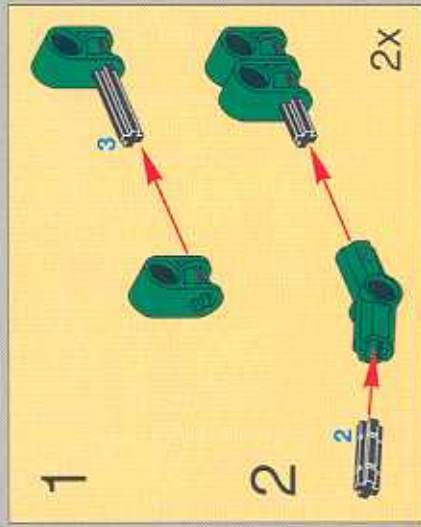
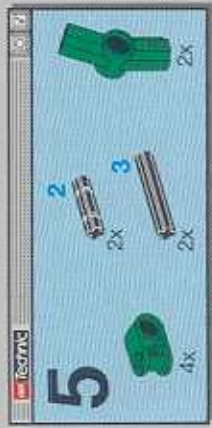







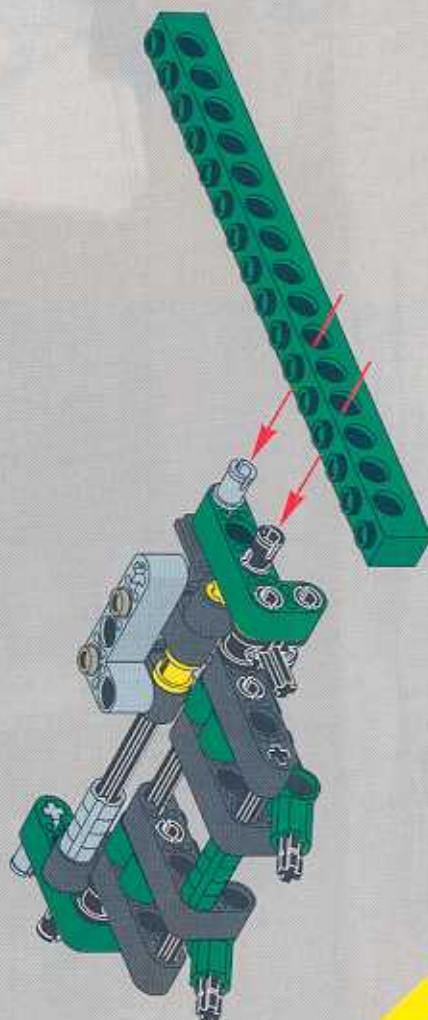
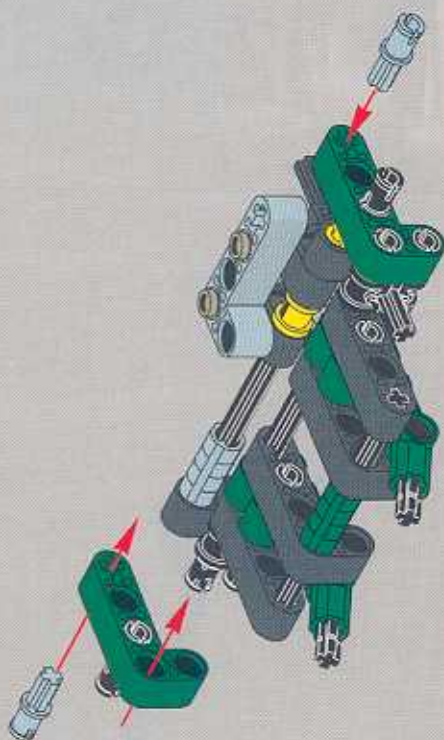
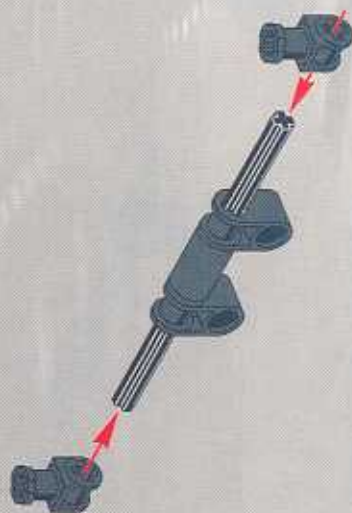
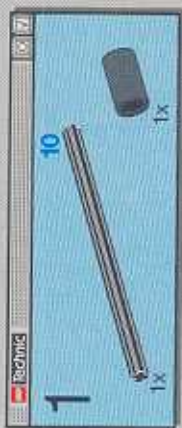



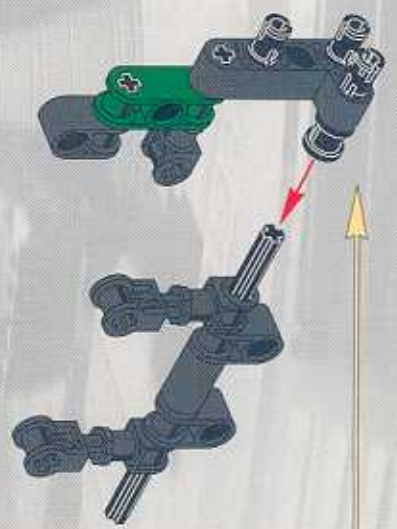
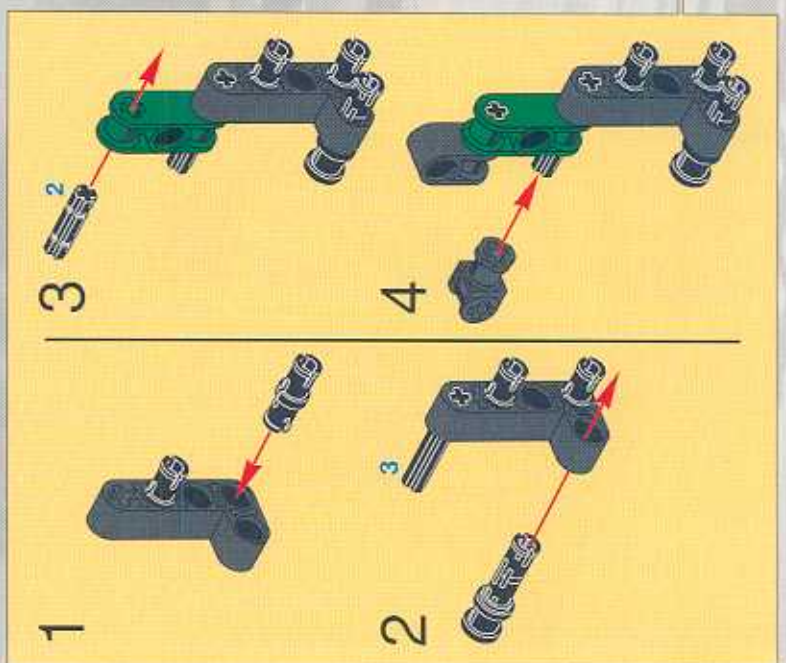
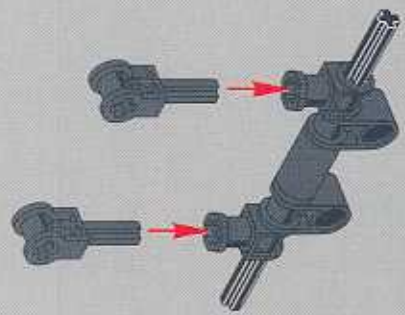
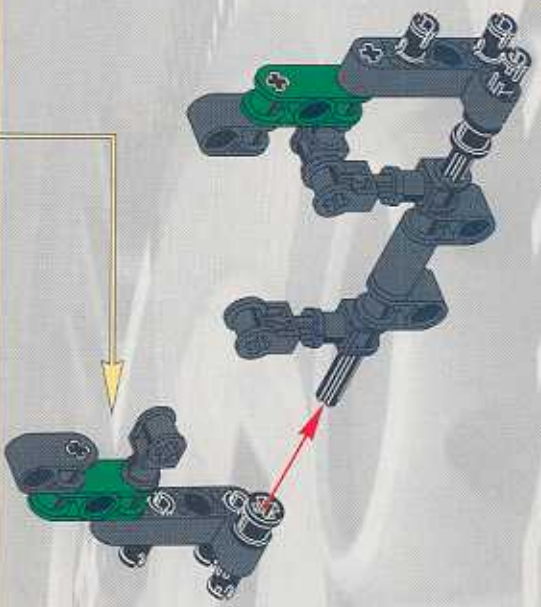
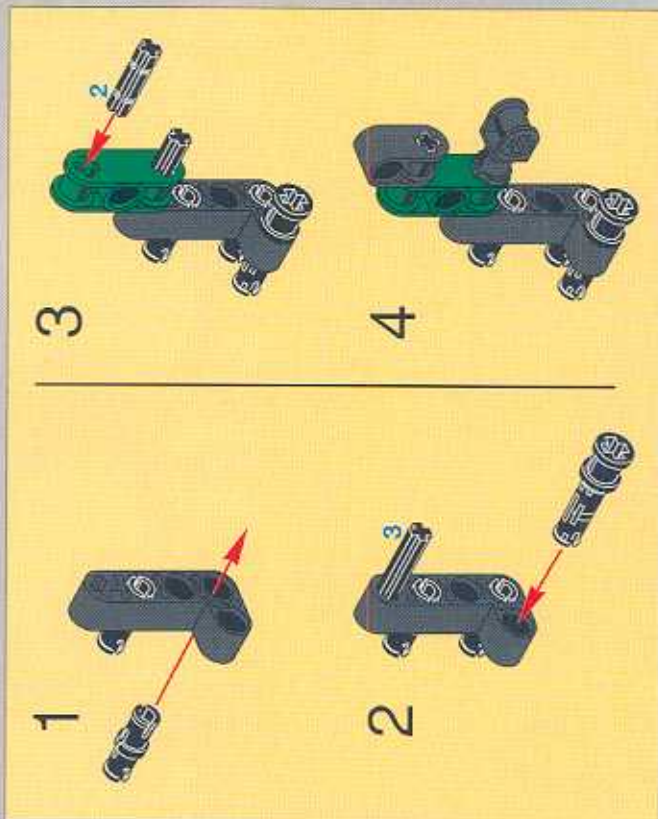
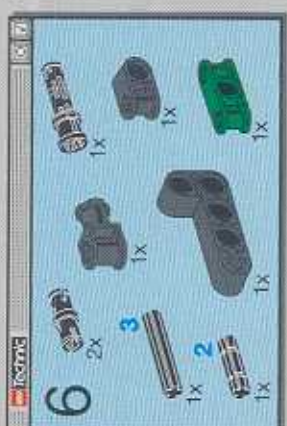



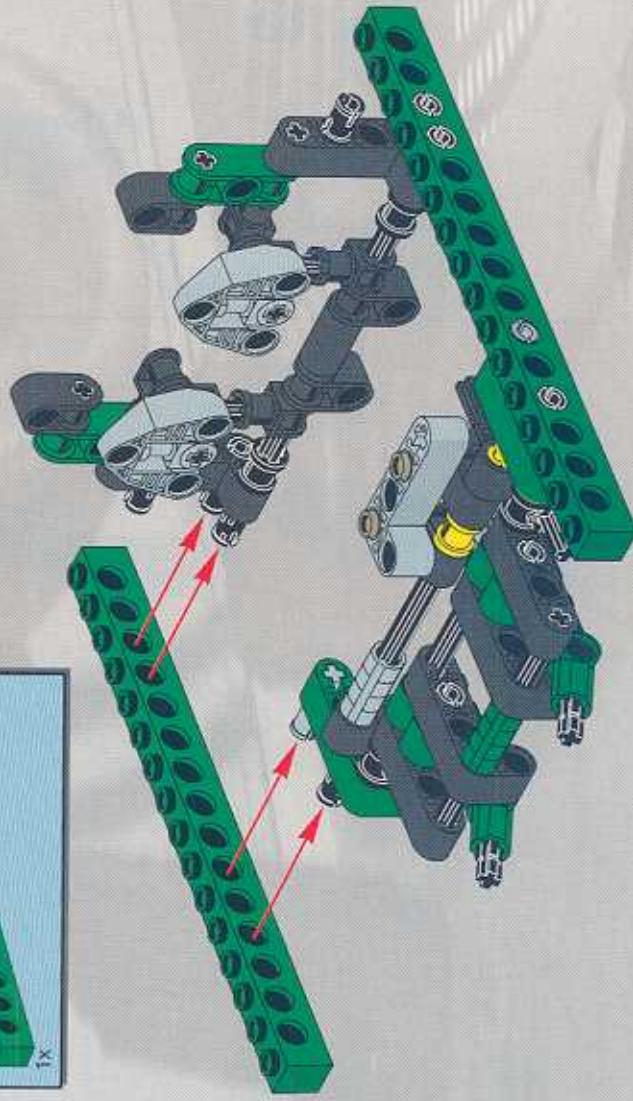
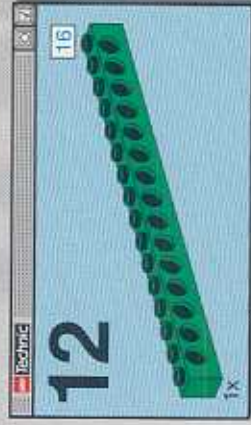
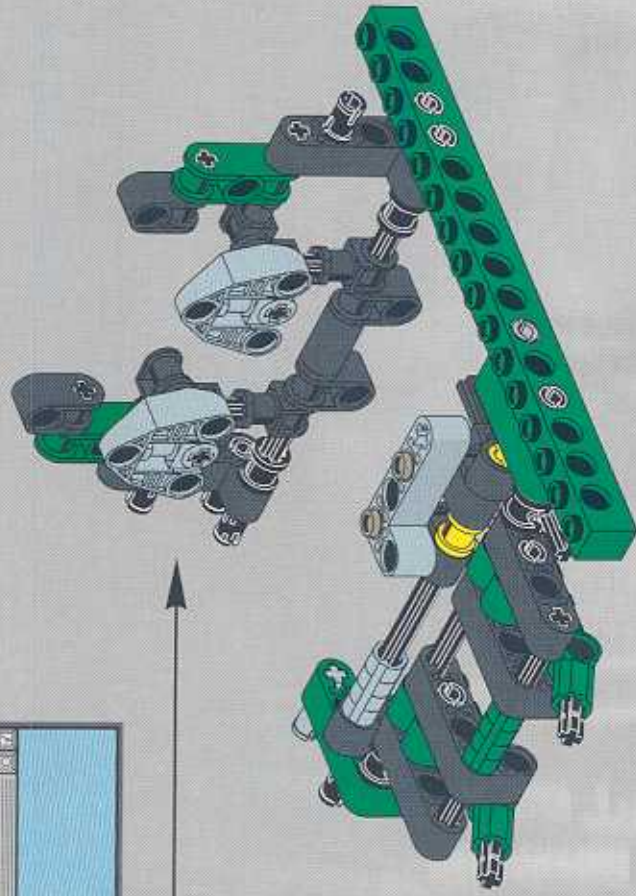
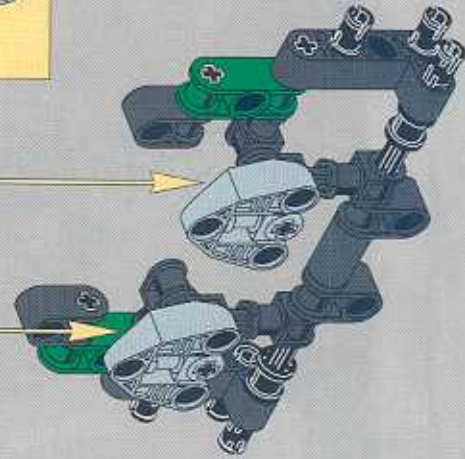
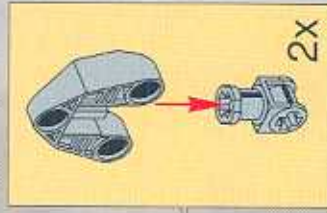
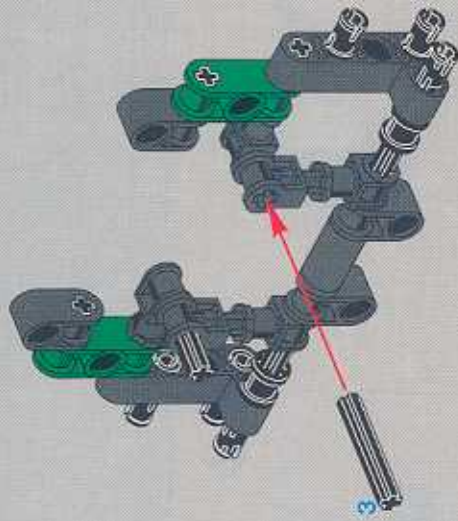







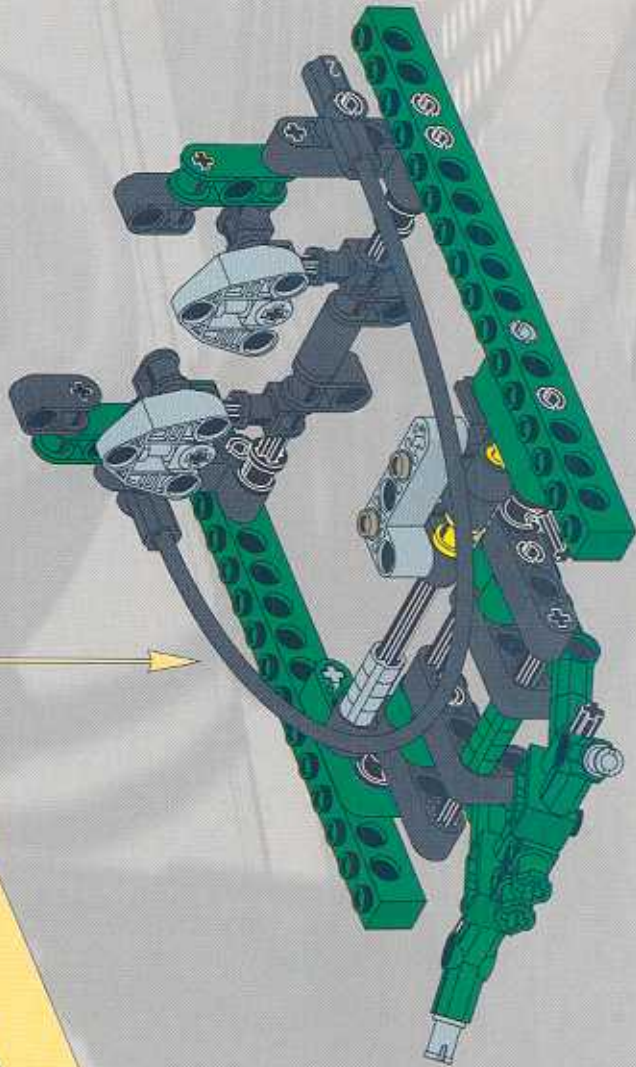
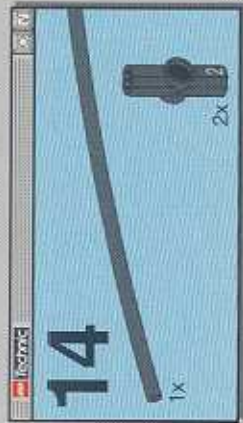
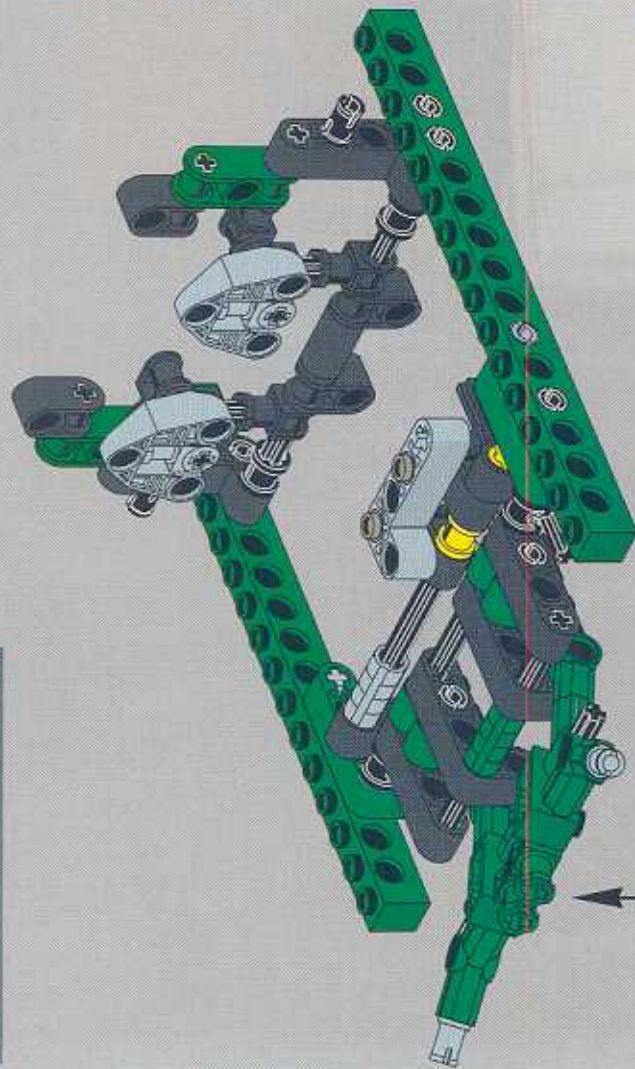



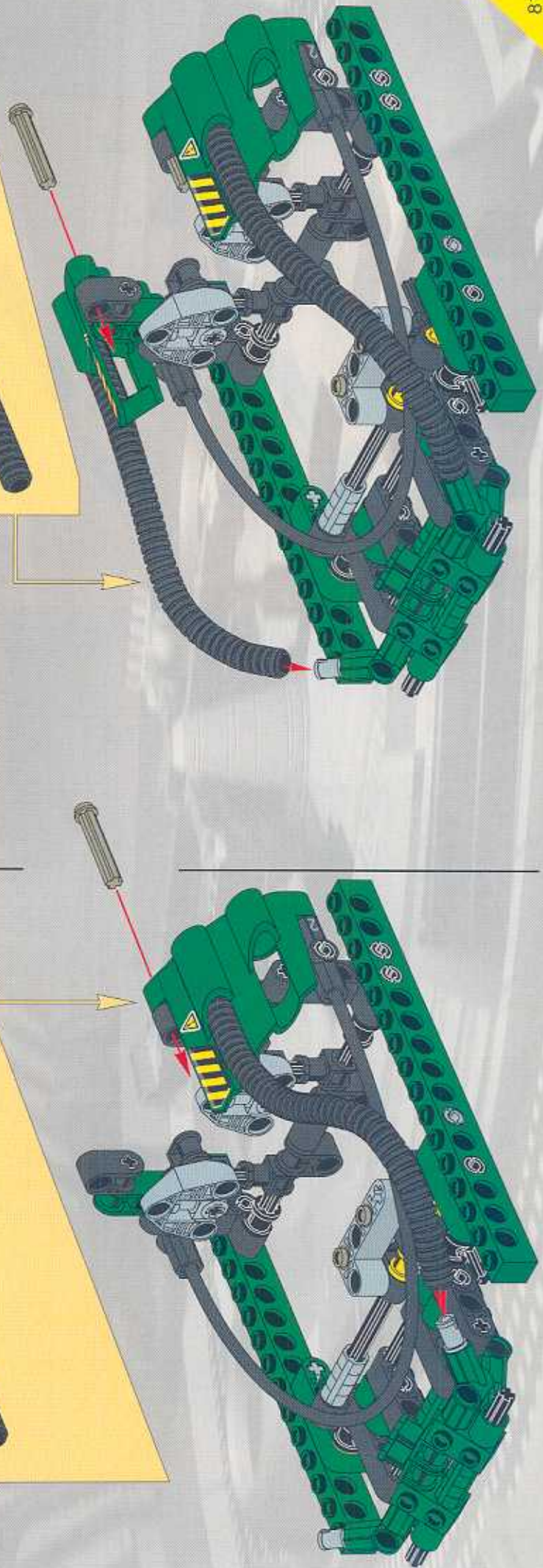
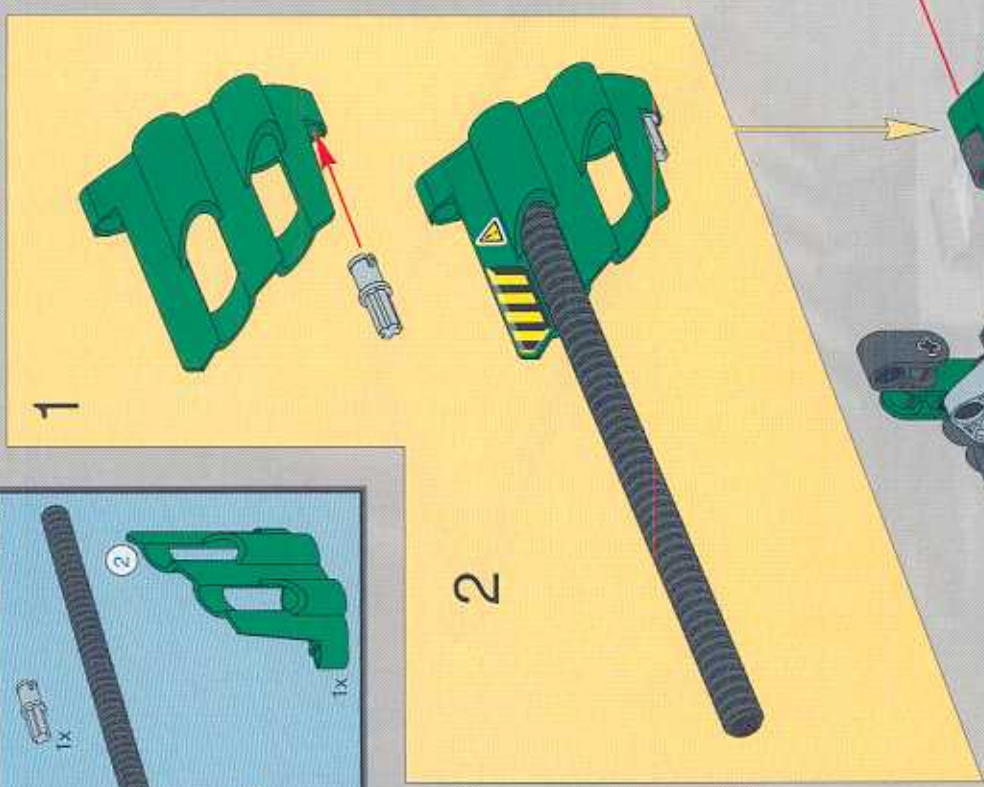
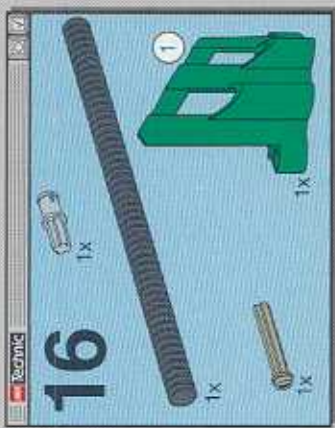
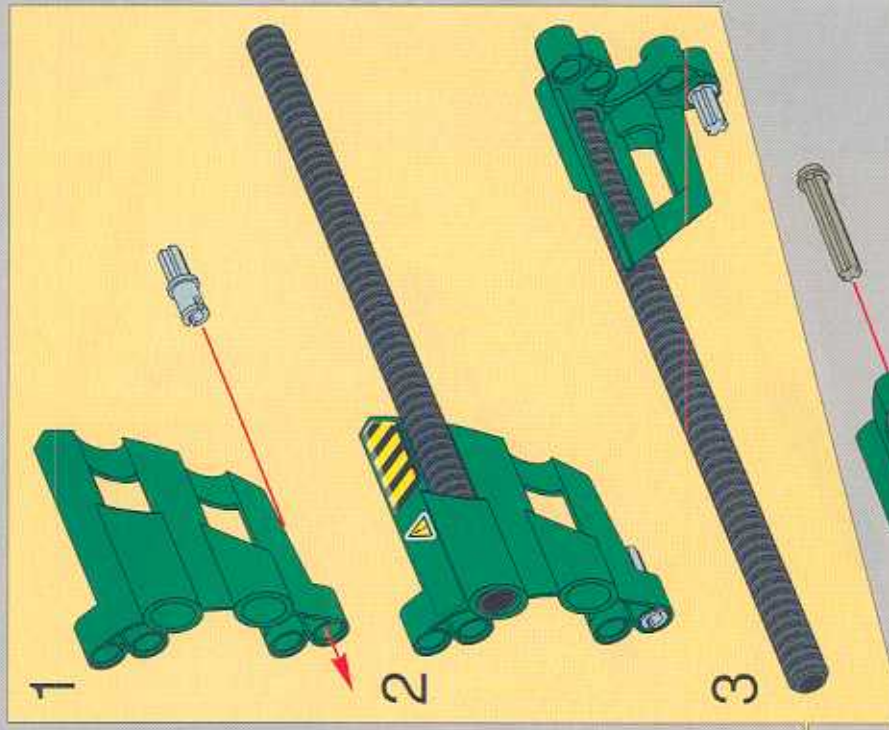



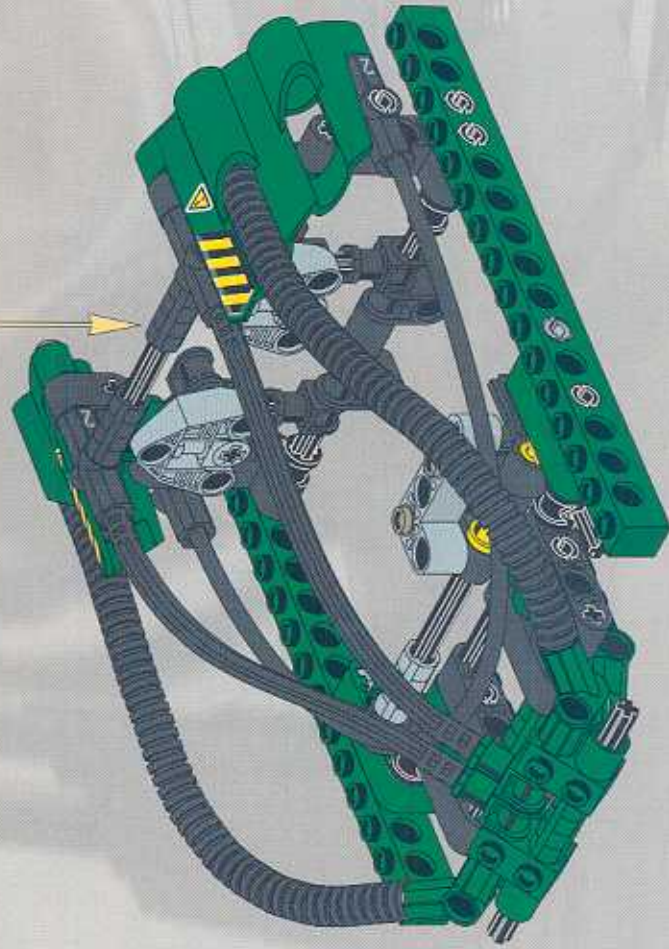
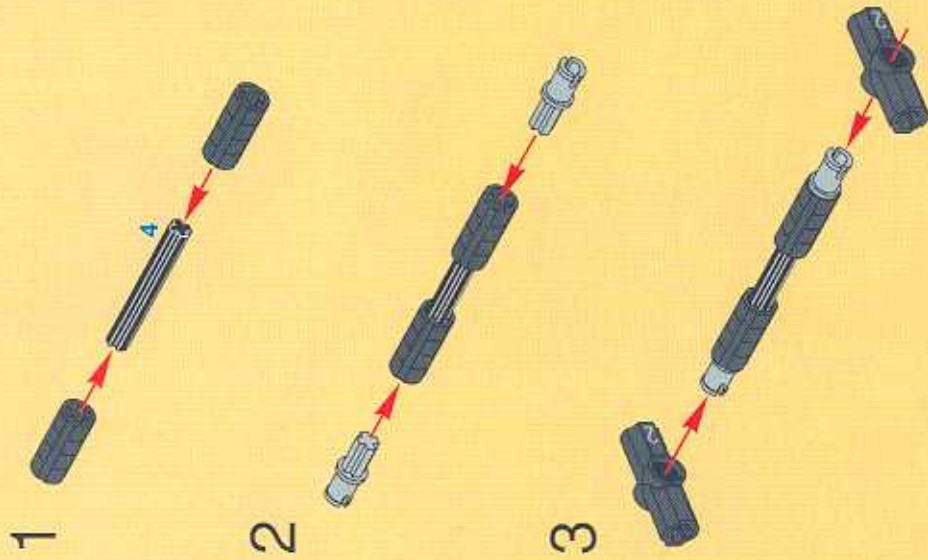
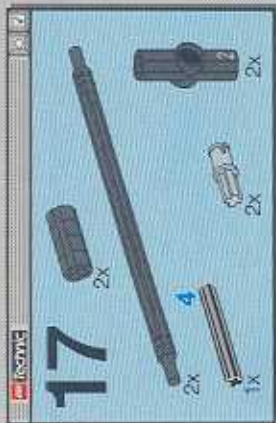



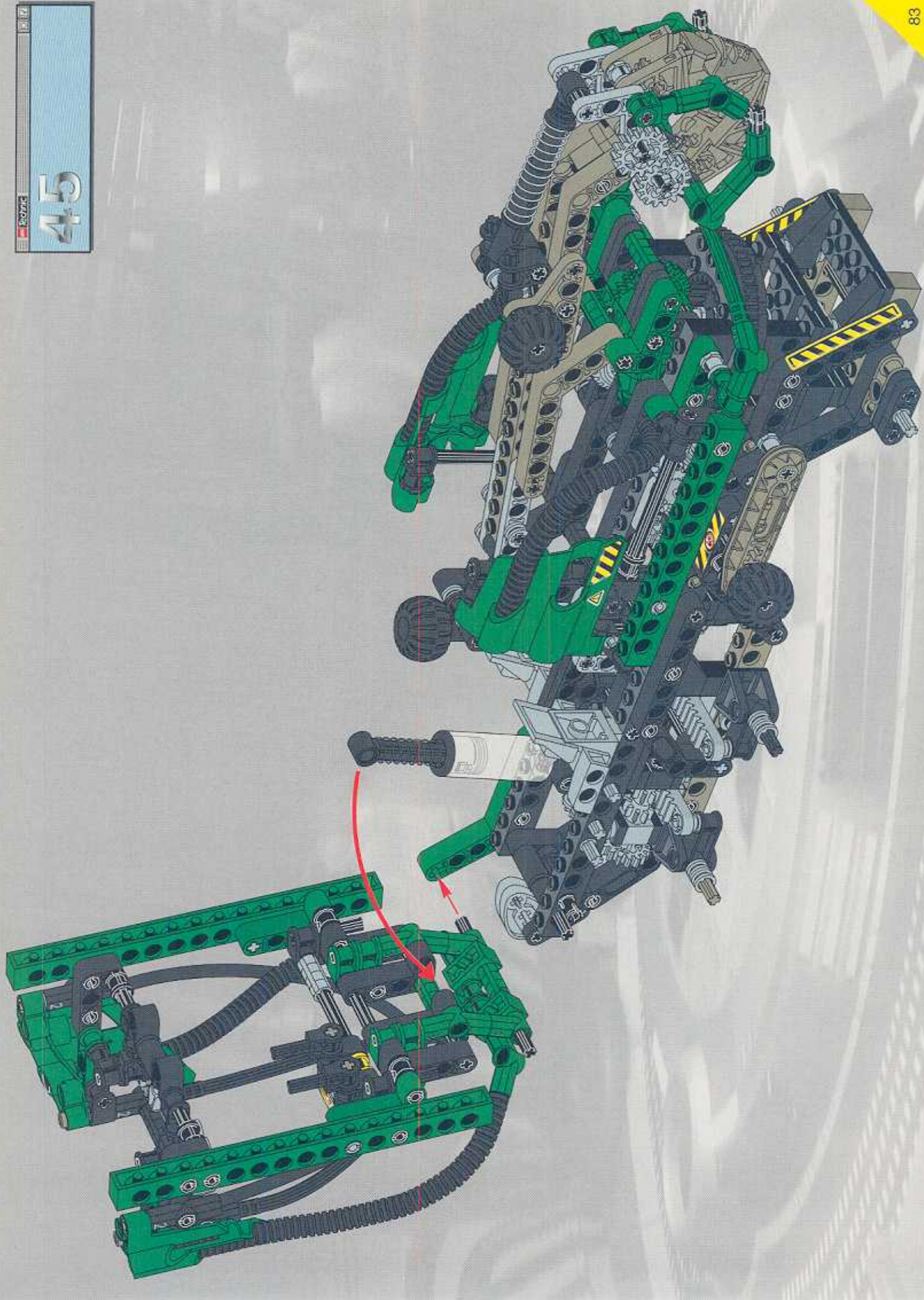



LEGO Technic

46

8

1x

1x

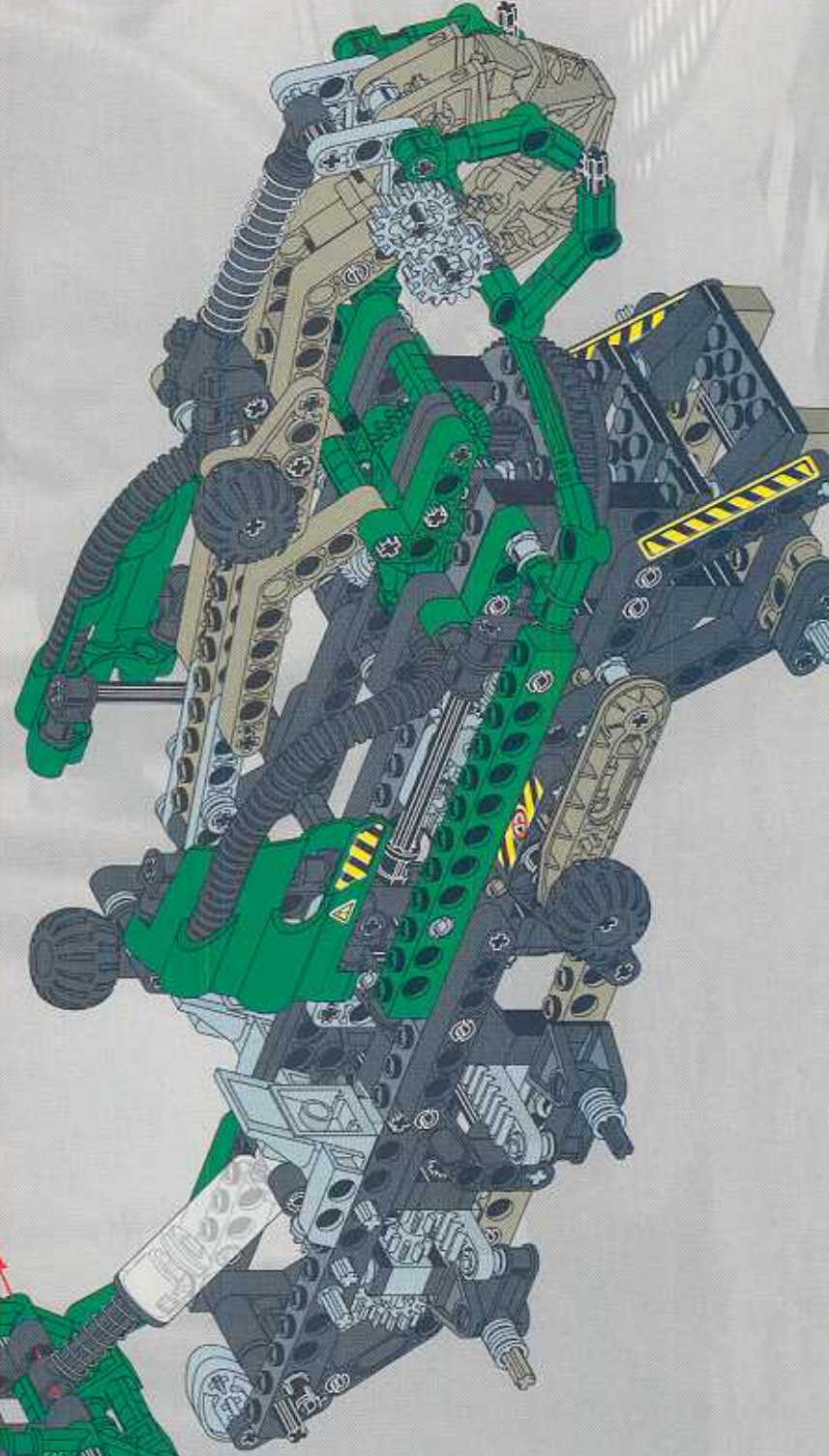
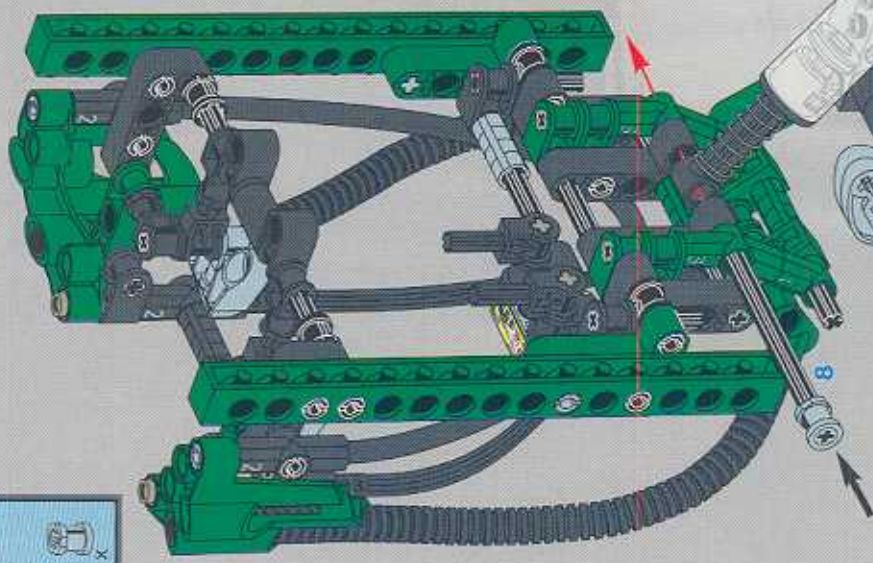



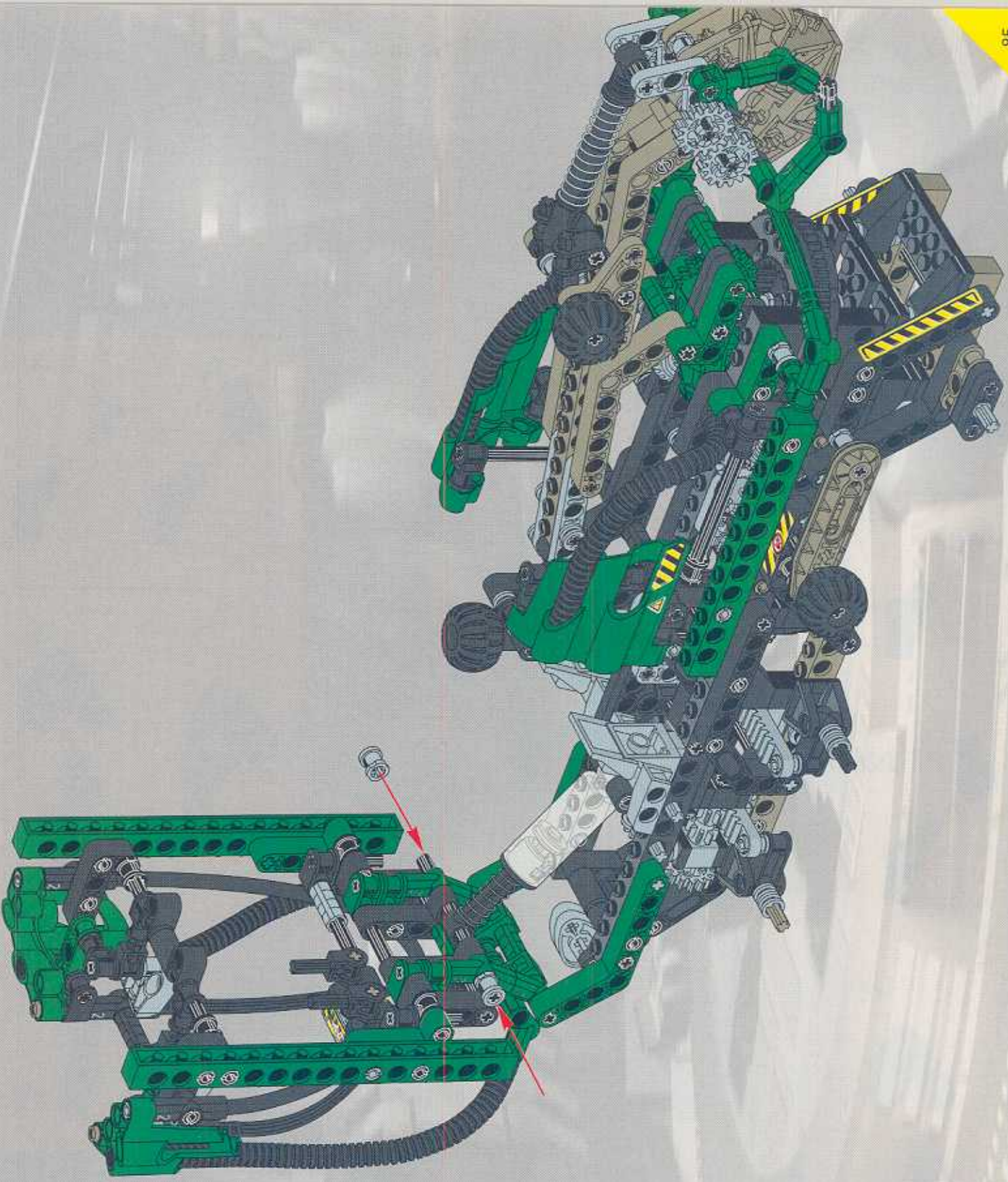

LEGO Technic

47

1x

1x



48

- 2x 1/2 Pin
- 2x 1/2 Pin
- 2x 1/2 Pin
- 2x 1/2 Pin
- 2x 1/2 Pin
- 2x 1/2 Pin
- 2x 1/2 Pin
- 2x 1/2 Pin

1

2

3

4

5

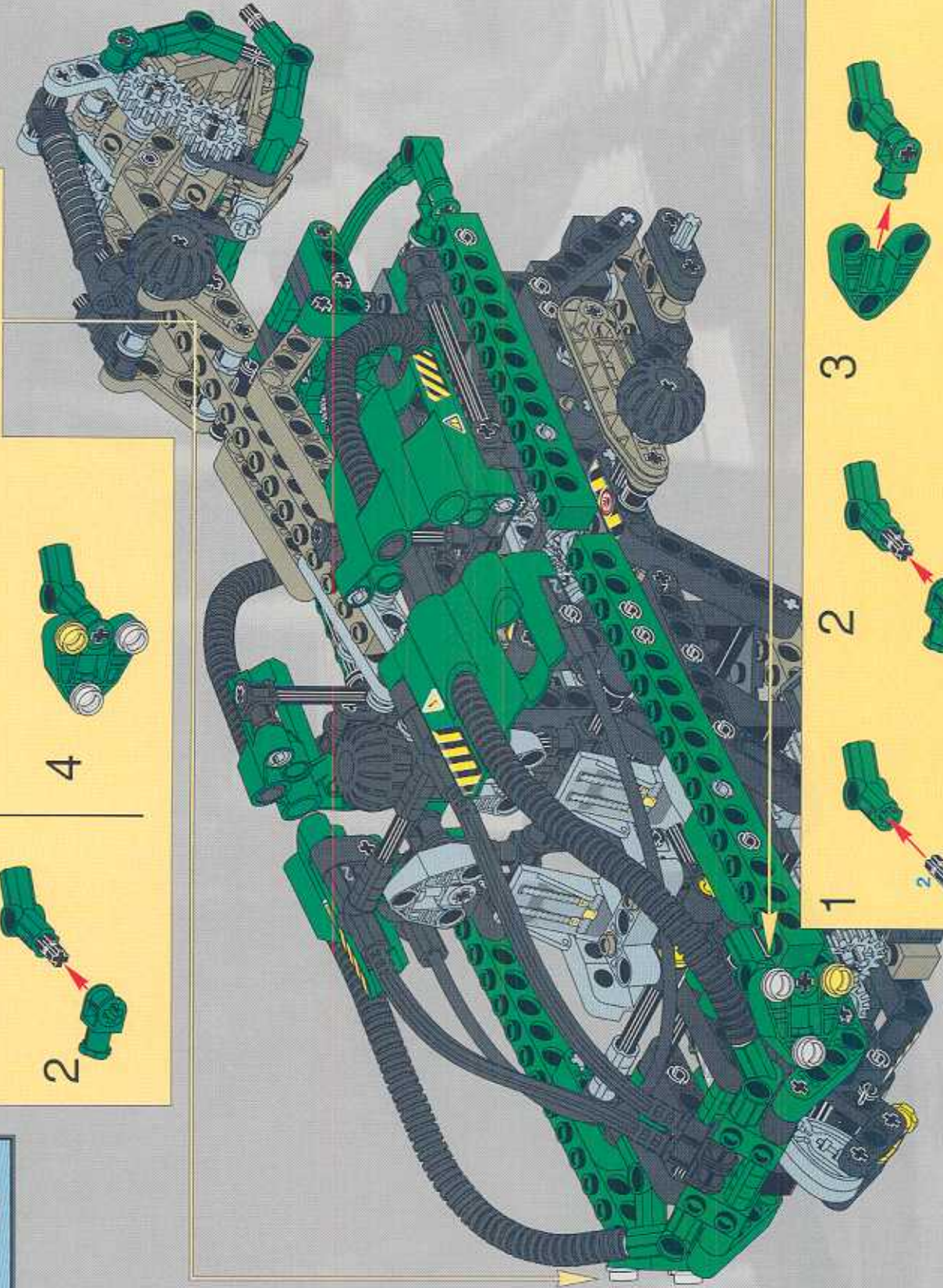

1

2

3

4



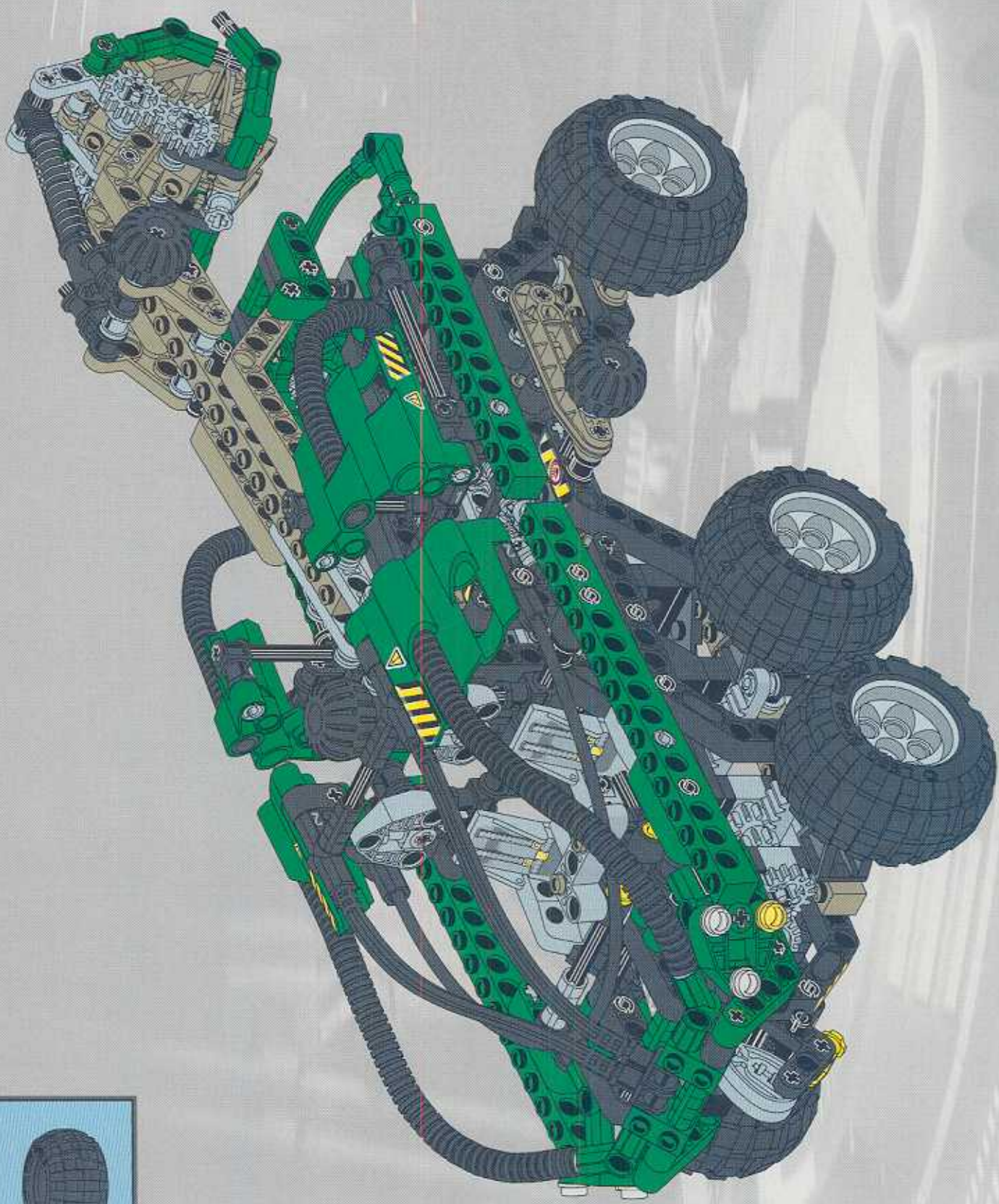

 **49**

 6x

 6x



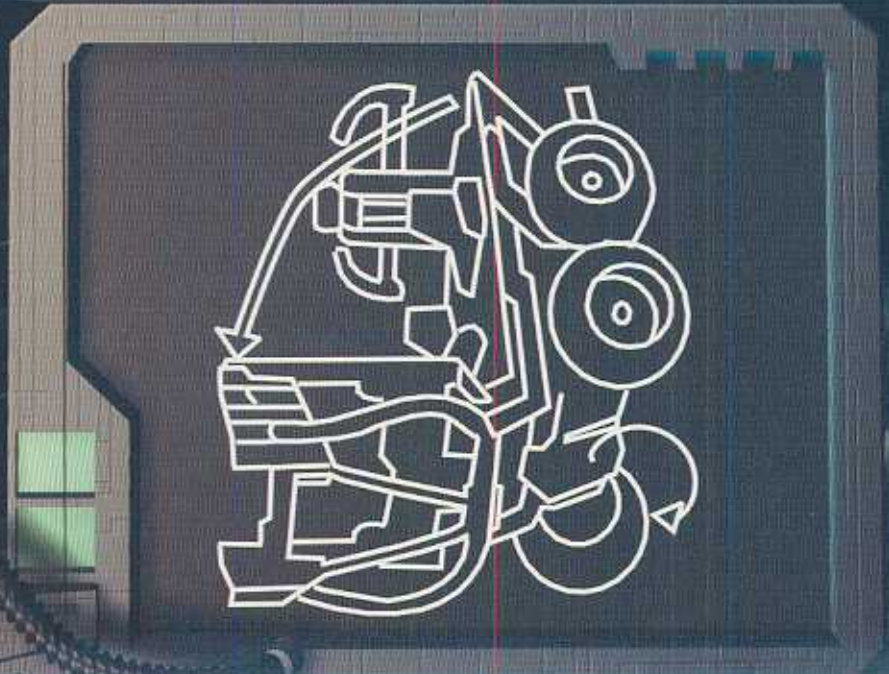
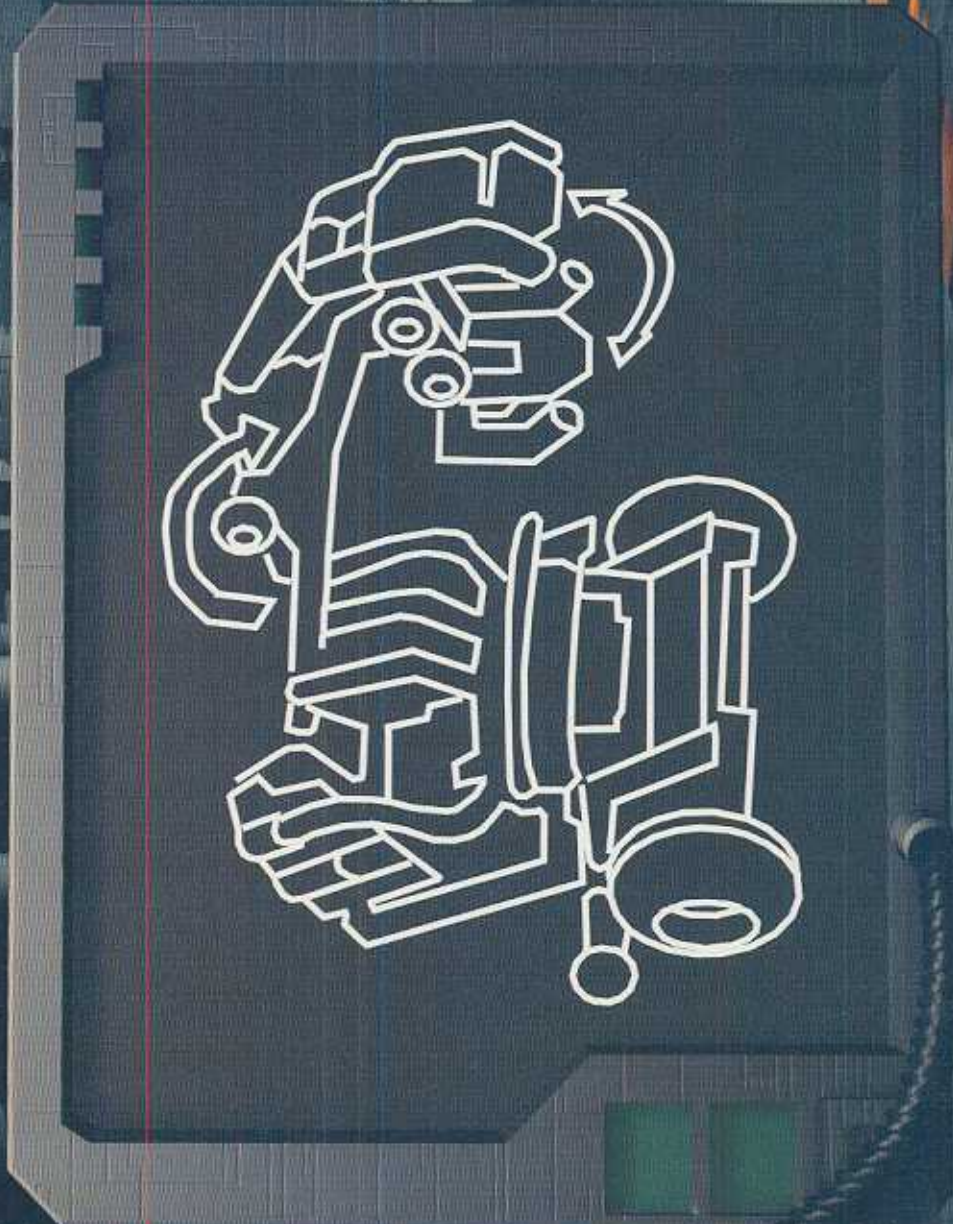
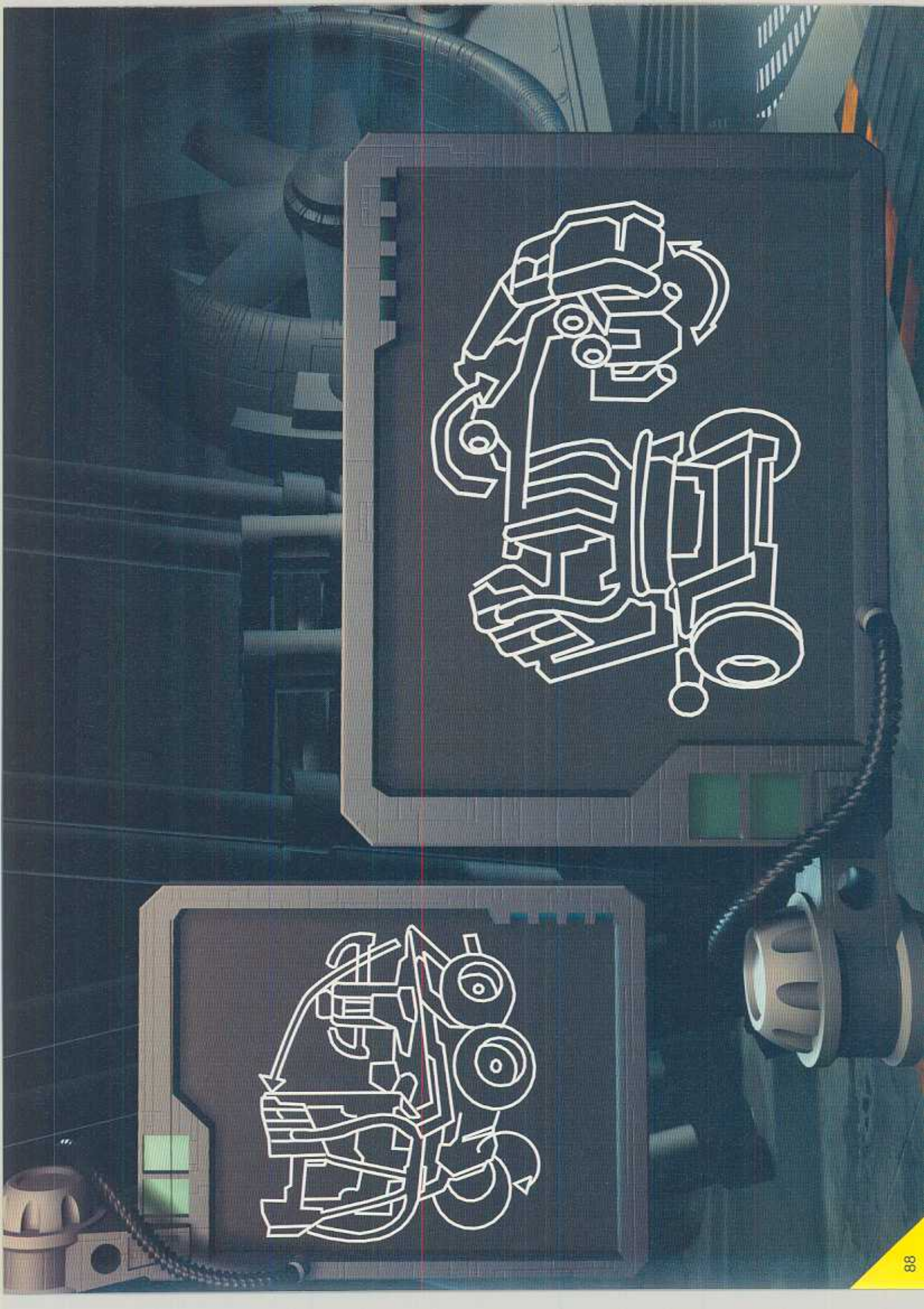







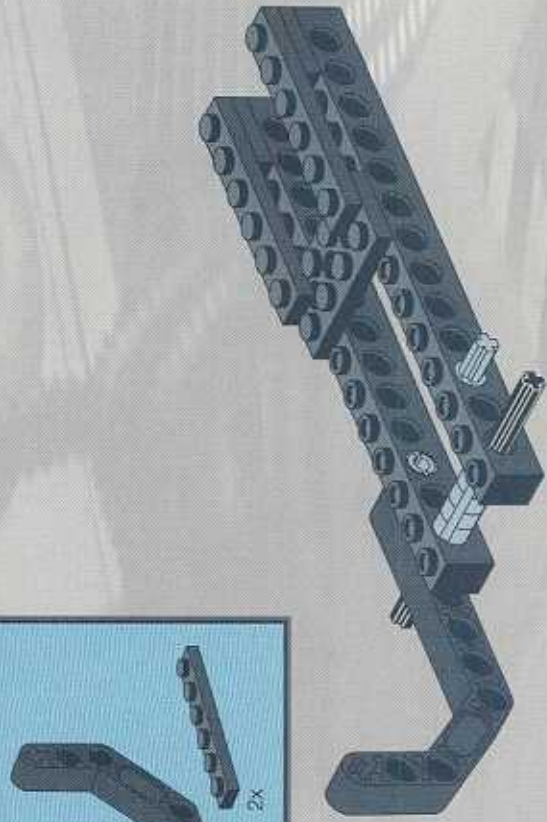
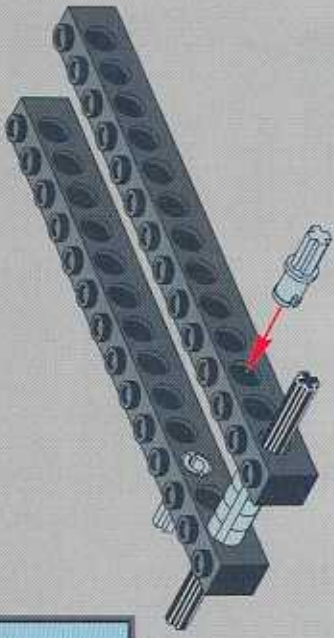
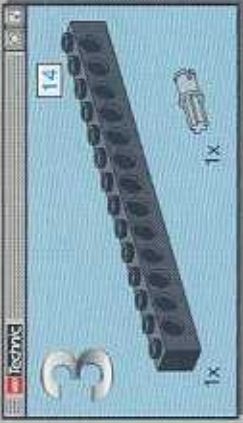
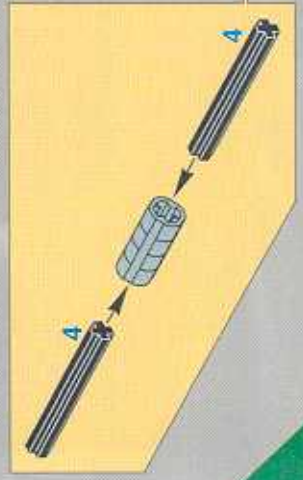
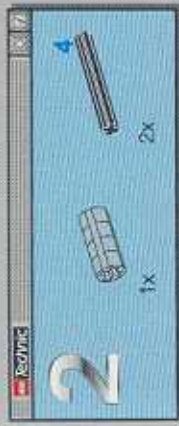
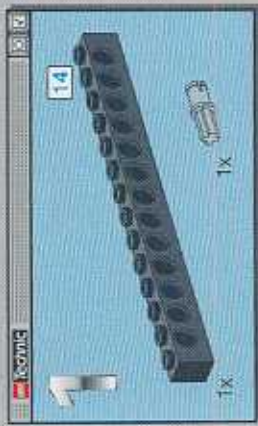



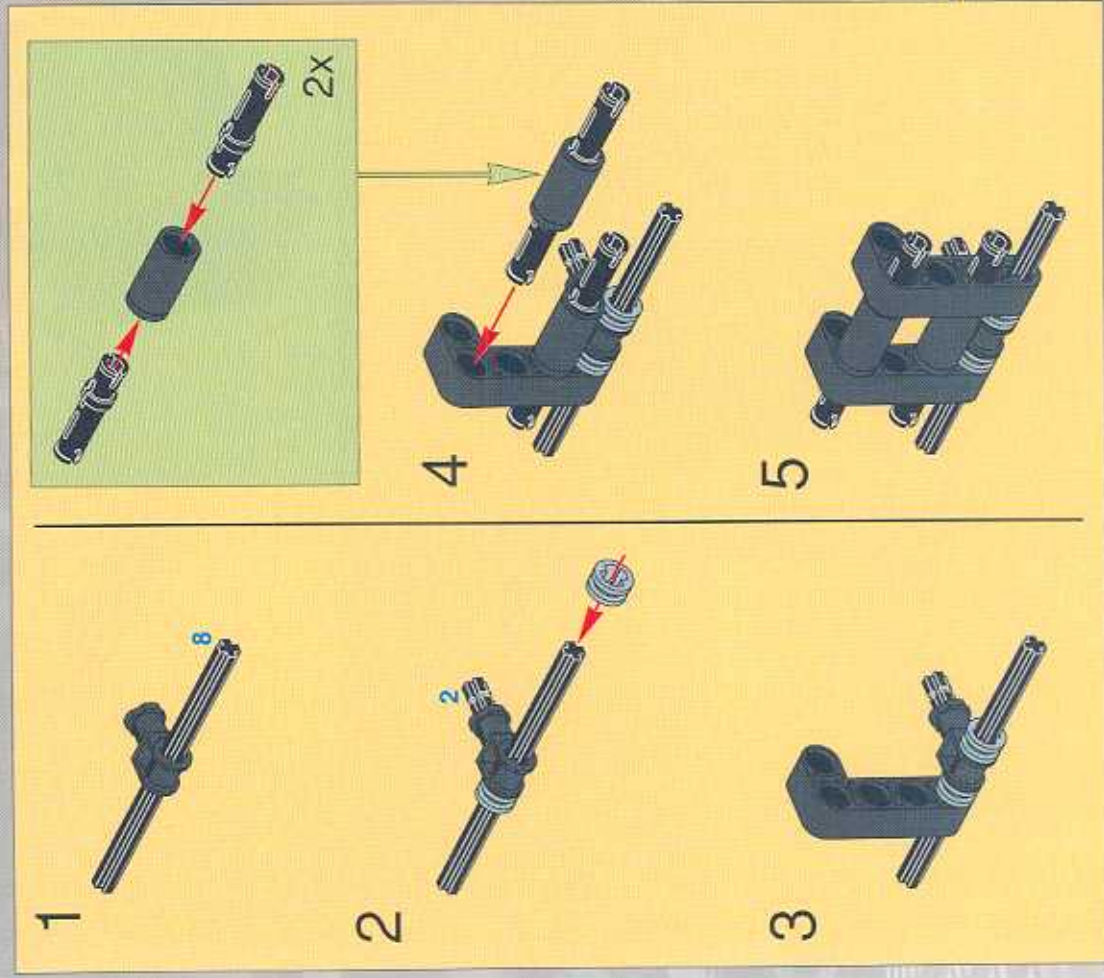

**6**

	2x		1x		2x
	1x		1x		2x
	2		1x		4x



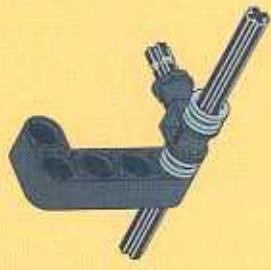

**1** 

**2** 

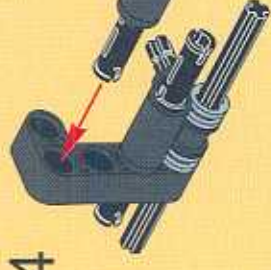
**3** 

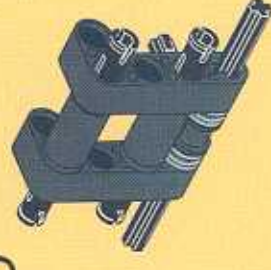
**4** 

**5** 

**2x** 

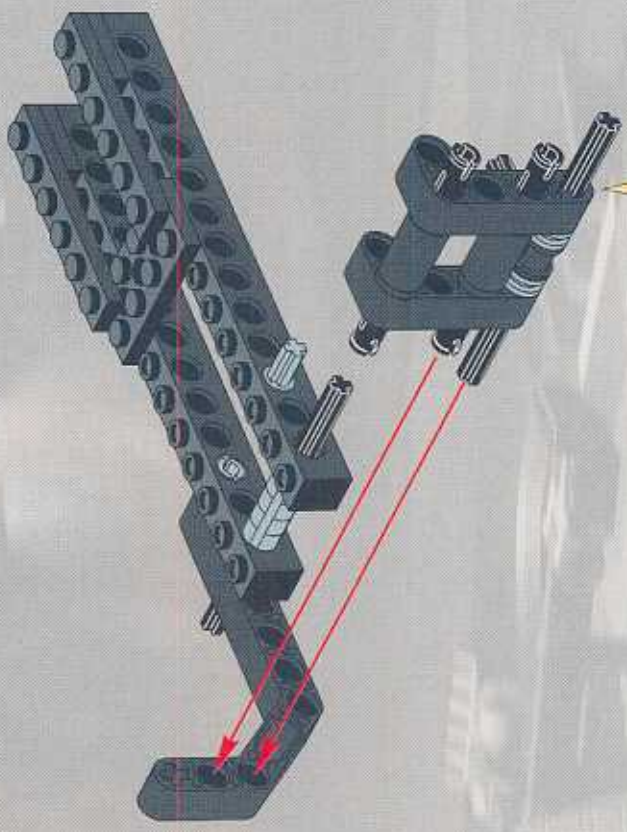



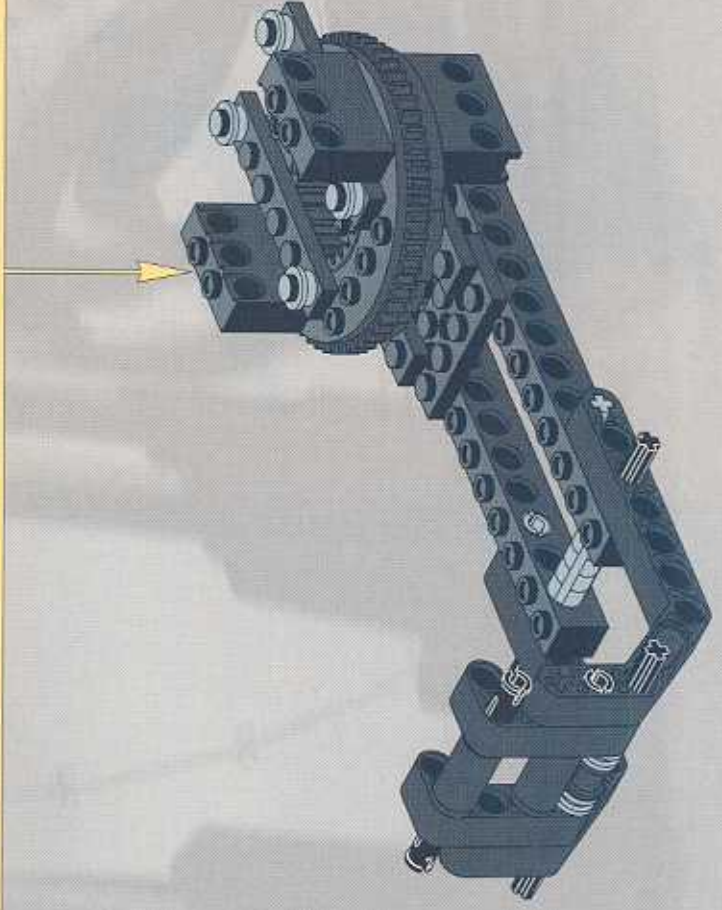
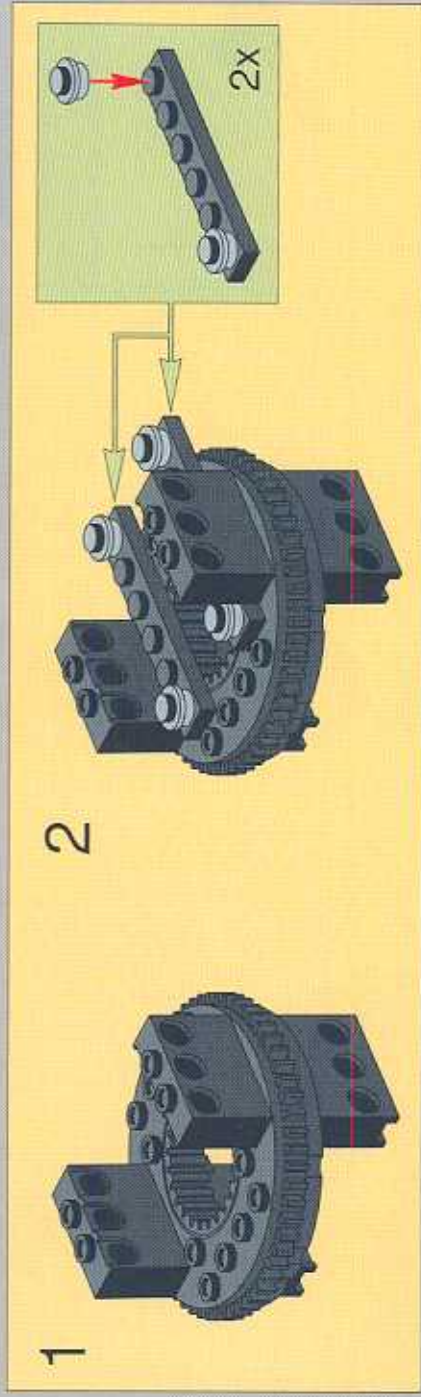
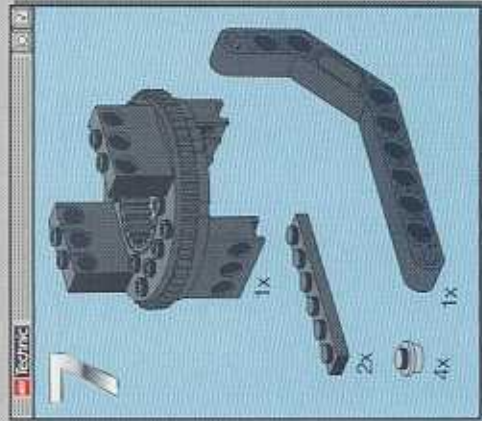



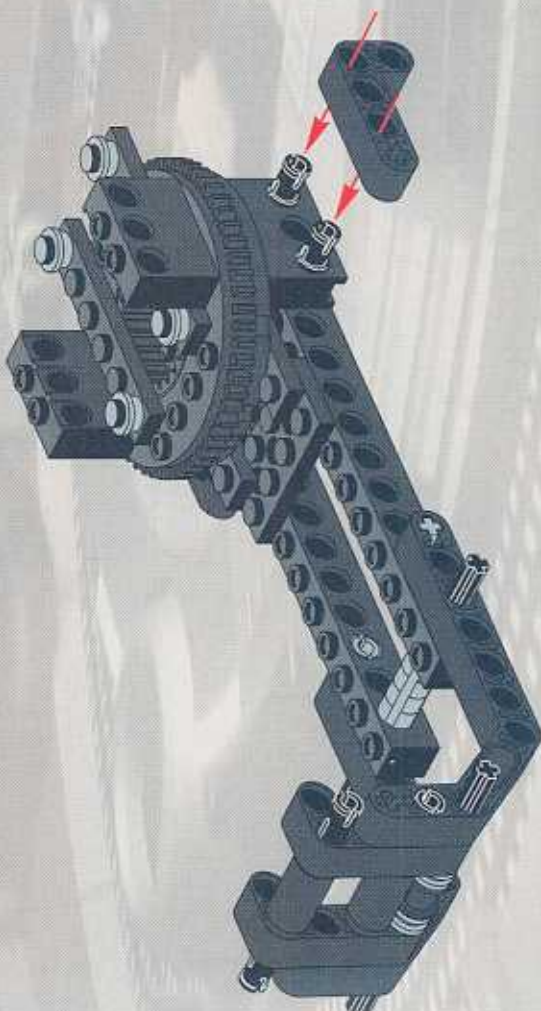
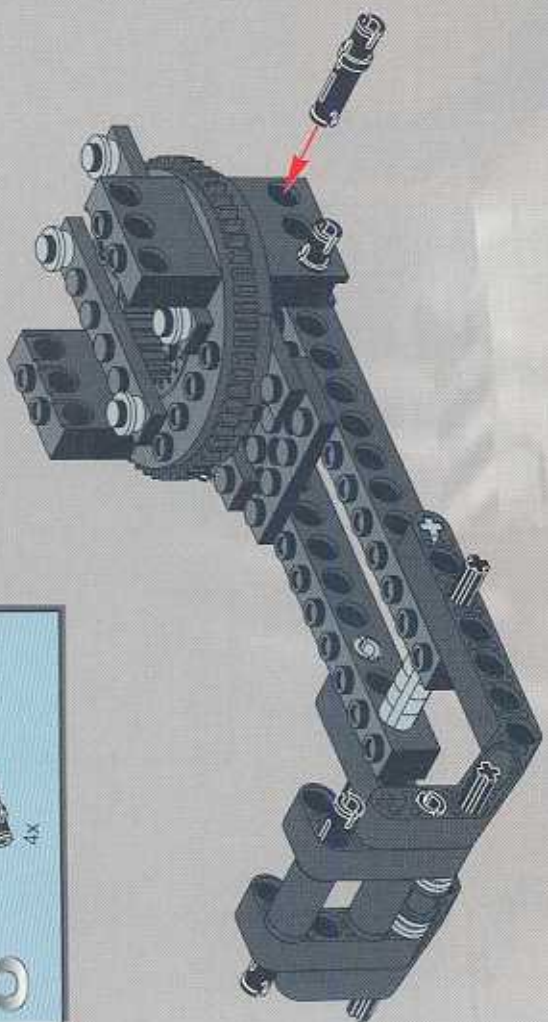
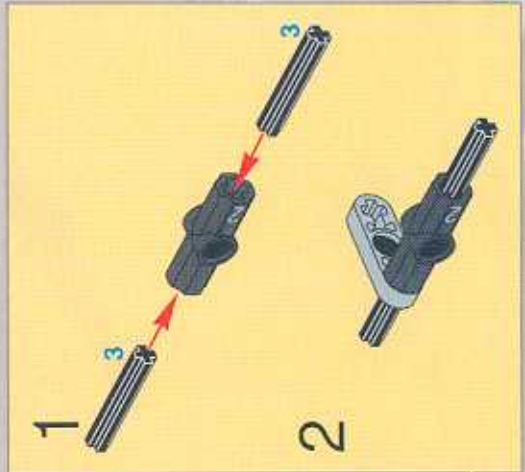
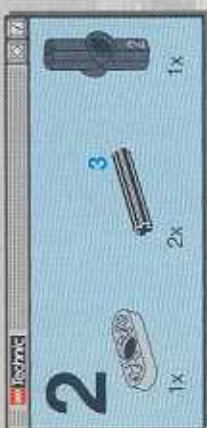
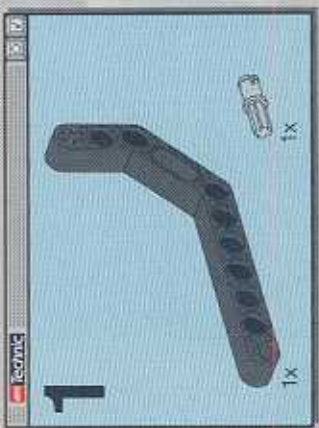



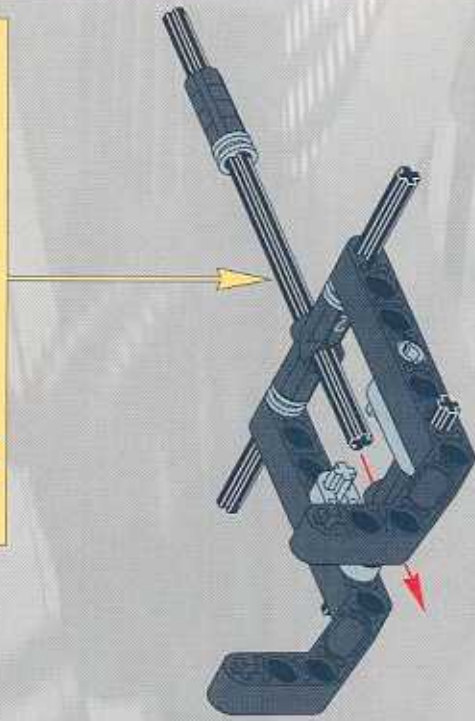
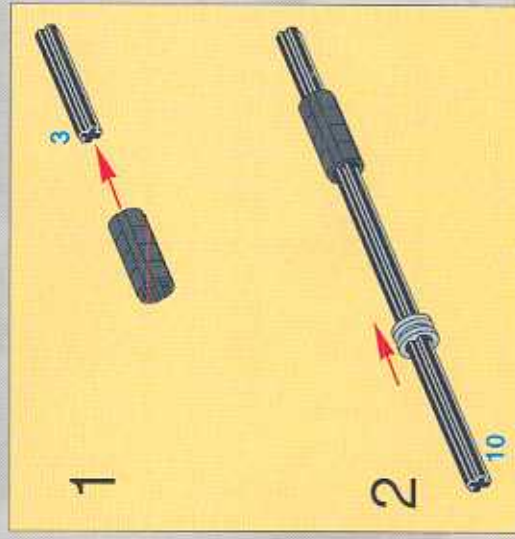
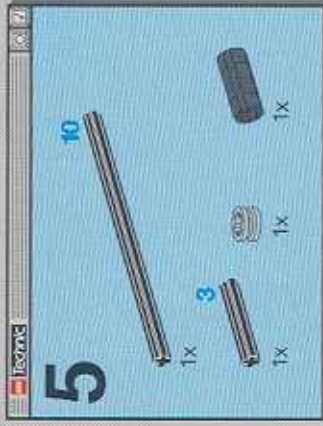
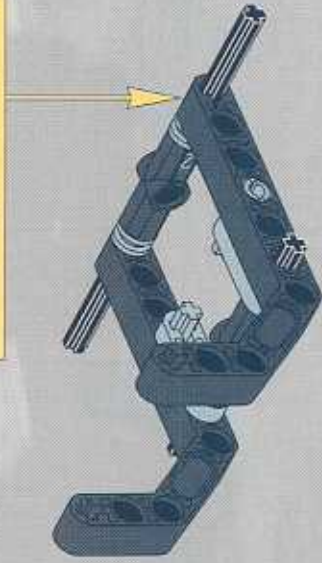
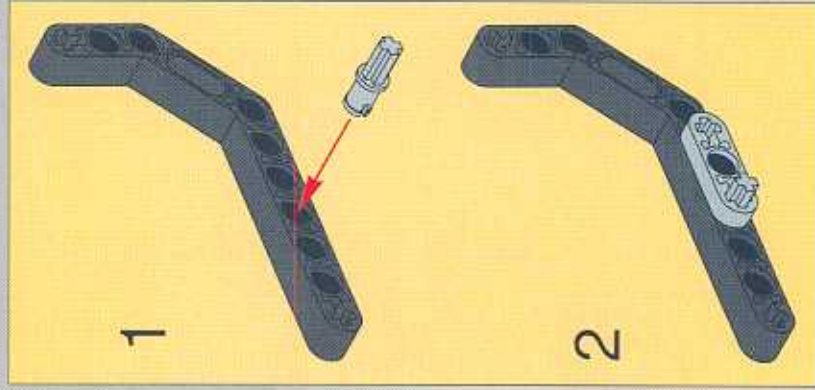
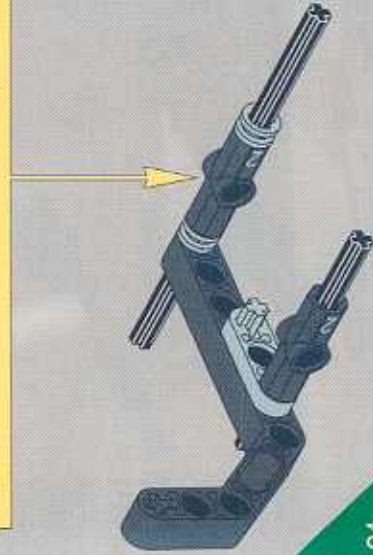
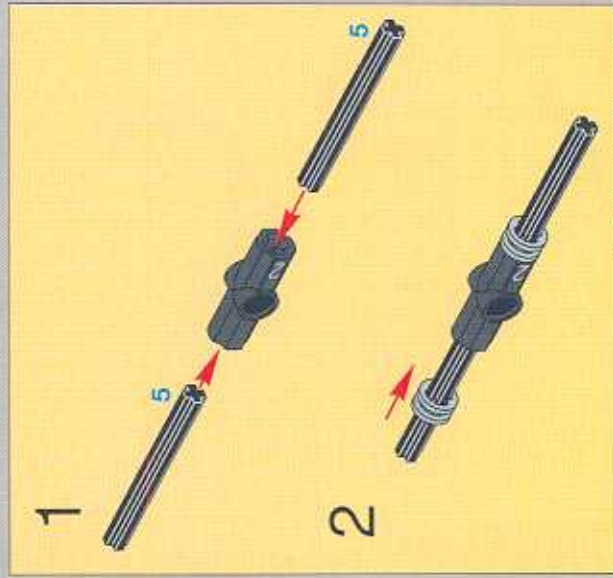
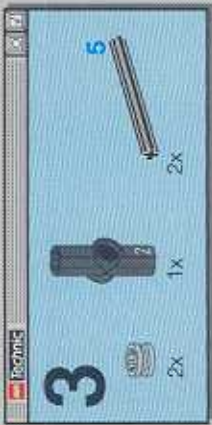



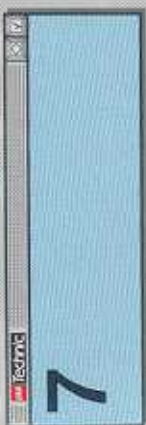
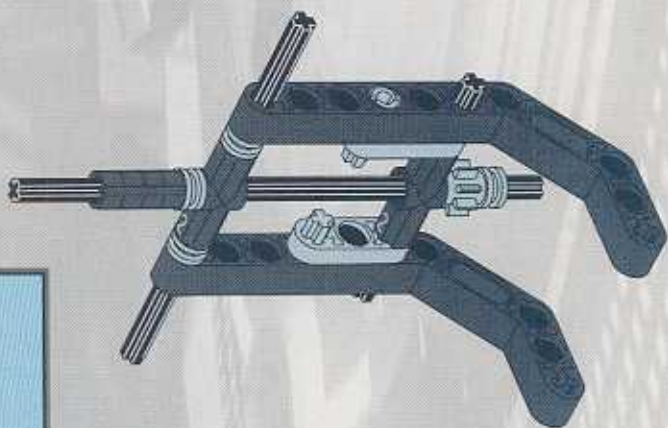
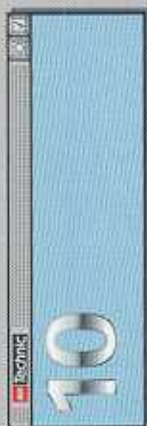
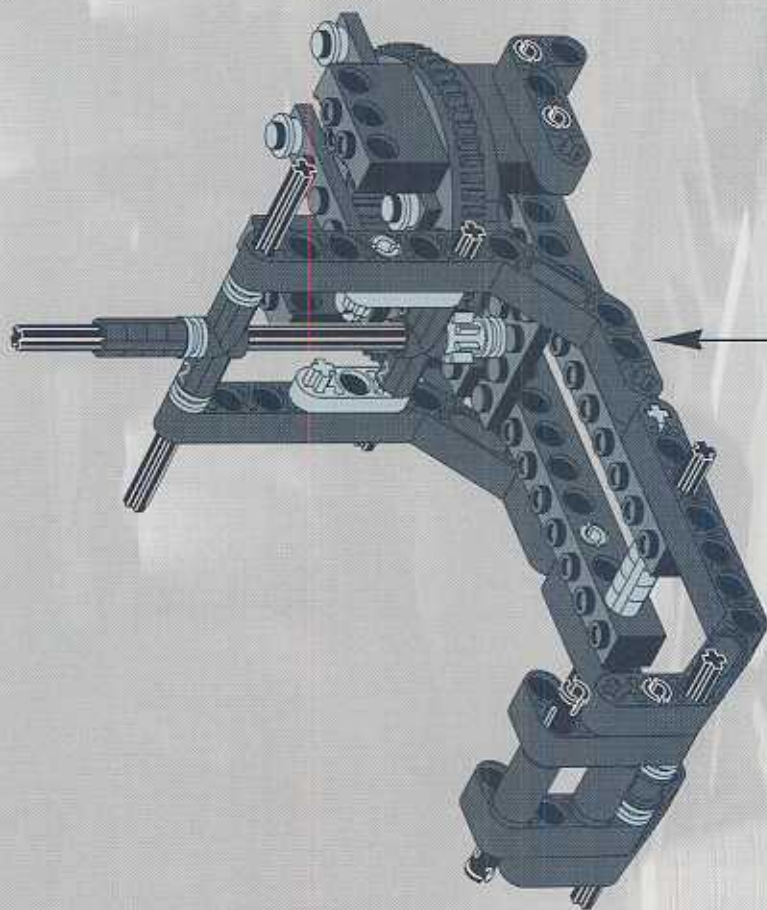



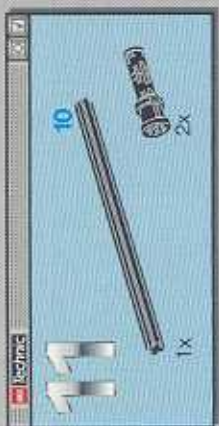
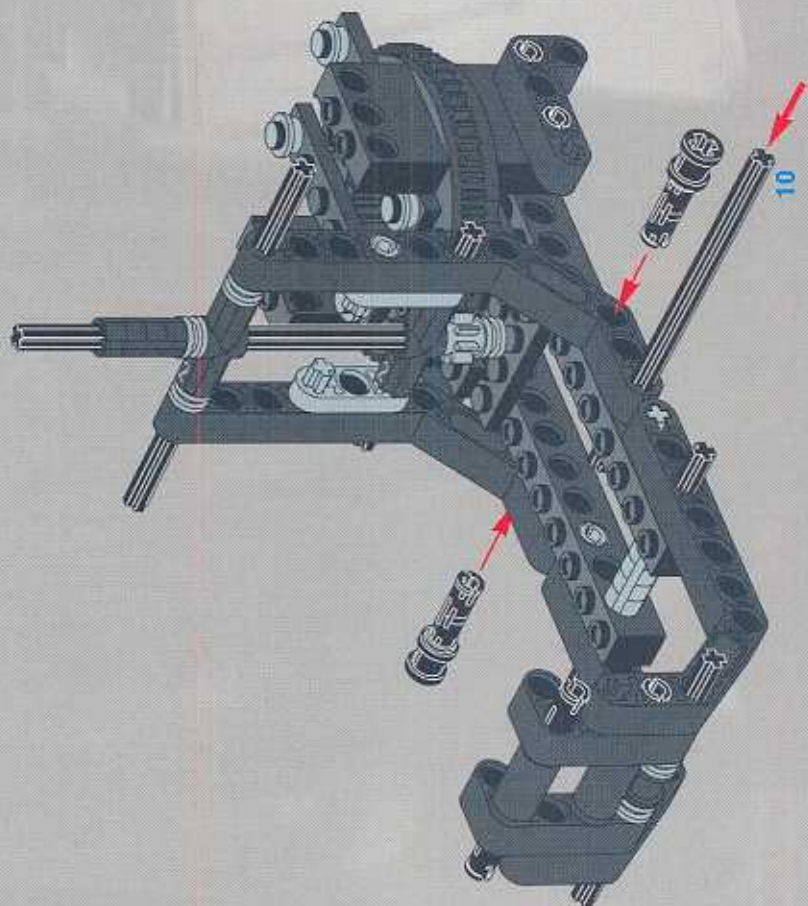



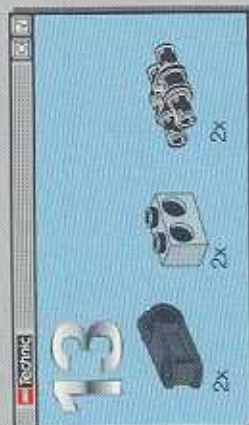
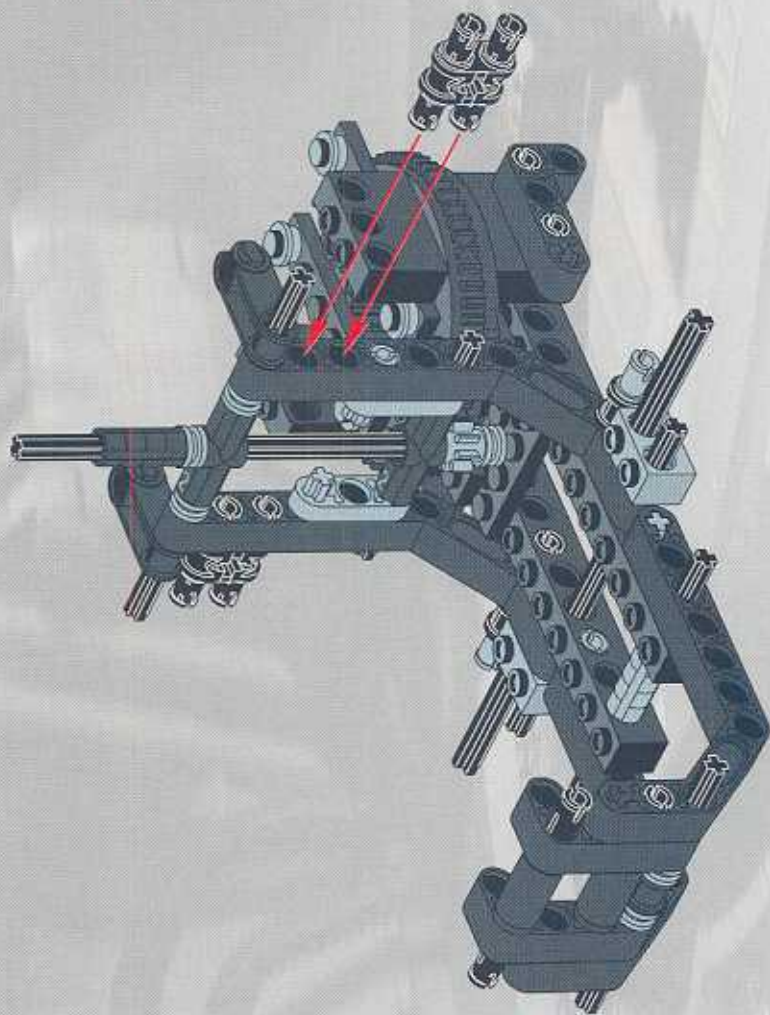
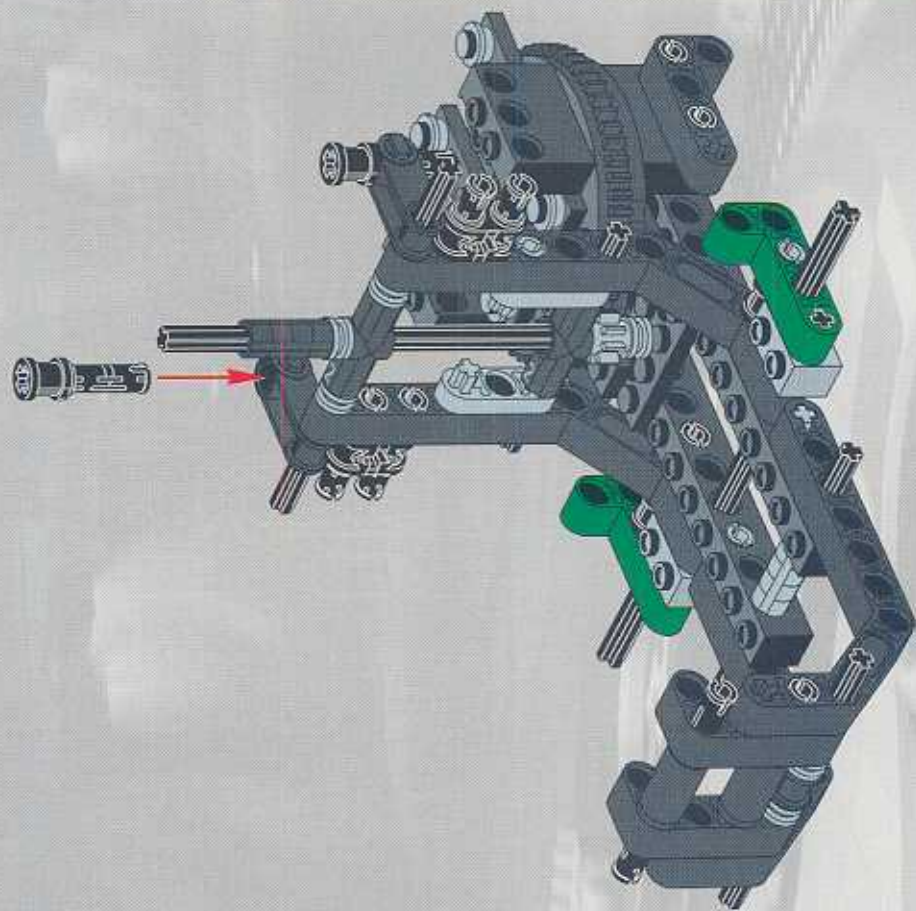



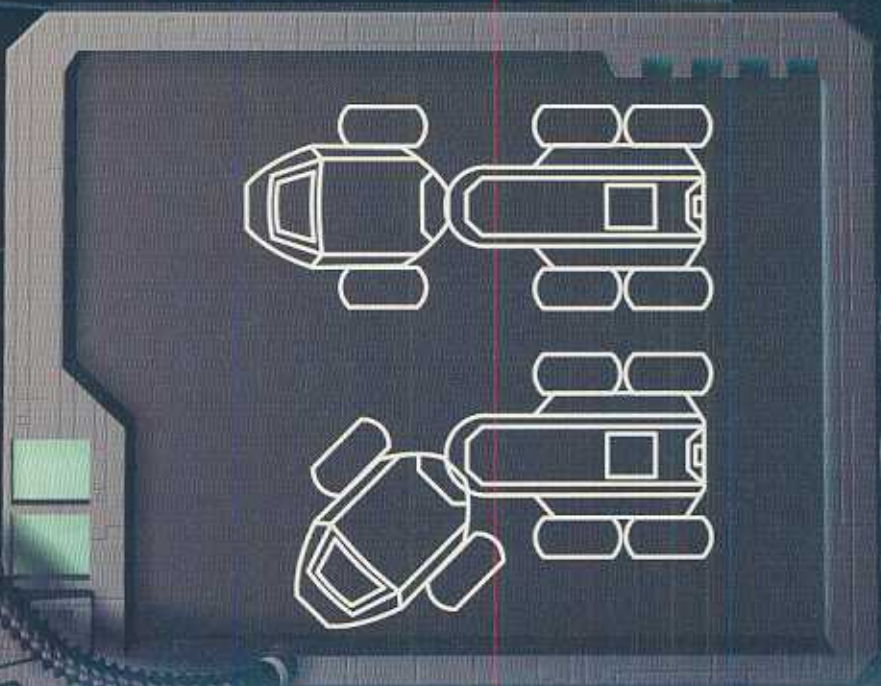
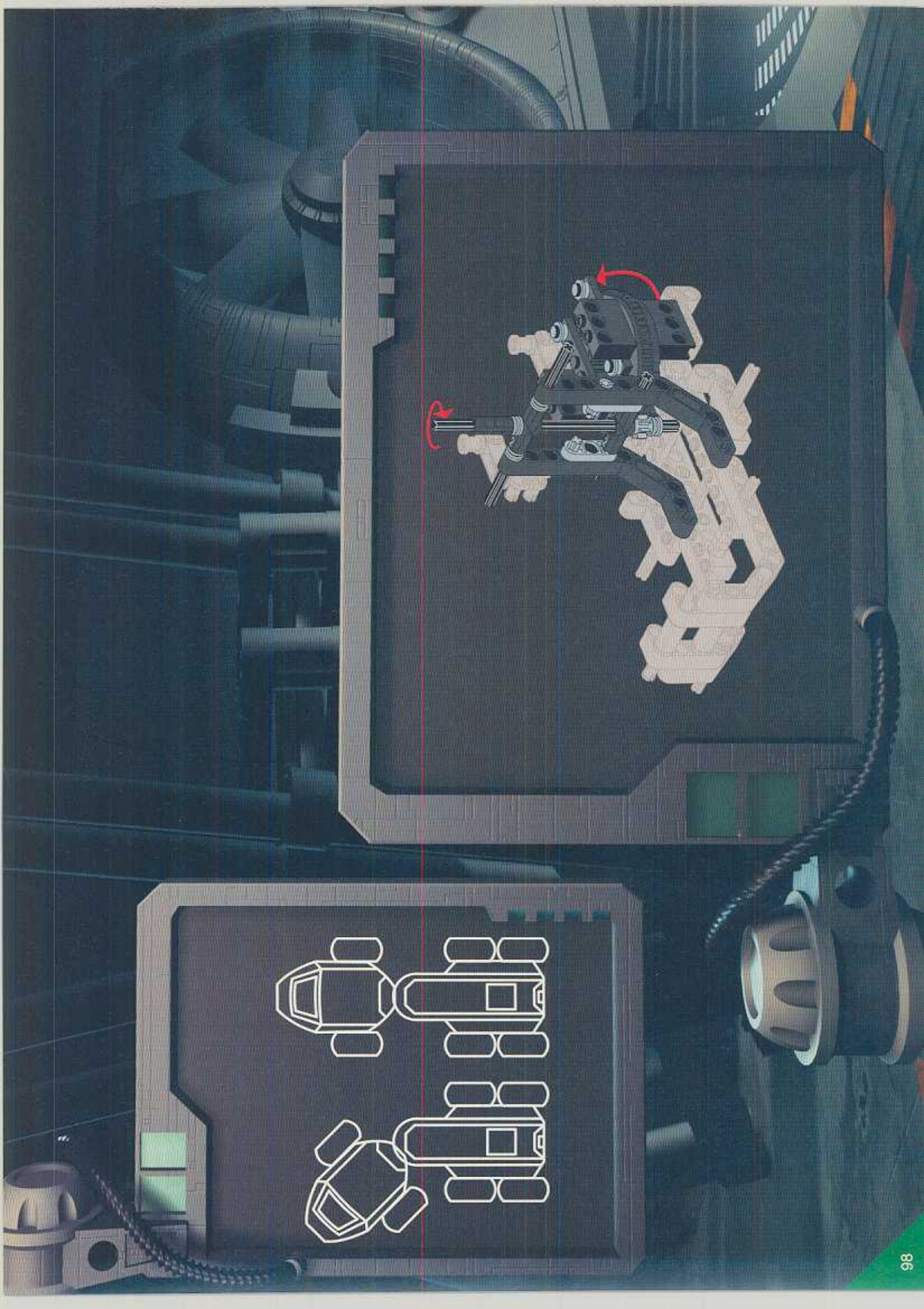



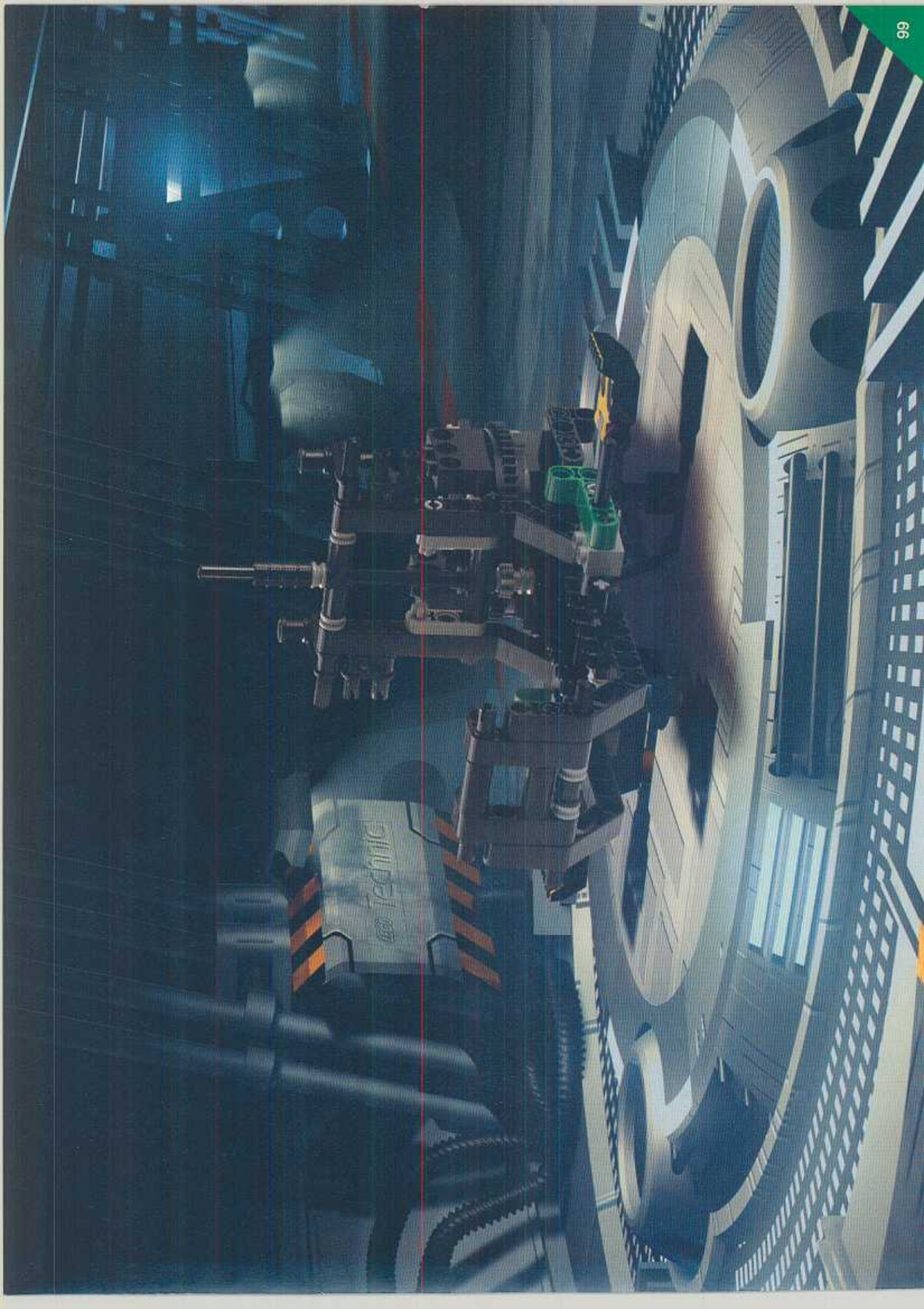



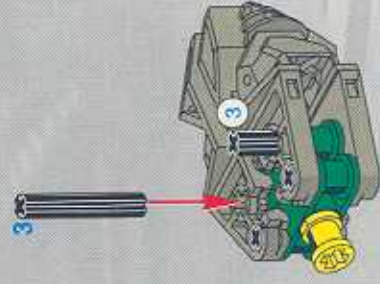
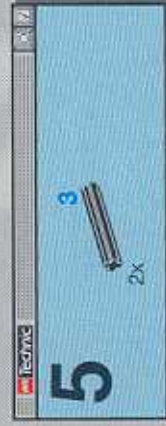
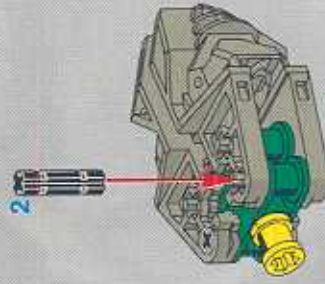
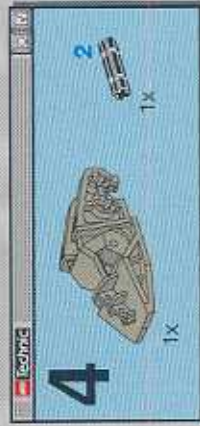
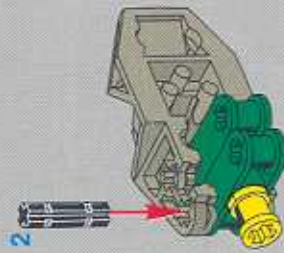
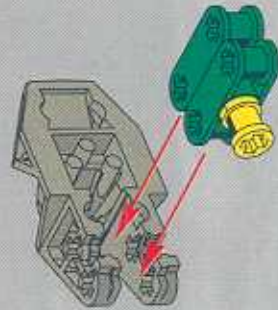
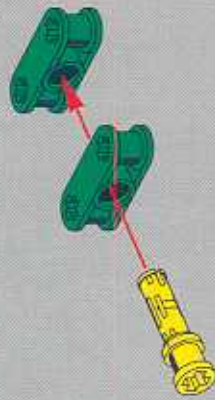





**7**

1x 

1x 

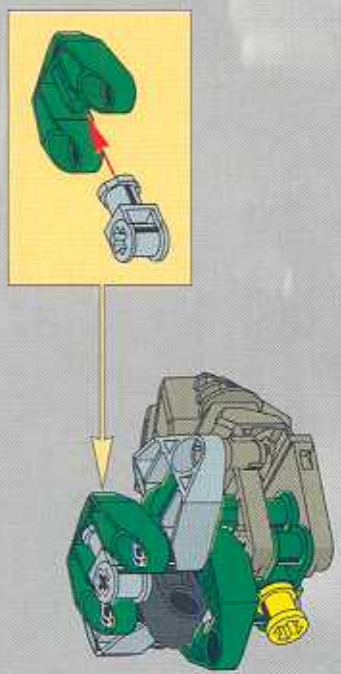

**15**

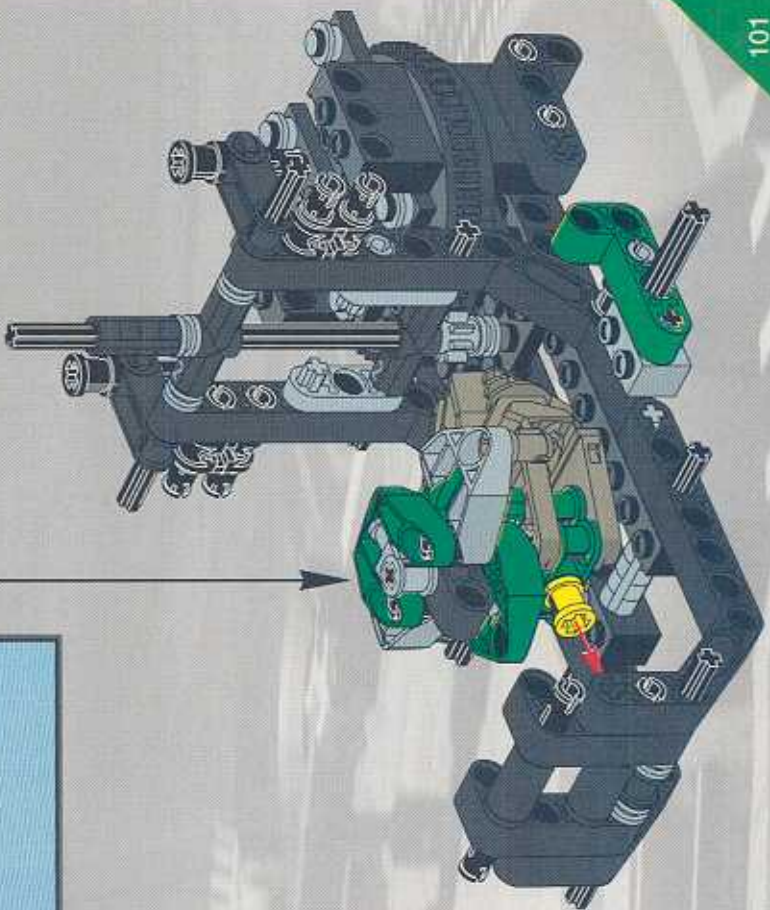

**5**

**6**

**7**

**6**

1x 

2x 

2x 

2x 

1x 

1x 

1x 

**1**

**2**

**3**

**4**



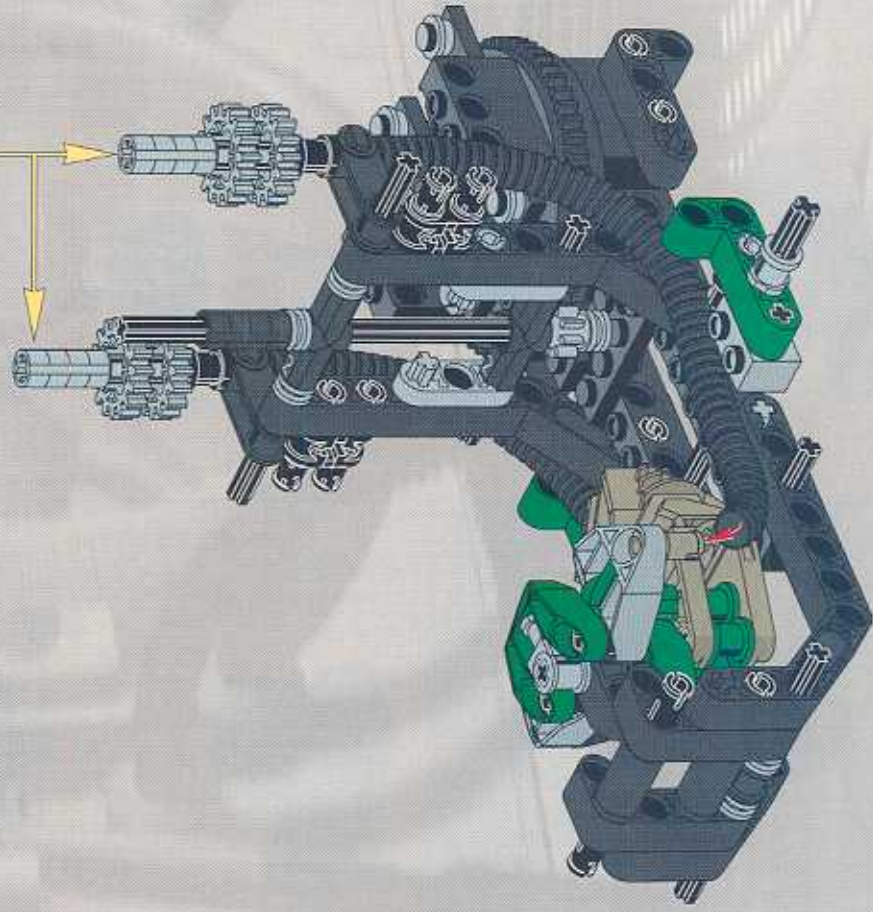
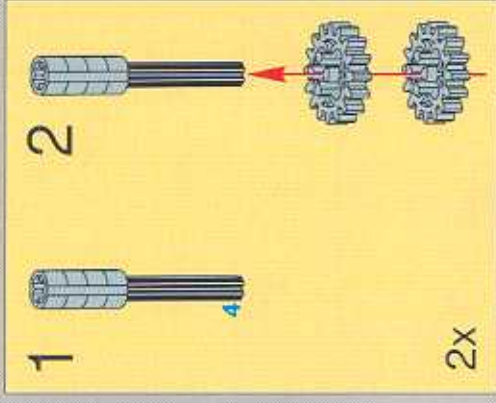
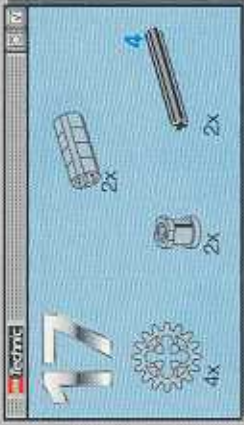
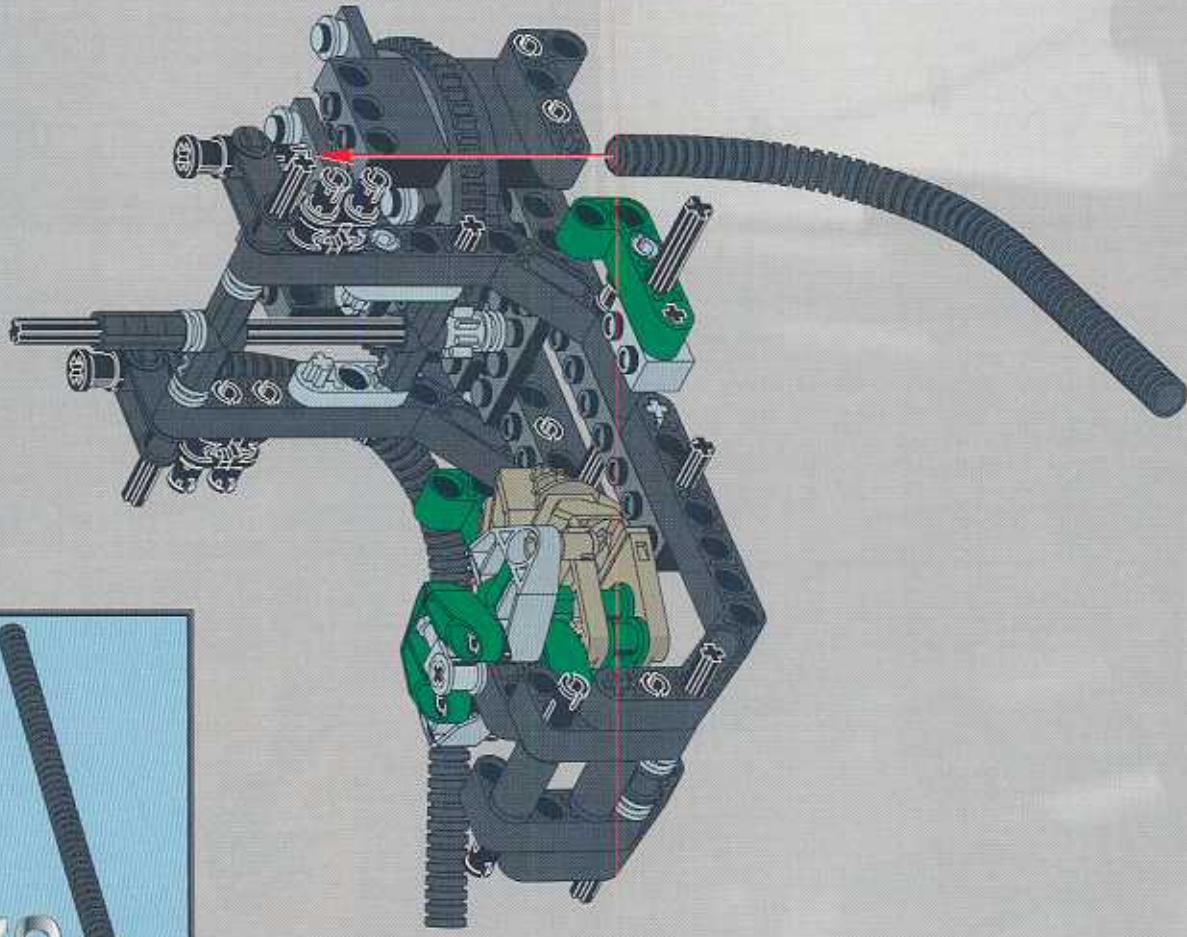
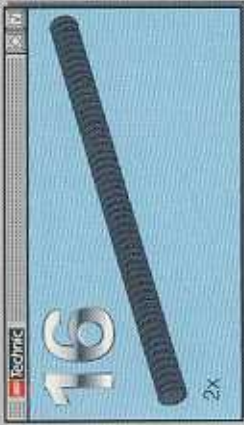



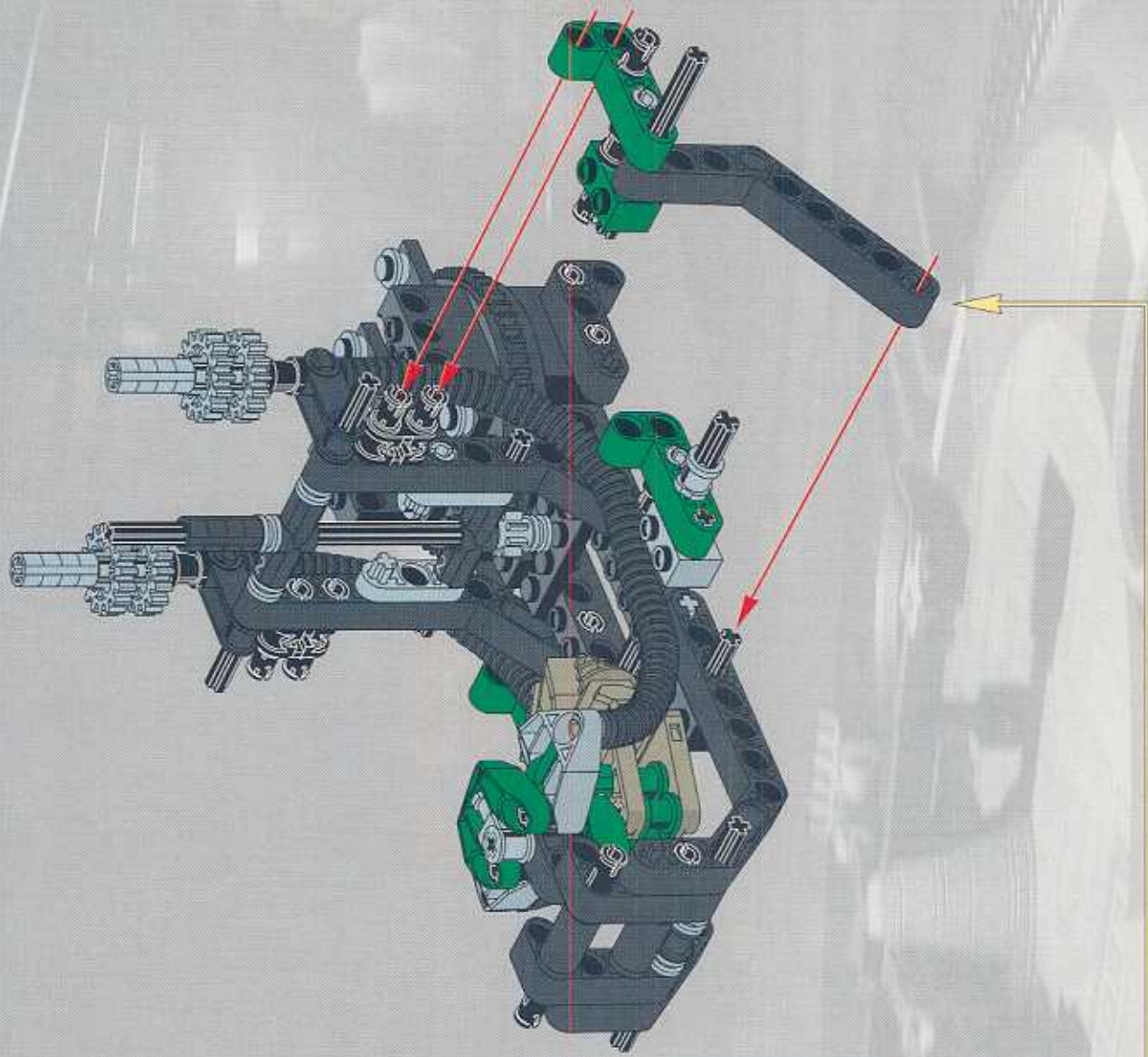
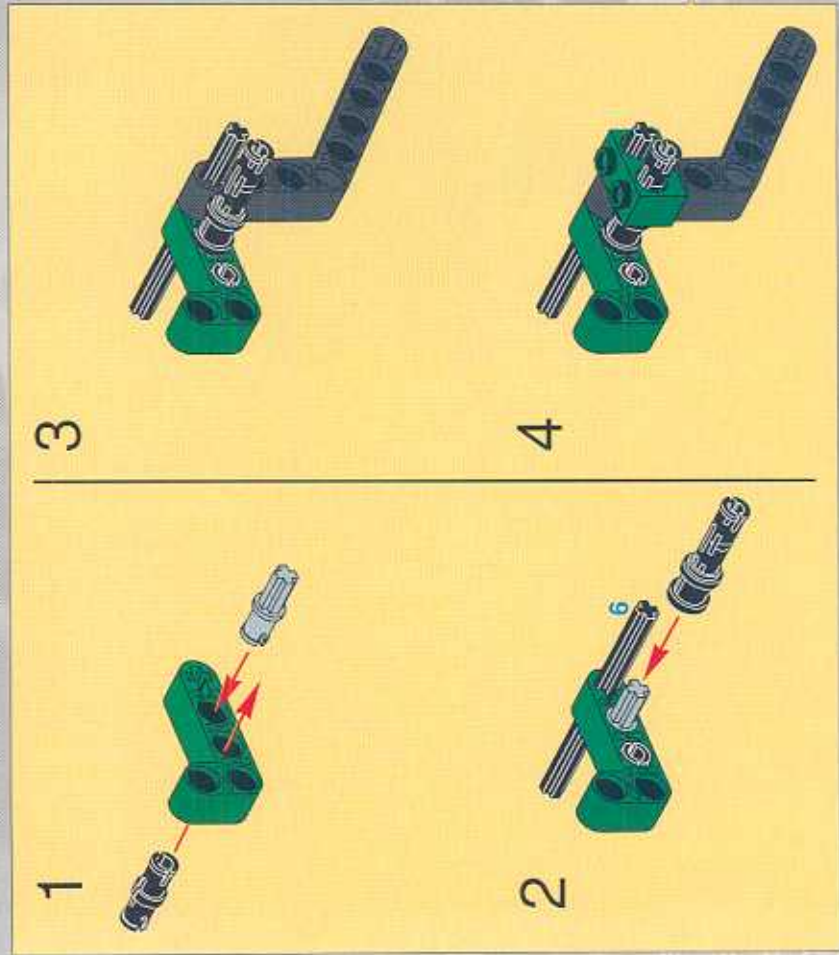



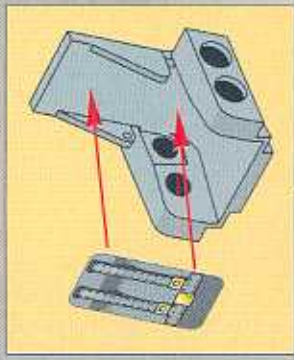
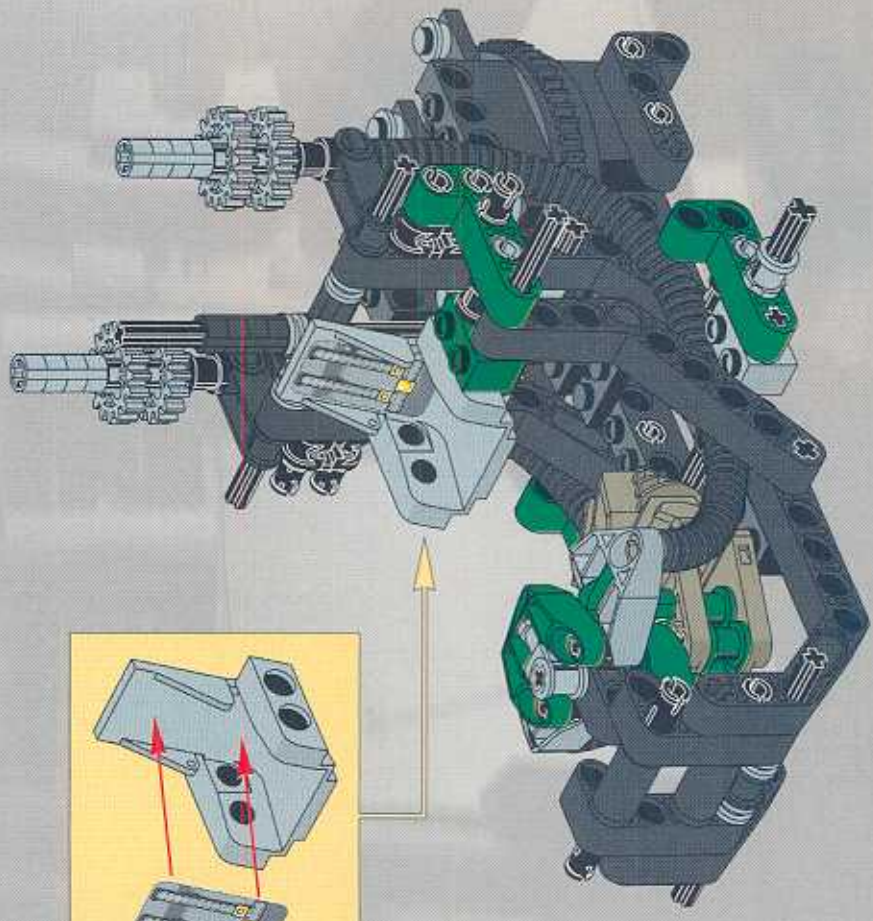



LEGO Technic

# 19



1x







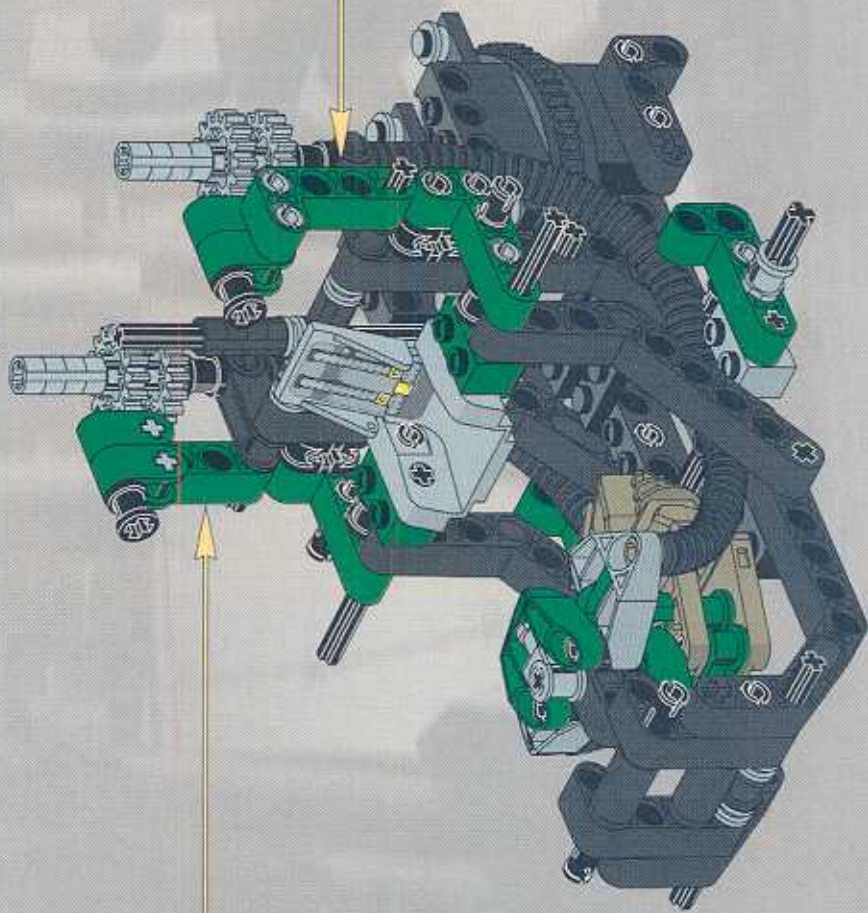
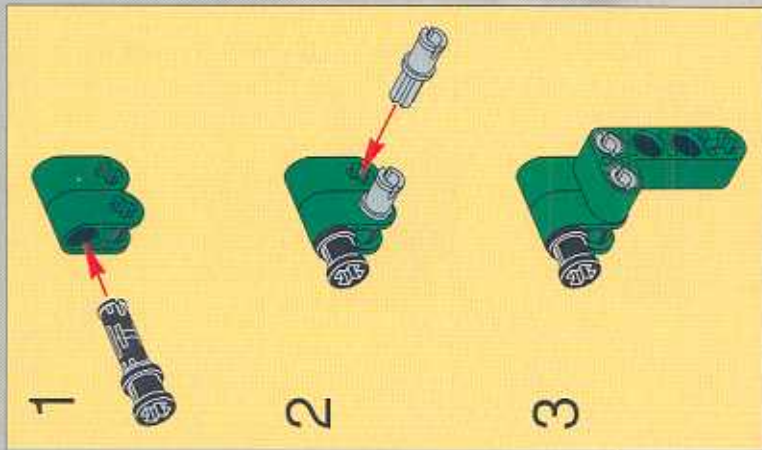
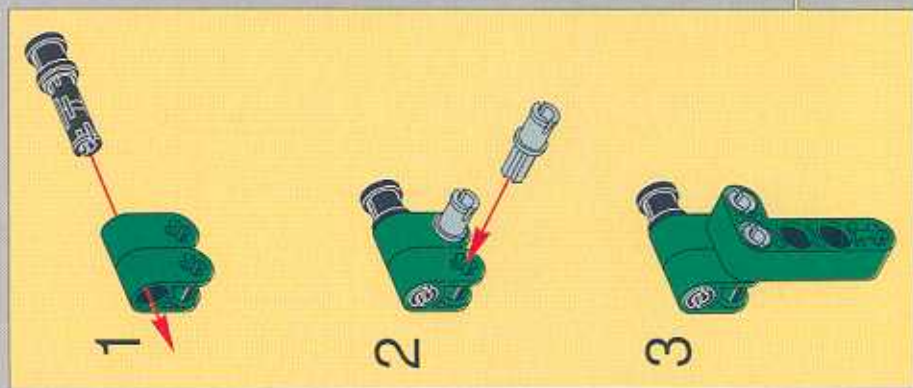



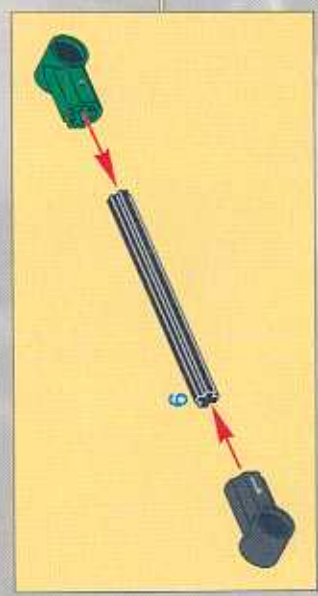
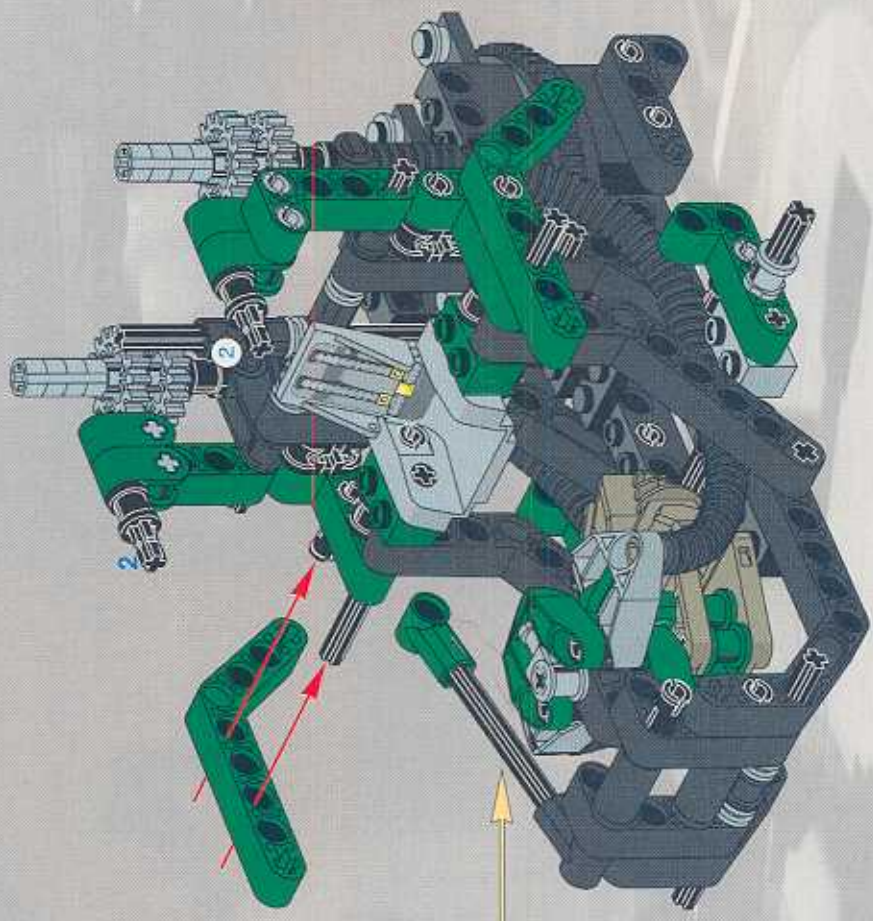

**22**

	1x
	1x
	6
	2
	2x
	2x



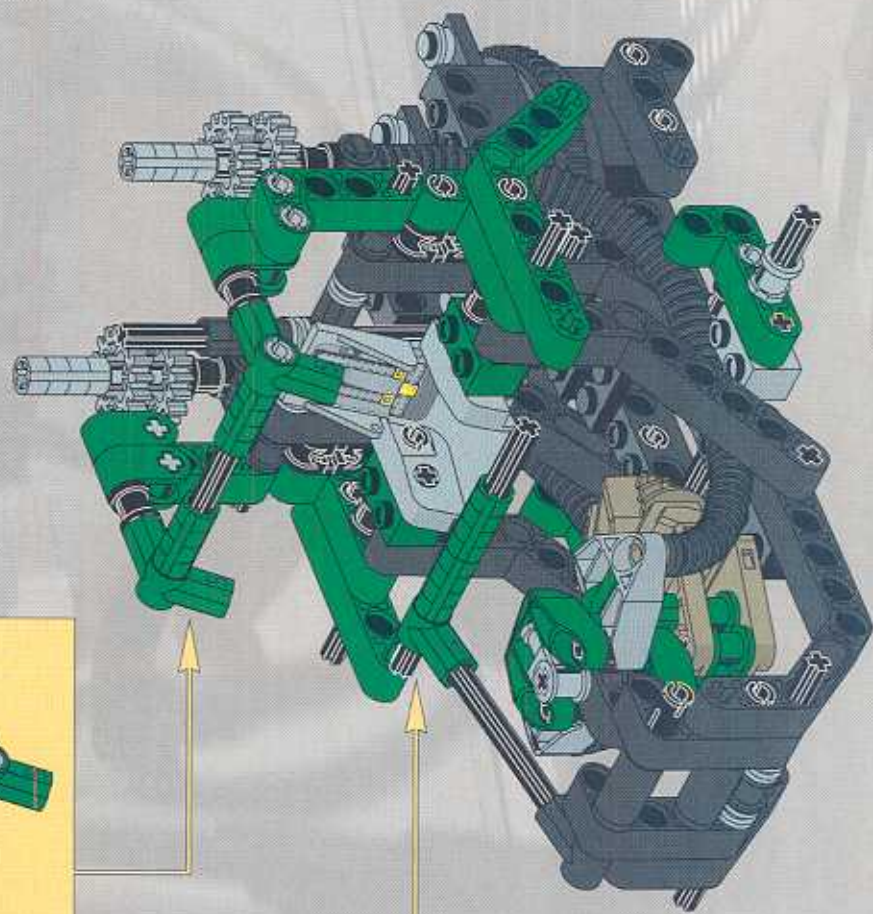
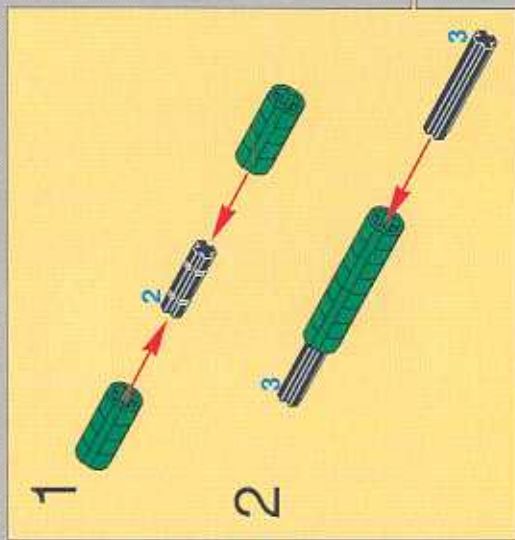
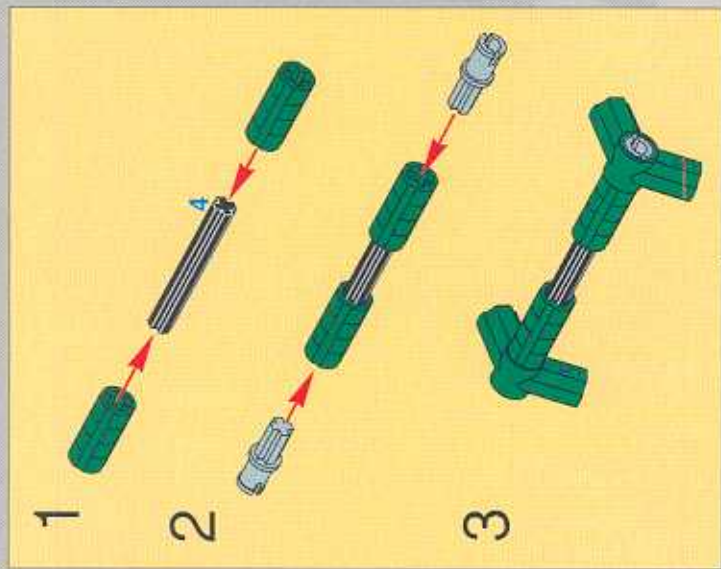
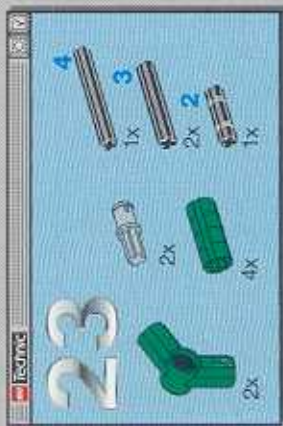



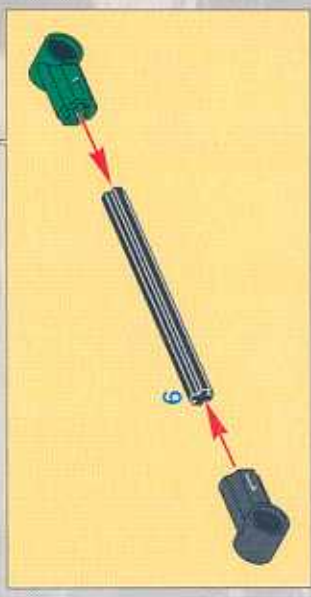
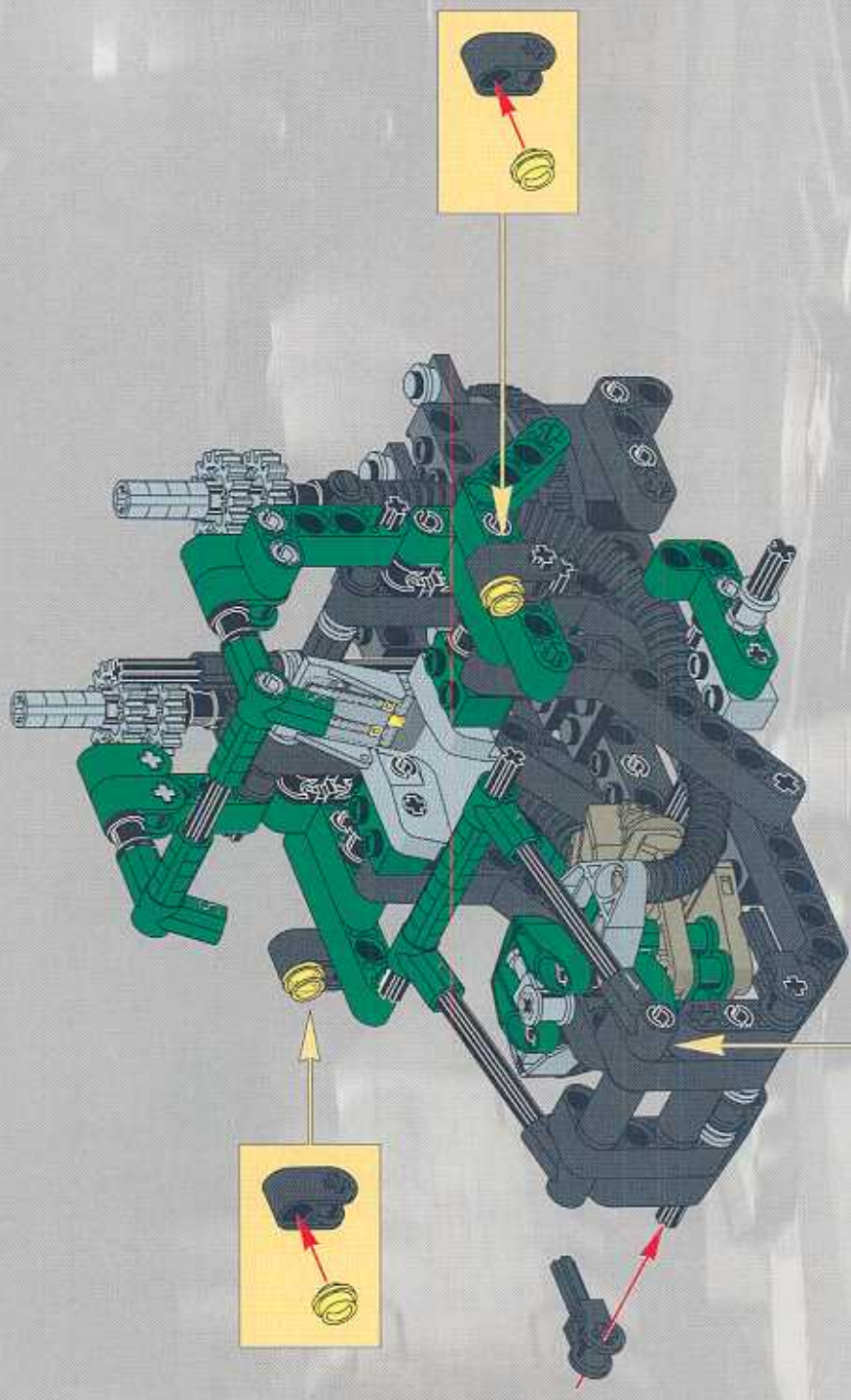

LEGO 24

	1x		6
	1x		1x
	2x		2x
	2x		2x



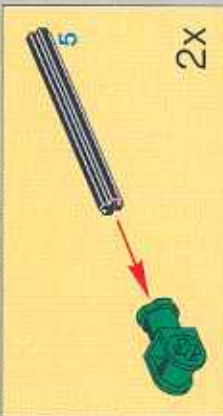
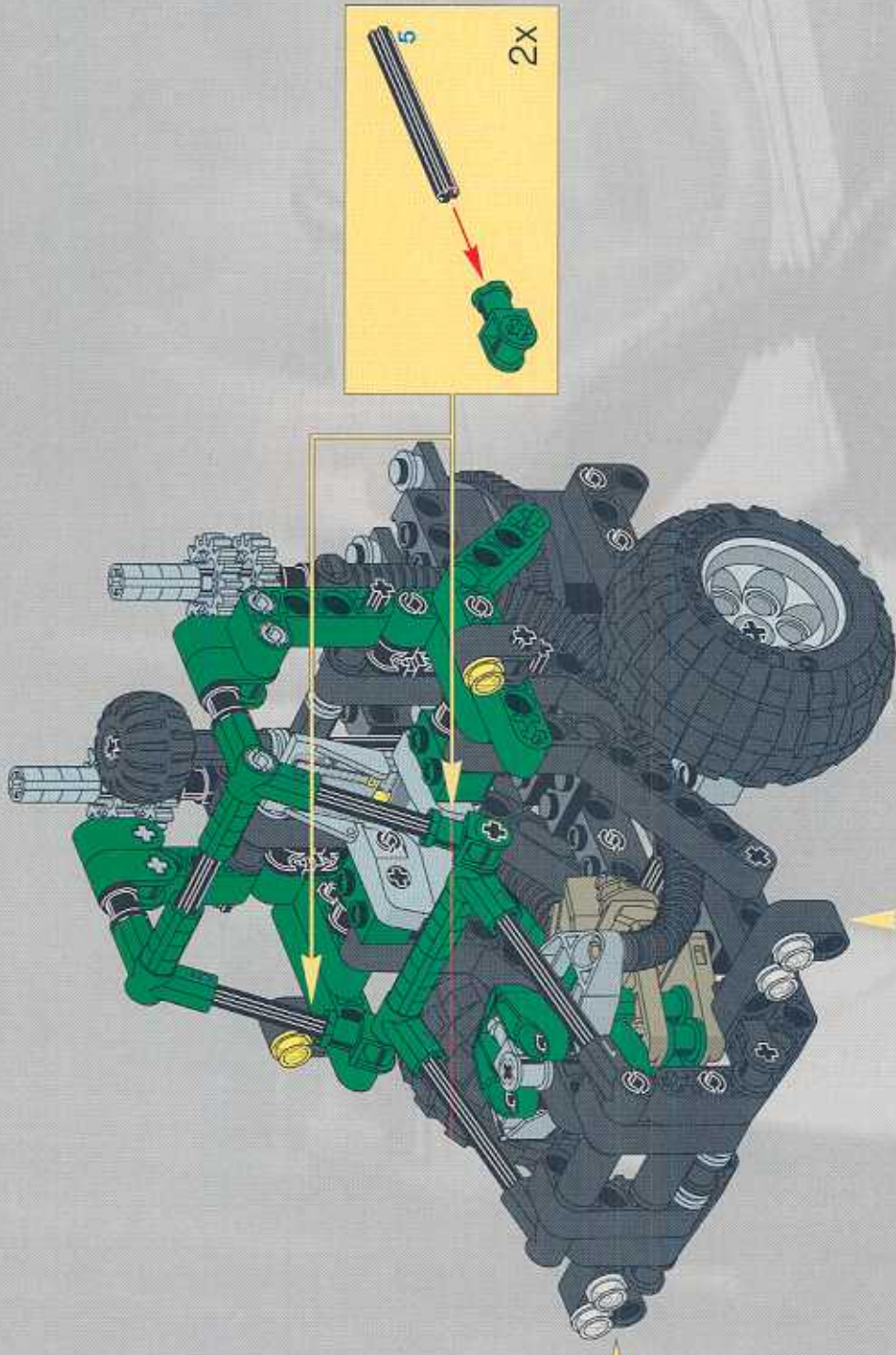



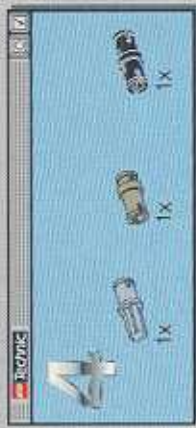
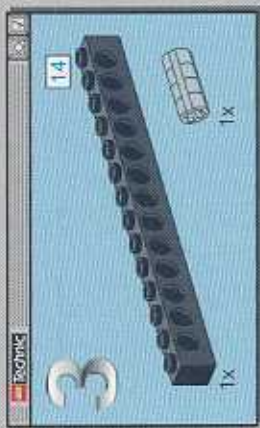



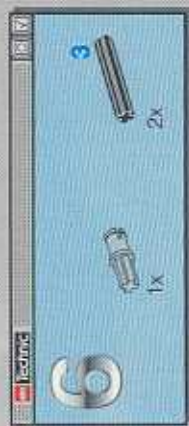
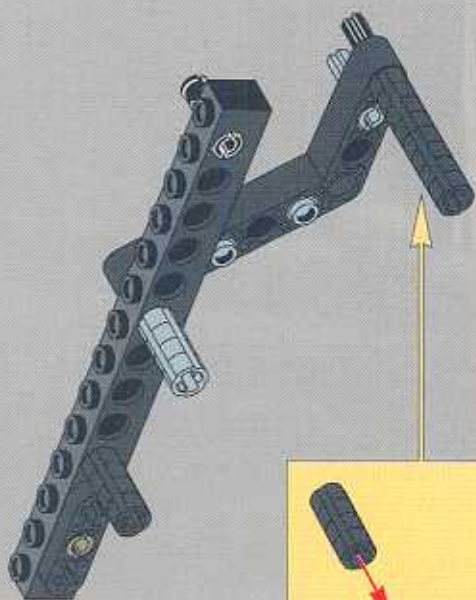
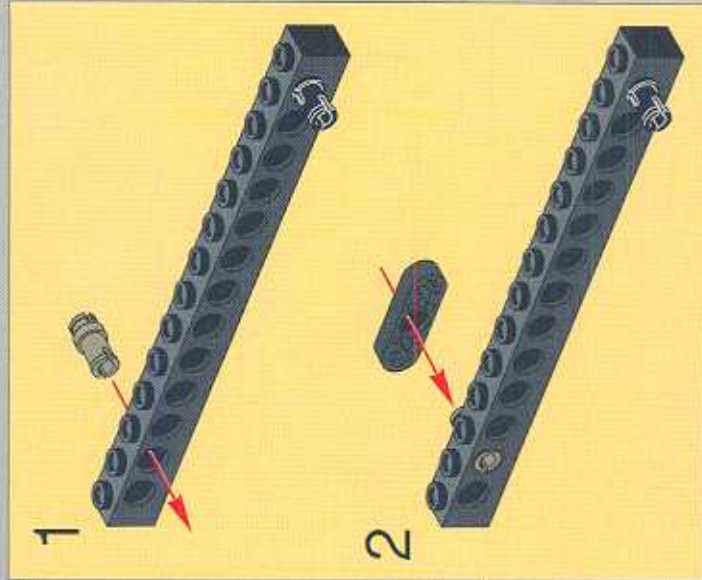







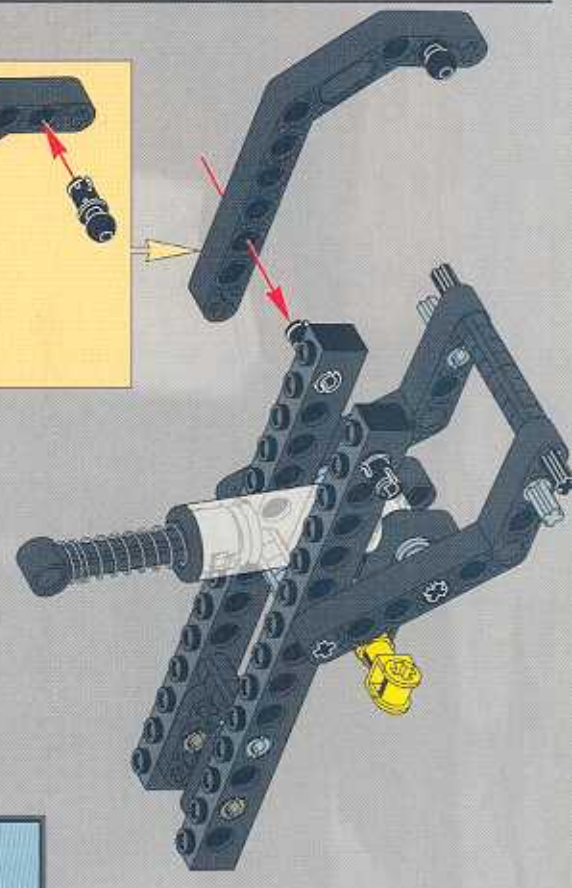
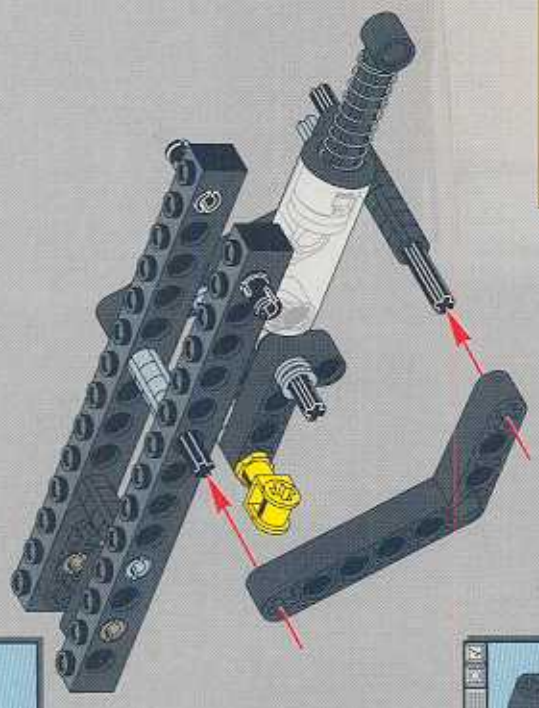
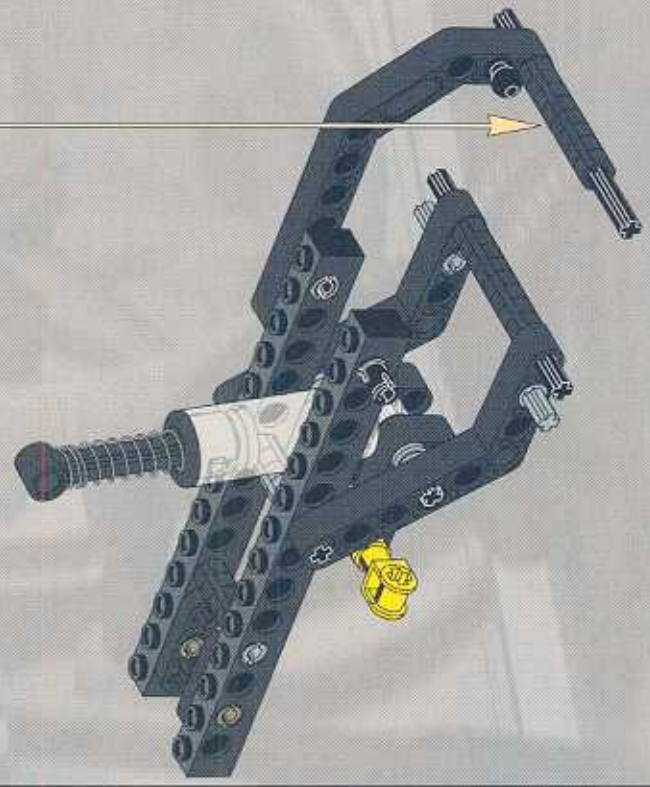
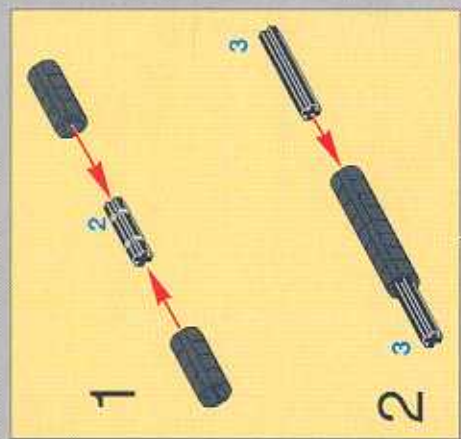







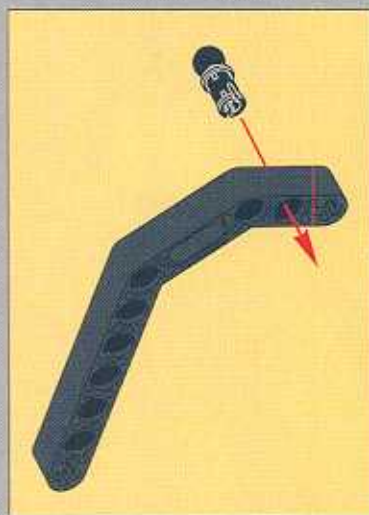
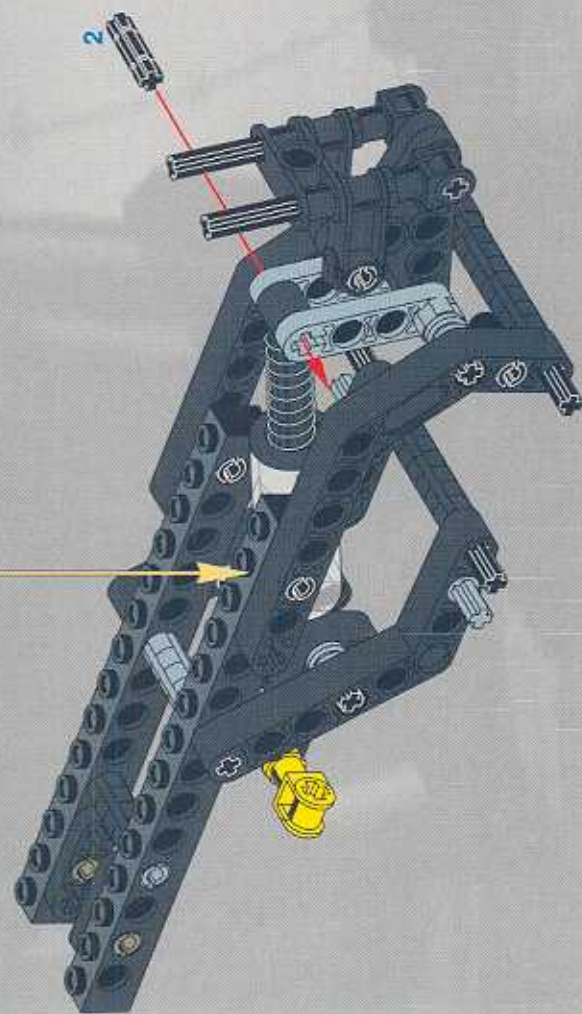
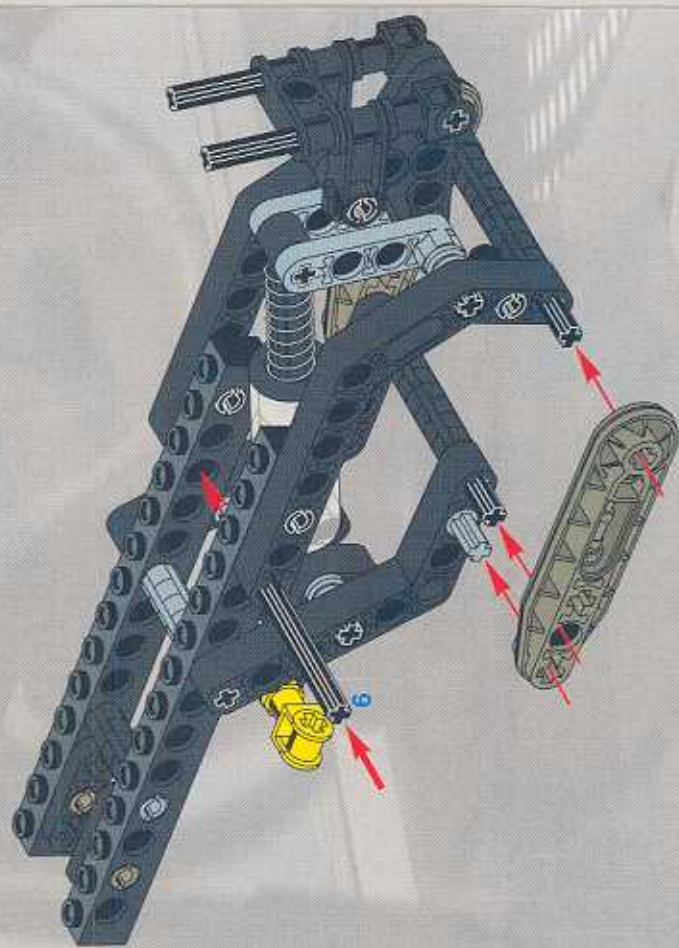



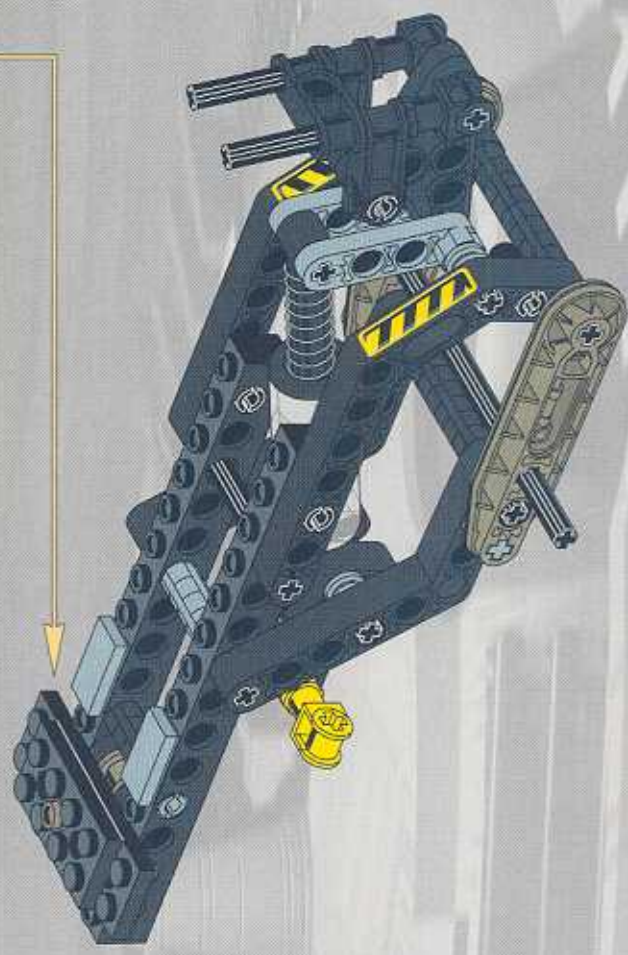
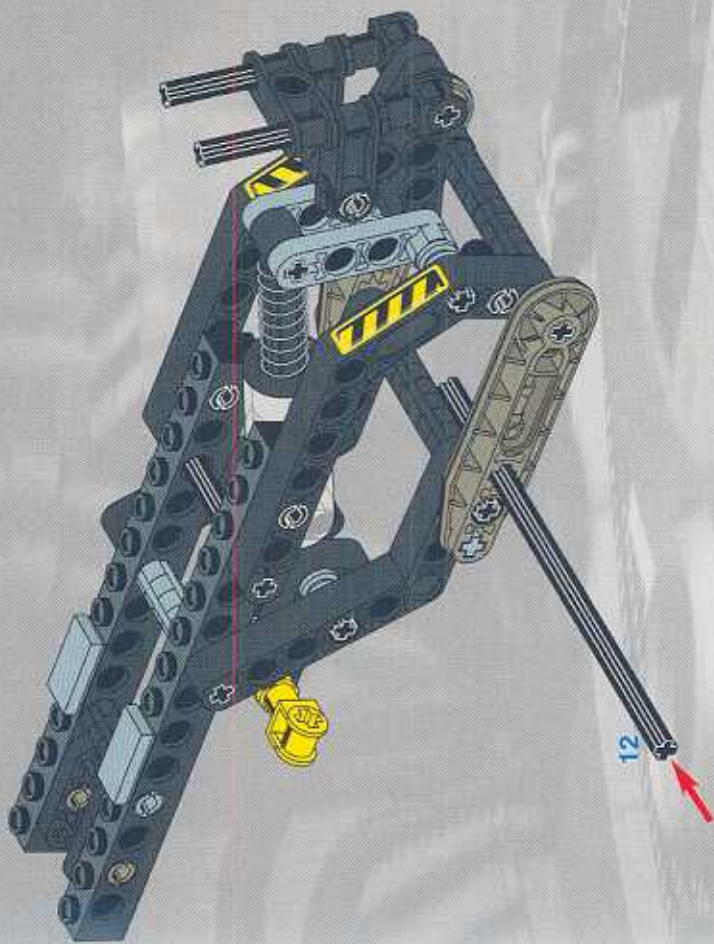
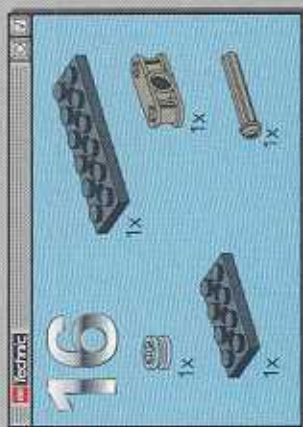
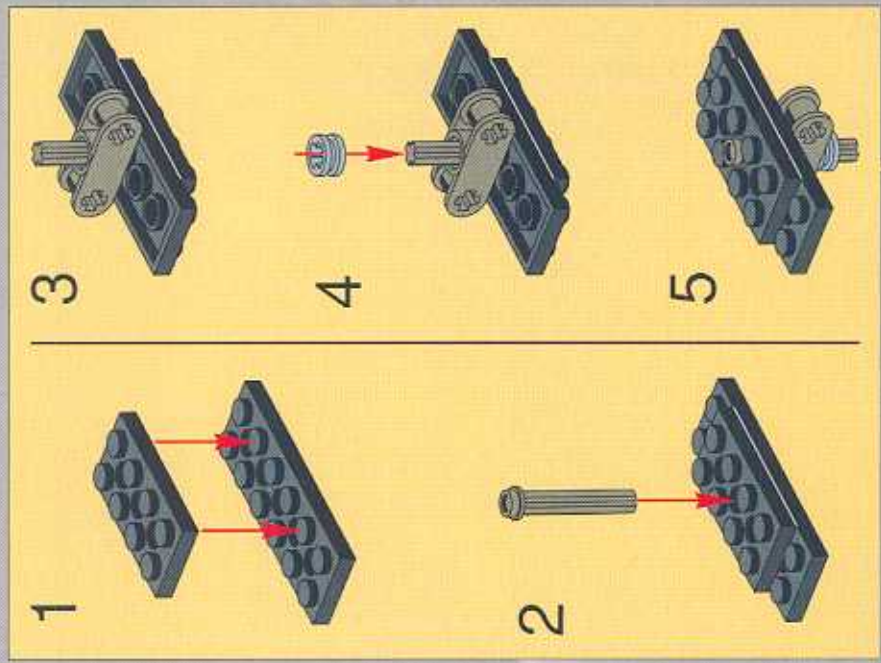



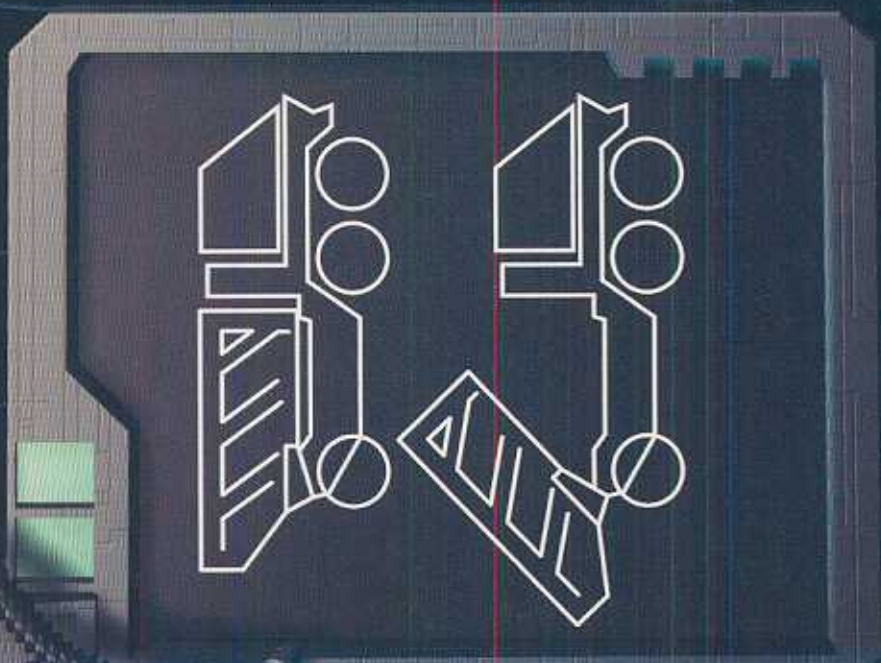



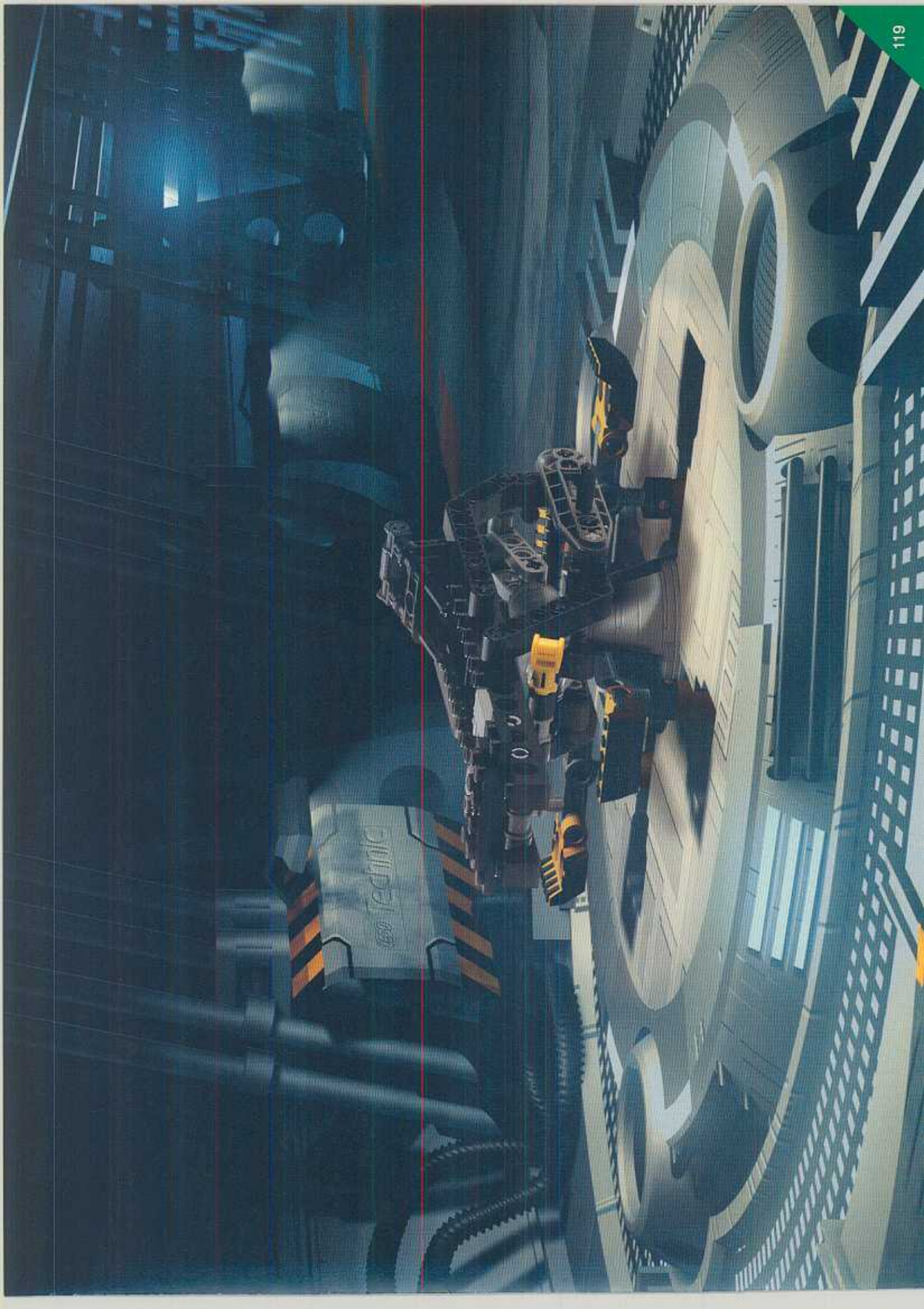



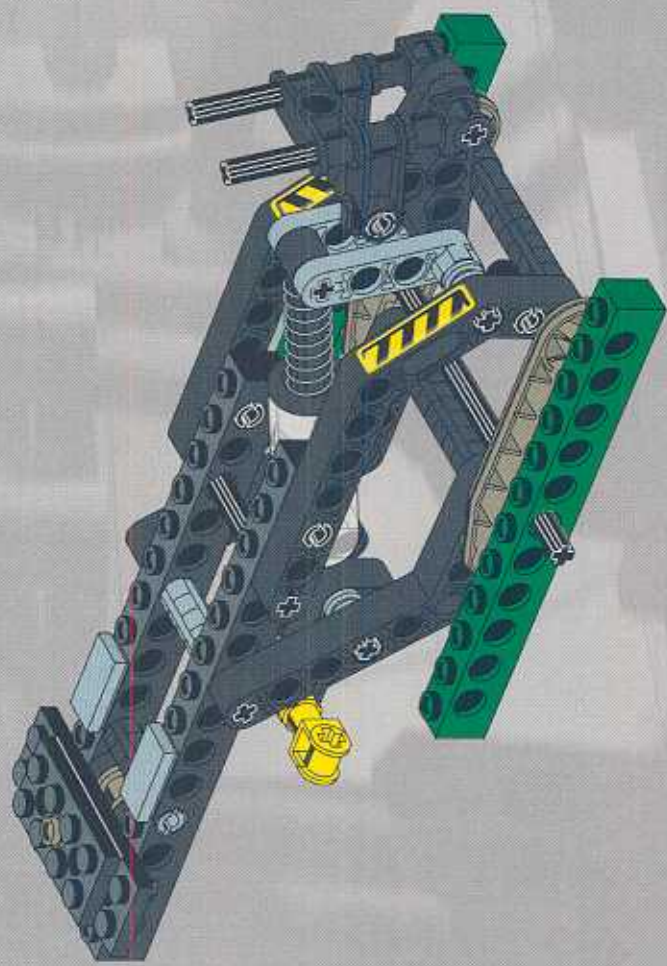



**18**

- 6x
- 2x
- 12x

**1**

**2** 4x

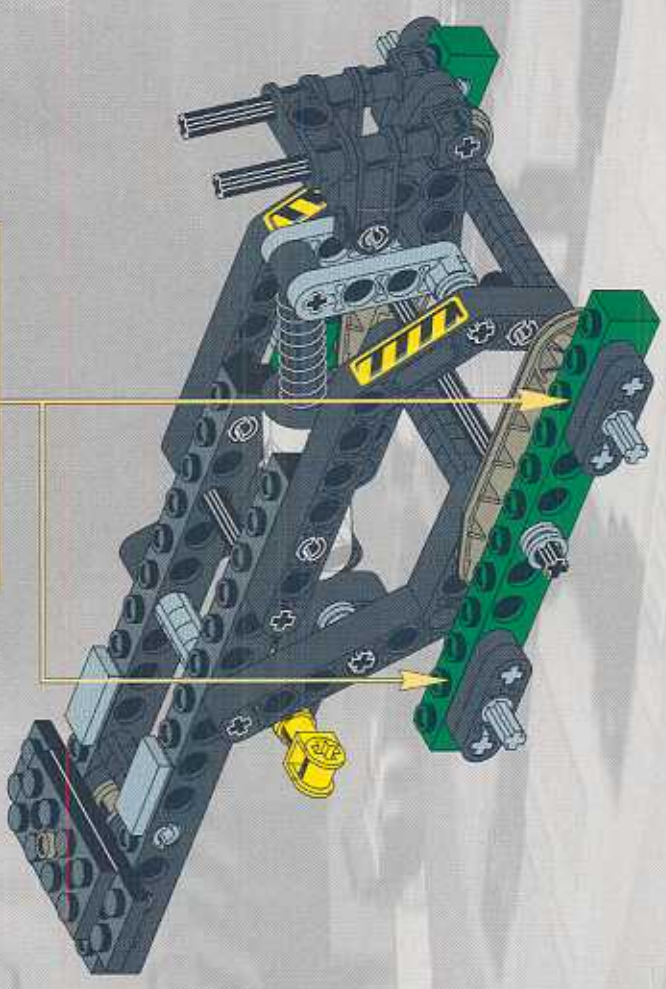



Technic

19



4x

4x

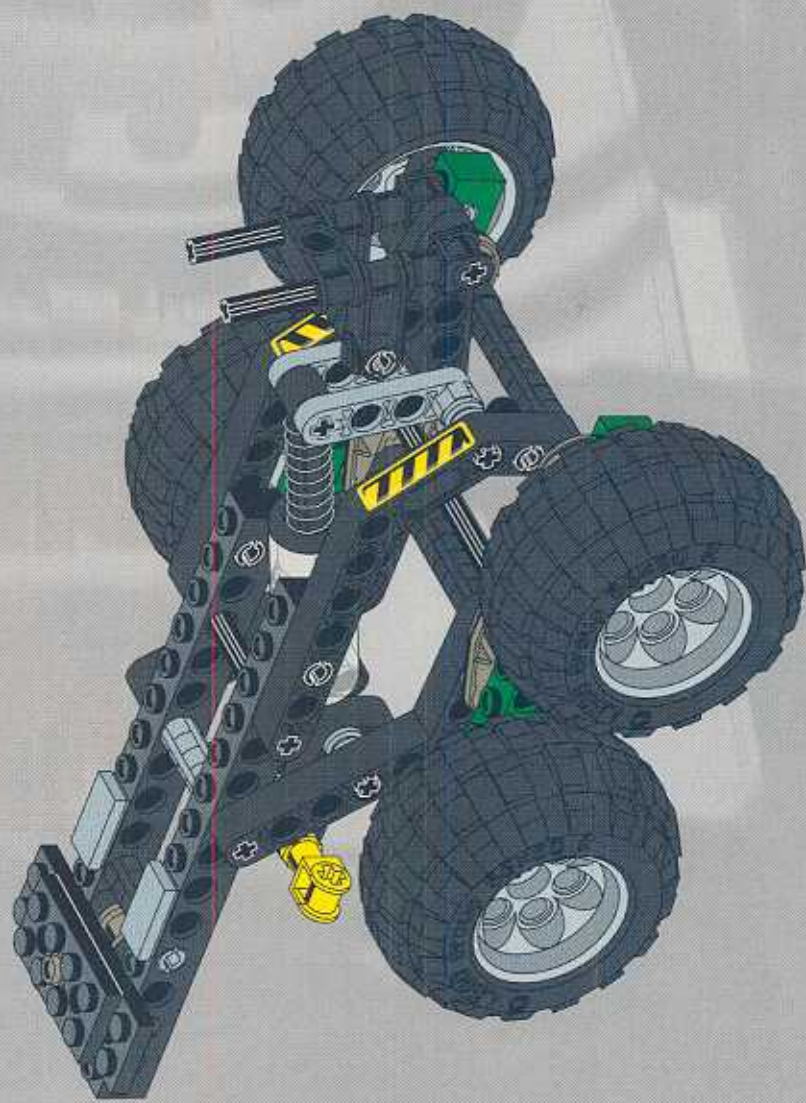



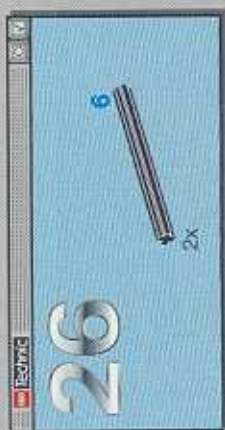
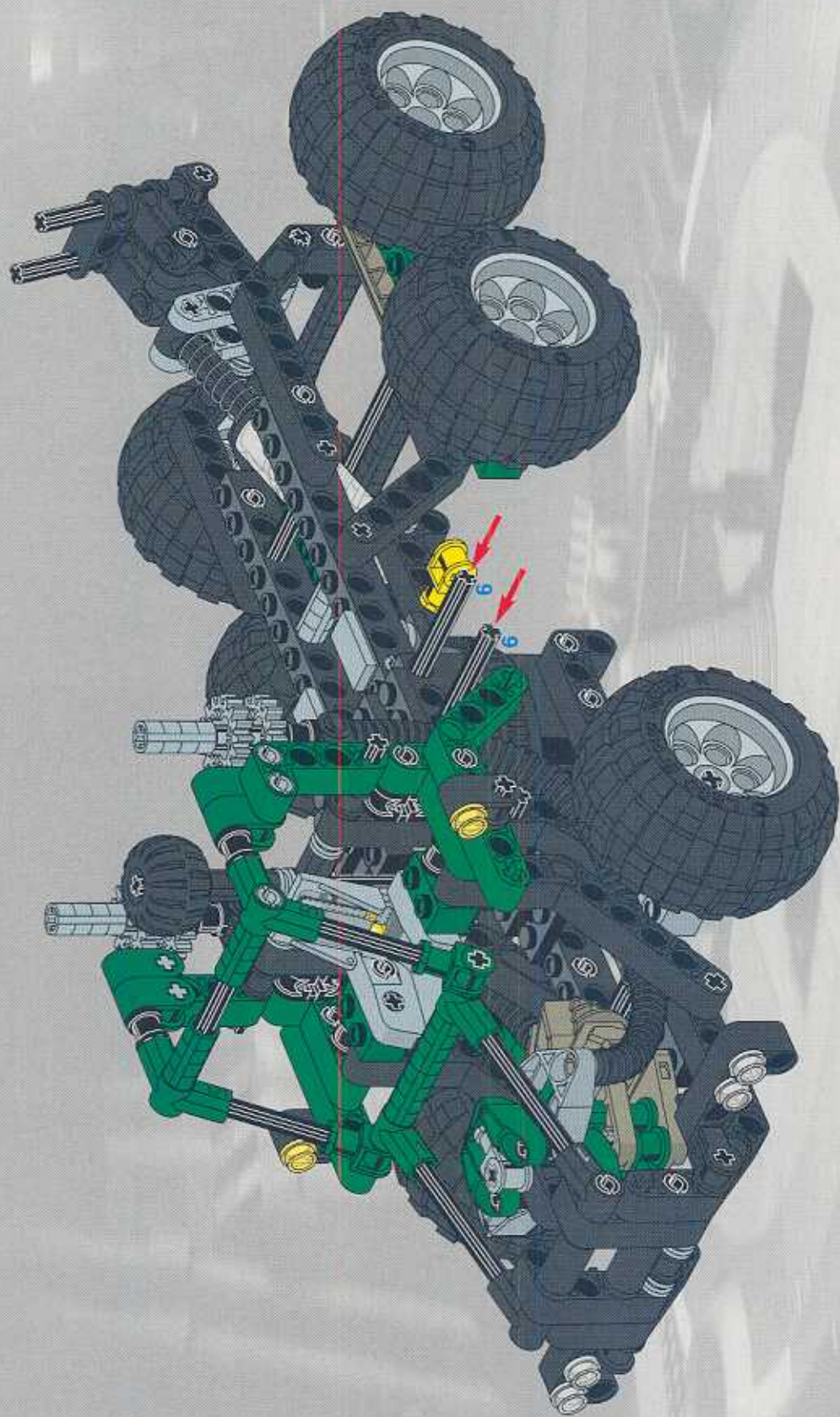



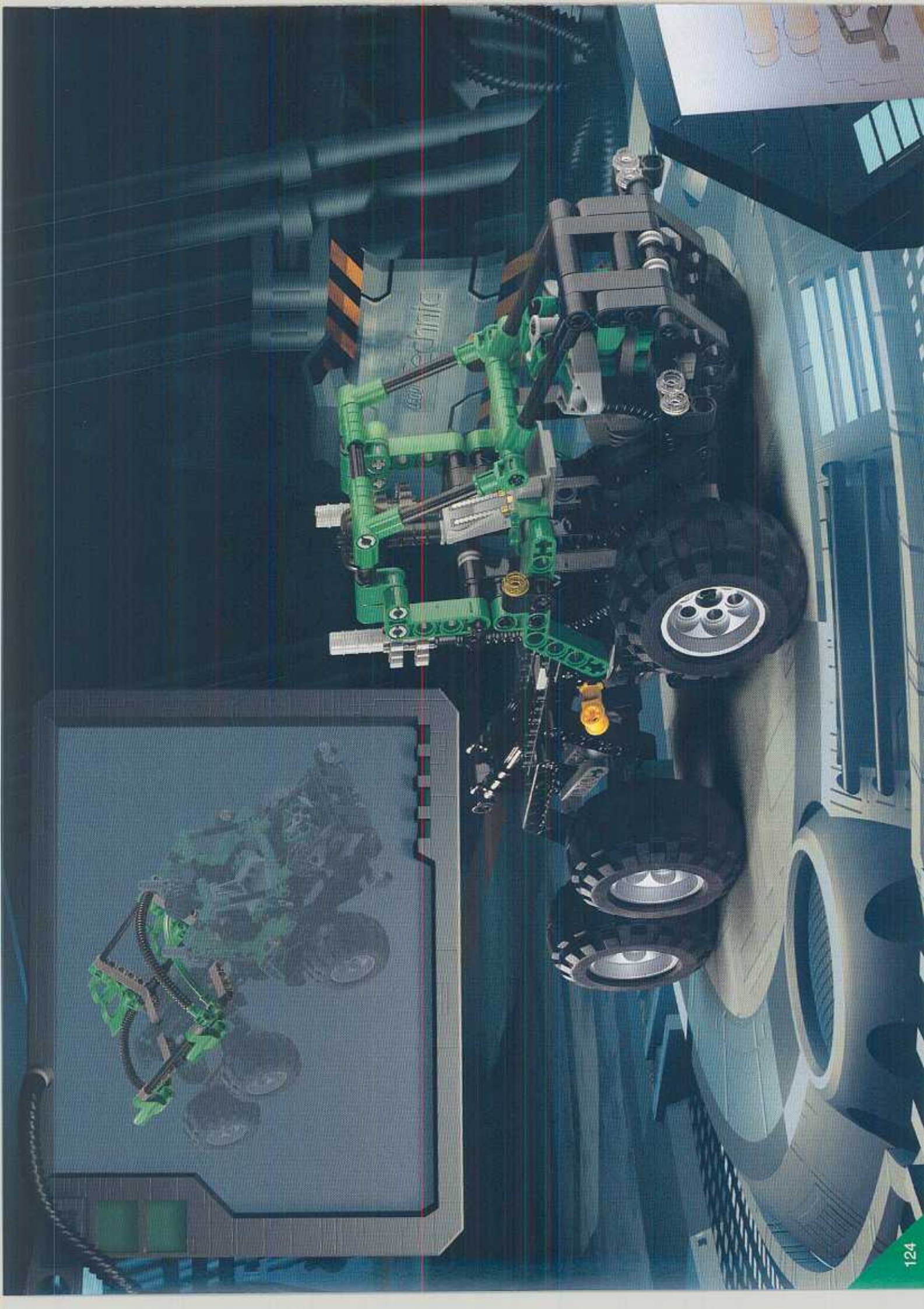



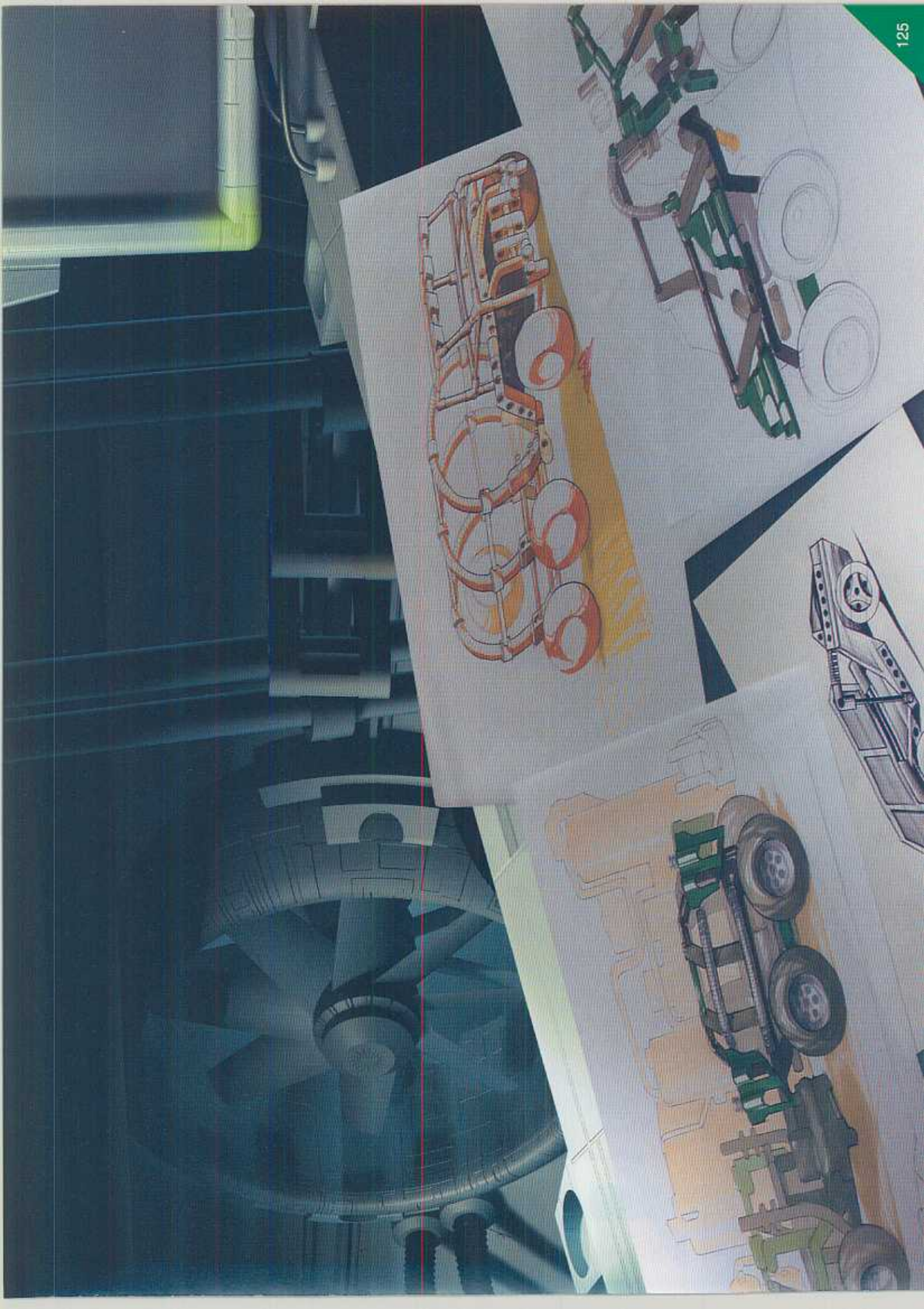







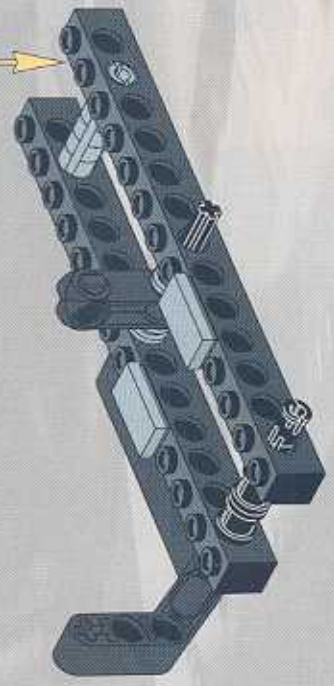
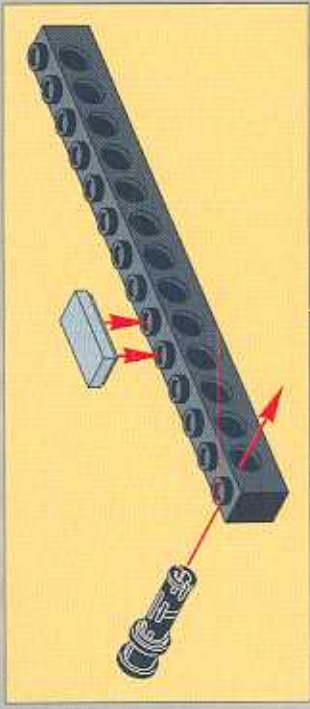
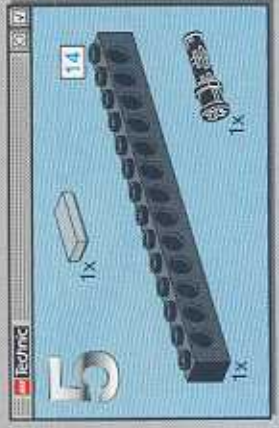
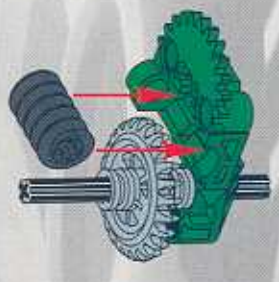
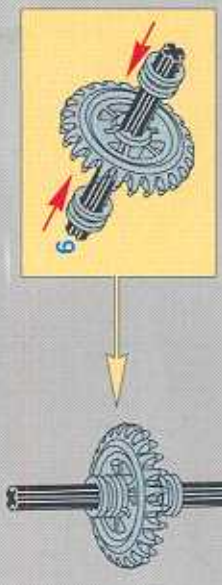
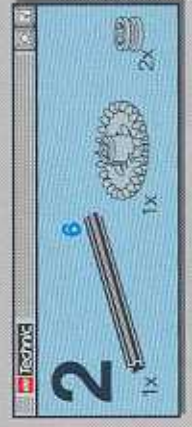



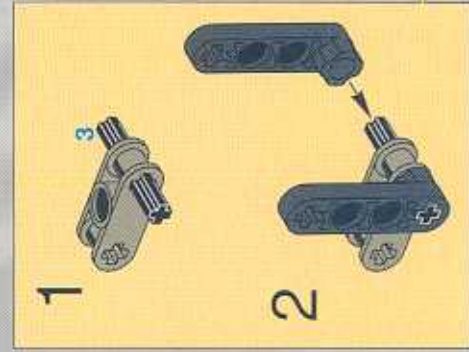
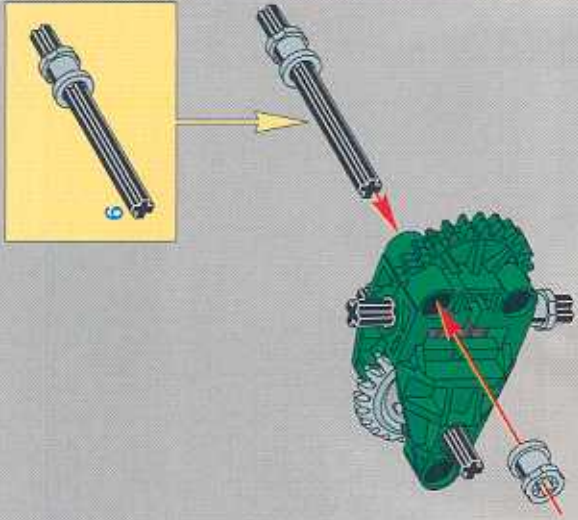
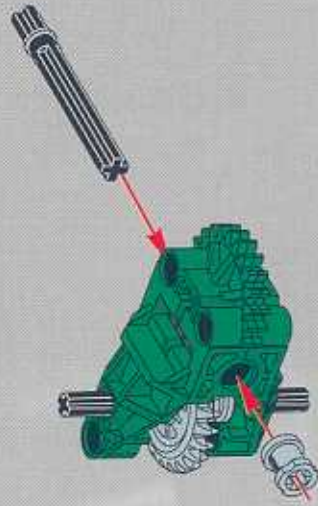



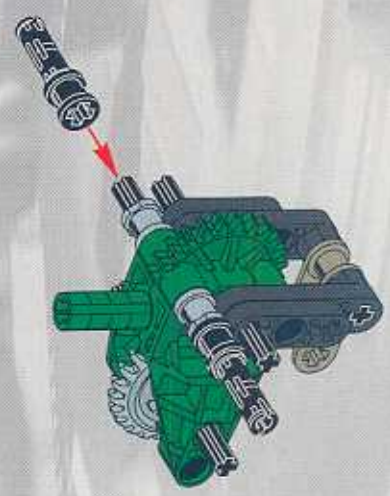
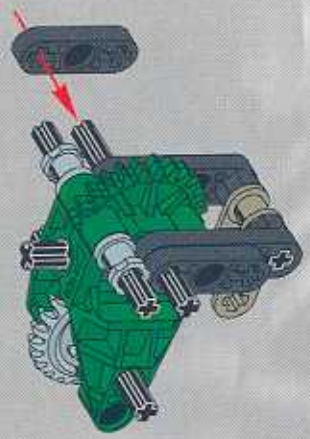
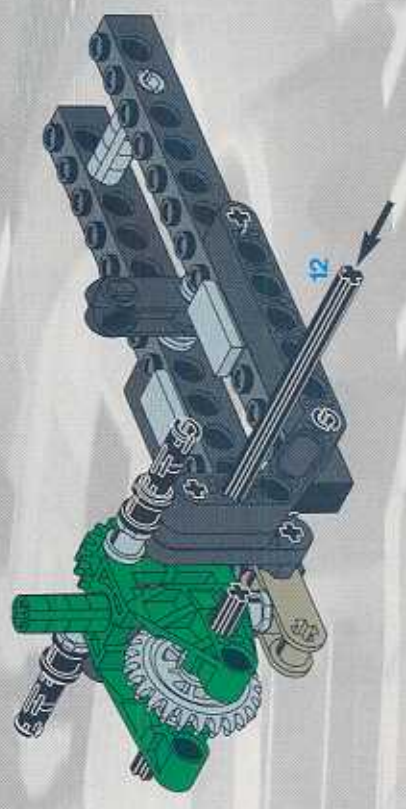
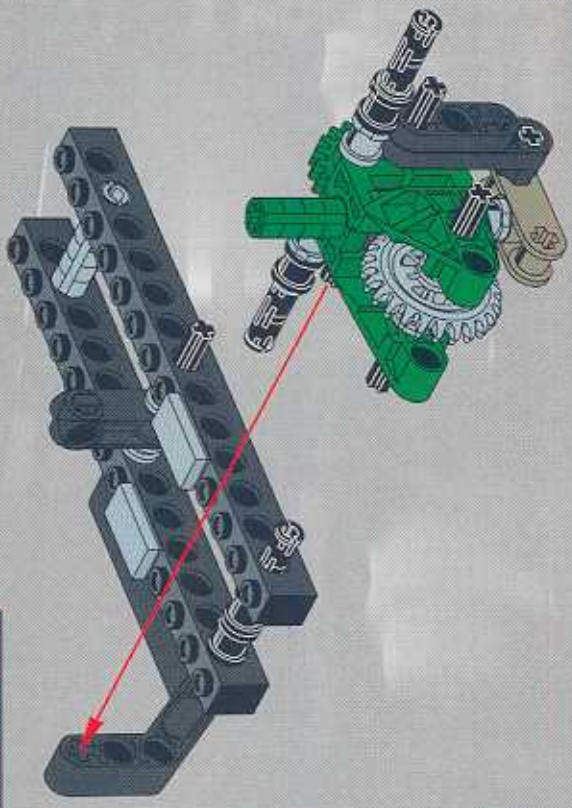
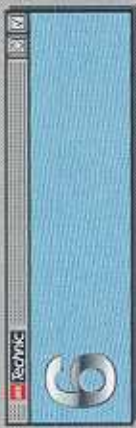



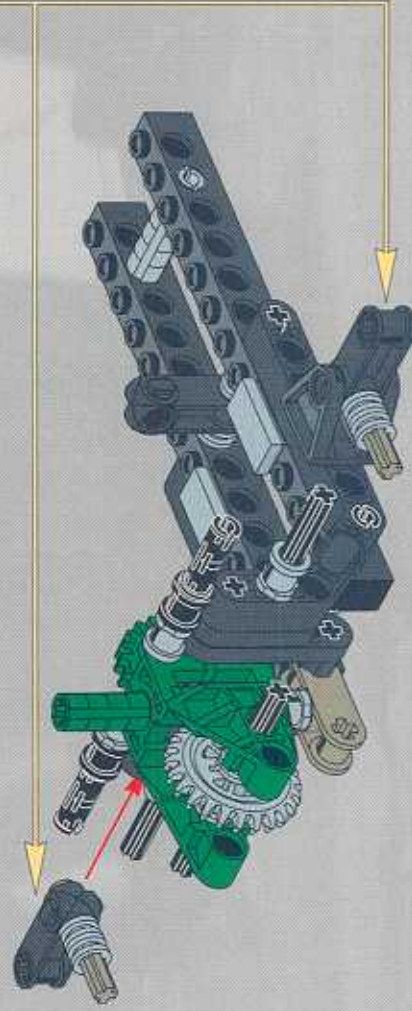
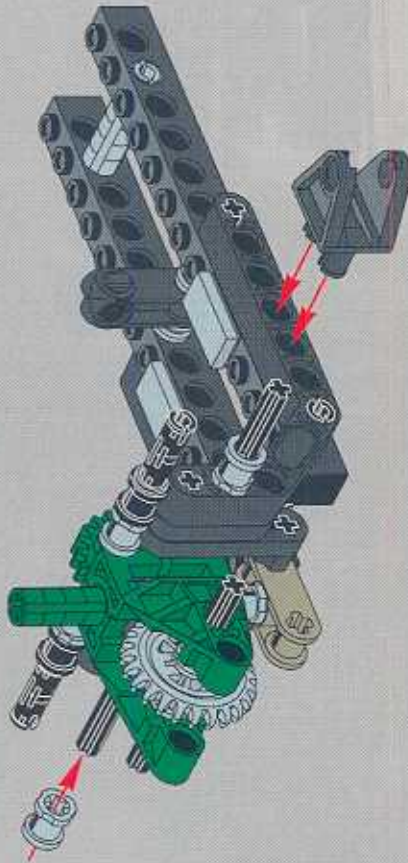
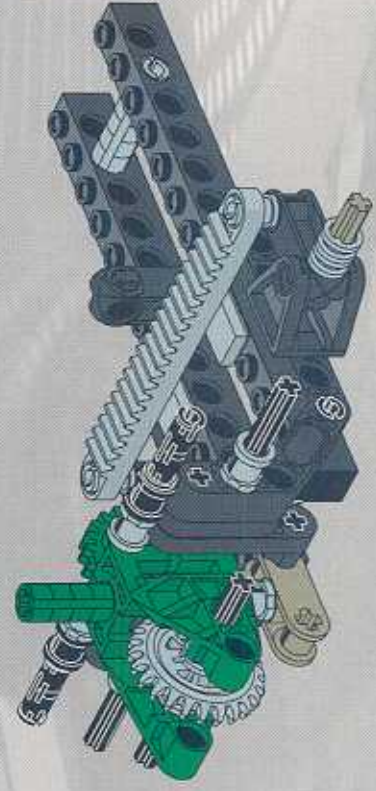
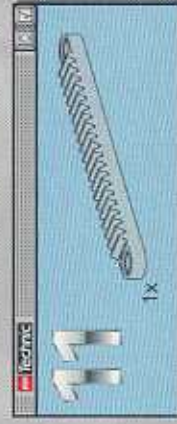
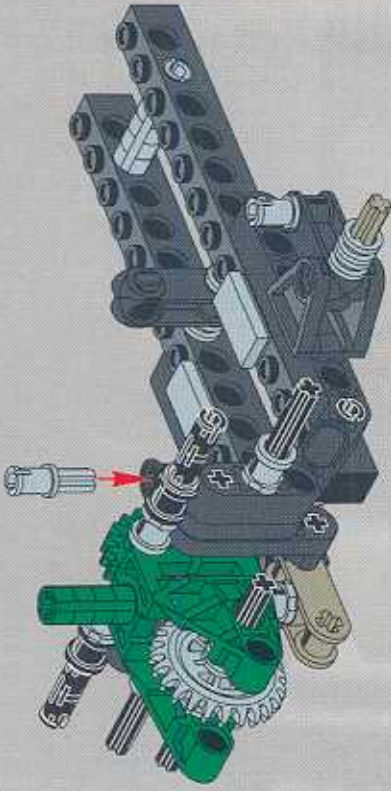



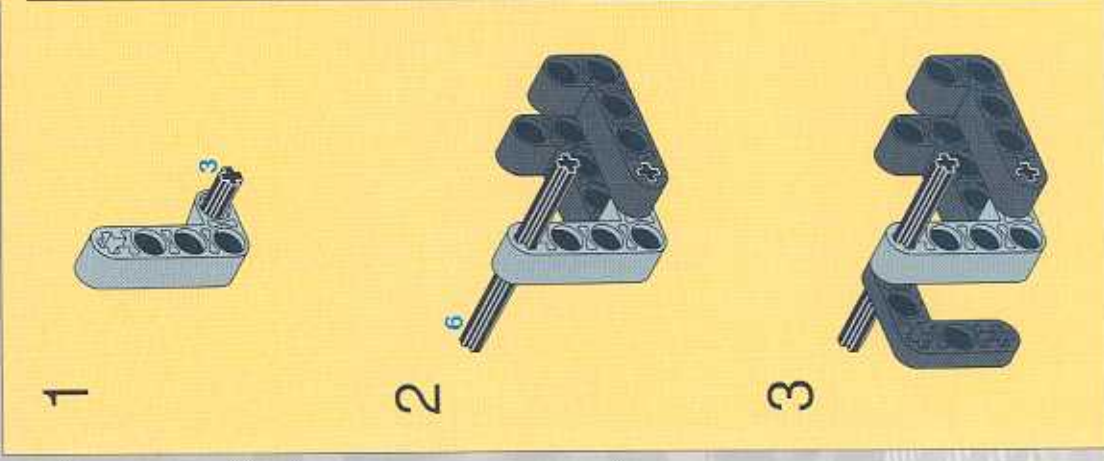
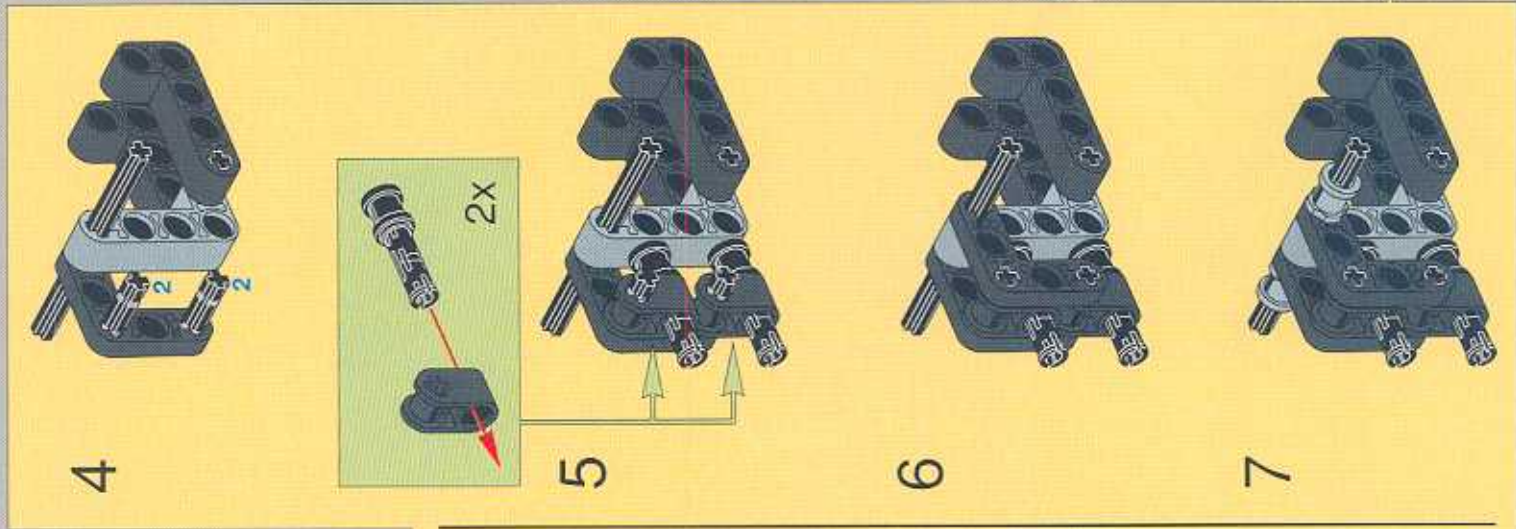



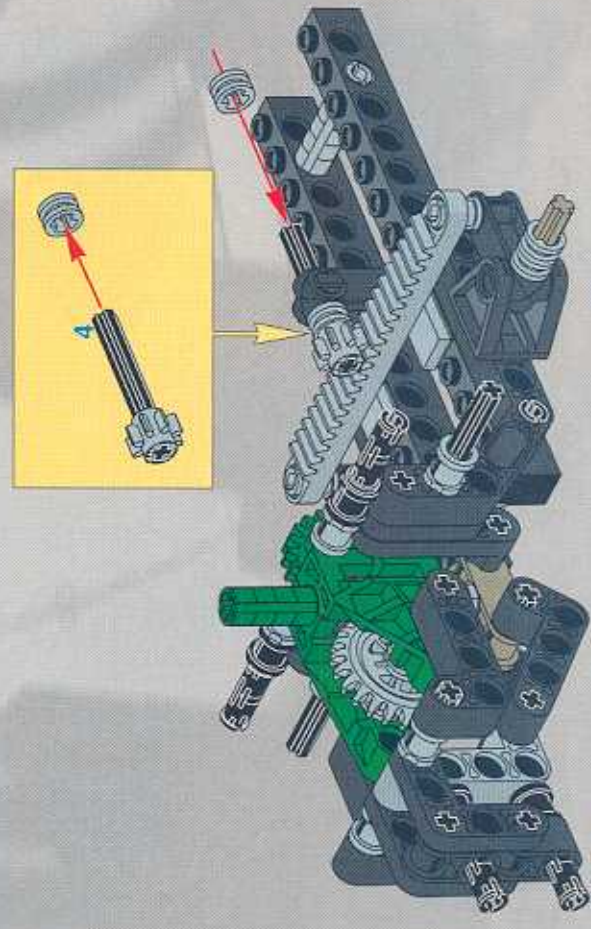
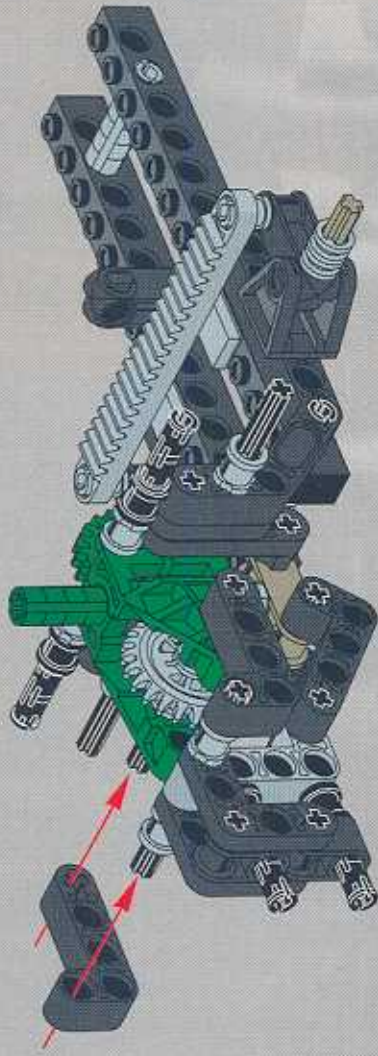



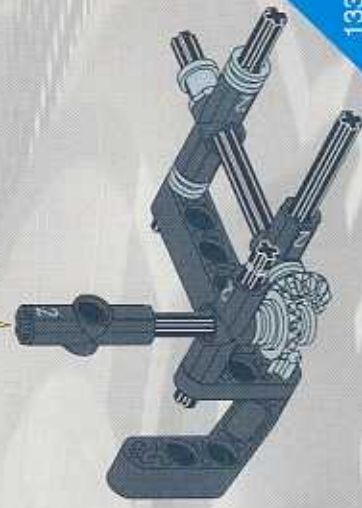
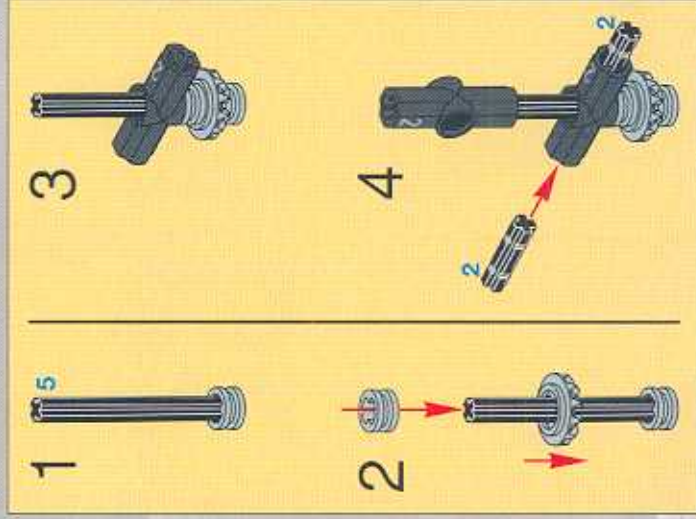
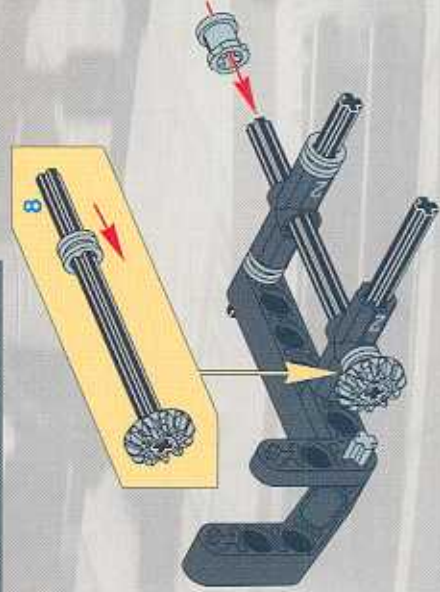
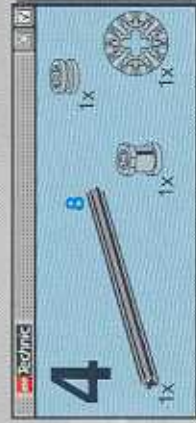
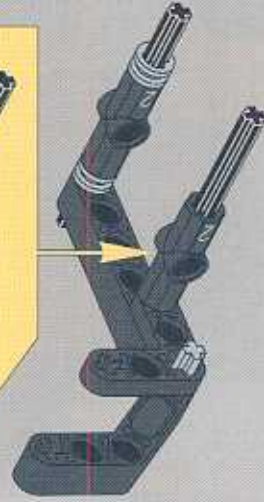
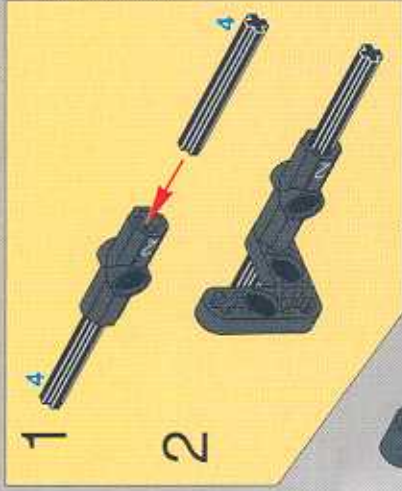
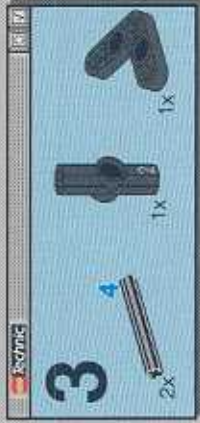
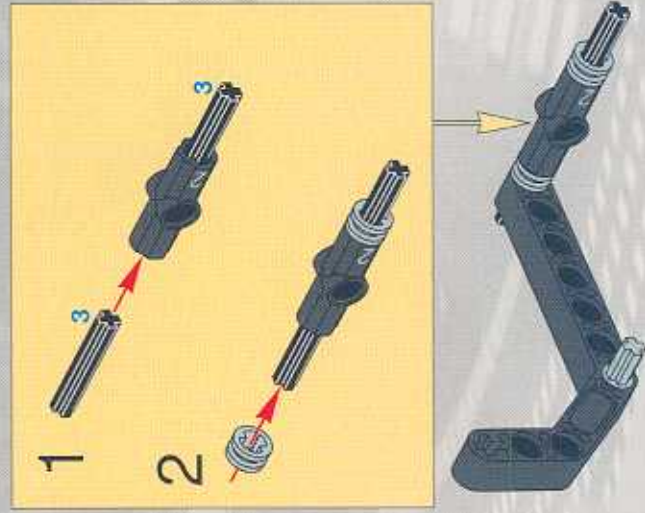



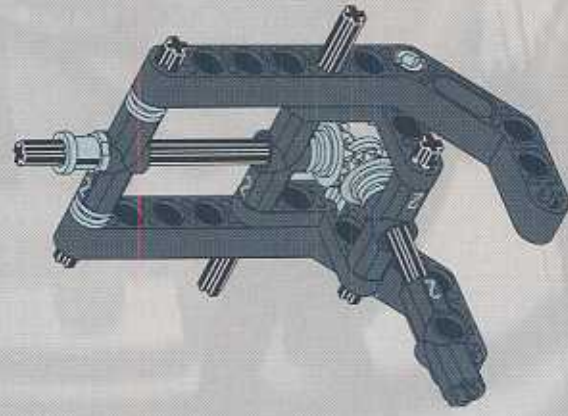
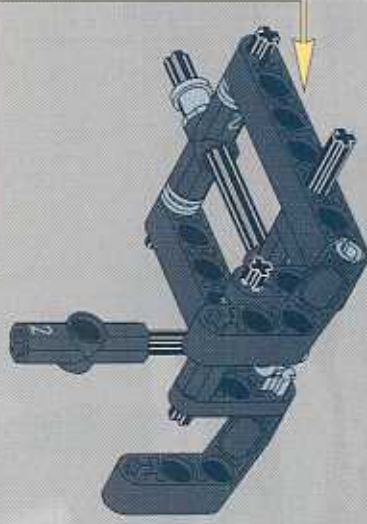
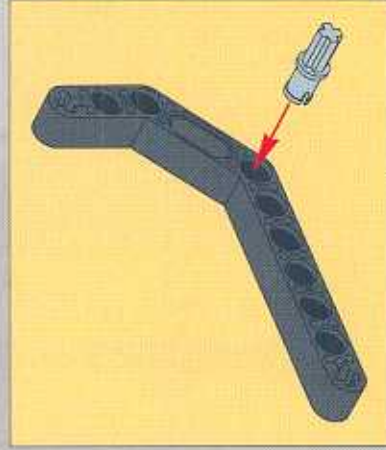
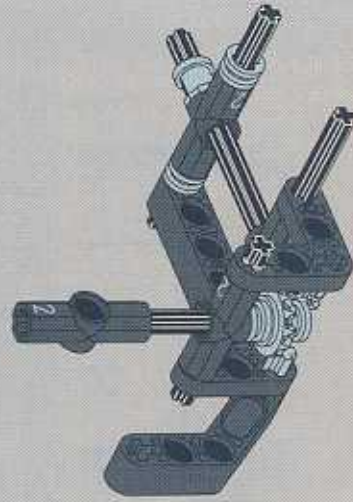



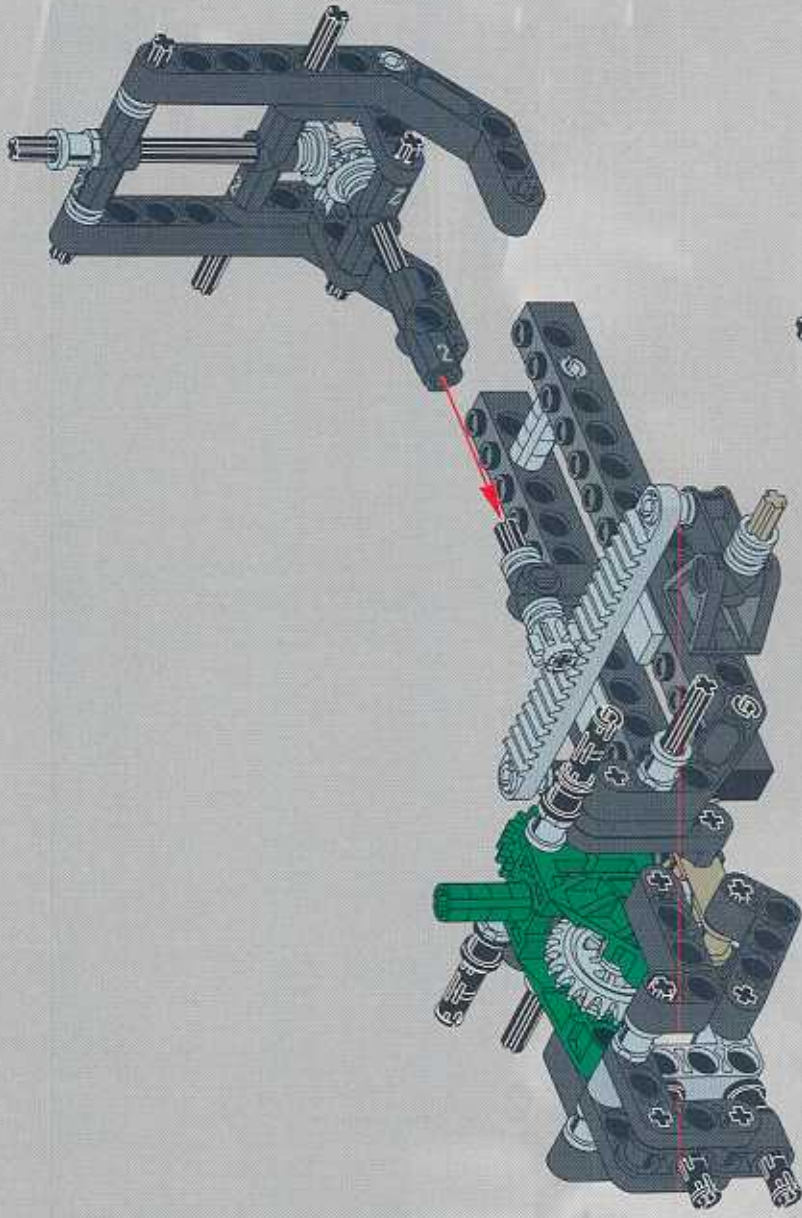
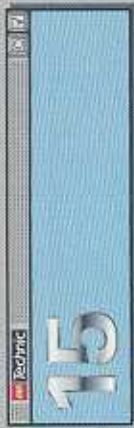



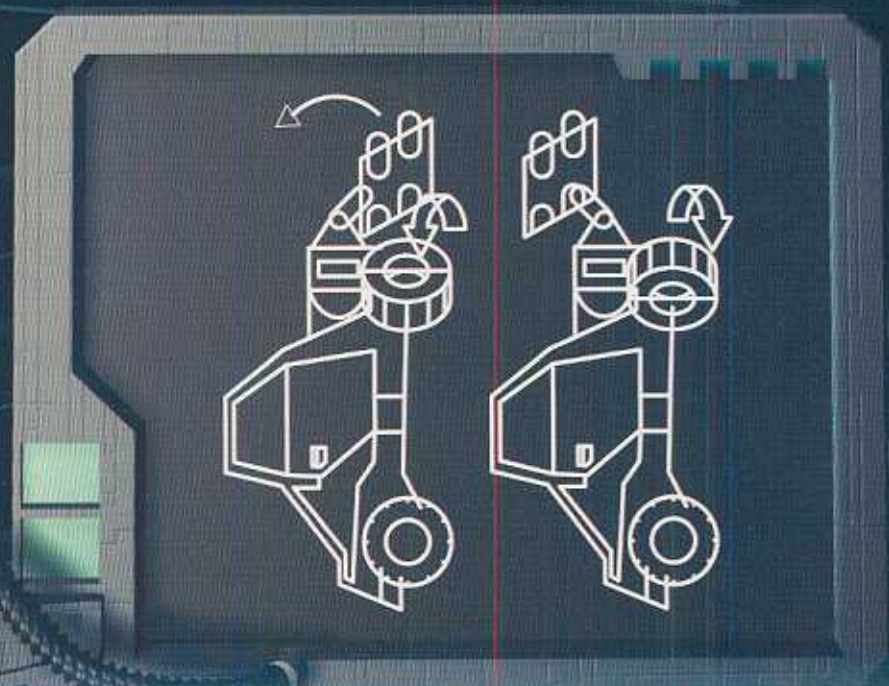
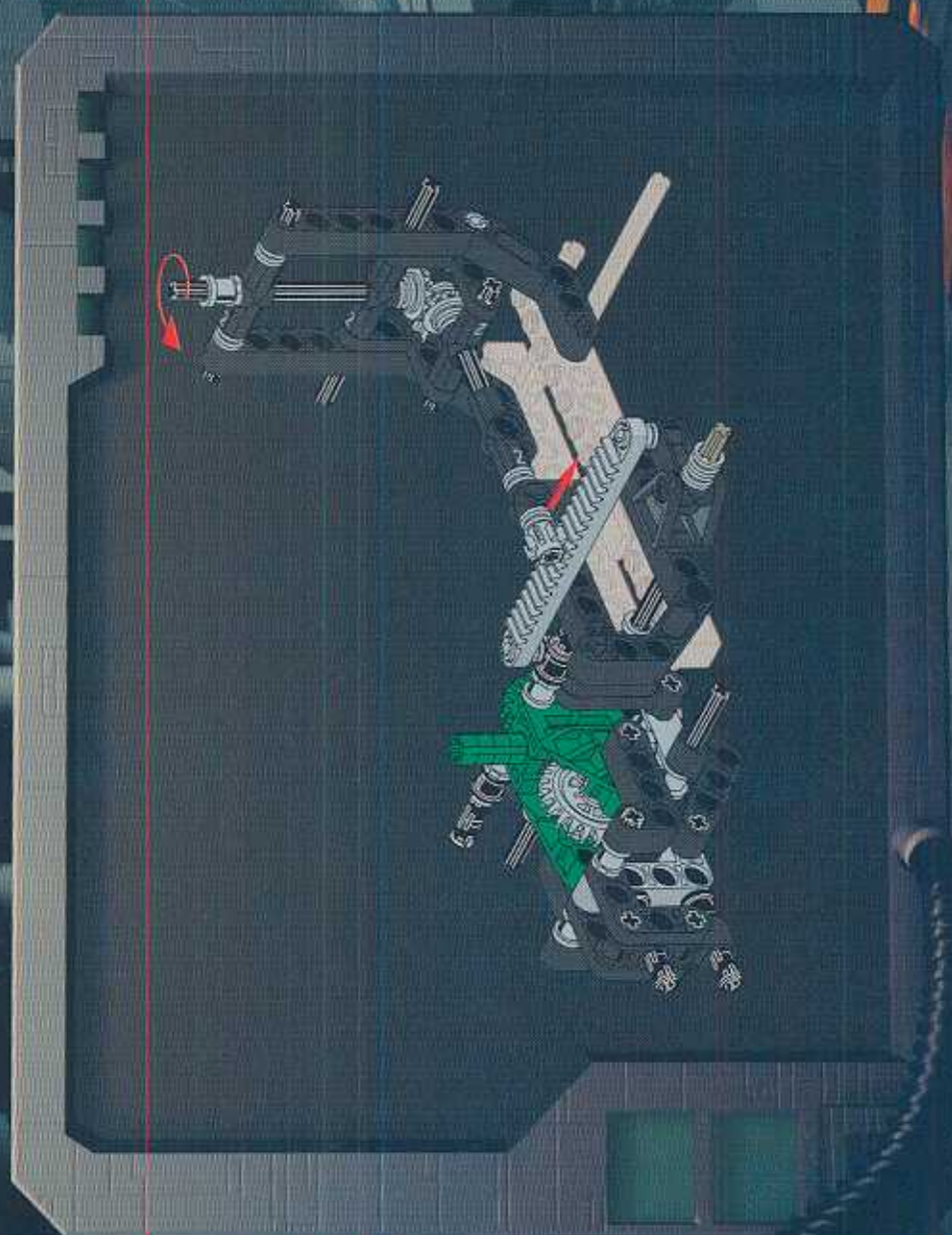







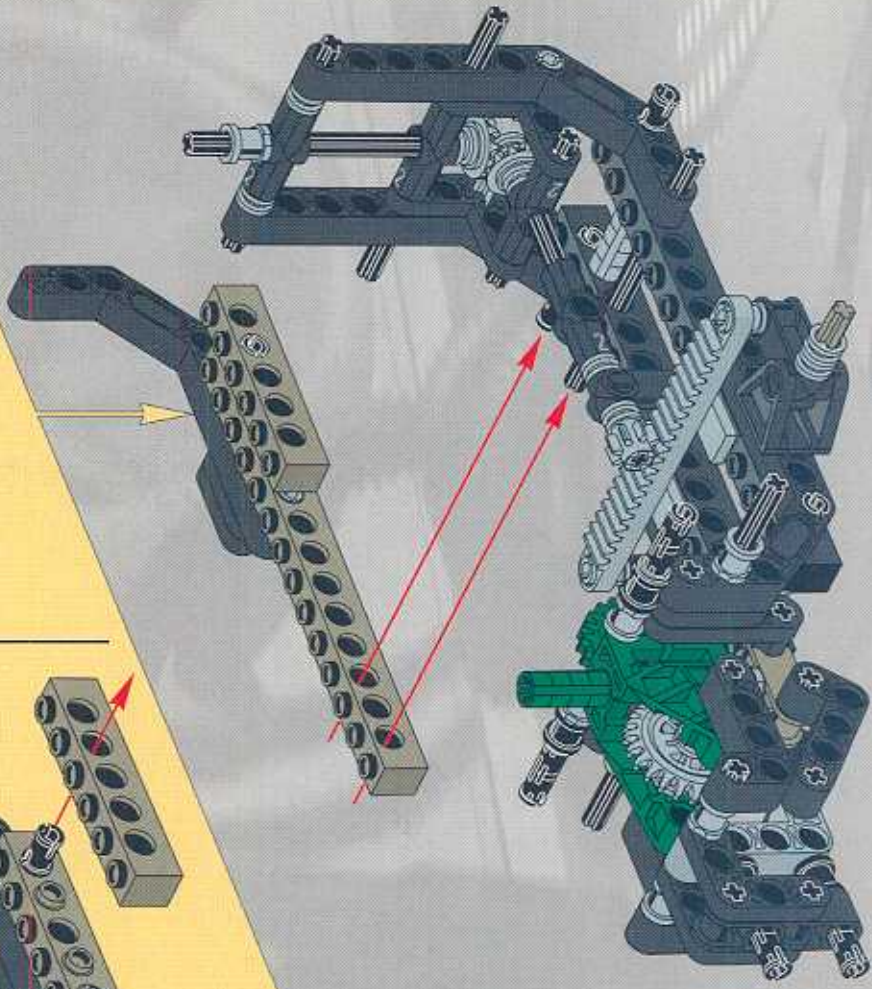
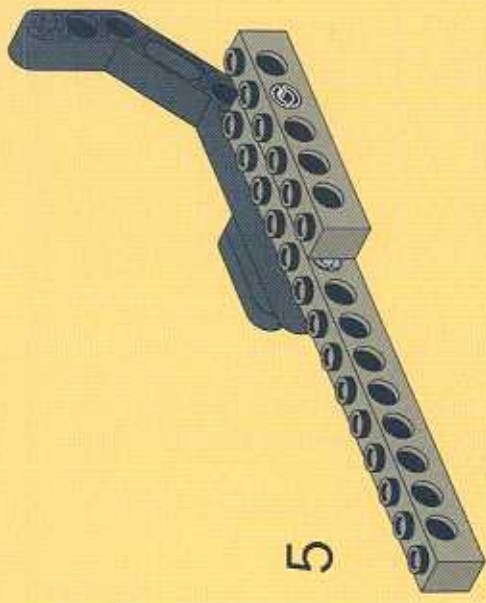
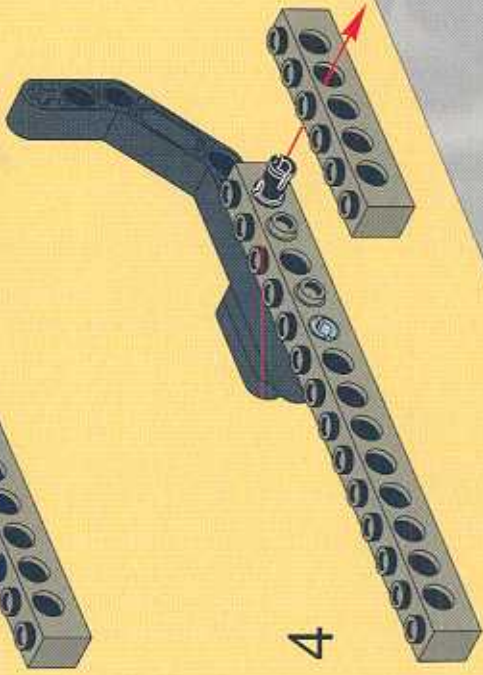
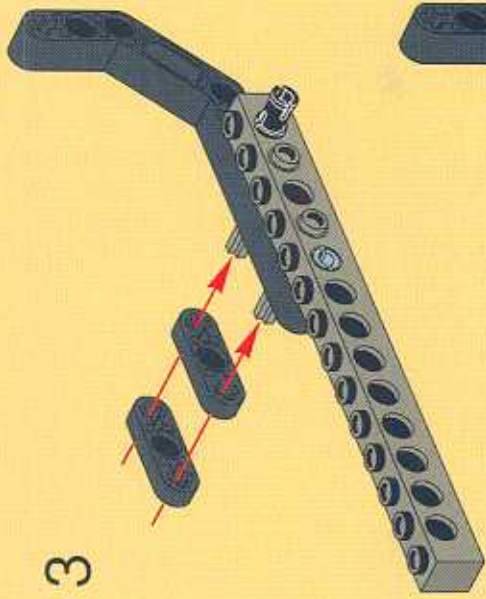
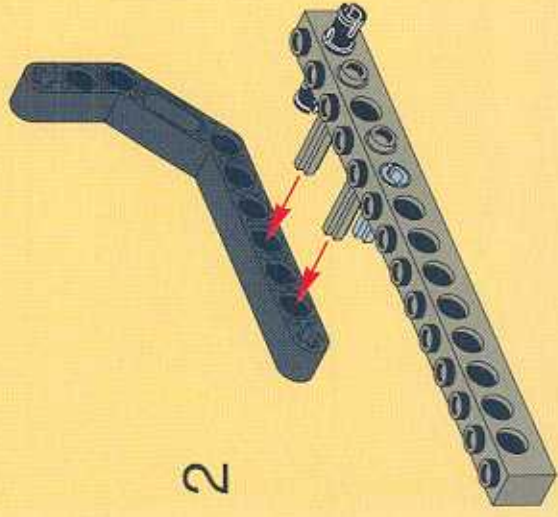
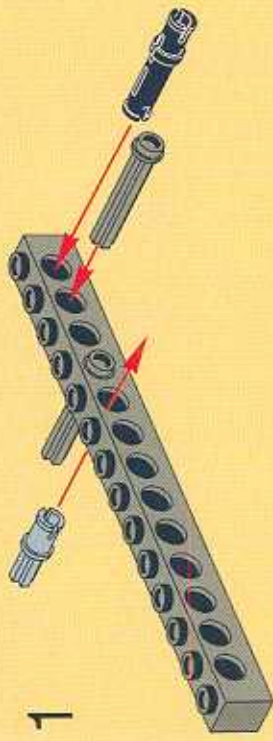
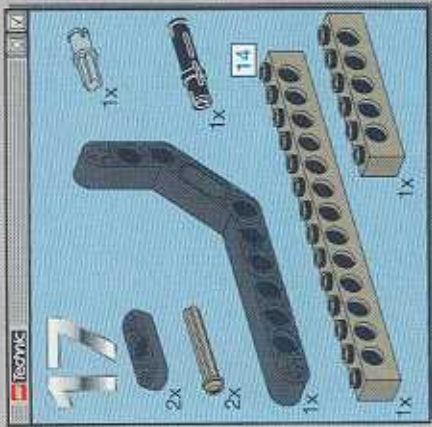



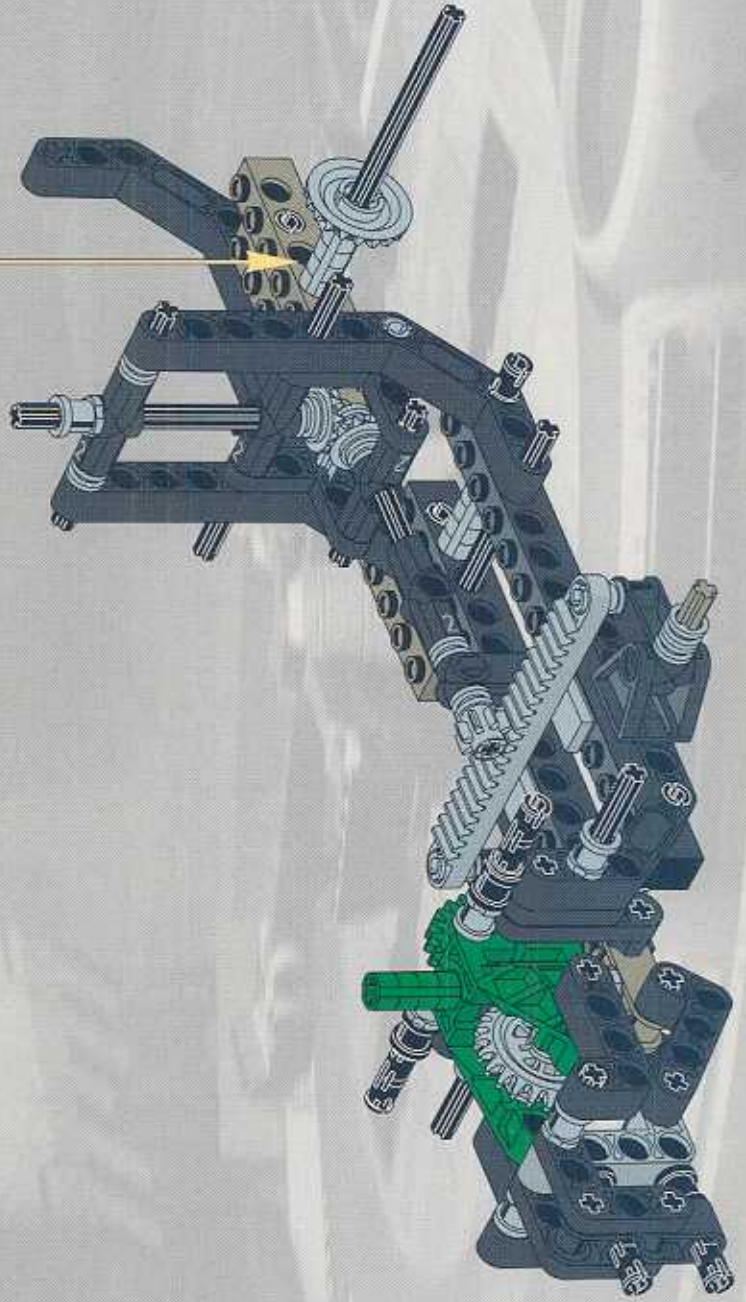
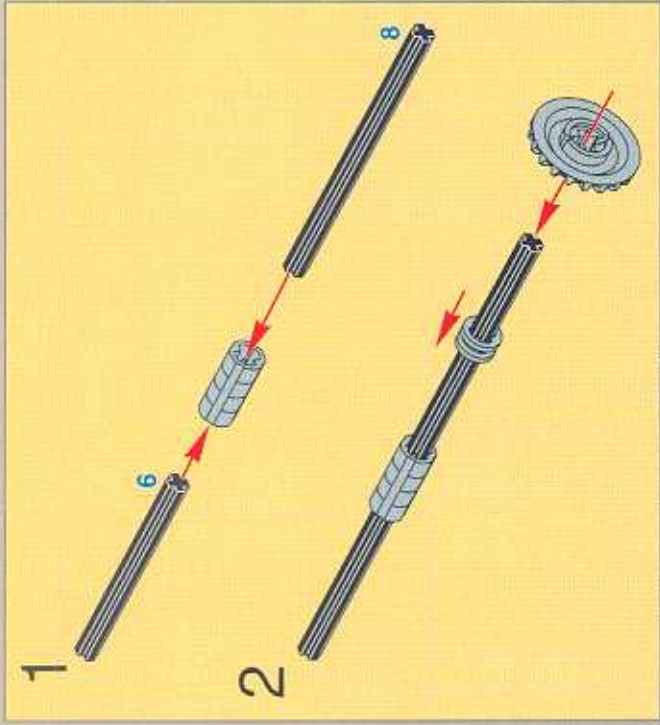
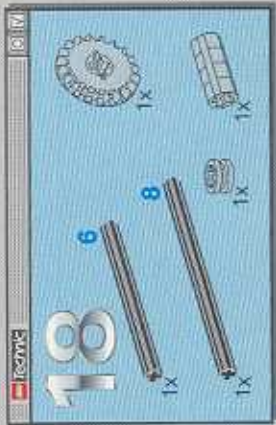







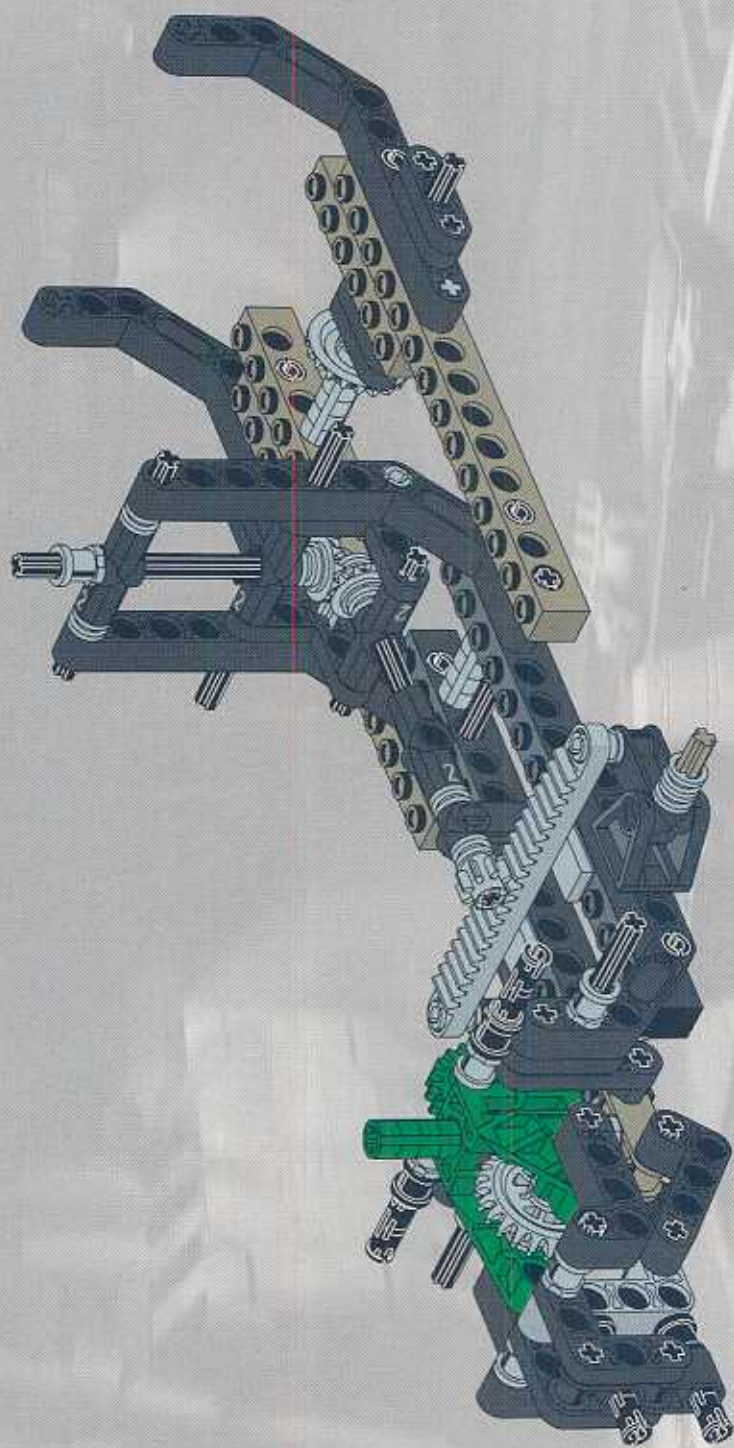



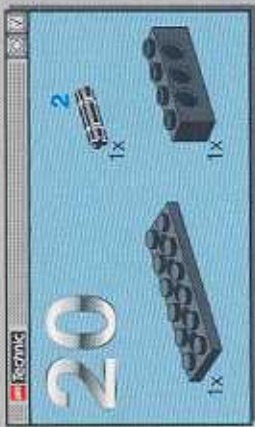
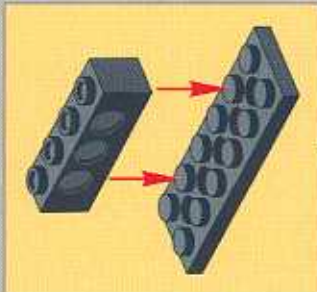
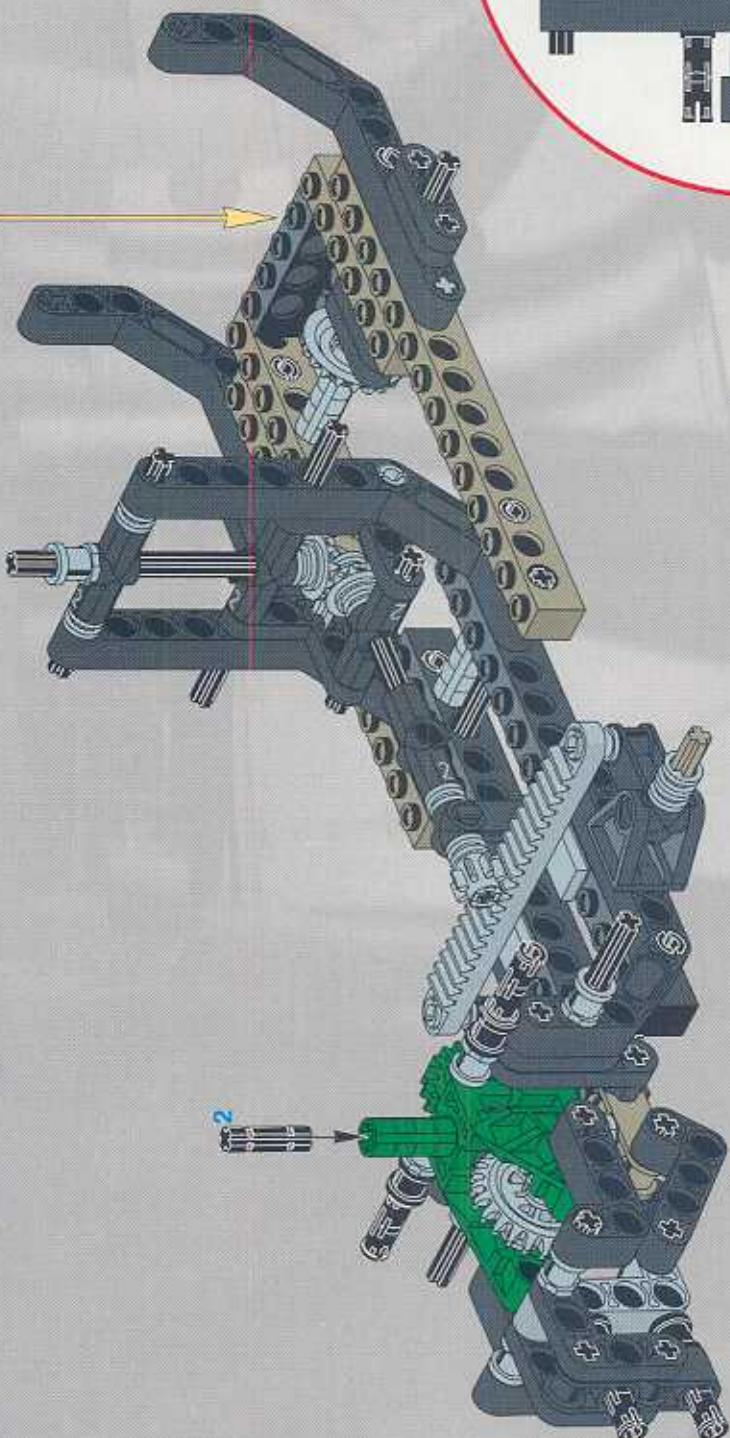



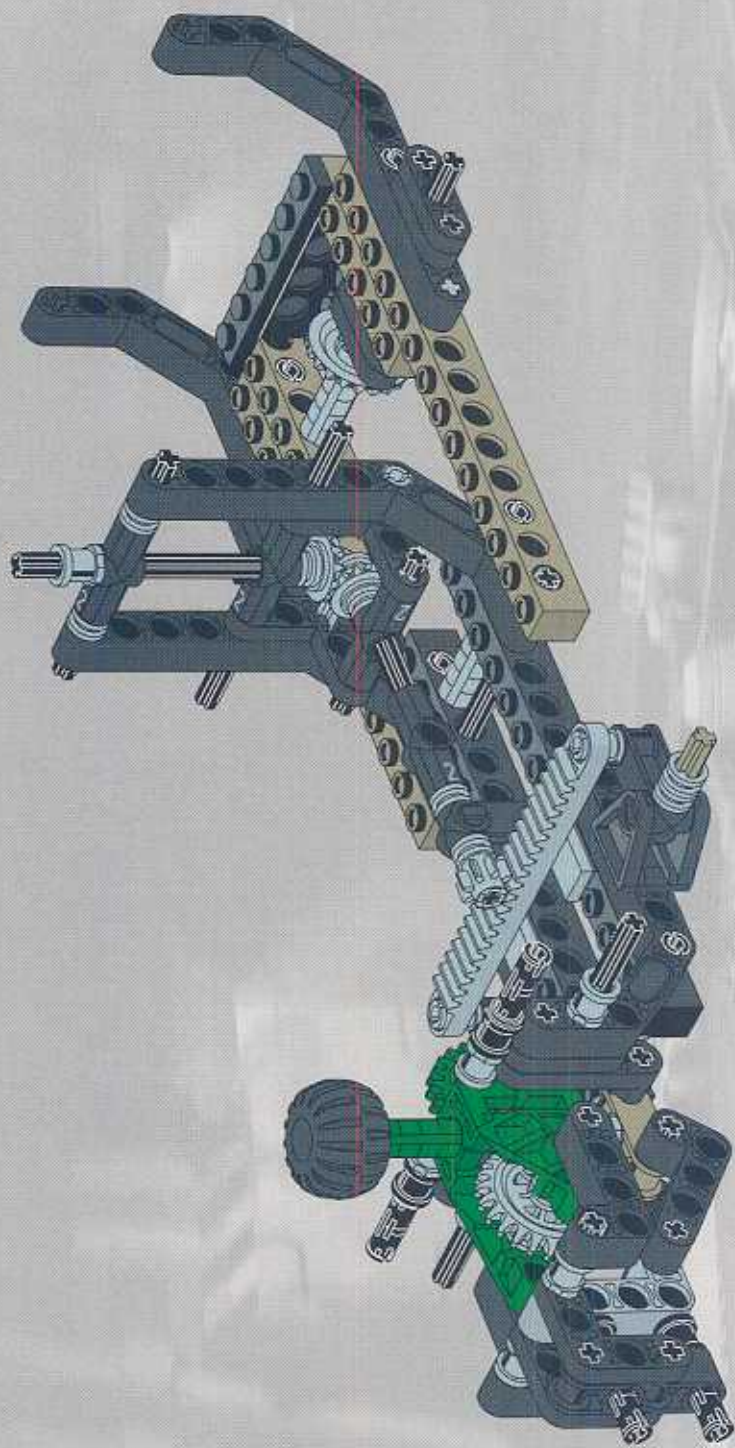



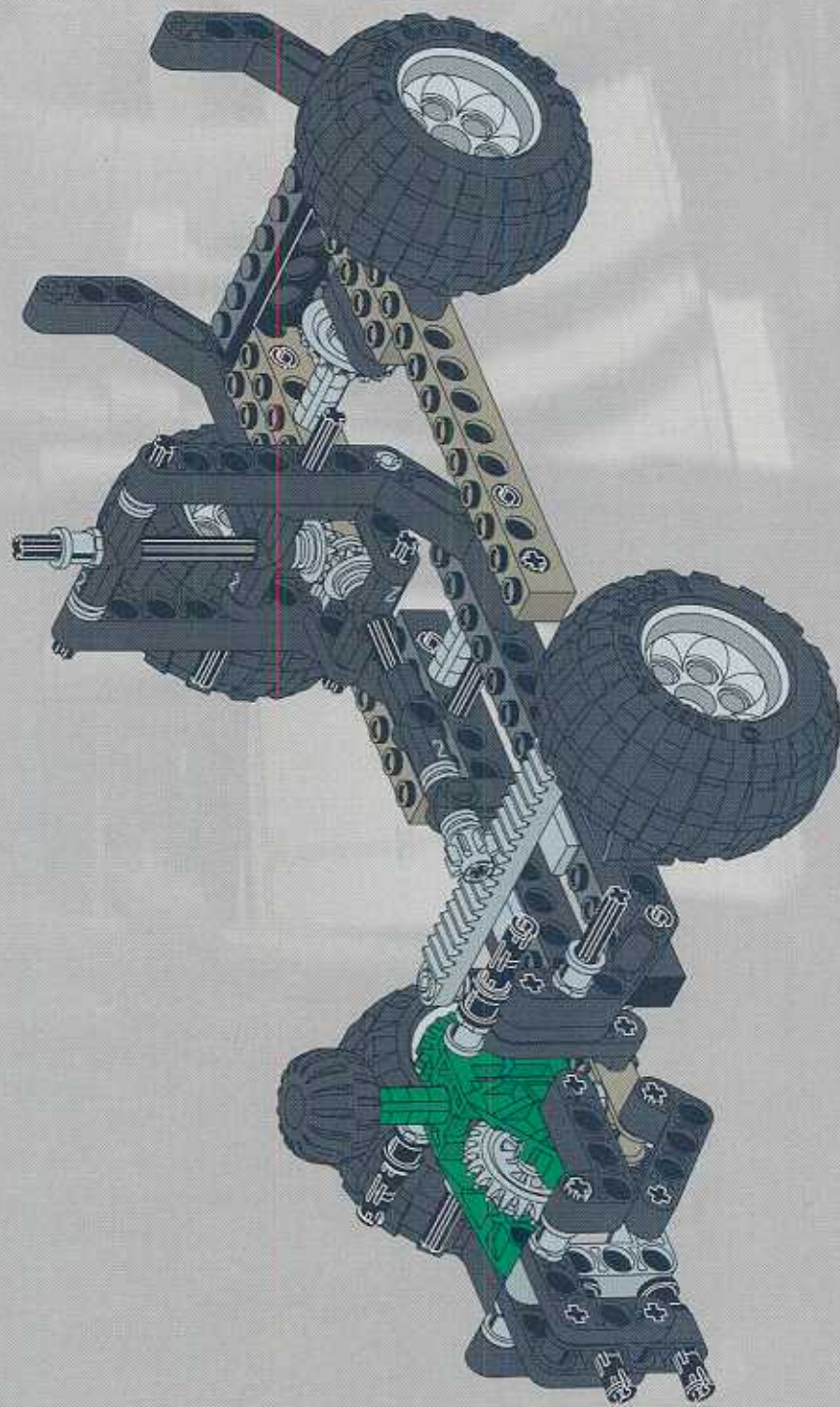



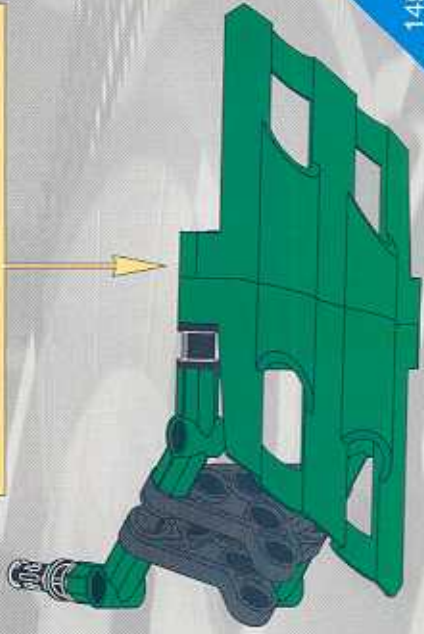
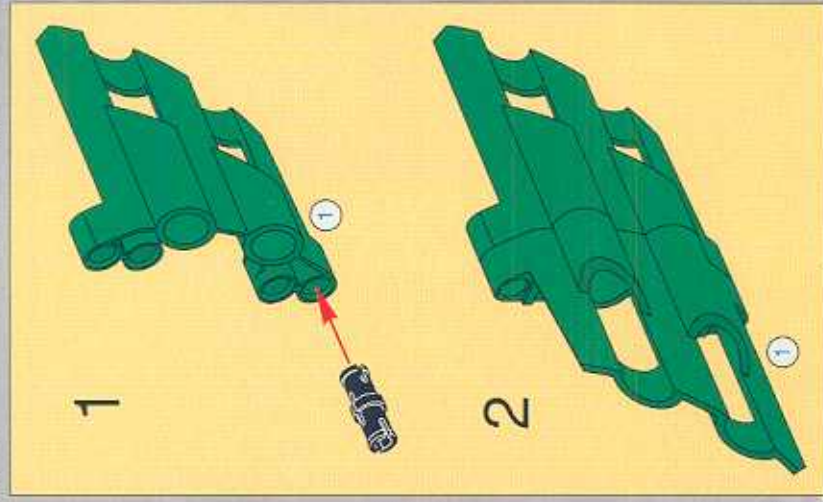
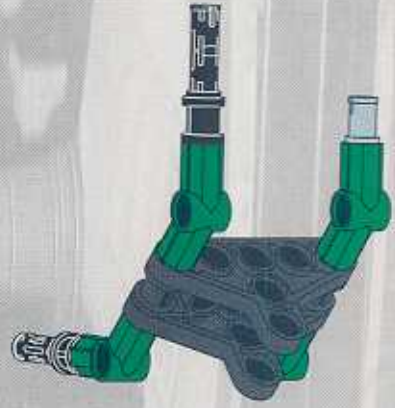
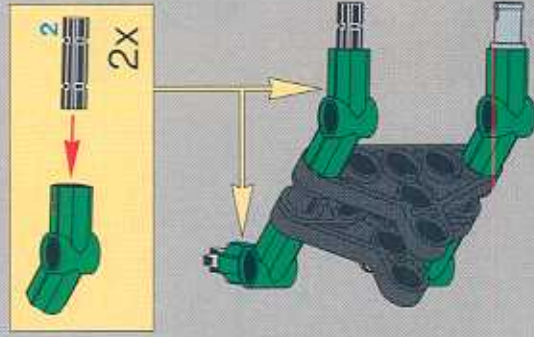
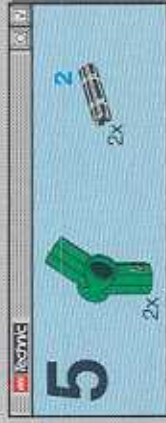



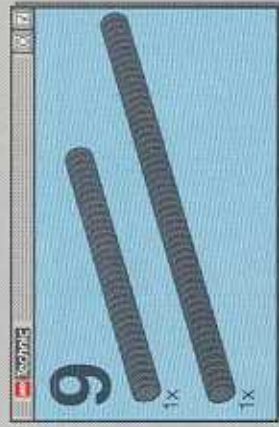
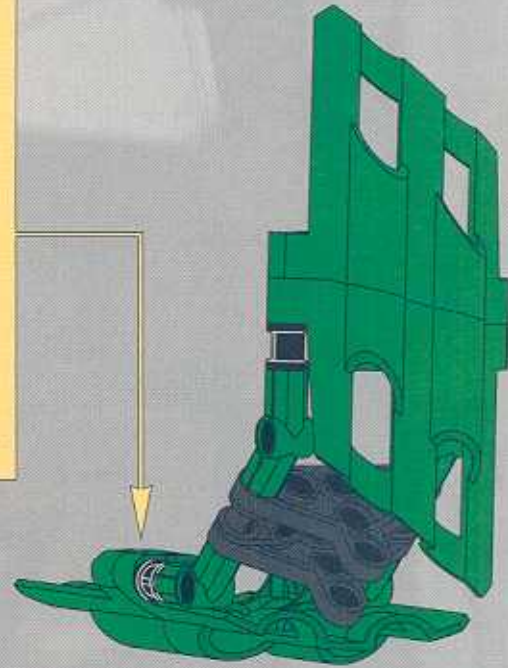
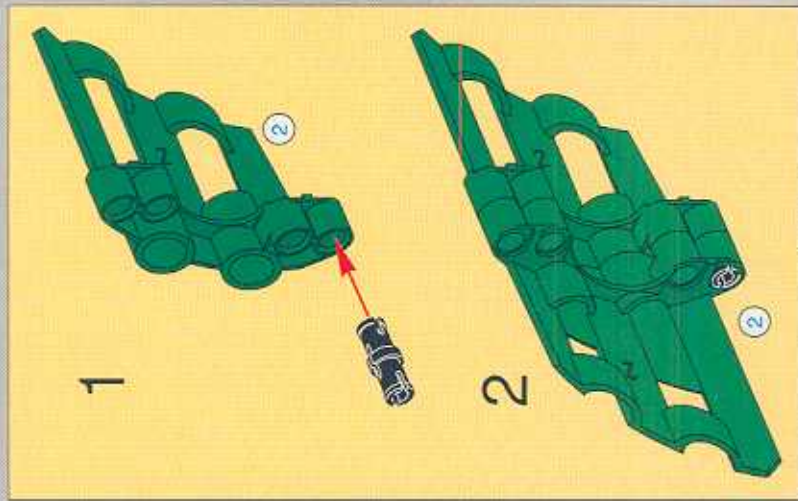



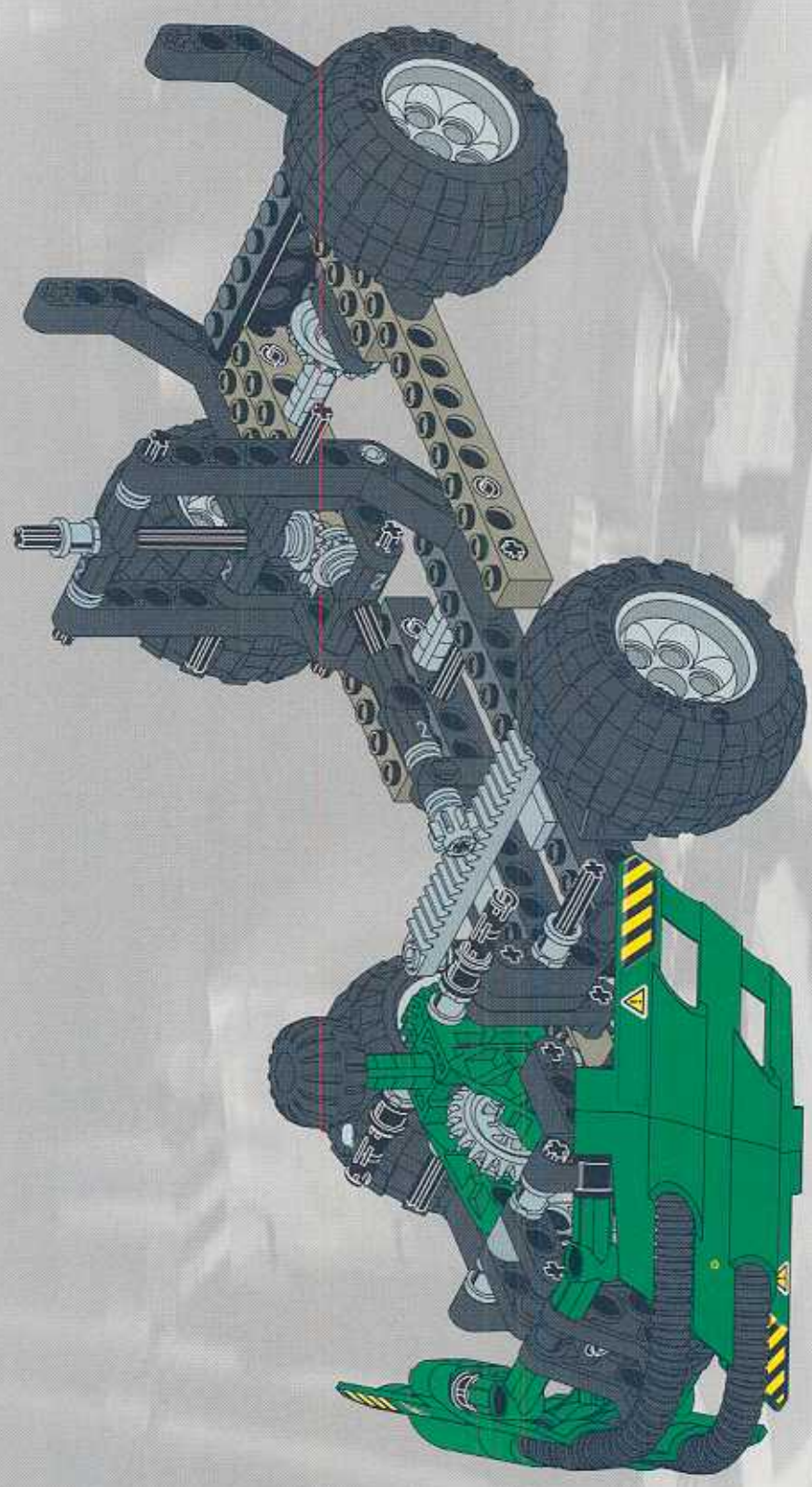







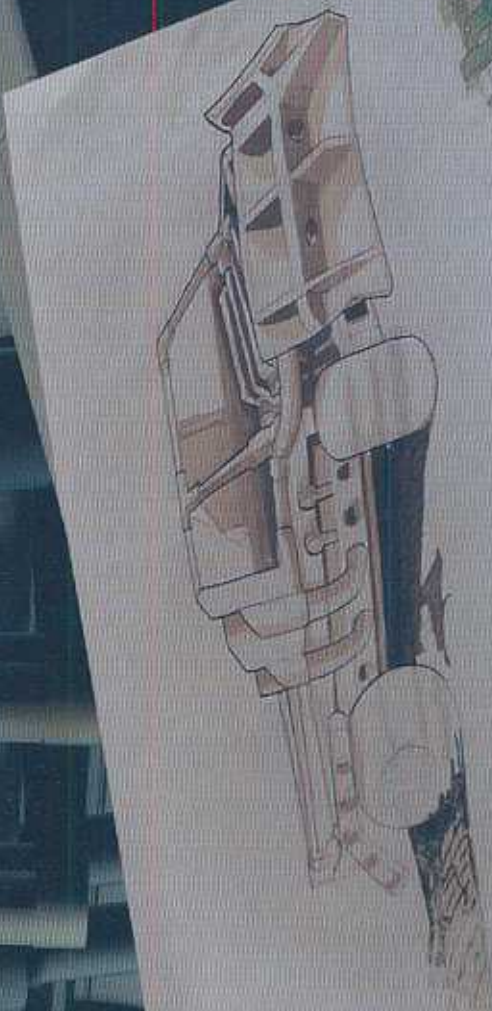
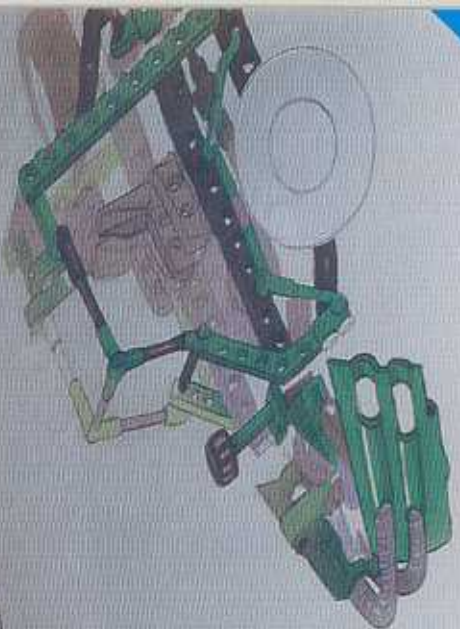





+



=

