

BIONICLE®

GELU



8988



1

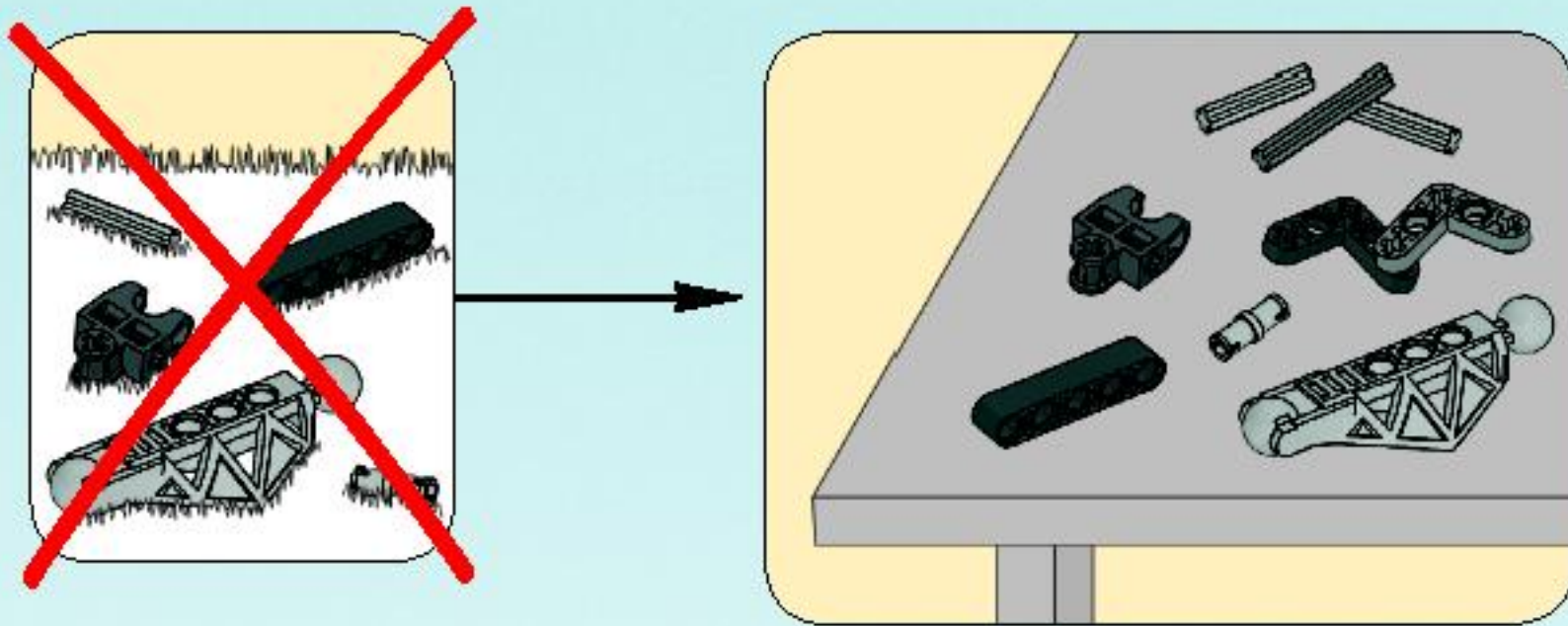

2

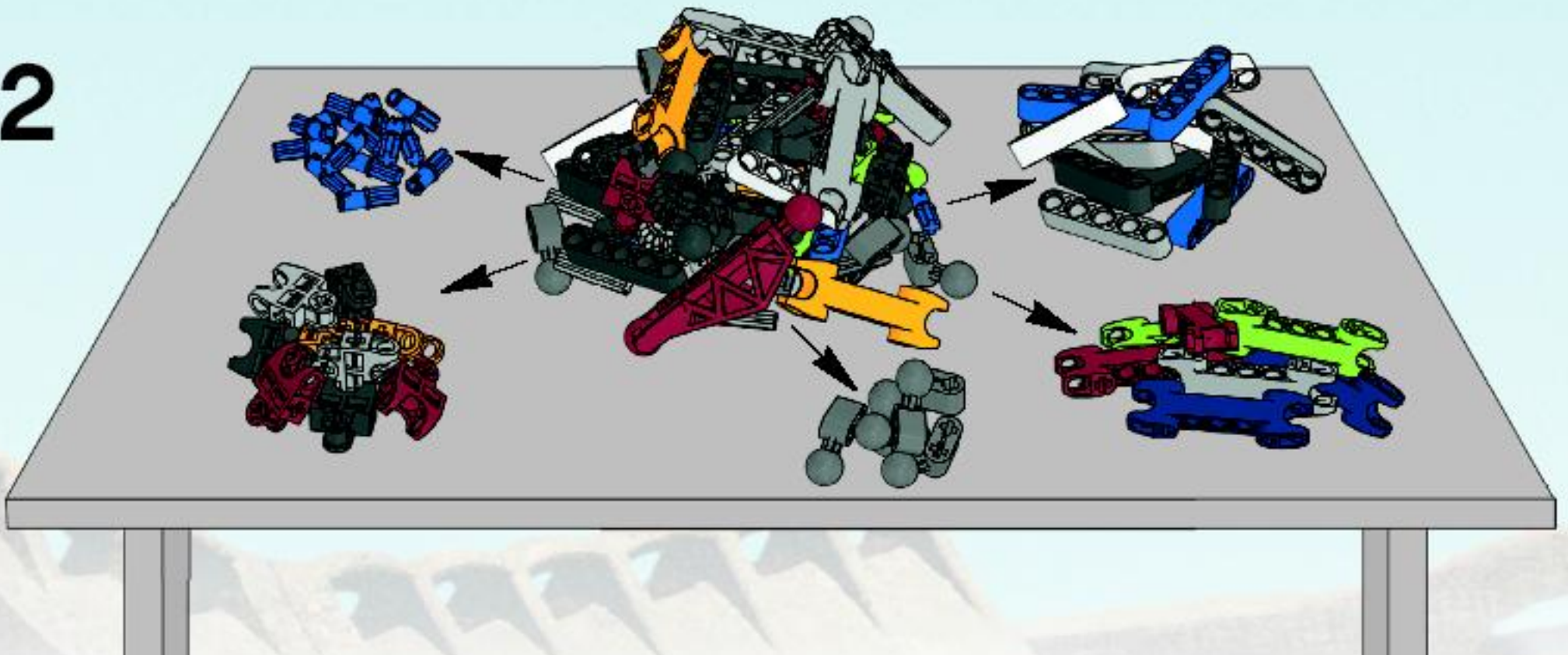

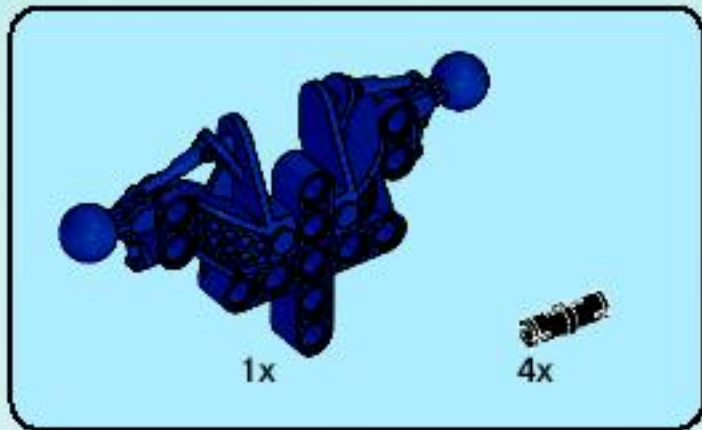

1

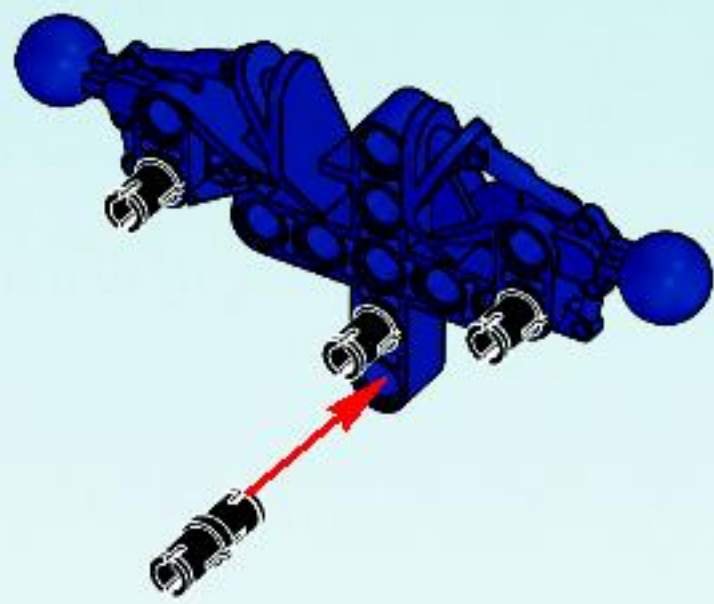

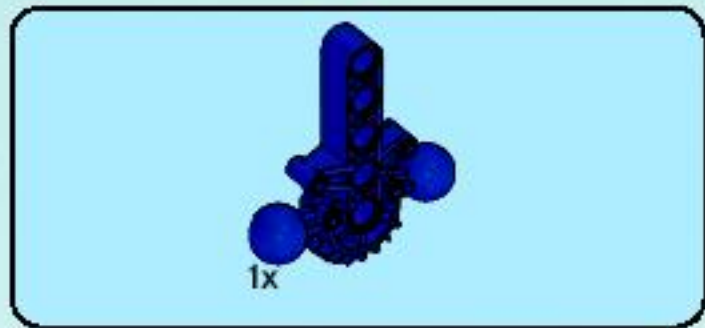

2

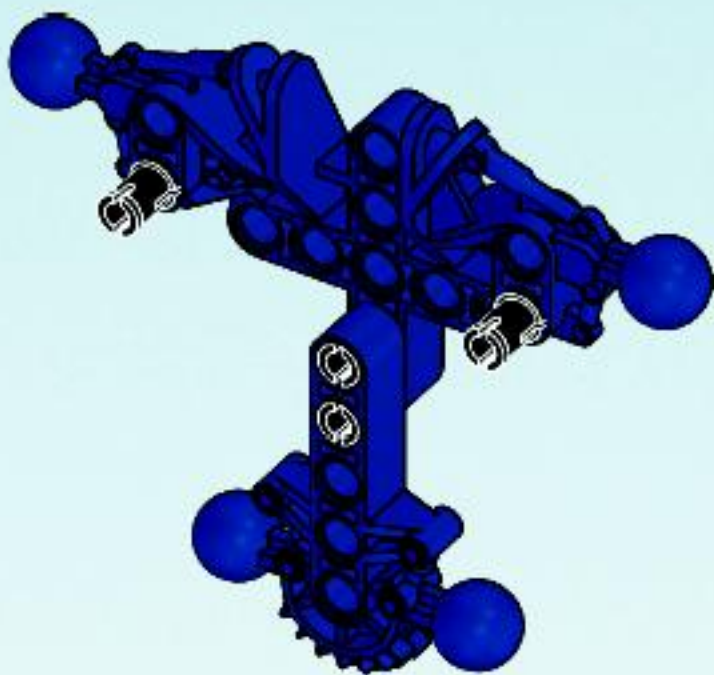

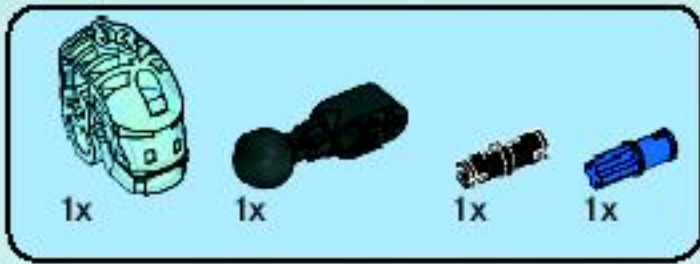

3

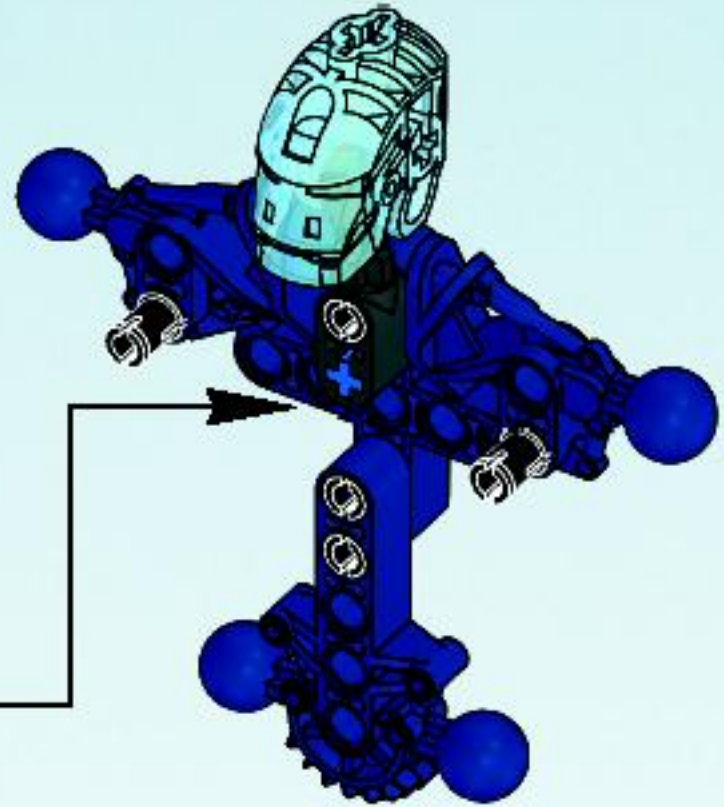
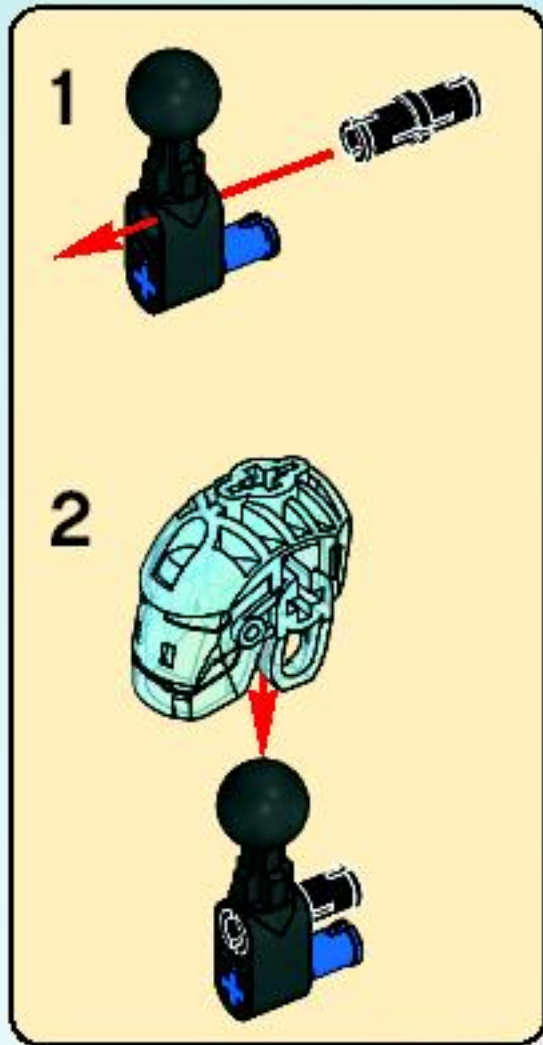



4

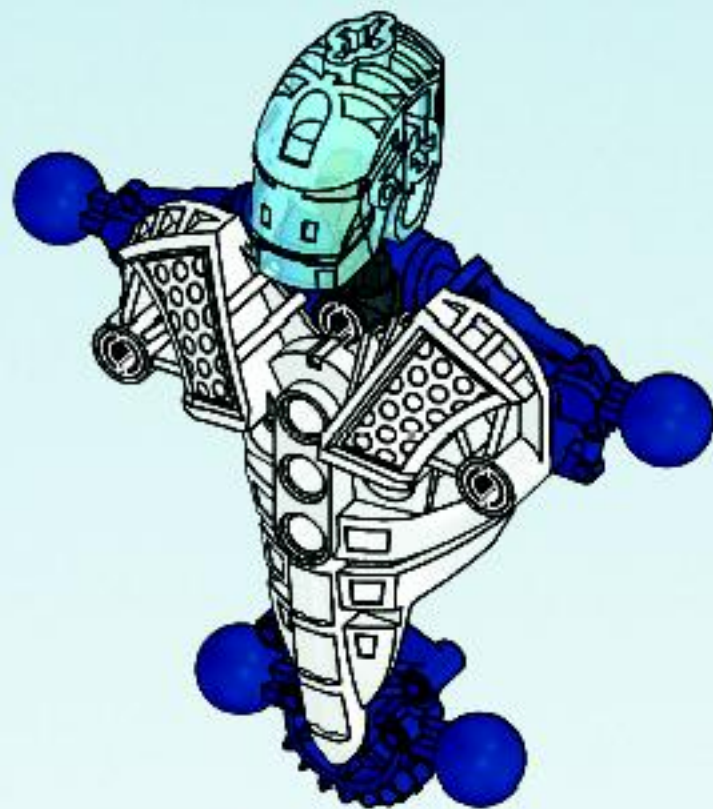

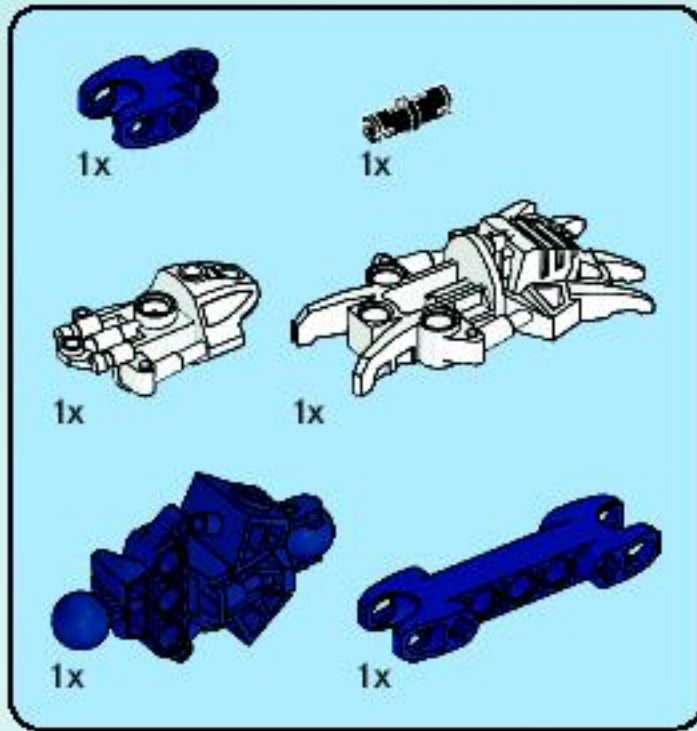
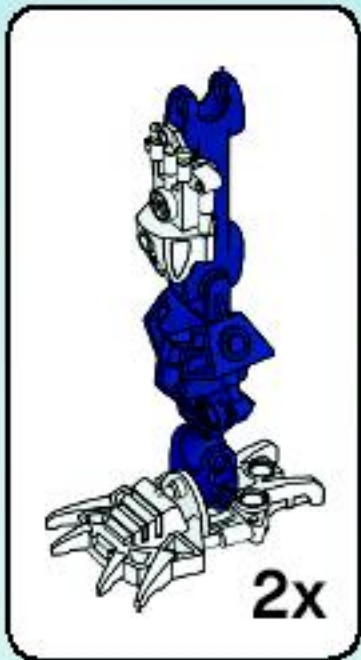

5

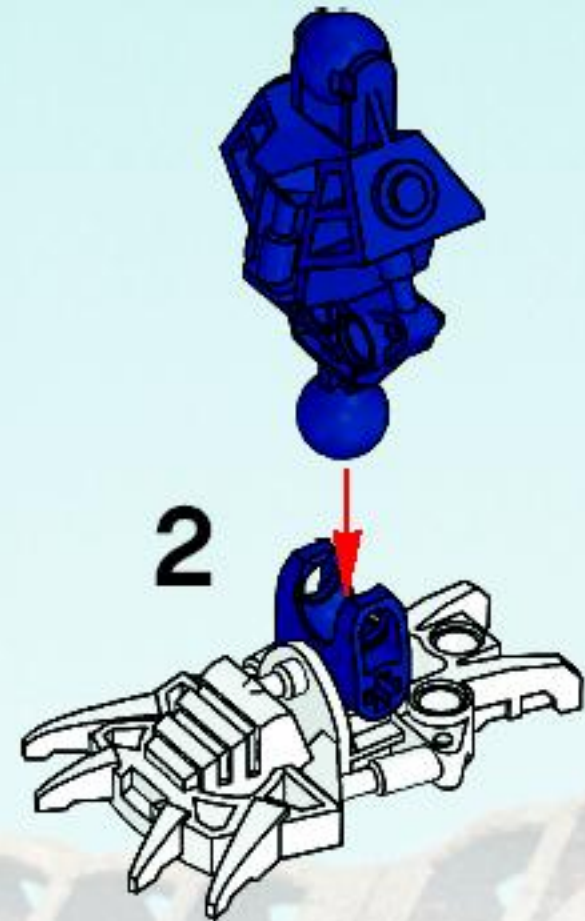
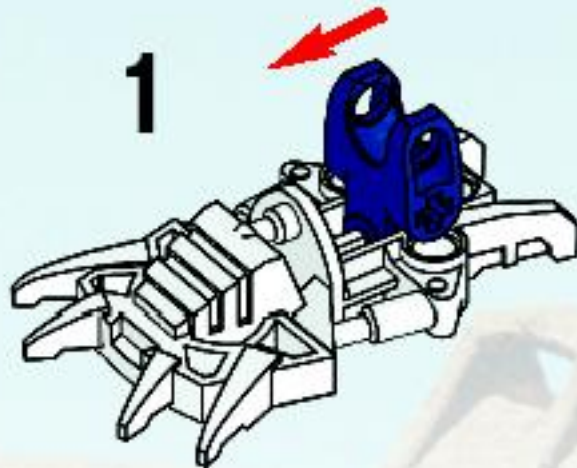

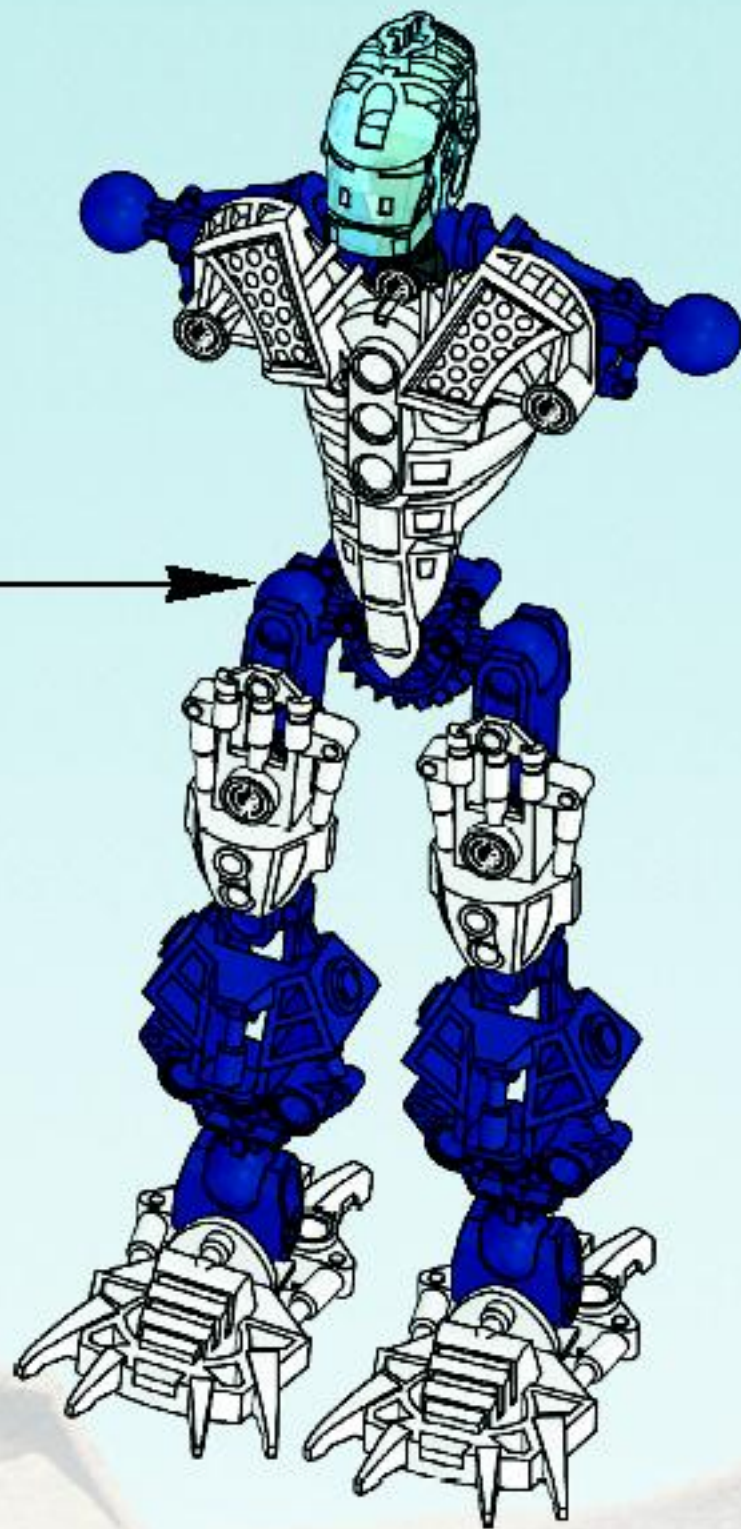
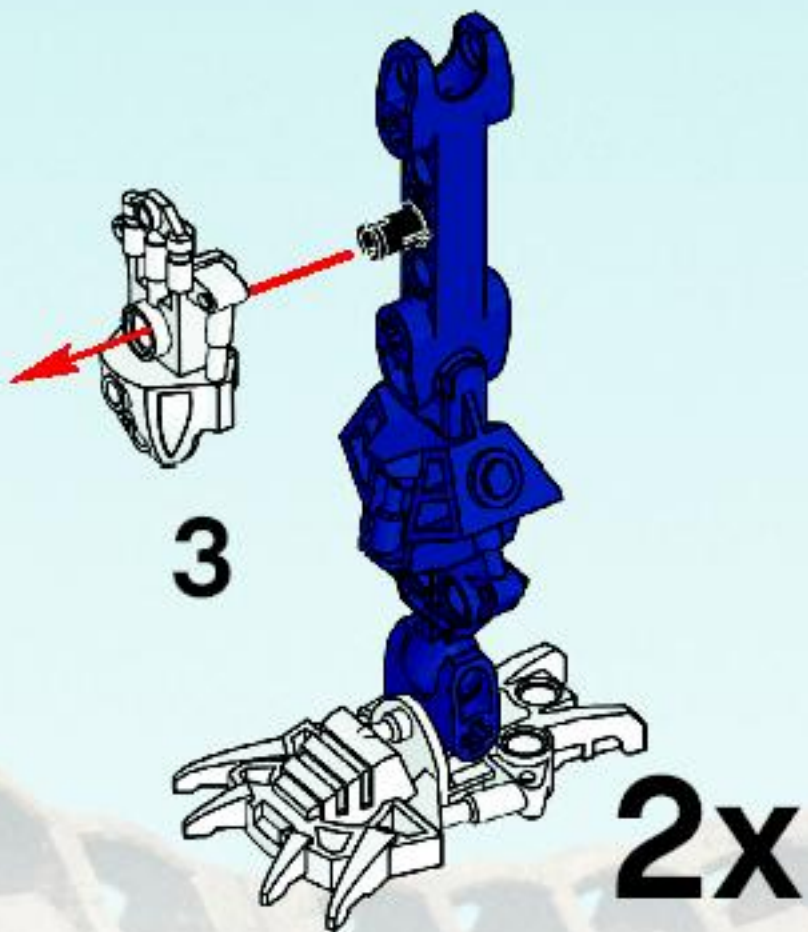

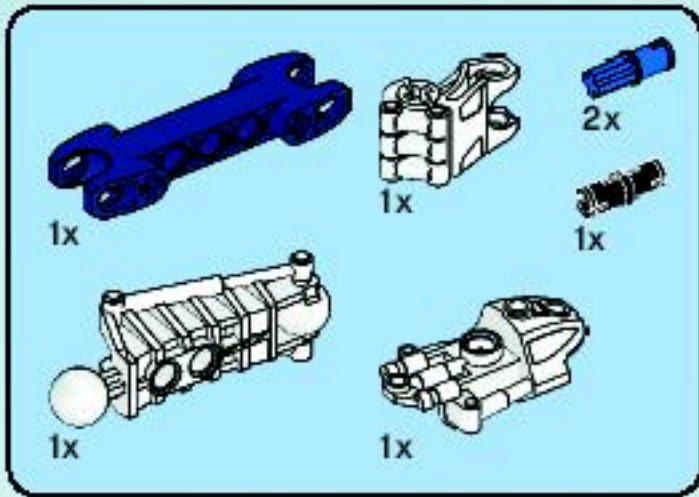
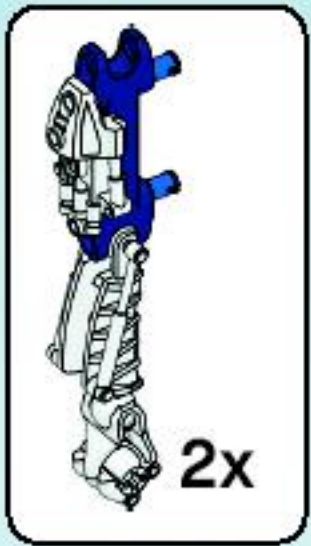

6

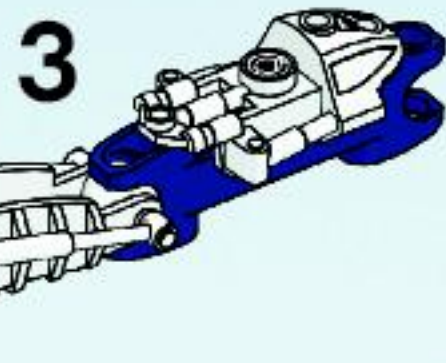
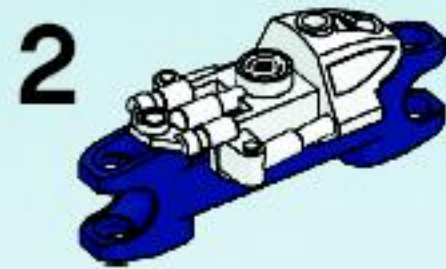
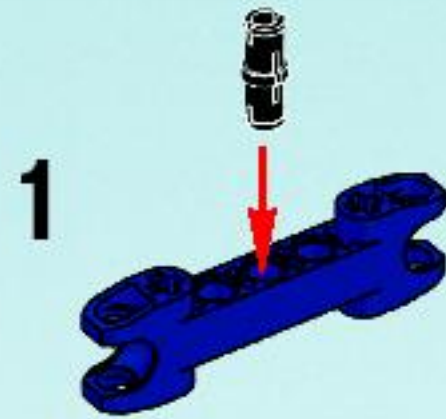

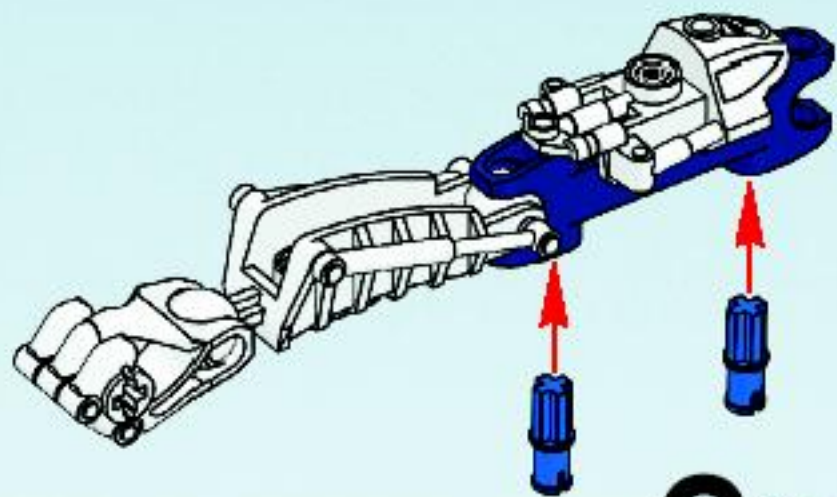

2x

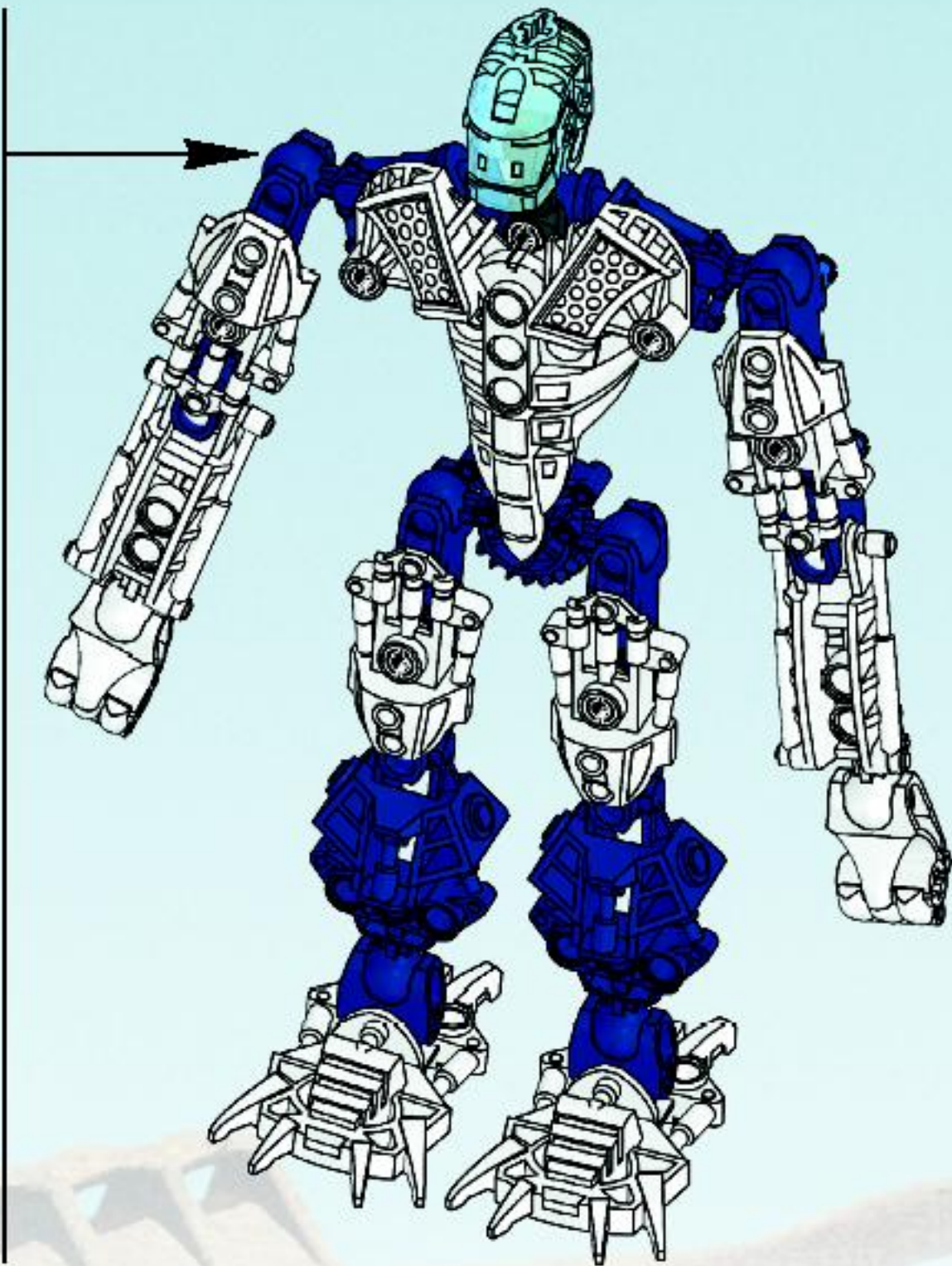



2x

7



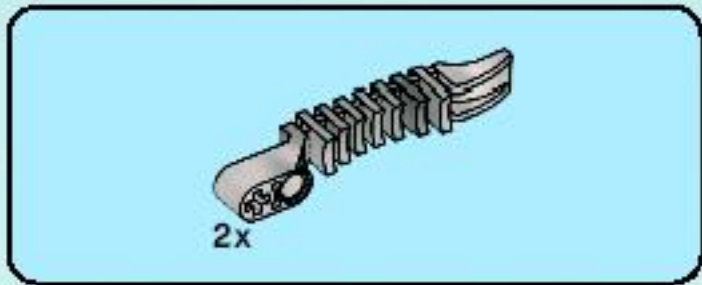

8

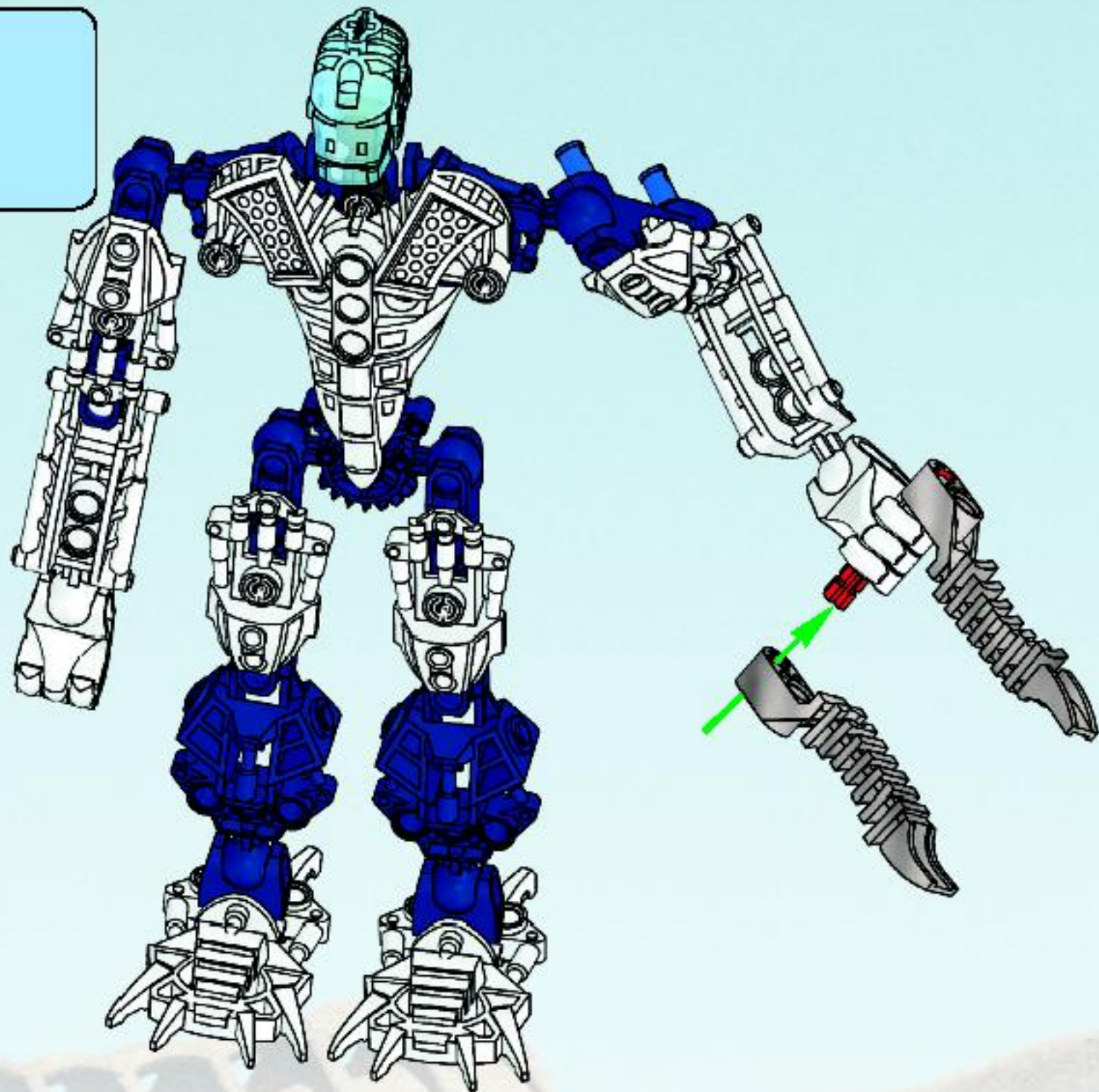

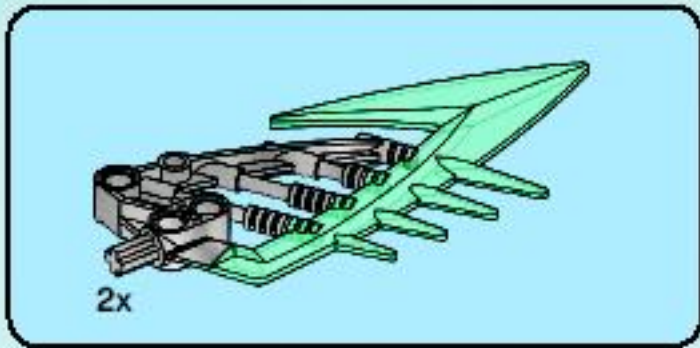

9

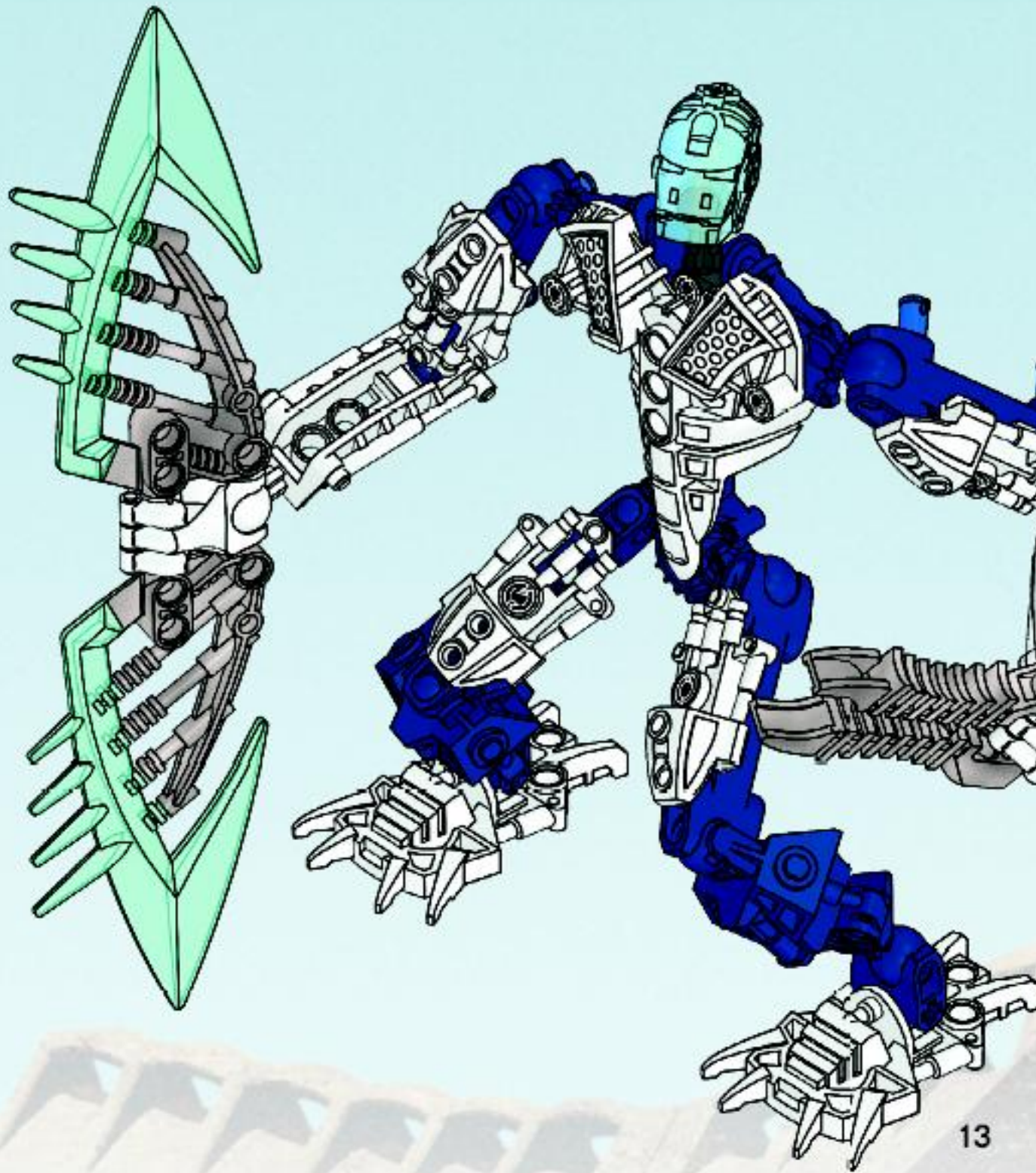

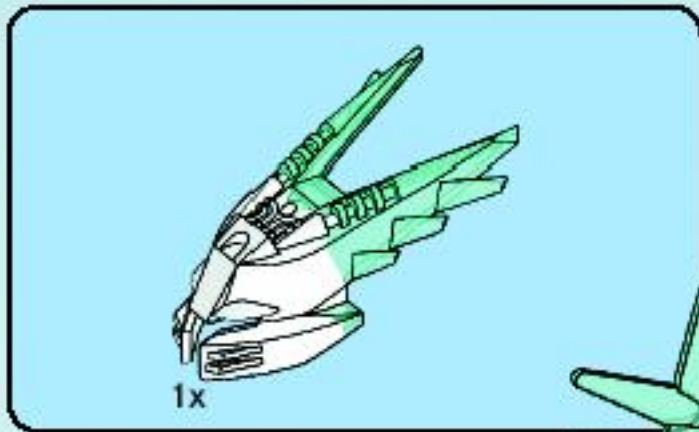

10

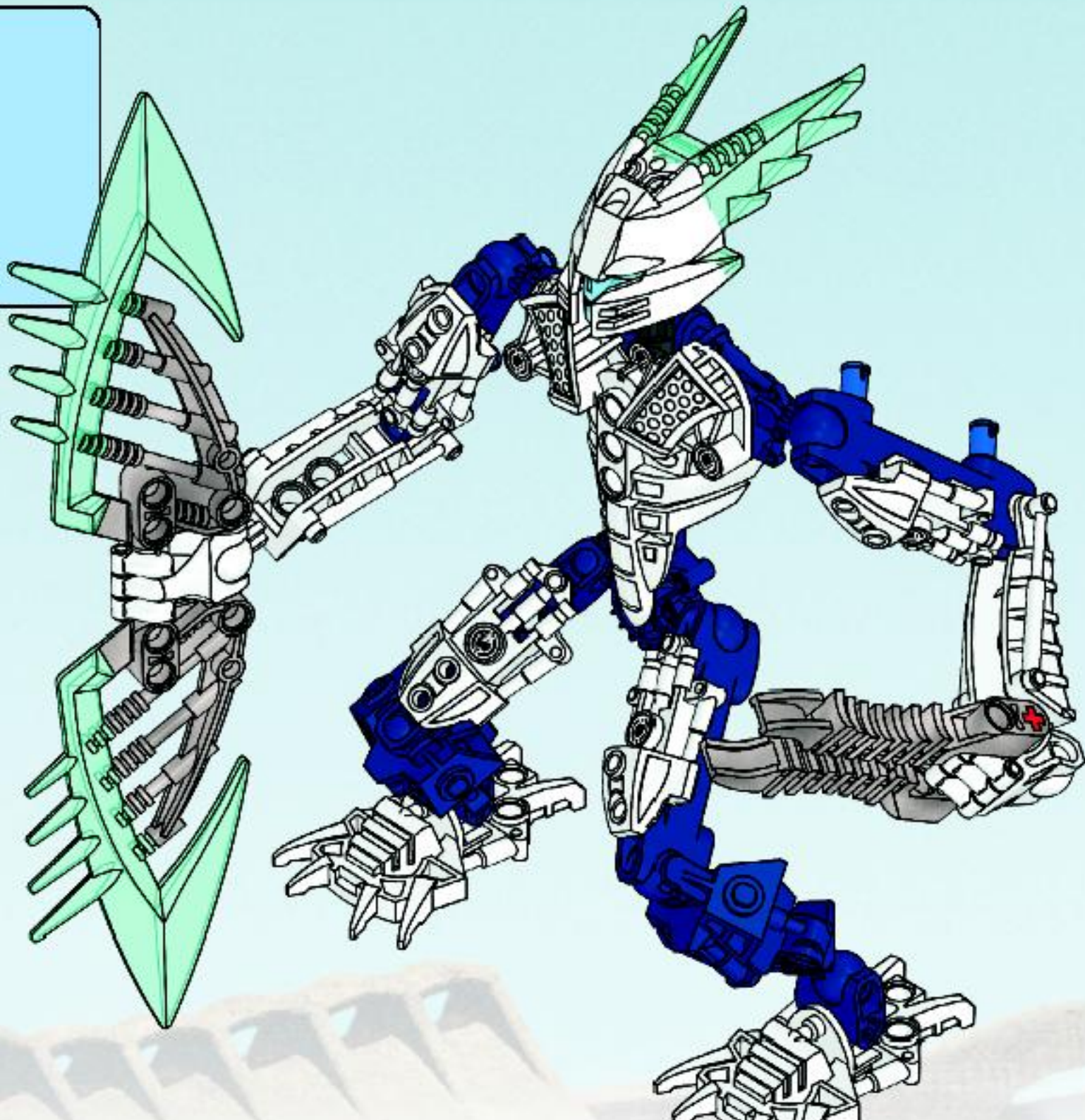

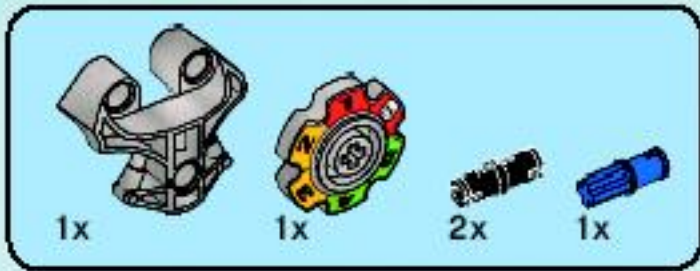

11

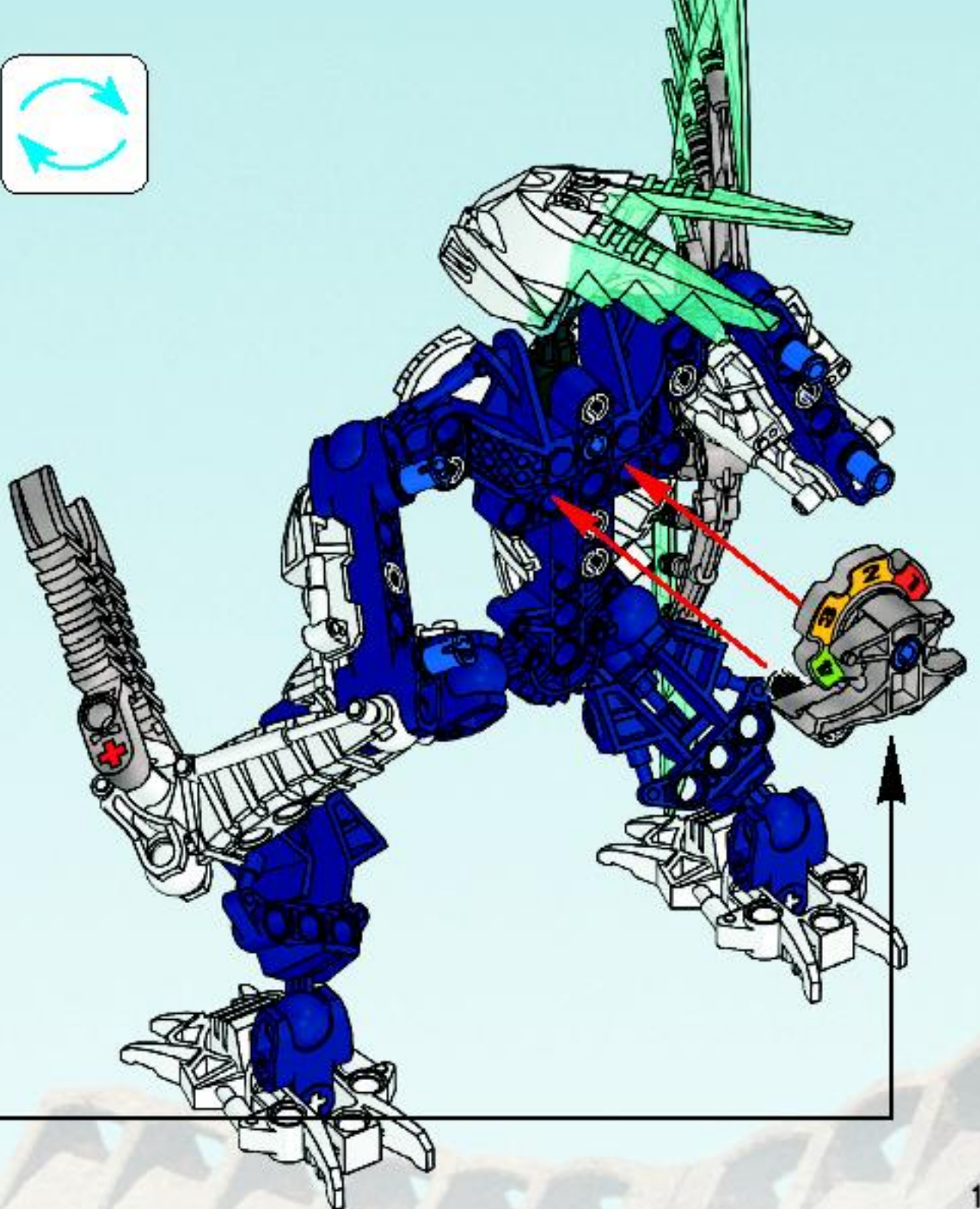
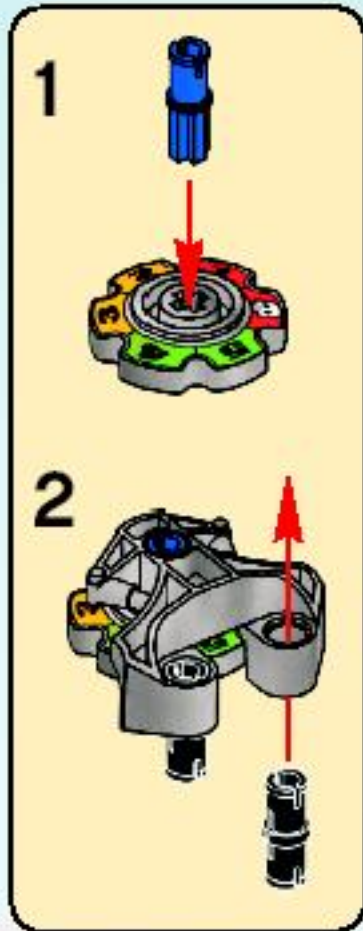

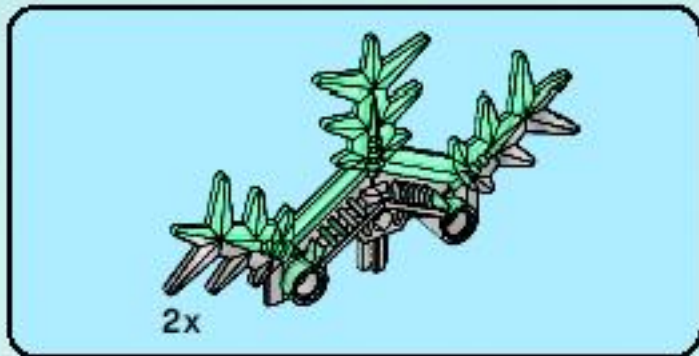

12





13

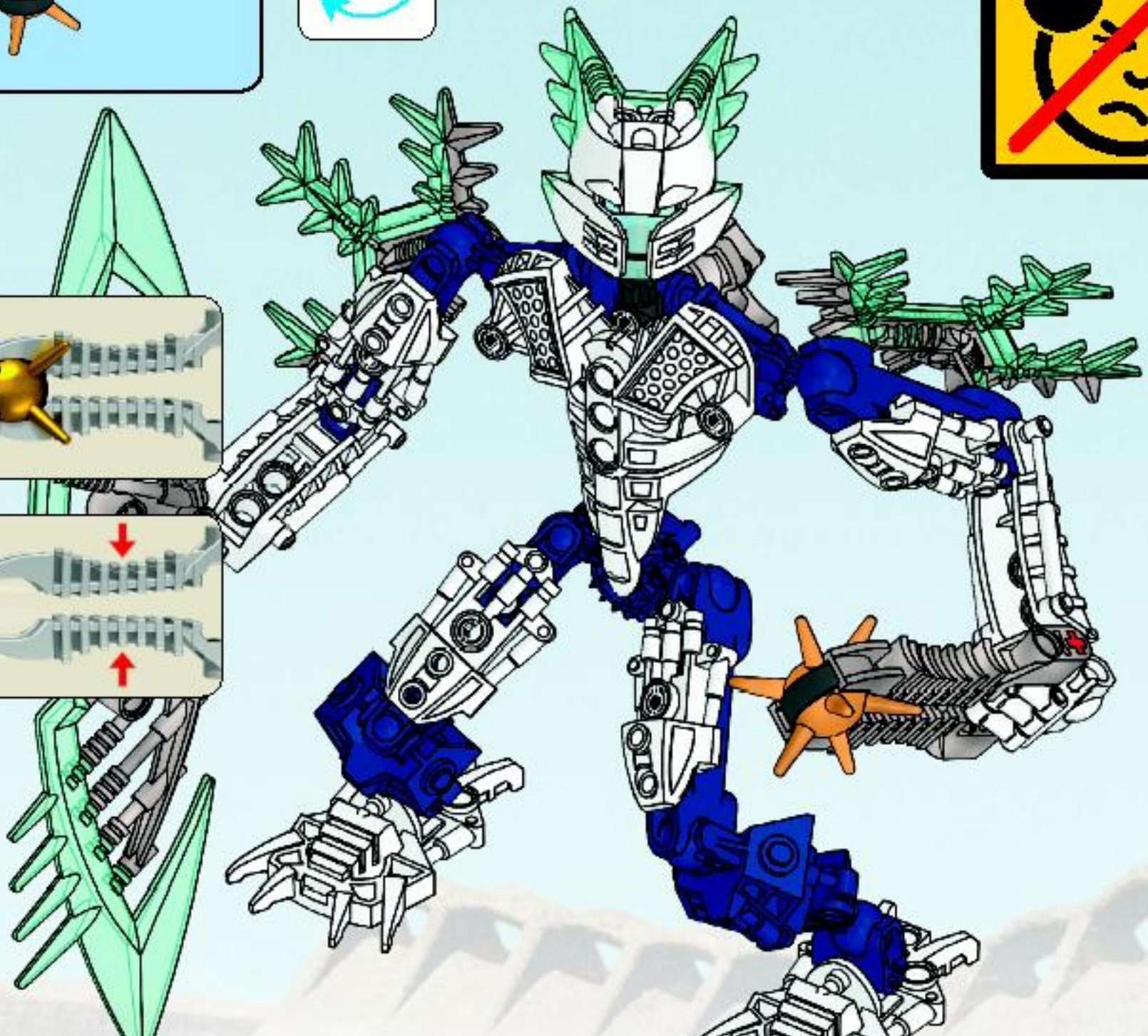



1x
4544529



1x
4537503



2x
4539157



2x
4527059



1x
4544660



1x
4247224



1x
4560108



4x
4281240



1x
4278500



2x
4537507



2x
4546416



11x
4121715

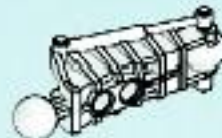

2x
4278479



2x
4289381



1x
4546585



2x
4142865



2x
4548168



4x
4525998



2x
4544659



6x
4206482



1x
4292552



1x
4297132



Customer Service

Kundenservice

Service Consommateurs

Servicio Al Consumidor

www.lego.com/service or dial



00800 5346 5555 :

1-800-422-5346 :



ALL-NEW MOVIE ON DVD

AUTUMN 2009

BRANDNEUER FILM AUF DVD HERBST 2009
UN TOUT NOUVEAU FILM EN DVD AUTOMNE 2009
UNA PELÍCULA TOTALMENTE NUEVA EN DVD OTOÑO 2009
UM FILME COMPLETAMENTE NOVO EM DVD OUTONO 2009
EGY VACONATÚJ MOZIFILM DVD SZ 2009



UNIVERSAL PICTURES
www.universal.com

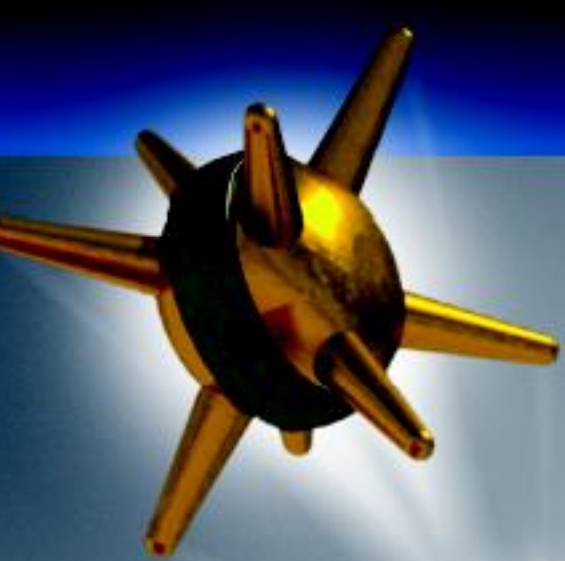

BIONICLE ACTION FIGURE
GAME



Setting Up Aufbau des Spiels

Règles du jeu Comenzar a jugar

This game is about taking the life of your opponent before he takes yours!

1. Set up the game using 2 cans & 2 figures
2. Set the dial to 5
3. Decide who goes first

Treffe Deinen Gegner und nimm ihm die Lebenspunkte, bevor er es tut!

1. Stelle zwei Dosen und zwei Figuren wie abgebildet auf.
2. Drehe die Lebenszähler an den Spielfiguren auf 5.
3. Entscheide, wer beginnt.

Pour remporter le combat, il faut que tu t'empares de la vie de ton adversaire avant qu'il ne s'empare de la tienne !

1. Délimite la zone de combat à l'aide des 2 boîtes et place les 2 figurines
2. Positionne ton compteur de vie sur 5
3. Décide qui commence

¡El objetivo de este juego es hacerse con la vida de tu oponente antes de que él se haga con la tuya!

1. Prepara el juego utilizando 2 botes y 2 figuras
2. Coloca el marcador en 5
3. Decide quién empezará



Playing the game: **POINTS** Punktvergabe bei einem Treffer

Comment jouer : **LE CALCUL DES POINTS**
Como jugar: **PUNTOS**

1. Hit can and opponent loses 1 life point or hit figure and opponent loses 2 points.

1. Wird die Dose getroffen, verliert der Gegner 1 Punkt, bei einem Treffer der Figur werden 2 Punkte abgezogen.

1. Si ta balle Spiky touche la boîte, ton adversaire perd 1 point de vie et si elle touche la figurine, ton adversaire perd 2 points

1. Si golpeas el bote, tu oponente pierde 1 punto y si golpeas la figura, tu oponente pierde dos puntos.



Playing the game: **MOVE**
Position der Spielfiguren

Comment jouer : **LES DÉPLACEMENTS**
Como jugar: **DESPLAZAMIENTO**

1. After shooting move figure to where ball lands.

1. Nach jedem Schuss wird die Figur dort abgestellt, wo die Dornenkugel gelandet ist.

1. Après avoir tiré, déplace la figurine à l'endroit où ta balle Spiky a atterri.

1. Después de disparar, mueve la figura hasta el lugar en el que haya caído la bola.



Winning the game
Gewinne das Spiel

Comment remporter le combat !
Como ganar

- 1. The first player to take all the opponent's life points wins!
- 1. Gewonnen hat der Spieler, der seinem Gegner als Erster alle Lebenspunkte genommen hat.
- 1. Le premier joueur qui s'empare de tous les points de vie de son adversaire gagne !
- 1. El primer jugador que se haya con todos los puntos de vida de su oponente ganará!





For more rules on advanced multi-figure game play - check out



Weitere Informationen und Anleitungen für coole Spiele mit mehreren Figuren findest du unter



Retrouve toutes les règles du jeu multi-joueur sur



Pour plus d'information concernant les règles des jeux de niveau avancé avec plusieurs figurines, visite



Para más información sobre instrucciones de juego avanzado con varias figuras, consulta



Para más información sobre instrucciones de juego avanzado con varias figuras, consulta

www.BIONICLE.com





8996



8995



8992



8993



8994





STRONIUS
8984



ACKAR
8985



VASTUS
8986

GLATORIAN LEGENDS



KIINA
8987



GELLU
8988



MATA NUI
8989

BIONICLE



SKOPIO XV-1
8996



BARANUS V7
8994



THORNATUS V9
8995

www.BIONICLE.com

A promotional image for LEGO Bionicle featuring two sets. On the left, a red and black Bionicle figure is mounted on a motorcycle-like vehicle, flying through a circular opening in a stone wall. On the right, a blue and silver Bionicle figure is mounted on a larger, more complex motorcycle-like vehicle, positioned on a cracked stone floor. The background shows a desert landscape with a large rock formation and a blue sky.

CENDOX V1
8992

KAXILM V3
8993

www.BIONICLE.com



ATAKLIS
8972



RAANU
8973



TAROUK
8974



BERIX
8975



METUS
8976



ZESK
8977



WWW.BIONICLE.COM



FREE! GRATIS! GRATUIT!



club
MAGAZINE™

www.LEGOclub.com



00800 5346 5555*        



1-866-534-6258 • 1-877-518-5346

US & Canada only

Canada seulement

* Prephone. Mobile charges may apply. * Tuntiro sata Präs. les Präs peuvent s'appliquer avec les téléphones cellulaires.
* Gebührenfrei, Kosten für Anrufer aus Mobilfunknetzen können abweichen. * Gratis telefonnummer vandrøstet til. * Telesett gratis nummer, når du ringer fra fasttelefon.
* Tel. å gratis, når du ringer fra fast telefon.



VISIT THE WORLD'S
BIGGEST LEGO® SHOP!

www.LEGOshop.com



WIN LEGO® PRODUCTS

Fill out a survey and you might WIN a cool LEGO product!
NO PURCHASE NECESSARY
Open to all residents where not prohibited
Go to www.nielsen.com/LEGO to fill out a survey for a chance to win a LEGO product.

WIN LEGO® PRODUCTEN

Vul een enquêteformulier in en maak kans op een cool LEGO® product!
Kopen niet nodig
Iedereen uit landen waar geen enquêteverbod geldt mag deelnemen.
Ga naar www.nielsen.com/LEGO, vul een enquêteformulier in en maak kans op een LEGO product.

GEWINNE LEGO® PRODUKTE

Nimm an der Umfrage teil und GEWINNE ein tolles LEGO® Produkt!
Die Teilnahme am Gewinnspiel führt zu keinerlei Kaufverpflichtungen
Teilnahme in allen nicht ausgeschlossenen Ländern möglich
Wir verlosen unter allen Teilnehmern der Umfrage auf www.nielsen.com/LEGO LEGO Produkte.

GAGNE DES PRODUITS LEGO®

Réponds à un questionnaire et tu pourrais GAGNER un produit LEGO® très cool !
Aucune obligation d'achat.
Ouvert à tous les résidents des pays autorisés.
Visite www.nielsen.com/LEGO pour répondre à un questionnaire et avoir une chance de gagner un produit LEGO.

レゴ®製品を「当てよう」

アンケートに記入して、カッコいいレゴ®製品を当てよう！
お買い上げの必要はありません。
禁止されていない限り、すべての皆様にご利用いただけます。
www.nielsen.com/LEGOにアクセスして、アンケートにご記入ください。当選者にはレゴ®製品を差し上げます。

